

US00D969941S

(12) **United States Design Patent**
Rothschild

(10) **Patent No.:** **US D969,941 S**

(45) **Date of Patent:** **** *Nov. 15, 2022**

(54) **WEIGHT PLATE**

(71) Applicant: **Sound Shore Innovations L.L.C.**,
Darien, CT (US)

(72) Inventor: **Kyle D. Rothschild**, Darien, CT (US)

(73) Assignee: **Sound Shore Innovations L.L.C.**,
Darien, CT (US)

(*) Notice: This patent is subject to a terminal disclaimer.

(**) Term: **15 Years**

(21) Appl. No.: **29/814,132**

(22) Filed: **Nov. 3, 2021**

Related U.S. Application Data

(63) Continuation-in-part of application No. 29/717,236,
filed on Dec. 16, 2019, now Pat. No. Des. 937,942,
(Continued)

(51) **LOC (13) Cl.** **21-02**

(52) **U.S. Cl.**
USPC **D21/680**

(58) **Field of Classification Search**
USPC D21/662, 681, 682, 694, 680, 684, 679
See application file for complete search history.

(56) **References Cited**

U.S. PATENT DOCUMENTS

D255,263 S 6/1980 Mandon et al.
D381,611 S 7/1997 Ohata et al.

(Continued)

OTHER PUBLICATIONS

Cap barbell store, announced 2015[online], [site visited Jan. 19, 2021]. Available on internet, URL: [https://www.amazon.com/CAP-Barbell-Olympic-Rubber-Bumper/dp/B00XP88TCU/ref\(Year: 2015\).*](https://www.amazon.com/CAP-Barbell-Olympic-Rubber-Bumper/dp/B00XP88TCU/ref(Year: 2015).*)

Primary Examiner — Khawaja Anwar
Assistant Examiner — Julice Seung Eun Oum

(74) *Attorney, Agent, or Firm* — Jones Day

(57) **CLAIM**

The ornamental design for a weight plate, as shown and described.

DESCRIPTION

FIG. 1 is a top perspective view of a first embodiment of a weight plate showing my new design, the bottom perspective view being a mirror image;
FIG. 2 is a top plan view thereof;
FIG. 3 is a bottom plan view thereof which is a mirror image of the top plan view;
FIG. 4 is a left side elevational view thereof;
FIG. 5 is a right side elevational view thereof which is a mirror image of the left side elevational view;
FIG. 6 is a front elevational view thereof;
FIG. 7 is a rear elevational view thereof which is a mirror image of the front elevational view;
FIG. 8 is a top perspective view of a second embodiment of the weight plate, the bottom perspective view being a mirror image;
FIG. 9 is a top plan view thereof;
FIG. 10 is a bottom plan view thereof which is a mirror image of the top plan view;
FIG. 11 is a left side elevational view thereof;
FIG. 12 is a right side elevational view thereof which is a mirror image of the left side elevational view;
FIG. 13 is a front elevational view thereof;
FIG. 14 is a rear elevational view thereof which is a mirror image of the front elevational view;
FIG. 15 is a cross sectional view of the weight plate of FIG. 9 along the line referenced as 15; and,
FIG. 16 is a cross sectional view of the weight plate of FIG. 9 along the line referenced as 16.

1 Claim, 10 Drawing Sheets

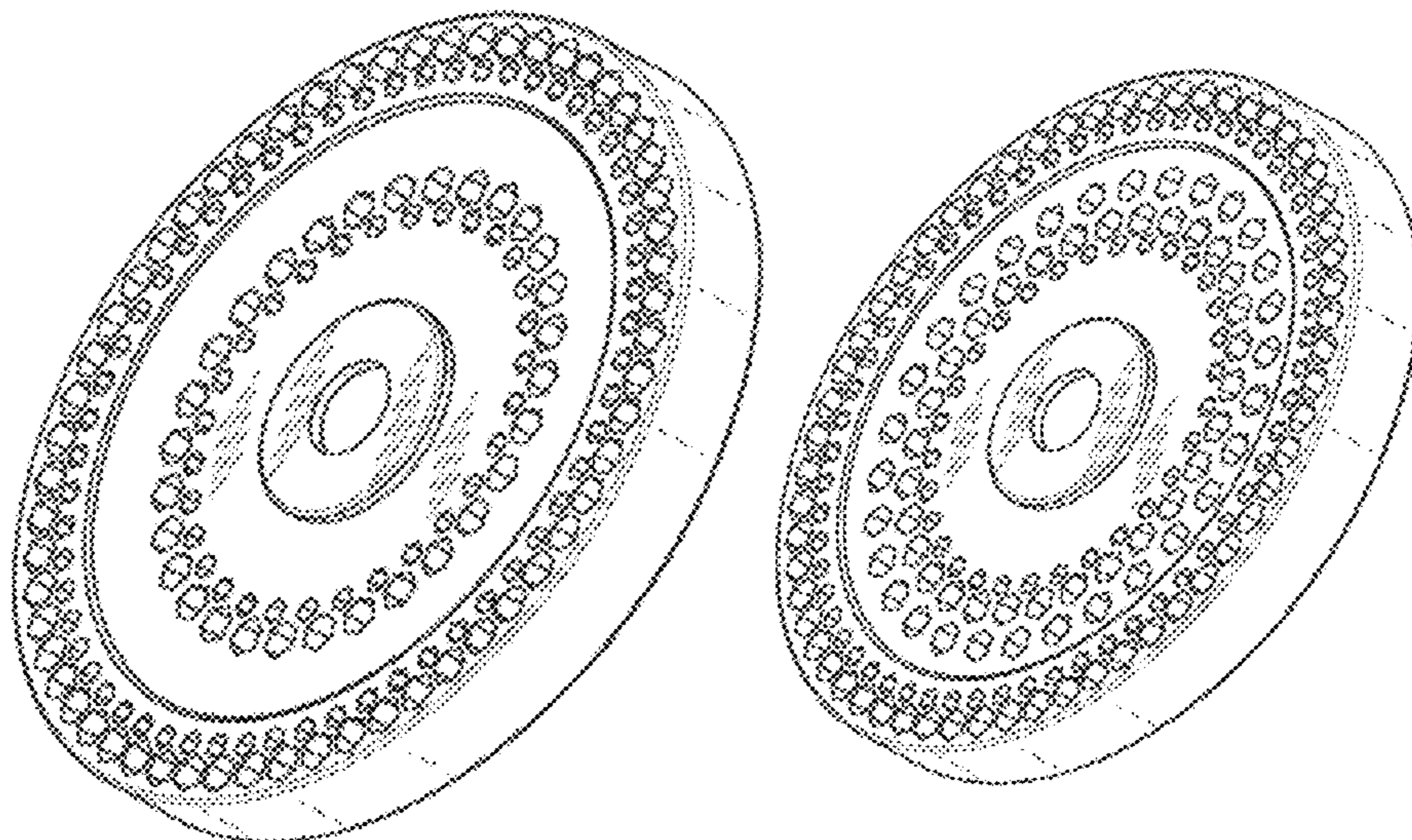

Related U.S. Application Data

which is a continuation of application No. 15/885, 292, filed on Jan. 31, 2018, now Pat. No. 11,260,257.

(56) **References Cited**

U.S. PATENT DOCUMENTS

D424,140	S	5/2000	Lincir	
D445,153	S	7/2001	Lincir	
D445,154	S	7/2001	Lincir	
D446,265	S	8/2001	Lincir	
D451,158	S	11/2001	Lincir	
D599,881	S	9/2009	Wang et al.	
9,126,077	B2	9/2015	Rothacker	
D743,519	S	11/2015	Furner	
D816,780	S	5/2018	Beekzad	
10,076,679	B2	9/2018	Dickerson	
D857,131	S	8/2019	Marton et al.	
10,456,655	B1	10/2019	Orehek	
10,537,777	B1	1/2020	Tash et al.	
D896,901	S *	9/2020	Jones	D21/681
10,773,117	B1	9/2020	Goldberg et al.	
D930,764	S *	9/2021	Jones	D21/680
D937,942	S *	12/2021	Rothschild	A63B 21/0604
				D21/680
D937,943	S *	12/2021	Rothschild	D21/680
D944,341	S *	2/2022	Henniger	D21/680
2008/0050260	A1	2/2008	Iwanami et al.	
2018/0028857	A1	2/2018	Rothschild et al.	
2019/0111304	A1	4/2019	Gilman	
2019/0143742	A1	5/2019	Ferry	
2019/0232100	A1	8/2019	Rothschild	
2020/0360755	A1	11/2020	Rothschild	
2020/0384307	A1	12/2020	Bowers	
2020/0398097	A1	12/2020	Chen	
2021/0135540	A1	5/2021	Zhang	

* cited by examiner

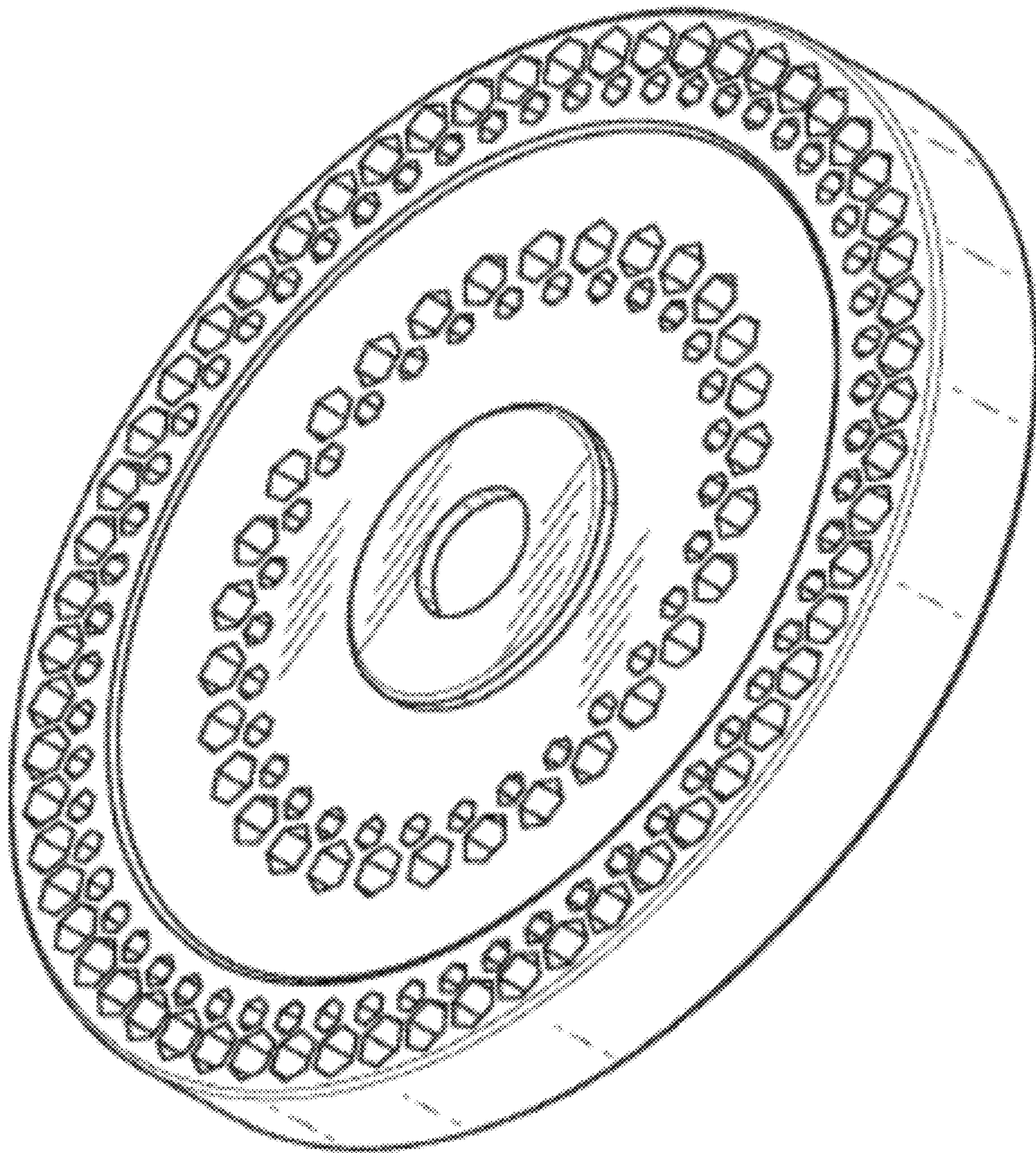

FIG. 1

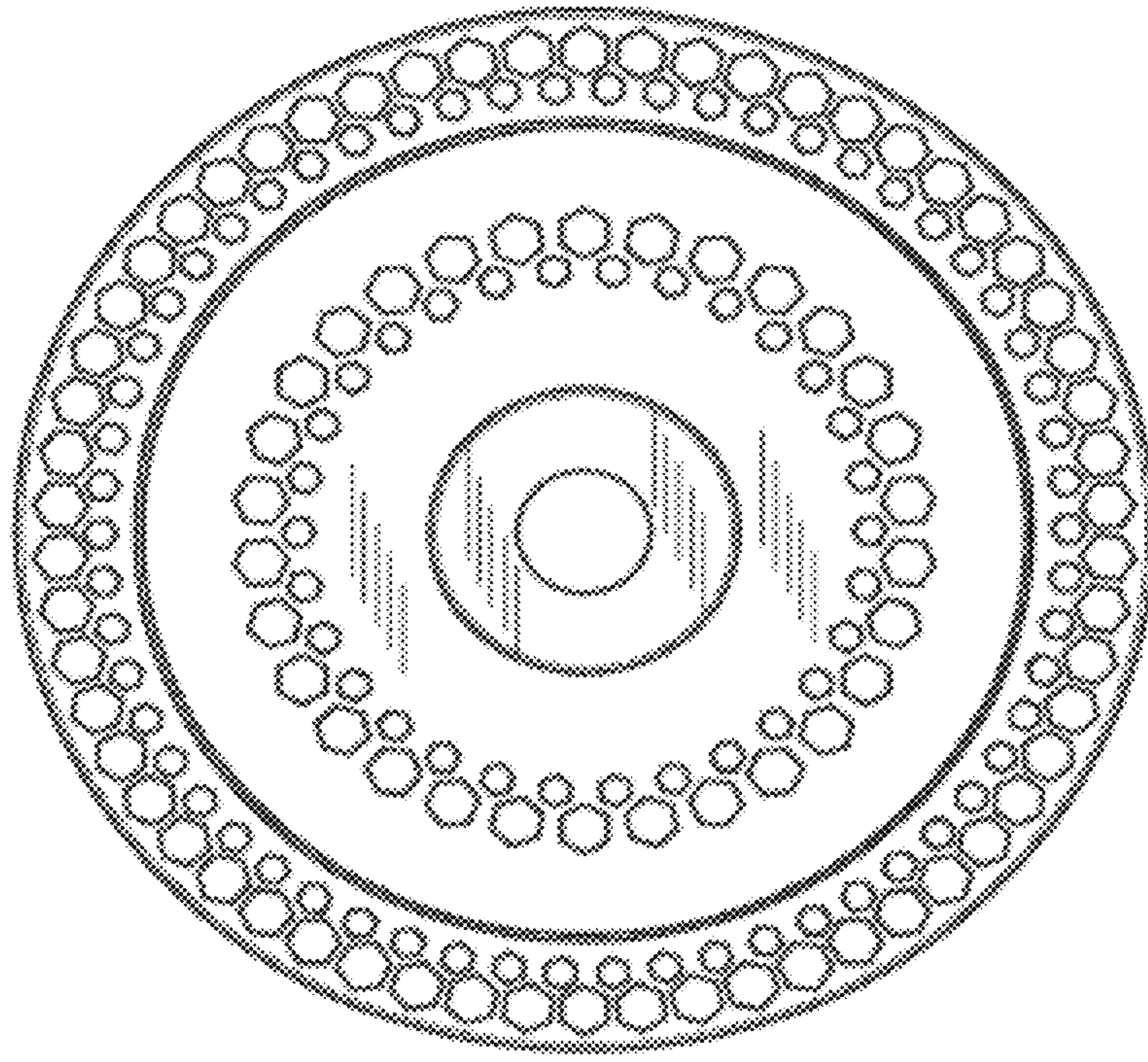

FIG. 2

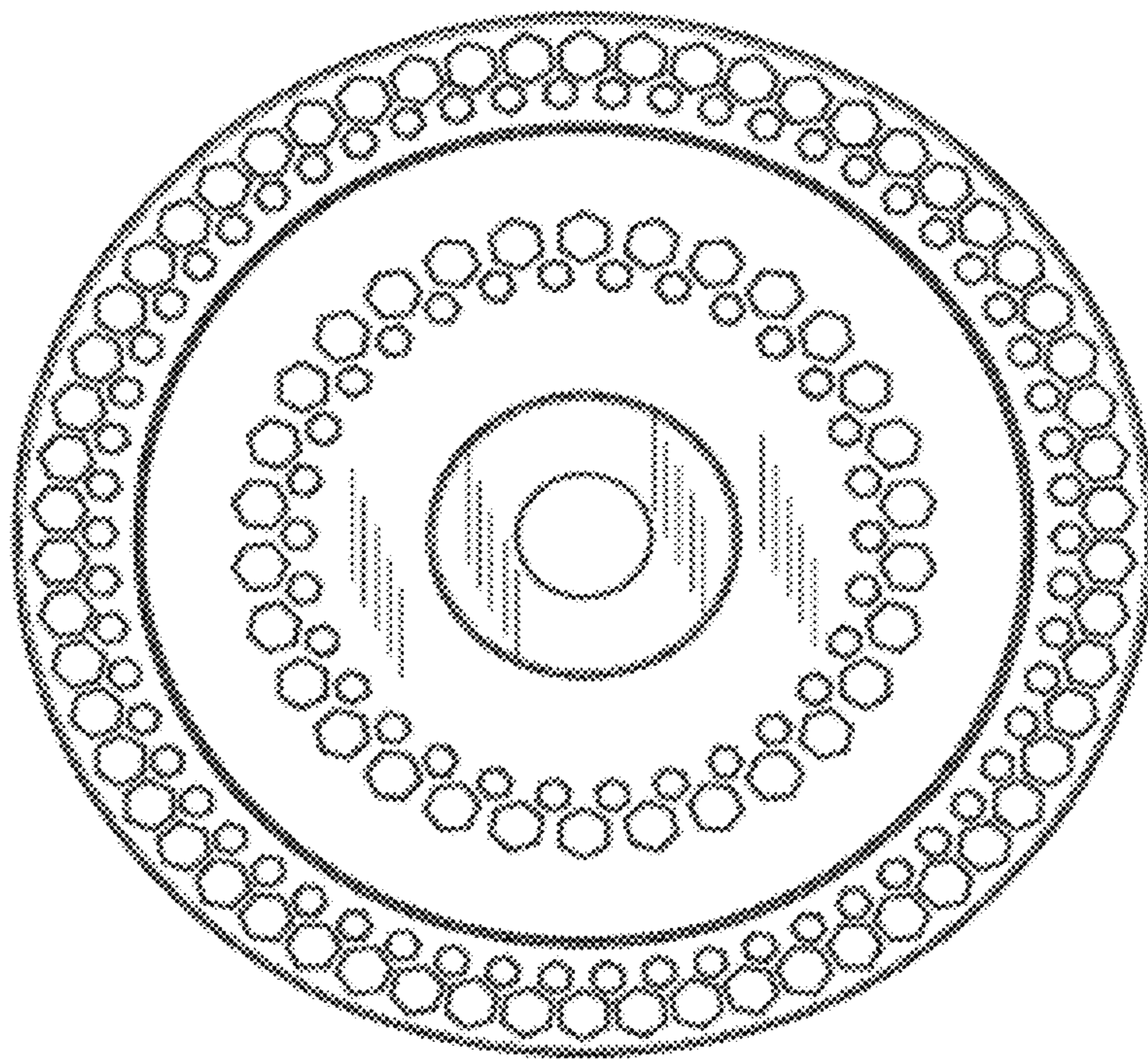

FIG. 3



FIG. 4



FIG. 5



FIG. 6



FIG. 7

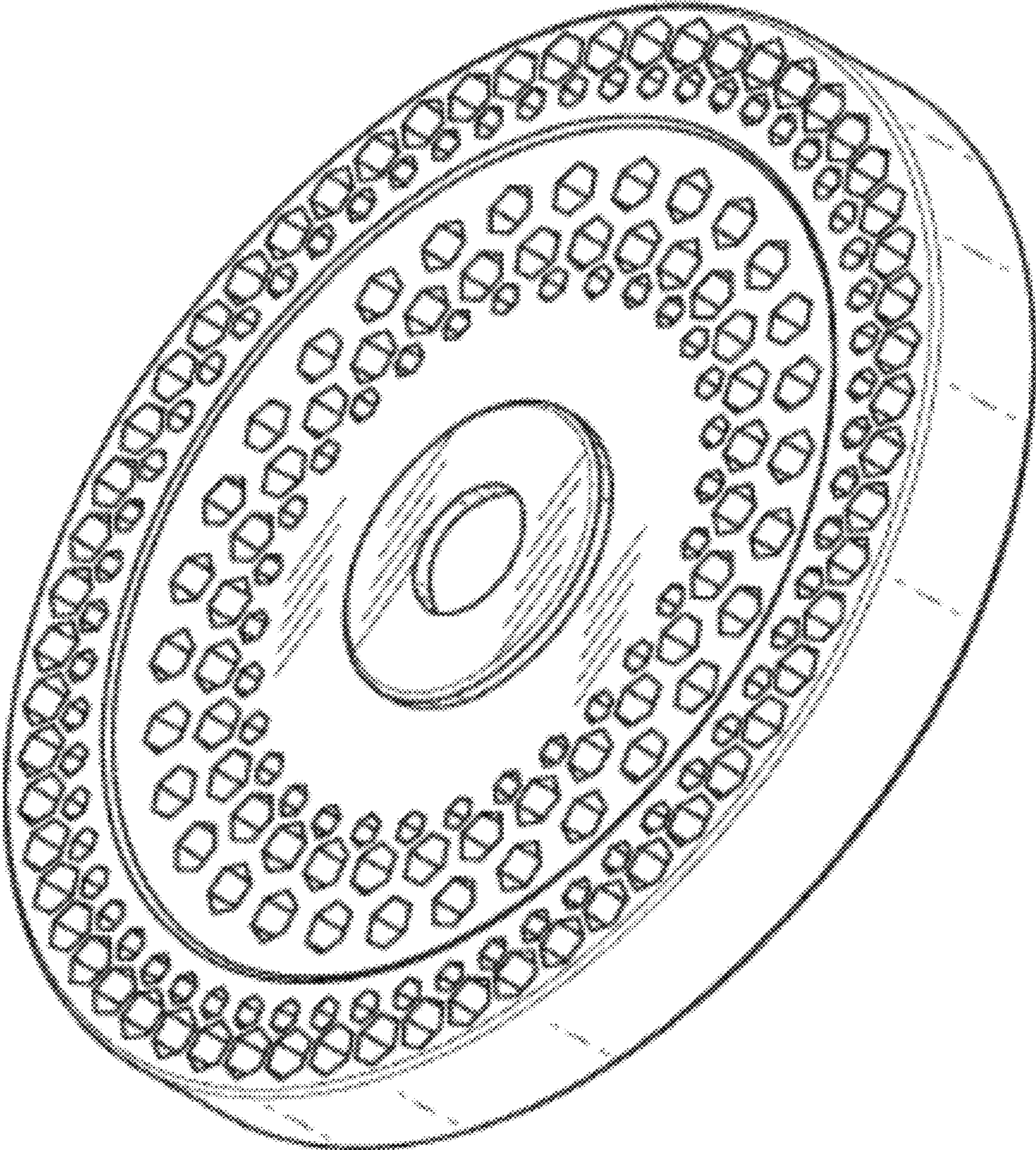

FIG. 8

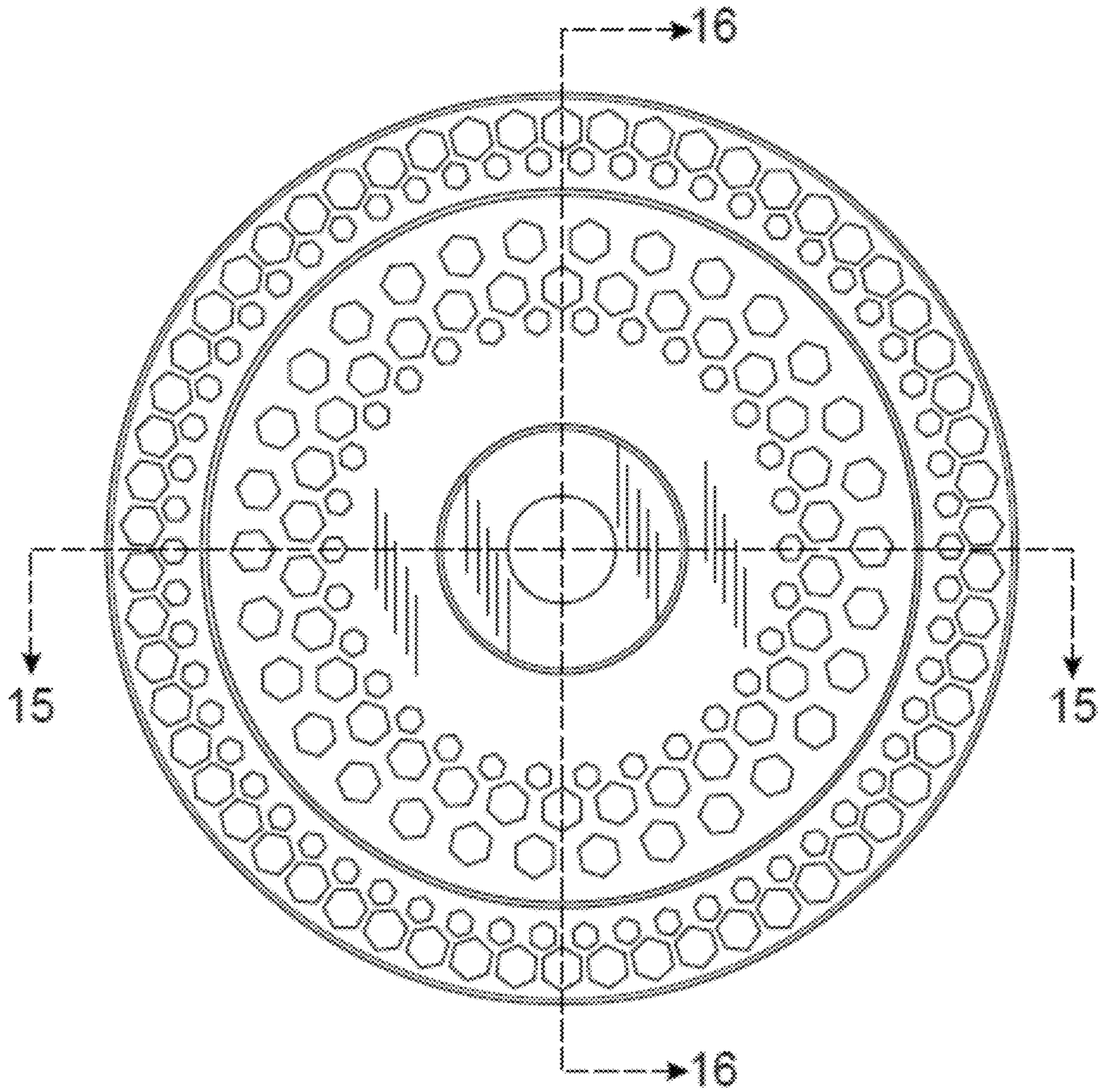

FIG. 9

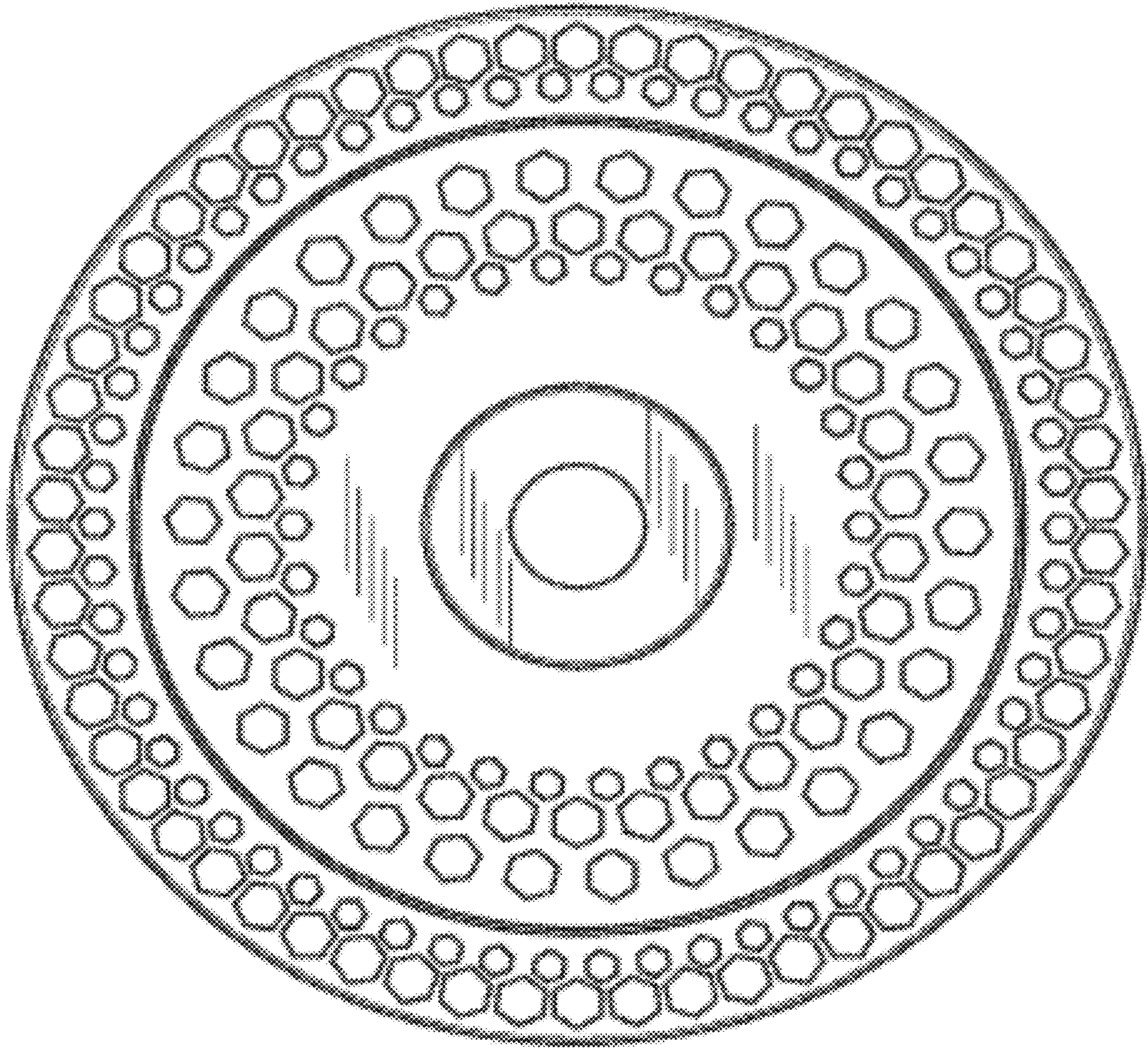

FIG. 10



FIG. 11



FIG. 12



FIG. 13



FIG. 14

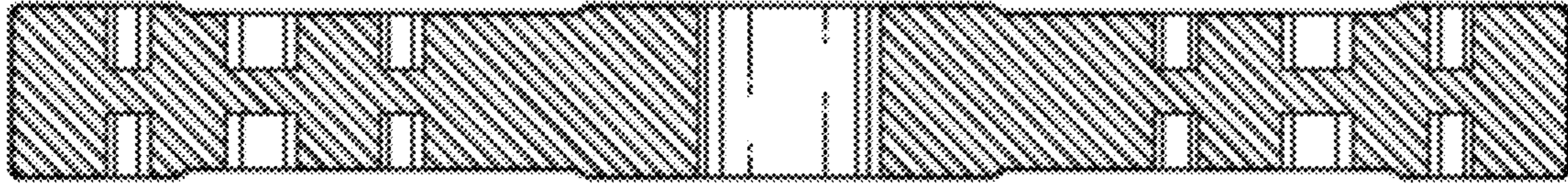

FIG. 15

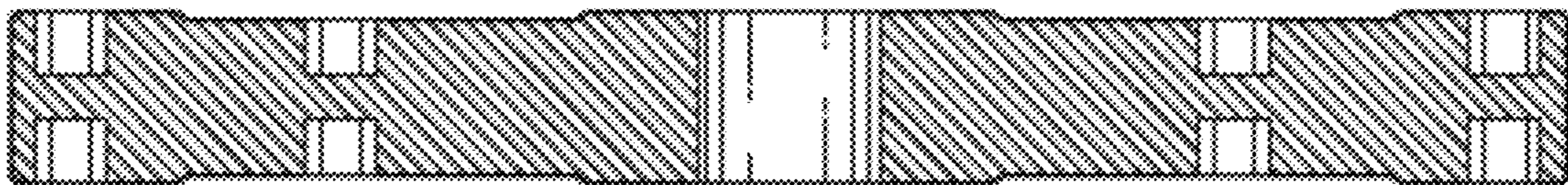

FIG. 16