



US00RE49990E

(19) **United States**
(12) **Reissued Patent**
Shivadas et al.

(10) **Patent Number: US RE49,990 E**
(45) **Date of Reissued Patent: *May 28, 2024**

(54) **USE OF OBJECTIVE QUALITY MEASURES OF STREAMED CONTENT TO REDUCE STREAMING BANDWIDTH**

(71) Applicant: **DIVX, LLC**, San Diego, CA (US)

(72) Inventors: **Abhishek Shivadas**, San Diego, CA (US); **William David Amidei**, San Diego, CA (US)

(73) Assignee: **DIVX, LLC**, San Diego, CA (US)

(*) Notice: This patent is subject to a terminal disclaimer.

(21) Appl. No.: **17/485,109**

(22) Filed: **Sep. 24, 2021**

Related U.S. Patent Documents

Reissue of:

(64) Patent No.: **9,313,510**
Issued: **Apr. 12, 2016**
Appl. No.: **13/731,949**
Filed: **Dec. 31, 2012**

U.S. Applications:

(63) Continuation of application No. 15/950,950, filed on Apr. 11, 2018, now Pat. No. Re. 48,761, which is an application for the reissue of Pat. No. 9,313,510.

(51) **Int. Cl.**
H04N 19/177 (2014.01)
H04N 19/102 (2014.01)

(Continued)

(52) **U.S. Cl.**
CPC **H04N 19/177** (2014.11); **H04N 19/102** (2014.11); **H04N 19/154** (2014.11); **H04N 19/164** (2014.11); **H04N 19/46** (2014.11)

(58) **Field of Classification Search**
CPC .. H04N 19/102; H04N 19/154; H04N 19/164; H04N 19/177; H04N 19/46

See application file for complete search history.

(56) **References Cited**

U.S. PATENT DOCUMENTS

3,609,227 A 9/1971 Kuljian
4,009,331 A 2/1977 Goldmark et al.

(Continued)

FOREIGN PATENT DOCUMENTS

AU 2010203605 B2 5/2015
CA 2237293 A1 7/1997

(Continued)

OTHER PUBLICATIONS

3GPP TS 26.247, V10.1.0, 3rd Generation Partnership Project; Technical Specification Group Services and System Aspects Transparent end-to-end Packet-switches Streaming Services (PSS); Nov. 2011, 112 pages.

(Continued)

Primary Examiner — Woo H Choi

(74) *Attorney, Agent, or Firm* — KPPB LLP

(57) **ABSTRACT**

A method includes encoding video at a first bitrate to produce first encoded sections, and at a second bitrate that is less than the first bitrate to produce second encoded sections. The method further includes measuring levels of objective quality, indicative of perceptual quality, of the first and second encoded sections. The method includes determining, based on the measured objective quality levels, replaceable sections among the first encoded sections, and replacement sections among the second encoded sections, each of the replacement sections to replace a corresponding one of the replaceable sections. The method includes streaming the first encoded sections except for the replaceable sections, and the replacement sections instead of their corresponding replaceable sections.

11 Claims, 13 Drawing Sheets

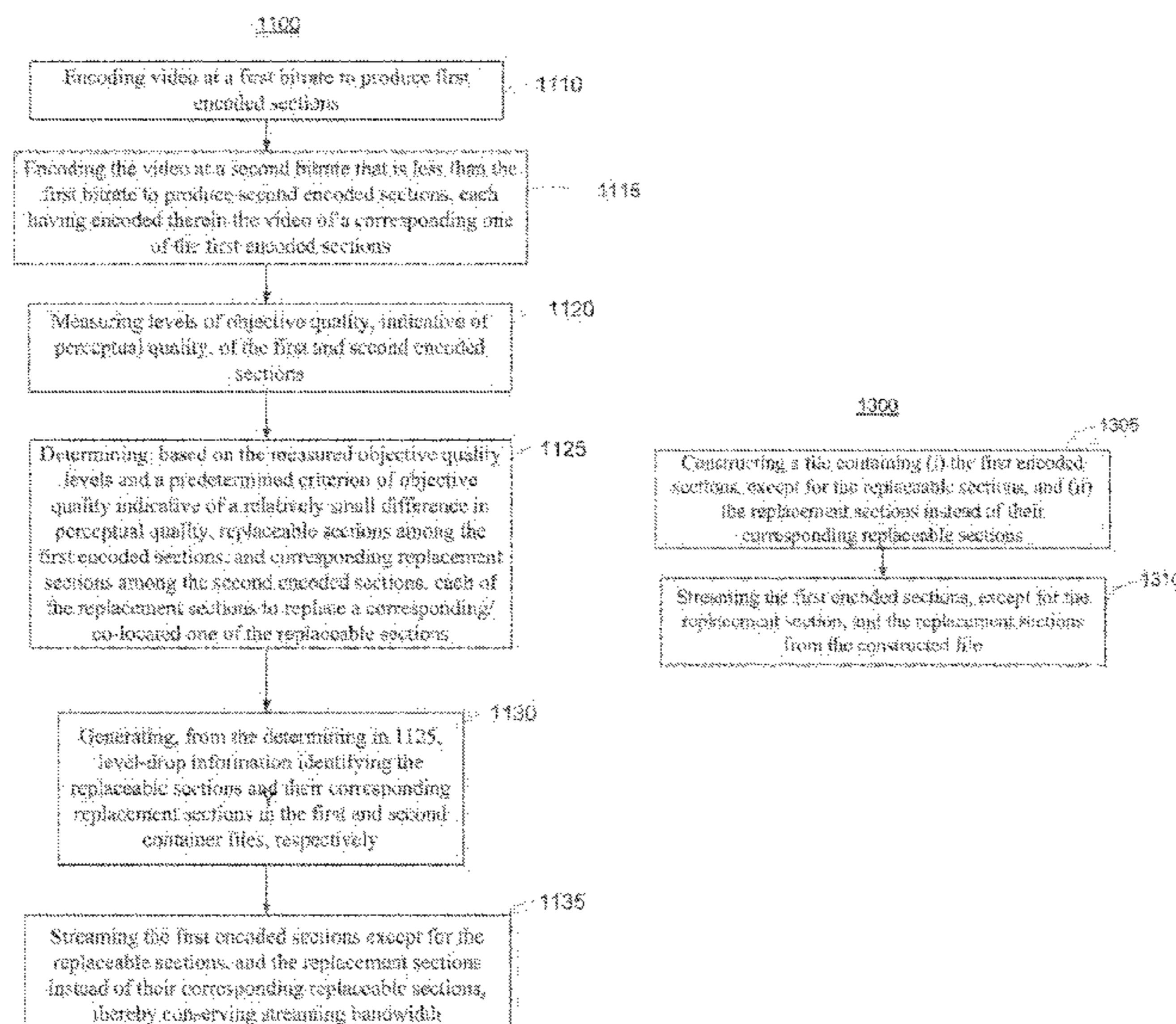

US RE49,990 E

(51)	Int. Cl.						
	<i>H04N 19/154</i>	(2014.01)		5,892,915 A	4/1999	Duso et al.	
	<i>H04N 19/164</i>	(2014.01)		5,903,261 A	5/1999	Walsh et al.	
	<i>H04N 19/46</i>	(2014.01)		5,907,597 A	5/1999	Mark	
				5,907,658 A	5/1999	Murase et al.	
				5,923,869 A	7/1999	Kashiwagi et al.	
				5,946,446 A	8/1999	Yanagihara	
				5,956,729 A	9/1999	Goetz et al.	
				5,959,690 A	9/1999	Toebes, VIII et al.	
				5,970,147 A	10/1999	Davis	
				5,973,679 A	10/1999	Abbott et al.	
				5,999,812 A	12/1999	Himsworth	
				6,002,834 A	12/1999	Hirabayashi et al.	
				6,009,237 A	12/1999	Hirabayashi et al.	
				6,016,381 A	1/2000	Taira et al.	
				6,031,622 A	2/2000	Ristow et al.	
				6,038,257 A	3/2000	Brusewitz et al.	
				6,038,316 A	3/2000	Dwork et al.	
				6,044,469 A	3/2000	Horstmann	
				6,046,778 A	4/2000	Nonomura et al.	
				6,047,100 A	4/2000	McLaren	
				6,057,832 A	5/2000	Lev et al.	
				6,058,240 A	5/2000	McLaren	
				6,064,794 A	5/2000	McLaren et al.	
				6,065,050 A	5/2000	DeMoney	
				6,018,611 A	6/2000	Nogami et al.	
				6,079,566 A	6/2000	Eleftheriadis et al.	
				6,097,877 A	8/2000	Katayama et al.	
				6,108,422 A	8/2000	Newby et al.	
				6,141,754 A	10/2000	Choy	
				6,151,634 A	11/2000	Glaser et al.	
				6,155,840 A	12/2000	Salette	
				6,169,242 B1	1/2001	Fay et al.	
				6,175,921 B1	1/2001	Rosen	
				6,192,075 B1	2/2001	Jeng et al.	
				6,195,388 B1	2/2001	Choi et al.	
				6,199,107 B1	3/2001	Dujari	
				6,204,883 B1	3/2001	Tsukagoshi	
				6,222,981 B1	4/2001	Rijckaert	
				6,266,483 B1	7/2001	Okada et al.	
				6,282,320 B1	8/2001	Hasegawa et al.	
				6,282,653 B1	8/2001	Berstis et al.	
				6,289,450 B1	9/2001	Pensak et al.	
				6,292,621 B1	9/2001	Tanaka et al.	
				6,308,005 B1	10/2001	Ando et al.	
				6,320,905 B1	11/2001	Konstantinides	
				6,330,286 B1	12/2001	Lyons et al.	
				6,347,145 B2	2/2002	Kato et al.	
				6,351,538 B1	2/2002	Uz	
				6,373,803 B2	4/2002	Ando et al.	
				6,374,144 B1	4/2002	Viviani et al.	
				6,389,218 B2	5/2002	Gordon et al.	
				6,389,473 B1	5/2002	Carmel et al.	
				6,395,969 B1	5/2002	Fuhrer	
				6,397,230 B1	5/2002	Carmel et al.	
				6,415,031 B1	7/2002	Colligan et al.	
				6,418,270 B1	7/2002	Steenhof et al.	
				6,441,754 B1	8/2002	Wang et al.	
				6,445,877 B1	9/2002	Okada et al.	
				6,449,719 B1	9/2002	Baker	
				6,453,115 B1	9/2002	Boyle	
				6,453,116 B1	9/2002	Ando et al.	
				6,466,671 B1	10/2002	Maillard et al.	
				6,466,733 B1	10/2002	Kim	
				6,504,873 B1	1/2003	Vehvilainen	
				6,510,513 B1	1/2003	Danieli	
				6,510,554 B1	1/2003	Gordon et al.	
				6,512,883 B2	1/2003	Shim et al.	
				6,516,064 B1	2/2003	Osawa et al.	
				6,532,262 B1	3/2003	Fukuda et al.	
				6,535,920 B1	3/2003	Parry et al.	
				6,578,200 B1	6/2003	Takao et al.	
				6,587,506 B1	7/2003	Noridomi et al.	
				6,594,699 B1	7/2003	Sahai et al.	
				6,621,979 B1	9/2003	Eerenberg et al.	
				6,625,320 B1	9/2003	Nilsson et al.	
				6,628,713 B1	9/2003	Kojima et al.	
				6,642,967 B1	11/2003	Saunders	
				6,654,933 B1	11/2003	Abbott et al.	
				6,658,056 B1	12/2003	Duruöz et al.	
(56)	References Cited						
	U.S. PATENT DOCUMENTS						
	4,694,357 A	9/1987	Rahman et al.				
	4,802,170 A	1/1989	Trottier				
	4,964,069 A	10/1990	Ely				
	5,119,474 A	6/1992	Beitel et al.				
	5,132,992 A	7/1992	Yurt et al.				
	5,274,758 A	12/1993	Beitel et al.				
	5,341,474 A	8/1994	Gelman et al.				
	5,361,332 A	11/1994	Yoshida et al.				
	5,396,497 A	3/1995	Veltman				
	5,400,401 A	3/1995	Wasilewski et al.				
	5,404,436 A	4/1995	Hamilton				
	5,420,801 A	5/1995	Dockter et al.				
	5,420,974 A	5/1995	Morris et al.				
	5,471,576 A	11/1995	Yee				
	5,477,263 A	12/1995	Ocallaghan et al.				
	5,479,303 A	12/1995	Suzuki et al.				
	5,487,167 A	1/1996	Dinallo et al.				
	5,502,766 A	3/1996	Boebert et al.				
	5,509,070 A	4/1996	Schull				
	5,533,021 A	7/1996	Branstad et al.				
	5,537,408 A	7/1996	Branstad et al.				
	5,539,908 A	7/1996	Chen et al.				
	5,541,662 A	7/1996	Adams et al.				
	5,544,318 A	8/1996	Schmitz et al.				
	5,550,863 A	8/1996	Yurt et al.				
	5,574,785 A	11/1996	Ueno et al.				
	5,583,652 A	12/1996	Ware				
	5,589,993 A	12/1996	Naimpally et al.				
	5,600,721 A	2/1997	Kitazato				
	5,614,940 A	3/1997	Cobbley et al.				
	5,621,794 A	4/1997	Matsuda et al.				
	5,627,936 A	5/1997	Prasad				
	5,630,005 A	5/1997	Ort				
	5,633,472 A	5/1997	DeWitt et al.				
	5,642,171 A	6/1997	Baumgartner et al.				
	5,642,338 A	6/1997	Fukushima et al.				
	5,655,117 A	8/1997	Goldberg et al.				
	5,664,044 A	9/1997	Ware				
	5,675,382 A	10/1997	Bauchspies				
	5,675,511 A	10/1997	Prasad et al.				
	5,684,542 A	11/1997	Tsukagoshi				
	5,715,403 A	2/1998	Stefik				
	5,717,816 A	2/1998	Boyce et al.				
	5,719,786 A	2/1998	Nelson et al.				
	5,745,643 A	4/1998	Mishina				
	5,751,280 A	5/1998	Abbott				
	5,751,358 A	5/1998	Suzuki et al.				
	5,754,648 A	5/1998	Ryan et al.				
	5,757,968 A	5/1998	Ando				
	5,761,417 A	6/1998	Henley et al.				
	5,763,800 A	6/1998	Rossum et al.				
	5,765,164 A	6/1998	Prasad et al.				
	5,794,018 A	8/1998	Vrvilo et al.				
	5,805,700 A	9/1998	Nardone et al.				
	5,813,010 A	9/1998	Kurano et al.				
	5,819,160 A	10/1998	Foladare et al.				
	5,822,524 A	10/1998	Chen et al.				
	5,828,370 A	10/1998	Moeller et al.				
	5,838,791 A	11/1998	Torii et al.				
	5,841,432 A	11/1998	Carmel et al.				
	5,844,575 A	12/1998	Reid				
	5,848,217 A	12/1998	Tsukagoshi et al.				
	5,852,664 A	12/1998	Iverson et al.				
	5,854,873 A	12/1998	Mori et al.				
	5,867,625 A	2/1999	McLaren				
	5,874,986 A	2/1999	Gibbon et al.				
	5,878,135 A	3/1999	Blatter et al.				
	5,887,110 A	3/1999	Sakamoto et al.				
	5,892,900 A	4/1999	Ginter et al.				

(56)

References Cited

U.S. PATENT DOCUMENTS

6,665,835	B1	12/2003	Gutfreund et al.	7,242,772	B1	7/2007	Tehranchi
6,671,408	B1	12/2003	Kaku	7,243,346	B1	7/2007	Seth et al.
6,690,838	B2	2/2004	Zhou	7,274,861	B2	9/2007	Yahata et al.
6,697,568	B1	2/2004	Kaku	7,295,673	B2	11/2007	Grab et al.
6,714,909	B1	3/2004	Gibbon et al.	7,302,490	B1	11/2007	Gupta et al.
6,721,794	B2	4/2004	Taylor et al.	7,315,829	B1	1/2008	Tagawa et al.
6,724,944	B1	4/2004	Kalevo et al.	7,328,345	B2	2/2008	Morten et al.
6,725,281	B1	4/2004	Zintel	7,330,875	B1	2/2008	Parasnis et al.
6,742,082	B1	5/2004	Lango et al.	7,340,528	B2	3/2008	Noblecourt et al.
6,751,623	B1	6/2004	Basso et al.	7,346,163	B2	3/2008	Pedlow, Jr. et al.
6,771,703	B1	8/2004	Oguz et al.	7,349,886	B2	3/2008	Morten et al.
6,807,306	B1	10/2004	Girgensohn et al.	7,349,976	B1	3/2008	Glaser et al.
6,810,031	B1	10/2004	Hegde et al.	7,352,956	B1	4/2008	Winter et al.
6,810,131	B2	10/2004	Nakagawa et al.	7,356,143	B2	4/2008	Morten
6,810,389	B1	10/2004	Meyer	7,356,245	B2	4/2008	Belknap et al.
6,813,437	B2	11/2004	Ando et al.	7,363,647	B1	4/2008	Fakharzadeh
6,819,394	B1	11/2004	Nomura et al.	7,366,788	B2	4/2008	Jones et al.
6,850,252	B1	2/2005	Hoffberg	7,376,233	B2	5/2008	Candelore et al.
6,856,997	B2	2/2005	Lee et al.	7,376,831	B2	5/2008	Kollmyer et al.
6,859,496	B1	2/2005	Boroczky et al.	7,382,879	B1	6/2008	Miller
6,868,525	B1	3/2005	Szabo	7,397,853	B2	7/2008	Kwon et al.
6,871,006	B1	3/2005	Oguz et al.	7,400,679	B2	7/2008	Kwon et al.
6,912,253	B1	6/2005	Li et al.	7,406,174	B2	7/2008	Palmer
6,912,513	B1	6/2005	Candelore	7,406,176	B2	7/2008	Zhu et al.
6,917,652	B2	7/2005	Lyu	7,418,132	B2	8/2008	Hoshuyama
6,931,531	B1	8/2005	Takahashi	7,421,411	B2	9/2008	Kontio et al.
6,931,543	B1	8/2005	Pang et al.	7,443,449	B2	10/2008	Momosaki et al.
6,944,621	B1	9/2005	Collart	7,454,780	B2	11/2008	Katsube et al.
6,944,629	B1	9/2005	Shioi et al.	7,457,359	B2	11/2008	Mabey et al.
6,956,901	B2	10/2005	Boroczky et al.	7,457,415	B2	11/2008	Reitmeier et al.
6,957,350	B1	10/2005	Demos	7,460,668	B2	12/2008	Grab et al.
6,965,646	B1	11/2005	Firestone	7,472,280	B2	12/2008	Giobbi
6,965,724	B1	11/2005	Boccon-Gibod et al.	7,478,325	B2	1/2009	Foehr et al.
6,965,993	B2	11/2005	Baker	7,484,103	B2	1/2009	Woo et al.
6,970,564	B1	11/2005	Kubota et al.	7,493,018	B2	2/2009	Kim
6,983,079	B2	1/2006	Kim	7,499,930	B2	3/2009	Naka et al.
6,985,588	B1	1/2006	Glick et al.	7,499,938	B2	3/2009	Collart
6,988,144	B1	1/2006	Luken et al.	7,515,710	B2	4/2009	Russell et al.
7,006,757	B2	2/2006	Ando et al.	7,526,450	B2	4/2009	Hughes et al.
7,007,170	B2	2/2006	Morten	7,539,213	B2	5/2009	Guillemot et al.
7,020,287	B2	3/2006	Unger	7,546,641	B2	6/2009	Robert et al.
7,023,924	B1	4/2006	Keller et al.	7,577,980	B2	8/2009	Kienzle et al.
7,023,992	B1	4/2006	Kubota et al.	7,594,271	B2	9/2009	Zhuk et al.
7,043,021	B2	5/2006	Graunke et al.	7,610,365	B1	10/2009	Kraft et al.
7,043,473	B1	5/2006	Rassool et al.	7,623,759	B2	11/2009	Shimoda
7,051,110	B2	5/2006	Hagai et al.	7,624,337	B2	11/2009	Sull et al.
7,054,968	B2	5/2006	Shrader et al.	7,627,750	B1	12/2009	Chan
7,058,177	B1	6/2006	Trimberger et al.	7,627,888	B2	12/2009	Ganesan et al.
7,073,191	B2	7/2006	Srikantan et al.	7,639,921	B2	12/2009	Seo et al.
7,103,906	B1	9/2006	Katz et al.	7,640,358	B2	12/2009	Deshpande
7,110,542	B1	9/2006	Tripathy	7,640,435	B2	12/2009	Morten
7,120,250	B2	10/2006	Candelore	7,644,172	B2	1/2010	Stewart et al.
7,124,303	B2	10/2006	Candelore et al.	7,653,686	B2	1/2010	Yoneda
7,127,155	B2	10/2006	Ando et al.	7,664,262	B2	2/2010	Haruki
7,139,868	B2	11/2006	Parry et al.	7,664,872	B2	2/2010	Osborne et al.
7,143,289	B2	11/2006	Denning et al.	7,676,555	B2	3/2010	Bushee et al.
7,150,045	B2	12/2006	Koelle et al.	7,689,510	B2	3/2010	Lamkin et al.
7,151,832	B1	12/2006	Fetkovich et al.	7,697,686	B2	4/2010	Puiatti et al.
7,151,833	B2	12/2006	Candelore et al.	7,702,925	B2	4/2010	Hanko et al.
7,165,175	B1	1/2007	Kollmyer et al.	7,711,052	B2	5/2010	Hannuksela et al.
7,167,560	B2	1/2007	Yu	7,711,647	B2	5/2010	Gunaseelan et al.
7,181,438	B1	2/2007	Szabo	7,720,352	B2	5/2010	Belknap et al.
7,185,363	B1	2/2007	Narin et al.	7,734,806	B2	6/2010	Park
7,188,183	B1	3/2007	Paul et al.	7,747,853	B2	6/2010	Candelore
7,191,335	B1	3/2007	Maillard	7,756,270	B2	7/2010	Shimosato et al.
7,197,234	B1	3/2007	Chatterton	7,756,271	B2	7/2010	Zhu et al.
7,203,313	B2	4/2007	England et al.	7,761,892	B2	7/2010	Ellis et al.
7,206,940	B2	4/2007	Evans et al.	7,779,097	B2	8/2010	Lamkin et al.
7,209,892	B1	4/2007	Galuten et al.	7,787,622	B2	8/2010	Sprunk
7,212,726	B2	5/2007	Zetts	7,788,271	B2	8/2010	Soma et al.
7,231,132	B1	6/2007	Davenport	7,797,720	B2	9/2010	Gopalakrishnan et al.
7,231,516	B1	6/2007	Sparrell et al.	7,817,608	B2	10/2010	Rassool et al.
7,233,669	B2	6/2007	Candelore	7,840,693	B2	11/2010	Gupta et al.
7,233,948	B1	6/2007	Shamoon et al.	7,853,980	B2	12/2010	Pedlow et al.
7,237,061	B1	6/2007	Boic	7,864,186	B2	1/2011	Robotham et al.
				7,869,691	B2	1/2011	Kelly et al.
				7,873,740	B2	1/2011	Sitaraman et al.
				7,877,002	B2	1/2011	Ikeda et al.
				7,881,478	B2	2/2011	Derouet

(56)

References Cited

U.S. PATENT DOCUMENTS

7,882,034 B2	2/2011	Hug et al.	8,510,303 B2	8/2013	Soroushian et al.
7,885,405 B1	2/2011	Bong	8,510,404 B2	8/2013	Carmel et al.
7,895,311 B1	2/2011	Juenger	8,514,926 B2	8/2013	Ro et al.
7,907,833 B2	3/2011	Lee	8,515,265 B2	8/2013	Kwon et al.
7,913,277 B1	3/2011	Rahrer	8,516,529 B2	8/2013	Lajoie et al.
7,945,143 B2	5/2011	Yahata et al.	8,526,610 B2	9/2013	Shamoon et al.
7,949,703 B2	5/2011	Matsuzaki et al.	8,527,645 B1	9/2013	Proffit et al.
7,962,942 B1	6/2011	Craner	8,543,842 B2	9/2013	Ginter et al.
7,970,835 B2	6/2011	St	8,555,329 B2	10/2013	Fröjdh et al.
7,974,714 B2	7/2011	Hoffberg	8,571,993 B2	10/2013	Kocher et al.
7,984,513 B1	7/2011	Kyne et al.	8,595,378 B1	11/2013	Cohn et al.
7,991,156 B1	8/2011	Miller	8,606,069 B2	12/2013	Okubo et al.
8,001,471 B2	8/2011	Shaver et al.	8,630,419 B2	1/2014	Mori
8,015,491 B2	9/2011	Shaver et al.	8,631,247 B2	1/2014	O'loughlin et al.
8,023,562 B2	9/2011	Zheludkov et al.	8,640,166 B1	1/2014	Craner et al.
8,046,453 B2	10/2011	Olaiya	8,649,669 B2	2/2014	Braness et al.
8,054,880 B2	11/2011	Yu et al.	8,650,599 B2	2/2014	Shindo et al.
8,065,708 B1	11/2011	Smyth et al.	8,656,183 B2	2/2014	Russell et al.
8,069,260 B2	11/2011	Speicher et al.	8,677,428 B2	3/2014	Lewis et al.
8,073,900 B2	12/2011	Guedalia et al.	8,681,866 B1	3/2014	Jia
8,074,083 B1	12/2011	Lee et al.	8,683,066 B2	3/2014	Hurst et al.
8,078,644 B2	12/2011	Hannuksela	8,689,267 B2	4/2014	Hunt
8,082,442 B2	12/2011	Keljo et al.	8,726,264 B1	5/2014	Allen et al.
8,131,875 B1	3/2012	Chen	8,731,193 B2	5/2014	Farkash et al.
8,135,041 B2	3/2012	Ramaswamy	8,731,369 B2	5/2014	Li et al.
8,160,157 B2	4/2012	Lamy-Bergot et al.	RE45,052 E	7/2014	Li
8,169,916 B1	5/2012	Pai et al.	8,767,825 B1	7/2014	Wang et al.
8,170,210 B2	5/2012	Manders et al.	8,774,609 B2	7/2014	Drake et al.
8,195,714 B2	6/2012	Mckibben et al.	8,781,122 B2	7/2014	Chan et al.
8,201,264 B2	6/2012	Grab et al.	8,782,268 B2	7/2014	Pyle et al.
8,213,607 B2	7/2012	Rose et al.	8,804,956 B2	8/2014	Hiriart
8,213,768 B2	7/2012	Morioka et al.	8,805,109 B2	8/2014	Shoham et al.
8,218,439 B2	7/2012	Deshpande	8,806,188 B2	8/2014	Braness et al.
8,225,061 B2	7/2012	Greenebaum	8,818,896 B2	8/2014	Candelore
8,233,768 B2	7/2012	Soroushian et al.	8,819,116 B1	8/2014	Tomay et al.
8,243,924 B2	8/2012	Chen et al.	8,832,434 B2	9/2014	Apostolopoulos et al.
8,245,124 B1	8/2012	Gupta	8,843,586 B2	9/2014	Pantos et al.
8,249,168 B2	8/2012	Graves	8,849,950 B2	9/2014	Stockhammer et al.
8,261,356 B2	9/2012	Choi et al.	8,850,205 B2	9/2014	Choi et al.
8,265,168 B1	9/2012	Masterson et al.	8,850,498 B1	9/2014	Roach et al.
8,270,473 B2	9/2012	Chen et al.	8,856,218 B1	10/2014	Inskip
8,270,819 B2	9/2012	Vannier	8,908,984 B2	12/2014	Shoham et al.
8,275,871 B2	9/2012	Ram et al.	8,909,922 B2	12/2014	Kiefer et al.
8,286,213 B2	10/2012	Seo	8,914,534 B2	12/2014	Braness et al.
8,286,621 B2	10/2012	Halmone	8,914,836 B2	12/2014	Shivadas et al.
8,289,338 B2	10/2012	Priyadarshi et al.	8,918,533 B2	12/2014	Chen et al.
8,290,157 B2	10/2012	Candelore	8,918,535 B2	12/2014	Ma et al.
8,291,460 B1	10/2012	Peacock	8,918,636 B2	12/2014	Kiefer
8,296,434 B1	10/2012	Miller et al.	8,918,908 B2	12/2014	Ziskind et al.
8,311,094 B2	11/2012	Kamariotis et al.	8,948,249 B2	2/2015	Sun et al.
8,311,111 B2	11/2012	Xu et al.	8,964,977 B2	2/2015	Ziskind et al.
8,311,115 B2	11/2012	Gu et al.	8,997,161 B2	3/2015	Priyadarshi et al.
8,312,079 B2	11/2012	Newsome et al.	8,997,254 B2	3/2015	Amidei et al.
8,321,556 B1	11/2012	Chatterjee et al.	9,014,471 B2	4/2015	Shoham et al.
8,325,800 B2	12/2012	Holcomb et al.	9,015,782 B2	4/2015	Acharya et al.
8,327,009 B2	12/2012	Prestenback et al.	9,025,659 B2	5/2015	Soroushian et al.
8,341,715 B2	12/2012	Sherkin et al.	9,038,116 B1	5/2015	Knox et al.
8,346,753 B2	1/2013	Hayes	9,038,121 B2	5/2015	Kienzle et al.
8,365,235 B2	1/2013	Hunt et al.	9,042,670 B2	5/2015	Carmel et al.
8,369,421 B2	2/2013	Kadono et al.	9,049,497 B2	6/2015	Chen et al.
8,380,041 B2	2/2013	Barton et al.	9,060,207 B2	6/2015	Scherkus et al.
8,386,621 B2	2/2013	Park	9,094,737 B2	7/2015	Shivadas et al.
8,396,114 B2	3/2013	Gu et al.	9,098,335 B2	8/2015	Muthiah et al.
8,397,265 B2	3/2013	Henocq et al.	9,111,098 B2	8/2015	Smith et al.
8,401,188 B1	3/2013	Swaminathan	9,124,773 B2	9/2015	Chan et al.
8,401,900 B2	3/2013	Cansler et al.	9,125,073 B2	9/2015	Oyman et al.
8,407,753 B2	3/2013	Kuo	9,184,920 B2	11/2015	Grab et al.
8,412,841 B1	4/2013	Swaminathan et al.	9,191,151 B2	11/2015	Luby et al.
8,423,889 B1	4/2013	Zagorie et al.	9,191,457 B2	11/2015	Van der Schaar
8,452,110 B2	5/2013	Shoham et al.	9,197,685 B2	11/2015	Soroushian
8,456,380 B2	6/2013	Pagan	9,201,922 B2	12/2015	Soroushian et al.
8,464,066 B1	6/2013	Price et al.	9,203,816 B2	12/2015	Brueck et al.
8,472,792 B2	6/2013	Butt	9,210,481 B2	12/2015	Braness et al.
8,473,630 B1	6/2013	Galligan	9,215,466 B2	12/2015	Zhai et al.
8,484,368 B2	7/2013	Robert et al.	9,247,311 B2	1/2016	Kiefer
			9,247,312 B2	1/2016	Braness et al.
			9,247,317 B2	1/2016	Shivadas et al.
			9,253,178 B2	2/2016	Blom et al.
			9,264,475 B2	2/2016	Shivadas et al.

(56)

References Cited

U.S. PATENT DOCUMENTS

9,294,531 B2	3/2016	Zhang et al.	2002/0116481 A1	8/2002	Lee
9,313,510 B2	4/2016	Shivadas et al.	2002/0118953 A1	8/2002	Kim
9,343,112 B2	5/2016	Amidei et al.	2002/0120934 A1	8/2002	Abrahams et al.
9,344,517 B2	5/2016	Shivadas et al.	2002/0135607 A1	9/2002	Kato et al.
9,344,721 B2	5/2016	Dikvall	2002/0136298 A1	9/2002	Anantharamu et al.
9,380,096 B2	6/2016	Luby et al.	2002/0141503 A1	10/2002	Kobayashi et al.
9,386,064 B2	7/2016	Luby et al.	2002/0143413 A1	10/2002	Fay et al.
9,479,805 B2	10/2016	Rothschild et al.	2002/0143547 A1	10/2002	Fay et al.
9,485,469 B2	11/2016	Kahn et al.	2002/0147980 A1	10/2002	Satoda
9,485,546 B2	11/2016	Chen et al.	2002/0154779 A1	10/2002	Asano et al.
9,571,827 B2	2/2017	Su et al.	2002/0159528 A1	10/2002	Graziani et al.
9,584,557 B2	2/2017	Panje et al.	2002/0159598 A1	10/2002	Rubinstein et al.
9,584,847 B2	2/2017	Ma et al.	2002/0161462 A1	10/2002	Fay
9,615,061 B2	4/2017	Carney et al.	2002/0161797 A1	10/2002	Gallo et al.
9,621,522 B2	4/2017	Kiefer et al.	2002/0164024 A1	11/2002	Arakawa et al.
9,628,536 B2	4/2017	Luby et al.	2002/0169926 A1	11/2002	Pinckney et al.
9,667,684 B2	5/2017	Ziskind et al.	2002/0169971 A1	11/2002	Asano et al.
9,672,286 B2	6/2017	Soroushian et al.	2002/0180929 A1	12/2002	Tseng et al.
9,674,254 B2	6/2017	Pare et al.	2002/0184159 A1	12/2002	Tadayon et al.
9,686,332 B1	6/2017	Binns et al.	2002/0184515 A1	12/2002	Oho et al.
9,706,259 B2	7/2017	Chan et al.	2002/0191112 A1	12/2002	Akiyoshi et al.
9,712,890 B2	7/2017	Shivadas et al.	2002/0191959 A1	12/2002	Lin et al.
9,761,274 B2	9/2017	Delpuch et al.	2002/0191960 A1	12/2002	Fujinami et al.
9,798,863 B2	10/2017	Grab et al.	2003/0001964 A1	1/2003	Masukura et al.
9,813,740 B2	11/2017	Panje et al.	2003/0002577 A1	1/2003	Pinder
9,866,878 B2	1/2018	van der Schaar et al.	2003/0002578 A1	1/2003	Tsukagoshi et al.
9,883,204 B2	1/2018	Braness et al.	2003/0005442 A1	1/2003	Brodersen et al.
9,906,785 B2	2/2018	Naletov et al.	2003/0021296 A1	1/2003	Wee et al.
9,967,189 B2	5/2018	Patel et al.	2003/0031178 A1	2/2003	Haeri
9,967,305 B2	5/2018	Braness	2003/0035488 A1	2/2003	Barrau
9,967,521 B2	5/2018	Kahn et al.	2003/0035545 A1	2/2003	Jiang
10,169,094 B2	1/2019	Iyer	2003/0035546 A1	2/2003	Jiang et al.
10,171,873 B2	1/2019	Krebs	2003/0041257 A1	2/2003	Wee et al.
10,212,486 B2	2/2019	Chan et al.	2003/0043847 A1	3/2003	Haddad
10,225,299 B2	3/2019	van der Schaar et al.	2003/0044080 A1	3/2003	Frishman et al.
10,225,588 B2	3/2019	Kiefer et al.	2003/0051237 A1	3/2003	Sako et al.
10,244,272 B2	3/2019	Kiefer et al.	2003/0053541 A1	3/2003	Sun et al.
10,264,255 B2	4/2019	Naletov et al.	2003/0061305 A1	3/2003	Copley et al.
10,321,168 B2	6/2019	van der Schaar et al.	2003/0061369 A1	3/2003	Aksu et al.
10,341,698 B2	7/2019	Kiefer et al.	2003/0063675 A1	4/2003	Kang et al.
10,368,096 B2	7/2019	Braness et al.	2003/0065777 A1	4/2003	Mattila et al.
10,382,785 B2	8/2019	Braness et al.	2003/0077071 A1	4/2003	Lin et al.
10,437,896 B2	10/2019	Soroushian et al.	2003/0078891 A1	4/2003	Capitant
10,462,537 B2	10/2019	Shivadas et al.	2003/0078930 A1	4/2003	Surcouf et al.
10,715,806 B2	7/2020	Naletov et al.	2003/0079222 A1	4/2003	Boykin et al.
10,805,368 B2	10/2020	van der Schaar et al.	2003/0081776 A1	5/2003	Candelore
10,856,020 B2	12/2020	Kiefer et al.	2003/0093799 A1	5/2003	Kauffman et al.
10,893,305 B2	1/2021	van der Schaar et al.	2003/0123855 A1	7/2003	Okada et al.
10,992,955 B2	4/2021	Braness et al.	2003/0128296 A1	7/2003	Lee
RE48,761 E	9/2021	Shivadas et al.	2003/0133506 A1	7/2003	Haneda
11,638,033 B2	4/2023	Braness et al.	2003/0135633 A1	7/2003	Dror et al.
2001/0021276 A1	9/2001	Zhou	2003/0135742 A1	7/2003	Evans
2001/0030710 A1	10/2001	Werner	2003/0142594 A1	7/2003	Tsumagari et al.
2001/0036355 A1	11/2001	Kelly et al.	2003/0152224 A1	8/2003	Candelore et al.
2001/0046299 A1	11/2001	Wasilewski et al.	2003/0152370 A1	8/2003	Otomo et al.
2001/0052077 A1	12/2001	Fung et al.	2003/0163824 A1	8/2003	Gordon et al.
2001/0052127 A1	12/2001	Seo et al.	2003/0165328 A1	9/2003	Grecia
2001/0053222 A1	12/2001	Wakao et al.	2003/0174844 A1	9/2003	Candelore
2001/0055337 A1	12/2001	Matsuzaki et al.	2003/0185302 A1	10/2003	Abrams
2002/0026560 A1	2/2002	Jordan et al.	2003/0185542 A1	10/2003	McVeigh et al.
2002/0034252 A1	3/2002	Owen et al.	2003/0206558 A1	11/2003	Parkkinen et al.
2002/0048450 A1	4/2002	Zetts	2003/0206717 A1	11/2003	Yogeshwar et al.
2002/0051494 A1	5/2002	Yamaguchi et al.	2003/0210821 A1	11/2003	Yogeshwar et al.
2002/0057739 A1	5/2002	Hasebe et al.	2003/0216922 A1	11/2003	Gonzales et al.
2002/0057898 A1	5/2002	Normile	2003/0229900 A1	12/2003	Reisman
2002/0062313 A1	5/2002	Lee et al.	2003/0231863 A1	12/2003	Eerenberg et al.
2002/0067432 A1	6/2002	Kondo et al.	2003/0231867 A1	12/2003	Gates et al.
2002/0075572 A1	6/2002	Boreczky et al.	2003/0233464 A1	12/2003	Walpole et al.
2002/0076112 A1	6/2002	Devara	2003/0236836 A1	12/2003	Borthwick
2002/0087569 A1	7/2002	Fischer et al.	2003/0236907 A1	12/2003	Stewart et al.
2002/0091665 A1	7/2002	Beek et al.	2004/0001594 A1	1/2004	Krishnaswamy et al.
2002/0093571 A1	7/2002	Hyodo	2004/0003008 A1	1/2004	Wasilewski et al.
2002/0107802 A1	8/2002	Philips	2004/0006701 A1	1/2004	Kresina
2002/0110193 A1	8/2002	Yoo et al.	2004/0021684 A1	2/2004	Millner
2002/0114330 A1	8/2002	Cheung et al.	2004/0022391 A1	2/2004	Obrien
			2004/0024688 A1	2/2004	Bi et al.
			2004/0025180 A1	2/2004	Begeja et al.
			2004/0028227 A1	2/2004	Yu
			2004/0031058 A1	2/2004	Reisman

(56)

References Cited

U.S. PATENT DOCUMENTS

2004/0037421	A1	2/2004	Truman	2005/0262257	A1	11/2005	Major et al.
2004/0039916	A1	2/2004	Aldis et al.	2005/0265555	A1	12/2005	Pippuri
2004/0047592	A1	3/2004	Seo et al.	2005/0273695	A1	12/2005	Schnurr
2004/0047607	A1	3/2004	Seo et al.	2005/0275656	A1	12/2005	Corbin et al.
2004/0047614	A1	3/2004	Green	2006/0013568	A1	1/2006	Rodriguez
2004/0049690	A1	3/2004	Candelore et al.	2006/0015580	A1	1/2006	Gabriel et al.
2004/0049694	A1	3/2004	Candelore	2006/0020825	A1	1/2006	Grab
2004/0052501	A1	3/2004	Tam	2006/0026294	A1	2/2006	Virdi et al.
2004/0071453	A1	4/2004	Valderas	2006/0026302	A1	2/2006	Bennett et al.
2004/0073917	A1	4/2004	Pedlow et al.	2006/0026654	A1	2/2006	An et al.
2004/0076237	A1	4/2004	Kadono et al.	2006/0036549	A1	2/2006	Wu
2004/0081333	A1	4/2004	Grab et al.	2006/0037057	A1	2/2006	Xu
2004/0081434	A1	4/2004	Jung et al.	2006/0052095	A1	3/2006	Vazvan
2004/0084035	A1	5/2004	Newton	2006/0053080	A1	3/2006	Edmonson et al.
2004/0088557	A1	5/2004	Malcolm et al.	2006/0059223	A1	3/2006	Klemets et al.
2004/0093494	A1	5/2004	Nishimoto et al.	2006/0064605	A1	3/2006	Giobbi
2004/0093618	A1	5/2004	Baldwin et al.	2006/0078301	A1	4/2006	Ikeda et al.
2004/0101059	A1	5/2004	Joch et al.	2006/0093318	A1	5/2006	Cohen et al.
2004/0101142	A1	5/2004	Nasypny	2006/0093320	A1	5/2006	Hallberg et al.
2004/0105549	A1	6/2004	Suzuki et al.	2006/0095472	A1	5/2006	Krikorian et al.
2004/0107356	A1	6/2004	Shamoon et al.	2006/0109856	A1	5/2006	Deshpande
2004/0114687	A1	6/2004	Ferris et al.	2006/0120378	A1	6/2006	Usuki et al.
2004/0117347	A1	6/2004	Seo et al.	2006/0129909	A1	6/2006	Butt et al.
2004/0136698	A1	7/2004	Mock	2006/0165163	A1	7/2006	Burazerovic et al.
2004/0139335	A1	7/2004	Diamand et al.	2006/0165233	A1	7/2006	Nonaka et al.
2004/0143760	A1	7/2004	Alkove et al.	2006/0168298	A1	7/2006	Aoki et al.
2004/0146276	A1	7/2004	Ogawa	2006/0168639	A1	7/2006	Gan et al.
2004/0158878	A1	8/2004	Ratnakar et al.	2006/0173887	A1	8/2006	Breitfeld et al.
2004/0184534	A1	9/2004	Wang	2006/0179239	A1	8/2006	Fluhr et al.
2004/0184616	A1	9/2004	Morten et al.	2006/0181965	A1	8/2006	Collart
2004/0202320	A1	10/2004	Amini et al.	2006/0210245	A1	9/2006	Mccrossan et al.
2004/0213094	A1	10/2004	Suzuki	2006/0212370	A1	9/2006	Shear et al.
2004/0217971	A1	11/2004	Kim	2006/0218251	A1	9/2006	Tanabe
2004/0243488	A1	12/2004	Yamamoto et al.	2006/0235880	A1	10/2006	Qian
2004/0243714	A1	12/2004	Wynn et al.	2006/0235883	A1	10/2006	Krebs
2004/0255115	A1	12/2004	DeMello et al.	2006/0245727	A1	11/2006	Nakano et al.
2004/0255236	A1	12/2004	Collart	2006/0259588	A1	11/2006	Lerman et al.
2004/0267952	A1	12/2004	He et al.	2006/0263056	A1	11/2006	Lin et al.
2005/0004875	A1	1/2005	Kontio et al.	2006/0267986	A1	11/2006	Bae
2005/0005025	A1	1/2005	Harville et al.	2006/0274835	A1	12/2006	Hamilton et al.
2005/0005143	A1	1/2005	Lang et al.	2006/0294164	A1	12/2006	Armangau et al.
2005/0013494	A1	1/2005	Srinivasan et al.	2007/0005333	A1	1/2007	Setiohardjo et al.
2005/0015509	A1	1/2005	Sitaraman et al.	2007/0031110	A1	2/2007	Rijckaert
2005/0015797	A1	1/2005	Noblecourt et al.	2007/0033419	A1	2/2007	Kocher et al.
2005/0038826	A1	2/2005	Bae et al.	2007/0044010	A1	2/2007	Sull et al.
2005/0055399	A1	3/2005	Savchuk	2007/0047645	A1	3/2007	Takashima
2005/0063541	A1	3/2005	Candelore	2007/0047901	A1	3/2007	Ando et al.
2005/0066063	A1	3/2005	Grigorovitch et al.	2007/0053513	A1	3/2007	Hoffberg
2005/0071280	A1	3/2005	Irwin et al.	2007/0055982	A1	3/2007	Spilo
2005/0076232	A1	4/2005	Kawaguchi	2007/0058928	A1	3/2007	Naito et al.
2005/0102371	A1	5/2005	Aksu	2007/0067472	A1	3/2007	Maertens et al.
2005/0108320	A1	5/2005	Lord et al.	2007/0067622	A1	3/2007	Nakano et al.
2005/0114534	A1	5/2005	Lee	2007/0083467	A1	4/2007	Lindahl et al.
2005/0114896	A1	5/2005	Hug	2007/0083617	A1	4/2007	Chakrabarti et al.
2005/0120132	A1	6/2005	Hutter	2007/0086528	A1	4/2007	Mauchly et al.
2005/0132208	A1	6/2005	Hug et al.	2007/0100757	A1	5/2007	Rhoads
2005/0138655	A1	6/2005	Zimler et al.	2007/0101271	A1	5/2007	Hua et al.
2005/0144468	A1	6/2005	Northcutt	2007/0101387	A1	5/2007	Hua et al.
2005/0149450	A1	7/2005	Stefik et al.	2007/0106863	A1	5/2007	Bonwick et al.
2005/0177741	A1	8/2005	Chen et al.	2007/0133603	A1	6/2007	Weaver
2005/0180641	A1	8/2005	Clark	2007/0136817	A1	6/2007	Nguyen
2005/0183120	A1	8/2005	Jain et al.	2007/0140647	A1	6/2007	Kusunoki et al.
2005/0190911	A1	9/2005	Pare et al.	2007/0154165	A1	7/2007	Hemmerlyckx-Deleersnijder et al.
2005/0192904	A1	9/2005	Candelore	2007/0156770	A1	7/2007	Espelien
2005/0193070	A1	9/2005	Brown et al.	2007/0157267	A1	7/2007	Lopez-Estrada
2005/0193322	A1	9/2005	Lamkin et al.	2007/0162568	A1	7/2007	Gupta et al.
2005/0196147	A1	9/2005	Seo et al.	2007/0162981	A1	7/2007	Morioka et al.
2005/0198364	A1	9/2005	Val et al.	2007/0166000	A1	7/2007	Nallur et al.
2005/0204289	A1	9/2005	Mohammed et al.	2007/0168541	A1	7/2007	Gupta et al.
2005/0207442	A1	9/2005	Zoest et al.	2007/0168542	A1	7/2007	Gupta et al.
2005/0207578	A1	9/2005	Matsuyama et al.	2007/0178933	A1	8/2007	Nelson
2005/0216752	A1	9/2005	Hofmeyr et al.	2007/0180051	A1	8/2007	Kelly et al.
2005/0227773	A1	10/2005	Lu et al.	2007/0180125	A1	8/2007	Knowles et al.
2005/0243912	A1	11/2005	Kwon et al.	2007/0185982	A1	8/2007	Nakanowatari et al.
2005/0254508	A1	11/2005	Aksu et al.	2007/0192810	A1	8/2007	Pritchett et al.
				2007/0201502	A1	8/2007	Abramson
				2007/0201695	A1	8/2007	Saarikivi
				2007/0204003	A1	8/2007	Abramson

(56)

References Cited

U.S. PATENT DOCUMENTS

2007/0204011	A1	8/2007	Shaver et al.	2009/0010622	A1	1/2009	Yahata et al.
2007/0204115	A1	8/2007	Abramson	2009/0013195	A1	1/2009	Ochi et al.
2007/0217339	A1	9/2007	Zhao	2009/0031220	A1	1/2009	Tranchant et al.
2007/0217759	A1	9/2007	Dodd	2009/0037959	A1	2/2009	Suh et al.
2007/0220118	A1	9/2007	Loyer	2009/0048852	A1	2/2009	Burns et al.
2007/0234391	A1	10/2007	Hunter et al.	2009/0055546	A1	2/2009	Jung et al.
2007/0239839	A1	10/2007	Buday et al.	2009/0060452	A1	3/2009	Chaudhri
2007/0250536	A1	10/2007	Tanaka et al.	2009/0064341	A1	3/2009	Hartung et al.
2007/0255940	A1	11/2007	Ueno	2009/0066839	A1	3/2009	Jung et al.
2007/0256141	A1	11/2007	Nakano et al.	2009/0067367	A1	3/2009	Buracchini et al.
2007/0271317	A1	11/2007	Carmel	2009/0077143	A1	3/2009	Macy, Jr.
2007/0271385	A1	11/2007	Davis et al.	2009/0097644	A1	4/2009	Haruki
2007/0274679	A1	11/2007	Yahata et al.	2009/0106082	A1	4/2009	Senti et al.
2007/0277219	A1	11/2007	Toebe et al.	2009/0132599	A1	5/2009	Soroushian et al.
2007/0277234	A1	11/2007	Bessonov et al.	2009/0132721	A1	5/2009	Soroushian et al.
2007/0280298	A1	12/2007	Hearn et al.	2009/0132824	A1	5/2009	Terada et al.
2007/0288745	A1	12/2007	Kwan	2009/0136216	A1	5/2009	Soroushian et al.
2007/0292107	A1	12/2007	Yahata et al.	2009/0138570	A1	5/2009	Miura et al.
2007/0297422	A1	12/2007	Matsuo et al.	2009/0150406	A1	6/2009	Giblin
2008/0005175	A1	1/2008	Bourke et al.	2009/0150557	A1	6/2009	Wormley et al.
2008/0008319	A1	1/2008	Poirier	2009/0165148	A1	6/2009	Frey et al.
2008/0008455	A1	1/2008	De Lange et al.	2009/0168795	A1	7/2009	Segel et al.
2008/0022005	A1	1/2008	Wu et al.	2009/0169001	A1	7/2009	Tighe et al.
2008/0043832	A1	2/2008	Barkley et al.	2009/0169181	A1	7/2009	Priyadarshi et al.
2008/0046718	A1	2/2008	Grab et al.	2009/0172201	A1	7/2009	Carmel et al.
2008/0046925	A1	2/2008	Lee et al.	2009/0178090	A1	7/2009	Oztascent
2008/0066099	A1	3/2008	Broderson et al.	2009/0196139	A1	8/2009	Bates et al.
2008/0066181	A1	3/2008	Haveson et al.	2009/0201988	A1	8/2009	Gazier et al.
2008/0077592	A1	3/2008	Brodie et al.	2009/0217317	A1	8/2009	White et al.
2008/0086456	A1	4/2008	Rasanen et al.	2009/0226148	A1	9/2009	Nesvadba et al.
2008/0086570	A1	4/2008	Dey et al.	2009/0228395	A1	9/2009	Wegner et al.
2008/0086747	A1	4/2008	Rasanen et al.	2009/0249081	A1	10/2009	Zayas
2008/0101466	A1	5/2008	Swenson et al.	2009/0265737	A1	10/2009	Issa et al.
2008/0101718	A1	5/2008	Yang et al.	2009/0268905	A1	10/2009	Matsushima et al.
2008/0104633	A1	5/2008	Noblecourt et al.	2009/0276636	A1	11/2009	Grab et al.
2008/0120330	A1	5/2008	Reed et al.	2009/0282162	A1	11/2009	Mehrotra et al.
2008/0120342	A1	5/2008	Reed et al.	2009/0290706	A1	11/2009	Amini et al.
2008/0120389	A1	5/2008	Bassali et al.	2009/0290708	A1	11/2009	Schneider et al.
2008/0120637	A1	5/2008	Deiss	2009/0293116	A1	11/2009	DeMello
2008/0126248	A1	5/2008	Lee et al.	2009/0303241	A1	12/2009	Priyadarshi et al.
2008/0131078	A1	6/2008	Jeong et al.	2009/0307258	A1	12/2009	Priyadarshi et al.
2008/0134043	A1	6/2008	Georgis	2009/0307267	A1	12/2009	Chen et al.
2008/0137541	A1	6/2008	Agarwal et al.	2009/0310819	A1	12/2009	Hatano
2008/0137736	A1	6/2008	Richardson et al.	2009/0310933	A1	12/2009	Lee
2008/0137847	A1	6/2008	Candelore et al.	2009/0313544	A1	12/2009	Wood et al.
2008/0151817	A1	6/2008	Fitchett	2009/0313564	A1	12/2009	Rottler et al.
2008/0155615	A1	6/2008	Craner et al.	2009/0316783	A1	12/2009	Au et al.
2008/0160911	A1	7/2008	Chou et al.	2009/0328124	A1	12/2009	Khousam et al.
2008/0162949	A1	7/2008	Sato et al.	2009/0328228	A1	12/2009	Schnell
2008/0168516	A1	7/2008	Flick et al.	2010/0005393	A1	1/2010	Tokashiki et al.
2008/0172441	A1	7/2008	Speicher et al.	2010/0040351	A1	2/2010	Toma et al.
2008/0177793	A1	7/2008	Epstein et al.	2010/0057928	A1	3/2010	Kapoor et al.
2008/0184119	A1	7/2008	Eyal et al.	2010/0058405	A1	3/2010	Ramakrishnan et al.
2008/0187283	A1	8/2008	Takahashi	2010/0074324	A1	3/2010	Qian et al.
2008/0192818	A1	8/2008	DiPietro et al.	2010/0074333	A1	3/2010	Au et al.
2008/0195664	A1	8/2008	Maharajh et al.	2010/0083322	A1	4/2010	Rouse
2008/0195744	A1	8/2008	Bowra et al.	2010/0094969	A1	4/2010	Zuckerman et al.
2008/0201705	A1	8/2008	Wookey	2010/0095121	A1	4/2010	Shetty et al.
2008/0205860	A1	8/2008	Holtman	2010/0106968	A1	4/2010	Mori et al.
2008/0209534	A1	8/2008	Keronen et al.	2010/0107260	A1	4/2010	Orrell et al.
2008/0219449	A1	9/2008	Ball et al.	2010/0111192	A1	5/2010	Graves
2008/0229025	A1	9/2008	Plamondon	2010/0138903	A1	6/2010	Medvinsky
2008/0240144	A1	10/2008	Kruse et al.	2010/0142915	A1	6/2010	Mcdermott et al.
2008/0256105	A1	10/2008	Nogawa et al.	2010/0142917	A1	6/2010	Isaji
2008/0263354	A1	10/2008	Beuque	2010/0158109	A1	6/2010	Dahlby et al.
2008/0271102	A1	10/2008	Kienzle et al.	2010/0161825	A1	6/2010	Ronca et al.
2008/0279535	A1	11/2008	Haque et al.	2010/0166060	A1	7/2010	Ezure et al.
2008/0294453	A1	11/2008	Baird-Smith et al.	2010/0185854	A1	7/2010	Burns et al.
2008/0298358	A1	12/2008	John et al.	2010/0186092	A1	7/2010	Takechi et al.
2008/0310454	A1	12/2008	Bellwood et al.	2010/0189183	A1	7/2010	Gu et al.
2008/0310496	A1	12/2008	Fang	2010/0198943	A1	8/2010	Harrang et al.
2008/0313541	A1	12/2008	Shafton et al.	2010/0218208	A1	8/2010	Holden
2008/0320100	A1	12/2008	Pantos et al.	2010/0228795	A1	9/2010	Hahn
2008/0320160	A1	12/2008	Sitaraman et al.	2010/0235472	A1	9/2010	Sood et al.
2009/0010429	A1	1/2009	Kim et al.	2010/0235528	A1	9/2010	Bocharov et al.
				2010/0250532	A1	9/2010	Soroushian et al.
				2010/0290761	A1	11/2010	Drake et al.
				2010/0299522	A1	11/2010	Khambete et al.
				2010/0306249	A1	12/2010	Hill et al.

(56)

References Cited

U.S. PATENT DOCUMENTS

2010/0313225	A1	12/2010	Cholas et al.	2012/0036544	A1	2/2012	Chen et al.
2010/0313226	A1	12/2010	Cholas et al.	2012/0042090	A1	2/2012	Chen et al.
2010/0316126	A1	12/2010	Chen et al.	2012/0047542	A1	2/2012	Lewis et al.
2010/0319014	A1	12/2010	Lockett et al.	2012/0066360	A1	3/2012	Ghosh
2010/0319017	A1	12/2010	Cook	2012/0093214	A1	4/2012	Urbach
2010/0332595	A1	12/2010	Fullagar et al.	2012/0110120	A1	5/2012	Willig et al.
2011/0002381	A1	1/2011	Yang et al.	2012/0114302	A1	5/2012	Randall
2011/0010466	A1	1/2011	Fan et al.	2012/0124191	A1	5/2012	Lyon
2011/0016225	A1	1/2011	Park et al.	2012/0134496	A1	5/2012	Farkash et al.
2011/0035517	A1	2/2011	Minnick et al.	2012/0137336	A1	5/2012	Applegate et al.
2011/0047209	A1	2/2011	Lindholm et al.	2012/0144117	A1	6/2012	Weare et al.
2011/0055585	A1	3/2011	Lee	2012/0144445	A1	6/2012	Bonta et al.
2011/0058675	A1	3/2011	Brueck et al.	2012/0147958	A1	6/2012	Ronca et al.
2011/0060808	A1	3/2011	Martin et al.	2012/0166633	A1	6/2012	Baumback et al.
2011/0066673	A1	3/2011	Outlaw	2012/0167132	A1	6/2012	Mathews et al.
2011/0067057	A1	3/2011	Karaoguz et al.	2012/0170642	A1	7/2012	Braness et al.
2011/0069757	A1	3/2011	Ammu et al.	2012/0170643	A1	7/2012	Soroushian et al.
2011/0078440	A1	3/2011	Feng et al.	2012/0170906	A1	7/2012	Soroushian et al.
2011/0080940	A1	4/2011	Bocharov	2012/0170915	A1	7/2012	Braness et al.
2011/0082914	A1	4/2011	Robert et al.	2012/0173751	A1	7/2012	Braness et al.
2011/0082924	A1	4/2011	Gopalakrishnan	2012/0177101	A1	7/2012	van der Schaar
2011/0083009	A1	4/2011	Shamoon et al.	2012/0179834	A1	7/2012	Van Der
2011/0096828	A1	4/2011	Chen et al.	2012/0188069	A1	7/2012	Colombo et al.
2011/0103374	A1	5/2011	Lajoie et al.	2012/0189069	A1	7/2012	Iannuzzelli et al.
2011/0107379	A1	5/2011	Lajoie et al.	2012/0201475	A1	8/2012	Carmel et al.
2011/0116772	A1	5/2011	Kwon et al.	2012/0201476	A1	8/2012	Carmel et al.
2011/0126191	A1	5/2011	Hughes et al.	2012/0233345	A1	9/2012	Hannuksela
2011/0129011	A1	6/2011	Cilli et al.	2012/0240176	A1	9/2012	Ma et al.
2011/0135090	A1	6/2011	Chan et al.	2012/0254455	A1	10/2012	Adimatyam et al.
2011/0138018	A1	6/2011	Raveendran et al.	2012/0257678	A1	10/2012	Zhou et al.
2011/0142415	A1	6/2011	Rhyu	2012/0260277	A1	10/2012	Kosciewicz
2011/0145726	A1	6/2011	Wei et al.	2012/0263434	A1	10/2012	Wainner et al.
2011/0145858	A1	6/2011	Philpott et al.	2012/0265562	A1	10/2012	Daouk et al.
2011/0149753	A1	6/2011	Bapst et al.	2012/0278496	A1	11/2012	Hsu
2011/0150100	A1	6/2011	Abadir	2012/0288015	A1	11/2012	Zhang et al.
2011/0153785	A1	6/2011	Minborg et al.	2012/0289147	A1	11/2012	Raleigh et al.
2011/0153835	A1	6/2011	Rimac et al.	2012/0294355	A1	11/2012	Holcomb et al.
2011/0158470	A1	6/2011	Martin et al.	2012/0297039	A1	11/2012	Acuna et al.
2011/0170687	A1	7/2011	Hyodo et al.	2012/0307883	A1	12/2012	Graves
2011/0173345	A1	7/2011	Knox et al.	2012/0311094	A1	12/2012	Biderman et al.
2011/0179185	A1	7/2011	Wang et al.	2012/0311174	A1	12/2012	Bichot et al.
2011/0184738	A1	7/2011	Kalisky et al.	2012/0314778	A1	12/2012	Salustri et al.
2011/0191439	A1	8/2011	Dazzi et al.	2012/0317235	A1	12/2012	Nguyen et al.
2011/0191803	A1	8/2011	Baldwin et al.	2012/0331167	A1	12/2012	Hunt
2011/0197237	A1	8/2011	Turner	2013/0007223	A1	1/2013	Luby et al.
2011/0197261	A1	8/2011	Dong et al.	2013/0013730	A1	1/2013	Li et al.
2011/0197267	A1	8/2011	Gravel et al.	2013/0013803	A1	1/2013	Bichot et al.
2011/0213827	A1	9/2011	Kaspar et al.	2013/0019107	A1	1/2013	Grab et al.
2011/0222786	A1	9/2011	Carmel et al.	2013/0019273	A1	1/2013	Ma et al.
2011/0225302	A1	9/2011	Park et al.	2013/0041808	A1	2/2013	Pham et al.
2011/0225315	A1	9/2011	Wexler et al.	2013/0044821	A1	2/2013	Braness et al.
2011/0225417	A1	9/2011	Maharajh et al.	2013/0046849	A1	2/2013	Wolf
2011/0238789	A1	9/2011	Luby et al.	2013/0046902	A1	2/2013	Villegas Nuñez et al.
2011/0239078	A1	9/2011	Luby et al.	2013/0051554	A1	2/2013	Braness et al.
2011/0246657	A1	10/2011	Glow	2013/0054958	A1	2/2013	Braness et al.
2011/0246659	A1	10/2011	Bouazizi	2013/0055084	A1	2/2013	Soroushian et al.
2011/0246661	A1	10/2011	Manzari et al.	2013/0058480	A1	3/2013	Ziskind et al.
2011/0252118	A1	10/2011	Pantos et al.	2013/0061040	A1	3/2013	Kiefer et al.
2011/0264530	A1	10/2011	Santangelo et al.	2013/0061045	A1	3/2013	Kiefer et al.
2011/0268178	A1	11/2011	Park	2013/0064466	A1	3/2013	Carmel et al.
2011/0276555	A1	11/2011	Fiero	2013/0066838	A1	3/2013	Singla et al.
2011/0276695	A1	11/2011	Maldaner et al.	2013/0080267	A1	3/2013	McGowan
2011/0283012	A1	11/2011	Melnyk	2013/0094565	A1*	4/2013	Yang et al. 375/240.02
2011/0291723	A1	12/2011	Hashimoto	2013/0097309	A1	4/2013	Ma et al.
2011/0296048	A1	12/2011	Knox et al.	2013/0114944	A1	5/2013	Soroushian et al.
2011/0302319	A1	12/2011	Ha et al.	2013/0124859	A1	5/2013	Pestoni et al.
2011/0305273	A1	12/2011	He et al.	2013/0128962	A1	5/2013	Rajagopalan et al.
2011/0314130	A1	12/2011	Strasman	2013/0152767	A1	6/2013	Katz et al.
2011/0314176	A1	12/2011	Frojdth et al.	2013/0159633	A1	6/2013	Lilly
2011/0314500	A1	12/2011	Gordon et al.	2013/0166580	A1	6/2013	Maharajh
2012/0005312	A1	1/2012	Mcgowan et al.	2013/0166765	A1	6/2013	Kaufman
2012/0005368	A1*	1/2012	Knittle 709/235	2013/0166906	A1	6/2013	Swaminathan et al.
2012/0017282	A1	1/2012	Kang et al.	2013/0170561	A1	7/2013	Hannuksela
2012/0023251	A1	1/2012	Pyle et al.	2013/0170764	A1	7/2013	Carmel et al.
2012/0036365	A1	2/2012	Kyslov et al.	2013/0173513	A1	7/2013	Chu et al.
				2013/0179199	A1	7/2013	Ziskind et al.
				2013/0179589	A1	7/2013	McCarthy et al.
				2013/0179992	A1	7/2013	Ziskind et al.
				2013/0182952	A1	7/2013	Carmel et al.

(56)

References Cited

U.S. PATENT DOCUMENTS

2013/0196292 A1 8/2013 Brennen et al.
 2013/0212228 A1 8/2013 Butler et al.
 2013/0223812 A1 8/2013 Rossi
 2013/0226578 A1 8/2013 Bolton et al.
 2013/0226635 A1 8/2013 Fisher
 2013/0227081 A1 8/2013 Luby et al.
 2013/0227111 A1 8/2013 Wright et al.
 2013/0227122 A1 8/2013 Gao et al.
 2013/0297602 A1 11/2013 Soroushian et al.
 2013/0301424 A1 11/2013 Kotecha et al.
 2013/0311670 A1 11/2013 Tarbox et al.
 2013/0329781 A1 12/2013 Su et al.
 2014/0003516 A1 1/2014 Soroushian
 2014/0019592 A1 1/2014 Arana et al.
 2014/0019593 A1 1/2014 Reznik et al.
 2014/0037620 A1 2/2014 Ferree et al.
 2014/0052823 A1 2/2014 Gavade et al.
 2014/0059156 A1 2/2014 Freeman, II et al.
 2014/0096171 A1 4/2014 Shivadas et al.
 2014/0096269 A1 4/2014 Amidei et al.
 2014/0101722 A1 4/2014 Moore
 2014/0114951 A1 4/2014 Sasaki et al.
 2014/0115650 A1 4/2014 Zhang et al.
 2014/0119432 A1 5/2014 Wang et al.
 2014/0140253 A1 5/2014 Lohmar et al.
 2014/0140396 A1 5/2014 Wang et al.
 2014/0140417 A1* 5/2014 Shaffer et al. 375/240.28
 2014/0143301 A1 5/2014 Watson et al.
 2014/0143431 A1 5/2014 Watson et al.
 2014/0143440 A1* 5/2014 Ramamurthy et al. 709/231
 2014/0149557 A1 5/2014 Lohmar et al.
 2014/0177734 A1 6/2014 Carmel et al.
 2014/0189065 A1 7/2014 Schaar et al.
 2014/0201382 A1 7/2014 Shivadas et al.
 2014/0211840 A1 7/2014 Butt et al.
 2014/0211859 A1 7/2014 Carmel et al.
 2014/0241420 A1 8/2014 Orton-jay et al.
 2014/0241421 A1 8/2014 Orton-jay et al.
 2014/0247869 A1 9/2014 Su et al.
 2014/0250473 A1 9/2014 Braness et al.
 2014/0258714 A1 9/2014 Grab
 2014/0269927 A1 9/2014 Naletov et al.
 2014/0269936 A1 9/2014 Shivadas et al.
 2014/0280763 A1 9/2014 Grab et al.
 2014/0297804 A1 10/2014 Shivadas et al.
 2014/0297881 A1 10/2014 Shivadas et al.
 2014/0355668 A1 12/2014 Shoham et al.
 2014/0359678 A1 12/2014 Shivadas et al.
 2014/0359679 A1 12/2014 Shivadas et al.
 2014/0359680 A1 12/2014 Shivadas et al.
 2014/0376720 A1 12/2014 Chan et al.
 2015/0006662 A1 1/2015 Braness
 2015/0019550 A1 1/2015 Maharajh et al.
 2015/0026677 A1 1/2015 Stevens et al.
 2015/0043554 A1 2/2015 Meylan et al.
 2015/0049957 A1 2/2015 Shoham et al.
 2015/0063693 A1 3/2015 Carmel et al.
 2015/0067715 A1 3/2015 Koat et al.
 2015/0104153 A1 4/2015 Braness et al.
 2015/0117836 A1 4/2015 Amidei et al.
 2015/0117837 A1 4/2015 Amidei et al.
 2015/0139419 A1 5/2015 Kiefer et al.
 2015/0188758 A1 7/2015 Amidei et al.
 2015/0188842 A1 7/2015 Amidei et al.
 2015/0188921 A1 7/2015 Amidei et al.
 2015/0189017 A1 7/2015 Amidei et al.
 2015/0189373 A1 7/2015 Amidei et al.
 2015/0281310 A1 10/2015 Ziskind et al.
 2015/0288530 A1 10/2015 Oyman
 2015/0288996 A1 10/2015 Van Der Schaar et al.
 2015/0334435 A1 11/2015 Shivadas et al.
 2015/0373421 A1 12/2015 Chan et al.
 2016/0048593 A1 2/2016 Soroushian et al.
 2016/0070890 A1 3/2016 Grab et al.
 2016/0112382 A1 4/2016 Kiefer et al.

2016/0149981 A1 5/2016 Shivadas et al.
 2016/0219303 A1 7/2016 Braness et al.
 2016/0323342 A1 11/2016 Luby et al.
 2017/0011055 A1 1/2017 Pitts
 2017/0083474 A1 3/2017 Meswani et al.
 2017/0214947 A1 7/2017 Kiefer et al.
 2017/0223389 A1 8/2017 Soroushian et al.
 2017/0238030 A1 8/2017 Ziskind et al.
 2017/0280203 A1 9/2017 Chan et al.
 2018/0007451 A1 1/2018 Shivadas et al.
 2018/0046949 A1 2/2018 Kahn et al.
 2018/0060543 A1 3/2018 Grab et al.
 2018/0081548 A1 3/2018 Barzik et al.
 2018/0131980 A1 5/2018 Van Der Schaar et al.
 2018/0220153 A1 8/2018 Braness et al.
 2018/0255366 A1 9/2018 Lockett et al.
 2018/0262757 A1 9/2018 Naletov et al.
 2018/0285261 A1 10/2018 Mandal et al.
 2018/0332094 A1 11/2018 Braness
 2019/0020907 A1 1/2019 Kiefer et al.
 2019/0020928 A1 1/2019 Chan et al.
 2019/0045219 A1 2/2019 Braness et al.
 2019/0045220 A1 2/2019 Braness et al.
 2019/0045234 A1 2/2019 Kiefer et al.
 2019/0158553 A1 5/2019 Van Der Schaar et al.
 2019/0268596 A1 8/2019 Naletov et al.
 2019/0297364 A1 9/2019 van der Schaar et al.
 2019/0342587 A1 11/2019 Kiefer et al.
 2019/0356928 A1 11/2019 Braness et al.
 2020/0059706 A1 2/2020 Shivadas et al.
 2020/0396454 A1 12/2020 Naletov et al.
 2021/0076082 A1 3/2021 Kiefer et al.
 2021/0099504 A1 4/2021 Van Der Schaar et al.
 2021/0136429 A1 5/2021 Van Der Schaar et al.
 2021/0250608 A1 8/2021 Braness et al.

FOREIGN PATENT DOCUMENTS

CA 2749170 A1 7/2010
 CA 2749170 C 6/2016
 CA 2823829 C 1/2019
 CN 1169229 12/1997
 CN 1221284 A 6/1999
 CN 1235473 A 11/1999
 CN 1629939 A 6/2005
 CN 1723696 1/2006
 CN 101252401 A 8/2008
 CN 102549557 A 7/2012
 CN 102549557 B 9/2015
 CN 105072454 A 11/2015
 CN 105072454 B 4/2019
 EP 757484 A2 2/1997
 EP 813167 A2 12/1997
 EP 0818111 A1 1/1998
 EP 0936812 A1 8/1999
 EP 0818111 B1 1/2000
 EP 1056273 A2 11/2000
 EP 1158799 A1 11/2001
 EP 1187483 A2 3/2002
 EP 1420580 A1 5/2004
 EP 1453319 A1 9/2004
 EP 1536646 A1 6/2005
 EP 1553779 A1 7/2005
 EP 1657835 A1 5/2006
 EP 1283640 B1 10/2006
 EP 1718074 A1 11/2006
 EP 2180664 A1 4/2010
 EP 2360923 A1 8/2011
 EP 2384475 A1 11/2011
 EP 2486517 A1 8/2012
 EP 2486727 A1 8/2012
 EP 2507995 A1 10/2012
 EP 2564354 A1 3/2013
 EP 2616991 7/2013
 EP 2616991 A2 7/2013
 EP 2617192 7/2013
 EP 2617192 A2 7/2013
 EP 2661696 A1 11/2013
 EP 2661875 A1 11/2013

(56)

References Cited

FOREIGN PATENT DOCUMENTS

EP	2661895	A2	11/2013	JP	6078574	B2	2/2017
EP	2486727	A4	3/2014	JP	2017063453		3/2017
EP	2564354	A4	3/2014	JP	2018160923	A	10/2018
EP	2616991	A4	3/2014	JP	6453291	B2	1/2019
EP	2617192	A4	3/2014	JP	6657313	B2	2/2020
EP	2716048	A1	4/2014	JP	202080551	A	5/2020
EP	2721826	A1	4/2014	JP	2021158694	A	10/2021
EP	2486517		6/2014	JP	7000475	B2	12/2021
EP	2486517	A4	6/2014	KR	100221423	B1	9/1999
EP	2751990		7/2014	KR	2002013664		2/2002
EP	2751990	A1	7/2014	KR	1020020064888	A	8/2002
EP	2807821		12/2014	KR	20040039852	A	5/2004
EP	2807821	A2	12/2014	KR	20060030164	A	4/2006
EP	2751990	A4	4/2015	KR	20060106250	A	10/2006
EP	2661875	B1	11/2019	KR	20060116967	A	11/2006
EP	2661696	B1	5/2020	KR	100669616	B1	1/2007
EP	3697096	A1	8/2020	KR	20070005699	A	1/2007
EP	3700219	A1	8/2020	KR	20070020727	A	2/2007
EP	3742740	A1	11/2020	KR	20090016282	A	2/2009
EP	3975574	A1	3/2022	KR	20100106418	A	10/2010
EP	3742740	B1	5/2022	KR	20110133024	A	12/2011
FR	2360923		8/2011	KR	1020130133830		12/2013
GB	2398210	A	8/2004	KR	101635876	B1	7/2016
HK	1125765	A	8/2009	KR	101874907	B1	7/2018
JP	08046902	A	2/1996	KR	101917763	B1	11/2018
JP	08111842	A	4/1996	KR	10-1988877	B1	6/2019
JP	08163488	A	6/1996	KR	10-2072839		1/2020
JP	08287613	A	11/1996	KR	10-2122189	B1	6/2020
JP	09037225	A	2/1997	KR	10-2195414	B1	12/2020
JP	H1175178	A	3/1999	KR	102191317	B1	12/2020
JP	11164307	A	6/1999	KR	10-2274290	B1	7/2021
JP	11275576	A	10/1999	KR	10-2352043	B1	1/2022
JP	11328929	A	11/1999	KR	102408120	B1	6/2022
JP	2000201343	A	7/2000	KR	102445689	B1	9/2022
JP	2001043668	A	2/2001	MX	2011007344	A	2/2012
JP	2001209726	A	8/2001	MX	316584	B	12/2013
JP	2001346165	A	12/2001	RU	2328040	C2	6/2008
JP	2002164880	A	6/2002	SG	146026		12/2010
JP	2002170363	A	6/2002	WO	1995015660	A1	6/1995
JP	2002518898	A	6/2002	WO	1996013121		5/1996
JP	2002218384	A	8/2002	WO	199800973	A1	1/1998
JP	2003179597	A	6/2003	WO	9731445	A3	4/1998
JP	2003250113	A	9/2003	WO	1997031445	A3	4/1998
JP	2004013823	A	1/2004	WO	199834405	A1	8/1998
JP	2004515941	A	5/2004	WO	1998047290		10/1998
JP	2004172830	A	6/2004	WO	9910836	A1	3/1999
JP	2004187161	A	7/2004	WO	1999010836	A1	3/1999
JP	2004234128	A	8/2004	WO	1999065239	A2	12/1999
JP	2004304767	A	10/2004	WO	2000049762	A2	8/2000
JP	2004328218	A	11/2004	WO	2000049763	A1	8/2000
JP	2005027153		1/2005	WO	0104892	A1	1/2001
JP	2005504480	A	2/2005	WO	2001031497	A1	5/2001
JP	2005080204	A	3/2005	WO	2001050732	A2	7/2001
JP	2005173241	A	6/2005	WO	2001065762	A2	9/2001
JP	2005284041	A	10/2005	WO	2002001880	A1	1/2002
JP	2005286881	A	10/2005	WO	2002008948	A2	1/2002
JP	2006155500	A	6/2006	WO	200223315	A2	3/2002
JP	2006521035	A	9/2006	WO	2003028293		4/2002
JP	2006524007	A	10/2006	WO	2002035832	A2	5/2002
JP	2007036666	A	2/2007	WO	2002037210	A2	5/2002
JP	2007174375	A	7/2007	WO	2002054196	A2	7/2002
JP	2007235690	A	9/2007	WO	2002054776		7/2002
JP	2007535881	A	12/2007	WO	2002073437	A1	9/2002
JP	2008235999	A	10/2008	WO	2002087241	A1	10/2002
JP	2009522887	A	6/2009	WO	2003030000	A1	4/2003
JP	2009530917	A	8/2009	WO	2003046750	A1	6/2003
JP	4516082	B2	5/2010	WO	2003047262	A2	6/2003
JP	2012514951	A	6/2012	WO	2003061173	A2	7/2003
JP	2013513298	A	4/2013	WO	2003096136	A2	11/2003
JP	5200204	B2	6/2013	WO	2004012378	A2	2/2004
JP	2014506430	A	3/2014	WO	2004054247	A1	6/2004
JP	5681641		1/2015	WO	2004097811	A1	11/2004
JP	5723888	B2	5/2015	WO	2004100158	A1	11/2004
JP	2015167357	A	9/2015	WO	2004102571	A1	11/2004
JP	6038805	B2	12/2016	WO	2005008385	A2	1/2005
				WO	2005015935	A1	2/2005
				WO	2005050373	A2	6/2005
				WO	2005057906	A2	6/2005
				WO	2005109224	A2	11/2005

(56)

References Cited

FOREIGN PATENT DOCUMENTS

WO	2005125214	A2	12/2005
WO	2006018843	A2	2/2006
WO	20060012398	A2	2/2006
WO	2006018843	A3	12/2006
WO	2007044590	A2	4/2007
WO	2007072257	A1	6/2007
WO	2007073347	A1	6/2007
WO	2007093923	A1	8/2007
WO	2007101182	A2	9/2007
WO	2007113836	A2	10/2007
WO	2008010275	A1	1/2008
WO	2008032908	A1	3/2008
WO	2008042242	A2	4/2008
WO	2008086313	A1	7/2008
WO	2008090859	A1	7/2008
WO	2007113836	A3	11/2008
WO	2008135932	A2	11/2008
WO	2007113836	B1	12/2008
WO	2009006302	A1	1/2009
WO	2009065137	A1	5/2009
WO	2009070770	A1	6/2009
WO	2009109976	A2	9/2009
WO	2010005673		1/2010
WO	2010060106	A1	5/2010
WO	2010080911	A1	7/2010
WO	2010089962	A1	8/2010
WO	2010108053	A1	9/2010
WO	2010111261	A1	9/2010
WO	2010122447	A1	10/2010
WO	2010147878	A1	12/2010
WO	2011042898	A1	4/2011
WO	2011042900	A1	4/2011
WO	2011068668	A1	6/2011
WO	2011086190	A1	7/2011
WO	2011087449	A1	7/2011
WO	2011101371	A1	8/2011
WO	2011103364	A1	8/2011
WO	2011132184	A1	10/2011
WO	2011135558	A1	11/2011
WO	2012035533	A2	3/2012
WO	2012035534	A2	3/2012
WO	2012035534	A3	7/2012
WO	2012094171	A1	7/2012
WO	2012094181	A2	7/2012
WO	2012094189	A1	7/2012
WO	20120094181	A2	7/2012
WO	20120094189	A1	7/2012
WO	2012035533	A3	8/2012
WO	2012162806	A1	12/2012
WO	2012171113	A1	12/2012
WO	2013030833	A1	3/2013
WO	2013032518	A2	3/2013
WO	2013103986	A2	7/2013
WO	2013111126	A2	8/2013
WO	2013111126	A3	8/2013
WO	2013032518	A3	9/2013
WO	2013144942	A1	10/2013
WO	2014145901	A1	9/2014
WO	2014193996	A2	12/2014
WO	2014193996	A3	2/2015
WO	2015031982	A1	3/2015
WO	2013111126	A3	6/2015

OTHER PUBLICATIONS

Chinese Patent Application 201180060590.1 office action dated Aug. 6, 2015, 11 pgs.
 Examination report for GB1308663.2, dated May 18, 2016, 3 pgs.
 Extended European Search Report for European Application No. 21208230.9, Search completed Feb. 18, 2022, dated Mar. 1, 2022, 15 Pgs.
 Filed Application and Filing Receipt for U.S. Appl. No. 61/359,748, Application filed Jun. 29, 2010, Receipt mailed Jul. 13, 2010, 38 pages.

Great Britain Application GB1308663.2 search report dated Jan. 5, 2017, 1 pg.
 ISO/IEC 14496-12 Information technology—Coding of audio-visual objects—Part 12: ISO base media file format, Amendment 3: DASH support and RTP reception hint track processing, 2011, 44 pgs.
 ISO/IEC CD 23001-6 MPEG systems technologies Part 6: Dynamic adaptive streaming over HTTP (DASH), Oct. 15, 2010, 70 pgs.
 ISO/IEC DIS 23009-1, Information technology—Dynamic adaptive streaming over HTTP (DASH)—Part 1: Media presentation description and segment formats, dated Aug. 30, 2011, 132 pgs.
 ISO/IEC JTC1/SC29/WG11, MPEG/M18620, Oct. 2010, Text of ISO/IEC 23001-6: Dynamic adaptive streaming over http (DASH), 72 pgs.
 ISO/IEC JTC1/SC29/WG11, MPEG/N11578, Text of ISO/IEC 23001-6: Dynamic adaptive streaming over HTTP (DASH), Oct. 2010, 70 pgs.
 ISO/IEC JTC1/SC29-WG11—Coding of Moving Pictures and Audio, MPEG2010/M18692, Jan. 2010, 10 pgs.
 Search Report for Canadian patent application 2,816,621, dated Oct. 30, 2014, 6 pgs.
 Search report for European Patent Application 11838186.2, dated Jul. 13, 2017, 6 pgs.
 “Pixel aspect ratio—Wikipedia”, Nov. 24, 2010, pp. 1-8.
 Hunt, “Encoding for streaming”, The Netflix Blog, Nov. 6, 2008, printed from <https://web.archive.org/web/20081216044437/http://blog.netflix.com/2008/11/encoding-for-streaming.htm>, retrieved on Feb. 8, 2022, 28 pgs.
 Pereira, “Security on Over the Top TV Services”, Thesis, Nov. 2011, 114 pgs.
 Stockhammer, “MPEG’s Dynamic Adaptive Streaming over HTTP (DASH)—An Enabling Standard for Internet TV”, Qualcomm Incorporated, Apr. 11, 2015, Retrieved from the Internet, <https://www.w3.org/2011/09/webtv/slides/W3C-Workshop.pdf>, 30 pgs.
 “IBM Closes Cryptolopes Unit,” Dec. 17, 1997, CNET News, Printed on Apr. 25, 2014 from http://news.cnet.com/IBM-closes-Cryptolopes-unit/2100-1001_3206465.html, 3 pages.
 Written Opinion for International Application No. PCT/US2007/063950 filed Mar. 14, 2007, report completed Mar. 1, 2008; report dated Mar. 19, 2008, 6 pgs.
 U.S. Appl. No. 13/905,804, “Notice of Allowance,” dated Aug. 12, 2015, 8 pgs.
 Broadq—The Ultimate Home Entertainment Software, printed May 11, 2009 from <http://web.archive.org/web/20030401122010/www.broadq.com/qcasttuner/>, 1 pg.
 Cloakware Corporation, “Protecting Digital Content Using Cloakware Code Transformation Technology”, Version 1.2, May 2002, pp. 1-10.
 EP11774529 Supplementary European Search Report, completed Jan. 31, 2014, 2 pgs.
 European Search Report Application No. EP 08870152, Search Completed May 19, 2011, dated May 26, 2011, 9 pgs.
 European Supplementary Search Report for Application EP09759600, completed Jan. 25, 2011, 11 pgs.
 Extended European Search Report for European Application EP10821672, completed Jan. 30, 2014, 3 pgs.
 Extended European Search Report for European Application EP11824682, completed Feb. 6, 2014, 4 pgs.
 Extended European Search Report for European Application No. 14763140.2, Search completed Sep. 26, 2016, dated Oct. 5, 2016, 9 Pgs.
 Extended European Search Report for European Application No. 20172313.7 Search completed Aug. 19, 2020 dated Aug. 27, 2020, 11 Pgs.
 Final draft ETSI ES 202 109, V1.1.1, ETSI Standard, Terrestrial Trunked Radio (TETRA); Security; Synchronization mechanism for end-to-end encryption, Oct. 2002, 17 pgs.
 IBM Corporation and Microsoft Corporation, “Multimedia Programming Interface and Data Specifications 1.0”, Aug. 1991, printed from <http://www.kk.ij4u.or.jp/~kondo/wave/mpidata.txt> on Mar. 6, 2006, 100 pgs.

(56)

References Cited

OTHER PUBLICATIONS

Information Technology—MPEG Systems Technologies—Part 7: Common Encryption in ISO Base Media File Format Files (ISO/IEC 23001-7), Apr. 2015, 24 pgs.

InformationWeek, “Internet on Wheels”, InformationWeek: Front End: Daily Dose, Jul. 20, 1999, Printed on Mar. 26, 2014, 3 pgs.

International Preliminary Report for Application No. PCT/US2011/066927, Filed Dec. 22, 2011, Report dated Jul. 10, 2013, 13 pgs.

International Preliminary Report for International Application No. PCT/US2011/067243, International Filing Date Dec. 23, 2011, dated Jul. 10, 2013, 7 pgs.

International Preliminary Report on Patentability for International Application PCT/US14/30747, Report dated Sep. 15, 2015, dated Sep. 24, 2015, 6 Pgs.

International Preliminary Report on Patentability for International Application No. PCT/US2007/063950, Report Completed Dec. 18, 2009, 3 pgs.

International Preliminary Report on Patentability for International Application No. PCT/US2008/083816, dated May 18, 2010, 6 pgs.

International Preliminary Report on Patentability for International Application No. PCT/US2010/56733, dated Jun. 5, 2012, 5 pgs.

International Preliminary Report on Patentability for International Application No. PCT/US2011/068276, dated Mar. 4, 2014, 23 pgs.

International Preliminary Report on Patentability for International Application PCT/US2011/067167, dated Feb. 25, 2014, 8 pgs.

International Preliminary Report on Patentability for International Application PCT/US2013/043181, dated Dec. 31, 2014, dated Jan. 8, 2015, 11 Pgs.

International Preliminary Report on Patentability for International Application PCT/US2014/039852, dated Dec. 1, 2015, dated Dec. 5, 2015, 8 Pgs.

International Search Report and Written Opinion for International Application No. PCT/US07/63950, completed Feb. 19, 2008; dated Mar. 19, 2008, 9 pgs.

International Search Report and Written Opinion for International Application No. PCT/US08/87999, completed Feb. 7, 2009, dated Mar. 19, 2009, 6 pgs.

International Search Report and Written Opinion for International Application No. PCT/US09/46588, completed Jul. 13, 2009, dated Jul. 23, 2009, 7 pgs.

International Search Report and Written Opinion for International Application No. PCT/US2004/041667, completed May 24, 2007, dated Jun. 20, 2007, 6 pgs.

International Search Report and Written Opinion for International Application No. PCT/US2005/025845, completed Feb. 5, 2007 and dated May 10, 2007, 8 pgs.

International Search Report and Written Opinion for International Application No. PCT/US2008/083816, completed Jan. 10, 2009, dated Jan. 22, 2009, 7 pgs.

International Search Report and Written Opinion for International Application No. PCT/US2010/020372, Completed Feb. 10, 2009, dated Mar. 1, 2010, 8 pgs.

International Search Report and Written Opinion for International Application No. PCT/US2010/56733, Completed Jan. 3, 2011, dated Jan. 14, 2011, 9 pgs.

International Search Report and Written Opinion for International Application No. PCT/US2011/067243, International Filing Date Dec. 23, 2011, Search Completed Apr. 24, 2012, dated May 8, 2012, 8 pgs.

International Search Report and Written Opinion for International Application No. PCT/US2013/043181, completed Nov. 27, 2013, dated Dec. 6, 2013, 12 pgs.

International Search Report and Written Opinion for International Application PCT/US14/30747, completed Jul. 30, 2014, dated Aug. 22, 2014, 7 Pgs.

International Search Report and Written Opinion for International Application PCT/US14/39852, completed Oct. 21, 2014, dated Dec. 5, 2014, 11 pgs.

International Search Report and Written Opinion for International Application PCT/US2011/066927, completed Apr. 3, 2012, dated Apr. 20, 2012, 14 pgs.

International Search Report and Written Opinion for International Application PCT/US2011/067167, completed Jun. 19, 2012, dated Jul. 2, 2012, 11 pgs.

International Search Report and Written Opinion for International Application PCT/US2011/068276, completed Jun. 19, 2013, dated Jul. 8, 2013, 24 pgs.

International Search Report and Written Opinion for PCT/US2013/020572, International Filing Date Jan. 7, 2013, Search Completed Mar. 19, 2013, dated Apr. 29, 2013, 10 pgs.

International Telecommunication Union, Telecommunication Standardization Sector of ITU, H.233, Line Transmission of Non-Telephone Signals, Confidentiality System for Audiovisual Services, ITU-T Recommendation H.233, Mar. 1993, 18 pgs.

ISO/IEC 14496-12 Information technology—Coding of audiovisual objects—Part 12: ISO base media file format, Feb. 2004 (“MPEG-4 Part 12 Standard”), 62 pgs.

ISO/IEC 14496-12:2008(E) Informational Technology—Coding of Audio-Visual Objects Part 12: ISO Base Media File Format, Oct. 2008, 120 pgs.

ISO/IEC FCD 23001-6 MPEG systems technologies Part 6: Dynamic adaptive streaming over HTTP (DASH), Jan. 28, 2011, 86 pgs.

ITS International, “Fleet System Opts for Mobile Server”, Aug. 26, 1999, Printed on Oct. 21, 2011 from <http://www.itsinternational.com/News/article.cfm?recordID=547>, 2 pgs.

Lifehacker—Boxqueue Bookmarklet Saves Videos for Later Boxee Watching, printed Jun. 16, 2009 from <http://feeds.gawker.com/~r/lifehacker/full/~3/OHvDmrlgZZc/boxqueue-bookmarklet-saves-videos-for-late-boxee-watching>, 2 pgs.

Linksys Wireless-B Media Adapter Reviews, printed May 4, 2007 from http://reviews.cnet.com/Linksys_Wireless_B_Media_Adapter/4505-6739_7-30421900.html?tag=box, 5 pgs.

Linksys, Kiss DP-500, printed May 4, 2007 from <http://www.kiss-technology.com/?p=dp500>, 2 pgs.

Linksys®: “Enjoy your digital music and pictures on your home entertainment center, without stringing wires!”, Model No. WMA 11B, printed May 9, 2007 from http://www.linksys.com/servlet/Satellite?c=L_Product_C2&childpagename=US/Layout&cid=1115416830950&p.

Microsoft Corporation, “Chapter 8, Multimedia File Formats” 1991, Microsoft Windows Multimedia Programmer’s Reference, 3 cover pgs, pp. 8-1 to 8-20.

Microsoft Corporation, Advanced Systems Format (ASF) Specification, Revision 01.20.03, Dec. 2004, 121 pgs.

Microsoft Media Platform: Player Framework, “Microsoft Media Platform: Player Framework v2.5 (formerly Silverlight Media Framework)”, May 3, 2011, 2 pages.

Microsoft Media Platform: Player Framework, “Silverlight Media Framework v1.1”, Jan. 2010, 2 pages.

Microsoft Windows® XP Media Center Edition 2005, Frequently asked Questions, printed May 4, 2007 from <http://www.microsoft.com/windowsxp/mediacenter/evaluation/faq.mspx>.

Microsoft Windows® XP Media Center Edition 2005: Features, printed May 9, 2007, from <http://www.microsoft.com/windowsxp/mediacenter/evaluation/features.mspx>, 4 pgs.

MPEG-DASH presentation at Streaming Media West 2011, Nov. 2011, 14 pgs.

Office Action for Chinese Patent Application No. CN200880127596.4, dated May 6, 2014, 8 pgs.

Office Action for U.S. Appl. No. 13/223,210, dated Apr. 30, 2015, 14 pgs.

Office Action for U.S. Appl. No. 14/564,003, dated Apr. 17, 2015, 28 pgs.

Open DML AVI-M-JPEG File Format Subcommittee, “Open DML AVI File Format Extensions”, Version 1.02, Feb. 28, 1996, 29 pgs.

PC world.com, Future Gear: PC on the HiFi, and the TV, from <http://www.pcworld.com/article/id,108818-page,1/article.html>, printed May 4, 2007, from IDG Networks, 2 pgs.

Pomelo, LLC Tech Memo, Analysis of Netflix’s Security Framework for ‘Watch Instantly’ Service, March-Apr. 2009, 18 pgs.

(56)

References Cited

OTHER PUBLICATIONS

Qtv—About BroadQ, printed May 11, 2009 from <http://www.broadq.com/en/about.php>, 1 pg.

Server-Side Stream Repackaging (Streaming Video Technologies Panorama, Part 2), Jul. 2011, 15 pgs.

Supplementary European Search Report for Application No. EP 04813918, Search Completed Dec. 19, 2012, 3 pgs.

Supplementary European Search Report for Application No. EP 10729513, completed Dec. 9, 2013, 4 pgs.

Supplementary European Search Report for EP Application 11774529, completed Jan. 31, 2014, 2 pgs.

Supplementary European Search Report for European Application No. 07758499.3, Report Completed Jan. 25, 2013, 8 pgs.

Text of ISO/IEC 23001-6: Dynamic adaptive streaming over HTTP (DASH), Oct. 2010, 71 pgs.

Universal Mobile Telecommunications System (UMTS), ETSI TS 126 233 V9.1.0 (Jun. 2011) 3GPP TS 26.233 version 9.1.0 Release 9, 18 pgs.

Universal Mobile Telecommunications Systems (UMTS); ETSI TS 126 244 V9.4.0 (May 2011) 3GPP TS 26.244 version 9.4.0 Release 9, 58 pgs.

Windows Media Center Extender for Xbox, printed May 9, 2007 from <http://www.xbox.com/en-US/support/systemuse/xbox/console/mediacenterextender.htm>, 2 pgs.

Windows® XP Media Center Edition 2005, “Experience more entertainment”, retrieved from <http://download.microsoft.com/download/c/9/a/c9a7000a-66b3-455b-860b-1c16f2eefec/MCE.pdf> on May 9, 2007, 2 pgs.

3GPP TS 26.247, V1.3.0, 3rd Generation Partnership Project; Technical Specification Group Services and System Aspects Transparent end-to-end Packet-switches Streaming Services (PSS); Progressive Download and Dynamic Adaptive Streaming over http (3GP-DASH) (Release 10), Mar. 2011, 72 pgs.

Written Opinion for International Application No. PCT/US2008/083816, Opinion completed Jan. 10, 2009, dated Jan. 22, 2009, 5 pgs.

Written Opinion for International Application No. PCT/US2009/046588, completed Jul. 14, 2009, dated Jul. 23, 2009, 5 pgs.

Written Opinion of the International Searching Authority for International Application No. PCT/US 08/87999, date completed Feb. 7, 2009, dated Mar. 19, 2009, 4 pgs.

International Search Report and Written Opinion for International Application PCT/US2010/020372, Search Report dated Mar. 1, 2010, 7 pgs.

Written Opinion for International Application No. PT/US2005/025845 filed Jul. 21, 2005, report completed Feb. 5, 2007 and dated May 10, 2007, 5 pgs.

Written Opinion for International Application No. PCT/US2004/041667, Filing Date Dec. 8, 2004, Report Completed May 24, 2007, dated Jun. 20, 2007, 4 pgs.

Written Opinion for International Application No. PCT/US2005/025845, completed Feb. 5, 2007 and dated May 10, 2007, 6 pgs.

Innovation of technology arrived, I-O Data, Nov. 2004, Retrieved from http://www.iodata.com/catalogs/AVLP2DVDLA_Flyer200505.pdf on May 30, 2013, 2 pgs., I-O Data, 2 pgs.

“Adaptive Streaming Comparison”, Jan. 28, 2010, 5 pgs.

“Adobe Flash Video File Format Specification”, Aug. 2010, Version 10.1, 89 pages.

“Apple HTTP Live Streaming specification”, Aug. 2017, 60 pgs.

“Best Practices for Multi-Device Transcoding”, Kaltura Open Source Video, Printed on Nov. 27, 2013 from knowledge.kaltura.com/best-practices-multi-device-transcoding, 13 pgs.

“Container format (digital)”, printed Aug. 22, 2009 from [http://en.wikipedia.org/wiki/Container_format_\(digital\)](http://en.wikipedia.org/wiki/Container_format_(digital)), 4 pgs.

“Data Encryption Decryption using AES Algorithm, Key and Salt with Java Cryptography Extension”, Available at <https://www.digizol.com/2009/10/java-encrypt-decrypt-jce-salt.html>, Oct. 2009, 6 pgs.

“Delivering Live and On-Demand Smooth Streaming”, Microsoft Silverlight, 2009, 28 pgs.

“Diagram | Matroska”, Dec. 17, 2010, Retrieved from <http://web.archive.org/web/20101217114656/http://matroska.org/technical/diagram/index.html> on Jan. 29, 2016, 5 pages, Dec. 17, 2010.

“Draft CR: Trick Mode for HTTP Streaming”, 3GPP TSG-SA4 Meeting #58, Apr. 26-30, 2010, Vancouver, Canada, S4-100237, 3 pgs.

“DVD—MPeg differences”, printed Jul. 2, 2009 from <http://dvd.sourceforge.net/dvinfo/dvdmpeg.html>, 1 pg.

“DVD subtitles”, sam.zoy.org/writings/dvd/subtitles, dated Jan. 9, 2001, printed Jul. 2, 2009, 4 pgs.

“Final Committee Draft of MPEG-4 streaming text format”, International Organisation for Standardisation, Feb. 2004, 22 pgs.

“HTTP Based Adaptive Streaming over HSPA”, Apr. 2011, 73 pgs.

“HTTP Live Streaming”, Mar. 2011, 24 pgs.

“HTTP Live Streaming”, Sep. 2011, 33 pgs.

“IBM Spearheading Intellectual Property Protection Technology for Information on the Internet; Cryptolope Containers Have Arrived”, May 1, 1996, Business Wire, Printed on Aug. 1, 2014 from <http://www.thefreelibrary.com/IBM+Spearheading+Intellectual+Property+Protection+Technology+for...-a018239381>, 6pg.

“Information Technology—Coding of audio-visual objects—Part 14: MP4 file format”, International Standard, ISO/IEC 14496-14, First Edition, Nov. 15, 2003, 18 pages.

“Information Technology—Coding of audio-visual objects—Part 17: Streaming text”, International Organisation for Standardisation, Feb. 2004, 22 pgs.

“Information technology—Coding of audio-visual objects—Part 18: Font compression and streaming”, ISO/IEC 14496-18, First edition Jul. 1, 2004, 26 pgs.

“Information technology—Generic coding of moving pictures and associated audio information: Systems”, International Standard ISO/IEC 13818-1, Second Edition, Dec. 1, 2000, 174 pages (presented in two parts).

“Information Technology—Coding of Audio Visual Objects—Part 2: Visual”, International Standard, ISO/IEC 14496-2, Third Edition, Jun. 1, 2004, pp. 1-724. (presented in three parts).

“Information-Technology—Generic coding of moving pictures and associated audio: Systems, Recommendation H.222.0”, International Standard, ISO/IEC 13818-1, Draft 1209, Apr. 25, 1995, 151 pages.

“Information-Technology—Generic coding of moving pictures and associated audio: Systems, Recommendation H.222.0”, International Standard, ISO/IEC 13818-1, Draft 1540, Nov. 13, 1994, 161 pages.

“Java Cryptography Architecture API Specification & Reference”, Available at <https://docs.oracle.com/javase/1.5.0/docs/guide/security/CryptoSpec.html>, Jul. 25, 2004, 68 pgs.

“Java Cryptography Extension, javax.crypto.Cipher class”, Available at <https://docs.oracle.com/javase/1.5.0/docs/api/javax/crypto/Cipher.html>, 2004, 24 pgs.

“JCE Encryption—Data Encryption Standard (DES) Tutorial”, Available at <https://mkyong.com/java/jce-encryption-data-encryption-standard-des-tutorial/>, Feb. 25, 2009, 2 pgs.

“Kiss Players, Kiss DP-500”, retrieved from <http://www.kiss-technology.com/?p=dp500> on May 4, 2007, 1 pg.

“Live and On-Demand Video with Silverlight and IIS Smooth Streaming”, Microsoft Silverlight, Windows Server Internet Information Services 7.0, Feb. 2010, 15 pgs.

“Matroska”, Wikipedia, Jul. 10, 2017, retrieved from <https://en.wikipedia.org/wiki/Matroska> on Jul. 20, 2017, 3 pages.

“Matroska Streaming | Matroska”, Retrieved from the Internet: URL:<http://web.archive.org/web/20101217114310/http://matroska.org/technical!streaming/index.html> [retrieved on Jan. 29, 2016], Dec. 17, 2010.

“Microsoft Smooth Streaming specification”, Jul. 22, 2013, 56 pgs.

“MovieLabs Specification for Next Generation Video—Version 1.0”, Motion Picture Laboratories, Inc., 2013, Retrieved from: <http://movielabs.com/ngvideo/MovieLabs%20Specification%20for%20Next%20Generation%20Video%20v1.0.pdf>, 5 pgs.

“MPEG-2”, Wikipedia, Jun. 13, 2017, retrieved from <https://en.wikipedia.org/wiki/MPEG-2> on Jul. 20, 2017, 13 pages.

“MPEG-4 File Format, Version 2”, Sustainability of Digital Formats: Planning for Library of Congress Collections, Retrieved from:

(56)

References Cited

OTHER PUBLICATIONS

<https://www.loc.gov/preservation/digital/formats/fdd/fdd000155.shtml>, Last updated Feb. 21, 2017, 8 pgs.

“MPEG-4 Part 14”, Wikipedia, Jul. 10, 2017, retrieved from https://en.wikipedia.org/wiki/MPEG-4_Part_14 on Jul. 20, 2017, 5 pages.

“Netflix turns on subtitles for PC, Mac streaming”, Yahoo! News, Apr. 21, 2010, Printed on Mar. 26, 2014, 3 pgs.

“OpenDML AVI File Format Extensions”, ** check for duplicate** OpenDML AVIM-JPEG File Format Subcommittee, retrieved from www.the-labs.com/Video/odmlff2-avidef.pdf, Sep. 1997, 42 pgs.

“OpenDML AVI File Format Extensions Version 1.02”, OpenDML AVI MJPEG File Format Subcommittee. Last revision: Feb. 28, 1996. Reformatting: Sep. 1997, 42 pgs.

“QCast Tuner for PS2”, printed May 11, 2009 from <http://web.archive.org/web/20030210120605/www.divx.com/software/detail.php?ie=39>, 2 pgs.

“Series H: Audiovisual and Multimedia Systems Infrastructure of audiovisual services—Coding of moving video; High efficiency video coding”, International Telecommunication Union, ITU-T H.265, Apr. 2015, 634 pages (presented in six parts).

“Single-Encode Streaming for Multiple Screen Delivery”, Telestream Wowza Media Systems, 2009, 6 pgs.

“Smooth Streaming Client”, The Official Microsoft IIS Site, Sep. 24, 2010, 4 pages.

“Specifications | Matroska”, Retrieved from the Internet: URL:<http://web.archive.org/web/20100706041303/http://1www.matroska.org/technical/specs/index.html> [retrieved on Jan. 29, 2016, Jul. 6, 2010].

“Specifications Matroska”, Dec. 17, 2010, [retrieved on Mar. 2, 2018], 12 pages.

“Supplementary European Search Report for Application No. EP 10834935, International Filing Date Nov. 15, 2010, Search Completed May 27, 2014, 9 pgs.”

“Supported Media Formats”, Supported Media Formats, Android Developers, Printed on Nov. 27, 2013 from developer.android.com/guide/appendix/media-formats.html, 3 pgs.

“SWF and FLV File Format Specification”, Adobe, Jun. 2007, Version 9, 298 pages.

“Text of ISO/IEC 14496-18/COR1, Font compression and streaming”, ITU Study Group 16—Video Coding Experts Group—ISO/IEC MPEG & ITU-T VCEG(ISO/IEC JTC1/SC29/WG11 and ITU-T SG16 06), No. N8664, Oct. 27, 2006, 8 pgs.

“Text of ISO/IEC 14496-18/FDIS, Coding of Moving Pictures and Audio”, ITU Study Group 16—Videocoding Experts Group—ISO/IEC MPEG & ITU-T VCEG(ISO/IEC JTC1/SC29/WG11 and ITU-T SG16 06), No. N6215, Dec. 2003, 26 pgs.

“The MPEG-DASH Standard for Multimedia Streaming Over the Internet”, IEEE MultiMedia, vol. 18, No. 4, 2011, 7 pgs.

“Thread: SSME (Smooth Streaming Media Element) config.xml review (Smooth Streaming Client configuration file)”, Printed on Mar. 26, 2014, 3 pgs.

“Transcoding Best Practices”, From movideo, Printed on Nov. 27, 2013 from code.movideo.com/Transcoding_Best_Practices, 5 pgs.

“Using HTTP Live Streaming”, iOS Developer Library, http://developer.apple.com/library/ios/#documentation/networkinginternet/conceptual/streamingmediaguide/UsingHTTPLiveStreaming/UsingHTTPLiveStreaming.html#//apple_ref/doc/uid/TP40008332-CH102-SW1, Feb. 11, 2014, 10 pgs.

“Video File Format Specification”, Adobe, Apr. 2008, Version 9, 46 pages.

“Video Manager and Video Title Set IFO file headers”, printed Aug. 22, 2009 from <http://dvd.sourceforge.net/dvdinfo/ifo.htm>, 6 pgs.

“What is a DVD?”, printed Aug. 22, 2009 from <http://www.videohelp.com/dvd>, 8 pgs.

“What is a VOB file”, <http://www.mpuCoder.com/DVD/vobov.html>, printed on Jul. 2, 2009, 2 pgs.

“What’s on a DVD?”, printed Aug. 22, 2009 from <http://www.doom9.org/dvd-structure.htm>, 5 pgs.

“Windows Media Player 9”, Microsoft, Mar. 23, 2017, 3 pgs.

“DVD-Mpeg differences”, printed on Jul. 2, 2009, <http://dvd.sourceforge.net/dvdinfo/dvdmpeg.html>, 1 pg.

Casares, Juan et al., “Simplifying Video Editing Using Metadata”. Long et al., “Silver: Simplifying Video Editing with Metadata”, CHI 2003: New Horizons, Apr. 5-10, 2003, pp. 628-629.

U.S. Appl. No. 13/224,298, “Final Office Action”, dated May 19, 2014, 26 pgs.

U.S. Appl. No. 13/905,804, “Non-Final Office Action Received”, U.S. Appl. No. 13/905,804, “Non-Final Office Action”, dated Jul. 25, 2014, 15 pgs.

Abomhara et al., “Enhancing Selective Encryption for H.264/AVC Using Advanced Encryption Standard”, International Journal of computer Theory and Engineering, Apr. 2010, vol. 2, No. 2, pp. 223-229.

Adams et al., “Will http adaptive streaming become the dominant mode of video delivery in cable networks?”, <https://www.nctatechnicalpapers.com/Paper/2011/2011-will-http-adaptive-streaming-become-the-dominant-mode-of-video-delivery-in-cable-networks->, 10 pgs.

Adhikari et al., “Unreeling Netflix: Understanding and Improving Multi-CDN Movie Delivery”, 2012 Proceedings IEEE InfoCom, Mar. 25-30, 2012, Orlando, Florida, 9 pgs.

Adzic et al., “Optimized Adaptive HTTP Streaming for Mobile Devices”, International Society for Optics and Photonics, Applications of Digital Image Processing XXXIV, vol. 8135, Sep. 2011, p. 81350T.

Akhshabi et al. “An Experimental Evaluation of Rate-Adaptation Algorithms in Adaptive Streaming over HTTP”, MMSys’11, Feb. 23-25, 2011, 12 pgs.

Alattar et al., A.M., “Improved selective encryption techniques for secure transmission of MPEG video bit-streams”, In Proceedings 1999 International Conference on Image Processing (Cat. 99CH36348), vol. 4, IEEE, 1999, pp. 256-260.

Anonymous, “Method for the encoding of a compressed video sequence derived from the same video sequence compressed at a different bit rate without loss of data”, ip.com, ip.com No. IPCOM000008165D, May 22, 2002, pp. 1-9.

Antoniou et al., “Adaptive Methods for the Transmission of Video Streams in Wireless Networks”, 2015, 50 pgs.

Apostolopoulos et al., “Secure Media Streaming and Secure Transcoding”, Multimedia Security Technologies for Digital Rights Management, 2006, 33 pgs.

Asai et al., “Essential Factors for Full-Interactive VOD Server: Video File System, Disk Scheduling, Network”, Proceedings of Globecom ’95, Nov. 14-16, 1995, 6 pgs.

Author Unknown, “Blu-ray Disc—Blu-ray Disc—Wikipedia, the free encyclopedia”, printed Oct. 30, 2008 from http://en.wikipedia.org/wiki/Blu-ray_Disc, 11 pgs.

Author Unknown, “Blu-ray Movie Bitrates Here—Blu-ray Forum”, printed Oct. 30, 2008 from <http://forum.blu-ray.com/showthread.php?t=3338>, 6 pgs.

Author Unknown, “MPEG-4 Video Encoder: Based on International Standard ISO/IEC 14496-2”, Patni Computer Systems, Ltd., printed Jan. 24, 2007, USA, pp. 1-15.

Author Unknown, “O’Reilly—802.11 Wireless Networks: The Definitive Guide, Second Edition”, printed Oct. 30, 2008 from <http://oreilly.com/catalog/9780596100520>, 2 pgs.

Author Unknown, “Turbo-Charge Your Internet and PC Performance”, printed Oct. 30, 2008 from Speedtest.net—The Global Broadband Speed Test, 1 pg.

Author Unknown, “White paper, The New Mainstream Wireless LAN Standard”, Broadcom Corporation, Jul. 2003, 12 pgs.

Beker et al., “Cipher Systems, The Protection of Communications”, 1982, 40 pgs.

Blasiak, “Video Transrating and Transcoding: Overview of Video Transrating and Transcoding Technologies”, Ingenient Technologies, TI Developer Conference, Aug. 6-8, 2002, 22 pgs.

Bloom et al., “Copy Protection for DVD Video”, Proceedings of the IEEE, vol. 87, No. 7, Jul. 1999, pp. 1267-1276.

Bocharov et al., “Portable Encoding of Audio-Video Objects, The Protected Interoperable File Format (PIFF)”, Microsoft Corporation, First Edition Sep. 8, 2009, 30 pgs.

Bross et al., “High Efficiency Video Coding (HEVC) text specification draft 10 (for FDIS & Last Call)”, Joint Collaborative Team on Video Coding (JCT-VC) of ITU-T SG 16 WP 3 and ISO/IEC JTC

(56)

References Cited

OTHER PUBLICATIONS

1/SC 29/WG 11, Document: JCTVC-L1003_v34, 12th Meeting: Geneva, CH, Jan. 14-23, 2013 (presented in three parts).

Bulterman et al., "Synchronized Multimedia Integration Language (SMIL 3.0)", W3C Recommendation, Dec. 1, 2008, <https://www.w3.org/TR/2008/REC-SMIL3-20081201/>, 321 pgs. (presented in five parts).

Cahill et al., "Locally Adaptive Deblocking Filter for Low Bit Rate Video", Proceedings 2000 International Conference on Image Processing, Sep. 10-13, 2000, Vancouver, BC, Canada, 4 pgs.

Candelore, U.S. Appl. No. 60/372,901, filed Apr. 17, 2002, 5 pgs.

Casares et al., "Simplifying Video Editing Using Metadata", DIS2002, 2002, pp. 157-166.

Chaddha et al., "A Frame-work for Live Multicast of Video Streams over the Internet", Proceedings of 3rd IEEE International Conference on Image Processing, Sep. 19, 1996, Lausanne, Switzerland, 4 pgs.

Cheng, "Partial Encryption for Image and Video Communication", Thesis, Fall 1998, 95 pgs.

Cheng et al., "Partial encryption of compressed images and videos", IEEE Transactions on Signal Processing, vol. 48, No. 8, Aug. 2000, 33 pgs.

Cheung et al., "On the Use of Destination Set Grouping to Improve Fairness in Multicast Video Distribution", Proceedings of IEEE INFOCOM'96, Conference on Computer Communications, vol. 2, IEEE, 1996, 23 pgs.

Collet, "Delivering Protected Content, An Approach for Next Generation Mobile Technologies", Thesis, 2010, 84 pgs.

Concolato et al., "Live HTTP Streaming of Video and Subtitles within a Browser", MMSys 2013, Feb. 26-Mar. 1, 2013, Oslo, Norway, 5 pgs.

De Cock et al., "Complexity-Based Consistent-Quality Encoding in the Cloud", IEEE International Conference on Image Processing (ICIP), Date of Conference Sep. 25-28, 2016, Phoenix, AZ, pp. 1484-1488.

Deutscher, "IIS Transform Manager Beta—Using the MP4 to Smooth Task", Retrieved from: <https://web.archive.org/web/20130328111303/http://blog.johndeutscher.com/category/smooth-streaming>, Blog post of Apr. 29, 2011, 14 pgs.

Diamantis et al., "Real Time Video Distribution using Publication through a Database", Proceedings SIBGRAP'98. International Symposium on Computer Graphics, Image Processing, and Vision (Cat. No. 98EX237), Oct. 1990, 8 pgs.

Dworkin, "Recommendation for Block Cipher Modes of Operation: Methods and Techniques", NIST Special Publication 800-38A, 2001, 66 pgs.

Eskicioglu et al., "An Integrated Approach to Encrypting Scalable Video", Proceedings IEEE International Conference on Multimedia and Expo, Aug. 26-29, 2002, Lausanne, Switzerland, 4 pgs.

Fang et al., "Real-time deblocking filter for MPEG-4 systems", Asia-Pacific Conference on Circuits and Systems, Oct. 28-31, 2002, Bail, Indonesia, pp. 541-544.

Fecheyr-Lippens, "A Review of HTTP Live Streaming", **check for duplicate** Internet Citation, Jan. 25, 2010, pp. 1-37.

Fecheyr-Lippens, "A Review of HTTP Live Streaming", Jan. 2010, 38 pgs.

Fielding et al., "Hypertext Transfer Protocol—HTTP1.1", Network Working Group, RFC 2616, Jun. 1999, 114 pgs.

Fukuda et al., "Reduction of Blocking Artifacts by Adaptive DCT Coefficient Estimation in Block-Based Video Coding", Proceedings 2000 International Conference on Image Processing, Sep. 10-13, 2000, Vancouver, BC, Canada, pp. 969-972.

Garg et al., "An Experimental Study of Throughput for UDP and VoIP Traffic in IEEE 802.11b Networks", Wireless Communications and Networkings, Mar. 2003, pp. 1748-1753.

Gast, "When is 54 Not Equal to 54? A Look at 802.11a, b and g Throughput", Aug. 8, 2003, printed Oct. 30, 2008 from www.oreillynet.com/pub/a/wireless/2003/08/08/wireless_throughput.html, 4 pgs.

Ghosh, "Enhancing Silverlight Video Experiences with Contextual Data", Retrieved from: <http://msdn.microsoft.com/en-us/magazine/ee336025.aspx>, 2010, 15 pgs.

Griffith, Eric, "The Wireless Digital Picture Frame Arrives", Wi-Fi Planet, printed May 4, 2007 from <http://www.wi-fiplanet.com/news/article.php/3093141>, Oct. 16, 2003, 3 pgs.

Hartung et al., "DRM Protected Dynamic Adaptive HTTP Streaming", MMSys 2011 Proceedings of the Second Annual ACM Conference on Multimedia Systems, San Jose, California, Feb. 23-25, 2011, pp. 277-282.

Huang, U.S. Pat. No. 7,729,426, U.S. Appl. No. 11/230,794, filed Sep. 20, 2005, 143 pgs.

Huang et al., "Adaptive MLP post-processing for block-based coded images", IEEE Proceedings—Vision, Image and Signal Processing, vol. 147, No. 5, Oct. 2000, pp. 463-473.

Huang et al., "Architecture Design for Deblocking Filter in H.264/JVT/AVC", 2003 International Conference on Multimedia and Expo., Jul. 6-9, 2003, Baltimore, MD, 4 pgs.

Hurtado Guzman, "Development and Implementation of an Adaptive HTTP Streaming Framework for H264/MVC Coded Media", Politecnico di Torino, Nov. 2010, 108 pgs.

Hwang et al., "Efficient and User Friendly Inter-domain Device Authentication/Access control for Home Networks", Proceedings of the 2006 International Conference on Embedded and Ubiquitous Computing, Seoul, Korea, Aug. 1-4, 2006, pp. 131-140.

Inlet Technologies, "Adaptive Delivery to iDevices", 2010, 2 pages.

Inlet Technologies, "Adaptive delivery to iPhone 3.0", 2009, 2 pgs.

Inlet Technologies, "HTTP versus RTMP", 2009, 3 pages.

Inlet Technologies, "The World's First Live Smooth Streaming Event: The French Open", 2009, 2 pages.

I-O Data, "Innovation of technology arrived", Nov. 2004, Retrieved from http://www.iodata.com/catalogs/AVLP2DVDLA_Flyer200505.pdf, 2 pgs.

Jain et al., U.S. Appl. No. 61/522,623, filed Aug. 11, 2011, 44 pgs.

Jung et al., "Design and Implementation of an Enhanced Personal Video Recorder for DTV", IEEE Transactions on Consumer Electronics, vol. 47, No. 4, Nov. 2001, 6 pgs.

Kalva, Hari, "Delivering MPEG-4 Based Audio-Visual Services", 2001, 113 pgs.

Kang et al., "Access Emulation and Buffering Techniques for Steaming of Non-Stream Format Video Files", IEEE Transactions on Consumer Electronics, vol. 43, No. 3, Aug. 2001, 7 pgs.

Kaspar et al., "Using HTTP Pipelining to Improve Progressive Download over Multiple Heterogeneous Interfaces", IEEE ICC proceedings, 2010, 5 pgs.

Kim et al., "A Deblocking Filter with Two Separate Modes in Block-Based Video Coding", IEEE transactions on circuits and systems for video technology, vol. 9, No. 1, 1999, pp. 156-160.

Kim et al., "Tree-Based Group Key Agreement", Feb. 2004, 37 pgs.

Kozintsev et al., "Improving last-hop multicast streaming video over 802.11", Workshop on Broadband Wireless Multimedia, Oct. 2004, pp. 1-10.

Kurzke et al., "Get Your Content Onto Google TV", Google, Retrieved from: <http://commondatastorage.googleapis.com/io2012/presentations/live%20to%20website/1300.pdf>, 2012, 58 pgs.

Lang, "Expression Encoder, Best Practices for live smooth streaming broadcasting", Microsoft Corporation, 2010, retrieved from <http://www.streamingmedia.com/conferences/west2010/presentations/SMWest-12010-Expression-Encoder.pdf>, 20 pgs.

Laukens, "Adaptive Streaming—A Brief Tutorial", EBU Technical Review, 2011, 6 pgs.

Legault et al., "Professional Video Under 32-bit Windows Operating Systems", SMPTE Journal, vol. 105, No. 12, Dec. 1996, 10 pgs.

Levkov, "Mobile Encoding Guidelines for Android Powered Devices", Adobe Systems Inc., Addendum B, Dec. 22, 2010, 42 pgs.

Li et al., "Content-Aware Payout and Packet Scheduling for Video Streaming Over Wireless Links", IEEE Transactions on Multimedia, vol. 10, No. 5, Aug. 2008, pp. 885-895.

Li et al., "Layered Video Multicast with Retransmission (LVMR): Evaluation of Hierarchical Rate Control", Proceedings of IEEE INFOCOM'98, the Conference on Computer Communications.

(56)

References Cited

OTHER PUBLICATIONS

Seventeenth Annual Joint Conference of the IEEE Computer and Communications Societies. Gateway to the 21st Century, Cat. No. 98, vol. 3, 1998, 26 pgs.

Lian et al., "Efficient video encryption scheme based on advanced video coding", *Multimed. Tools Appl.* vol. 38, 2008, pp. 75-89.

Lin et al., "Multipass Encoding for Reducing Pulsing Artifacts in Cloud Based Video Transcoding", *IEEE International Conference on Image Processing (ICIP)*, Date of Conference Sep. 27, 30, 2015, Quebec City, QC, Canada, pp. 907-911.

List et al., "Adaptive deblocking filter", *IEEE transactions on circuits and systems for video technology*, vol. 13, No. 7, Jul. 2003, pp. 614-619.

Liu et al., "A Formal Framework for Component Deployment", *OOPSLA 2006, Proceedings of the 21st Annual ACM SIGPLAN Conference on Object-Oriented Programming Systems, Language, and Applications*, Portland, Oregon, Oct. 22-26, 2006, pp. 325-344.

Long et al., "Silver: Simplifying Video Editing with Metadata", *Demonstrations, CHI 2003: New Horizons*, Apr. 5-10, 2003, pp. 628-629.

Massoudi et al., "Overview on Selective Encryption of Image and Video: Challenges and Perspectives", *EURASIP Journal on Information Security*, Nov. 2008, 18 pgs.

Matroska, "Diagram", Matroska, Technical/Info, Diagram, 2016, retrieved from <https://www.matroska.org/technical/diagram/index.html> on Jul. 20, 2017, 9 pages.

Matroska, "Specifications", Matroska, Technical/Info, Specifications, Jun. 25, 2017, retrieved from <https://www.matroska.org/technical/specs/index.html> on Jul. 20, 2017, 20 pages.

McCanne et al., "Receiver-driven Layered Multicast", *Conference proceedings on Applications, technologies, architectures, and protocols for computer communications*, Aug. 1996, 14 pgs.

Meier, "Reduction of Blocking Artifacts in Image and Video Coding", *IEEE Transactions on Circuits and Systems for Video Technology*, vol. 9, No. 3, Apr. 1999, pp. 490-500.

Miras, "On Quality Aware Adaptation of Internet Video", *University of London, PhD dissertation*, May 2004, 181 pgs.

Morrison, "EA IFF 85 Standard for Interchange Format Files", Jan. 14, 1985, printed from <http://www.dcs.ed.ac.uk/home/mxr/gfx/2d/IFF.txt> on Mar. 6, 2006, 24 pgs.

Moscoso, Pedro Gomes, "Interactive Internet TV Architecture Based on Scalable Video Coding", *Instituto Superior Technico, Universidad Technica de Lisboa*, May 2011, 103 pgs.

MSDN, "Adaptive streaming, Expression Studio 2.0", Apr. 23, 2009, 2 pgs.

Nelson, "Arithmetic Coding + Statistical Modeling = Data Compression: Part 1—Arithmetic Coding", *Doctor Dobb's Journal*, Feb. 1991, USA, pp. 1-12.

Nelson, Mark, "Arithmetic Coding + Statistical Modeling = Data Compression: Part 1—Arithmetic Coding", *Doctor Dobb's Journal*, Feb. 1991, printed from <http://www.dogma.net/markn/articles/arith/part1.htm>; printed Jul. 2, 2003, 12 pgs.

Nelson, Michael, "IBM's Cryptolopes", *Complex Objects in Digital Libraries Course*, Spring 2001, Retrieved from http://www.cs.ou.edu/~mln/teaching/unc/inls210/?method=display&pkg_name=cryptolopes.pkg&element_name=cryptolopes.ppt, 12 pages.

Newton et al., "Preserving Privacy by De-identifying Facial Images", *Carnegie Mellon University School of Computer Science, Technical Report, CMU-CS-03-119*, Mar. 2003, 26 pgs.

Noboru, "Play Fast and Fine Video on Web! codec", *Co.9 No. 12*, Dec. 1, 2003, pp. 178-179.

Noe, Alexander, "AVI File Format", <http://www.alexander-noe.com/video/documentation/avi.pdf>, Dec. 14, 2006, pp. 1-26.

Noe, Alexander, "Definitions", Apr. 11, 2006, retrieved from <http://www.alexander-noe.com/video/amg/definitions.html> on Oct. 16, 2013, 2 pages.

O'Brien, U.S. Appl. No. 60/399,846, filed Jul. 30, 2002, 27 pgs.

Ooyala, "Widevine Content Protection", *Ooyala Support Center for Developers*. Ooyala, Inc., 2013. Jun. 3, 2013. http://support.ooyala.com/developers/documentation/concepts/player_v3_widevine_integration.html.

O'Rourke, "Improved Image Decompression for Reduced Transform Coding Artifacts", *IEEE Transactions on Circuits and Systems for Video Technology*, vol. 5, No. 6, Dec. 1995, pp. 490-499.

Oyman et al., "Quality of Experience for HTTP Adaptive Streaming Services", *IEEE Communications Magazine*, Apr. 2012, vol. 50, No. 4, pp. 20-27, DOI: 10.1109/MCOM.2012.6178830.

Ozer, Jan, "Adaptive Streaming in the Field", *Streaming Media*, Dec. 2010-Jan. 2011, pp. 36-47.

Padiadpu, Rashmi, "Towards Mobile Learning: A Scorm Player for the Google Android Platform", *Master Thesis, Hamburg University of Applied Sciences*, 2008, 66 pgs.

Papagiannaki et al., "Experimental Characterization of Home Wireless Networks and Design Implications", *INFOCOM 2006, 25th IEEE International Conference of Computer Communications, Proceedings*, Apr. 2006, 13 pgs.

Park et al., "A postprocessing method for reducing quantization effects in low bit-rate moving picture coding", *IEEE Transactions on Circuits and Systems for Video Technology*, vol. 9, No. 1, Feb. 1999, pp. 161-171.

Peek, David, "Consumer Distributed File Systems", *Dissertation, Doctor of Philosophy, Computer Science and Engineering, The University of Michigan*, 2009, 118 pgs.

Phamdo, "Theory of Data Compression", printed on Oct. 10, 2003, 12 pgs.

Richardson, "H.264 and MPEG-4 Video Compression", *Wiley*, 2003, 306 pgs. (presented in 2 parts).

Rosenberg et al., "Indicating User Agent Capabilities in the Session Initiation Protocol (SIP)", *Network Working Group, RFC 3840*, Aug. 2004, 36 pgs.

Schulzrinne, H, "Real Time Streaming Protocol 2.0 (RTSP): draft-ietfmmusic-rfc2326bis-27", *MMUSIC Working Group of the Internet Engineering Task Force (IETF)*, 296 pgs. (presented in two parts), Mar. 9, 2011, 296 pages.

Silvia, "Adaptive HTTP Streaming for Open Codecs", Oct. 9, 2010, [retrieved on: Mar. 2, 2018].

Sima et al., "An Efficient Architecture for Adaptive Deblocking Filter of H.264 AVC Video Coding", *IEEE Transactions on Consumer Electronics*, vol. 50, No. 1, Feb. 2004, pp. 292-296.

Spanos et al., "Performance Study of a Selective Encryption Scheme for the Security of Networked, Real-Time Video", *Proceedings of the Fourth International Conference on Computer Communications and Networks, IC3N'95*, Sep. 20-23, 1995, Las Vegas, NV, pp. 2-10.

Srinivasan et al., "Windows Media Video 9: overview and applications", *Signal Processing: Image Communication*, 2004, 25 pgs.

Stockhammer, "Dynamic Adaptive Streaming over HTTP—Standards and Design Principles", *Proceedings of the second annual ACM conference on Multimedia*, Feb. 2011, pp. 133-145.

Tan, Yap-Peng et al., "Video transcoding for fast forward/reverse video playback", *IEEE ICIP*, 2002, pp. I-713 to I-716.

Taxan, "A Vel LinkPlayer2 for Consumer", *I-O Data USA—Products—Home Entertainment*, printed May 4, 2007 from <http://www.iodata.com/usa/products/products.php?cat=HNP&sc=AVEL&pId=AVLP2/DVDLA&ts=2&tsc>, 1 pg.

Timmerer et al., "HTTP Streaming of MPEG Media", *Proceedings of Streaming Day*, 2010, 4 pgs.

Tiphaigne et al., "A Video Package for Torch", Jun. 2004, 46 pgs.

Trappe et al., "Key Management and Distribution for Secure Multimedia Multicast", *IEEE Transaction on Multimedia*, vol. 5, No. 4, Dec. 2003, pp. 544-557.

Tripathi et al., "Improving Multimedia Streaming with Content-Aware Video Scaling", Retrieved from: <http://digitalcommons.wpi.edu/computerscience-pubs/96>, 2001, 17 pgs.

Unknown, "AVI RIFF File Reference (Direct X 8.1 C++ Archive)", printed from http://msdn.microsoft.com/archive/en-us/dx81_c/directx_cpp/htm/aviriffreference.asp?fr... on Mar. 6, 2006, 7 pgs.

Unknown, "Entropy and Source Coding (Compression)", *TCOM 570*, 1999-9, pp. 1-22.

(56)

References Cited

OTHER PUBLICATIONS

Unknown, "MPEG-4 Video Encoder: Based on International Standard ISO/IEC 14496-2", Patni Computer Systems, Ltd., publication date unknown, 15 pgs.

Van Deursen et al., "On Media Delivery Protocols in the Web", 2010 IEEE International Conference on Multimedia and Expo, Jul. 19-23, 2010, 6 pgs.

Venkatramani et al., "Securing Media for Adaptive Streaming", Multimedia 2003 Proceedings of the Eleventh ACM International Conference on Multimedia, Nov. 2-8, 2003, Berkeley, California, 4 pgs.

Ventura, Guillermo Albaida, "Streaming of Multimedia Learning Objects", AG Integrated Communication System, Mar. 2003, 101 pgs.

Waggoner, "Compression for Great Digital Video", 2002, 184 pgs.

Wang et al., "Image Quality Assessment: From Error Visibility to Structural Similarity", IEEE Transactions on Image Processing, Apr. 2004, vol. 13, No. 4, pp. 600-612.

Watanabem et al., "MPEG-2 decoder enables DTV trick plays", esearcher System LSI Development Lab, Fujitsu Laboratories Ltd., Kawasaki, Japan, Jun. 2001, 2 pgs.

Wiegand, "Joint Video Team (JVT) of ISO/IEC MPEG and ITU-T VCEG", Jan. 2002, 70 pgs.

Willig et al., U.S. Appl. No. 61/409,285, filed Nov. 2, 2010, 43 pgs.

Yang et al., "Projection-Based Spatially Adaptive Reconstruction of Block-Transform Compressed Images", IEEE Transactions on Image Processing, vol. 4, No. 7, Jul. 1995, pp. 896-908.

Yang et al., "Regularized Reconstruction to Reduce Blocking Artifacts of Block Discrete Cosine Transform Compressed Images", IEEE Transactions on Circuits and Systems for Video Technology, vol. 3, No. 6, Dec. 1993, pp. 421-432.

Yu et al., "Video deblocking with fine-grained scalable complexity for embedded mobile computing", Proceedings 7th International Conference on Signal Processing, Aug. 31-Sep. 4, 2004, pp. 1173-1178.

Zakhor, "Iterative Procedures for Reduction of Blocking Effects in Transform Image Coding", IEEE Transactions on Circuits and Systems for Video Technology, vol. 2, No. 1, Mar. 1992, pp. 91-95.

Prosecution File History for U.S. Pat. No. 10,225,588, IPR filed Feb. 15, 2020, 2937 pgs., presented in 29 parts.

U.S. Appl. No. 61/530,305, filed Sep. 1, 2011, 6 pgs.

Wayback Machine, Grooveshark—Features, All Your Music In One Place, printed Aug. 15, 2016 from <https://web.archive.org/web/20081013115837/http://www.grooveshark.com/features>, 6 pgs.

"Broadcom BCM7413 Product Brief", Dec. 11, 2008, 2 pgs.

"Common Interface Specification for Conditional Access and other Digital Video Broadcasting Decoder Applications", European Standard, EN 50221, Feb. 1997, 86 pgs.

"Free music was never so cool before Grooveshark", Wayback Machine, Grooveshark, Startup Meme, May 31, 2008, printed Aug. 15, 2016 from <https://web.archive.org/web/20080601173852/http://startupmeme.com/2008/05/31/free-music-was-never-so-wool-before-grooveshark/>, 2 pgs.

"HTTP Live Streaming on the Leading Media CDN", Akamai website, retrieved from <http://www.akamai.com/html/resources/http-live-streaming.html>, 2015, accessed May 11, 2015, 5 pgs.

"Instantly convert songs into tiny URLs with TinySong", Wayback Machine, Startup Memo Technology Blog, printed Aug. 15, 2016 from <https://web.archive.org/web/2008919133853/http://startupmeme.com/instantly-convert-songs-into-tiny-urls-with-tinysong/>, 4 pgs.

"Media Delivery Solutions for Streaming Video and Software Delivery", Akamai website, Retrieved from <http://www.akamai.com/html/solutions/media-delivery-solutions.html>, 2015, Accessed May 11, 2015, 5 pgs.

"Microsoft Announces Breakthrough Technology Enabling Simple Access to Broad Set of Digital Content, Including Music, Games, Video, Ring Tones and Pictures", Microsoft, Feb. 12, 2017, Retrieved from <https://news.microsoft.com/2007/02/12/microsoft-announces->

breakthrough-technology-enabling-simple-access-to-broad-set-of-digital-content-including-music-games-video-ring-tones-and-pictures/, 5 pgs.

"SDMI Secure Digital Music Initiative", SDMI Portable Device Specification, Part 1, Version 1.0, Jul. 8, 1999, pp. 1-35.

"Server 'Trick Play' support for MPEG-2 Transport Stream Files", www.live555.com/liveMedia/transport-stream-trick-play.html, 2006, Dec. 31, 2020, 1 pg.

"The Live555 Media Server", www.live555.com/mediaServer/#about, 2006, printed Dec. 31, 2020, 3 pgs.

"Twitpic's Future", Twitpic, Oct. 25, 2014, Retrieved from: <https://web.archive.org/web/20150521043642/https://blog.twitpic.com/index.html>, 12 pgs.

"What is Fliggo?", Wayback Machine, printed Aug. 15, 2016 from <https://web.archive.org/web/20080623065120/http://www.fliggo.com/about>, 3 pgs.

ADB, "ADB-3800W Datasheet", 2007, 2 pgs.

Agi et al., "An Empirical Study of Secure MPEG Video Transmissions", IEEE, Mar. 1996, 8 pgs., DOI: 10.1109/NDSS.1996.492420.

Ahmed et al., "An Efficient Chaos-Based Feedback Stream Cipher (ECBFSC) for Image Encryption and Decryption", Informatica, Mar. 2007, vol. 31, No. 1, pp. 121-129.

Arachchi et al., "Adaptation-aware encryption of scalable H.264/AVC for content security", Signal Processing: Image Communication, Jul. 2009, vol. 24, pp. 468-483, doi:10.1016/j.image.2009.02.004.

Bell et al., "The BellKor 2008 Solution to the Netflix Prize", Netflix Prize, 2008, 21 pgs.

Catone, Josh "10 Ways to Share Music on Twitter", Mashable, May 29, 2009, Retrieved from: <https://mashable.com/2009/05/29/twitter-music/#vJCdrVzNOOqx>, 5 pgs.

Chesler, Oliver "TinySong is like TinyURL for music", wire to the ear, Jun. 30, 2008, printed Aug. 15, 2016 from <https://web.archive.org/web/20080907100459/http://www.wiretotheear.com/2008/06/30/tinysongis-like-tinyurl-for-music>, 8 pgs.

Conklin et al., "Video coding for streaming media delivery on the Internet", IEEE Transactions on Circuits and Systems for Video Technology, Mar. 2001, vol. 11, No. 3, pp. 269-281.

Deshpande et al., "Scalable Streaming of JPEG2000 Images Using Hypertext Transfer Protocol", Multimedia '01: Proceedings of the Ninth ACM International Conference on Multimedia, Oct. 2001, pp. 372-381. <https://doi.org/10.1145/500141.500197>.

Entone, "Amulet High Definition IP Television Receiver User's Guide", 2008, 28 pgs.

Entone, "Hydra HD IP Video Gateway", 2008, 2 pgs.

International Standard, Information technology—Generic coding of moving pictures and associated audio information: Systems, ISO/IEC 13818-1:2000(E), Dec. 1, 2000 174 pgs.

Decision Granting Institution of Inter Partes Review 35 U.S.C. § 314, IPR2020-00558, U.S. Pat. No. 10,225,588, 46 pgs.

Decision Granting Institution of Inter Partes Review 37 C.F.R. § 42.71(d) Granting Institution of Inter Partes Review 35 U.S.C. § 314, IPR2020-00614 U.S. Pat. No. 7,295,673, 29 pgs.

Declaration of Patrick McDaniel, Ph.D., Inter Partes Review of U.S. Pat. No. 10,225,588, IPR filed Feb. 15, 2020, 211 pgs.

Extended European Search Report for European Application No. 19211286.0, Search completed Jul. 3, 2020, dated Jul. 13, 2020, 9 Pgs.

Extended European Search Report for European Application No. 19211291.0, Search completed Jul. 6, 2020, dated Jul. 14, 2020, 12 Pgs.

First Amended Complaint for Patent Infringement, *DivX, LLC v. Netflix, Inc.*, No. 2:19-cv-1602-PSG, Am. Compl. (C.D. Cal Aug. 21, 2019), 229 pgs., IPR filed Feb. 15, 2020.

International Preliminary report on Patentability for International Application No. PCT/US2005/025845, report dated Jun. 19, 2007, 6 pgs.

International Preliminary Report on Patentability for International Application PCT/US2010/020372, Completed Oct. 6, 2011, 6 Pgs.

Petition for Inter Partes Review of U.S. Pat. No. 10,225,588, IPR2020-00558, 96 pgs., IPR filed Feb. 15, 2020.

Power of Attorney—Hulu, LLC (IPR2020-00558), 4 pgs., IPR filed Feb. 15, 2020.

(56)

References Cited

OTHER PUBLICATIONS

- Power of Attorney—Netflix, Inc. (IPR2020-00558), 4 pgs., IPR filed Feb. 15, 2020.
- Proceedings of the Second KDD Workshop on Large-Scale Recommender Systems and the Netflix Prize Competition, Las Vegas, Nevada, Aug. 24, 2008, 34 pgs.
- Prosecution File History for U.S. Appl. No. 13/340,623 to Kiefer et al. (“Kiefer”), IPR filed Feb. 15, 2020, 1249 pgs., presented in 6 parts.
- ETSI, “Digital Video Broadcasting (DVB) Support for use of scrambling and Conditional Access (CA) within digital broadcasting systems”, Oct. 1996, 13 pgs.
- ETSI, “Digital Video Broadcasting (DVB); Implementation guidelines for the use of Video and Audio Coding in Contribution and Primary Distribution Applications based on the MPEG-2 Transport Stream”, ETSI TS 102 154 V1.2.1, May 2004, 73 pgs.
- Fahmi et al., “Proxy Servers for Scalable Interactive Video Support”, *Computer*, Sep. 2001, vol. 45, No. 9, pp. 54-60, <https://doi.org/10.1109/2.947092>.
- Fitzek et al., “A Prefetching Protocol for Continuous Media Streaming in Wireless Environments”, *IEEE Journal on Selected Areas in Communications*, Oct. 2001, vol. 19, No. 10, pp. 2015-2028, DOI: 10.1109/49.957315.
- Ho, “Digital Video Broadcasting Conditional Access Architecture”, Report prepared for CS265-Section 2, Fall 2002, Prof Stamp, 7 pgs.
- INCITS/ISO/IEC, “Information Technology—Generic Coding of Moving Pictures And Associated Audio Information: Video (Formerly ANSI/ISO/IEC 13818-2-2000)”, Second edition, Dec. 15, 2000, 220 pgs., (presented in two parts).
- ISMA, “ISMA Encryption and Authentication, Version 1.1, Area / Task Force: DRM”, Internet Streaming Media Alliance, Sep. 15, 2006, pp. 1-64.
- ITU-T, “Series J: Cable Networks and Transmission of Television, Sound Programme and Other Multimedia Signals”, Technical method for ensuring privacy in long-distance international MPEG-2 television transmission conforming to ITU-T J.89, ITU-T Recommendation J.96, Mar. 2001, 34 pgs.
- Kabir, “Scalable and Interactive Multimedia Streaming Over the Internet”, Thesis, 2005, 207 pgs.
- Krikor et al., “Image Encryption Using DCT and Stream Cipher”, *European Journal of Scientific Research*, Jan. 2009, vol. 32, No. 1, pp. 48-58.
- Lew et al., “Content-Based Multimedia Information Retrieval: State of the Art and Challenges”, *ACM Transactions on Multimedia Computing, Communications and Applications*, Feb. 2006, vol. 2, No. 1, pp. 1-19.
- Lian et al., “Recent Advances in Multimedia Information System Security”, *Informatica*, Jan. 2009, vol. 33, pp. 3-24.
- Lian et al., “Selective Video Encryption Based on Advanced Video Coding”, *PCM*, Nov. 2005, Part II, LNCS 3768, pp. 281-290.
- Lievaart, “Characteristics that differentiate CA Systems”, *Irdeto access*, Nov. 2001, 5 pgs.
- Lloyd, “Supporting Trick Mode Playback Universally Across the Digital Television Industry”, Thesis, 2005, 111 pgs.
- Lomas et al., “Educause Learning Initiative, Collaboration Tools”, Educause Learning Initiative, Aug. 2008, ELI Paper 2: 2008, 11 pgs.
- Macaulay et al., “Whitepaper—IP Streaming of MPEG-4: Native RTP vs MPEG-2 Transport Stream”, *Envivio*, Oct. 2005, 12 pgs.
- Martin et al., “Privacy Protected Surveillance Using Secure Visual Object Coding”, *IEEE Transactions on Circuits and Systems for Video Technology*, Aug. 2008, vol. 18, No. 8, pp. 1152-1162, DOI: 10.1109/TCSVT.2008.927110.
- Meyer et al., “Security mechanisms for Multimedia-Data with the Example MPEG-I-Video”, *SECMPEG*, 1992, 10 pgs.
- Molavi et al., “A Security Study of Digital TV Distribution Systems”, Thesis, Jun. 2005, 112 pgs.
- Montes, “Muusic: mashup de servicios web musicales”, *Ingenieria Tecnica en Informatica de Gestion*, Nov. 2008, 87 pgs.
- Nelson, “The Data Compression Book”, M&T Publishing, 1992, 533 pgs., (presented in two parts).
- OIPF Open Forum, “OIPF Release 1 Specification, vol. 3, Content Metadata”, OIPF, Oct. 8, 2009, vol. 1.1, 47 pgs.
- OIPF Open Forum, “OIPF Release 1 Specification, vol. 7—Authentication, Content Protection and Service Protection”, OIPF, Oct. 8, 2009, vol. 1.1, 88 pgs.
- Open IPTV Forum, “Functional Architecture”, Jan. 16, 2008, vol. 1.1, 141 pgs.
- Open IPTV Forum, “OIPF Release 1 Specification, vol. 1—Overview”, OIPF, Oct. 8, 2009, vol. 1.1, 48 pgs.
- Open IPTV Forum, “OIPF Release 1 Specification, vol. 2, Media Formats”, OIPF, Oct. 8, 2009, vol. 1.1, 22 pgs.
- Park et al., “An Efficient Encryption and Key Management Scheme for Layered Access Control of H.265/Scalable Video Coding”, *IEICI Trans. Inf. & Syst.*, May 2009, vol. E92-D, No. 5, pp. 851-858, DOI: 1031587/transinf.E92.D.851.
- Park et al., “Combined Scheme of Encryption and Watermarking in H.264/Scalable Video Coding”, *New Directions in Intelligent Interactive Multimedia*, SCI 142, 2008, pp. 351-361.
- Qiao et al., “Comparison of MPEG Encryption Algorithms”, *Comput. & Graphics*, 1998, vol. 22, No. 4, pp. 437-448.
- Raju et al., “Fast and Secure Real-Time Video Encryption”, *Sixth Indian Conference on Computer Vision, Graphics & Image Processing*, Jan. 2009, pp. 257-264, doi:10.1109/ACVIGIP.2008.100.
- Senoh et al., “DRM Renewability & Interoperability”, *IEEE Xplore, Conference: Consumer Communications and Networking Conference*, 2004, Feb. 2004, pp. 424-429, DOI: 10.1109/CCNC.2004.1286899 *Conference: Consumer Communications and Networking Conference*, 2004. CCNC 2004. First IEEE.
- Sheu, Tsang-Ling et al., “Dynamic layer adjustments for SVC segments in P2P streaming networks”, *Computer Symposium (ICS)*, 2010, 2010 International, Tainan, Taiwan, R.O.C., pp. 793-798, 2010.
- Shojania et al., “Experiences with MPEG-4 Multimedia Streaming”, *CiteSeer*, Jan. 2001, 3 pgs., DOI: 10.1145/500141.500221.
- Symes, “Video Compression Demystified”, McGraw-Hill, 2001, 353 pgs., (presented in two parts).
- Taymans et al., “GStreamer Application Development Manual (1.6.0)”, 2007, 159 pgs.
- Thomas et al., “A Novel Secure H.264 Transcoder Using Selective Encryption”, *Proceedings in International Conference on Image Processing*, Jan. 2007, vol. 4, pp. IV-85-IV-88, DOI: 10.1109/ICIP.2007.4379960.
- Toscher et al., “The BigChaos Solution to the Netflix Prize 2008”, *Netflix Prize*, Nov. 25, 2008, 17 pgs.
- Tosun et al., “Efficient multi-layer coding and encryption of MPEG video streams”, *2000 IEEE International Conference on Multimedia and Expo. ICME2000. Proceedings. Latest Advances in the Fast Changing World of Multimedia (Cat. No. 00TH8532)*, July 30-Aug. 2, 2000, pp. 119-122, DOI: 10.1109/ICME.2000.869559.
- Um, “Selective Video Encryption of Distributed Video Coded Bitstreams and Multicast Security over Wireless Networks”, Thesis, Aug. 2006, 142 pgs.
- Van Grove, Jennifer “Top 5 Ways to Share Videos on Twitter”, *Mashable*, May 23, 2009, Retrieved from: <https://mashable.com/2009/05/23/video-for-twitter/#Jvn9IYYy6qQA>, 6 pgs.
- Wang, “Lightweight Encryption in Multimedia”, Thesis, Jun. 2005, 184 pgs.
- Weng, “A Multimedia Socaill-Networking Community for Mobile Devices”, 2007, 30 pgs.
- Wong, “Web Client Programming with Perl”, 1997, printed Jan. 8, 2021 from: <https://www.oreilly.com/openbook-webclientch03.html>, 31 pgs.
- Wu, “A Fast MPEG Encryption Algorithm and Implementation of AES on CAM”, Thesis, Oct. 6, 2003, 91 pgs.
- Yuksel, “Partial Encryption of Video for Communication and Storage”, Thesis, Sep. 2003, 78 pgs.
- “Supported Media Formats”, *Supported Media Formats, Android Developers*, Nov. 27, 2013, 3 pgs.
- European Search Report for Application 11855103.5, search completed Jun. 26, 2014, 9 pgs.
- European Search Report for Application 11855237.1, search completed Jun. 12, 2014, 9 pgs.

(56)

References Cited

OTHER PUBLICATIONS

Federal Computer Week, "Tool Speeds Info to Vehicles", Jul. 25, 1999, 5 pages.

HTTP Live Streaming Overview, Networking & Internet, Apple, Inc., Apr. 1, 2011, 38 pages.

Informationweek: Front End: Daily Dose, "Internet on Wheels", Jul. 20, 1999, 3 pgs.

International Search Report and Written Opinion for International Application PCT/US2011/066927, International Filing Date Dec. 22, 2011, Report Completed Apr. 3, 2012, Mailed Apr. 20, 2012, 14 pgs.

International Search Report and Written Opinion for International Application PCT/US2011/067167, International Filing Date Dec. 23, 2011, Report Completed Jun. 19, 2012, Mailed Jul. 2, 2012, 11 pgs.

The Official Microsoft IIS Site, Smooth Streaming Client, 4 pages.
Author Unknown, "Tunneling QuickTime RTSP and RTP over HTTP", Published by Apple Computer, Inc.: 1999 (month unknown), 6 pages.

"Netflix turns on subtitles for PC, Mac streaming", 3 pgs.

Deutscher, "IIS Transform Manager Beta-Using the MP4 to Smooth Task", Retrieved from: <https://web.archive.org/web/20130328111303/http://blog.johndeutscher.com/category/smooth-streaming>, Blog post of Apr. 17, 2010, 14 pgs.

Gannes, "The Lowdown on Apple's HTTP Adaptive Bitrate Streaming", GigaOM, Jun. 10, 2009, 12 pgs.

Kim, Kyuheon, "MPEG-2 ES/PES/TS/PSI", Kyung-Hee University, Oct. 4, 2010, 66 pages.

Nelson, "Smooth Streaming Deployment Guide", Microsoft Expression Encoder, Aug. 2010, 66 pgs.

Noe, A., "Matroska File Format (under construction!)", Retrieved from the Internet: URL: <http://web.archive.org/web/20070821155146/www.matroska.org/technical/specs/matroska.pdf>, retrieved on Jan. 19, 2011, Jun. 24, 2007, 1-51.

Ozer, "The 2012 Encoding and Transcoding Buyers' Guide", Streamingmedia.com, Retrieved from: <http://www.streamingmedia.com/Articles/Editorial/Featured-Articles/The-2012-Encoding-and-Transcoding-Buyers-Guide-84210.aspx>, 2012, 8 pgs.

Pantos, "HTTP Live Streaming, draft-pantos-http-live-streaming-10", IETF Tools, Oct. 15, 2012, Retrieved from: <http://tools.ietf.org/html/draft-pantos-http-live-streaming-10>, 37 pgs.

Pantos, R, "HTTP Live Streaming: draft-pantos-http-live-streaming-06", Published by the Internet Engineering Task Force (IETF), Mar. 31, 2011, 24 pages.

RGB Networks, "Comparing Adaptive HTTP Streaming Technologies", Nov. 2011, Retrieved from: <http://btreport.net/wp-content/uploads/2012/02/RGB-Adaptive-HTTP-Streaming-Comparison-1211-01.pdf>, 20 pgs.

Schulzrinne, H et al., "Real Time Streaming Protocol 2.0 (RTSP): draft-ietfmmusic-rfc2326bis-27", MMUSIC Working Group of the Internet Engineering Task Force (IETF), Mar. 9, 2011, 296 pages.

Siglin, "HTTP Streaming: What You Need to Know", streamingmedia.com, 2010, 15 pages.

Siglin, "Unifying Global Video Strategies, MP4 File Fragmentation for Broadcast, Mobile and Web Delivery", Nov. 16, 2011, 16 pgs.

Wu, Feng et al., "Next Generation Mobile Multimedia Communications: Media Codec and Media Transport Perspectives", In China Communications, Oct. 2006, pp. 30-44.

Zambelli, Alex "IIS Smooth Streaming Technical Overview", Microsoft Corporation, Mar. 2009.

* cited by examiner

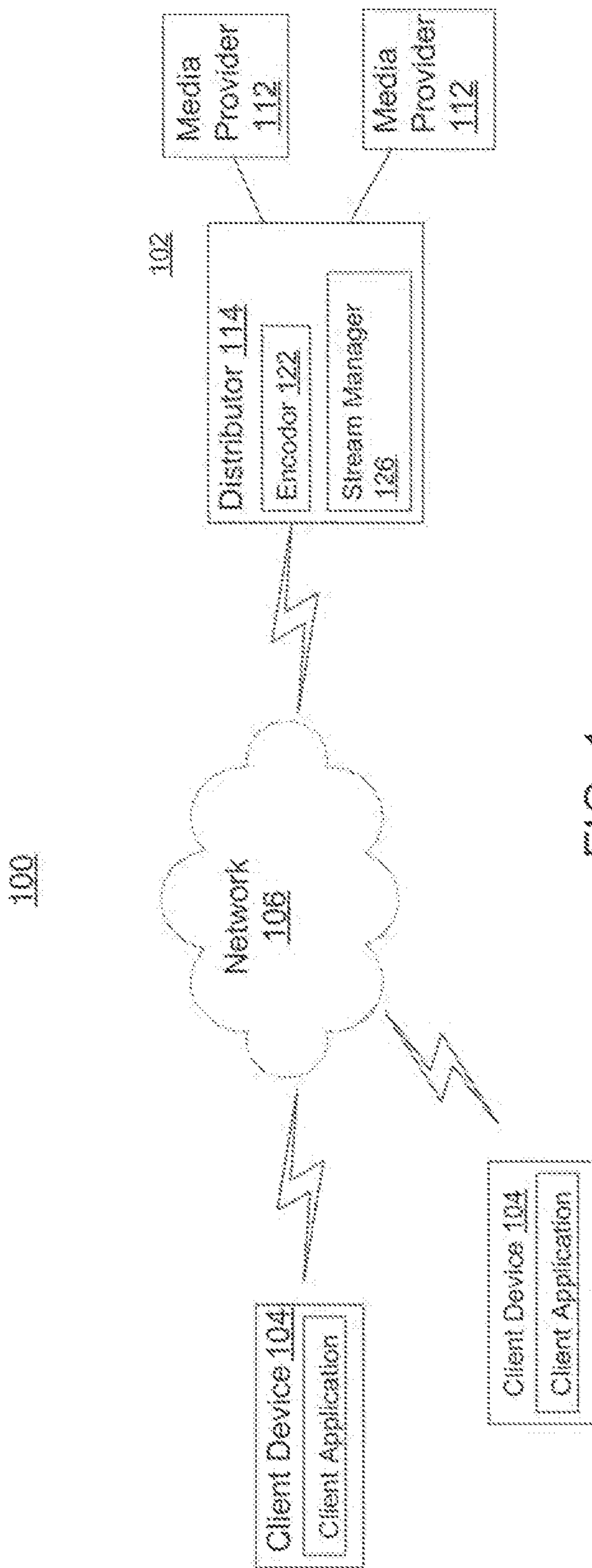

FIG. 1

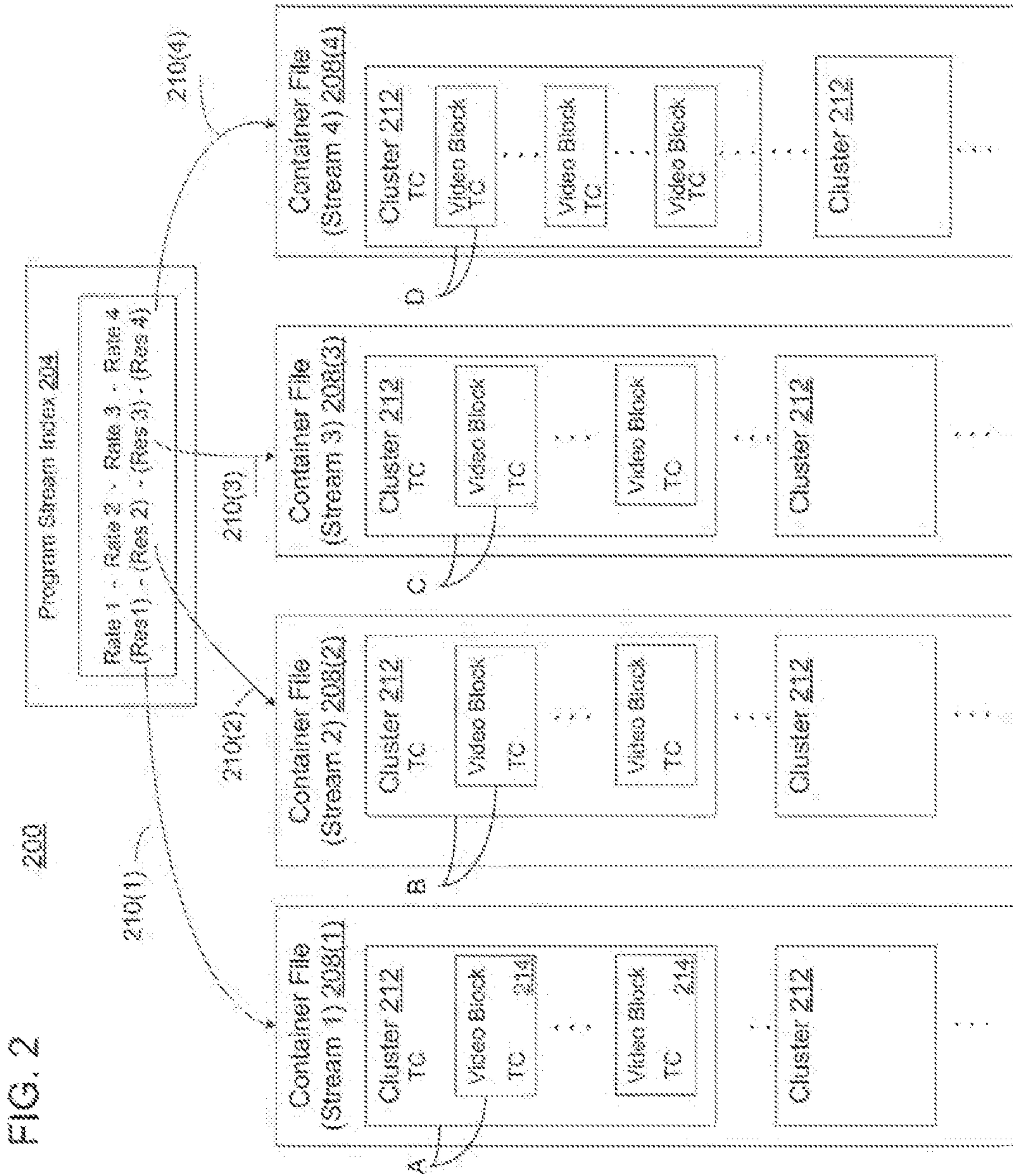

FIG. 2

FIG. 5

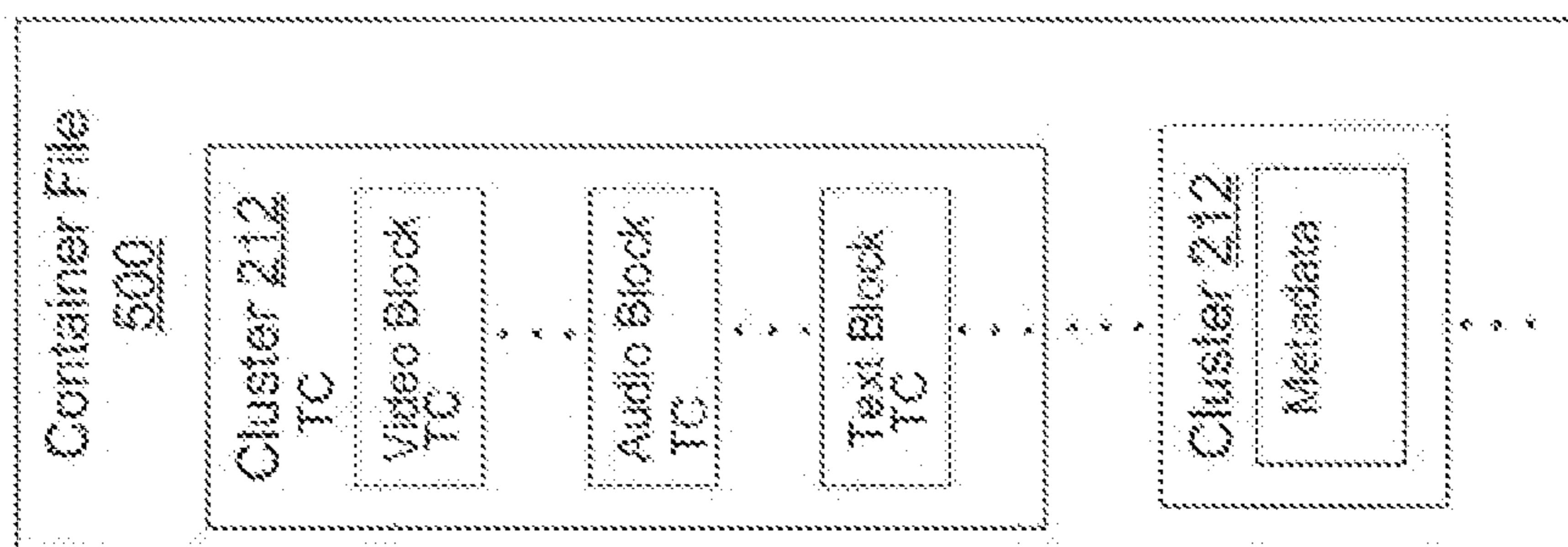

FIG. 4

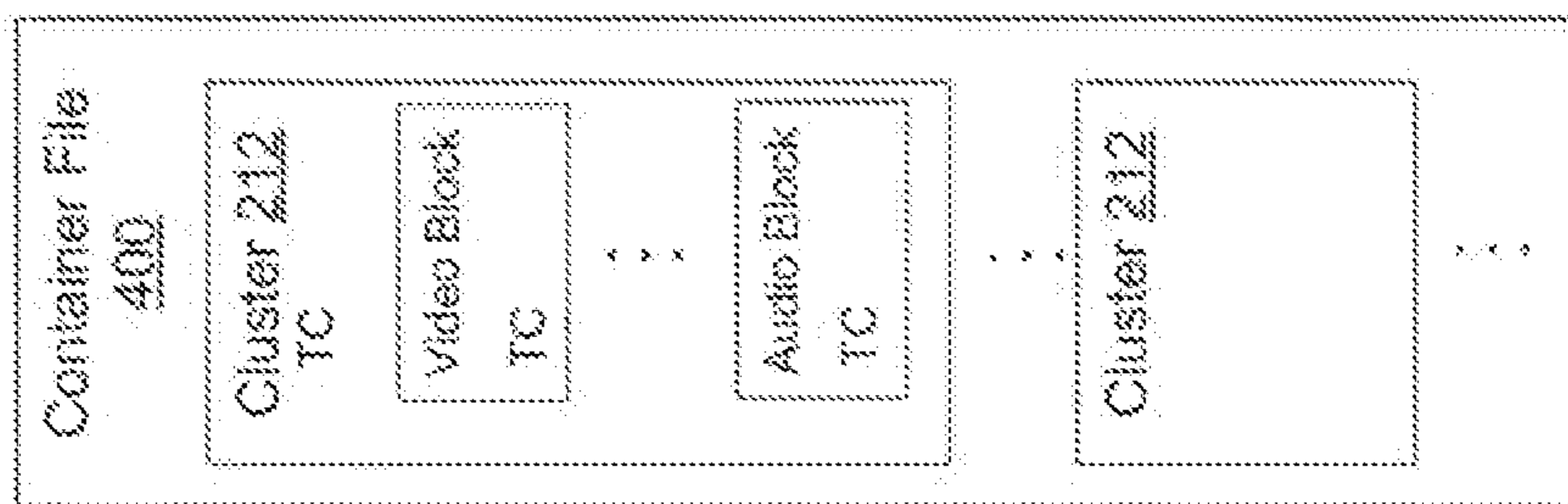
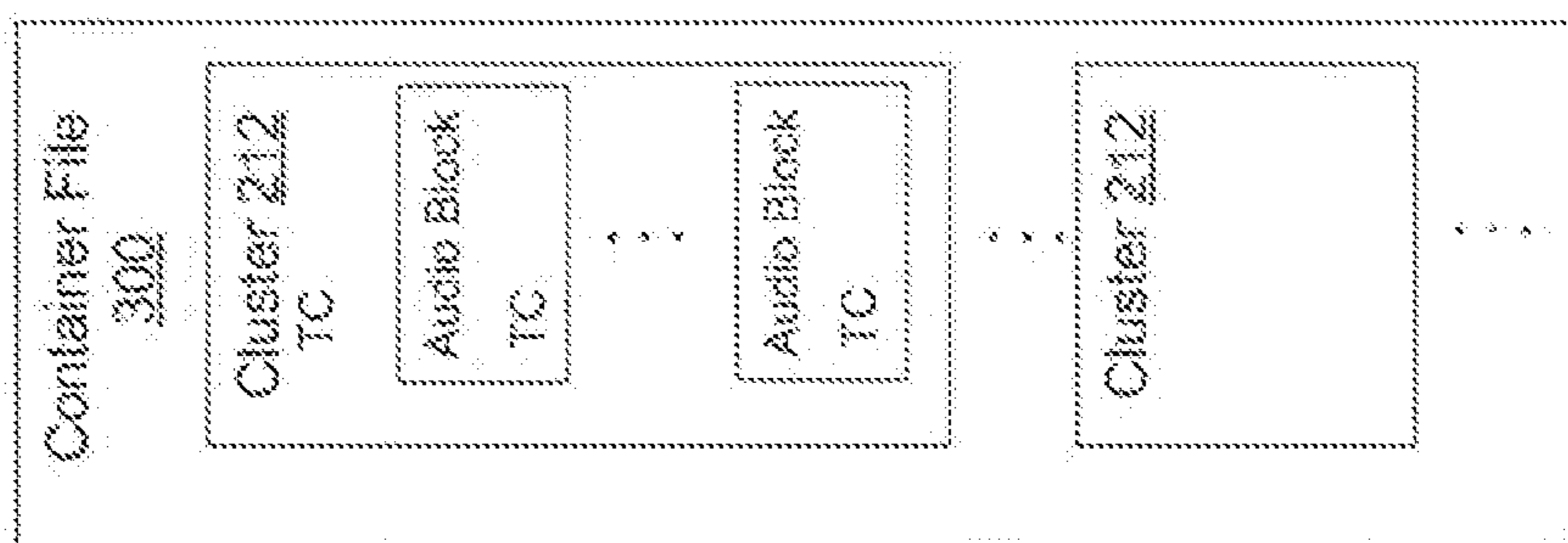

FIG. 3



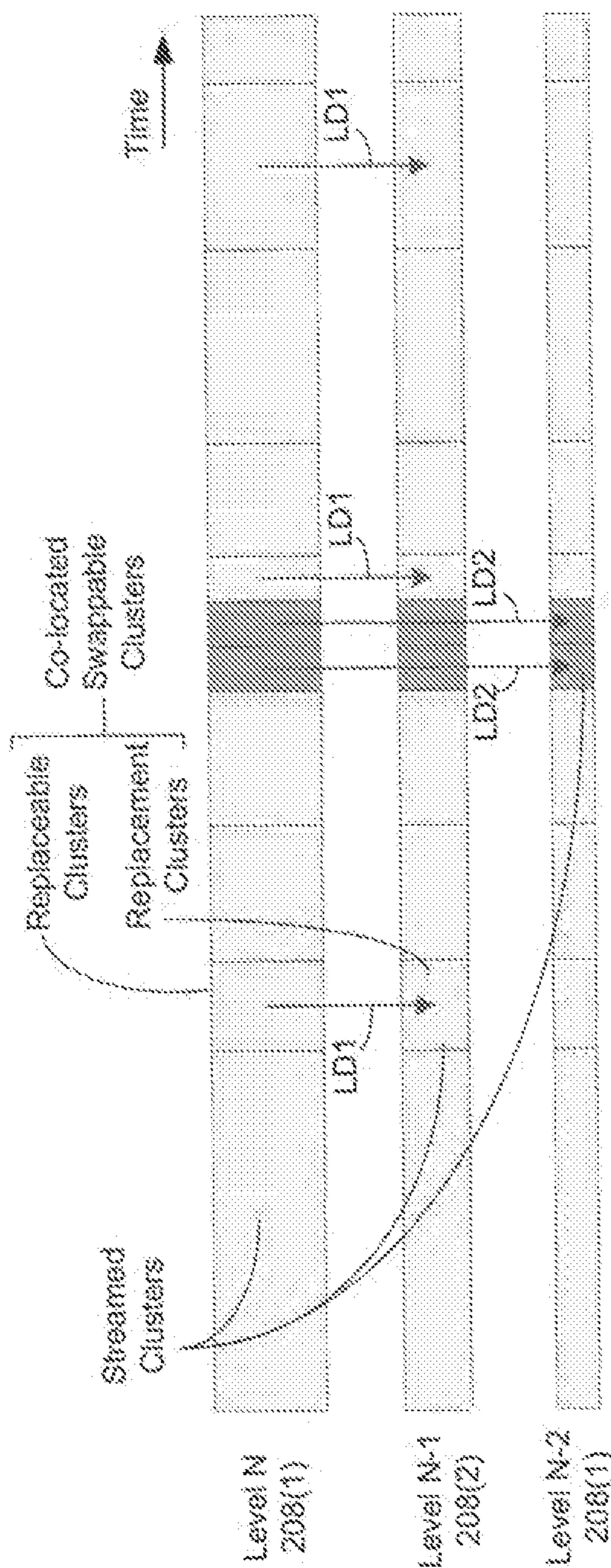

FIG. 6

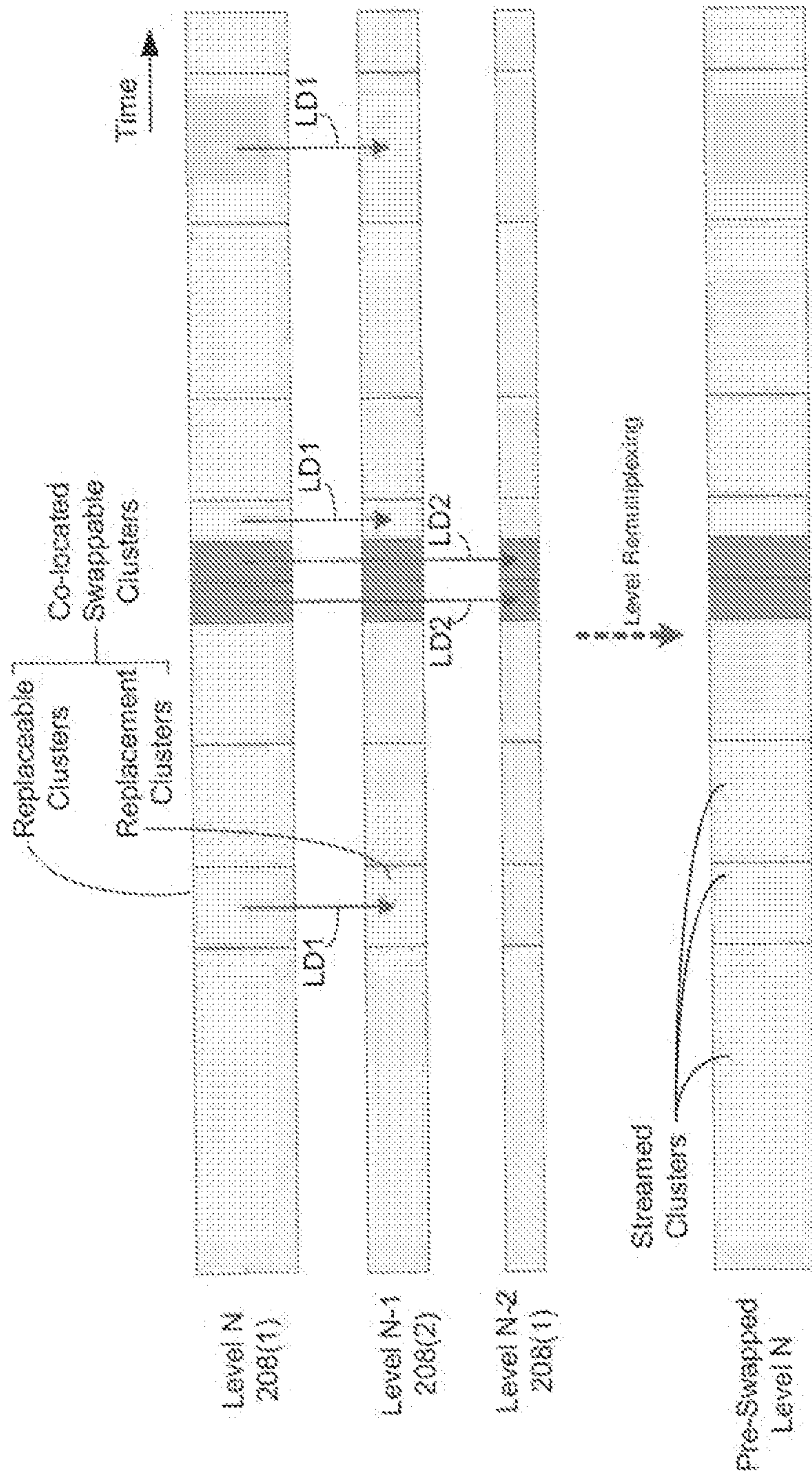

FIG. 7

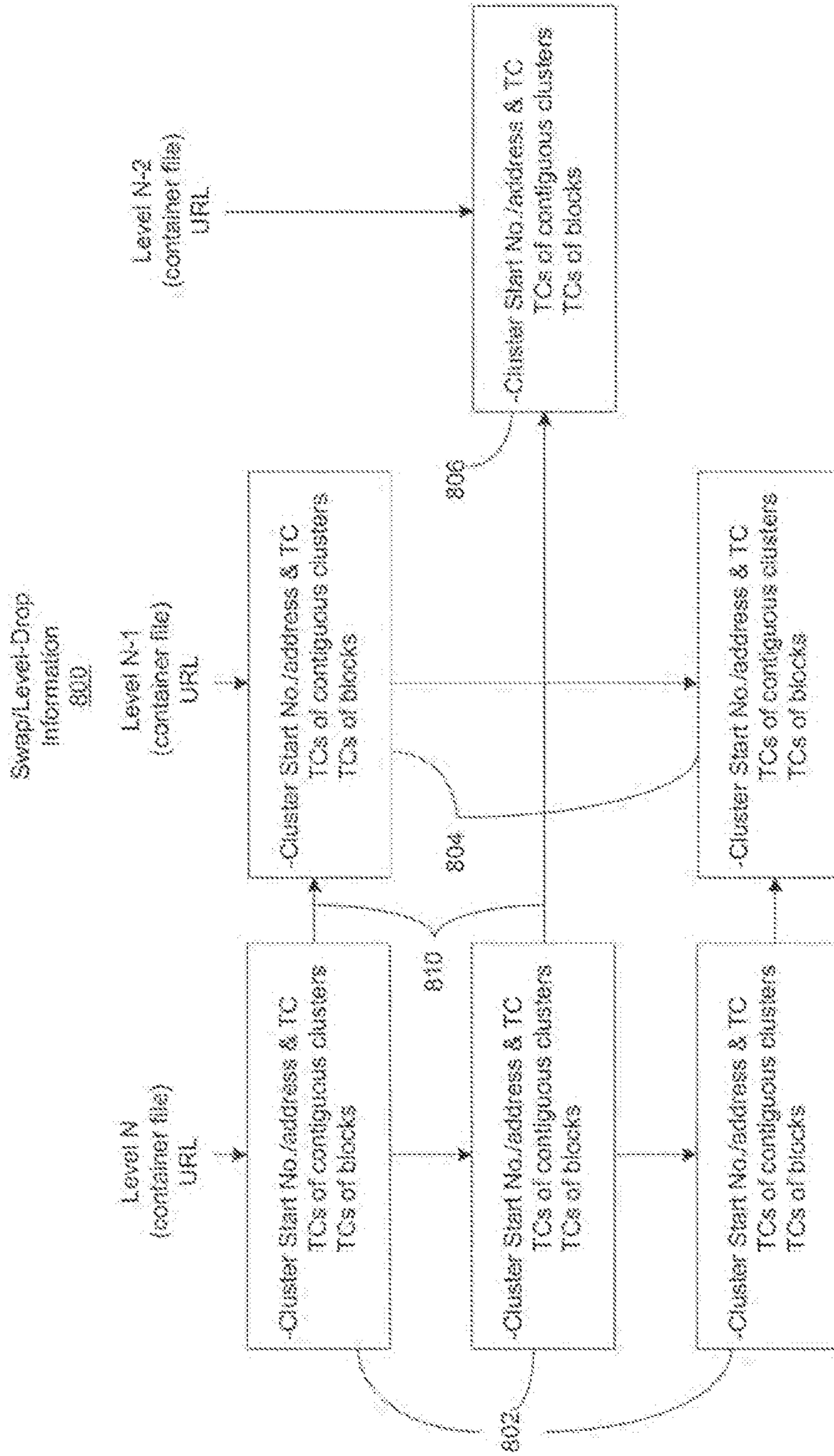

FIG. 8

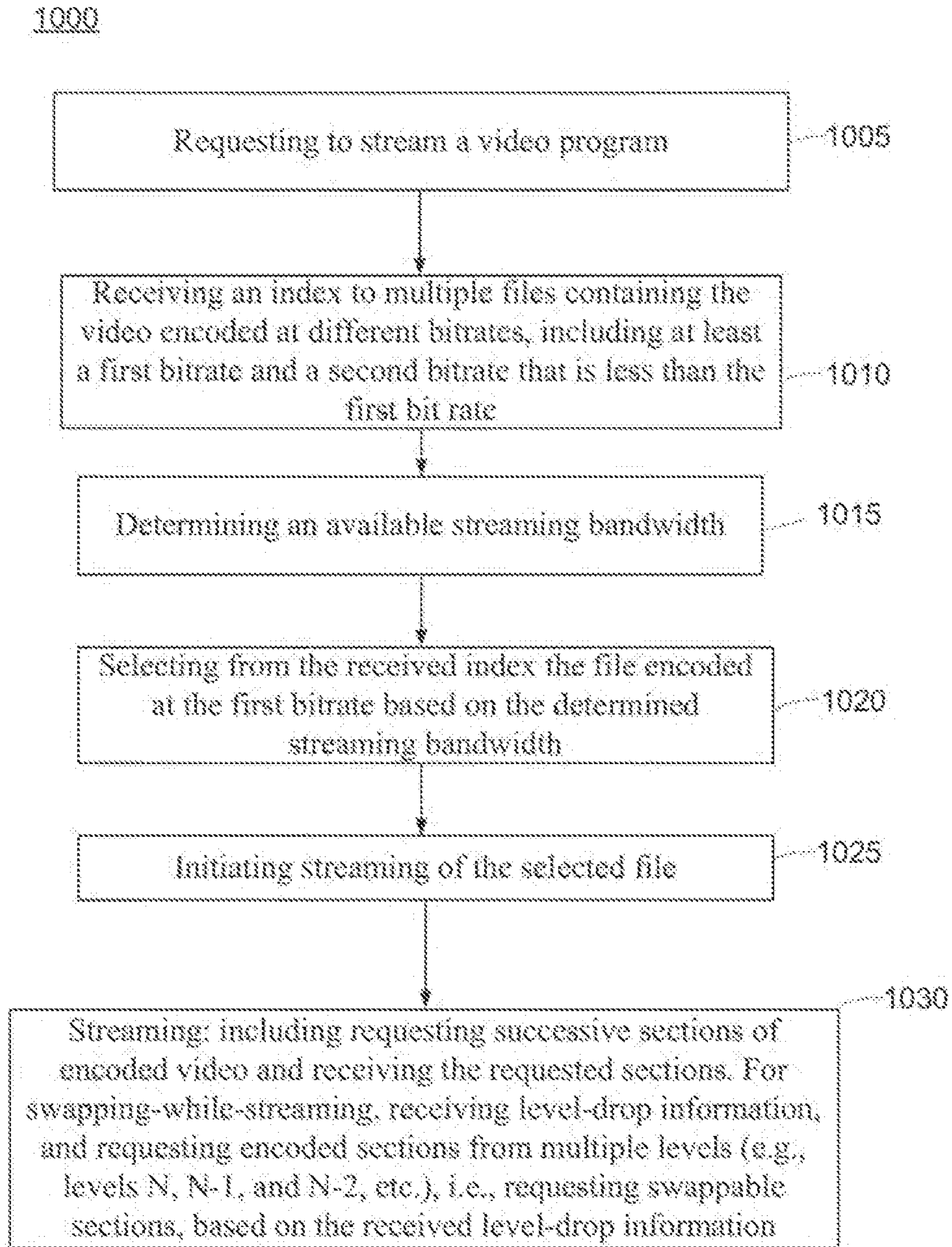

FIG. 10

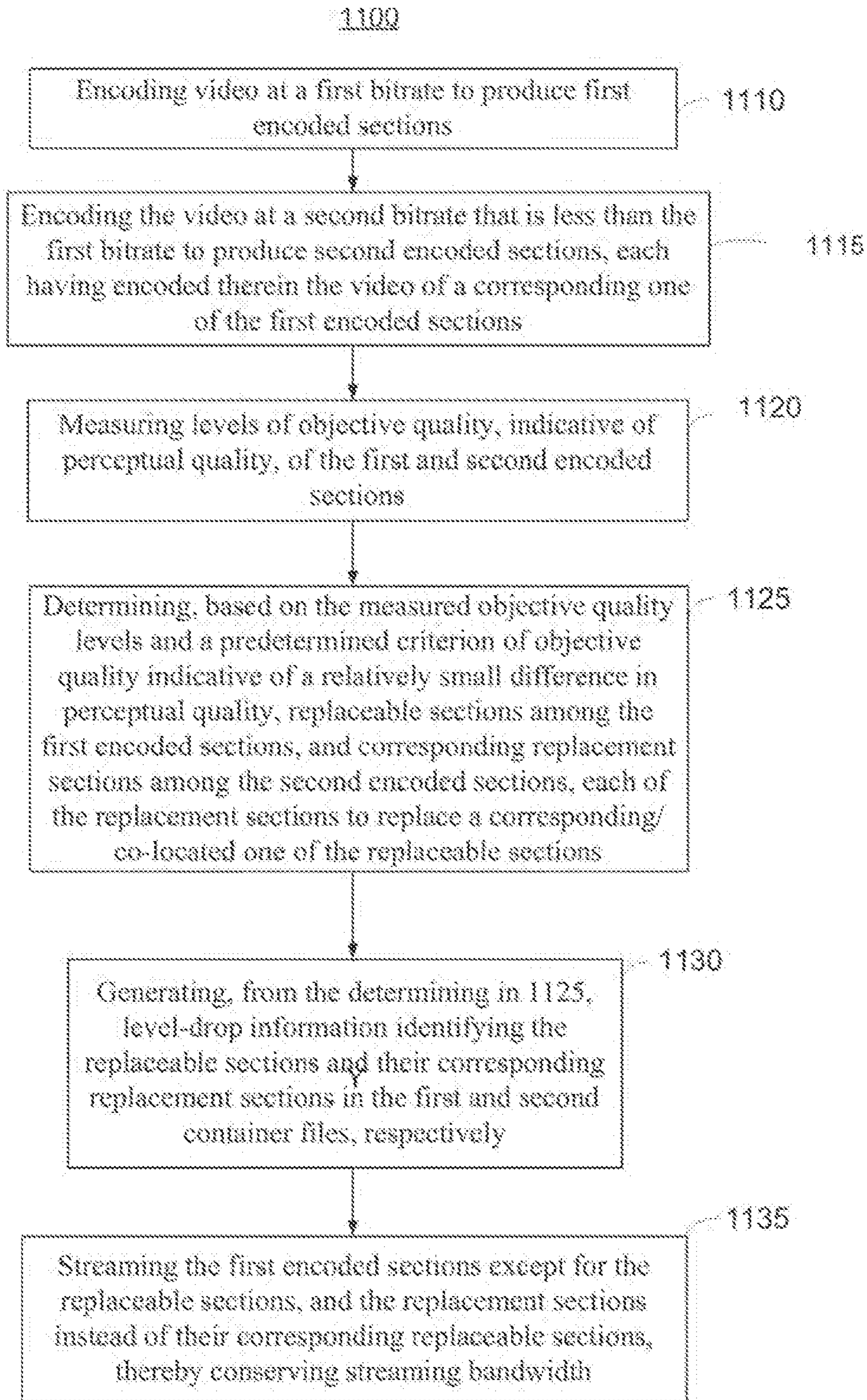

FIG. 11

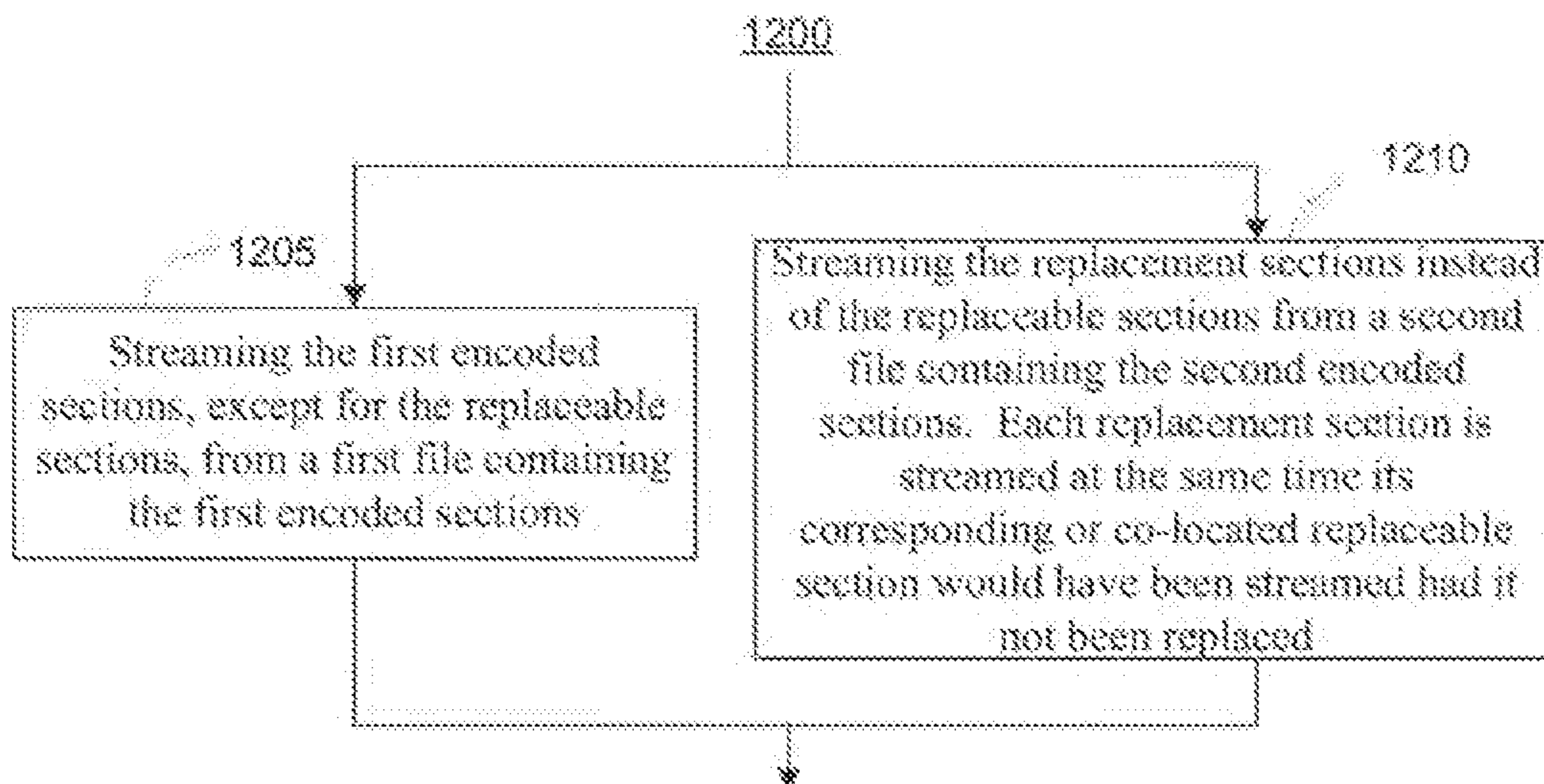

FIG. 12

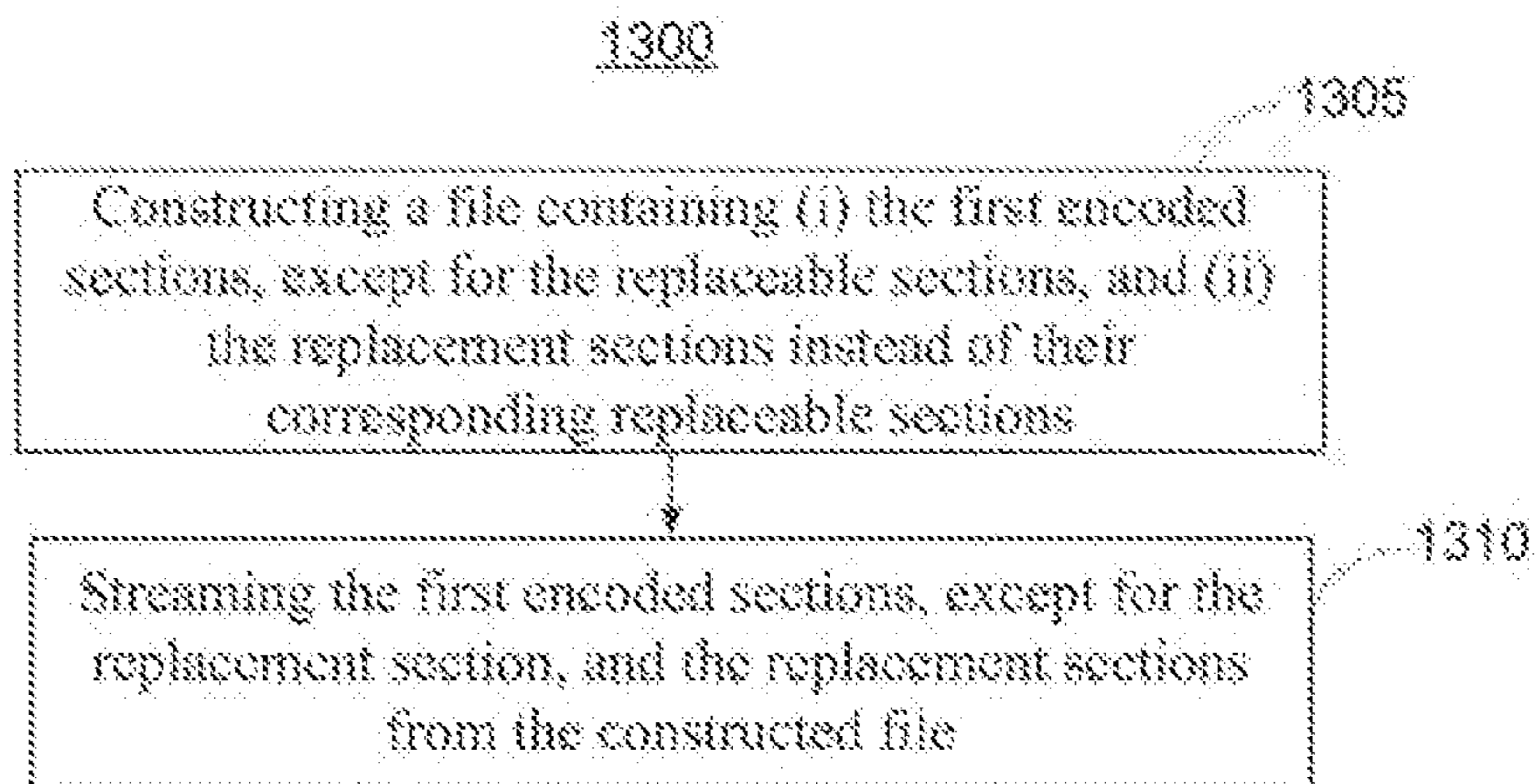

FIG. 13

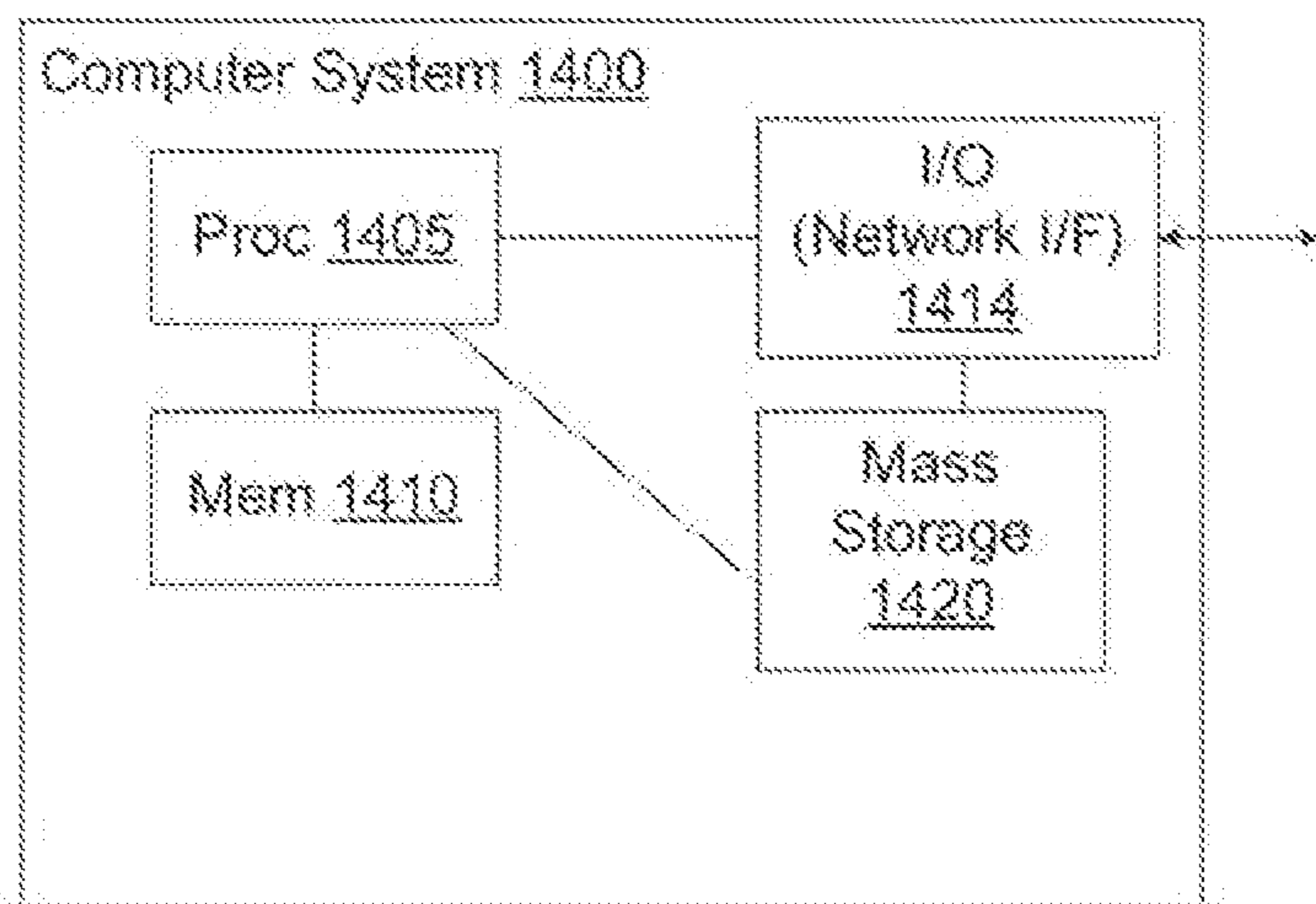

FIG. 14

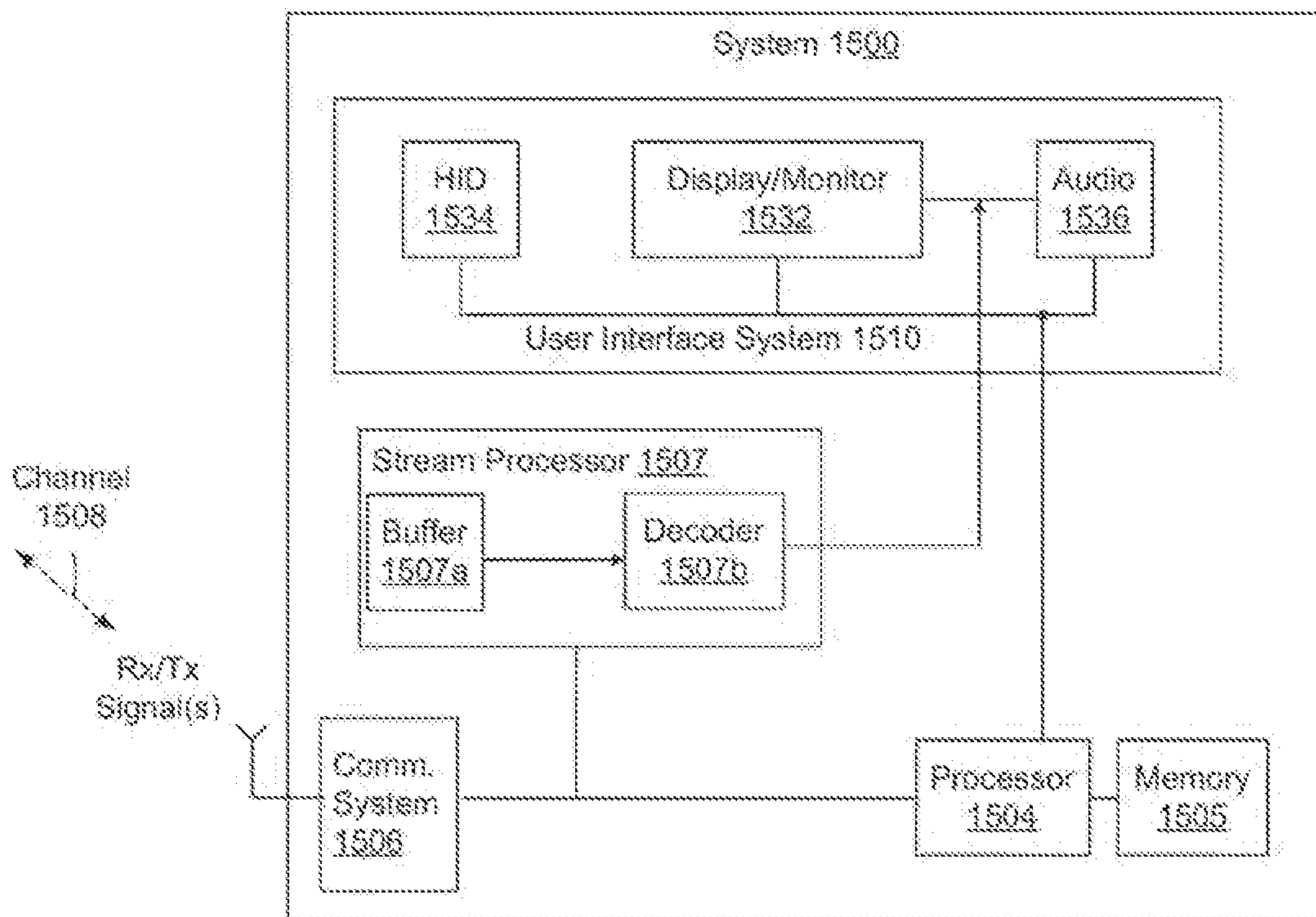

FIG. 15

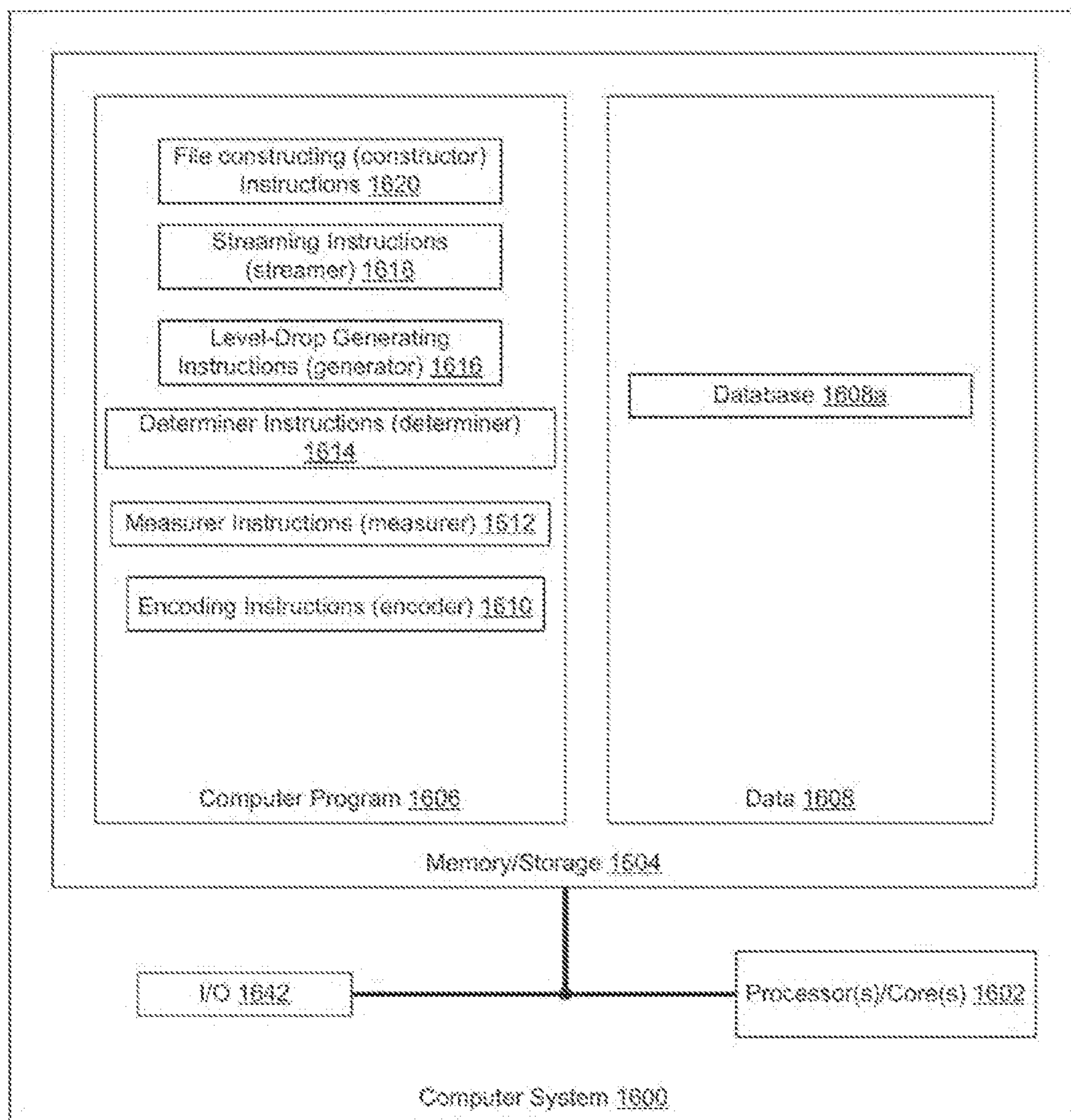

FIG. 16

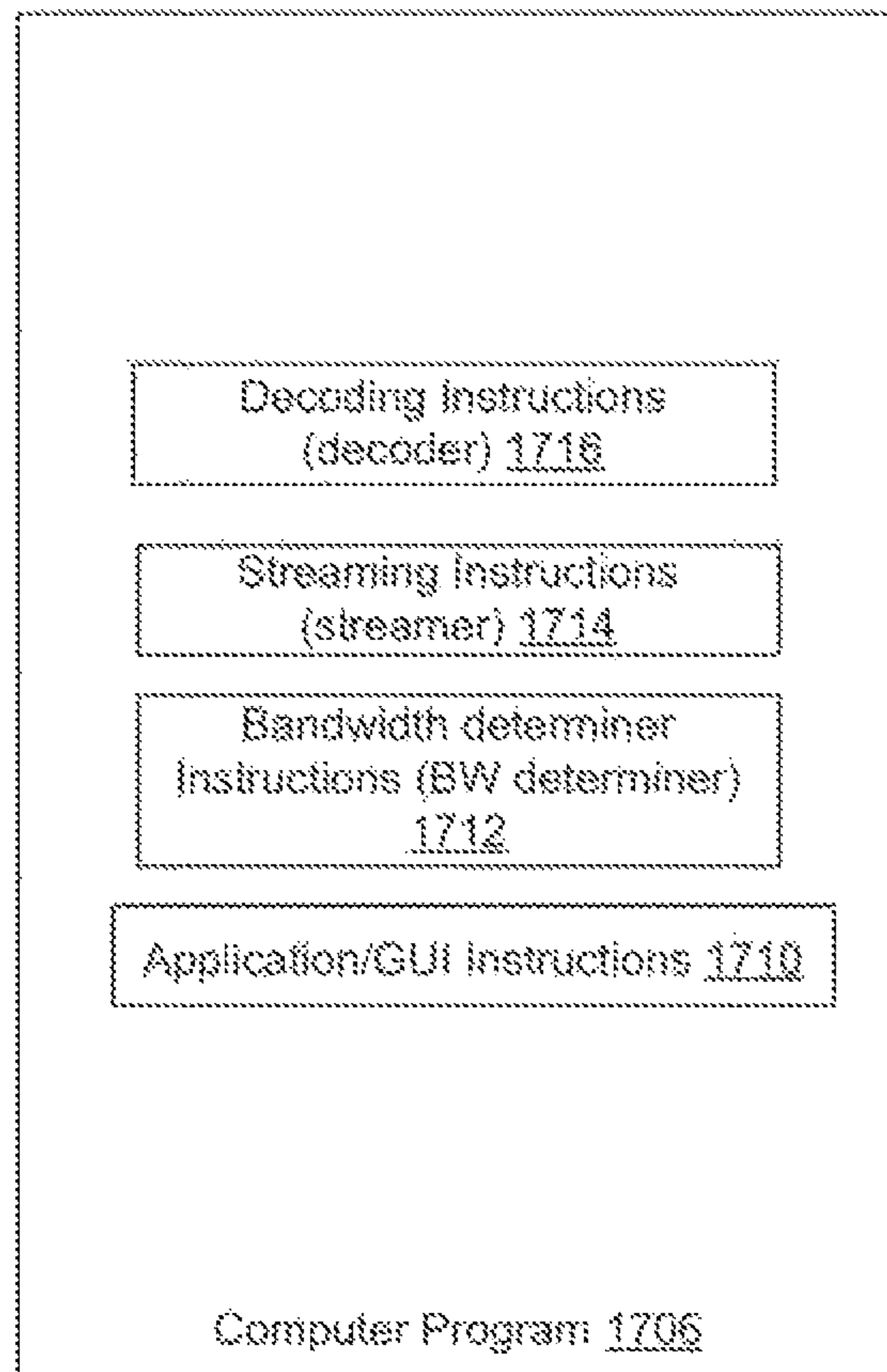

FIG. 17

**USE OF OBJECTIVE QUALITY MEASURES
OF STREAMED CONTENT TO REDUCE
STREAMING BANDWIDTH**

Matter enclosed in heavy brackets [] appears in the original patent but forms no part of this reissue specification; matter printed in italics indicates the additions made by reissue; a claim printed with strikethrough indicates that the claim was canceled, disclaimed, or held invalid by a prior post-patent action or proceeding.

*CROSS-REFERENCE TO RELATED
APPLICATIONS*

This application is a continuation reissue of application Ser. No. 15/950,950, which is an application for reissue of U.S. Pat. No. 9,313,510.

BACKGROUND

Distribution of multimedia (also referred to herein as “media” and/or “program(s)”), such as movies and the like, from network services to a client device may be achieved through adaptive bitrate streaming of the media. Typically, the media may be encoded at different bitrates and resolutions into multiple bitrate streams that are stored in the network services. Conventional adaptive bitrate streaming of media includes determining streaming conditions, e.g., an available streaming bandwidth at the client device, and then streaming a selected one of the different bitrate streams from the network services to the client device based on the determined conditions.

From the perspective of the network service, streaming media includes transmitting the media in response to requests from the client device. From the perspective of the client device, streaming media includes continuously requesting and receiving the media from the network services, and storing the received media in a buffer for subsequent presentation or playback, essentially, in near real-time. The buffered media may be presented, i.e., played back, in audio-visual form, for example.

The human visual system perceives a perceptual or subjective quality of streamed, presented media, and is able to detect small changes in the perceptual quality. The perceptual quality generally increases and decreases as the encoded bitrate of the streamed program (i.e., “streaming bitrate”) increases and decreases. Therefore, more or less available streaming bandwidth may translate to more or less perceptual quality, respectively.

Given the ever pressing need to conserve bandwidth at the client device, conventional streaming techniques tend to select a streaming bitrate deemed to be sufficiently high to meet an acceptable level of perceptual quality, based on the streaming bandwidth conditions determined at the client device, as mentioned above. This bandwidth-centric determination and selection at the client device does not take into consideration changes or variations in the content contained in the media itself over time as the media is streamed and, therefore, often results in unnecessarily high, and therefore, bandwidth-wasteful, streaming bitrates.

BRIEF DESCRIPTION OF THE
DRAWINGS/FIGURES

FIG. 1 is a block diagram of an example network environment in which adaptive streaming of multimedia (also

referred to herein as “media” and “program(s)”) from network services to a client device may be implemented.

FIG. 2 is an illustration of an example encoded video program generated by a media distributor.

FIG. 3 is an illustration of a container file that encodes a single audio stream.

FIG. 4 is an illustration of a container file that encodes multiplexed audio and video streams.

FIG. 5 is an illustration of a container file that encodes multiplexed video, audio, text, and metadata streams.

FIG. 6 is an illustration of an example of swapping-while-streaming from the container files of FIG. 2.

FIG. 7 is an illustration of an example of pre-swapped streaming using the container files of FIG. 2.

FIG. 8 is an illustration of example level-drop (or swap) information that identifies swappable, co-located clusters, as determined in cluster swapping examples of FIGS. 6 and 7.

FIG. 9 is a sequence diagram of example high-level interactions between a distributor and a client device in the network environment of FIG. 1.

FIG. 10 is a flowchart of an example method of streaming a program, which may be performed at a client device of FIG. 1.

FIG. 11 is a flowchart of an example method of adaptive streaming of programs from network services to a client device, which may be performed in a distributor of the network services.

FIG. 12 is a flowchart of a method expanding on the streaming in the method of FIG. 11, corresponding to a swapping-while-streaming embodiment, in which streaming is from multiple files.

FIG. 13 is a flowchart of a method expanding on the streaming of the method of FIG. 11, corresponding to a pre-swapped embodiment, in which streaming is from a single file constructed from multiple different files.

FIG. 14 is a block diagram of an example computer system corresponding to any network services, including a distributor in the network services.

FIG. 15 is a block diagram of an example system representing a client device.

FIG. 16 is a block diagram of a computer system configured to perform processing of media/programs and adaptive streaming.

FIG. 17 is a block diagram of an example computer program hosted in a client-side computer system (e.g., client device) similar to the computer system of FIG. 14.

In the drawings, the leftmost digit(s) of a reference number identifies the drawing in which the reference number first appears.

DETAILED DESCRIPTION

Embodiments described herein are directed to adaptive streaming of a video program from network services to a client device that utilize encoded video section swapping to reduce streaming bandwidth, while minimally impacting a perceptual/presentation quality of the streamed program at the client device. The adaptive streaming with section swapping embodiments reduce streaming bandwidth at the client device based on characteristics or properties of content in the video program, i.e., measures of objective quality indicative of perceptual quality, that change over time while the program is being streamed. More specifically, the embodiments determine swappable, corresponding/co-located sections of video encoded at different bitrates based on the measured objective quality levels of the co-located sections and the predetermined criterion of objective quality. The

swappable, co-located sections include a section encoded at a first bitrate and a section encoded at a second bitrate that is less than the first bitrate. During streaming of the video program, the section encoded at the first bitrate is replaced with the co-located section encoded at the lesser second bitrate, thereby conserving streaming bandwidth by a substantial amount approximately equally to a difference between the first and second bitrates.

Network Environment

FIG. 1 is a block diagram of an example network environment 100 in which adaptive streaming of programs from network services to a client device may be implemented. Network environment 100 includes a collection of server-side services 102 that interact and cooperate to originate, manage, and distribute, e.g., stream, programs to a user operated client device 104 over one or more networks 106, such as the Internet. Such programs include, but are not limited to, entertainment programs (e.g., television shows, movies, cartoons, news programs, etc.), educational programs (e.g., classroom video, adult education video, learning programs, etc.), and advertising programs (e.g., commercials, infomercials, or marketing content). Network services 102 communicate with each other and with client device 104 using any suitable communication protocol, such as an Internet protocol, which may include Transmission Control Protocol/Internet Protocol (TCP/IP), Hypertext Transfer Protocol (HTTP), etc.

Client device 104 may be capable of wireless and/or wired communication with networks 106. Client device 104 includes processing, storage, communication, and user interface capabilities sufficient to provide all of the client device functionality described herein. Such functionality may be provided, at least in part, by one or more applications, such as computer programs, that execute on client device 104. Applications executed on client device 104 may include a client-side application, which presents Graphical User Interfaces (GUIs) through which a user of the client device may interact with and request services from corresponding server-side applications hosted in services 102. Accordingly, under user control, client device 104 may request/select programs from services 102, stream the selected programs from the services, and then present the streamed programs, in other words, playback the streamed programs.

Network services 102 include, but are not limited to, one or more media provider(s) 112 to originate source programs, and one or more media distributor(s) 114 to encode, store, and distribute the programs to client device 104. Each of the services 102 may be implemented as one or more computer servers that execute one or more associated server-side computer program applications suited to the given service. Media providers 112, such as Netflix®, HBO®, cable networks, and so on, utilize network services 102 to manage and deliver their revenue bearing programs to client device 104. Media providers 112 download their source programs to distributor 114, which encodes, stores, and then streams the encoded programs to client device 104 when requested to do so.

Distributor 114 includes an encoder 122 and a stream manager 126. Encoder 122 may encode each program into a number of alternative streams to support adaptive bitrate streaming of the program. The alternative streams encode the same program in different ways, such as at one or more of different bitrates, one or more different resolutions, and/or one of more different frame rates. As will be described more fully below in connection with FIG. 2, each of the encoded streams is typically stored in one or more container files. Encoder 122 also generates a program index file for the

container files associated with the encoded program. Stream manager 126 manages streaming of the encoded program from the container files to client device 104 when the client device requests the program. Stream manager 126 cooperates with the requesting client device 104 to support adaptive bitrate streaming of the program from the container files to the client device.

Distributor 114 may also store auxiliary streams which contain information associated with the program streams mentioned above. The auxiliary streams are encoded at low bitrates, e.g., at bitrates of 200 kbps or much less. The auxiliary streams may include metadata synchronized in time with and descriptive of the content in associated main program streams. The metadata may include cues indicating or bracketing, e.g., commercial segments, or other non-program segments/content, such as level-drop information for encoded section swapping as will be described below, interspersed throughout the program streams. Typically, such auxiliary streams would be streamed simultaneously with their associated program streams and handled appropriately at the client device. However, the auxiliary streams may be streamed before the program streams.

As discussed above, client-side GUIs provide a user with access to services and program offerings. Such client-side GUIs typically include easily navigable program guides, and may present programs and channel selection options, program descriptions, advertisements, programming/user control options, and other typical programming features, as would be appreciated by those of ordinary skill in the relevant arts. The client-side GUIs accept user selections/requests, such as a request to view a program. In response to such GUI selections/requests, the client-side application sends appropriate requests to a counterpart server-side application residing in distributor 114, to initiate the appropriate actions among services 102 that will satisfy the client selections/requests, e.g., enable a client device to stream the selected program from the distributor for presentation to the user.

Container Files—Streaming Sources

As described above, distributor 114 encodes source programs from providers 112. To support adaptive bitrate streaming, distributor 122 may encode the source programs at multiple bitrates to produce multiple streams for each source program, as will be described more fully below in connection with FIG. 2. While streaming such encoded programs, client device 104 may switch between streams (and thus between encoded bitrates and corresponding streaming rates) according to conditions at the client device.

FIG. 2 is an illustration of an example encoded video program 200 generated by distributor 112. Encoded video program 200 includes multiple (encoded) video streams 1-4 encoded at multiple corresponding bitrates Rate 1-Rate 4. Encoded video streams 1-4 encode video at multiple video resolutions Res 1-Res 4, which may be equal to or different from each other. Encoded video program 200 includes a program stream index 204 and multiple container files 208(1)-208(4) corresponding to streams 1-4.

Program stream index 204 includes pointers 210(1)-(4), e.g., Uniform Resource Locators (URLs), to corresponding container files 208(1)-(4), and lists encoding parameters used to encode each of the streams 1-4, including, but not limited to, encoded bitrates Rate 1-Rate 4, encoding resolutions Res 1-Res 4, frame rates, and encoding techniques/standards. Exemplary, non-limiting, bitrates may range from below 125 kilo-bits-per-second (kbps) up to 15,000 kbps, or even higher, depending on the type of encoded media.

Each of container files **208** comprises sequential clusters **212** of a larger media sector (not shown in FIG. 2), and sequential blocks **214** of encoded media (which may also include audio, text, multimedia, etc., in addition to video) within each of the clusters. Each cluster **212**, and each block **214**, includes a time code TC indicating a start time for the media encoded in the blocks of that cluster, and encodes a fixed duration of media. For example, each cluster **212** of container file **208(1)** encodes two seconds of video. In other embodiments, each cluster may encode a different duration of media, which may vary from two seconds. Each cluster **212** is a self-contained unit of media that may be decoded and presented on client devices **204** without reference to any other clusters. Clusters **212** may also include successive cluster numbers identifying a streaming sequence of the clusters.

Each cluster/block **212/214** in a given one of container files **208** encodes the same content (e.g., video content) as corresponding clusters in the other ones of the container files. For example, the cluster/block indicated at A in container file **208(1)** has encoded therein the same video as that encoded in the clusters/blocks indicated at B, C, and D of container files **208(2)**, **208(3)**, and **208(4)**, respectively. Corresponding clusters/blocks are also referred to herein as “co-located” clusters/blocks because they encode the same video and share the same time code TC, i.e., they are aligned or coincide in time.

Container files may encode a single stream, such as a video stream (as depicted in FIG. 2), an audio stream, or a text stream (e.g., subtitles). Alternatively, each container file may encode multiple multiplexed streams, such as a mix of video, audio, and text streams. FIGS. 3-5 are further illustrations of diverse container files.

FIG. 3 is an illustration of a container file **300** that encodes a single audio stream.

FIG. 4 is an illustration of a container file **400** that encodes multiplexed audio and video streams.

FIG. 5 is an illustration of a container file **500** that encodes multiplexed video, audio, text, and metadata streams.

In addition, a container file may encode only a metadata stream at a relatively low bitrate.

The encoded container files depicted in FIGS. 2-5 support adaptive streaming to client device **104**. If conditions change while streaming, then client device **104** may switch between container files to stream at rates best suited to the conditions.

In embodiments: the container files may be Matroska containers based on Extensible Binary Meta Language (EBML), which is a derivative of Extensible Binary Meta Language (XML), or files encoded in accordance with the Moving Picture Experts Group (MPEG) standard; the program index may be provided in a Synchronized Multimedia Integration Language (SMIL) format; and client device **104** may implement adaptive streaming from distributor **114** over networks **106** using the HTTP protocol.

The container files described above may support adaptive streaming of encoded video programs across an available spectrum bandwidth that is divided into multiple, i.e., n , levels. Video having a predetermined video resolution for each level may be encoded at a bitrate corresponding to the bandwidth associated with the given level. For example, in DivX® Plus Streaming, by Rovi Corporation, the starting bandwidth is 125 kbps and the ending bandwidth is 8400 kbps, and the number n of bandwidth levels is eleven (11). Each bandwidth level encodes a corresponding video stream, where the maximum encoded bitrate of the video stream (according to a hypothetical reference decoder model of the video coding standard H.264) is set equal to the

bandwidth/bitrate of the given level. In DivX® Plus Streaming, the 11 levels are encoded according to 4 different video resolution levels, in the following way: mobile (2 levels), standard definition (4 levels), 720p (2 levels), and 1080p (3 levels).

Section Swapping: Objective Quality vs. Perceptual Quality

Adaptive streaming embodiments described herein take into consideration certain characteristics in the content in video programs (also referred to herein simply as “video”) to be streamed, to reduce streaming bitrates, as will now be described. The human visual system is able to detect small changes in the perceptual or presentation quality of presented video. However, perceptual quality and changes in perceptual quality are difficult to measure directly. Instead, certain characteristics or properties of encoded video, that are indicative of perceptual quality video as actually presented (i.e., once the encoded video is decoded and presented), may be determined, e.g., measured directly, in a straight forward manner. Such measured properties represent an objective quality of the video. As the content of encoded video varies across successive sections of the encoded video, and between co-located sections of encoded video in different video streams, the objective quality correspondingly varies, and may be measured to determine a level of objective quality corresponding to each of the aforementioned sections. The term “section” as used herein refers to a number of successive frames of video, including, but not limited to, multimedia audio-visual content, which may be collected into successive blocks and clusters in container files for streaming, as described above.

The difference in objective quality levels between co-located sections of encoded video (e.g., between co-located clusters from two container files that encode the same video but at different bitrates) may be used to determine a corresponding difference in the perceptual quality of the two video sections. Specifically, the difference in objective quality levels may be used to determine whether that difference is sufficiently large as to cause a visually noticeable difference in the perceptual quality of the two sections (once decoded and presented). With this in mind, there exists a criterion of objective quality (referred to as a predetermined “swap criterion” of objective quality), for the two objective quality levels, that translates to a virtually imperceptible difference in perceptual quality. Two co-located sections having objective quality levels that meet this criterion are considered interchangeable or swappable with each other for purposes of streaming to a client device because of their imperceptible or nearly imperceptible difference in perceptual quality. “Co-located” sections are also referred to herein as “corresponding” sections.

Swappable, co-located, encoded sections may be swapped to reduce streaming bandwidth in cases where co-located sections include a first section encoded at a relatively high bitrate and a (co-located) second section encoded at a relatively low bitrate. Specifically, streaming the (lower bitrate) second section instead of (i.e., in place of) its co-located (higher bitrate) first section reduces streaming bandwidth, while maintaining perceptual quality. The first section is referred to herein as a “replaceable section” and the second section that is streamed instead of the first section is referred to herein as the “replacement section.” The more often high bitrate sections are replaced with their co-located low bitrate sections while streaming, i.e., the more often bitrate swapping occurs, the more streaming bandwidth is conserved.

Measures of objective quality of a section of encoded video (e.g., of a cluster/block of encoded video) include, but are not limited to, a signal-to-noise ratio (SNR) of the section, a peak SNR (PSNR) of the section, a structural similarity index (SSIM) that measures a similarity between sections, and so on.

PSNR is a commonly used measure for assessing a quality of reconstructed video after compression (encoding). PSNR is measured on a logarithmic scale and depends on the Mean Squared Error (MSE) between an original source image and an impaired image or video frame. A higher PSNR generally indicates better quality, while a lower PSNR generally indicates poorer quality. Formulas for PSNR are given below:

$$\text{MSE} = \frac{1}{mn} \sum_{i=0}^{m-1} [I(i, j) - K(i, j)]^2$$

$$\text{PSNR} = 10 \cdot \log_{10}(\text{MAX}_i^2 / \text{MSE}_i)$$

Where: m & n are dimensions of an image; I & K are components of an image (Y , U , V); and MAX_i is a maximum possible pixel value.

Each section of encoded video may be assigned one or more scores based on the different possible objective quality measures. Multiple successive encoded sections may have their objective quality levels combined into and, therefore, associated with, a single measurement of objective quality, which may include, e.g., a mean or variance of the SNR (or PSNR) of each of the multiple sections.

A criterion of objective quality that indicates co-located sections may be swapped with little or no impact on perceptual quality—if the co-located section have levels of objective quality that each meet that criterion—may be based on one of:

- a. an absolute level of objective quality, e.g., co-located clusters are declared swappable if the PSNR of each cluster is above a threshold PSNR; and
- b. a difference between respective levels objective quality of co-located encoded sections, e.g., co-located clusters are declared swappable if a difference between their respective PSNR values is less than a certain PSNR difference threshold.

For relative criterion (b), a variable scale may be defined using as a base PSNR a highest level PSNR among encoded sections under consideration; e.g., for encoded section PSNR levels in a range of 29 dB and 31 dB, an acceptable difference value may be 1.5 dB, and for encoded section PSNR levels in a range of 27 dB and 29 dB, an acceptable PSNR difference level may be only 1 dB. The variable scale may be extended to cover all encoded section PSNR levels that are expected as part of an encoding process, and may also extend to cover other objective quality metrics such as a mean, a variance, a difference between highest and lowest PSNR levels in a cluster, or a formula combining some or all of these or other metrics. Such assignments may be altered based on the type of objective quality that is used.

Embodiments directed to adaptive streaming using section swapping described below include (i) a “swapping-while-streaming” embodiment in which swappable co-located sections from different files are swapped while streaming, and (ii) a “pre-swapped streaming” embodiment in which a single file containing pre-swapped sections is constructed from multiple encoded files before streaming is initiated, and then all of the sections in the single file,

including the pre-swapped sections, are streamed from that file. Examples of these embodiments are described below.

Swapping-While-Streaming

In swapping-while-streaming, swappable co-located sections are swapped while streaming from multiple different container files in real-time, such as from multiple container files **208** in FIG. **2**.

FIG. **6** is an illustration of an example of swapping-while-streaming from container files **208** of FIG. **2**. With reference to FIG. **6**, the example assumes the following:

- a. Separate container files **208(1)**, **208(2)**, and **208(3)** represent three levels N , $N-1$, and $N-2$, respectively, of the n levels available for, e.g., DivX® Plus Streaming;
- b. Levels N , $N-1$, and $N-2$ are each encoded at successively decreasing bitrates but may be at the same resolution. In other examples, the Levels are each encoded at successively decreasing bitrates but may be at different resolutions;
- c. Swappable, co-located clusters (including a replaceable section and its corresponding replacement section) have been determined and identified across the container files **208(1)**-**208(3)**. As described above, the swappable, co-located clusters are determined based on determined/measured objective quality levels of the clusters in the container files and a comparison of the determined/measured objective quality levels (of co-located sections) against a predetermined criterion of objective quality indicative of a minimal difference in perceptual quality; and
- d. Level N is initially selected for streaming.

Traversing left-to-right in FIG. **6**, initially, encoded sections from level N are streamed from container file **208(1)**. Encoded sections are streamed predominantly from level N . However, while the sections from Level N are streamed, replaceable (swappable) sections thereof are encountered and replaced with co-located replacement (swappable) sections from level $N-1$, or level $N-2$, as indicated at LD1, or LD2, respectively. That is, the lower level, co-located replacement sections are streamed instead of the higher level replaceable sections, resulting in conserved streaming bandwidth. Each replacement section is streamed at the same time its corresponding co-located replaceable section would have been streamed had it not been replaced, so as to maintain a proper encoded video sequence. A section swap is referred to as a “level-drop” because the source level (n) from which the replacement section is streamed is lower than the current level, e.g., in a swap, the level drops from Level N to Level $N-1$, or Level $N-2$. In swapping-while-streaming, client device **104** and distributor **114** cooperate with each other to swap sections from different container files.

Pre-Swapped Streaming

In pre-swapped streaming, a single file containing swappable sections, i.e., level-drops, is constructed from multiple files before streaming. Then, the sections in the single file, including the pre-swapped sections, are streamed from that file.

FIG. **7** is an illustration of an example of pre-swapped streaming using container files **208** of FIG. **2**. Before streaming, swappable, co-located clusters are determined and identified across levels N , $N-1$, and $N-2$, similar to the swapping-while-streaming embodiment. The determined swaps, or level-drops, are incorporated into Level N . In other words, determined and identified replaceable sections of Level N are replaced with co-located replacement sections of Levels $N-1$ and $N-2$, as identified. As a result, a new, pre-swapped Level N file is constructed that incorporates

original sections of Level N that were not indicated as replaceable, and the determined/identified replacement sections (i.e., level-drops) instead of the replaceable sections. Then, sections are streamed only from the new, pre-swapped Level N file. In pre-swapped streaming, streaming of the pre-swapped sections is transparent to client device 104, which simply requests streaming sections from the single file. The examples of FIGS. 6 and 7 may be extended over more container files at different bitrates, and thus more levels and corresponding level-drops.

Level-Drop Information

FIG. 8 is an illustration of example level-drop (or swap) information 800 that identifies swappable, co-located clusters, as determined in the cluster swapping examples of FIGS. 6 and 7. In the manner described above, and further below, distributor 114 measures objective quality levels of sections, e.g., clusters in container files 208, and then determines swappable co-located clusters between the files based on the measured objective quality levels and a predetermined swap criterion. Distributor 114 generates level-drop information 800 as records 802, 804, and 806 that identify the determined, swappable, co-located clusters in the different files. Each record identifies swappable clusters including a starting cluster and its contiguous following clusters (if any), and also blocks within clusters. Each record may include one or more of cluster/block numbers, time codes TC, locations/addresses of the clusters in the file. Level-drop information 800 includes:

- a. records 802 linked vertically to indicate determined, time-ordered, replaceable clusters among the clusters of level N, e.g., in container file 208(1);
- b. records 804 linked vertically to indicate determined, time-ordered replacement clusters among the clusters of level N-1, e.g., in container file 208(2); and
- c. records 806 to indicate a determined replacement cluster among the clusters of level N-2, e.g., in container file 208(3).

Horizontal links 810 between records indicating co-located, replaceable and replacement clusters, e.g. between Level N and Levels N-1, N-2.

Distributor 114 may embed level-drop information 800 as in container files as metadata. Alternatively, or additionally, level-drop information may be stored as an auxiliary/metadata, level-drop file that is stored and indexed separately from the container files. Therefore, in the swapping-while-streaming embodiment, level-drop information 800 may be streamed from distributor 114, to client device 104, with streamed clusters. Alternatively, level-drop information may be streamed from the auxiliary file separately from the clusters.

In the pre-swapped embodiment, distributor 114 uses level-drop information 800 to construct a single pre-swapped file and need not be streamed to client device 104. However, client device 104 does not need the level-drop information.

Server-Client Sequence Diagram

FIG. 9 is a sequence diagram of example high-level interactions 900 between distributor 114 and client device 104 in network environment 100. Interactions 900 progress in time from top-to-bottom in FIG. 9, as a sequence of phases beginning with an initialization/set-up phase 904 indicated in the top left-hand corner of FIG. 9.

During initialization/set-up phase 904, distributor 114 encodes video programs and stores the encoded video programs in container files for subsequent streaming to client device 104. Distributor 114 determines swappable co-located sections among the container files associated with each

program based on determined objective quality measures and a predetermined swap criterion for the objective quality measures of co-located clusters in different files, as discussed above. Distributor 114 embeds drop-level information, such as information 900, in the container files, or stores the information in a separate drop-level file. In the pre-swapped embodiment, distributor 114 constructs a single file for streaming using the drop-level information and the multiple container files.

During a user interaction phase 920, client device 104 presents client-side GUIs to a user. At 924, the user selects a program from the GUIs, and, in response, client device 104 sends a request for the program to distributor 114.

During a pre-streaming phase 930, in response to the client device request (at 924), at 932, the distributor 114 sends an index of URLs associated with the requested program to client device 104. In the swapping-while-streaming embodiment, distributor 114 may also send drop-level information if such information is provided in a separate file. Alternatively, distributor 114 may stream the drop-level information to client 104 in subsequent pre-streaming and streaming phases 930, 940, described below. The URLs may include a first URL directed to a program index (e.g., index 204 in FIG. 2) for the encoded program corresponding to the requested program and stored in distributor 114, and a second URL directed to a drop-level file, if available.

During streaming phase 940, streaming of the requested program from distributor 114 to client device 104 commences. Client device 104 determines a streaming bandwidth available at the client device and selects a stream from among the multi-bitrate streams, as indicated in the program index, that best matches the determined bandwidth. Client device 104 continually requests encoded stream sections from container files in distributor 114 based on the index information and the level-drop information (in the swapping-while-streaming embodiment), and receives the requested blocks from the distributor. In the swapping-while-streaming embodiment, the level-drop information may have been received during pre-streaming phase 930, may be streamed from a separate level-drop file, and/or may be embedded as records in the encoded video sections streamed during stage 940. Client device 104 buffers the received sections, decodes the buffered sections, and then presents the decoded sections. As streaming conditions change, client device 104 may switch to a new stream, i.e., request sections from another stream having a bitrate better suited to the changed conditions.

In yet another embodiment, level-drop information may be calculated dynamically at client device 104 instead of distributor 114 based on objective quality levels embedded in streamed sections. In this embodiment, distributor 114 embeds measured objective quality levels in corresponding encoded video sections, and streams the sections to the client device 104. Client device 104 calculates level-drop information based on the received objective quality levels, and performs swapping-while-streaming based on the dynamically calculated objective quality levels.

In both the swapping-while-streaming and pre-swapped embodiments, client device 104 intermittently requests replacement blocks having a lower encoded bitrate than the co-located replaceable block, which advantageously conserves streaming bandwidth at the client device. Each replacement block is streamed at the same its corresponding or co-located replaceable block would have been streamed had it not been replaced.

11

Client-Side Method

FIG. 10 is a flowchart of an example summary method 1000 of streaming a video program with swapped sections, which may be performed at client device 104.

1005 includes requesting to stream the video program.

1010 includes receiving an index to multiple files containing the video encoded at different bitrates, including at least a first bitrate and a second bitrate that is less than the first bit rate.

1015 includes determining an available streaming bandwidth.

1020 includes selecting from the received index the file encoded at the first bitrate based on the determined streaming bandwidth.

1025 includes initiating streaming of the selected file.

1030 includes streaming the selected file, including requesting successive sections of encoded video and receiving the requested sections. The swapping-while-streaming embodiment also includes receiving level-drop information in any number of ways, including streaming the level-drop information from an auxiliary file before or while streaming the encoded video, or as metadata embedded with the streamed encoded sections. The streaming in the swapping-while-streaming embodiment includes requesting encoded sections from multiple levels (e.g., levels N, N-1, and N-2, etc.), i.e., requesting swappable sections, based on the level-drop information, so as to conserve bandwidth.

Server/Network-Side Method

FIG. 11 is a flowchart of an example summary method 1100 of preparing, and adaptive streaming of, a video program with swapped sections from services 102 to client device 104, which may be performed in distributor 114.

1110 includes encoding video at a first bitrate to produce first encoded sections.

1115 includes encoding the video at a second bitrate that is less than the first bitrate to produce second encoded sections, each having encoded therein the video of a corresponding one of the first encoded sections. The first and second encoded sections may encode video that has the same resolution for each of the first and second encoded sections, or may encode video having different resolutions.

1120 includes measuring levels of objective quality, indicative of perceptual quality, of the first and second encoded sections.

1125 includes determining, based on the measured objective quality levels and a predetermined criterion of objective quality indicative of a relatively small difference in perceptual quality, swappable sections, including replaceable sections among the first encoded sections, and corresponding replacement sections among the second encoded sections, each of the replacement sections to replace a corresponding/co-located one of the replaceable sections. This can be thought of as declaring or identifying certain co-located sections as swappable sections if they meet the predetermined criterion. A result of the determining in 1125 is to identify sections in lower levels (e.g., N-1, N-2) which may be swapped with higher levels (e.g., N) with little or no impact to the subjective/perceptual quality of the video.

1130 includes generating, from the determining in 1125, level-drop information identifying the replaceable sections and their corresponding replacement sections in the first and second container files, respectively.

12

1135 includes streaming the first encoded sections except for the replaceable sections, and the replacement sections instead of their corresponding replaceable sections, thereby conserving streaming bandwidth. Each replacement section is streamed at the same time its corresponding or co-located replaceable section would have been streamed had it not been replaced.

FIG. 12 is a flowchart of a method 1200 expanding on the streaming at 1140, corresponding to the swapping-while-streaming embodiment described above, in which streaming is from multiple files.

1205 includes streaming the replacement sections instead of the replaceable sections from a second file containing the second encoded sections. Each replacement section is streamed from the second file at the same time its corresponding replaceable section would have been streamed from the first file.

1210 includes streaming the replacement sections from a second file containing the second encoded sections.

FIG. 13 is a flowchart of a method 1300 expanding on the streaming at 1140, corresponding to the pre-swapped embodiment described above, in which streaming is from a single file constructed from multiple different bitrate files.

1305 includes constructing a file containing (i) the first encoded sections, except for the replaceable sections, and (ii) the replacement sections instead of their corresponding replaceable sections.

1310 includes streaming the first encoded sections, except for the replacement section, and the replacement sections from the constructed file.

Methods and systems disclosed herein may be implemented with respect to one or more of a variety of systems including one or more consumer systems, such as described below with reference to FIGS. 13 and 14. Methods and systems disclosed herein are not, however, limited to the examples of FIGS. 13 and 14.

Prototype Example

In a prototype example, a full length feature movie (video program) (2 hours and 25 minutes) was encoded at three bitrates: 8400 kbps, 5300 kbps, and 3500 kbps utilizing a 2-pass encoding process at a resolution of 1920×816 pixels and 24 frames per second. The PSNR for each frame was determined against the original source video, and the frames were grouped into clusters of 48 frames, corresponding to 2 seconds of video frames. From here, the lowest PSNR of the frames in a cluster was determined for each cluster, and a minimum PSNR of 40 dB was chosen as the least acceptable objective quality metric for a cluster. If the minimum PSNR for a cluster at a lower level was available, that cluster was swapped for the higher level cluster. This approach was used for 8400 kbps (using 8400 kbps, 5300 kbps, and 3500 kbps), and for 5300 kbps (using 5300 kbps and 3500 kbps). The results were an accumulative bandwidth savings of 36% for an 8400 kbps stream and 18% for a 5300 kbps stream, with minimal impact on perceptual quality.

System and Computer Block Diagrams

FIG. 14 is a block diagram of an example computer system 1400 corresponding to any of services 102, including distributor 114. Computer system 1400, which may be, e.g., a server, includes one or more processors 1405, a memory 1410 in which instruction sets and databases for computer program applications are stored, a mass storage 1420 for storing, e.g., encoded programs and drop-level information,

13

and an input/output (I/O) module **1415** through which components of computer system **1400** may communicate with networks **106**.

FIG. **15** is a block diagram of an example system **1500** representing, e.g., client device **104**, and may be implemented, and configured to operate, as described in one or more examples herein.

System **1500** or portions thereof may be implemented within one or more integrated circuit dies, and may be implemented as a system-on-a-chip (SoC).

System **1500** may include one or more processors **1504** to execute client-side application programs stored in memory **1505**.

System **1500** may include a communication system **1506** to interface between processors **1504** and communication networks, such as networks **106**. Communication system **1506** may include a wired and/or wireless communication system.

System **1500** may include a stream processor **1507** to process program streams, received over channel **1508** and through communication system **1506**, for presentation at system **1500**. Stream processor **1507** includes a buffer **1507a** to buffer portions of received, streamed programs, and a decoder **1507b** to decode and decrypt the buffered programs in accordance with encoding and encryption standards, and using decryption keys. In an alternative embodiment, decoder **1507b** may be integrated with a display and graphics platform of system **1500**. Stream processor **1507** together with processors **1504** and memory **1505** represent a controller of system **1500**. This controller includes modules to perform the functions of one or more examples described herein, such as a streaming module to stream programs through communication system **1506**.

System **1500** may include a user interface system **1510**.

User interface system **1510** may include a monitor or display **1532** to display information from processor **1504**, such as client-side storefront GUIs.

User interface system **1510** may include a human interface device (HID) **1534** to provide user input to processor **1504**. HID **1534** may include, for example and without limitation, one or more of a key board, a cursor device, a touch-sensitive device, and or a motion and/or image sensor. HID **1534** may include a physical device and/or a virtual device, such as a monitor-displayed or virtual keyboard.

User interface system **1510** may include an audio system **1536** to receive and/or output audible sound.

System **1500** may correspond to, for example, a computer system, a personal communication device, and/or a television set-top box.

System **1500** may include a housing, and one or more of communication system **1506**, processors **1504**, memory **1505**, user interface system **1510**, or portions thereof may be positioned within the housing. The housing may include, without limitation, a rack-mountable housing, a desk-top housing, a lap-top housing, a notebook housing, a net-book housing, a set-top box housing, a portable housing, and/or other conventional electronic housing and/or future-developed housing. For example, communication system **1502** may be implemented to receive a digital television broadcast signal, and system **1500** may include a set-top box housing or a portable housing, such as a mobile telephone housing.

Accordingly, system **1500** may include, but is not limited to, stand-alone equipment, such as personal computers, laptops, ultrabooks, and tablets, and mobile phones and smartphones/Personal Digital Assistants (PDAs). System **150** may also represent and include a suite of interconnected devices, such a set-top box/video game console device, a

14

remote to operate such a device, and an audio-visual display and/or computer. System **1500** may also represent and include (digital video disk) DVD and Blu-ray players, and televisions.

FIG. **16** is a block diagram of a computer system **1600**, configured to perform processing of media/programs and adaptive streaming as described herein.

Computer system **1600** includes one or more computer instruction processing units and/or processor cores, illustrated here as processor **1602**, to execute computer readable instructions, also referred to herein as computer program logic.

Computer system **1600** may include memory, cache, registers, and/or storage, illustrated here as memory **1604**, which may include a non-transitory computer readable medium encoded with computer programs, illustrated here as computer program **1606**.

Memory **1604** may include data **1608** to be used by processor **1602** in executing computer program **1606**, and/or generated by processor **1602** during execution of computer program **1606**. Data **1608** includes a database **1608a** of container files and generated drop-level information for use in the methods described herein.

Computer program **1606** may include the following server-side instructions:

- a. encoding instructions **1610** to cause processor **1602** to encode programs at different bitrates into different container files;
- b. measurer instructions **1612** to measure objective quality levels of encoded video sections;
- c. determiner instructions **1614** to cause processor **1602** to determine, based on the measured objective quality levels and a predetermined criterion of objective quality indicative of a relatively small difference in perceptual quality, swappable, co-located sections among the different container files, e.g., to determine replaceable sections and corresponding replacement sections;
- d. generating instructions **1616** to generate level-drop information identifying the determined co-located swappable sections;
- e. streaming instructions **1618** to stream the encoded programs, and swap the swappable sections as appropriate in the swapping-while-streaming embodiment; and
- f. file constructing instructions **1620** to construct a file from multiple files containing pre-swapped sections in the pre-swapped embodiment.

FIG. **17** is a block diagram of an example computer program **1706** hosted in a client-side computer system similar to computer system **1600**. Computer program **1606** may include the following client-side instructions:

- a. client-side application instructions **1710** to cause a client-side processor to communicate with corresponding server-side distributors, present corresponding client-side navigable GUIs, permit a user to select programs for presentation, and present streamed programs;
- b. bandwidth determiner instructions **1712** to cause the processor to determine an available streaming bandwidth;
- c. streaming instructions **1714** to cause the processor to initiate and maintain streaming of programs. Streaming instructions **1714** include instructions to cause the processor to identify swappable co-located sections from drop-level information received from a server-side peer and to stream the identified swappable sections accordingly; and

15

d. decoding instructions 1716 to cause the processor to decode streamed programs.

Methods and systems disclosed herein may be implemented in hardware, software, firmware, and combinations thereof, including discrete and integrated circuit logic, application specific integrated circuit (ASIC) logic, and microcontrollers, and may be implemented as part of a domain-specific integrated circuit package, and/or a combination of integrated circuit packages. Software may include a computer readable medium encoded with a computer program including instructions to cause a processor to perform one or more functions in response thereto. The computer readable medium may include a transitory and/or non-transitory medium. The processor may include a general purpose instruction processor, a controller, a microcontroller, and/or other instruction-based processor.

Methods and systems are disclosed herein with the aid of functional building blocks illustrating functions, features, and relationships thereof. At least some of the boundaries of these functional building blocks have been arbitrarily defined herein for the convenience of the description. Alternate boundaries may be defined so long as the specified functions and relationships thereof are appropriately performed.

A method embodiment which may be performed at a client-side or a network/server-side comprises:

identifying

a. replaceable sections among first sections of video encoded at a first bitrate, and

b. replacement sections of the video each encoded at a bitrate that is less than the first bitrate and having encoded therein the video of a corresponding one of the replaceable sections, each replacement section and the corresponding replaceable section having respective measured levels of objective quality that meet a predetermined criterion of objective quality; and

streaming the first sections of video except for the replaceable sections, and the replacement sections instead of the corresponding replaceable sections.

The method may further comprise:

decoding the streamed first sections and the replacement sections to recover the video encoded therein; and

presenting the recovered video.

In the method, the predetermined criterion of objective quality, if met, may translate to an acceptable difference in perceptual quality levels of the video when decoded from the corresponding replaceable and replacement sections, and then presented.

In the method, the replacement sections may include:

first replacement sections encoded at a second bit rate that is less than the first bitrate; and

second replacement sections encoded at a third bitrate that is less than the second bitrate.

In the method, the streaming may include:

streaming the first sections except for the replaceable sections from a first file containing the first sections and the replaceable sections; and

streaming the replacement sections instead of the replaceable sections from a second file containing the replacement sections.

The method may further comprise:

requesting to stream the video;

receiving an index to multiple files containing the video encoded at different bitrates, including at least the first bitrate and the bitrate that is less than the first bit rate;

determining an available streaming bandwidth;

16

selecting the file encoded at the first bitrate based on the determined streaming bandwidth,

wherein

the identifying may include receiving level-drop information identifying the replaceable and replacement sections, and

the streaming may include streaming the first sections except for the replaceable sections, and the replacement sections instead of the corresponding replaceable sections, based on the identifying information.

The streaming may include receiving requests for the sections of video and transmitting the requested sections of video.

The identifying may include streaming information identifying the replaceable and replacement sections in streaming sources.

In the method, each of the measured levels of objective quality may be based on a signal to noise ratio (SNR) and the predetermined criterion may be based on a one of an absolute SNR level and a relative SNR between the measured levels of objective quality.

A computer program product embodiment corresponding to the above-recited method embodiment comprises a non-transitory computer readable medium encoded with a computer program, including instructions to cause a processor to:

identify

a. replaceable sections among first sections of video encoded at a first bitrate, and

b. replacement sections of the video each encoded at a bitrate that is less than the first bitrate and having encoded therein the video of a corresponding one of the replaceable sections, each replacement section and the corresponding replaceable section having respective measured levels of objective quality that meet a predetermined criterion of objective quality; and

stream the first sections of video except for the replaceable sections, and the replacement sections instead of the corresponding replaceable sections.

The predetermined criterion of objective quality, if met, may translate to an acceptable difference in perceptual quality levels of the video decoded from the corresponding replaceable and replacement sections, and then presented.

The replacement sections may include:

first replacement sections encoded at a second bit rate that is less than the first bitrate; and

second replacement sections encoded at a third bitrate that is less than the second bitrate.

The instruction to cause the processor to stream may include instructions to cause the processor to:

stream the first sections except for the replaceable sections from a first file containing the first sections and the replaceable sections; and

stream the replacement sections instead of the replaceable sections from a second file containing the replacement sections.

The instructions may further include instructions to cause the processor to:

request to stream the video;

receive an index to multiple files containing the video encoded at different bitrates, including at least the first bitrate and the bitrate that is less than the first bit rate;

determine an available streaming bandwidth;

select the file encoded at the first bitrate based on the determined streaming bandwidth; and

receive the information identifying the replaceable and replacement sections,

wherein

the instructions to cause the processor to identify may include instructions to cause the processor to receive level-drop information that identifies the replaceable and replacement sections, and

the instructions to cause the processor to stream may include instructions to cause the processor to stream the first sections except for the replaceable sections, and the replacement sections instead of the corresponding replaceable sections, based on the identifying information.

The instructions to cause the processor to stream may include instructions to cause the processor to receive requests for the sections of video and transmit the requested sections of video.

The instructions to cause the processor to identify may include instructions to cause the processor to stream information identifying the replaceable and replacement sections in streaming sources.

Each of the measured levels of objective quality may be based on a signal to noise ratio (SNR) and the predetermined criterion is based on a one of an absolute SNR level and a relative SNR between the measured levels of objective quality.

An apparatus embodiment corresponding to the above method and computer program product embodiments comprises:

a processor and memory configured to:

identify

- a. replaceable sections among first sections of video encoded at a first bitrate, and
- b. replacement sections of the video each encoded at a bitrate that is less than the first bitrate and having encoded therein the video of a corresponding one of the replaceable sections, each replacement section and the corresponding replaceable section having respective measured levels of objective quality that meet a predetermined criterion of objective quality; and

stream the first sections of video except for the replaceable sections, and the replacement sections instead of the corresponding replaceable sections.

The predetermined criterion of objective quality, if met, may translate to an acceptable difference in perceptual quality levels of the video decoded from the corresponding replaceable and replacement sections, and then presented.

The replacement sections may include:

first replacement sections encoded at a second bit rate that is less than the first bitrate; and

second replacement sections encoded at a third bitrate that is less than the second bitrate.

The processor and memory, configured to stream, may be configured to:

stream the first sections except for the replaceable sections from a first file containing the first sections and the replaceable sections; and

stream the replacement sections instead of the replaceable sections from a second file containing the replacement sections.

The processor and memory may be further configured to:

request to stream the video;

receive an index to multiple files containing the video encoded at different bitrates, including at least the first bitrate and the bitrate that is less than the first bit rate;

determine an available streaming bandwidth;

select the file encoded at the first bitrate based on the determined streaming bandwidth,

wherein

the processor and memory, configured to identify, may be further configured to receive level-drop information identifying the replaceable and replacement sections, and

the processor and memory, configured to stream, may be further configured to stream the first sections except for the replaceable sections, and the replacement sections instead of the corresponding replaceable sections, based on the identifying information.

The processor and memory, configured to stream, may be further configured to receive requests for the sections of video and transmit the requested sections of video.

The processor and memory, configured to identify, may be further configured to identify the replaceable and replacement sections from streamed information.

The apparatus may further comprise:

a user interface system;

a communication system to communicate with a network; and

a housing to house the processor and memory, the communication system, and the user interface system.

The communication system may include a wireless communication system; and

the housing includes a mobile hand-held housing to receive the processor and memory, the user interface system, the communication system, and a battery.

While various embodiments are disclosed herein, it should be understood that they have been presented by way of example only, and not limitation. It will be apparent to persons skilled in the relevant art that various changes in form and detail may be made therein without departing from the spirit and scope of the methods and systems disclosed herein. Thus, the breadth and scope of the claims should not be limited by any of the examples disclosed herein.

What is claimed is:

[1. A method of encoding video, the method performed by an encoding system, comprising:

encoding video at a first bitrate to produce first encoded sections using an encoding system;

encoding the video at a second bitrate that is less than the first bitrate to produce second encoded sections using the encoding system, each having encoded therein the video of a corresponding one of the first encoded sections;

measuring levels of objective quality using the encoding system, indicative of perceptual quality, of the first and second encoded sections;

determining, based on the measured objective quality levels, replaceable sections among the first encoded sections, and replacement sections among the second encoded sections using the encoding system, each to replace a corresponding one of the replaceable sections; generating identifying information that identifies the replaceable sections and their corresponding replacement sections in the first and second container files, respectively, using the encoding system;

streaming the identifying information using the encoding system; and

in response to requests from a streaming client device that are dependent on the streamed identifying information, streaming the first encoded sections except for the replaceable sections using the encoding device, and streaming the replacement sections instead of their corresponding replaceable sections at a same time as the corresponding replaceable section would have been streamed had the corresponding replaceable section not been replaced.]

[2. The method of claim 1, wherein the determining includes:

determining, using the encoding device, if corresponding first and second encoded sections have respective measured objective quality levels that each meet a predetermined criterion of objective quality; and

declaring, using the encoding device, the corresponding first and second encoded sections as corresponding replaceable and replacement sections, respectively, if the respective measured objective quality levels each meet the predetermined criterion.]

[3. The method of claim 2, wherein the predetermined criterion of objective quality is indicative of an acceptable difference in the perceptual quality levels of the corresponding replaceable and replacement sections when decoded and presented.]

[4. The method of claim 2, wherein the predetermined criterion of objective quality is one of:

a threshold level of objective quality that must be exceeded by each of the respective measured objective quality levels; and

a maximum difference between the respective measured objective quality levels that must not be exceeded.]

[5. The method of claim 1, wherein:

the measuring includes measuring a signal-to-noise ratio (SNR) as the objective quality level; and

the determining includes determining whether the measured objective quality levels meet a predetermined criterion that is based on one of an absolute objective quality level and a relative objective quality level.]

[6. The method of claim 1, further comprising:

constructing a first file containing the first encoded sections, including the replaceable sections;

constructing a second file containing the second encoded sections, including the replacement sections; and

wherein the streaming includes:

streaming the first encoded sections, except for the replaceable sections, from the first container file; and

streaming the replacement sections from the second container file.]

[7. The method of claim 1, further comprising constructing a file containing the first encoded sections, except for the replaceable sections which are replaced by their corresponding replacement sections, wherein the streaming includes streaming from the file the first encoded sections, except for the replaceable sections, and the replacement sections.]

[8. A non-transitory computer readable medium encoded with a computer program, including instructions to cause a processor to:

encode video at a first bitrate to produce first encoded sections;

encode the video at a second bitrate that is less than the first bitrate to produce second encoded sections, each having encoded therein the video of a corresponding one of the first encoded sections;

measure objective quality levels, indicative of perceptual quality levels, of the first and second encoded sections;

determine, based on the measured objective quality levels, replaceable sections among the first encoded sections, and replacement sections among the second encoded sections, each to replace a corresponding one of the replaceable sections;

generate identifying information that identifies the replaceable sections and their corresponding replacement sections in the first and second container files, respectively, using the encoding system;

stream the identifying information; and

in response to requests from a playback device that are dependent on the streamed identifying information, stream the first encoded sections except for the replaceable sections, and stream the replacement sections instead of their corresponding replaceable sections at a same time as the corresponding replaceable section would have been streamed had the corresponding replaceable section not been replaced.]

[9. The computer readable medium of claim 8, wherein the instructions to cause the processor to determine include instructions to cause the processor to:

determine if corresponding first and second encoded sections have respective measured objective quality levels that each meet a predetermined criterion of objective quality; and

declare the corresponding first and second encoded sections as corresponding replaceable and replacement sections, respectively, if the respective measured objective quality levels each meet the predetermined criterion.]

[10. The computer readable medium of claim 9, wherein the predetermined criterion of objective quality is indicative of an acceptable difference in the perceptual quality levels of the corresponding replaceable and replacement sections when decoded and presented.]

[11. The computer readable medium of claim 9, wherein the predetermined criterion of objective quality is one of:

a threshold level of objective quality that must be exceeded by each of the respective measured objective quality levels; and

a maximum difference between the respective measured objective quality levels that must not be exceeded.]

[12. The computer readable medium of claim 8, wherein: the instructions to cause the processor to measure include

instructions to cause the processor to measure a signal-to-noise ratio (SNR) as the objective quality level; and

the instructions to cause the processor to determine include instructions to cause the processor to determine whether the measured objective quality levels meet a predetermined criterion that is based on one of an absolute objective quality level and a relative objective quality level.]

[13. The computer readable medium of claim 8, wherein the instructions further include instructions to cause the processor to:

construct a first file containing the first encoded sections, including the replaceable sections;

construct a second file containing the second encoded sections, including the replacement sections; and

wherein the instructions to cause the processor to stream include instructions to cause the processor to:

stream the first encoded sections, except for the replaceable sections, from the first container file; and

stream the replacement sections from the second container file.]

[14. The computer readable medium of claim 8, further comprising constructing a file containing the first encoded sections, except for the replaceable sections which are replaced by their corresponding replacement sections, wherein the streaming includes streaming from the file the first encoded sections, except for the replaceable sections, and the replacement sections.]

[15. An apparatus, comprising:

a processor and memory configured to:

encode video at a first bitrate to produce first encoded sections, and

21

encode the video at a second bitrate that is less than the first bitrate to produce second encoded sections, each having encoded therein the video of a corresponding one of the first encoded sections;
 measure objective quality levels, indicative of perceptual quality levels, of the first and second encoded sections; determine, based on the measured objective quality levels, replaceable sections among the first encoded sections, and replacement sections among the second encoded sections, each to replace a corresponding one of the replaceable sections; and
 generate identifying information that identifies the replaceable sections and their corresponding replacement sections in the first and second container files, respectively, using the encoding system;
 stream the identifying information; and
 in response to requests from a playback device that are dependent on the streamed identifying information stream the first encoded sections except for the replaceable sections, and the replacement sections instead of their corresponding replaceable sections at a same time as the corresponding replaceable section would have been streamed had the corresponding replaceable section not been replaced.]

[16. The apparatus of claim 15, wherein the processor and memory, configured to determine, are further configured to: determine if corresponding first and second encoded sections have respective measured objective quality levels that each meet a predetermined criterion of objective quality; and
 declare the corresponding first and second encoded sections as corresponding replaceable and replacement sections, respectively, if the respective measured objective quality levels each meet the predetermined criterion.]

[17. The apparatus of claim 16, wherein the predetermined criterion of objective quality is indicative of an acceptable difference in the perceptual quality levels of the corresponding replaceable and replacement sections when decoded and presented.]

[18. The apparatus of claim 16, wherein the predetermined criterion of objective quality is one of:
 a threshold level of objective quality that must be exceeded by each of the respective measured objective quality levels; and
 a maximum difference between the respective measured objective quality levels that must not be exceeded.]

[19. The apparatus of claim 16, wherein:
 the processor and memory, configured to measure, are further configured to measure a signal-to-noise ratio (SNR) as the objective quality level; and
 the processor and memory, configured to determine, are further configured to determine whether the measured objective quality levels meet a predetermined criterion that is based on one of an absolute objective quality level and a relative objective quality level.]

[20. The apparatus of claim 16, wherein:
 the processor and memory are further configured to construct a first file containing the first encoded sections, including the replaceable sections, and
 construct a second file containing the second encoded sections, including the replacement sections; and
 the processor and memory, configured to stream, are further configured to stream the first encoded sections, except for the replaceable sections, from the first container file, and

22

stream the replacement sections from the second container file.]

[21. The apparatus of claim 16, wherein:
 the processor and memory are further configured to construct a file containing the first encoded sections, except for the replaceable sections which are replaced by their corresponding replacement sections; and
 the processor and memory, configured to stream, are further configured to stream from the file the first encoded sections, except for the replaceable sections, and the replacement sections.]

[22. The apparatus of claim 15, further comprising:
 a communication system to communicate with a network; and
 a housing to house the processor and memory, and the communication system.]

23. A method of encoding video, the method performed by an encoding system, comprising:

encoding a portion of video at a first bitrate to produce a first encoded section using an encoding system;
 encoding the same portion of video at a second bitrate that is less than the first bitrate to produce a second encoded section using the encoding system;

measuring objective quality levels using the encoding system with respect to each of the first and second encoded sections;

selecting one of the first and second encoded sections based on the measured objective quality levels of the first and second encoded sections using the encoding system;

constructing a file containing the selected one of the first and second encoded sections, wherein the file contains at least one encoded section encoded at the first bitrate and at least one encoded section encoded at the second bitrate using the encoding system;

storing a video stream comprising the file containing the selected one of the first and second encoded sections using the encoding system; and

streaming, using the encoding system, the stored video stream in response to a request from a playback device.

24. The method of claim 23, wherein the first and second sections encode video at a same resolution.

25. The method of claim 23, wherein the first and second encoded sections are each a self-contained unit of media capable of being decoded without reference to any other encoded section.

26. The method of claim 25, wherein the video stream comprises a plurality of encoded sections including the selected one of the first and second encoded sections and each of the plurality of encoded sections encodes a fixed duration of media.

27. The method of claim 26, wherein the video stream comprises a plurality of encoded sections including the selected one of the first and second encoded sections and at least some of the plurality of encoded sections encode different durations of media.

28. The method of claim 23, wherein each of the first and second encoded sections comprises a number of successive frames of video.

29. The method of claim 23, wherein a measured objective quality of a section of video is at least one measure selected from the group consisting of: a signal-to-noise ratio (SNR) of the section, a peak SNR (PSNR) of the section, and a structural similarity index (SSIM) that measures a similarity between sections.

23

30. The method of claim 23, further comprising:
 determining when the second encoded section has a
 respective measured objective quality level that meets a
 predetermined criterion for objective quality; and
 selecting the corresponding second encoded section when
 the measured objective quality level meets the prede-
 termined criterion.

31. The method of claim 30, wherein the predetermined
 criterion of objective quality is indicative of an acceptable
 difference in the perceptual quality levels of the correspond-
 ing first and second sections when decoded and presented.

32. The method of claim 30, wherein the measuring
 includes measuring a signal-to-noise ratio (SNR) as the
 objective quality level; and the determining includes deter-
 mining whether the measured objective quality level meet a
 predetermined criterion that is based on one of an absolute
 objective quality level and a relative objective quality level.

33. A method of encoding video, the method performed by
 an encoding system, comprising:

encoding a portion of video at a first bitrate to produce a
 first encoded section using an encoding system, where
 the first encoded section is a self-contained unit of
 media capable of being decoded without reference to
 any other encoded section;

encoding the same portion of video at a second bitrate
 that is less than the first bitrate to produce a second
 encoded section using the encoding system, where the
 second encoded section is a self-contained unit of

24

media capable of being decoded without reference to
 any other encoded section;

measuring objective quality levels with respect to each of
 the first and second encoded sections using the encod-
 ing system;

determining when the second encoded section has a
 respective measured objective quality level that meets a
 predetermined criterion for objective quality using the
 encoding system;

selecting one of the first and second encoded sections
 based on the measured objective quality levels of the
 first and second encoded sections using the encoding
 system, where the second encoded section is selected
 when the measured objective quality level of the second
 encoded section meets the predetermined criterion for
 objective quality;

constructing a file containing the selected one of the first
 and second encoded sections using the encoding sys-
 tem, wherein the file contains at least one encoded
 section encoded at the first bitrate and at least one
 encoded section encoded at the second bitrate;

storing a video stream comprising the file containing the
 selected one of the first and second encoded sections
 using the encoding system; and

streaming the stored video stream in response to a request
 from a playback device using the encoding system.

* * * * *