

US00RE49595E

(19) **United States**  
(12) **Reissued Patent**  
**Noh**

(10) **Patent Number:** **US RE49,595 E**  
(45) **Date of Reissued Patent:** **Aug. 1, 2023**

(54) **TRANSMISSION OF UPLINK SOUNDING REFERENCE SIGNAL**

(71) Applicant: **KT CORPORATION**, Gyeonggi-do (KR)

(72) Inventor: **Min Seok Noh**, Seoul (KR)

(73) Assignee: **KT CORPORATION**, Gyeonggi-do (KR)

(21) Appl. No.: **17/089,208**

(22) Filed: **Nov. 4, 2020**

**Related U.S. Patent Documents**

Reissue of:

(64) Patent No.: **10,154,497**  
Issued: **Dec. 11, 2018**  
Appl. No.: **13/913,648**  
Filed: **Jun. 10, 2013**

(30) **Foreign Application Priority Data**

Jun. 11, 2012 (KR) ..... 10-2012-0062278  
Aug. 31, 2012 (KR) ..... 10-2012-0096443  
Dec. 6, 2012 (KR) ..... 10-2012-0141262

(51) **Int. Cl.**

**H04W 72/04** (2023.01)  
**H04L 5/00** (2006.01)

(Continued)

(52) **U.S. Cl.**

CPC ..... **H04L 27/2613** (2013.01); **H04L 5/0035** (2013.01); **H04L 5/0048** (2013.01);

(Continued)

(58) **Field of Classification Search**

CPC ... H04L 5/0048; H04L 5/0053; H04L 5/0073;  
H04L 5/0091; H04L 27/2613;

(Continued)

(56) **References Cited**

U.S. PATENT DOCUMENTS

9,426,818 B2 8/2016 Lee et al.  
2011/0090862 A1 4/2011 Liang et al.

(Continued)

FOREIGN PATENT DOCUMENTS

JP 2013-236289 A 11/2013  
KR 10-2011-0048421 A 5/2011

(Continued)

OTHER PUBLICATIONS

3GPP TR 36.819 V11.0.0, "3rd Generation Partnership Project; Technical Specification Group Radio Access Network; Coordinated multi-point operation for LTE physical layer aspects (Release 11)", Sep. 27, 2011, pp. 1-68, 3GPP, France.

(Continued)

*Primary Examiner* — Robert L Nasser

(74) *Attorney, Agent, or Firm* — IP Legal Services, LLC

(57) **ABSTRACT**

Provided are methods for transmission of a sounding reference signal (SRS) being independent of or separated from an uplink channel. The method may include receiving UE-specific configuration information including an uplink reference signal identity from the first transmission/reception point, determining the second transmission/reception point indicated by the uplink reference signal identity included in the received UE-specific configuration information as an uplink channel reception entity, transmitting the uplink channel to the determined second transmission/reception point, using the uplink reference signal identity, generating an SRS, using the physical cell identity of the first transmission/reception point, determining the first transmission/reception point as an SRS reception entity, and transmitting

(Continued)

100

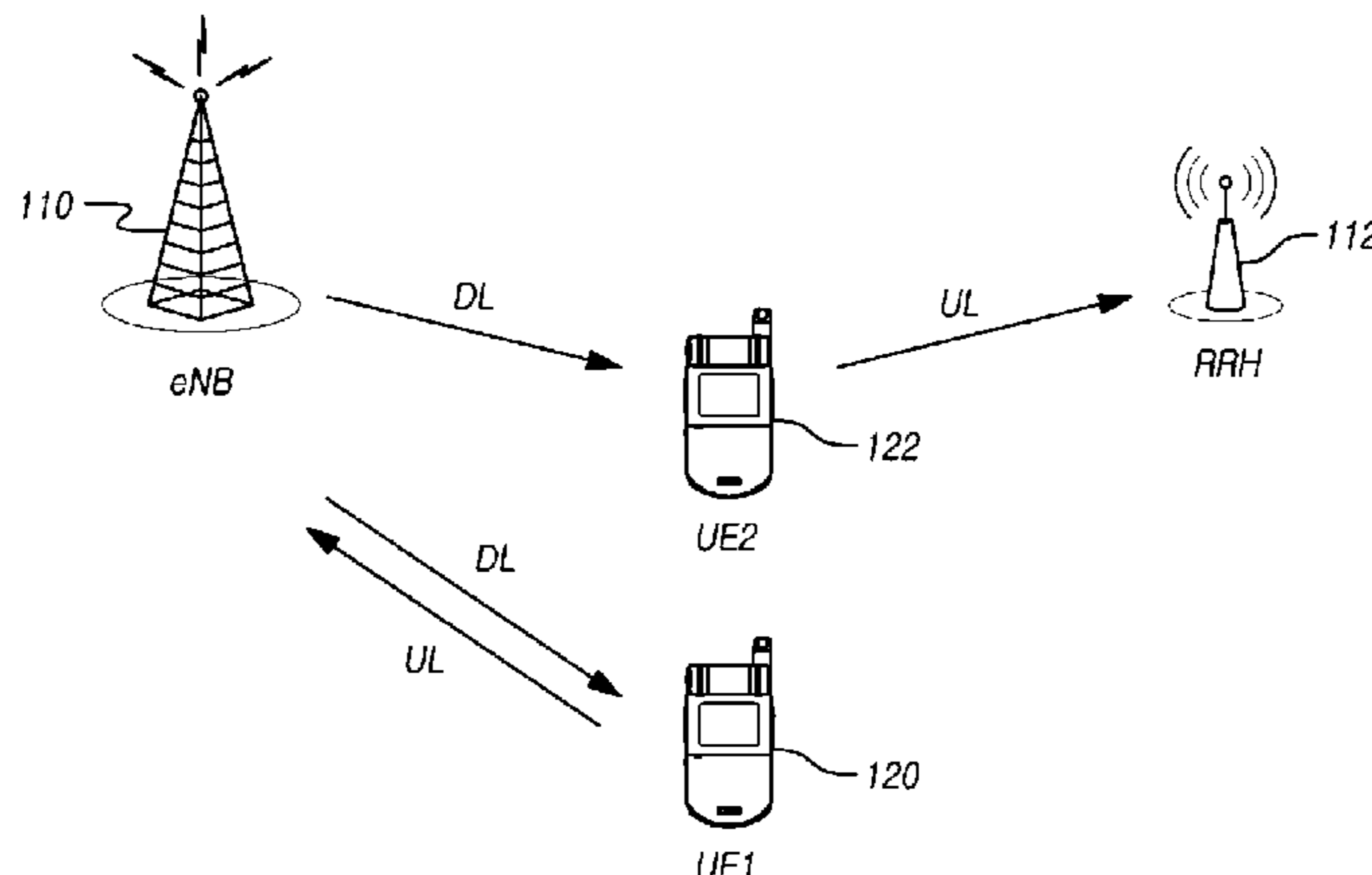

the generated SRS to the determined first transmission/reception point indicated by the physical cell identity.

**10 Claims, 38 Drawing Sheets**

- (51) **Int. Cl.**  
*H04L 27/26* (2006.01)  
*H04W 72/51* (2023.01)  
*H04W 72/12* (2023.01)
- (52) **U.S. Cl.**  
 CPC ..... *H04L 5/0053* (2013.01); *H04W 72/51* (2023.01); *H04W 72/12* (2013.01)
- (58) **Field of Classification Search**  
 CPC ..... H04L 5/001; H04L 5/0035; H04W 84/12; H04W 48/16; H04W 72/12; H04W 72/048; H04W 74/085
- See application file for complete search history.

(56) **References Cited**

U.S. PATENT DOCUMENTS

2011/0098054	A1	4/2011	Gorokhov et al.
2011/0249581	A1	10/2011	Jen
2011/0249639	A1	10/2011	Jen
2011/0249648	A1	10/2011	Jen
2011/0294529	A1	12/2011	Luo et al.
2011/0312316	A1*	12/2011	Baldemair ..... H04L 5/001 455/422.1
2012/0051265	A1*	3/2012	Shen ..... H04L 5/0035 370/254
2012/0051319	A1*	3/2012	Kwon ..... H04W 72/0406 370/329
2012/0093119	A1*	4/2012	Kim ..... H04L 27/2613 370/329
2012/0113950	A1	5/2012	Skov et al.
2012/0129561	A1	5/2012	Peng et al.
2012/0140660	A1	6/2012	Kang et al.
2012/0213190	A1	8/2012	Yoon et al.
2012/0236741	A1*	9/2012	Xu ..... H04B 7/024 370/252
2012/0287799	A1	11/2012	Chen et al.
2012/0300743	A1	11/2012	Kim et al.
2013/0021986	A1	1/2013	Bhattad et al.
2013/0077571	A1*	3/2013	Papasakellariou .. H04W 52/325 370/328
2013/0078913	A1	3/2013	Lee et al.
2013/0114523	A1*	5/2013	Chatterjee ..... H04J 11/0053 370/329
2013/0242895	A1*	9/2013	Chen ..... H04L 5/0051 370/329

2014/0295909	A1*	10/2014	Ouchi ..... H04W 52/242 455/522
2014/0376356	A1	12/2014	Park et al.
2014/0376484	A1	12/2014	Park et al.
2015/0023270	A1	1/2015	Park et al.
2015/0029968	A1	1/2015	Park et al.
2015/0029969	A1	1/2015	Park et al.
2015/0036607	A1	2/2015	Park et al.
2015/0085787	A1	3/2015	Ouchi

FOREIGN PATENT DOCUMENTS

KR	10-2012-0023794	A	3/2012	
WO	2010/147411	A2	12/2010	
WO	2011/009486	A1	1/2011	
WO	2011/099695	A2	8/2011	
WO	2011/152685	A2	12/2011	
WO	2012/036704	A1	3/2012	
WO	2013/125840	A1	8/2013	
WO	2013/125845	A1	8/2013	
WO	WO 2013/125840	*	8/2013	..... H04L 1/00

OTHER PUBLICATIONS

European Patent Office, European Search Report of European Patent Application No. 13804562.0, dated Jan. 5, 2016.

Korean Intellectual Property Office, International Search Report for International Application No. PCT/KR2013/005028, dated Sep. 24, 2013.

Korean Intellectual Property Office, Written Opinion of the International Searching Authority for International Application No. PCT/KR2013/005028, dated Sep. 24, 2013.

Ericsson et al., "Potential Enhancements for SRS", R1-114255, 3GPP TSG RAN WG1 Meeting #66bis, San Francisco, USA, Nov. 14-18, 2011, pp. 1-7.

Intel Corporation, "CSI-RS configuration/reconfiguration in distributed RRH systems", R1-111593, 3GPP TSG RAN WG1 Meeting #65, Barcelona, Spain, May 9-13, 2011, pp. 1-3.

Qualcomm Incorporated, "On the standardization impact of UL CoMP operation", R1-113389, 3GPP TSG RAN WG1 Meeting #66bis, Zhuhai, China, Oct. 10-14, 2011, pp. 1-2.

3GPP, "3rd Generation Partnership Project; Technical Specification Group Radio Access Network; Evolved Universal Terrestrial Radio Access (E-UTRA); Physical layer procedures (Release 10)", 3GPP TS 36.213 V10.5.0, Mar. 2012, pp. 1-125.

3GPP, "3rd Generation Partnership Project; Technical Specification Group Radio Access Network; Evolved Universal Terrestrial Radio Access (E-UTRA); Physical Channels and Modulation (Release 10)", 3GPP TS 36.211 V10.4.0, Dec. 2011, pp. 1-101.

KDDI, "SRS Enhancements for UL CoMP", R1-122533, 3GPP TSG RAN WG1 Meeting #69, Prague, Czech Republic, May 21-26, 2012, pp. 1-5.

\* cited by examiner

FIG. 1

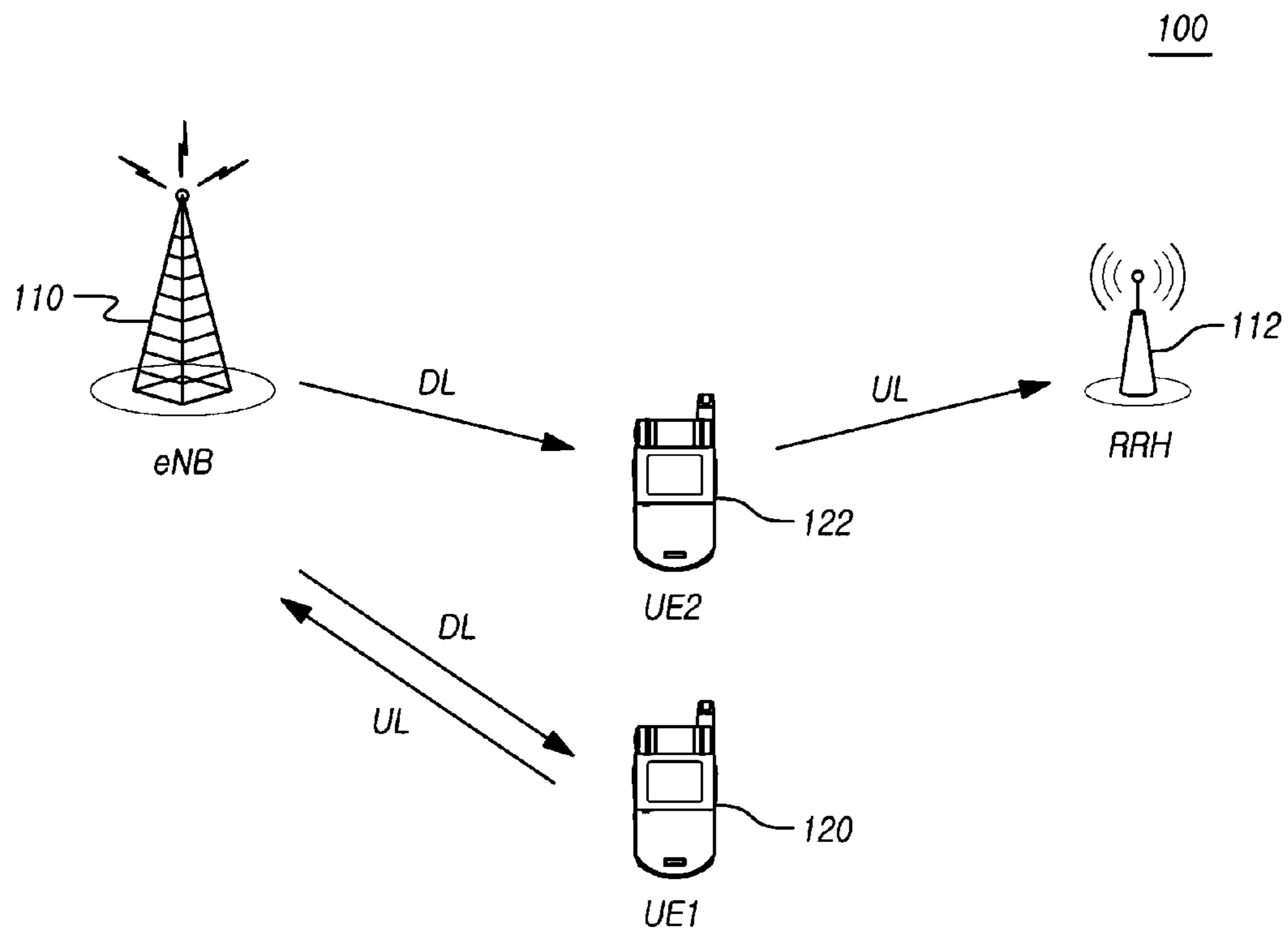

FIG. 2

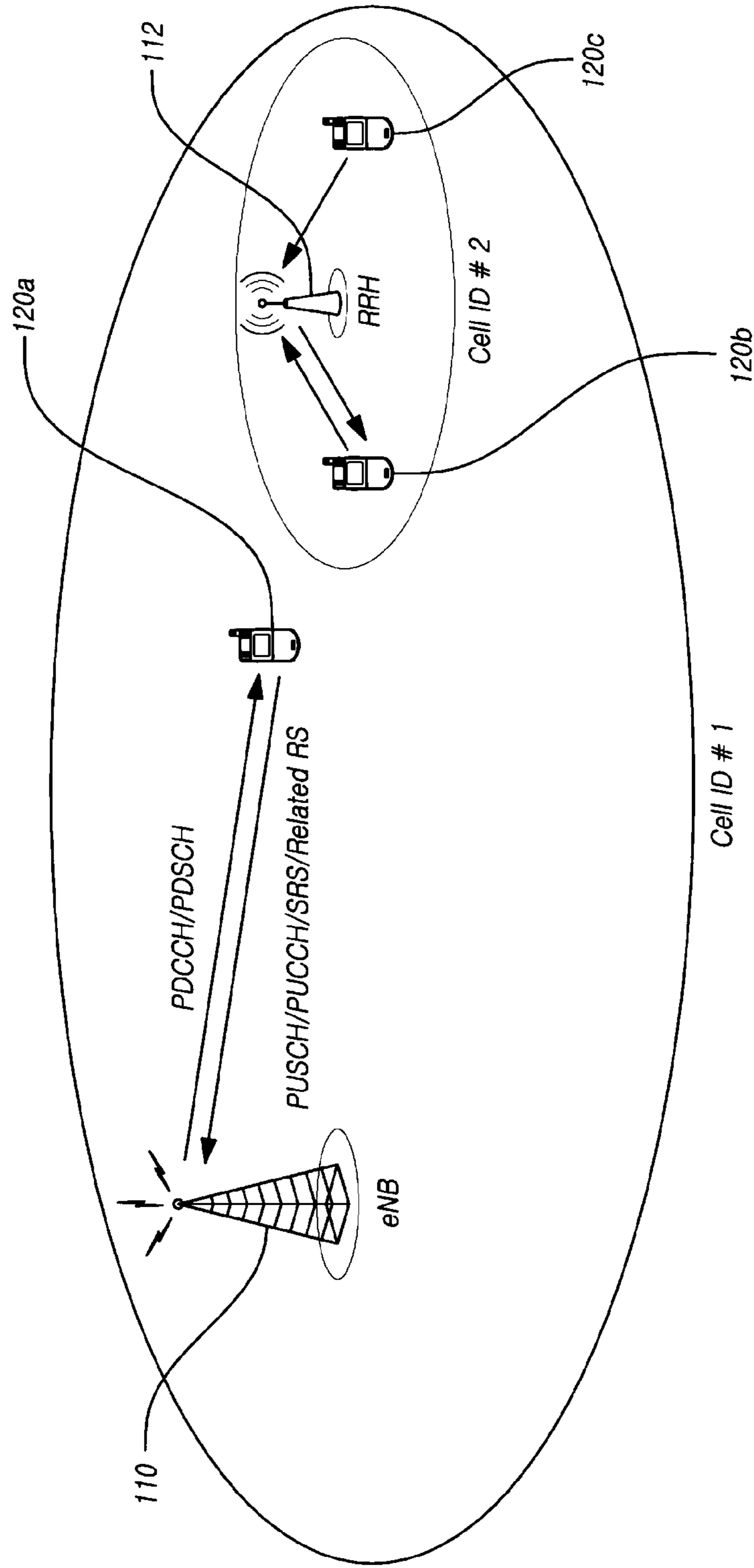

FIG. 3

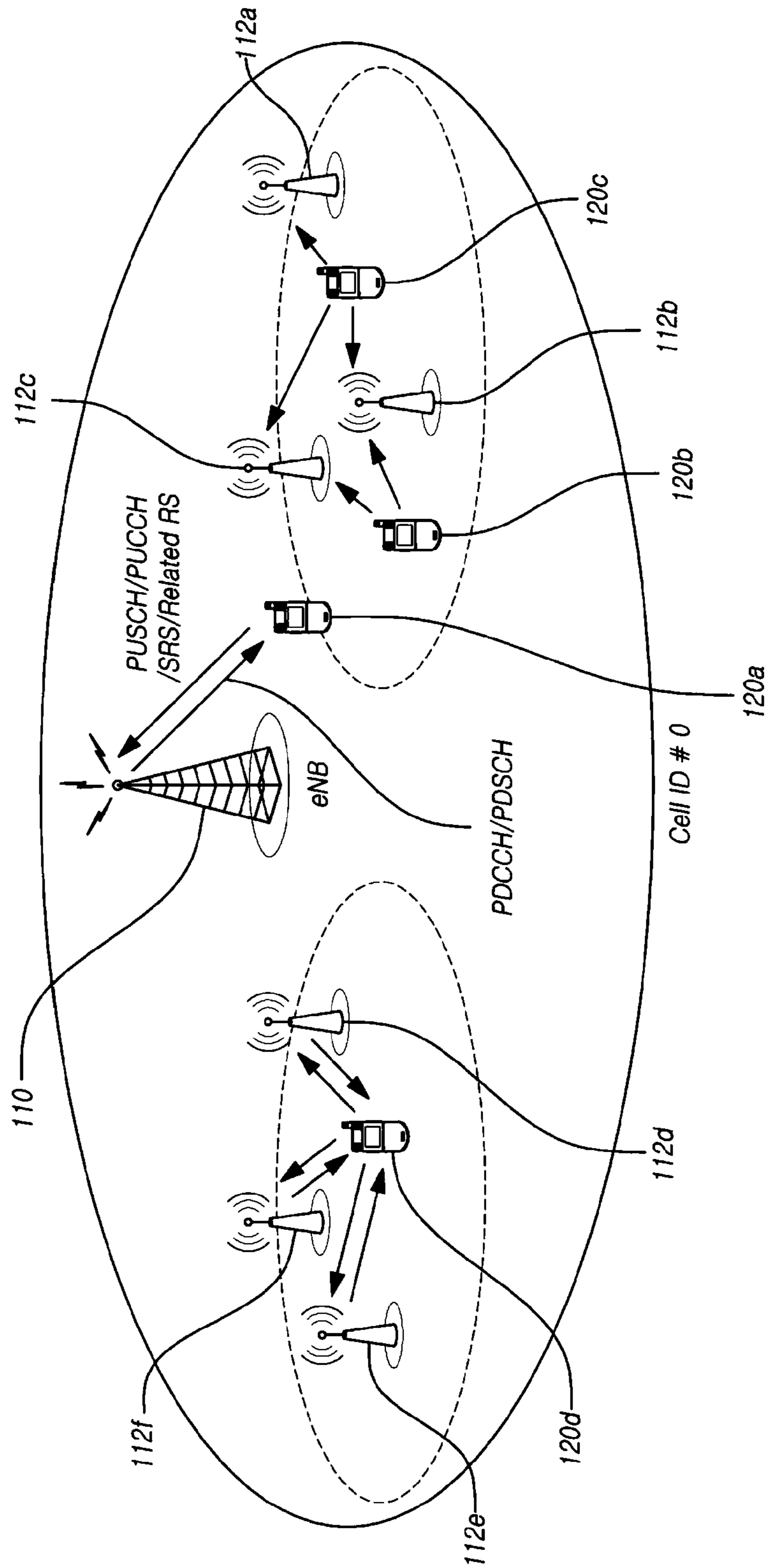

FIG. 4

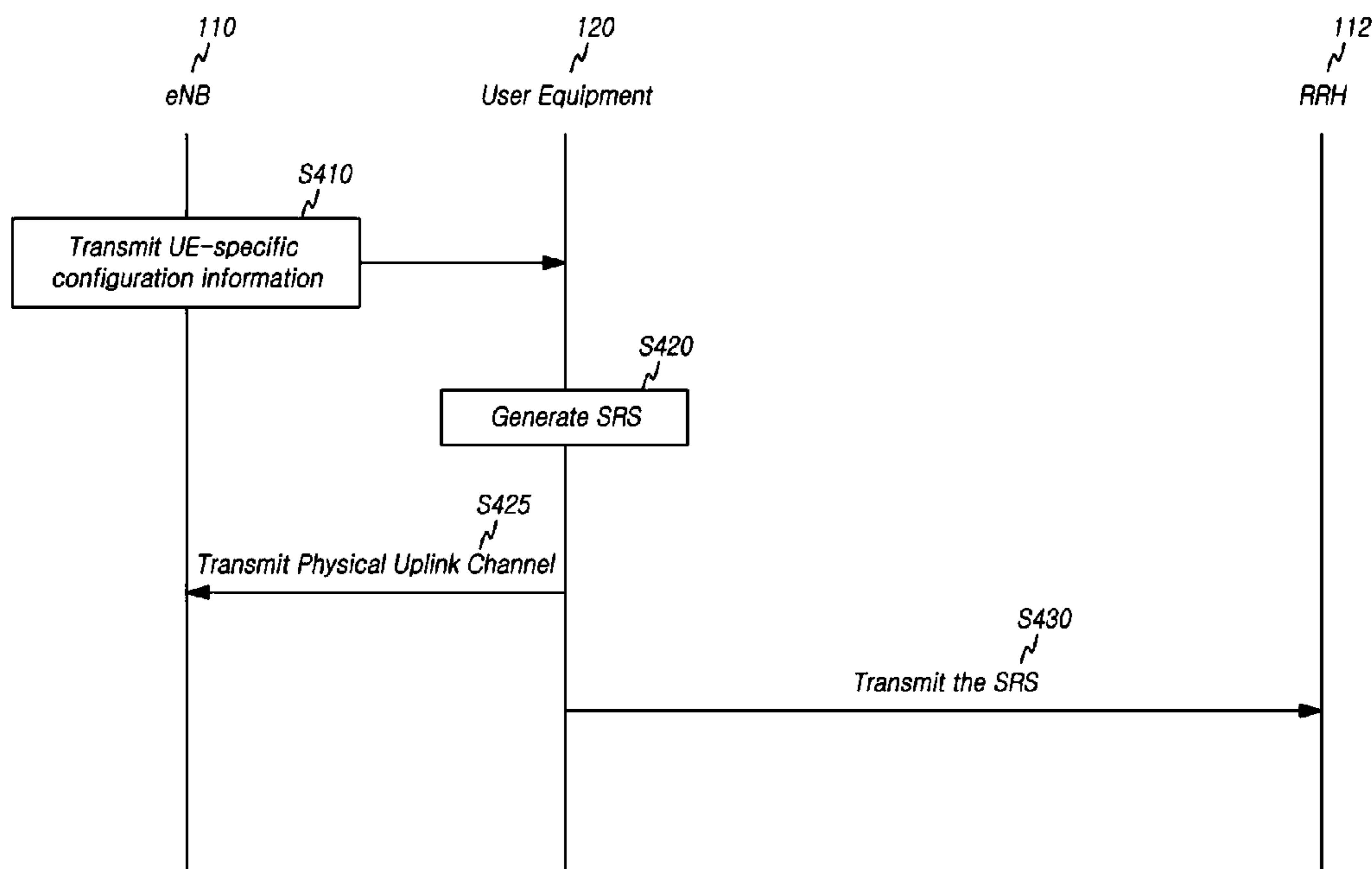

FIG. 5

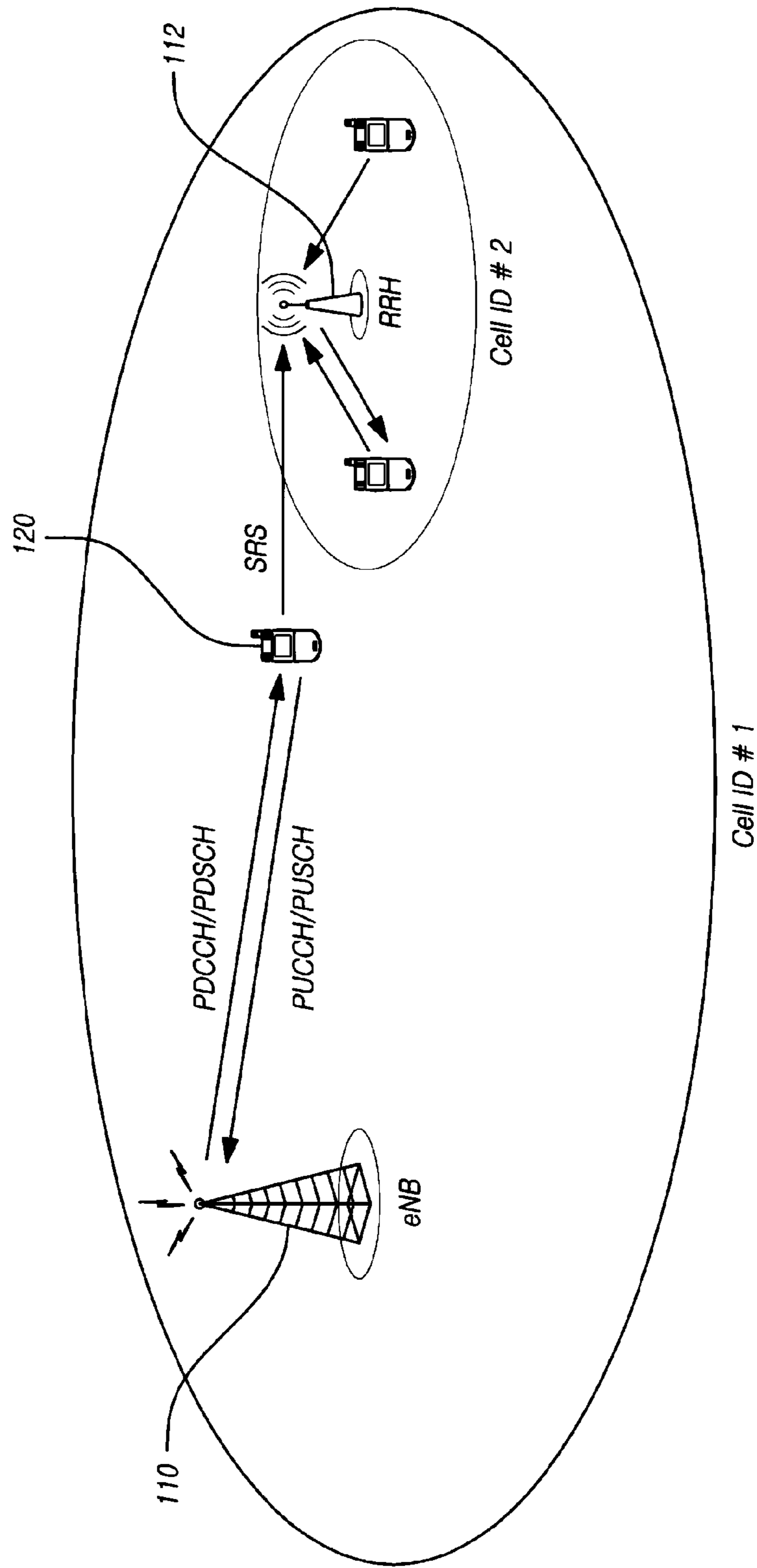

FIG. 6

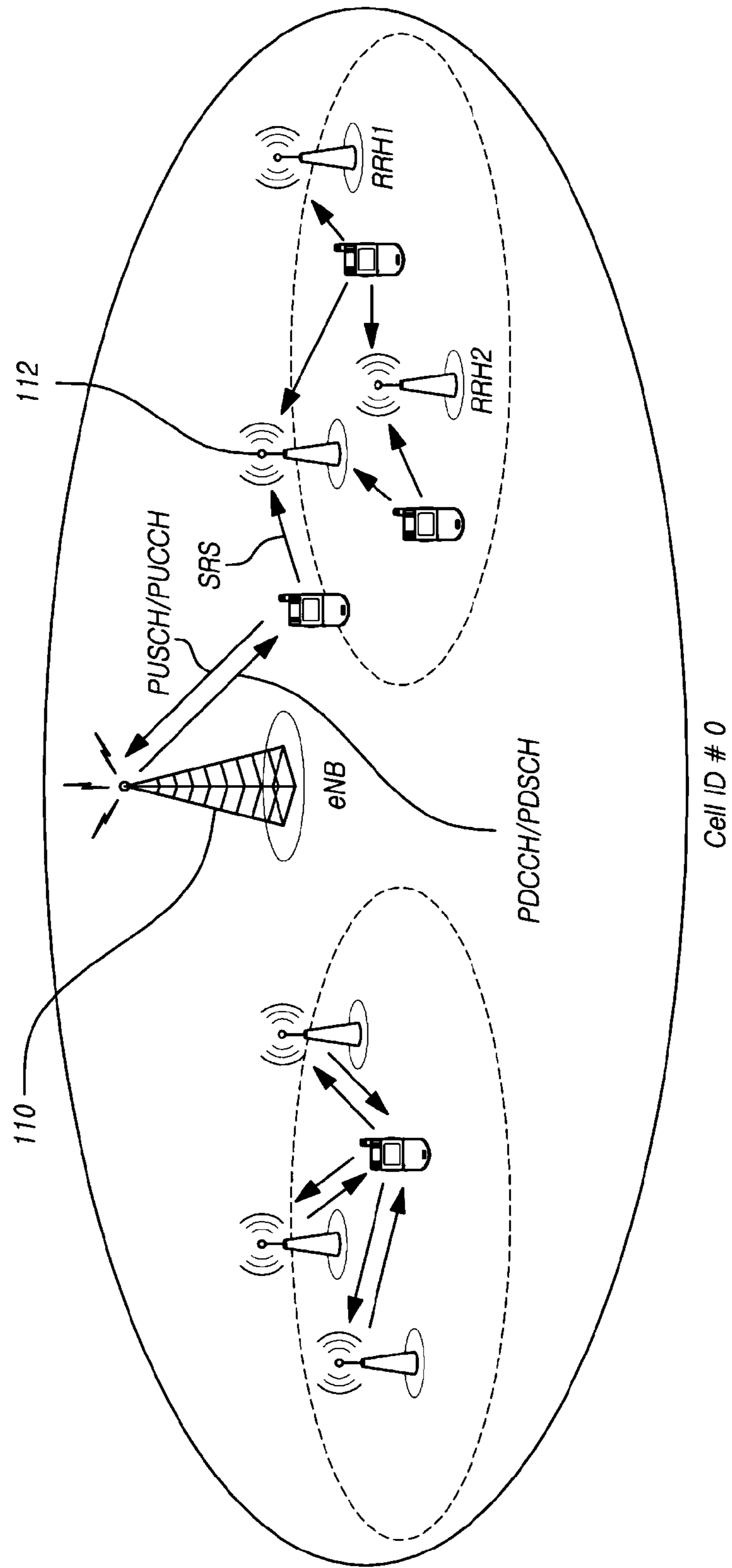



FIG. 7

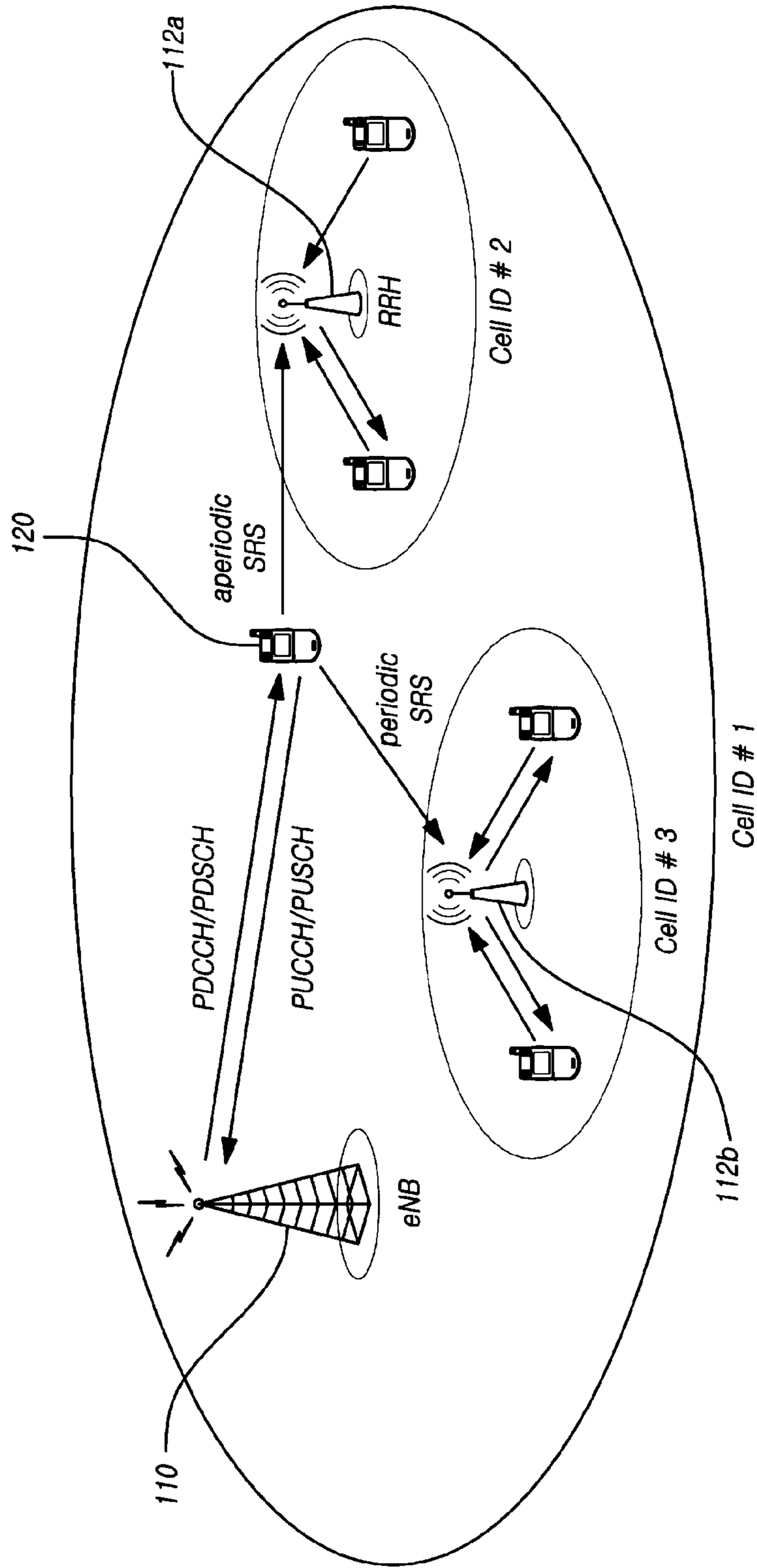

FIG. 8

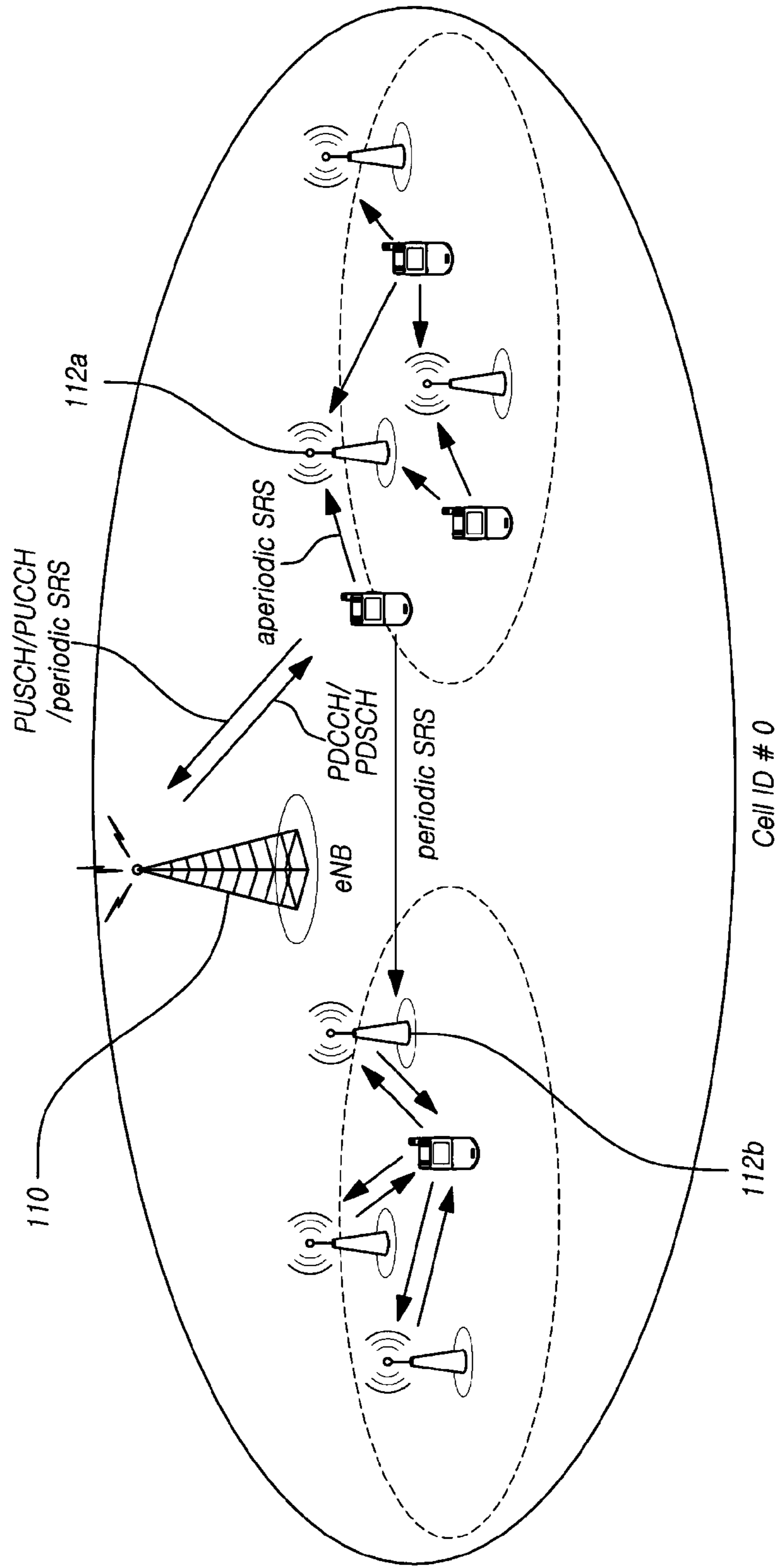

FIG. 9

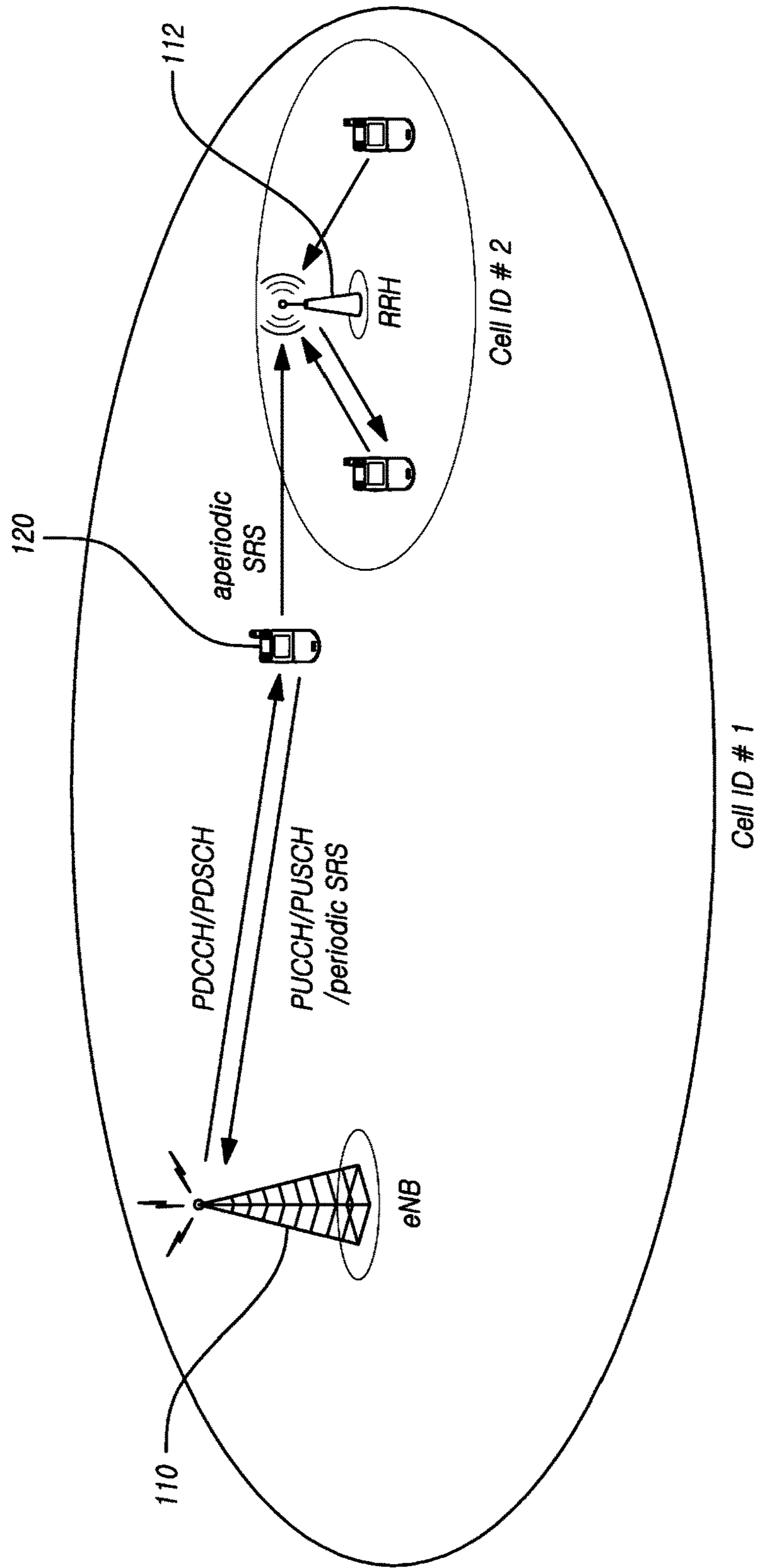

FIG. 10

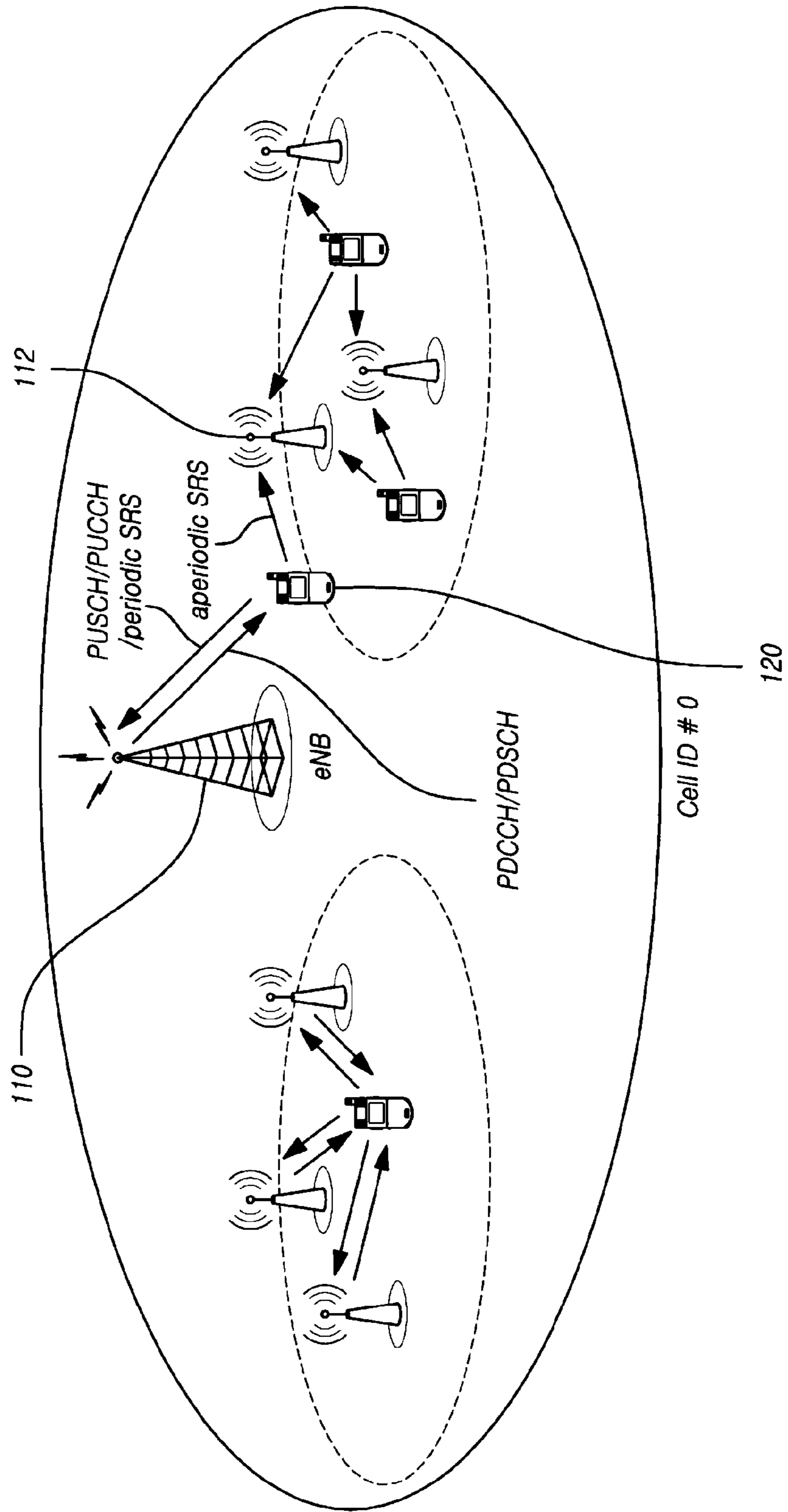

FIG. 11

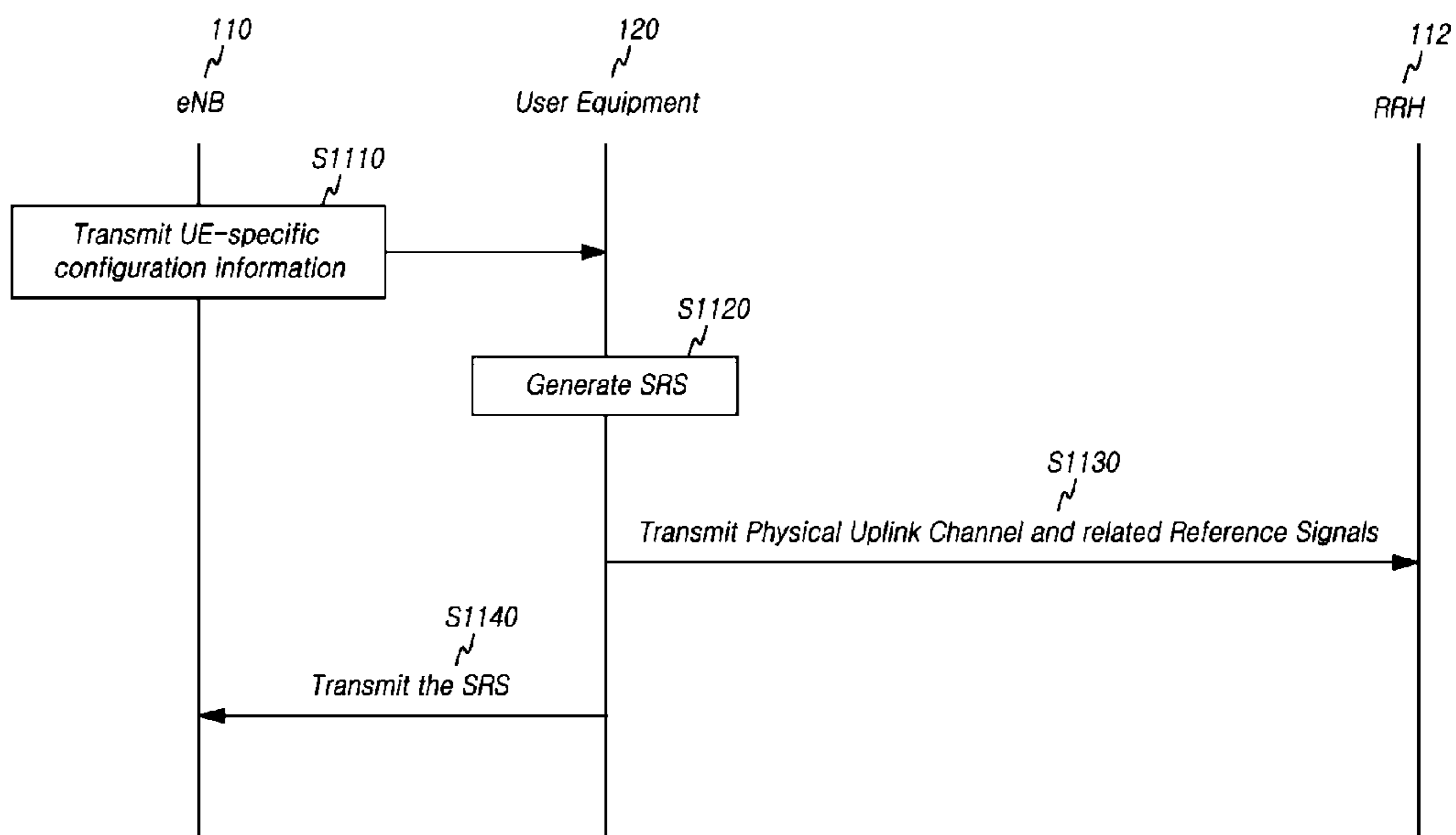

FIG. 12

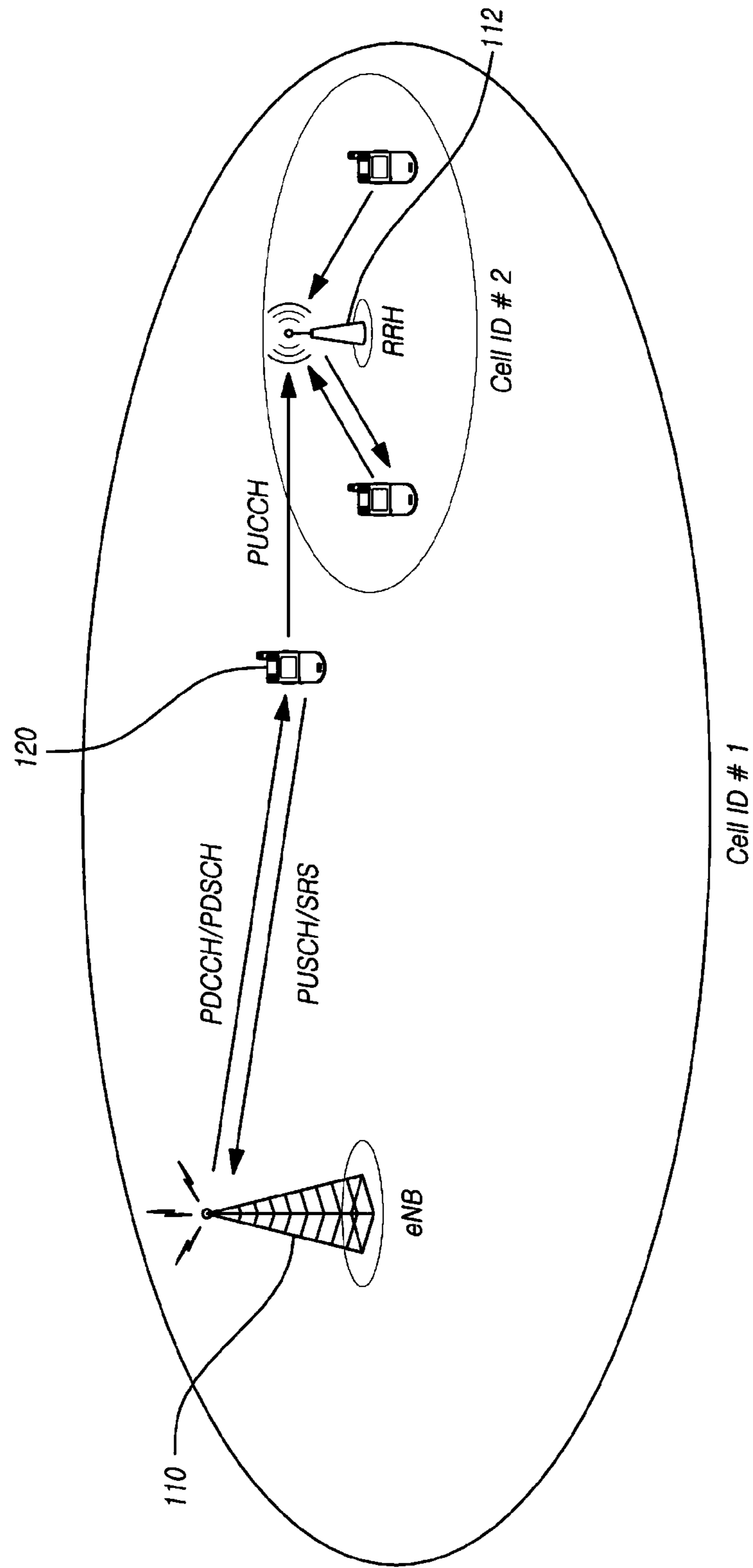

FIG. 13

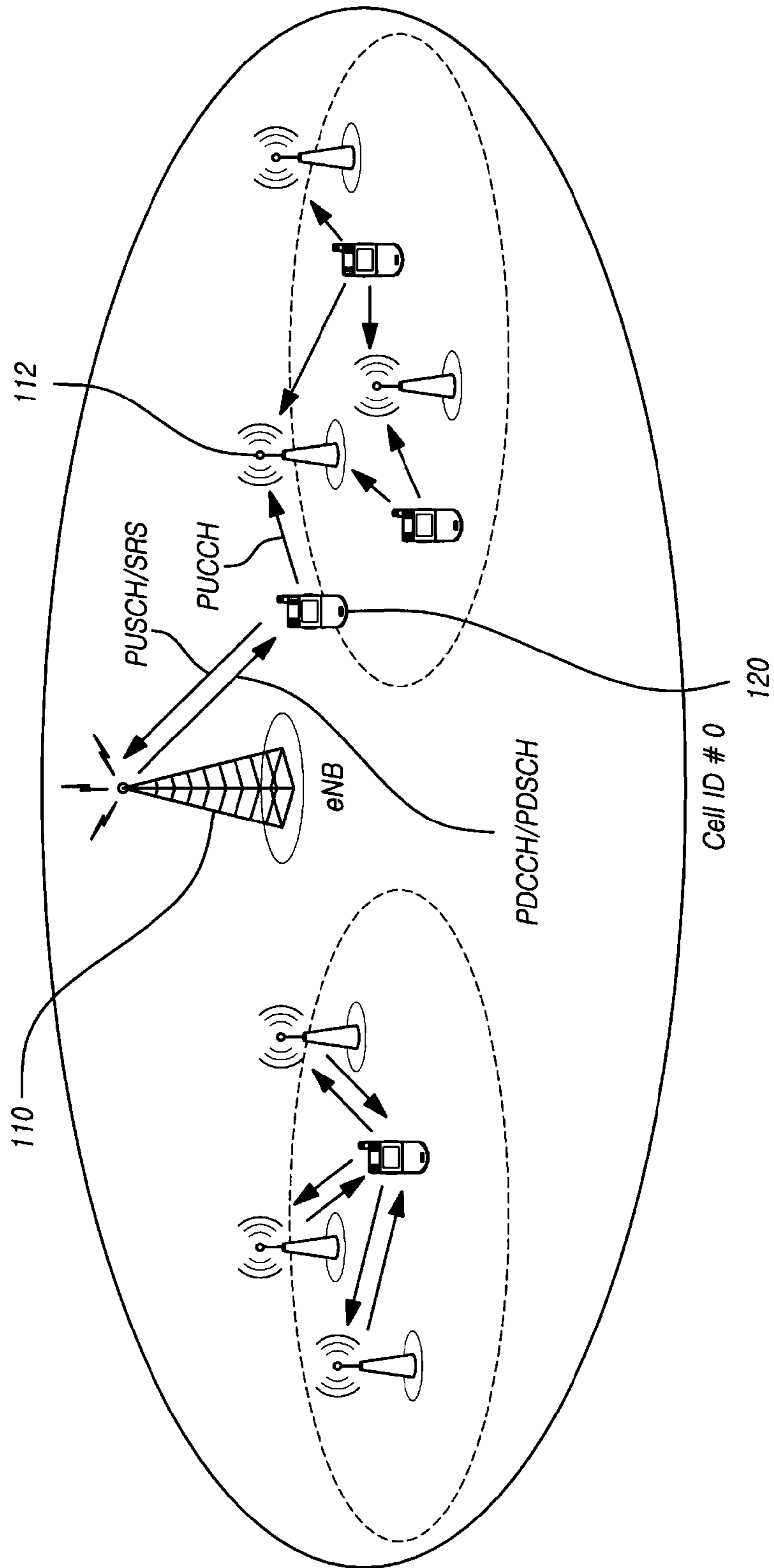

FIG. 14

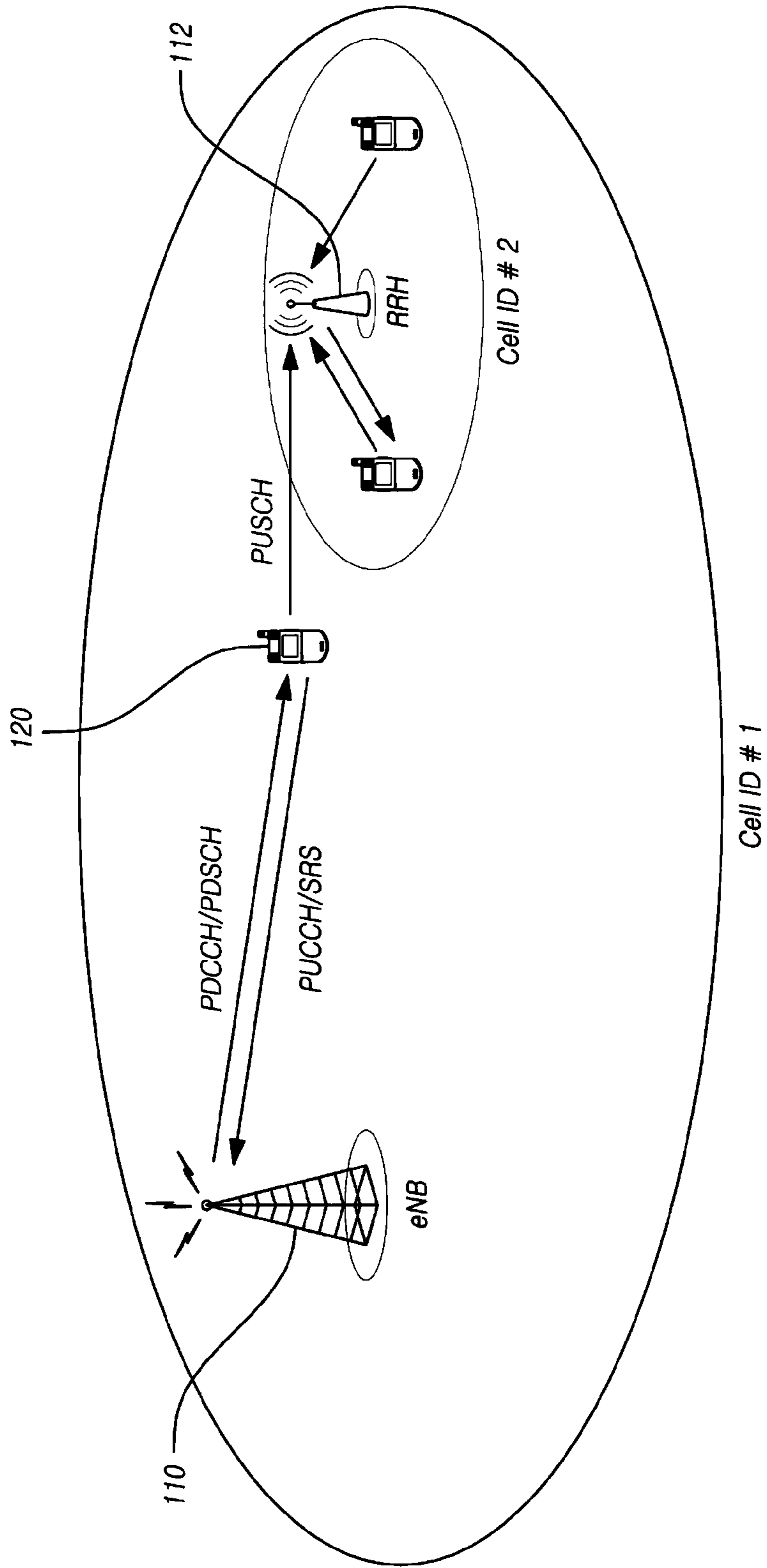



FIG. 15

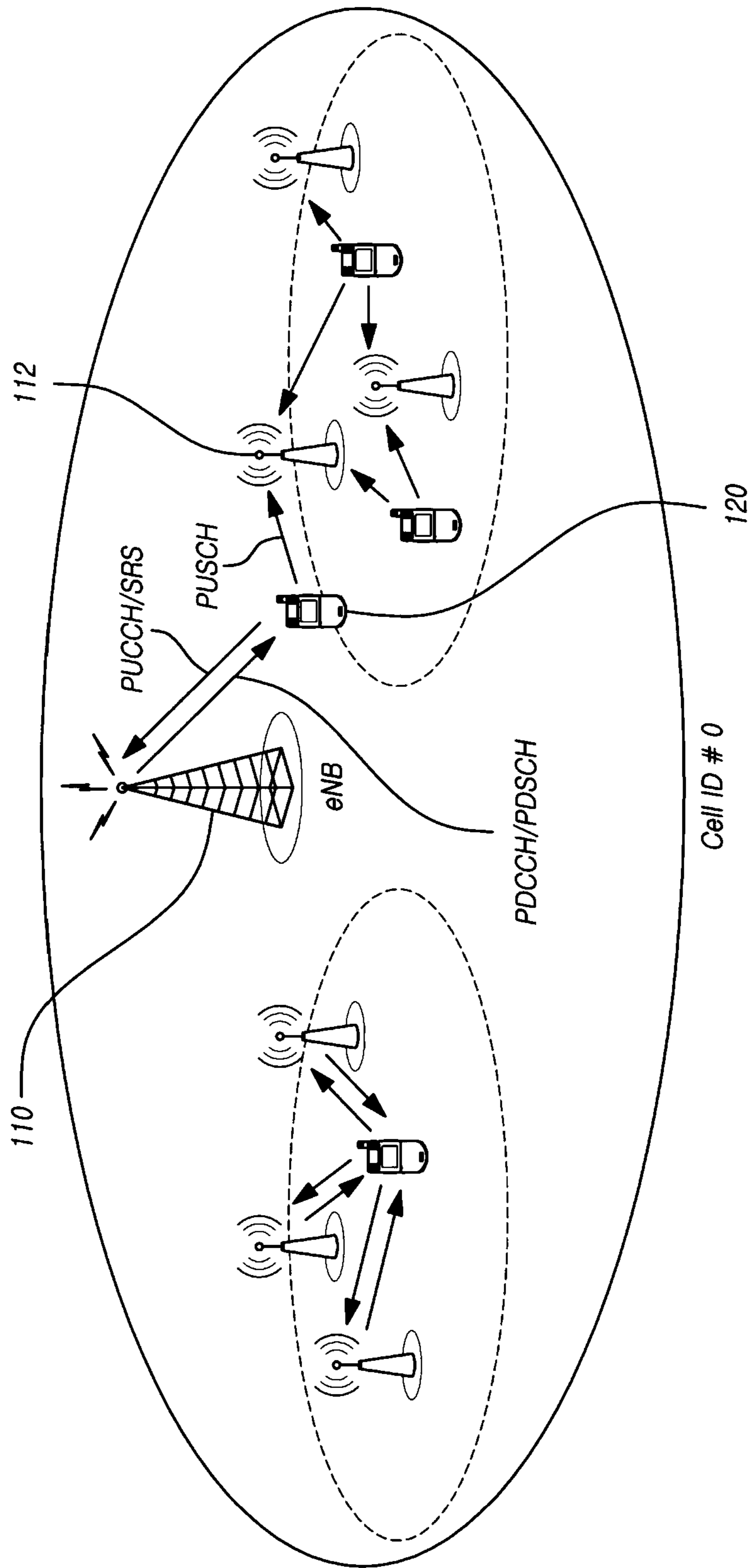

FIG. 16

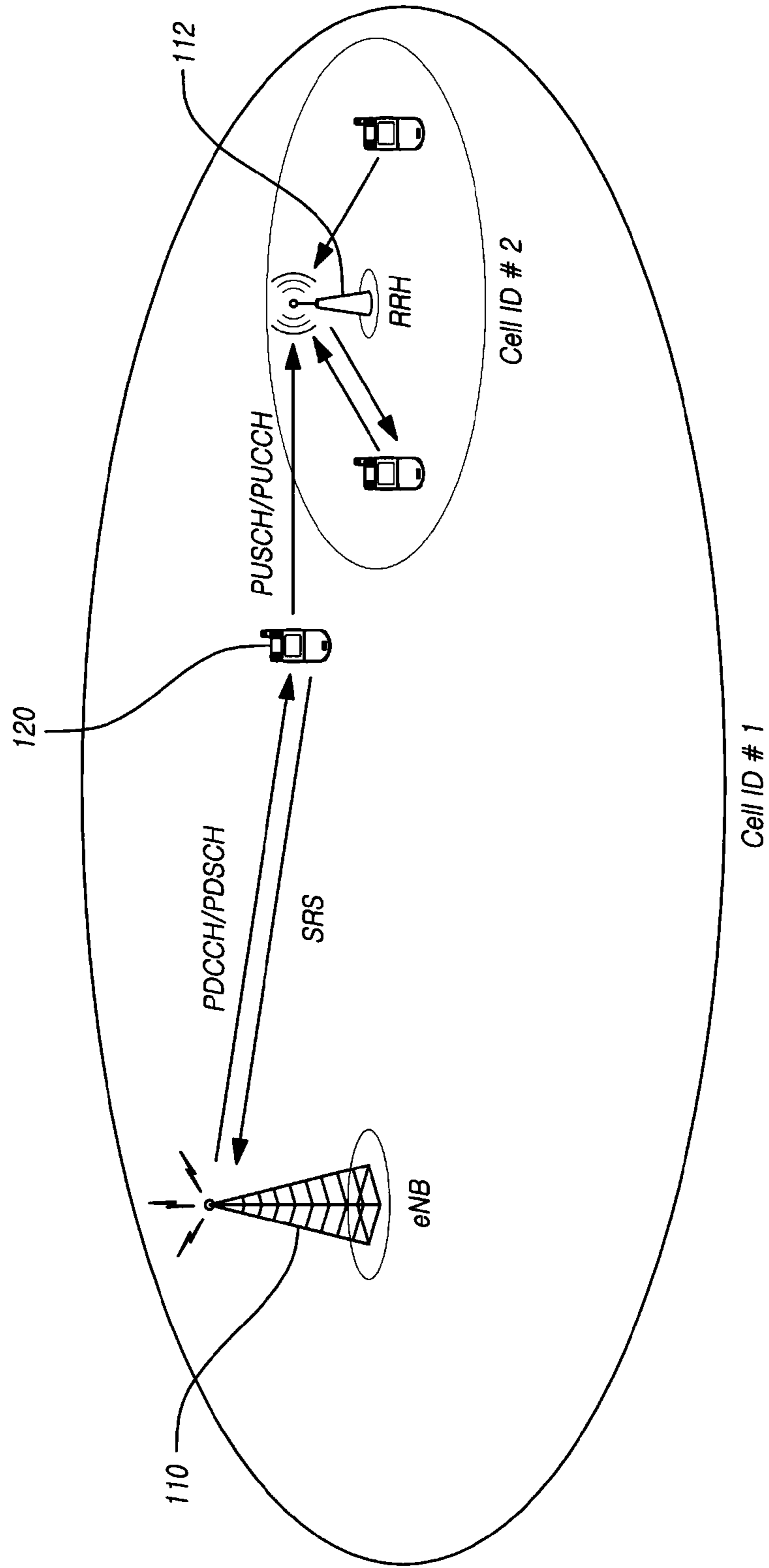

FIG. 17

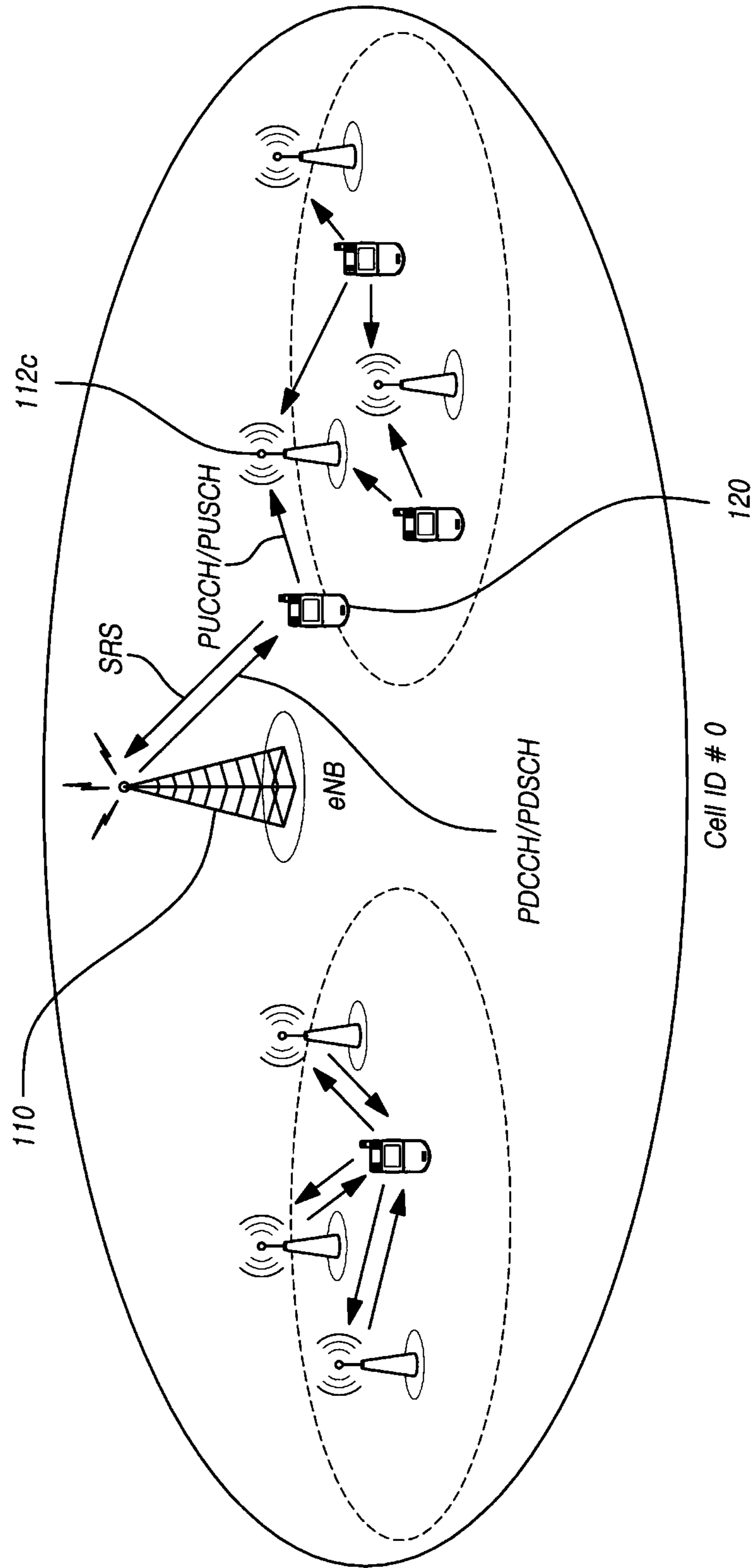

FIG. 18

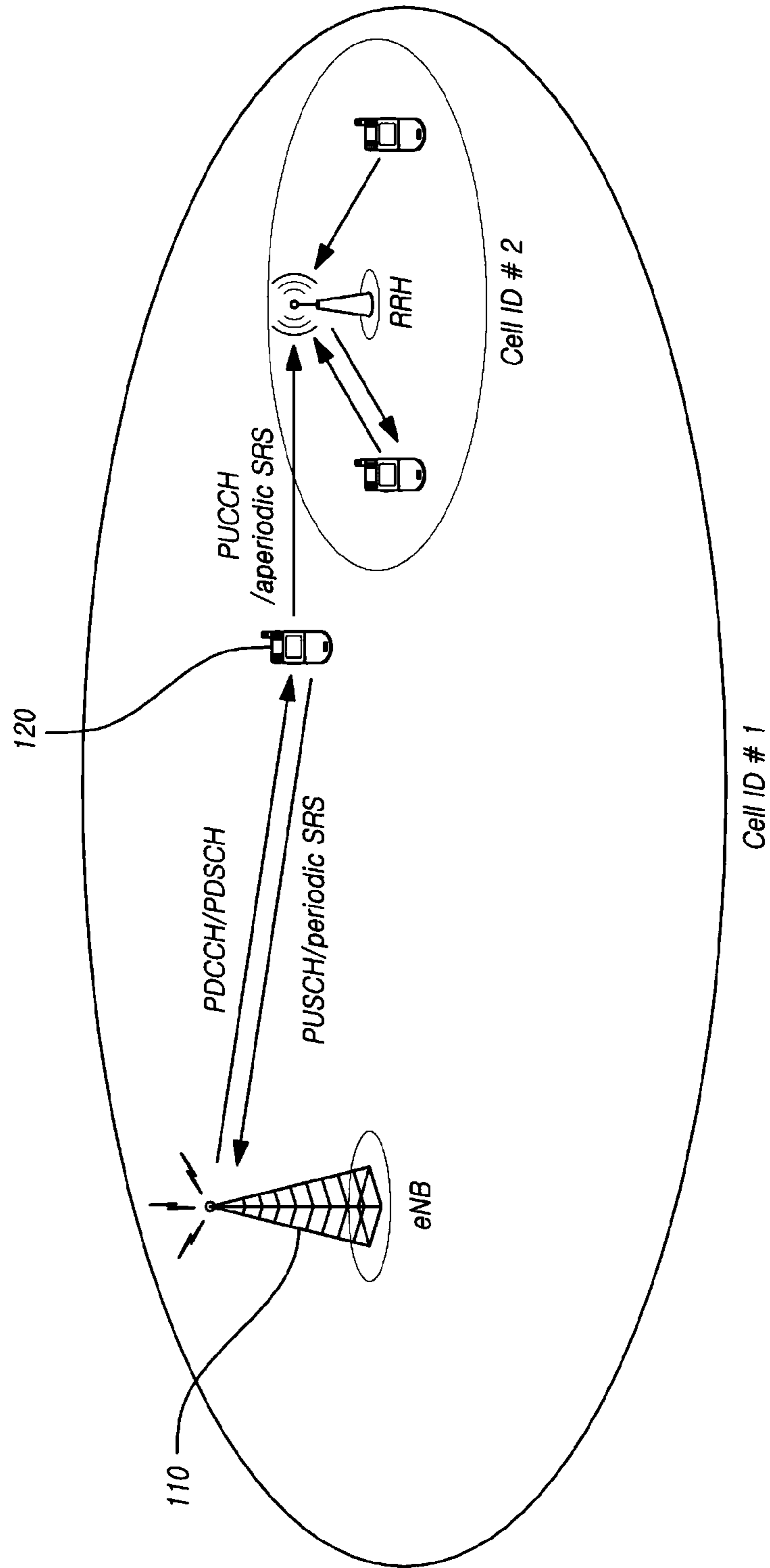

FIG. 19

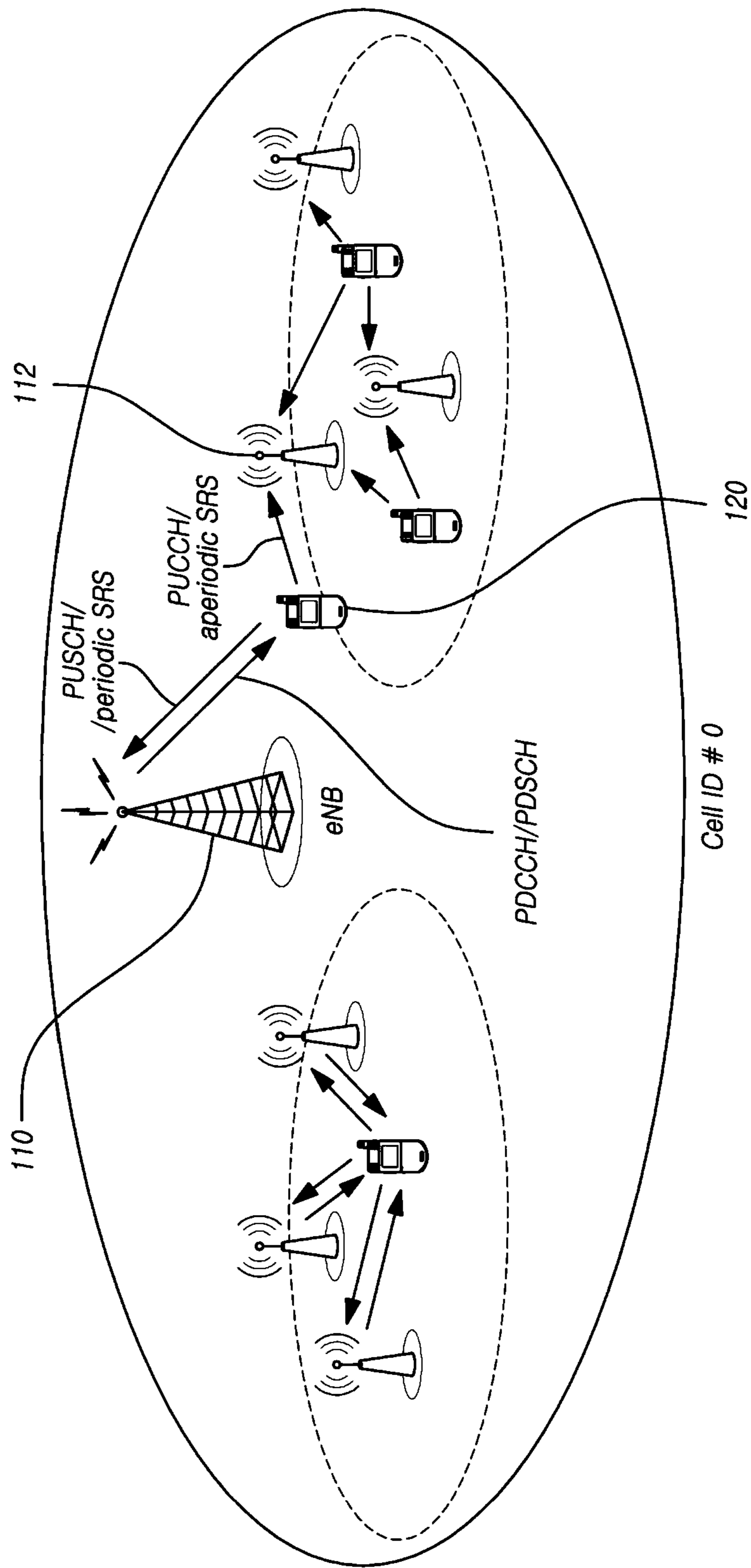

FIG. 20

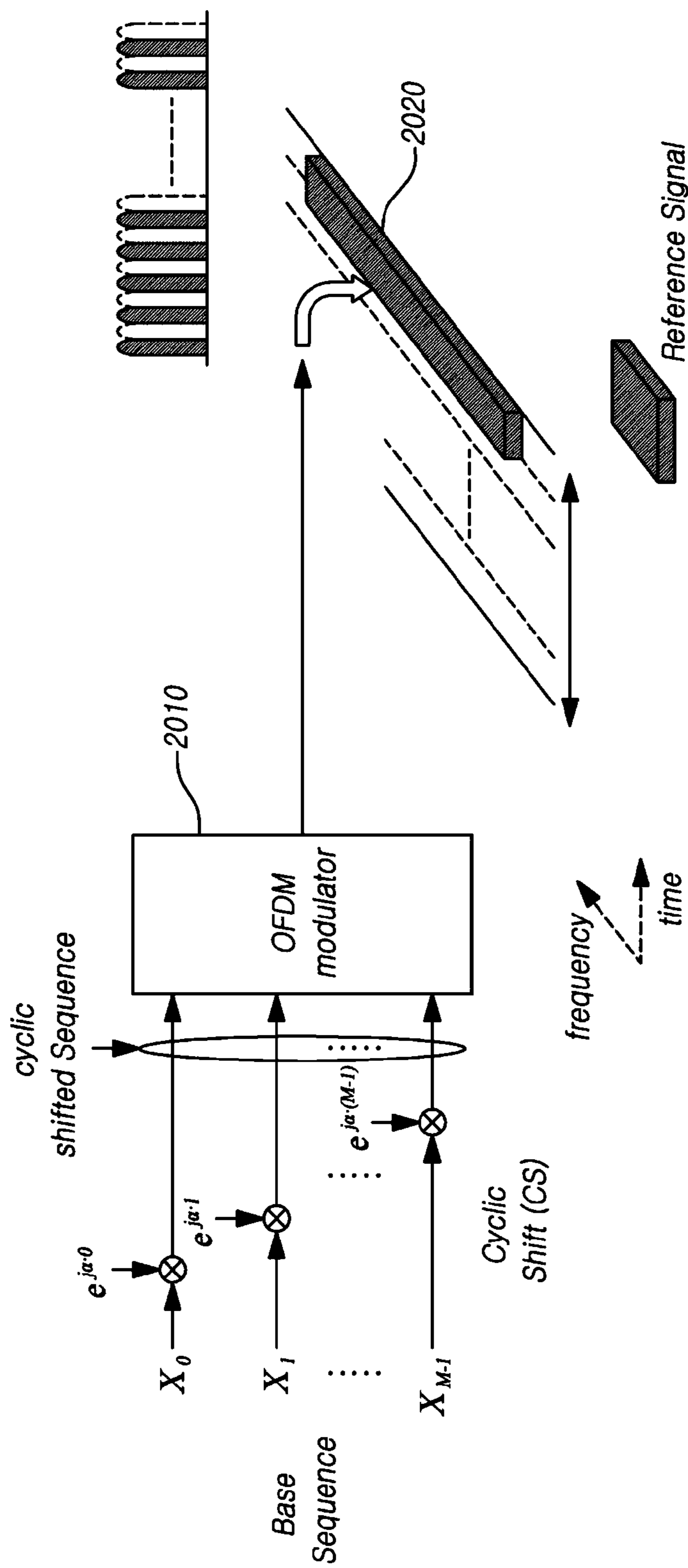

FIG. 21

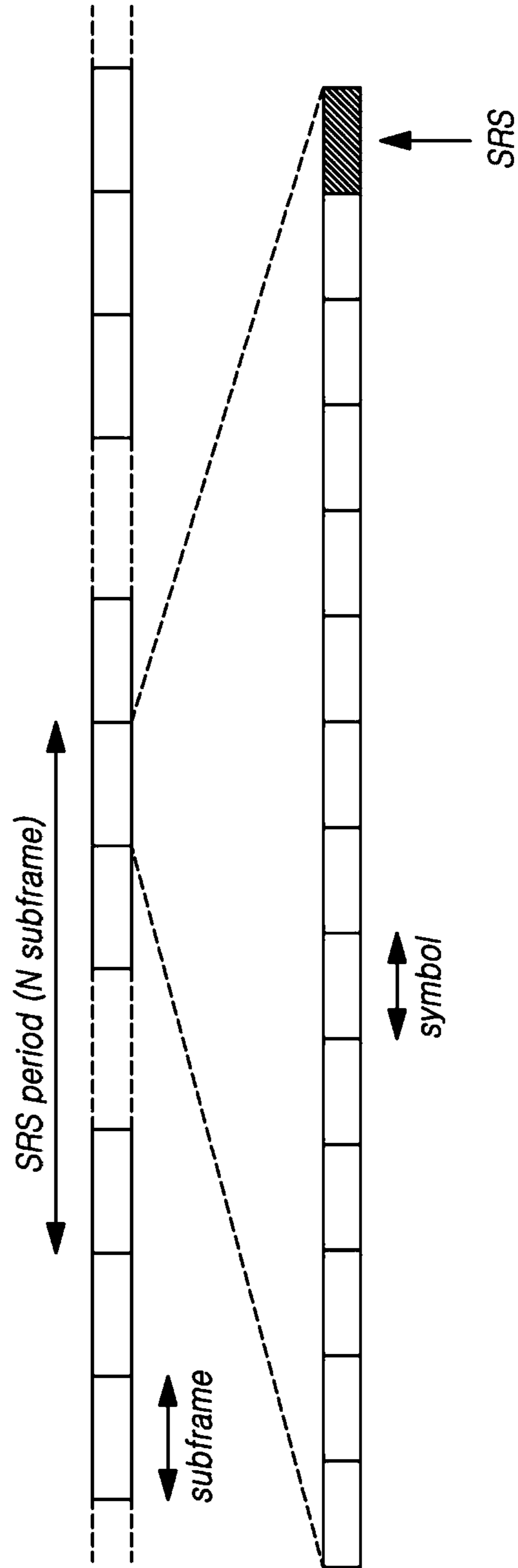

FIG. 22

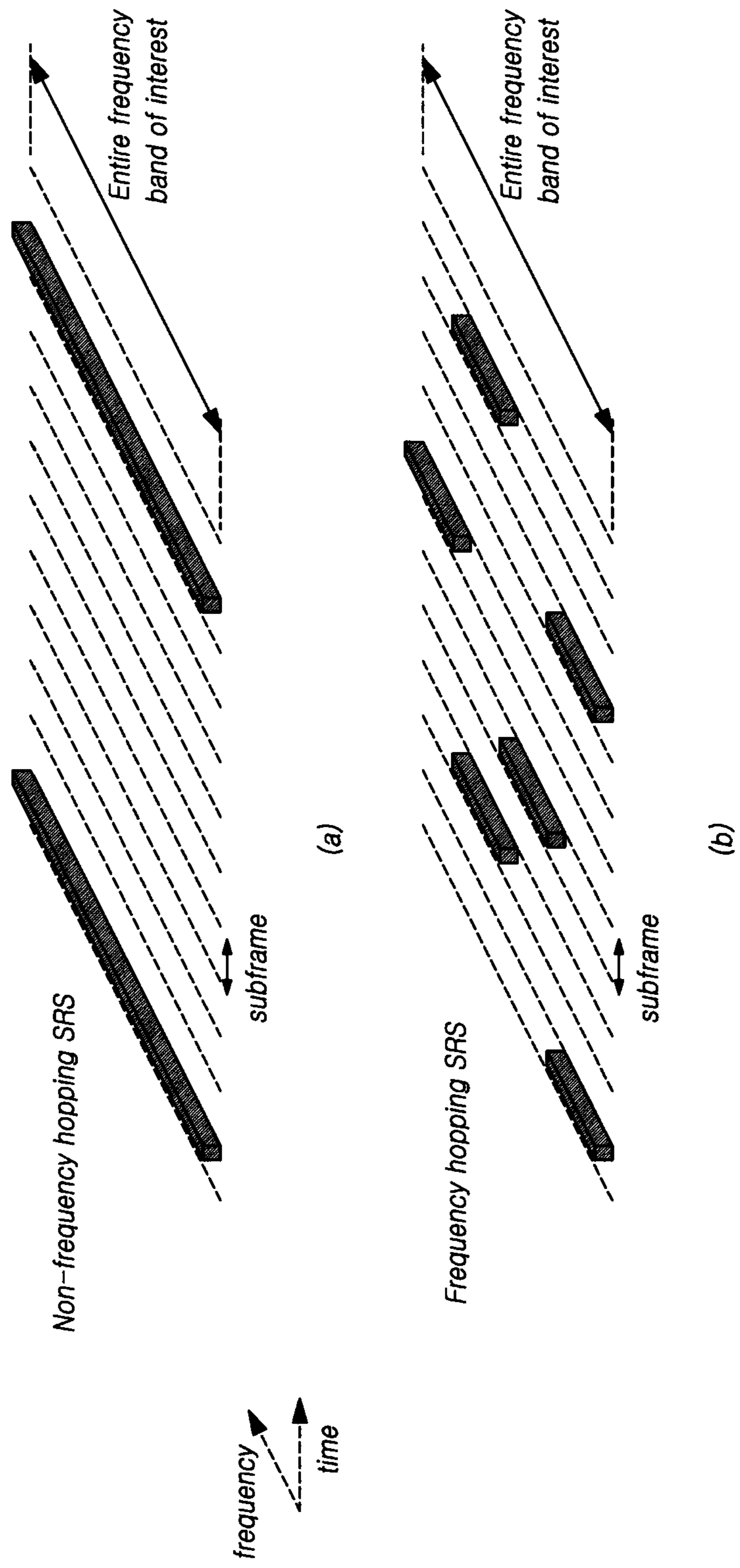



FIG. 23

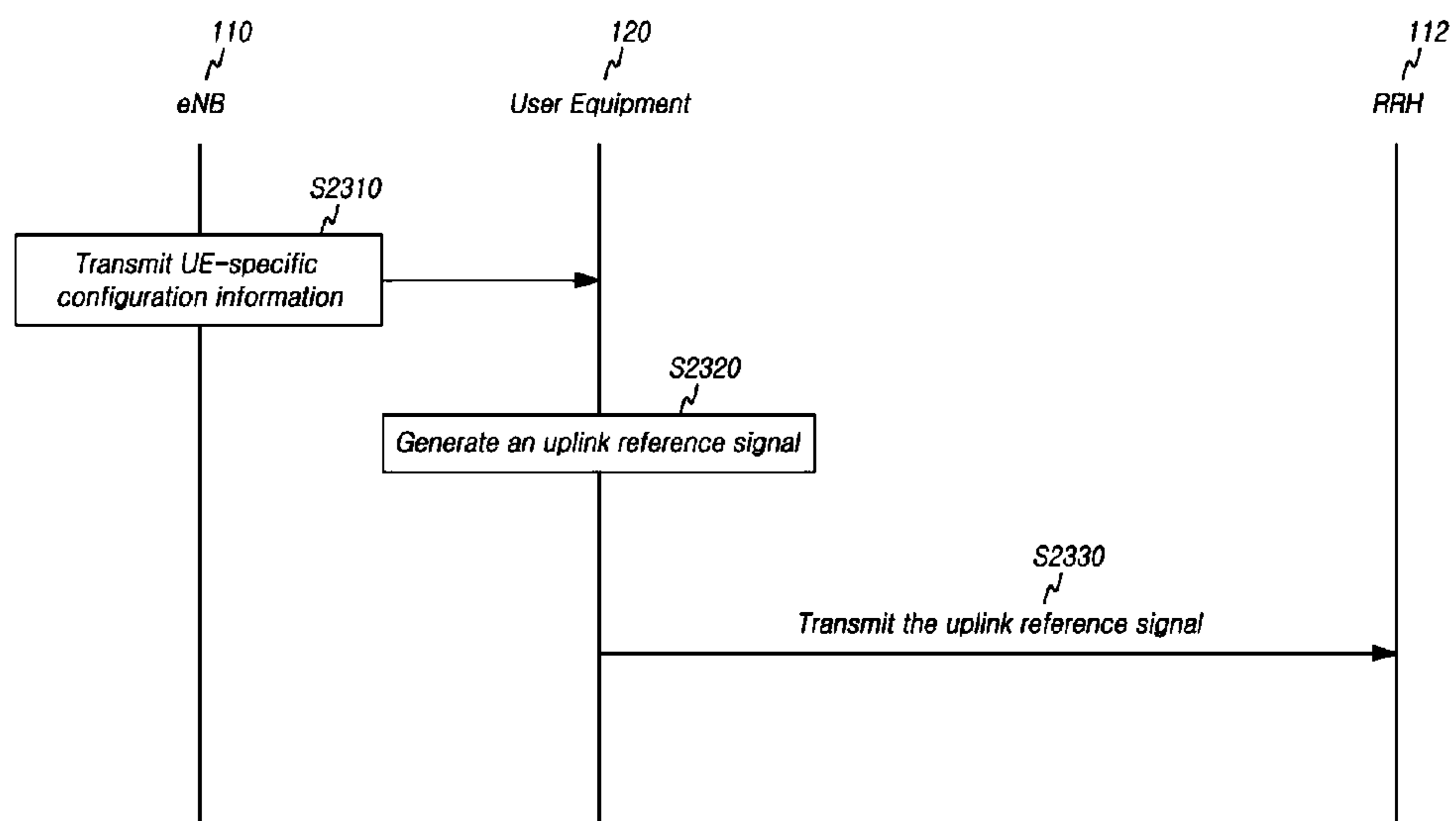

FIG. 24

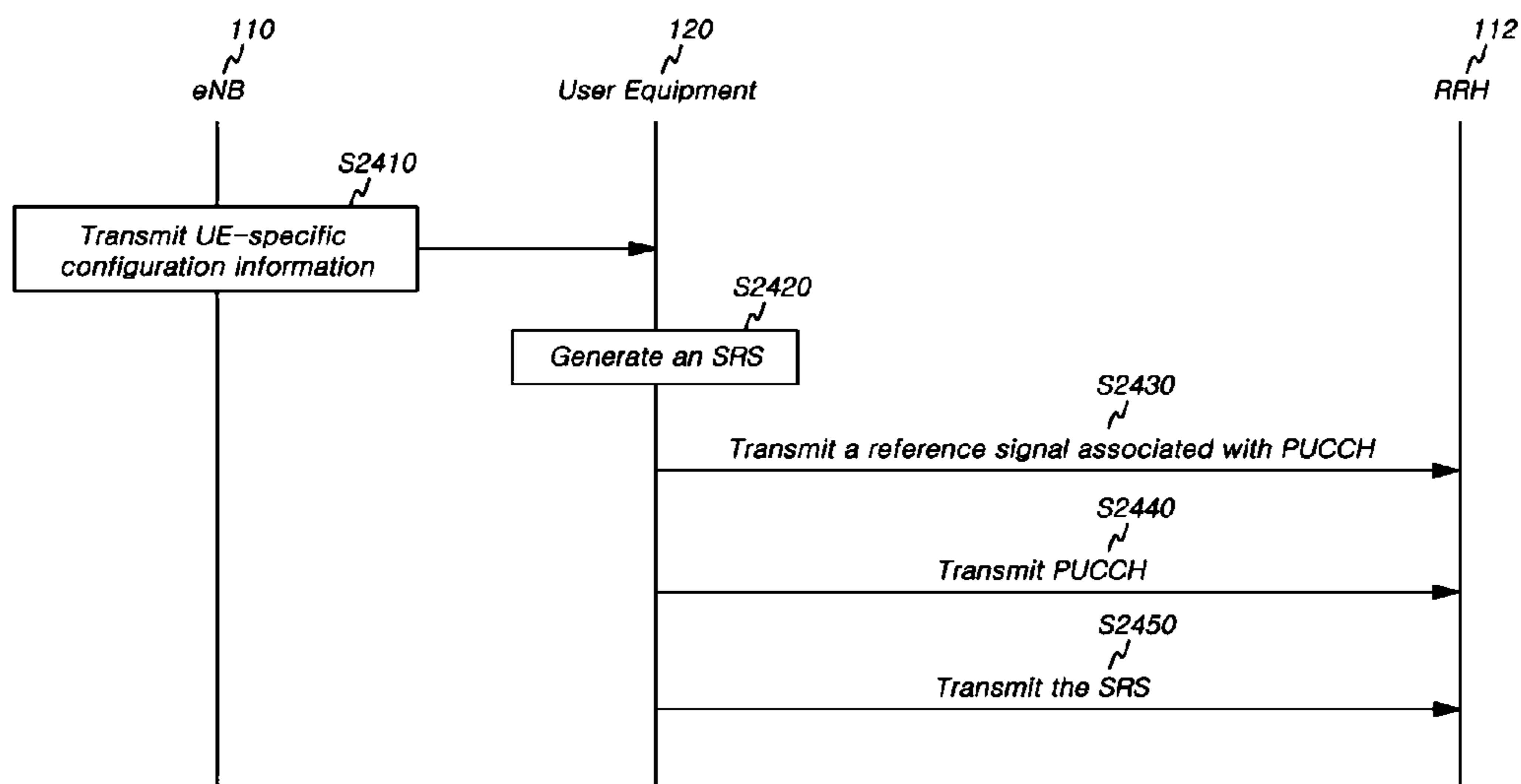

FIG. 25

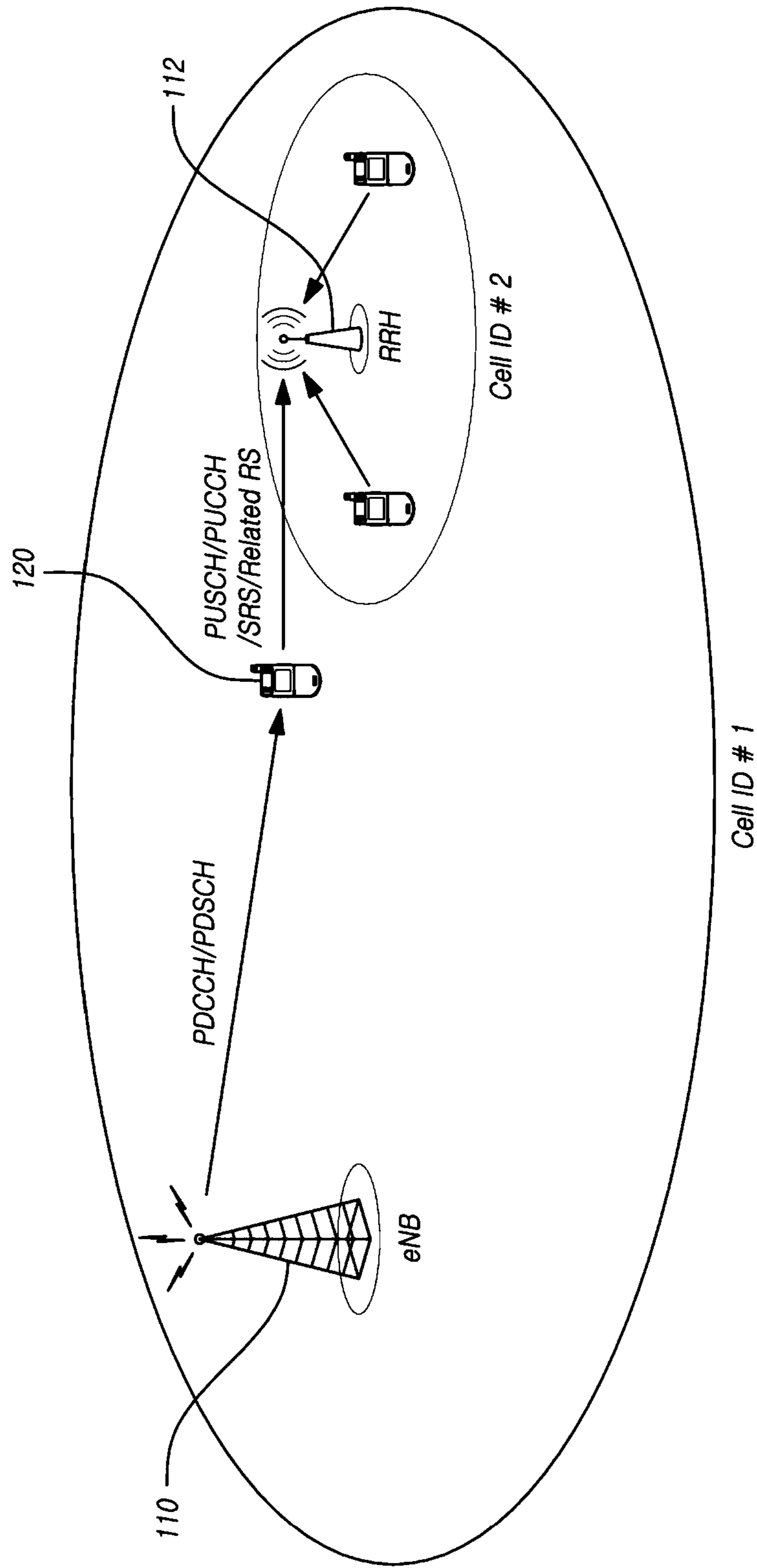

FIG. 26

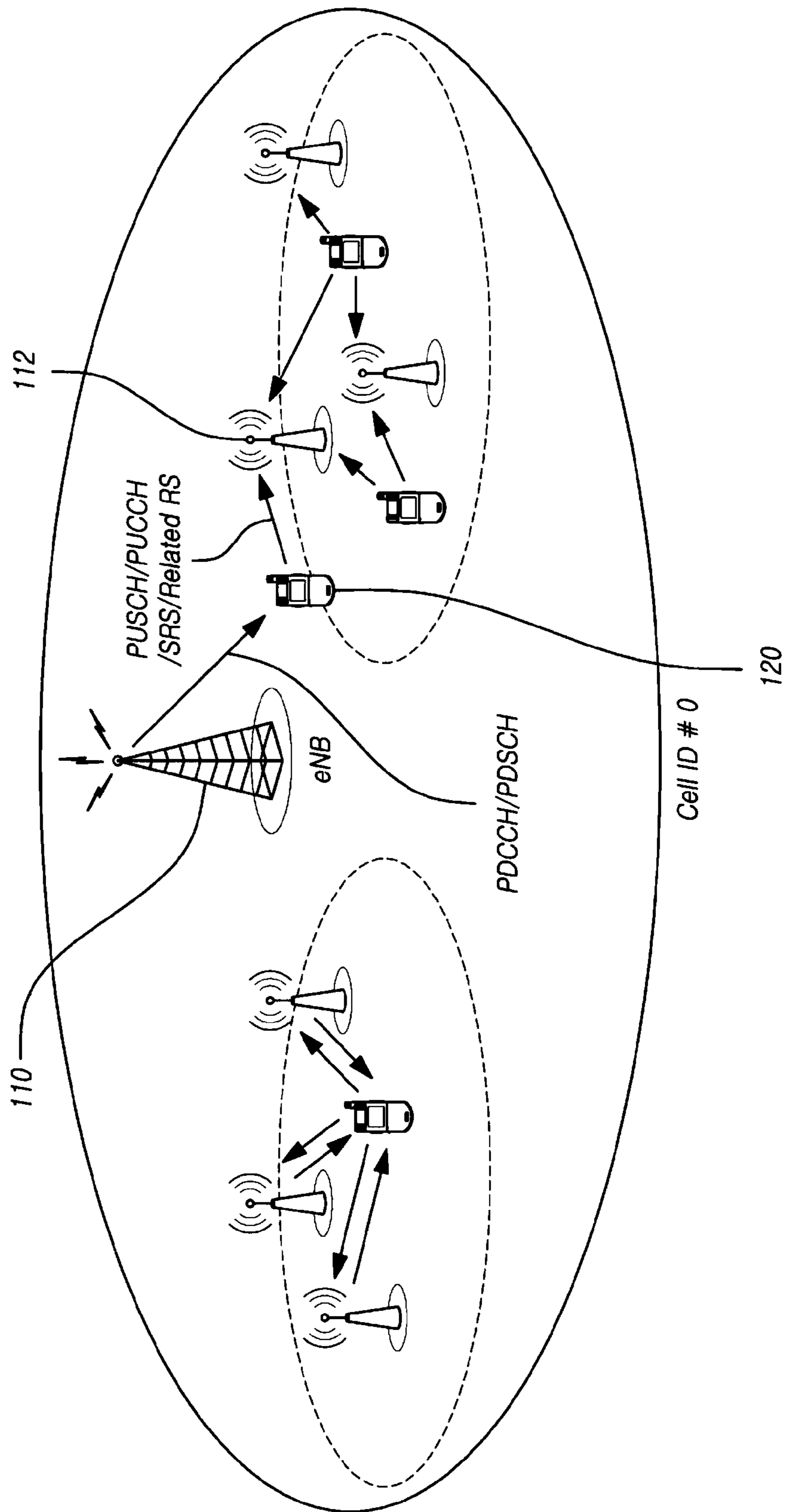

FIG. 27

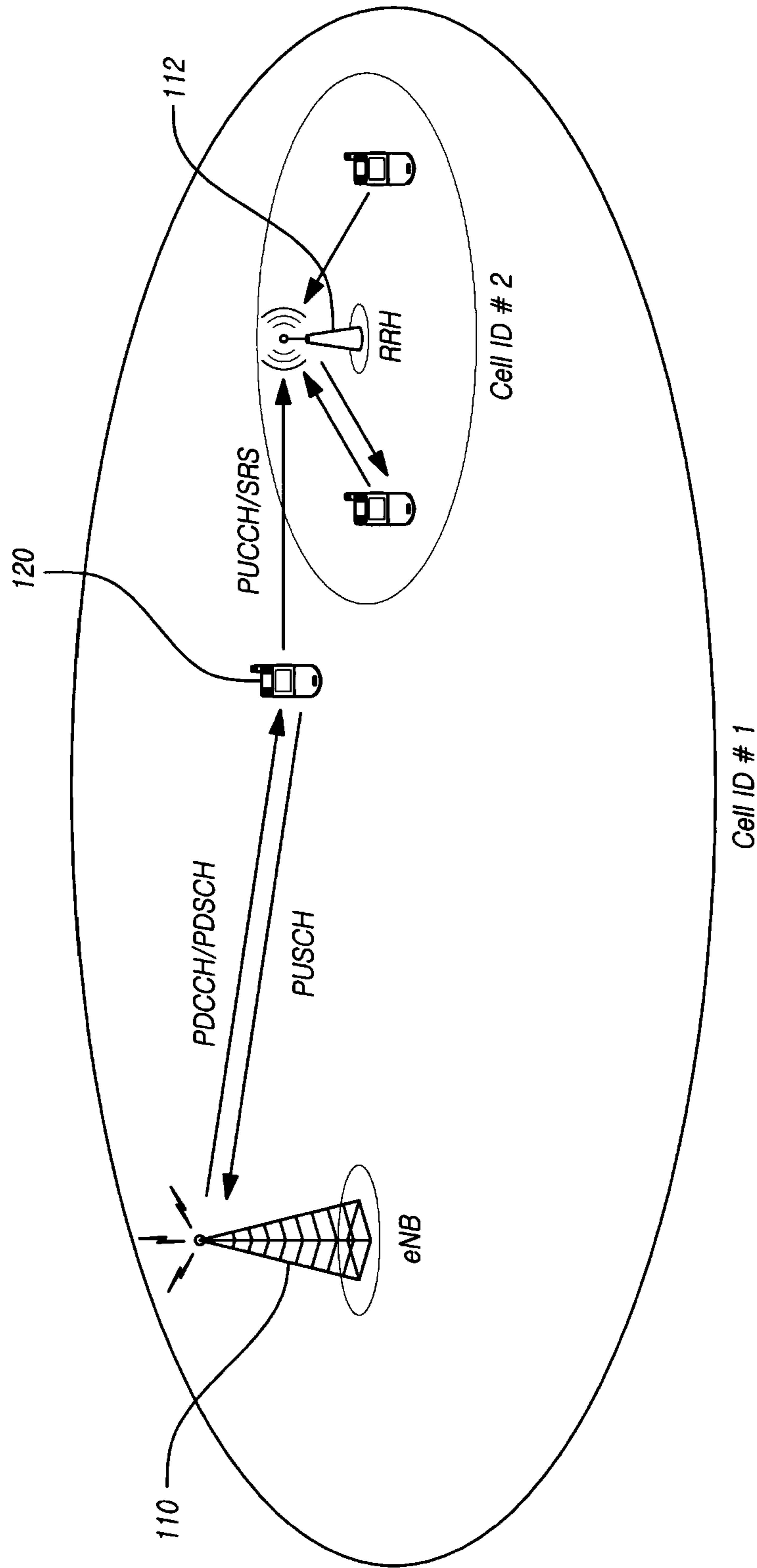

FIG. 28

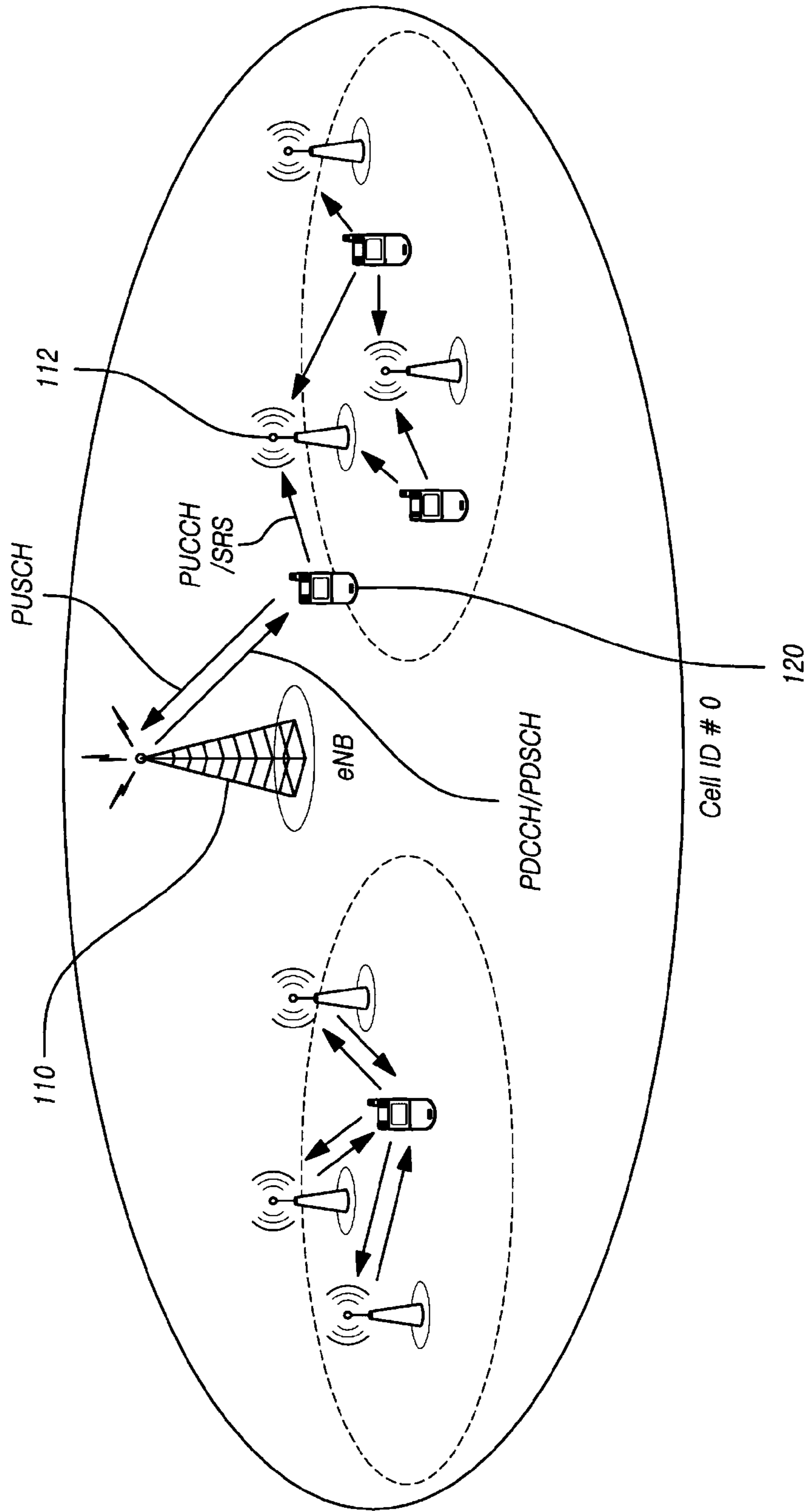

FIG. 29

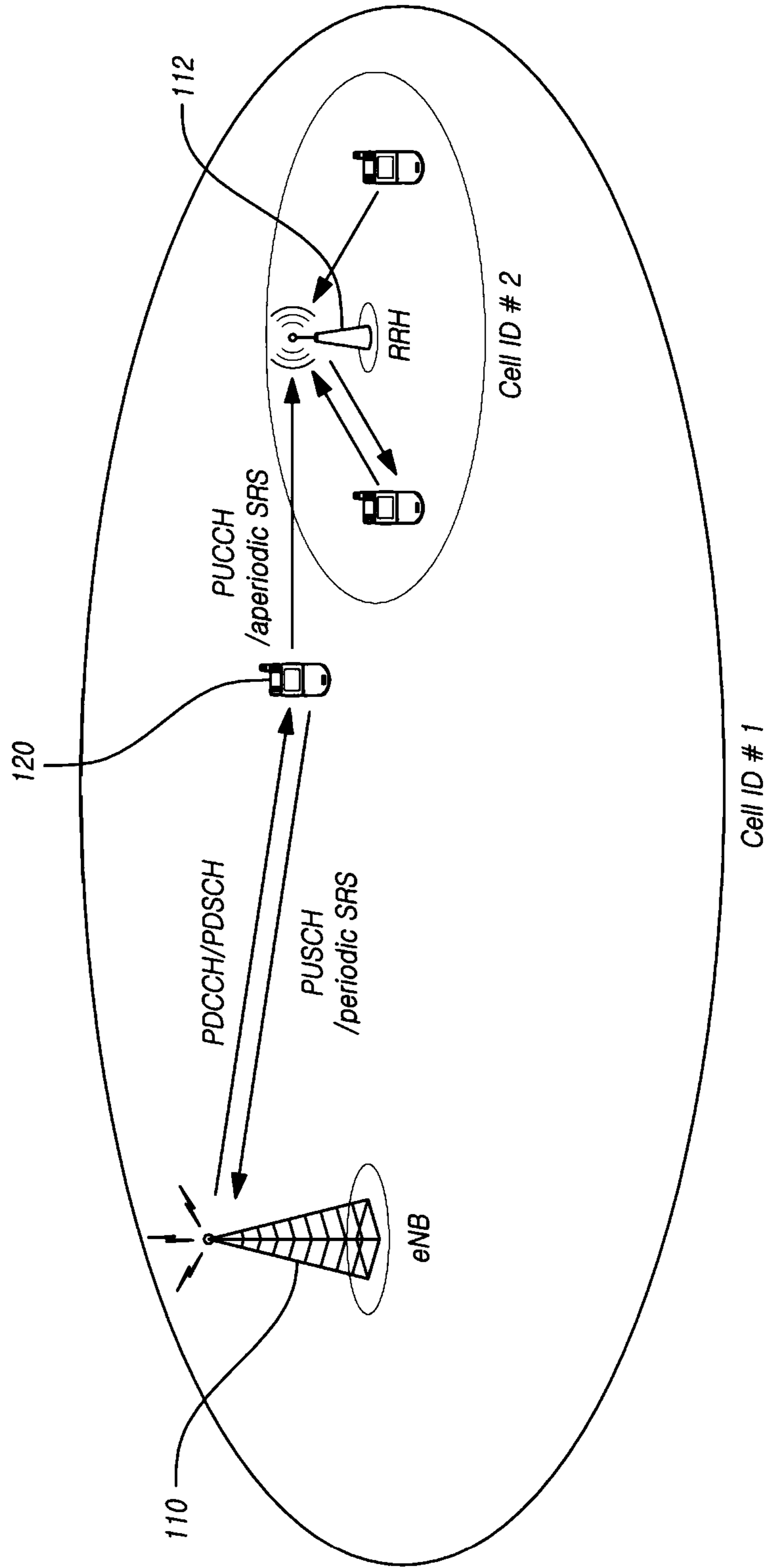

FIG. 30

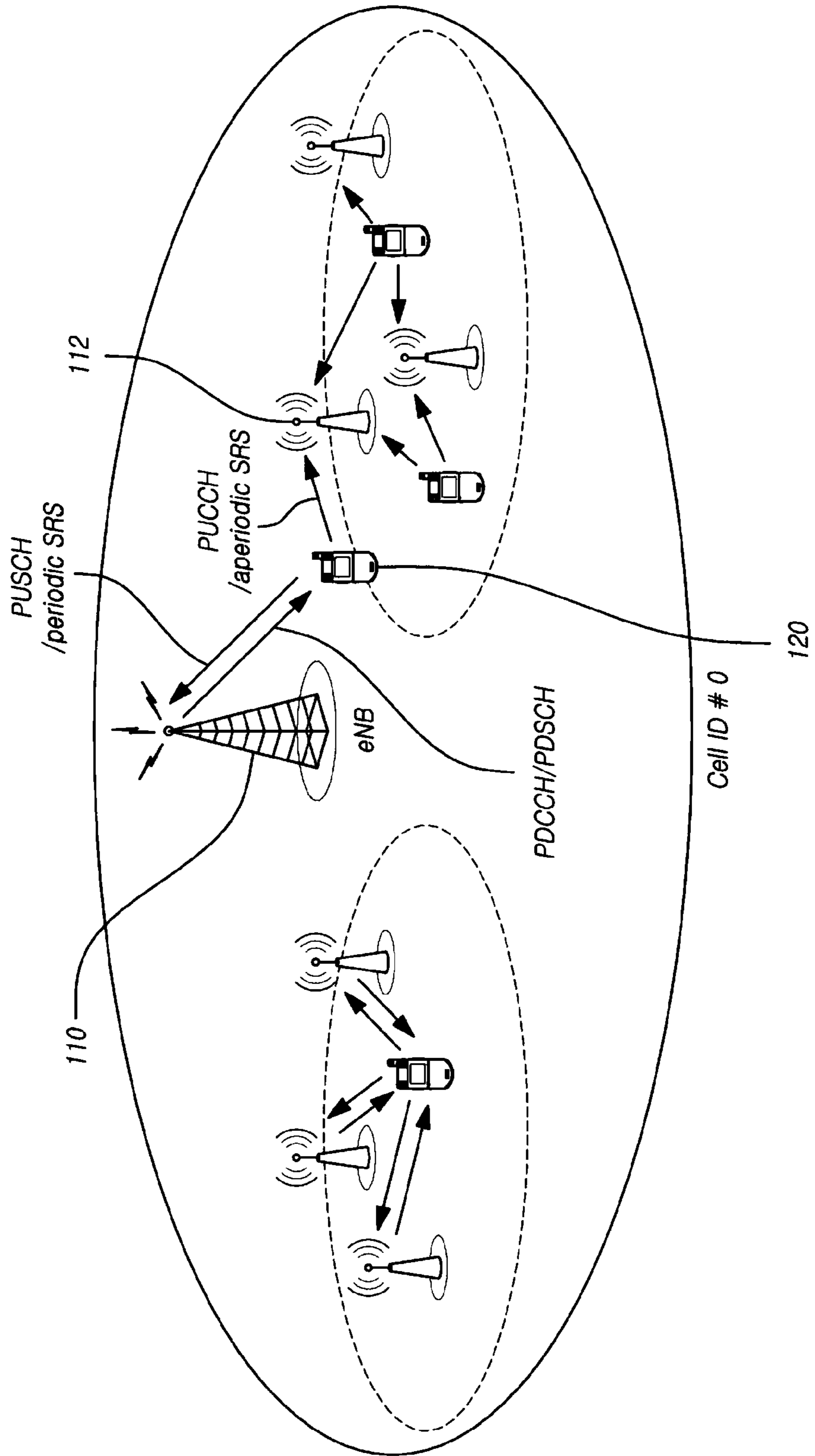



FIG. 31

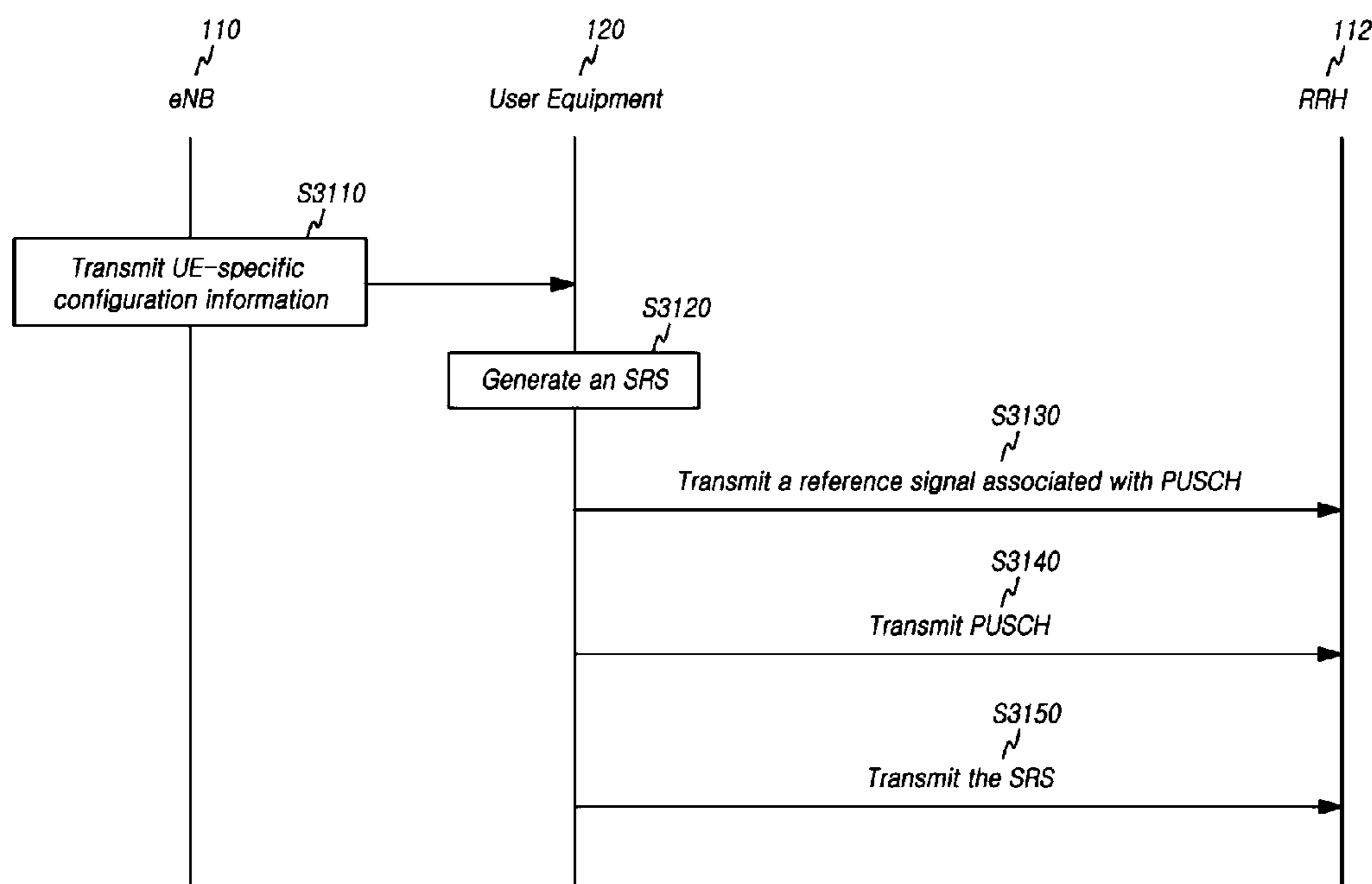

FIG. 32

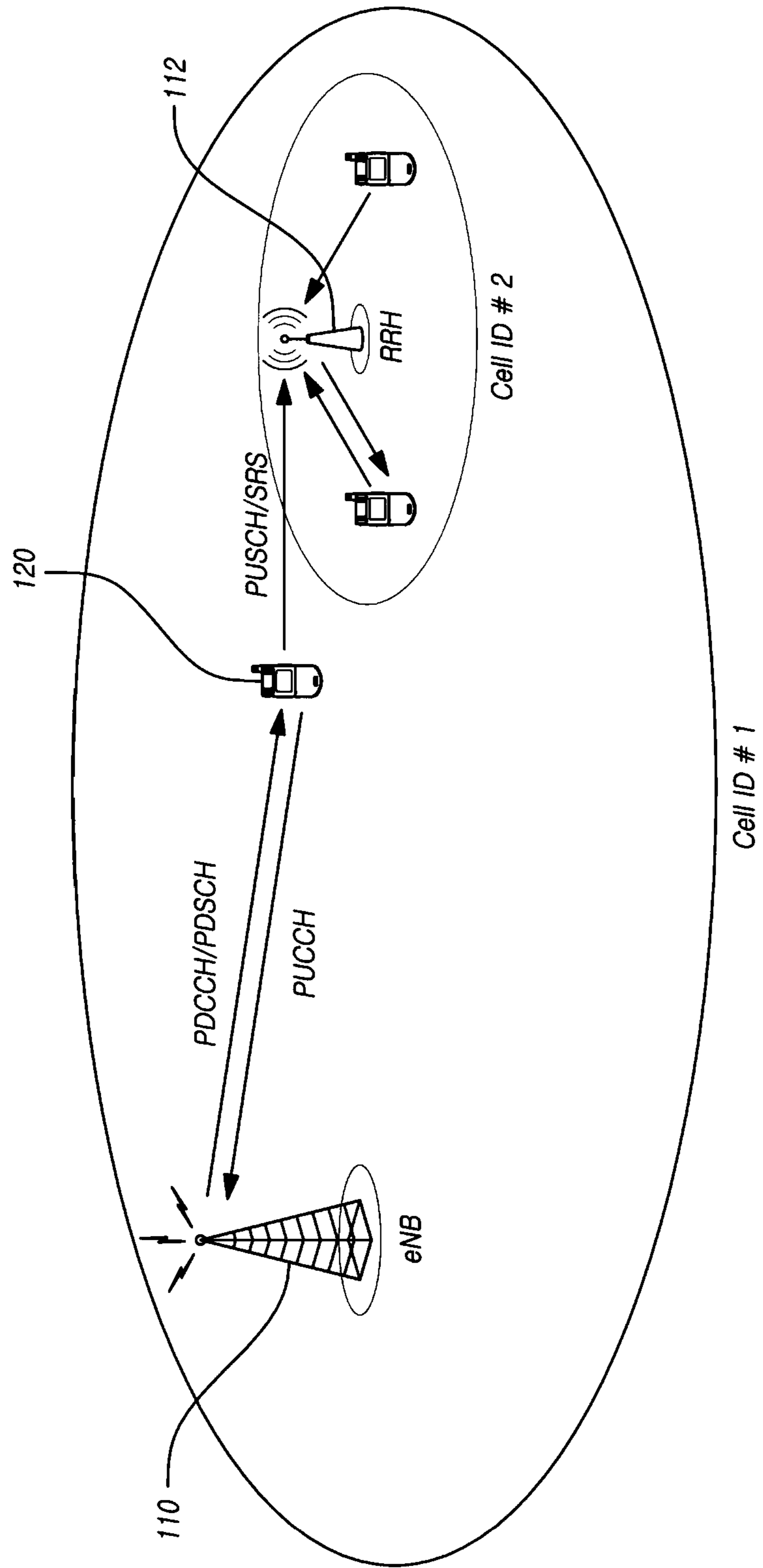

FIG. 33

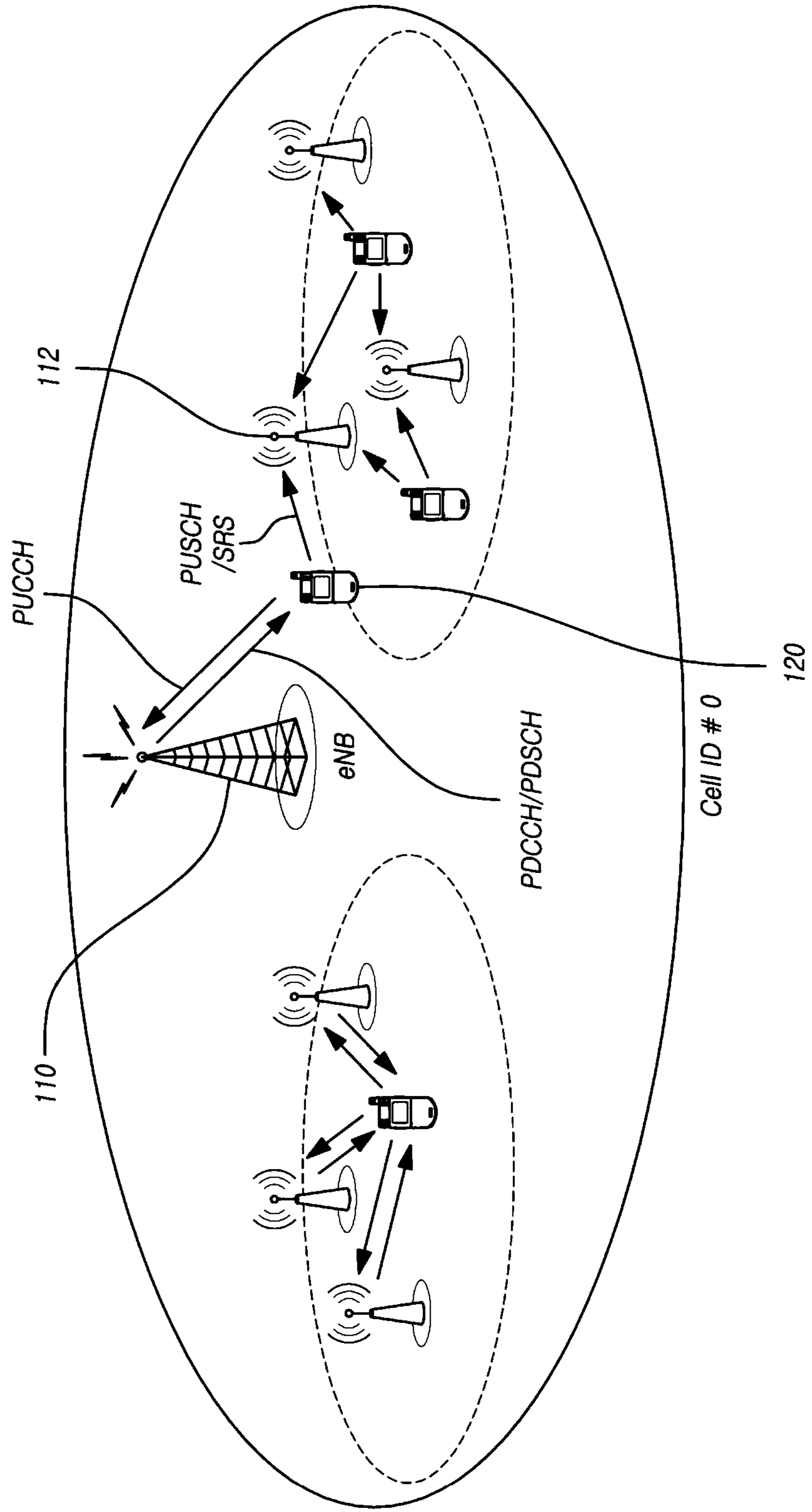

FIG. 34

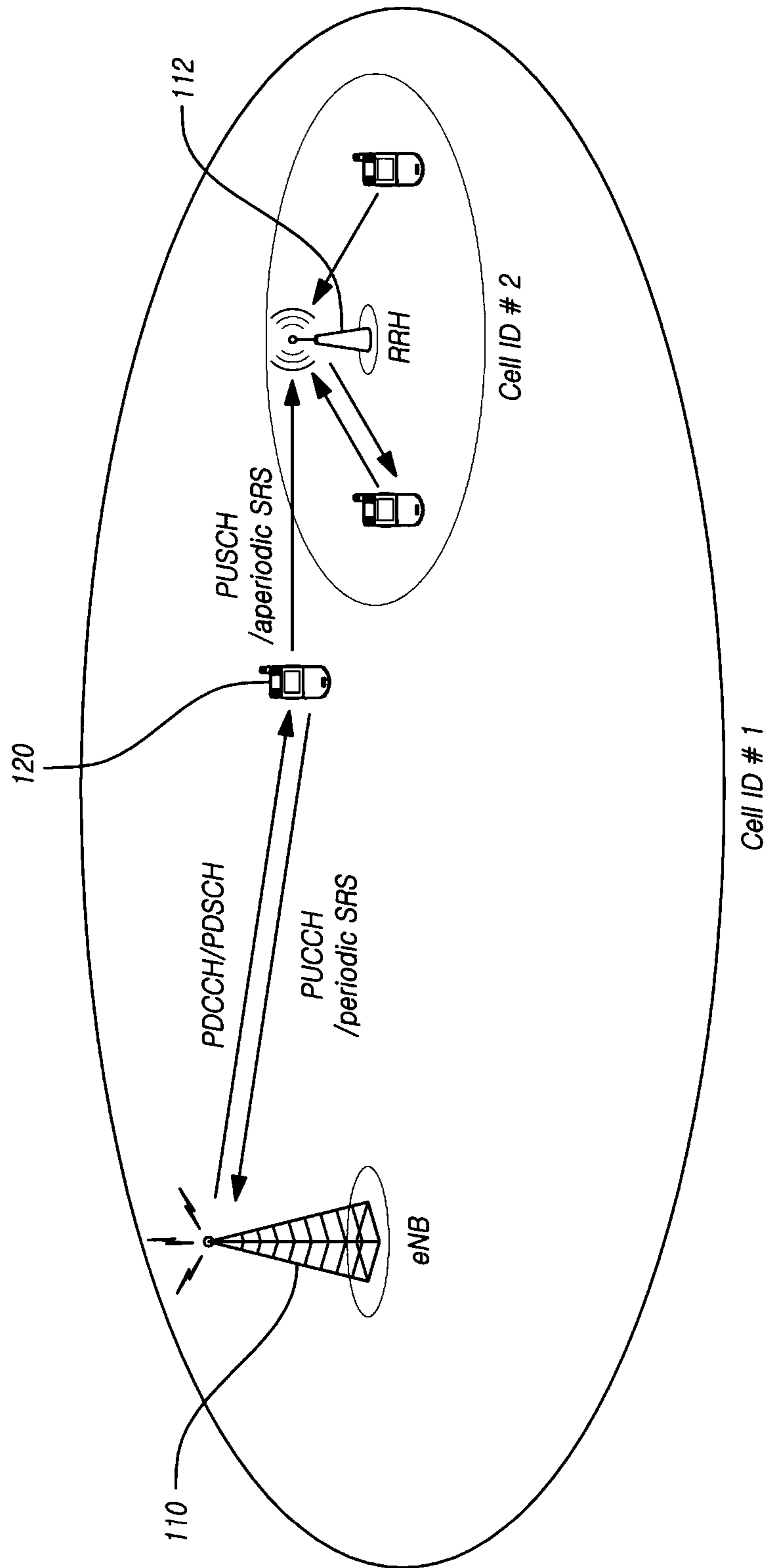

FIG. 35

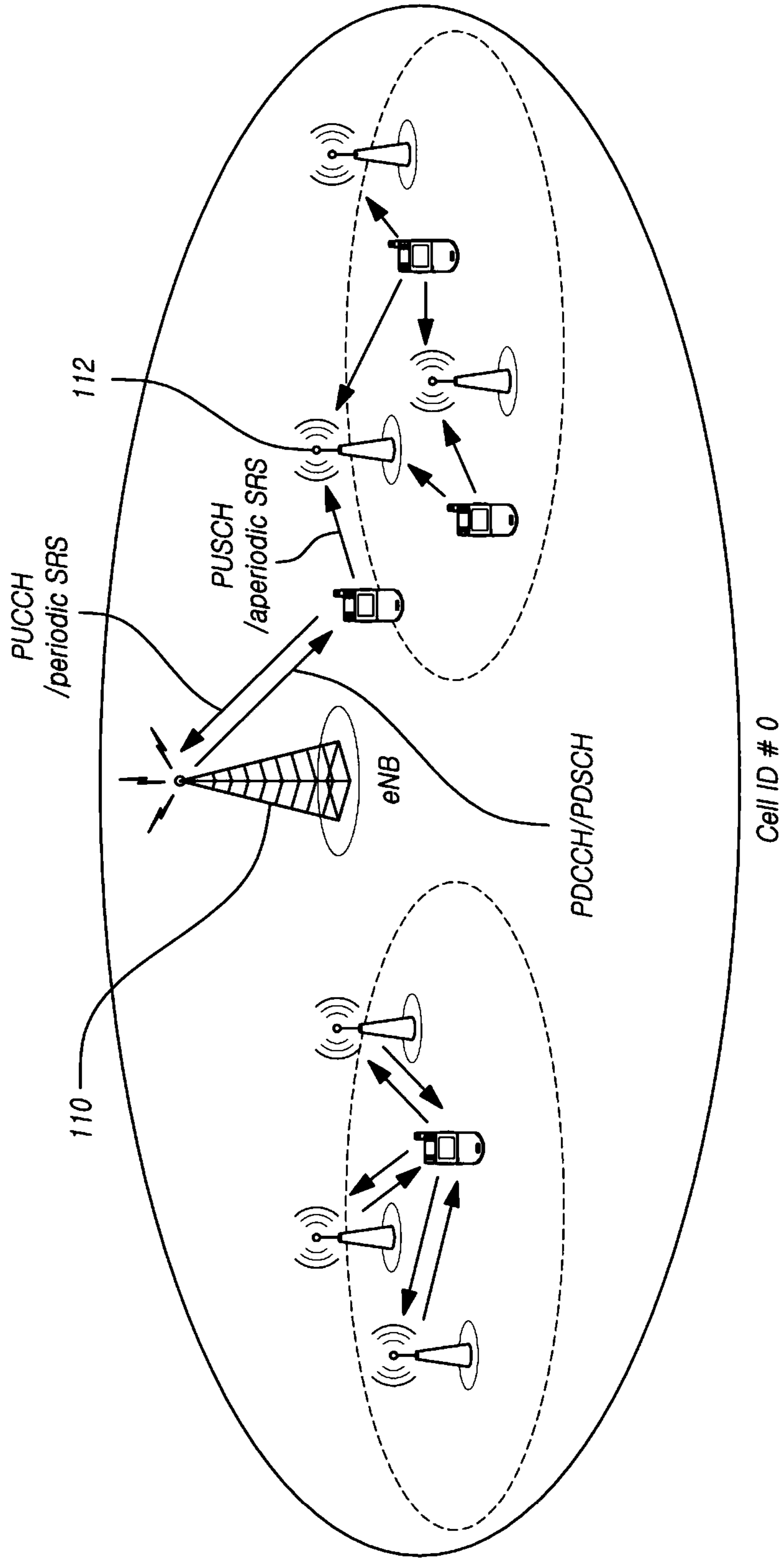

FIG. 36

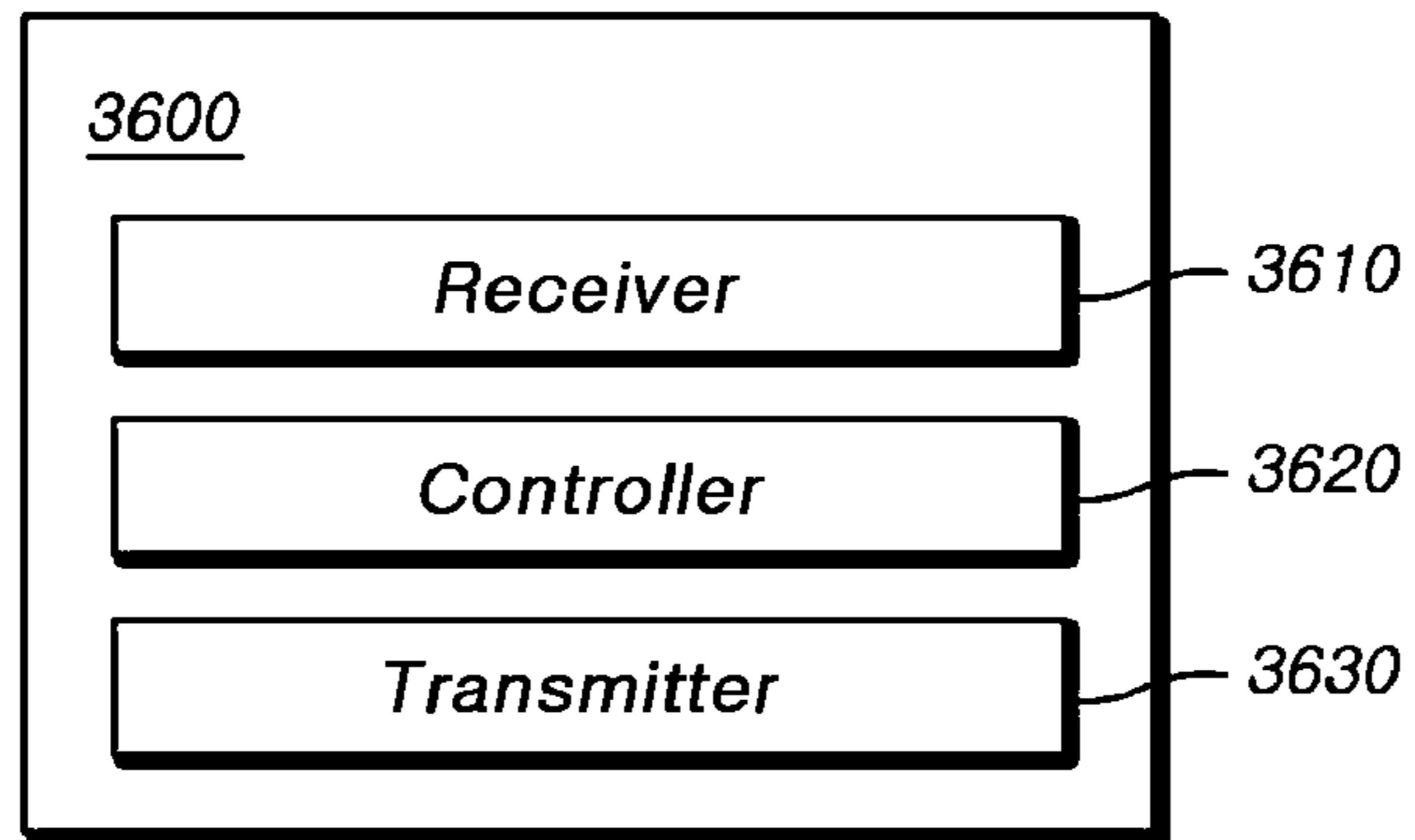

FIG. 37

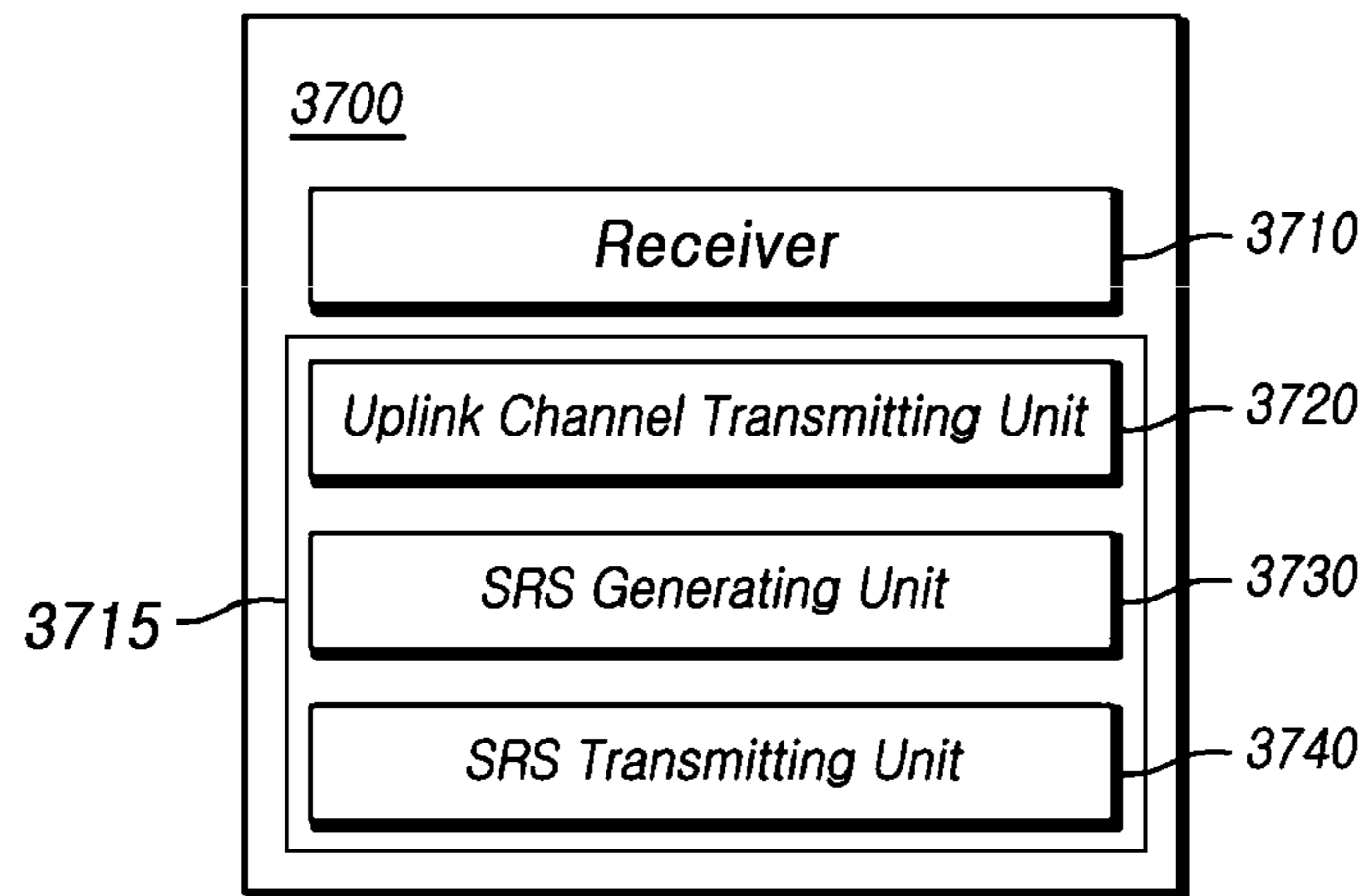
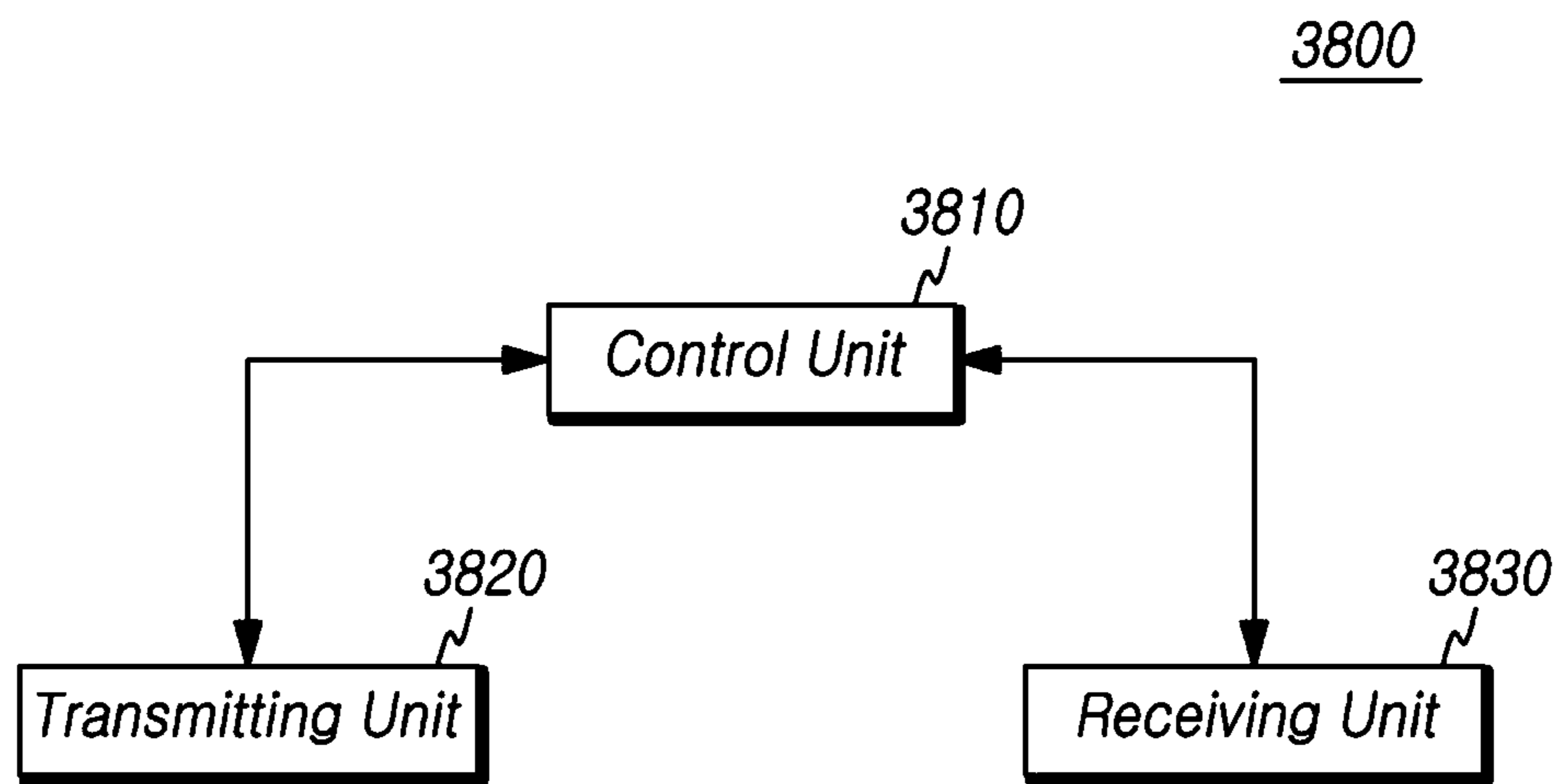

FIG. 38





**TRANSMISSION OF UPLINK SOUNDING  
REFERENCE SIGNAL**

**Matter enclosed in heavy brackets [ ] appears in the original patent but forms no part of this reissue specification; matter printed in italics indicates the additions made by reissue; a claim printed with strikethrough indicates that the claim was canceled, disclaimed, or held invalid by a prior post-patent action or proceeding.**

CROSS REFERENCE TO PRIOR  
APPLICATIONS

The present application claims priority under 35 U.S.C. § 119 to Korean Patent Application No. 10-2012-0062278 (filed on Jun. 11, 2012), Korean Patent Application No. 10-2012-0096443 (filed on Aug. 31, 2012), and Korean Patent Application No. 10-2012-0141262 (filed on Dec. 6, 2012), which are hereby incorporated by reference in their entirety.

BACKGROUND

The present [invention] *disclosure* relates to a physical uplink channel, and particularly, to transmission of uplink sounding reference signal.

In a coordinated multi-point transmission/reception system (CoMP system), at least two of transmission and reception points cooperate with each other to transmit signals. Such a CoMP system measures an uplink channel state for uplink frequency-dependent schedule and measures an uplink/downlink channel for downlink beam-forming using channel reciprocity. In order to measure the uplink channel state and the uplink/downlink channel, transmission of a sounding reference signal (SRS) is required.

SUMMARY

In accordance with at least one embodiment, a method may be provided for transmitting an uplink sounding reference signal (SRS) in user equipment (UE). The method may include receiving UE-specific configuration information indicating an uplink reference signal identity from one [transmission/reception point] of a plurality of [different] transmission/reception points, wherein the uplink reference signal identity is independent of a physical cell identity of the one transmission/reception point and is associated with an uplink channel; transmitting the uplink channel to a transmission/reception point indicated by the uplink reference signal identity, using the uplink reference signal identity; generating a sounding reference signal (SRS) independent of (*or independently from*) the uplink channel, using the physical cell identity of the one transmission/reception point; and transmitting the generated SRS to the one transmission/reception point.

The SRS may include at least one of a periodic SRS and an aperiodic SRS. The generating an SRS may include generating both the periodic SRS and the aperiodic SRS using the physical cell identity of the one transmission/reception point. The transmitting the generated SRS may include transmitting one of the periodic SRS and the aperiodic SRS to the one transmission/reception point indicated by the physical cell identity.

The SRS may include at least one of a periodic SRS and an aperiodic SRS. The generating an SRS may include generating one of the periodic SRS and the aperiodic SRS

using the physical cell identity of the one transmission/reception point, and the other SRS using the uplink reference signal identity. The transmitting the generated SRS may include transmitting one of the periodic SRS and the aperiodic SRS to the one transmission/reception point, and *transmitting* the other SRS to the transmission/reception point indicated by the uplink reference signal identity.

The uplink channel may be at least one of a physical uplink shared channel and a physical uplink control channel.

The receiving UE-specific configuration information may include receiving the UE-specific configuration information either through a UE-specific parameter, or dynamically through at least one of a physical downlink control channel (PDCCH) and an enhanced physical downlink control channel (EPDCCH).

In accordance with another embodiment, a method may be provided for transmitting an uplink sounding reference signal (SRS) in user equipment (UE). The method may include receiving UE-specific configuration information indicating a sounding reference signal (SRS) identity from one [transmission/reception point] of a plurality of [different] transmission/reception points, wherein the SRS identity is independently distinguished from an uplink reference signal identity for an uplink channel; generating an SRS using the SRS identity; and transmitting the generated SRS to a transmission/reception point indicated by the SRS identity.

The SRS may include at least one of a periodic SRS and an aperiodic SRS. The UE-specific configuration information indicating the SRS identity may indicate a same reference signal identity for each of the periodic SRS and the aperiodic SRS.

The SRS may include at least one of a periodic SRS and an aperiodic SRS. The UE-specific configuration information [indicating the SRS identity] may indicate a different reference signal identity for each of the periodic SRS and the aperiodic SRS.

The SRS may include at least one of a periodic SRS and an aperiodic SRS. The generating an SRS may include generating one of the periodic SRS and the aperiodic SRS using the SRS identity, and *generating* the other SRS using the physical cell identity of the one transmission/reception point. The transmitting the generated SRS may include transmitting one of the periodic SRS and the aperiodic SRS to the transmission/reception point indicated by the SRS identity, and *transmitting* the other SRS to the one transmission/reception point.

The uplink channel may be at least one of a physical uplink shared channel and a physical uplink control channel.

The receiving UE-specific configuration information may include receiving the UE-specific configuration information either through a UE-specific parameter, or dynamically through at least one of a physical downlink control channel (PDCCH) and an enhanced physical downlink control channel (EPDCCH).

In accordance with still another embodiment, user equipment may be provided. The user equipment may include a [receiving unit] *receiver* configured to receive UE-specific configuration information indicating an uplink reference signal identity from one [transmission/reception point] among a plurality of [different] transmission/reception points, wherein the uplink reference signal identity is independent of a physical cell identity of the one transmission/reception point and is associated with an uplink channel; an uplink channel [transmission unit] *transmitter* configured to transmit the uplink channel to a transmission/reception point indicated by the uplink reference signal identity, using the

uplink reference signal identity; an SRS generating unit configured to generate a sounding reference signal (SRS) being independent of (*e.g.*, *separately from*) the uplink channel, using a physical cell identity of the one transmission/reception point; and an SRS transmitting unit configured to transmit the generated SRS to the one transmission/reception point.

The SRS may include at least one of a periodic SRS and an aperiodic SRS. The SRS generating unit may be configured to generate both the periodic SRS and the aperiodic SRS using the physical cell identity of the one transmission/reception point. The SRS transmitting unit may be configured to transmit one of the periodic SRS and the aperiodic SRS to the one transmission/reception point indicated by the physical cell identity.

The SRS may include at least one of a periodic SRS and an aperiodic SRS. The SRS generating unit may be configured to generate one of the periodic SRS and the aperiodic SRS using the physical cell identity of the one transmission/reception point, and to generate the other SRS using the uplink reference signal identity. The SRS transmitting unit may be configured to transmit one of the periodic SRS and the aperiodic SRS to the one transmission/reception point indicated by the uplink reference signal identity.

The uplink channel may be at least one of a physical uplink shared channel and a physical uplink control channel.

The receiving unit may be configured to receive information for the UE-specific configuration information through a UE-specific parameter, or to dynamically receive through at least one of a physical downlink control channel (PDCCH) and an enhanced physical downlink control channel (EPDCCH).

In accordance with still another embodiment, user equipment may be provided. The user equipment may include a [receiving unit] *receiver* configured to receive UE-specific configuration information indicating a sounding reference signal (SRS) identity from one [transmission/reception point of] *among* a plurality of [different] transmission/reception points, wherein the SRS identity is [independently distinguished] *an independent identify distinguished* from an uplink reference signal identity for an uplink channel; a [control unit] *controller* configured to generate an SRS using the uplink reference signal identity; and a [transmitting unit] *transmitter* configured to transmit the generated SRS to a transmission/reception point indicated by the SRS identity.

The SRS may include at least one of a periodic SRS and an aperiodic SRS. The UE-specific configuration information [indicating the SRS identity] may indicate a same reference signal identity for the periodic SRS and the aperiodic SRS.

The SRS may include at least one of a periodic SRS and an aperiodic SRS. The UE-specific configuration information [indicating the SRS identity] may indicate a different reference signal identity for the periodic SRS and the aperiodic SRS.

The SRS may include at least one of a periodic SRS and an aperiodic SRS. The [control unit] *controller* may be configured to generate one of the periodic SRS and the aperiodic SRS using the SRS identity, and to generate the other SRS using the physical cell identity of the one transmission/reception point. The [transmitting unit] *transmitter* may be configured to transmit one of the periodic SRS and the aperiodic SRS to the transmission/reception point indicated by the SRS identity, and to transmit the other SRS to the one transmission/reception point.

The uplink channel may be at least one of a physical uplink shared channel and a physical uplink control channel.

The [receiving unit] *receiver* may be configured to receive information for the UE-specific configuration information through a UE-specific parameter, or to dynamically receive through at least one of a physical downlink control channel (PDCCH) and an enhanced physical downlink control channel (EPDCCH).

In accordance with still another embodiment, a method may be provided for transmitting an uplink reference signal in user equipment (UE). The method may include receiving UE-specific configuration information indicating an uplink reference signal identity from one [transmission/reception point of] *among* a plurality of [different] transmission/reception points, wherein the uplink reference signal identity is *an independent [of] identify distinguished from* a physical cell identity of the one transmission/reception point; generating an uplink reference signal associated with an uplink channel, using the uplink reference signal identity; and transmitting the generated uplink reference signal to a transmission/reception point indicated by the uplink reference signal identity.

The uplink channel may be at least one of a physical uplink shared channel and a physical uplink control channel.

The uplink reference signal identity may be a reference signal identity of an uplink demodulation reference signal, and the uplink reference signal may be the uplink demodulation reference signal.

[the] *The* transmission/reception point indicated by the uplink reference signal identity may be a transmission/reception point different from the one transmission/reception point.

In accordance with still another embodiment, user equipment may be provided. The user equipment may include a [receiving unit] *receiver* configured to receive UE-specific configuration information indicating an uplink reference signal identity from one transmission/reception point of a plurality of different transmission/reception points, wherein the uplink reference signal identity is *an independent [of] identify distinguished* a physical cell identity of the one transmission/reception point; a [control unit] *controller* configured to generate an uplink reference signal associated with an uplink channel, using the uplink reference signal identity; and a [transmitting unit] *transmitter* configured to transmit the generated uplink reference signal and the uplink channel to a transmission/reception point indicated by the uplink reference signal identity.

The uplink channel may be at least one of a physical uplink shared channel and a physical uplink control channel.

The uplink reference signal identity may be a reference signal identity of an uplink demodulation reference signal, and the uplink reference signal may be the uplink demodulation reference signal.

The transmission/reception point indicated by the uplink reference signal identity may be a transmission/reception point different from the one transmission/reception point.

#### BRIEF DESCRIPTION OF THE DRAWINGS

FIG. 1 is [an exemplary] *a* diagram illustrating a wireless communication system [to which at least one embodiment may be applied];

FIG. 2 illustrates a typical method of performing uplink/downlink data transmission in a CoMP scenario environment and/or a heterogeneous network environment in which transmission/reception points use different cell identities;

## 5

FIG. 3 illustrates a method of performing uplink/downlink data transmissions in a CoMP scenario environment in which transmission/reception points use the same cell identity;

FIG. 4 is a flowchart illustrating a method of transmitting a sounding reference signal (SRS) in accordance with a first embodiment;

FIG. 5 illustrates independently transmitting a physical uplink channel and an SRS in a CoMP environment in which transmission/reception points use different cell identities (e.g., cell ID #1 and cell ID #2);

FIG. 6 illustrates independently transmitting a physical uplink channel and an SRS in a CoMP environment in which transmission/reception points use the same cell identity (e.g., cell ID #0);

FIG. 7 illustrates independently transmitting not only a physical uplink channel and an SRS but also a periodic SRS and an aperiodic SRS in a CoMP environment in which transmission/reception points use different cell identities (e.g., cell ID #1, cell ID #2, and cell ID #3);

FIG. 8 illustrates independently transmitting a physical uplink channel, an SRS and also a periodic SRS and an aperiodic SRS in a CoMP environment in which transmission/reception points use the same cell identity (e.g., cell ID #0);

FIG. 9 illustrates transmitting a periodic SRS to a serving transmission/reception point serving user equipment, and transmitting an aperiodic SRS to a different transmission/reception point in a CoMP environment in which transmission/reception points use different cell identities (e.g., cell ID #1 and cell ID #2);

FIG. 10 illustrates transmitting a periodic SRS to a serving transmission/reception point serving user equipment, and transmitting, independently from a physical uplink channel, an aperiodic SRS to a different transmission/reception point in a CoMP environment in which transmission/reception points use the same cell identity (e.g., cell ID #0);

FIG. 11 is a flowchart illustrating a method of transmitting an SRS in accordance with [Embodiment 2 of the present invention] a *second embodiment*;

FIG. 12 illustrates transmitting an SRS to a serving transmission/reception point when PUCCH is transmitted to a transmission/reception point other than the serving transmission/reception point, in a CoMP environment in which transmission/reception points use different cell identities (e.g., cell ID #1 and cell ID #2);

FIG. 13 illustrates transmitting an SRS to a serving transmission/reception point when PUCCH is transmitted to a transmission/reception point other than the serving transmission/reception point, in a CoMP environment in which transmission/reception points use the same cell identity (e.g., cell ID #0);

FIG. 14 illustrates transmitting an SRS to a serving transmission/reception point when PUSCH is transmitted to a transmission/reception point other than the serving transmission/reception point, in a CoMP environment in which transmission/reception points use different cell identities (e.g., cell ID #1 and cell ID #2);

FIG. 15 illustrates transmitting an SRS to a serving transmission/reception point when PUSCH is transmitted to a transmission/reception point other than the serving transmission/reception point, in a CoMP environment in which transmission/reception points use the same cell identity (e.g., cell ID #0);

FIG. 16 illustrates transmitting an SRS to a serving transmission/reception point when PUSCH and PUCCH are

## 6

transmitted to a transmission/reception point other than the serving transmission/reception point, in a CoMP environment in which transmission/reception points use different cell identities (e.g., cell ID #1 and cell ID #2);

FIG. 17 illustrates transmitting an SRS to a serving transmission/reception point when PUSCH and PUCCH are transmitted to a transmission/reception point other than the serving transmission/reception point, in a CoMP environment in which transmission/reception points use the same cell identity (e.g., cell ID #0);

FIG. 18 illustrates transmitting a periodic SRS to a serving transmission/reception point and transmitting an aperiodic SRS in association with PUCCH when the PUCCH is transmitted to a transmission/reception point other than the serving transmission/reception point, in a CoMP environment in which transmission/reception points use different cell identities (e.g., cell ID #1 and cell ID #2);

FIG. 19 illustrates transmitting a periodic SRS to a serving transmission/reception point and transmitting an aperiodic SRS in association with PUCCH when the PUCCH is transmitted to a transmission/reception point other than the serving transmission/reception point, in a CoMP environment in which transmission/reception points use the same cell identity (e.g., cell ID #0);

FIG. 20 is a block diagram illustrating user equipment performing an uplink SRS transmission shown in FIG. 4;

FIG. 21 illustrates a position of a symbol carrying an SRS;

FIG. 22 illustrates a non-frequency hopping SRS and a frequency hopping SRS;

FIG. 23 is a flowchart illustrating a method of transmitting an uplink reference signal in accordance with at least one embodiment;

FIG. 24 is a flowchart illustrating a method of transmitting an SRS associated with PUCCH in accordance with at least one embodiment;

FIG. 25 illustrates transmitting all uplink-related channels to a transmission/reception point different from a serving transmission/reception point to which user equipment belongs, in a CoMP environment in which transmission/reception points use different cell identities (e.g., cell ID #1 and cell ID #2);

FIG. 26 illustrates transmitting all uplink-related channels to a transmission/reception point different from a serving transmission/reception point to which user equipment belongs, in a CoMP environment in which transmission/reception points use the same cell identity (e.g., cell ID #0);

FIG. 27 illustrates transmitting an SRS in association with PUCCH, in a CoMP environment in which transmission/reception points use different cell identities (e.g., cell ID #1 and cell ID #2);

FIG. 28 illustrates transmitting an SRS in association with PUCCH, in a CoMP environment in which transmission/reception points use the same cell identity (e.g., cell ID #0);

FIG. 29 illustrates transmitting an aperiodic SRS in association with PUCCH, in a CoMP environment in which transmission/reception points use different cell identities (e.g., cell ID #1 and cell ID #2);

FIG. 30 illustrates transmitting an aperiodic SRS in association with PUCCH, in a CoMP environment in which transmission/reception points use the same cell identity (e.g., cell ID #0);

FIG. 31 is a flowchart illustrating a method of transmitting an SRS associated with PUSCH in accordance with [Embodiment 2 of the present invention] a *second embodiment*;

FIG. 32 illustrates transmitting an SRS in association with PUSCH, in a CoMP environment in which transmission/reception points use different cell identities (e.g., cell ID #1 and cell ID #2);

FIG. 33 illustrates transmitting an SRS in association with PUSCH, in a CoMP environment in which transmission/reception points use the same cell identity (e.g., cell ID #0);

FIG. 34 illustrates transmitting an aperiodic SRS in association with PUSCH, in a CoMP environment in which transmission/reception points use different cell identities (e.g., cell ID #1 and cell ID #2);

FIG. 35 illustrates transmitting an aperiodic SRS in association with PUSCH, in a CoMP environment in which transmission/reception points use the same cell identity (e.g., cell ID #0);

FIG. 36 illustrates user equipment in accordance with [at least] one embodiment;

FIG. 37 illustrates user equipment in accordance with [other embodiments of the present invention] *another embodiment*; and

FIG. 38 illustrates a base station (BS) in accordance with [at least] one embodiment.

#### DETAILED DESCRIPTION OF EMBODIMENTS

Hereinafter, exemplary embodiments of the present [invention] *disclosure* will be described with reference to the accompanying drawings. In the following description, the same elements will be designated by the same reference numerals although they are shown in different drawings. Furthermore, in the following description of the present [invention] *disclosure*, a detailed description of known functions and configurations incorporated herein will be omitted when it may make the subject matter of the present [invention] *disclosure* rather unclear.

A wireless communication system in accordance with at least one embodiment may be widely used in order to provide a variety of communication services such as a voice service, a packet data service, and so forth. The wireless communication system may include user equipment (UE) and at least one transmission/reception point. In the present description, the term “user equipment (UE)” is used as a general concept that includes a terminal in a wireless communication. Accordingly, the user equipment (UE) should be construed as a concept that includes a mobile station (MS), a user terminal (UT), a subscriber station (SS), and/or a wireless device in a global system for mobile communications (GSM), as well as user equipment used in wideband code division multiple access (WCDMA), long term evolution (LTE), and/or high speed packet access (HSPA).

The transmission/reception point generally may indicate a station communicating with the user equipment. However, the transmission/reception point may be referred to as different terms such as a base station (BS), a cell, a Node-B, an evolved Node-B (eNB), a sector, a site, a base transceiver system (BTS), an access point (AP), a relay node (RN), a remote radio head (RRH), a radio unit (RU), an antenna, and the like.

That is, in the present description, the transmission/reception point, the base station (BS), or the cell may be construed as an inclusive concept indicating a portion of an area or a function covered by a base station controller (BSC) in code division multiple access (CDMA), a Node-B in WCDMA, an eNB or a sector (a site) in LTE, and the like. Accordingly, a concept of the transmission/reception point, the base station (BS), and/or the cell may include a variety of coverage areas such as a megacell, a macrocell, a micro-

cell, a picocell, a femtocell, and the like. Furthermore, such concept may include a communication range of the relay node (RN), the remote radio head (RRH), or the radio unit (RU).

In the present description, the user equipment and the transmission/reception point may be two transmission/reception subjects, having an inclusive meaning, which are used to embody the technology and the technical concept disclosed herein, and may not be limited to a specific term or word. Furthermore, the user equipment and the transmission/reception point may be uplink or downlink transmission/reception subjects, having an inclusive meaning, which are used to embody the technology and the technical concept disclosed in connection with the present [invention] *disclosure*, and may not be limited to a specific term or word. Herein, an uplink (UL) transmission/reception is [a scheme in which] data [is transmitted] *transmission and reception* from user equipment to a base station. Unlike this, a downlink (DL) transmission/reception is [a scheme in which] data [is transmitted] *transmission and reception* from the base station to the user equipment.

The wireless communication system may use a variety of multiple access schemes such as CDMA, time division multiple access (TDMA), frequency division multiple access (FDMA), orthogonal frequency division multiple access (OFDMA), OFDM-FDMA, OFDM-TDMA, OFDM-CDMA, and/or the like. Such multiple access schemes, however, are not limited thereto. At least one embodiment may be applied to resource allocation in the field of asynchronous wireless communications evolving to LTE and LTE-advanced (LTE-A) through GSM, WCDMA, and HSPA, and in the field of synchronous wireless communications evolving into CDMA, CDMA-2000, and UMB. The present [invention] *disclosure* should not be construed as being limited to or restricted by a particular wireless communication field, and should be construed as including all technical fields to which the spirit of the present [invention] *disclosure* can be applied.

In case of an uplink transmission and a downlink transmission, at least one of a time division duplex (TDD) and a frequency division duplex (FDD) may be used. Herein, the TDD may perform the uplink/downlink transmissions using different times. The FDD may perform the uplink/downlink transmissions using different frequencies.

In a LTE or LTE-A system in conformance with a corresponding standard, an uplink and/or a downlink may be constituted based on one carrier or a pair of carriers. In case of the uplink and/or downlink, control information may be transmitted through such control channels as a physical downlink control channel (PDCCH), a physical control format indicator channel (PCFICH), a physical hybrid ARQ indicator channel (PHICH), a physical uplink control channel (PUCCH), and/or so forth. Data may be transmitted through such data channels as a physical downlink shared channel (PDSCH), a physical uplink shared channel (PUSCH), and/or the like.

In the description, the term “cell” may indicate one of coverage of a signal transmitted from a transmission point or transmission/reception point, a component carrier having the coverage, and the transmission/reception point. Herein, the term “transmission/reception point” may indicate one of a transmission point transmitting a signal, a reception point receiving a signal, and a combination thereof (i.e., a transmission/reception point).

FIG. 1 is [an exemplary] a diagram illustrating a wireless communication system [to which at least one embodiment may be applied].

Referring to FIG. 1, wireless communication system 100 may be one of a coordinated multi-point transmission/reception (CoMP) system, a coordinated multi-antenna transmission system, and a coordinated multi-cell communication system. Herein, the CoMP system may transmit signals through cooperation between a plurality of transmission/reception points. Wireless communication system 100 such as a CoMP system may include a plurality of transmission/reception points 110 and 112, and at least one user equipment (UE) 120 and 122.

The transmission/reception points may be, as shown in the figure, one of eNB 110 and RRH 112. Herein, eNB 110 may be a base station or a macrocell (or macronode). RRH 112 may be at least one picocell which is wiredly controlled by coupling to eNB 110 through an optical cable or an optical fiber. Furthermore, RRH 112 may have either a high transmission power, or a low transmission power within a macrocell region. Transmission/reception points eNB 110 and RRH 112 may have the same cell identity (ID) or different cell identities.

Hereinafter, a downlink (DL) may represent communication or a communication path from transmission/reception points 110 and 112 to user equipment 120. An uplink (UL) may represent communication or a communication path from user equipment 120 to transmission/reception points 110 and 112. In the downlink, a transmitter may be a portion of transmission/reception points 110 and 112, and a receiver may be a portion of user equipment 120 and 122. In the uplink, a transmitter may be a portion of user equipment 120, and a receiver may be a portion of transmission/reception points 110 and 112.

Hereinafter, [a situation in which a] signal [is transmitted] *transmission* or [received] *reception* through such channels as PUCCH, PUSCH, PDCCH, and/or PDSCH may be referred to as the expression of “transmit or receive PUCCH, PUSCH, PDCCH, and/or PDSCH.”

eNB 110 corresponding to one of transmission/reception points (e.g., 110, 112) may perform a downlink transmission to user equipment 120 and 122. eNB 110 may transmit PDSCH corresponding to a primary physical channel, for unicast transmission. Furthermore, eNB 110 may transmit PDCCH in order to transmit downlink control information, such as scheduling information required for receiving PDSCH, and to transmit scheduling grant information for an uplink shared channel (e.g., PUSCH) transmission. Hereinafter, “transmit or receive a signal through a channel” may be referred to as the expression of “transmit or receive a channel.”

UE 1 (120) may transmit an uplink signal to eNB 110. UE 2 (122) may transmit an uplink signal to RRH 112 corresponding to one of transmission/reception points 110 and 112. Alternatively, UE 1 (120) may transmit an uplink signal to RRH 112, and UE 2 (122) may transmit an uplink signal to eNB 110. The number of user equipment may be “2” or more. In the following embodiments, descriptions will be given under the assumption that one of two user equipment transmits an uplink signal to eNB 110, and the other transmits an uplink signal to RRH 112, though the present [invention] *disclosure* is not so limited.

Meanwhile, in LTE communication systems corresponding to wireless communication systems, a demodulation reference signal (DMRS or DM-RS) and an SRS may be defined for an uplink. Three types of reference signals (RSs) may be defined for a downlink. Herein, the three types of the reference signals (RSs) may include a cell-specific reference

signal (CRS), a multicast/broadcast over single frequency network reference signal (MBSFN-RS), and a UE-specific reference signal.

In a wireless communication system, when performing an uplink transmission, user equipment may transmit an uplink demodulation reference signal (UL DMRS or UL DM-RS) per slot such that channel information for demodulation of data channels is recognized. In case of an uplink DM-RS associated with PUSCH, user equipment may transmit a reference signal through one symbol per slot. In case of an uplink DM-RS associated with PUCCH, user equipment may transmit reference signals through a different number of symbols according to PUCCH formats. For example, in case of PUCCH formats 1, 1a, and 1b, a reference signal may be transmitted through three symbols per slot. In case of PUCCH formats 2, 2a, 2b, and 3, a reference signal may be transmitted through two symbols per slot.

FIG. 2 illustrates a typical method of performing uplink/downlink data transmissions in a CoMP scenario environment and/or a heterogeneous network environment in which transmission/reception points use different cell identities.

Referring to FIG. 2, wireless communication system 100 [to which at least one embodiment is applied] may be a CoMP system implementing a CoMP scenario or a heterogeneous network in which eNB 110 and RRH 112 have different cell identities.

FIG. 3 illustrates a method of performing uplink/downlink data transmissions in a CoMP scenario environment in which transmission/reception points use the same cell identity.

Referring to FIG. 3, wireless communication system 100 [to which at least one embodiment is applied] may be a CoMP system implementing a CoMP scenario in which eNB 110 and RRHs 112a through 112f have the same cell identity.

In the CoMP system shown in FIG. 2 and FIG. 3, in case of DM-RS for PUSCH data demodulation, user equipment may receive parameters for generation of reference signals, from a corresponding transmission/reception point to which the user equipment belongs. Herein, the parameter for reference signal generation may include information on at least one of a sequence group number, a base sequence number, a cyclic shift index, and an orthogonal cover code (OCC) index. The reference signals transmitted by user equipment in wireless communication system 100 may be generated based on the parameters for reference signal generation. The corresponding transmission/reception point may be eNB 110 corresponding to a serving transmission/reception point. Meanwhile, in the case of illustrating a plurality of user equipment in figures, each user equipment may be classified by reference numerals 120a, 120b, 120c, or the like. In the case of illustrating one user equipment in figures, the one user equipment may be denoted by reference numeral 120.

In a certain operation (“operation 1”), eNB 110 may inform user equipment of a corresponding cell identity such that eNB 110 can be identified, and inform the user equipment of a sequence group number and a base sequence number, according to the configuration of sequence-group hopping and sequence hopping determined through radio resource control (RRC). Furthermore, in another operation (“operation 2”), eNB 110 may inform user equipment of PDCCH for an uplink grant, transmitted through a downlink. For example, eNB 110 may inform user equipment of a cyclic shift index and an OCC index for generation of a reference signal to be transmitted by user equipment 120a, through downlink control information (DCI) format 0 and DCI format 4. User equipment may generate an uplink

DM-RS, and transmit the generated uplink DM-RS and PUSCH to eNB 110, through the operation 1 and the operation 2.

In the case of an uplink SRS, a certain transmission/reception point or a certain cell in wireless communication system 100 may transmit parameters for SRS generation (i.e., parameters for generation of the SRS transmitted by user equipment) to the user equipment. Herein, the parameters for SRS generation may include a cell-specific SRS bandwidth, a transmission comb, a UE-specific SRS bandwidth, hopping related configuration parameters, a frequency domain position, a periodicity, a subframe configuration (designating which subframe will transmit an SRS), an antenna configuration (designating the number of antennas transmitting an SRS and the number of antenna ports), a base sequence index, a cyclic shift index (i.e., a reference signal to be used for SRS generation), and so forth. Herein, transmission comb may designate frequency positions assigned at intervals of two types of subcarrier spacing. For example, "0" may denote even subcarriers and "1" denote odd subcarriers. The base sequence index may be an SRS sequence index for generating a corresponding SRS. The SRS sequence index may be determined, based on sequence group number  $u$  used in PUCCH and base sequence number  $v$  defined according to a sequence hopping configuration used for PUSCH. More specifically, a corresponding transmission/reception point (e.g., eNB 110) may transmit the parameters for SRS generation, as RRC parameters, to user equipment 120a. User equipment 120a may receive the parameters for SRS generation from eNB 110, and transmit an uplink SRS to eNB 110.

Furthermore, an aperiodic SRS may be defined along with a periodic SRS. In case of the aperiodic SRS, like a case of the periodic SRS, parameters to be used for generation of the aperiodic SRS may be transmitted, as RRC parameters, to user equipment 120a by a certain transmission/reception point. Herein, the parameters for generation of the aperiodic SRS may include a UE-specific SRS bandwidth of aperiodic SRS, a transmission comb, a frequency domain position, a periodicity, a subframe configuration, an antenna configuration, a base sequence index, a cyclic shift index, and so forth, as defined in wireless communication system 100.

In addition, a certain transmission/reception point may dynamically trigger user equipment 120a through PDCCH such that user equipment 120a can transmit a periodic SRS. When receiving a triggering signal through the PDCCH and RRC parameters, user equipment 120a may transmit an uplink aperiodic SRS.

According to the above-described uplink/downlink data transmission method, when user equipment 120a belonging to a certain transmission/reception point transmits a reference signal, only the certain transmission/reception point may receive the reference signal. Other transmission/reception points may not receive the reference signal because other transmission/reception points cannot know information for generation of the reference signal. Herein, the expression "receive the reference signal" may mean that the reference signal is received not as interference but as a desired signal. That is, the expression may mean that the reference signal is received to meet a purpose of the reference signal transmitted by user equipment.

When receiving parameters from a certain transmission/reception point, user equipment may generate reference signals, such as an uplink DM-RS and/or periodic/aperiodic SRSs, based on the received parameters. Accordingly, user equipment may perform an uplink transmission only through an uplink associated with a downlink of the certain

transmission/reception point to which the user equipment belongs. In other words, user equipment may not perform an uplink transmission through an uplink not being associated with the downlink of the certain transmission/reception point to which the user equipment belongs.

Typically, user equipment 120a belonging to the certain transmission/reception point (i.e., user equipment 120a receiving a downlink control channel from the certain transmission/reception point) may not perform an uplink transmission to a different transmission/reception point (i.e., a transmission/reception point different from the certain transmission/reception point). Herein, the different transmission/reception point may provide an uplink channel having a comparatively better uplink channel quality and/or a comparatively better geometry.

Meanwhile, in at least one embodiment, a method may be provided for supporting an uplink transmission to a different transmission/reception point. More specifically, according to the method, user equipment 120a belonging to a certain transmission/reception point (i.e., user equipment 120a receiving a downlink control channel from the certain transmission/reception point) may perform an uplink transmission to a different transmission/reception point which provides an uplink channel having a comparatively better channel quality and/or a comparatively higher geometry. Furthermore, in at least one embodiment, a method and an apparatus may be provided for differentiating channels transmitted to different transmission/reception points.

Furthermore, in at least one embodiment, a method and an apparatus may be provided for differentiating between an uplink channel (e.g., PUSCH, PUCCH, SRS, and/or an uplink related RS) which user equipment transmits to a corresponding transmission/reception (i.e., a corresponding transmission/reception to which the user equipment belongs) and an uplink channel which the user equipment transmits to a transmission/reception points other than the corresponding transmission/reception. Herein, such channel differentiation may be differentiation between the same type channels such as between SRSs, between PUSCHs, between PUCCHs, between related RSs, and so forth. Such channel differentiation may be differentiation between different type channels such as between SRS and PUSCH, between PUCCH and PUSCH, between PUCCH and SRS, and so forth. For example, a sequence group number and a base sequence number used for periodic and aperiodic SRSs may be defined from a sequence group number  $u$  and a base sequence number  $v$ , respectively. Herein, the sequence group number  $u$  may be used for PUCCH. The base sequence number  $v$  may be defined in sequence hopping used for PUSCH. In at least one embodiment, a method and an apparatus may be provided for differently defining the sequence group number  $u$  and the base sequence number  $v$  used for periodic and aperiodic SRSs.

Hereinafter, the present [invention] disclosure will be described through the following two embodiments: i) a first embodiment (Embodiment 1) determines a receiving subject (i.e., a target transmission/reception point) of an SRS independently from receiving subjects of PUCCH and/or PUSCH by generating an SRS sequence independently from the PUCCH, a reference signal sequence associated with the PUCCH, the PUSCH, and a reference signal sequence associated with the PUSCH; and ii) a second embodiment (Embodiment 2) transmits an SRS without association with PUCCH and PUSCH, to a serving transmission/reception point.

## Embodiment 1: Independent Configuration

In the case of transmitting a periodic SRS or an aperiodic SRS according to [Embodiment 1] *the first embodiment* (Embodiment 1), a sequence group number and a base sequence number for SRS generation may be independently generated, without deriving from PUCCH sequence group number or PUSCH base sequence number based on a cell identity of a serving cell. In order to generate an independent sequence from PUCCH/PUSCH sequences, a sequence group number and a base sequence number for SRS generation may be further included in RRC configuration parameters. Alternatively, in the case that a certain parameter is predefined through PDCCH transmitted dynamically or through RRC parameters, a sequence group number and a base sequence number for SRS generation may be dynamically indicated by transmitting the predefined parameter through PDCCH or EPDCCH.

FIG. 4 is a flowchart illustrating a method of transmitting an SRS in accordance with [Embodiment 1] *the first embodiment* (Embodiment 1) of the present [invention] *disclosure*.

Referring to FIG. 4, in an SRS transmission method according to [Embodiment 1] *the first embodiment* (Embodiment 1), user equipment 120 may receive UE-specific configuration information indicating an SRS identity from one transmission/reception point (e.g., eNB110) [of] among a plurality of different transmission/reception points at step S410. Herein, the SRS identity is independently determined to be distinguished from an uplink reference signal identity for an uplink channel. At step S420, user equipment 120 may generate an SRS using the independently determined SRS identity. At step S425, user equipment 120 may perform a physical uplink channel transmission to eNB110. Meanwhile, at step S430, user equipment 120 may transmit the generated SRS to a transmission/reception point (e.g., RRH 112) indicated by the independently determined SRS identity.

According to the SRS transmission method as shown in FIG. 4, an uplink reference signal identity for an uplink channel and an SRS identity may be independently determined. Accordingly, a receiving subject (e.g., eNB 110) of the uplink channel and a receiving subject (e.g., RRH 112) of the SRS may be different.

In the present description, the expressions “independent,” and “independently” may mean that an SRS identity is separately defined without association with other uplink reference signal identities and/or a physical cell identity of a serving transmission/reception point serving user equipment. Accordingly, the SRS identity may be the same as or different from the other uplink reference signal identities and/or the physical cell identity of the serving transmission/reception point.

That is, in the present description, the expression “an SRS is transmitted independently from an uplink channel” may mean that receiving subjects are independently determined. However, such expression may not mean that transmission timings should be different each other. Accordingly, in an SRS transmission method in accordance with at least one embodiment, an SRS may be independently transmitted when other channel transmissions are not performed. Alternatively, an SRS and at least a portion of an uplink channel (i.e., all or a portion of an uplink channel) may be simultaneously transmitted in one subframe.

In an SRS transmission method in accordance with at least one embodiment, an uplink channel may correspond to at least one of PUSCH and PUCCH. An SRS may be at least one of a periodic SRS and an aperiodic SRS.

Hereinafter, a variety of cases of transmitting an SRS according to [Embodiment 1] *the first embodiment* (Embodiment 1) illustrated in FIG. 4 will be described with reference to FIG. 5 to FIG. 10.

FIG. 5 illustrates independently transmitting a physical uplink channel and an SRS in a CoMP environment in which transmission/reception points use different cell identities (e.g., cell ID #1 and cell ID #2).

FIG. 6 illustrates independently transmitting a physical uplink channel and an SRS in a CoMP environment in which transmission/reception points use the same cell identity (e.g., cell ID #0).

Referring to FIG. 5 and FIG. 6, a receiving subject of a physical uplink channel and a receiving subject of an SRS may be independently determined since an identity for SRS generation is determined independently from an identity for a physical uplink reference signal. Accordingly, even though it is not shown in figures, the physical uplink channel and the SRS may be transmitted to different receiving subjects or the same receiving subject. In this case, it may be necessary to independently determine each receiving subject of the physical uplink channel and the SRS.

According to an SRS transmission method as shown in FIG. 5 and FIG. 6, an SRS sequence may be determined independently from DM-RS associated with PUCCH and/or PUSCH. Accordingly, a TDD system may independently measure a downlink channel quality of a serving transmission/reception point and a downlink channel quality of a different transmission/reception point (i.e., a transmission/reception point different from the serving transmission/reception point). Herein, the TDD system may use an uplink channel quality measurement and a channel reciprocity for the serving transmission/reception point and the different transmission/reception point. Furthermore, the SRS transmission method may allow for recognition of a location or a geometry of user equipment, using an SRS. Accordingly, in the case that user equipment is located on edge of a cell or at the center of the cell, [improvement of] *it is possible to improve* data throughput in a downlink by using a UE-specific downlink transmission method [may be possible].

In embodiments shown in FIG. 5 and FIG. 6, receiving subjects of a periodic SRS and an aperiodic SRS may be the same. That is, a UE-specific parameter indicating an SRS identity may indicate the same reference signal identity for the periodic SRS and the aperiodic SRS.

Unlike the embodiment shown in FIG. 5 and FIG. 6, SRS identities for generating a periodic SRS and an aperiodic SRS may be independent each other.

FIG. 7 illustrates independently transmitting not only a physical uplink channel and an SRS but also a periodic SRS and an aperiodic SRS, in a CoMP environment in which transmission/reception points use different cell identities (e.g., cell ID #1, cell ID #2, and cell ID #3).

FIG. 8 illustrates independently transmitting not only a physical uplink channel and an SRS but also a periodic SRS and an aperiodic SRS, in a CoMP environment in which transmission/reception points use the same cell identity (e.g., cell ID #0).

Referring to FIG. 7 and FIG. 8, UE-specific configuration information indicating an SRS identity may indicate a different reference signal identity for each of the periodic SRS and the aperiodic SRS. Accordingly, the SRS may be transmitted independently from PUCCH and PUSCH. Furthermore, the periodic SRS and the aperiodic SRS may be transmitted independently from each other. FIG. 7 and FIG. 8 illustrate only a case that a receiving subject (e.g., 112b or 110) of the periodic SRS and a receiving subject (e.g., 112a)

of the aperiodic SRS are different. However, in at least one embodiment, each receiving subject for periodic/aperiodic SRSs may be independently determined, and the two receiving subjects may be the same.

According to an SRS transmission method as shown in FIG. 7 and FIG. 8, an SRS sequence may be determined independently from DM-RS associated with PUCCH and/or PUSCH. Furthermore, sequences for a periodic SRS and an aperiodic SRS may be independently determined. Accordingly, a TDD system may independently measure a downlink channel quality of a serving transmission/reception point and a downlink channel quality of a different transmission/reception point. Herein, the TDD system may use an uplink channel quality measurement and a channel reciprocity for the serving transmission/reception point and the different transmission/reception point.

Furthermore, such SRS transmission method may allow for recognition of a location or a geometry of user equipment, using an SRS. Accordingly, in the case that user equipment is located on edge of a cell or at the center of the cell, improvement of data throughput for a downlink by using a UE-specific downlink transmission method may be possible.

FIG. 9 illustrates transmitting a periodic SRS to a serving transmission/reception point serving user equipment, and transmitting an aperiodic SRS to a different transmission/reception point, in a CoMP environment in which transmission/reception points use different cell identities (e.g., cell ID #1 and cell ID #2).

FIG. 10 illustrates transmitting a periodic SRS to a serving transmission/reception point serving user equipment, and transmitting, independently from a physical uplink channel, an aperiodic SRS to a different transmission/reception point, in a CoMP environment in which transmission/reception points use the same cell identity (e.g., cell ID #0).

In other embodiments, not shown in FIG. 9 and FIG. 10, an aperiodic SRS may be transmitted to a serving transmission/reception point serving user equipment. A periodic SRS may be independently transmitted from a physical uplink channel, to another transmission/reception point.

Referring to FIG. 4, FIG. 9, and FIG. 10, in an SRS generation procedure (S420) shown in FIG. 4, one of a periodic SRS and an aperiodic SRS may be generated using an SRS identity, and the other SRS may be generated using a cell identity of a serving transmission/reception point serving user equipment. Herein, the SRS identity may be [independently distinguished] *independent* from an identity for a physical uplink channel. In an SRS transmission procedure (S430), one of the periodic SRS and the aperiodic SRS may be transmitted to a transmission/reception point indicated by the SRS identity, and the other SRS may be transmitted to the serving transmission/reception point.

That is, according to embodiments shown in FIG. 9 and FIG. 10, one of the periodic SRS and the aperiodic SRS may be transmitted independently from a physical uplink channel, and the other may be transmitted to the serving transmission/reception point. In at least one embodiment, a receiving subject of the SRS transmitted independently may be the same as a receiving subject of the physical uplink channel. Furthermore, the SRS may be transmitted to the serving transmission/reception point.

Referring back to FIG. 4, in a procedure (S410) receiving a UE-specific configuration information indicating an SRS identity, the SRS identity may be [independently] *an independent identity* distinguished from an uplink reference signal identity for a physical uplink channel. Herein, the

uplink reference signal identity may be a reference signal identity of an uplink demodulation reference signal (UL DMRS or UL DM-RS).

In a UE-specific configuration information receiving procedure (S410), UE-specific configuration information may include UE-specific parameters which are specifically determined for user equipment 120 belonging to eNB 110. Such UE-specific configuration information may include reference signal identities associated with a physical uplink channel (e.g., PUCCH or PUSCH). Herein, the reference signal identities associated with the physical uplink channel may be used to determine a UE-specific physical uplink channel sequence and a UE-specific reference signal sequence associated with a physical uplink channel. More specifically, the UE-specific configuration information may include UE-specific parameters indicating the reference signal identity  $n_{ID}^{RS}$  associated with PUCCH or a virtual cell identity (VCID) (hereinafter, referred to as  $n_{ID}^{RS}$ ), and a reference signal identity  $n_{ID}^{RS'}$  associated with PUSCH. In this case, the reference signal identity  $n_{ID}^{RS}$  associated with the PUCCH and the reference signal identity  $n_{ID}^{RS'}$  associated with the PUSCH may be different from or the same as a cell-specific parameter indicating a cell identity  $N_{ID}^{cell}$  of a cell to which user equipment 120 belongs.

eNB 110 may dynamically transmit UE-specific configuration information to user equipment 120 through PDCCH/EPDCCH. Herein, the UE-specific configuration information may include UE-specific parameters indicating a reference signal identity  $n_{ID}^{RS}$  associated with PUCCH and a reference signal identity  $n_{ID}^{RS'}$  associated with PUSCH. Alternatively, the UE-specific configuration information may be determined semi-statically by higher layers such as RRC layer, or be determined in advance through RRC. In this case, eNB 110 may provide indication information for use of the pre-determined UE-specific configuration information, through PDCCH/EPDCCH.

For each of PUCCH and PUSCH, user equipment 120 may generate a base sequence for each of a reference signal associated with PUCCH and/or a reference signal associated with PUSCH, using UE-specific configuration information. Herein, the UE-specific configuration information may include a reference signal identity  $n_{ID}^{RS}$  associated with the PUCCH and/or a reference signal identity  $n_{ID}^{RS'}$  associated with the PUSCH. For example, in each case of the PUSCH and the PUCCH, user equipment 120 may generate a base sequence  $\bar{r}_{u,v}(n)$  for DM-RS. Such base sequence (e.g., a base sequence for the PUSCH and a base sequence for the PUCCH) may be differently generated according to a sequence group number  $u$  and a base sequence number  $v$  within a corresponding sequence group. The reference signal identity  $n_{ID}^{RS}$  associated with the PUCCH and/or the reference signal identity  $n_{ID}^{RS'}$  associated with the PUSCH may be used in place of a cell ID  $N_{ID}^{cell}$ , to determine the sequence group number  $u$  and the base sequence number  $v$  within the corresponding sequence group.

User equipment 120 may transmit a DM-RS through an assigned radio resource to a transmission/reception point (e.g., RRH 112) indicated by a reference signal identity. Herein, the DM-RS may be generated using a base sequence, a cyclic shift, and an orthogonal code (or an orthogonal cover code). In case of an uplink DM-RS, user equipment 120 may transmit the uplink DM-RS using a maximum of three symbols per slot.

In addition, user equipment 120 may transmit PUCCH or PUSCH through the same frequency band as a frequency band assigned for an uplink DM-RS associated with each of PUCCH and PUSCH. A transmission/reception point (e.g.,



RRH **112**) capable of receiving DM-RS, among transmission/reception points may receive the PUCCH and the PUSCH, using a received DM-RS.

In this case, receiving subjects of PUCCH/PUSCH may be determined as a serving transmission/reception point **110**, but the present invention is not limited thereto. Receiving subjects of PUCCH/PUSCH may be arbitrarily determined based on a reference signal identity  $n_{ID}^{RS}$  associated with the PUCCH and/or a reference signal identity  $n_{ID}^{RS'}$  associated with the PUSCH. Accordingly, the receiving subjects of the PUCCH and the PUSCH may be determined as a transmission/reception point other than a serving transmission/reception point **110**.

At step **S410**, user equipment **120** may receive UE-specific configuration information. Herein, the UE-specific configuration information may include an SRS identity  $n_{ID}^{SRS}$  determined independently.

At step **S420**, user equipment **120** may generate an SRS, using the received UE-specific configuration information including the independently determined SRS identity  $n_{ID}^{SRS}$ . Hereinafter, such SRS generation procedure (**S420**) will be described in more detail.

An SRS sequence may be generated by a cyclic shift (CS) of a base sequence  $\bar{r}_{u,v}(n)$  based on Zadoff-Chu sequence, as described by Formula 1 and Formula 2 below. Herein, the generated SRS sequence may have length  $M_{sc}^{RS}$  based on resource blocks (RBs) used for an SRS transmission. For example, the length  $M_{sc}^{RS}$  of the SRS sequence = [Number of RSs] × [Number of subcarriers (typically, 12) within an RB] / 2.

$$r_{SRS}^{(\bar{p})}(n) = r_{u,v}^{(\alpha_{\bar{p}})}(n) \quad [\text{Formula 1}]$$

$$r_{u,v}^{(\alpha_{\bar{p}})}(n) = e^{j\alpha_{\bar{p}}n} \bar{r}_{u,v}(n) \quad [\text{Formula 2}]$$

where,  $r_{u,v}^{(\alpha_{\bar{p}})}(n)$  denotes a reference signal (RS) sequence,  $\alpha_{\bar{p}}$  denotes a cyclic shift (CS),  $\bar{r}_{u,v}(n)$  denotes a base sequence,  $0 \leq n < M_{sc}^{RS}$ ,  $M_{sc}^{RS} = mN_{sc}^{RB}$ ,  $1 \leq m \leq N_{RB}^{max, UL}$ , and  $M_{sc}^{RS}$  is the number of subcarriers assigned for UL RS sequence in the frequency domain.

Base sequences may be differently generated according to the sequence group number  $u$ , the base sequence number  $v$  within the group, and a sequence length  $n$ .

In a sequence group hopping, 30 sequence groups may be hopped per slot regardless of the number of resource blocks (RBs) assigned to user equipment.

More specifically, the sequence group number  $u$  in slot  $n_s$  may be defined by a group hopping pattern  $f_{gh}(n_s)$  and a sequence-shift pattern  $f_{ss}$ , according to Formula 3 below.

$$u = (f_{gh}(n_s) + f_{ss}) \bmod 30 \quad [\text{Formula 3}]$$

The sequence group hopping pattern  $f_{gh}(n_s)$  may be the same for PUCCH and PUSCH. However, the sequence-shift pattern  $f_{ss}$  may be different for PUCCH and PUSCH.

The group-hopping pattern  $f_{gh}(n_s)$  may be given by Formula 4 below for PUSCH and PUCCH.

$$f_{gh}(n_s) = \begin{cases} 0 & \text{if group hopping is disabled} \\ \left( \sum_{i=0}^7 c(8n_s + i) \cdot 2^i \right) \bmod 30 & \text{if group hopping is enabled} \end{cases} \quad [\text{Formula 4}]$$

In Formula 4,  $c(i)$  denotes a pseudo-random sequence. When user equipment **120** receives  $n_{ID}^{SRS}$  for an SRS transmission from eNB **110**, the pseudo-random sequence

$c(i)$  may be initialized using a UE-specific parameter  $n_{ID}^{SR}$  in each radio frame. More specifically, the pseudo-random sequence may be initialized with

$$c_{init} = \left\lfloor \frac{n_{ID}^{SRS}}{30} \right\rfloor$$

Definition of the sequence-shift pattern  $f_{ss}$  may be different between PUCCH, PUSCH and SRS. For an SRS, the sequence-shift pattern  $f_{ss}^{SRS}$  may be given by  $f_{ss}^{SRS} = n_{ID}^{SRS} \bmod 30$ .

Sequence hopping may be applied for reference signals of length 6 RBs or larger ( $M_{sc}^{RS} \geq 6N_{sc}^{RB}$ ). For reference-signals of length less than 6 RBs ( $M_{sc}^{RS} < 6N_{sc}^{RB}$ ), the base sequence number  $v$  within the base sequence group may be given by  $v=0$ .

For reference-signals of length 6 RBs or larger ( $M_{sc}^{RS} \geq 6N_{sc}^{RB}$ ), the base sequence number  $v$  within the base sequence group in slot  $n_s$  may be defined by Formula 5 below.

$$v = \begin{cases} c(n_s) & \text{if group hopping is disabled} \\ & \text{and sequence hopping is enabled} \\ 0 & \text{otherwise} \end{cases} \quad [\text{Formula 5}]$$

In Formula 5,  $c(i)$  denotes a pseudo-random sequence. The pseudo-random sequence may be initialized with

$$c_{init} = \left\lfloor \frac{n_{ID}^{SRS}}{30} \right\rfloor \cdot 2^5 + (n_{ID}^{SRS} + \Delta_{ss}) \bmod 30$$

in each radio frame.

The cyclic shift  $\alpha_{\bar{p}}$  may be differently generated for each user equipment and for each antenna port, according to Formula 6 below.

$$\alpha_{\bar{p}} = 2\pi \frac{n_{SRS}^{cs, \bar{p}}}{8} \quad [\text{Formula 6}]$$

$$n_{SRS}^{cs, \bar{p}} = \left( n_{SRS}^{cs} + \frac{8\bar{p}}{N_{ap}} \right) \bmod 8$$

$$\bar{p} \in \{0, 1, \dots, N_{ap} - 1\}$$

In Formula 6,  $n_{SRS}^{cs}$  used to calculate the cyclic shift  $\alpha_{\bar{p}}$  may be transmitted by higher-layer signaling (e.g., RRC). For example, in case of  $n_{SRS}^{cs}$ , a total of 8 values (e.g.,  $n_{SRS}^{cs} = \{0, 1, 2, 3, 4, 5, 6, 7\}$ ) for each user equipment may be transmitted. Cyclic shift  $\alpha_{\bar{p}}$  for each antenna port may be determined based on the transmitted  $n_{SRS}^{cs}$  as described in Formula 6.  $\bar{p}$  denotes an antenna port number index, and  $N_{ap}$  denotes the number of antenna ports used for an SRS transmission.

An SRS sequence may be generated according to Formula 1 using the base sequence of Formula 2 and the cyclic shift (CS)  $\alpha_{\bar{p}}$  of Formula 6. Such SRS sequence generation procedure may be performed in OFDM modulator **2010** shown in FIG. **20**. At step **S430**, user equipment **120** may assign radio resources for SRS transmission, and transmit the generated SRS (e.g., an SRS generated at step **S420**) through the assigned radio resources, to a transmission/reception point (e.g., RRH **112**) indicated by  $n_{ID}^{SRS}$ .

A UE-specific parameter indicating an uplink reference signal identity may indicate the same reference signal identity for a periodic SRS and an aperiodic SRS.

In this case, sequence group numbers and base sequence numbers for the periodic SRS and the aperiodic SRS may be determined as the same value. However, the sequence group numbers and the base sequence numbers for the periodic or aperiodic SRS may be determined independently from a sequence group number and a base sequence number for PUCCH and PUSCH.

That is, an SRS sequence may be determined independently from PUCCH and PUSCH. Accordingly, a TDD system may independently measure a downlink channel quality of a serving transmission/reception point and a downlink channel quality of a different transmission/reception point. Herein, the TDD system may use an uplink channel quality measurement and a channel reciprocity for the serving transmission/reception point and the different transmission/reception point. Furthermore, the SRS transmission method may allow for recognition of a location or a geometry of user equipment, using an SRS. Accordingly, in the case that the user equipment is located on edge of a cell or at the center of the cell, it may be possible to improve data throughput for a downlink by using a UE-specific downlink transmission method.

Meanwhile, sequence group numbers and base sequence numbers used for a periodic SRS and an aperiodic SRS may be assigned independently from each other, through RRC parameters. In at least one embodiment, indication information for corresponding base sequence numbers and sequence group numbers may be included in PDCCH transmitted dynamically. Alternatively, base sequence numbers and sequence group numbers used for a periodic SRS and an aperiodic SRS may be dynamically indicated through a RRC parameter (e.g., a parameter having a length of 1 bit) predefined by RRC signaling.

Accordingly, an SRS sequence may be generated independently from PUCCH and PUSCH. Furthermore, user equipment may transmit an SRS to a serving transmission/reception point or a different transmission/reception point. Therefore, a transmission/reception point (e.g., a base station) received the SRS may flexibly perform a scheduling procedure.

For a periodic SRS and an aperiodic SRS, a transmission to a serving transmission/reception point and a transmission to a different transmission/reception point (i.e., a transmission/reception point other than the serving transmission/reception point) may be independently performed.

In an SRS transmission method, a UE-specific parameter indicating an SRS identity may indicate different reference signal identities for a periodic SRS and an aperiodic SRS.

In this case, a sequence group number and a base sequence number for the periodic SRS may be determined independently from a sequence group number and a base sequence numbers for the aperiodic SRS. Furthermore, the sequence group numbers and the base sequence numbers for the periodic and aperiodic SRSs may be determined independently from a sequence group number and a base sequence number for PUCCH and PUSCH.

For example, in Formula 1 to Formula 6, an SRS may be generated using a periodic SRS identity  $n_{ID}^{SRS}$ , and the generated SRS may be transmitted to a transmission/reception point indicated by the periodic SRS identity  $n_{ID}^{SRS}$ . Meanwhile, an SRS may be generated using an aperiodic SRS identity  $n_{ID}^{SRS'}$  being independent of a periodic SRS identity  $n_{ID}^{SRS}$ . The generated SRS may be transmitted to a transmission/reception point indicated by the aperiodic SRS

identity  $n_{ID}^{SRS'}$ . Herein, the periodic SRS identity  $n_{ID}^{SRS}$  and the aperiodic SRS identity  $n_{ID}^{SRS'}$  may independently indicate a corresponding transmission/reception point for SRS transmission. Furthermore, the periodic SRS identity  $n_{ID}^{SRS}$  and/or the aperiodic SRS identity  $n_{ID}^{SRS'}$  may not necessarily indicate a serving transmission/reception point. Accordingly, the periodic SRS identity  $n_{ID}^{SRS}$  and/or the aperiodic SRS identity  $n_{ID}^{SRS'}$  may indicate a certain transmission/reception points (e.g., eNB 110) other than the serving transmission/reception point.

That is, an SRS sequence may be determined independently from PUCCH and PUSCH. Furthermore, sequences for a periodic SRS and an aperiodic SRS may be independently determined from each other. Accordingly, a TDD system may independently measure a downlink channel quality of a serving transmission/reception point and a downlink channel quality of a different transmission/reception point. Herein, the TDD system may use an uplink channel quality measurement and a channel reciprocity for the serving transmission/reception point and the different transmission/reception point.

Furthermore, the SRS transmission method may allow for recognition of a location or a geometry of user equipment, using an SRS. Accordingly, in the case that user equipment is located on edge of a cell or at the center of the cell, it may be possible to improve data throughput for a downlink by using a UE-specific downlink transmission method.

FIG. 21 illustrates a position of a symbol carrying an SRS. FIG. 22 illustrates a non-frequency hopping SRS and a frequency hopping SRS.

Referring to FIG. 21 and FIG. 22, an SRS may be transmitted by the last symbol of a subframe. In the frequency domain, SRS transmissions should cover the frequency band that is of interest for a frequency-domain scheduling. As illustrated in FIG. 22(a), a sufficiently wideband SRS transmission may be performed such that channel quality of an entire frequency band of interest can be estimated with a single SRS transmission. As illustrated in FIG. 22(b), a sequence of SRS transmissions may jointly cover the entire frequency band of interest, by transmitting a narrowband SRS using hopping in the frequency domain.

As described above, when an SRS is mapped to resource elements, SC-FDMA symbols may be generated by a SC-FDMA generator (not shown in FIG. 20). SRS signals corresponding to the generated SC-FDMA symbols may be transmitted to a corresponding transmission/reception point.

Specific subframes carrying SRSs may be periodically or aperiodically determined. For example, "cell-specific subframes for SRS transmission" (hereinafter, referred to as "cell-specific SRS subframes") may be configured or defined as shown in Table [for] 1 or Table 2 below. Herein, Table 1 and Table 2 may be associated with frequency division duplex (FDD) and time division duplex (TDD), respectively. An SRS may be periodically transmitted in subframes which have a specific configuration period  $T_{SFC}$  and a specific transmission offset  $\Delta_{SFC}$  in each user equipment. Such SRS may be referred to as a periodic SRS or a trigger type 0 SRS. Alternatively, an SRS may be transmitted in subframes which are aperiodically configured. In this case, such SRS may be referred to as an aperiodic SRS or a trigger type 1 SRS.

## 21

TABLE 1

srs-SubframeConfig	Binary	Configuration	
		Period $T_{SFC}$ (subframes)	Transmission offset $\Delta_{SFC}$ (subframes)
0	0000	1	{0}
1	0001	2	{0}
2	0010	2	{1}
3	0011	5	{0}
4	0100	5	{1}
5	0101	5	{2}
6	0110	5	{3}
7	0111	5	{0, 1}
8	1000	5	{2, 3}
9	1001	10	{0}
10	1010	10	{1}
11	1011	10	{2}
12	1100	10	{3}
13	1101	10	{0, 1, 2, 3, 4, 6, 8}
14	1110	10	{0, 1, 2, 3, 4, 5, 6, 8}
15	1111	reserved	reserved

TABLE 2

srs-SubframeConfig	Binary	Configuration Period $T_{SFC}$ (subframes)	Transmission
			offset $\Delta_{SFC}$ (subframes)
0	0000	5	{1}
1	0001	5	{1, 2}
2	0010	5	{1, 3}
3	0011	5	{1, 4}
4	0100	5	{1, 2, 3}
5	0101	5	{1, 2, 4}
6	0110	5	{1, 3, 4}
7	0111	5	{1, 2, 3, 4}
8	1000	10	{1, 2, 6}
9	1001	10	{1, 3, 6}
10	1010	10	{1, 6, 7}
11	1011	10	{1, 2, 6, 8}
12	1100	10	{1, 3, 6, 9}
13	1101	10	{1, 4, 6, 7}
14	1110	reserved	reserved
15	1111	reserved	reserved

Table 1 and Table 2 may represent cell-specific SRS subframes as configuration period  $T_{SFC}$  and transmission offset  $\Delta_{SFC}$  for FDD (frame structure type 1) and TDD (frame structure type 2). The total number of possible cases may be 16. The parameter “srs-SubframeConfig” for each case may be transmitted by higher-layer signaling of 4 bits, such as RRC signaling. For example, in Table 1, in the case that the parameter “srs-SubframeConfig” is 7 (“0111”), a corresponding configuration period  $T_{SFC}$  may be “5” and a corresponding transmission offset  $\Delta_{SFC}$  may be {0,1}. In this case, an SRS may be transmitted in the first and second subframes per five subframes corresponding to the configuration period.

The periodic SRS may represent an SRS transmitted in corresponding subframes which are periodically transmitted according to a specific configuration period  $T_{SFC}$  and a specific transmission offset  $\Delta_{SFC}$  in each user equipment, among the above-described cell-specific SRS subframes.

Meanwhile, Table 3 (FDD) and Table 4 (TDD) below may represent a periodicity and an offset of a UE-specific periodic SRS. Herein, the UE-specific periodic SRS may represent a periodic SRS defined according to each user equipment.

## 22

TABLE 3

SRS Configuration Index	$I_{SRS}$	SRS Periodicity $T_{SRS}$ (ms)	SRS Subframe Offset $T_{offset}$
0-1		2	$I_{SRS}$
2-6		5	$I_{SRS} - 2$
7-16		10	$I_{SRS} - 7$
17-36		20	$I_{SRS} - 17$
37-76		40	$I_{SRS} - 37$
77-156		80	$I_{SRS} - 77$
157-316		160	$I_{SRS} - 157$
317-636		320	$I_{SRS} - 317$
637-1023		Reserved	reserved

TABLE 4

SRS Configuration Index	$I_{SRS}$	SRS Periodicity $T_{SRS}$ (ms)	SRS Subframe Offset $T_{offset}$
0		2	0, 1
1		2	0, 2
2		2	1, 2
3		2	0, 3
4		2	1, 3
5		2	0, 4
6		2	1, 4
7		2	2, 3
8		2	2, 4
9		2	3, 4
10-14		5	$I_{SRS} - 10$
15-24		10	$I_{SRS} - 15$
25-44		20	$I_{SRS} - 25$
45-84		40	$I_{SRS} - 45$
85-164		80	$I_{SRS} - 85$
165-324		160	$I_{SRS} - 165$
325-644		320	$I_{SRS} - 325$
645-1023		reserved	reserved

Table 3 and Table 4 may represent UE-specific periodic SRS subframes as periodicity  $T_{SRS}$  and offset  $T_{offset}$  for FDD and TDD. Herein, UE-specific periodic SRS subframes may be subframes transmitting a UE-specific periodic SRS. The total number of possible cases may be 1024. SRS configuration index  $I_{SRS}$  for each case may be transmitted by higher-layer signaling of 10 bits, such as RRC signaling. For example, in Table 3, in the case that the SRS configuration index  $I_{SRS}$  is 3, a corresponding periodicity  $T_{SRS}$  is “5” and a corresponding offset  $T_{offset}$  is “1”. In this case, a UE-specific periodic SRS may be transmitted in the second subframe per five subframes corresponding to a periodicity.

Information on resource blocks (RBs) when transmitting SRS may be transmitted by higher-layer signaling. Herein, the information on RBs may include the number of “cell-specific occupied RBs” (i.e., all RBs being used for certain cell). More specifically, in case of the cell-specific occupied RBs, occupied RBs (i.e., in-use RBs) may represent specific RBs corresponding to the number of higher-layer signaling among all RBs corresponding to an entire system bandwidth (BW). For example, in the case that system bandwidth is 50 RBs and the number of signaling RBs is 48, it may mean that 48 RBs are used among a total of 50 RBs. Furthermore, the information on RBs may include the number of and positions of “UE-specific occupied RBs” (i.e., RBs being used by a certain user equipment among the cell-specific occupied RBs).

For example, Table 5 may be used in the case that a system bandwidth (e.g., an uplink bandwidth) is 40 to 60 RBs.

In at least one embodiment, Table 5 may be differently defined according to corresponding system bandwidths. The number of cell-specific occupied RBs may be transmitted as

the parameter  $C_{SRS}$ . The number of UE-specific occupied RBs may be defined as the parameter  $B_{SRS}$ . For example, in Table 5 below, in the case that  $C_{SRS}$  is “1” and  $B_{SRS}$  is “2”, the number ( $m_{SRS,0}$ ) of cell-specific RBs used for transmission of all SRSs is “48”. The number ( $m_{SRS,2}$ ) of RBs used for a specific user equipment among the cell-specific RBs used for transmission of all SRSs is “2”. Furthermore, the parameter  $n_{RRC}$  may be defined in order to represent positions of RBs used for each user equipment. Such parameters (e.g.,  $C_{SRS}$ ,  $B_{SRS}$ ,  $n_{RRC}$ ) may be transmitted by higher-layer signaling such as RRC signaling.

TABLE 5

SRS bandwidth configuration	SRS-Bandwidth $B_{SRS}=0$		SRS-Bandwidth $B_{SRS}=1$		SRS-Bandwidth $B_{SRS}=2$		SRS-Bandwidth $B_{SRS}=3$		
	$C_{SRS}$	$m_{SRS,0}$	$N_0$	$m_{SRS,1}$	$N_1$	$m_{SRS,2}$	$N_2$	$m_{SRS,3}$	$N_3$
0	0	48	1	24	2	12	2	4	3
1	1	48	1	16	3	8	2	4	2
2	2	40	1	20	2	4	5	4	1
3	3	36	1	12	3	4	3	4	1
4	4	32	1	16	2	8	2	4	2
5	5	24	1	4	6	4	1	4	1
6	6	20	1	4	5	4	1	4	1
7	7	16	1	4	4	4	1	4	1

Furthermore, information (i.e., a transmission comb) on subcarriers assigned for an SRS may be transmitted by higher-layer signaling such as RRC. The transmission comb may be expressed as the parameter  $k_{TC}$ , and the parameter  $k_{TC}$  may be set as “0” or “1”. For SRS transmission subframes and/or SRS transmission RBs, the parameter  $k_{TC}$  may indicate whether subcarriers substantially transmitting an SRS sequence through a mapping process are even-numbered subcarriers or odd-numbered subcarriers. The transmission comb may also be transmitted by higher-layer signaling (e.g., RRC signaling) performed for each user equipment.

In summary, a transmission unit (e.g., a transmission/reception point) may transmit the following SRS transmission related parameters to user equipment such that the user equipment can transmit a periodic SRS or a trigger type 0 SRS. Herein, such SRS transmission related parameters may include i) parameters (e.g., srs-SubframeConfig,  $I_{SRS}$ ) used for determination of subframes transmitting an SRS, ii) parameters (e.g.,  $C_{SRS}$ ,  $B_{SRS}$ ,  $n_{RRC}$ ) used for determination of resource blocks (RBs) transmitting an SRS, iii) a parameter (e.g.,  $k_{TC}$ ) used for determination of subcarriers assigned for SRS transmission, iv) a parameter (e.g.,  $n_{SRS}^{CS}$ ) used for determination of cyclic shifts between SRSs, and v) the number of antenna ports. Such SRS transmission related parameters may be transmitted by a higher-layer signaling (e.g., RRC signaling). Table 6 below may represent a summary of the above-described SRS transmission related parameters.

TABLE 6

srs-SubframeConfig	$I_{SRS}$	$C_{SRS}$	$B_{SRS}$	$n_{RRC}$	$k_{TC}$	$n_{SRS}^{CS}$	Number of antenna ports
Indicated by higher-layer signaling (RRC signaling)							

Meanwhile, an SRS may be transmitted in SRS subframes which are aperiodically configured, among cell-specific SRS

subframes determined by Table 1 (FDD) or Table 2 (TDD). In this case, such SRS may be referred to as an aperiodic SRS or a trigger type 1SRS.

In this case, an SRS may be aperiodically transmitted in UE-specific subframes determined according to Table 7 (FDD) or Table 8 (TDD), among cell-specific SRS subframes determined by Table 1 or Table 2. Herein, the UE-specific subframes may have a specific periodicity and a specific offset defined according to a corresponding user equipment as described in Table 7 or Table 8. The expression “SRS is aperiodically transmitted” may mean that after some possible cases for SRS transmission are pre-defined, SRS transmission associated with such pre-defined cases may be triggered by dynamic signaling such as downlink control information (DCI), if necessary. As described above, in case of a periodic (trigger type 0) SRS, signaling information for SRS transmission may be directly transmitted by higher-layer signaling. Herein, the signaling information for SRS transmission may include at least one of i) information on SRS transmission subframes, ii) information on SRS transmission resource blocks (RBs), iii) information on subcarriers assigned for SRS transmission, iv) information on cyclic shift used for SRS sequence generation, and v) the number of antenna ports for SRS transmission. Alternatively, in case of an aperiodic (trigger type 1) SRS, some of signaling information for SRS transmission may not be directly transmitted to user equipment. However, the SRS parameter set associated with the some signaling information may be pre-defined by higher-layer signaling (e.g., RRC signaling). Accordingly, only when an SRS transmission is necessary, only a value indicating the pre-defined SRS parameter set may be transmitted by a dynamic signaling such as DCI.

TABLE 7

SRS Configuration Index $I_{SRS}$	SRS Periodicity $T_{SRS,1}$ (ms)	SRS Subframe Offset $T_{offset,1}$
0-1	2	$I_{SRS}$
2-6	5	$I_{SRS} - 2$
7-16	10	$I_{SRS} - 7$
17-31	reserved	reserved

TABLE 8

SRS Configuration Index $I_{SRS}$	SRS Periodicity $T_{SRS,1}$ (ms)	SRS Subframe Offset $T_{offset,1}$
0	2	0, 1
1	2	0, 2
2	2	1, 2
3	2	0, 3
4	2	1, 3
5	2	0, 4
6	2	1, 4
7	2	2, 3
8	2	2, 4
9	2	3, 4
10-14	5	$I_{SRS} - 10$
15-24	10	$I_{SRS} - 15$
25-31	reserved	reserved

For example, in case of an aperiodic (trigger type 1) SRS, an SRS parameter set may include i) the parameter  $I_{SRS}$  used to determine SRS transmission subframes, ii) the parameters  $B_{SRS}$  and  $n_{RRC}$  used to determine SRS transmission resource blocks (RBs), iii) the parameter  $k_{TC}$  used to determine subcarriers assigned for SRS transmission, iv) the parameter  $n_{SRS}^{CS}$  used to determine a cyclic shift of SRS, and v) the

number of antenna ports. However, the parameters srs-SubframeConfig and  $C_{SRS}$  may not be included in the SRS parameter set. In summary, Table 9 below may represent SRS parameters which are included or excluded in the SRS parameter set.

TABLE 9

srs-SubframeConfig	$C_{SRS}$	$I_{SRS}$	$B_{SRS}$	$n_{RRC}$	$k_{TC}$	$n_{SRS}^{CS}$	Number of antenna ports
Indicated by higher-layer signaling (RRC signaling)							SRS parameter sets are configured by higher-layer signaling (RRC signaling) Indicate an SRS parameter set by dynamic signaling (DCI)

In case of DCI format 0, a trigger signal of an aperiodic SRS may have a length of 1 bit. Herein, values transmitted through the trigger signal may be as described in Table 10 below. Meanwhile, in case of DCI format 4, a trigger signal of an aperiodic SRS may have a length of 2 bits. Herein, values transmitted through the trigger signal may be as described in Table 11 below.

TABLE 10

Value of SRS request field (1 bit case)	Description
'0'	No type 1 SRS trigger
'1'	The 1 <sup>st</sup> SRS parameter set configured by higher layers

TABLE 11

Value of SRS request field (2 bits case)	Description
'00'	No type 1 SRS trigger
'01'	The 1 <sup>st</sup> SRS parameter set configured by higher layers
'10'	The 2 <sup>nd</sup> SRS parameter set configured by higher layers
'11'	The 3 <sup>rd</sup> SRS parameter set configured by higher layers

For example, in case of DCI format 4, when a value of an SRS request field is '00', an aperiodic SRS (or a type 1 SRS) may not be transmitted. When a value of the SRS request field is '01', '10', or '11', the aperiodic SRS (or the type 1 SRS) may be transmitted, according to parameters included in a corresponding SRS parameter set. Herein, the SRS parameter set may be configured by higher-layer signaling in advance.

In an SRS transmission method according to [Embodiment 1] *the first embodiment (Embodiment 1)*, independent transmission of periodic/aperiodic SRS(s) may allow for estimation of a channel state of uplink associated with a transmission/reception points (i.e., a different transmission/reception point) other than a serving transmission/reception point. Accordingly, it may be possible to overcome a shortage of uplink coverage.

Further, a TDD system may independently measure a downlink channel quality of a serving transmission/reception point and a downlink channel quality of a different transmission/reception point. Herein, the TDD system may use an uplink channel quality measurement and a channel reciprocity for the serving transmission/reception point and

the different transmission/reception point. Furthermore, the SRS transmission method may allow for recognition of a location or a geometry of user equipment, using an SRS. Accordingly, in the case that user equipment is located on edge of a cell or at the center of the cell, [improvement of] *it may be possible to improve* data throughput for a downlink by using a UE-specific downlink transmission method [may be possible].

When performing a blind decoding of PDCCH according to a sequence configuration of a corresponding SRS, user equipment may perform the following procedure in order to detect a corresponding uplink grant.

In at least one embodiment, indication information for a related base sequence number may be included in PDCCH, or the related base sequence number may be dynamically indicated by RRC parameters (e.g., a parameter having a length of 1 bit) predefined by RRC signaling. In these cases, when performing a search for PDCCH, user equipment may not monitor a common search space but monitor a UE specific search space (or a UE dedicated search space) to find an uplink grant. Herein, the uplink grant may include uplink scheduling information for the user equipment. DCI format 0 and DCI format 4 may correspond to the uplink grant. Accordingly, the user equipment may be configured to monitor the UE specific search space for the uplink grant including the uplink scheduling information when performing a search for PDCCH.

Embodiment 2: Association Release

In an SRS transmission method according to [Embodiment 2] *the second embodiment (Embodiment 2)*, a physical uplink channel may be generated using a reference signal identity, and an SRS may be generated using a physical cell identity of a serving transmission/reception point.

According to [Embodiment 2] *the second embodiment (Embodiment 2)*, at least one of aperiodic and periodic SRSs may be not associated with PUCCH and PUSCH such that the at least one of the aperiodic and periodic SRSs is not subject to configuration of PUCCH/PUSCH sequences. Therefore, a receiving subject for the at least one of aperiodic and periodic SRSs may be determined as the serving transmission/reception point. Meanwhile, a reception point for PUSCH or PUCCH may be determined as a transmission/reception point other than the serving transmission/reception point (i.e., a downlink transmission subject). In other words, in case of generating sequences for PUSCH/PUCCH reference signals, a corresponding receiving subject may be determined as a different transmission/reception point (i.e., a transmission/reception points other than the serving transmission/reception point), by defining UE-specific PUSCH/PUCCH reference signal sequences. Accordingly, a receiving subject of PUSCH/PUCCH and a receiving subject of an SRS may differ, and therefore PUSCH/PUCCH transmissions and an SRS transmission may be separately performed.

FIG. 11 is a flowchart illustrating a method of transmitting an SRS in accordance with [Embodiment 2] *the second embodiment (Embodiment 2)* of the present [invention] *disclosure*.

Referring to FIG. 11, at step S1110 in an SRS transmission method according to [Embodiment 2] *the second embodiment (Embodiment 2)*, user equipment 120 may receive UE-specific configuration information indicating an uplink reference signal identity from one transmission/reception point (e.g., eNB 110) [of] *among* a plurality of different transmission/reception points. Herein, the uplink reference signal identity may be *an independent [of] identify distinguished from* a physical cell identity of the one transmission/

reception point (e.g., eNB 110) and is associated with an uplink channel. At step S1120, user equipment 120 may generate an SRS, using a physical cell identity of the one transmission/reception point. Herein, the one transmission/reception point may be a transmission/reception point serving user equipment 120. At step S1130, user equipment 120 may transmit an uplink channel and related reference signals (e.g., a demodulation reference signal (DM-RS) associated with the uplink channel), using the uplink reference signal identity. More specifically, user equipment 120 may transmit *the uplink channel and related reference signals* to a transmission/reception point (e.g., RRH 112) indicated by the uplink reference signal identity. At step S1140, user equipment 120 may transmit the generated SRS (S1120) to the one transmission/reception point, i.e., the serving transmission/reception point (e.g., eNB 110).

Herein, the SRS may include at least one of a periodic SRS and an aperiodic SRS. The uplink channel may include at least one of PUCCH and PUSCH.

A receiving subject of the uplink channel transmitted at step S1130 is determined to be a transmission/reception point (e.g., RRH 112) different from the serving transmission/reception point (e.g., eNB 110) serving user equipment 120. Thus, a receiving subject of an uplink channel may be independently determined by an uplink reference signal identity. However, a transmission/reception point (e.g., eNB 110) serving user equipment 120 may not necessarily be excluded from a receiving subject of the uplink channel.

In an SRS transmission method described with reference to FIG. 11, an SRS may be independently transmitted while other channels are not transmitted. Alternatively, the SRS and at least one of PUCCH and PUSCH may be simultaneously transmitted in one sub frame.

As described above, an SRS may include at least one of a periodic SRS and an aperiodic SRS. An uplink channel may include at least one of PUCCH and PUSCH. Accordingly, in the case that an SRS transmission is performed according to the method shown in FIG. 11, a variety of embodiments may be present.

Hereinafter, a variety of embodiments of transmitting an SRS according to an SRS transmission method illustrated in FIG. 11 will be described with reference to FIG. 12 to FIG. 19.

FIG. 12 illustrates transmitting an SRS to a serving transmission/reception point when PUCCH is transmitted to a transmission/reception point other than the serving transmission/reception point, in a CoMP environment in which transmission/reception points use different cell identities (e.g., cell ID #1 and cell ID #2).

FIG. 13 illustrates transmitting an SRS to a serving transmission/reception point when PUCCH is transmitted to a transmission/reception point other than the serving transmission/reception point, in a CoMP environment in which transmission/reception points use the same cell identity (e.g., cell ID #0).

Referring to FIG. 12 and FIG. 13, in the case that DM-RS identity of PUCCH is defined to indicate a transmission/reception point different from a serving transmission/reception point, the SRS may be transmitted to the serving transmission/reception point. Accordingly, the SRS and PUCCH may be separately transmitted.

FIG. 14 illustrates transmitting an SRS to a serving transmission/reception point when PUSCH is transmitted to a transmission/reception point other than the serving transmission/reception point, in a CoMP environment in which transmission/reception points use different cell identities (e.g., cell ID #1 and cell ID #2).

FIG. 15 illustrates transmitting an SRS to a serving transmission/reception point when PUSCH is transmitted to a transmission/reception point other than the serving transmission/reception point, in a CoMP environment in which transmission/reception points use the same cell identity (e.g., cell ID #0).

Referring to FIG. 14 and FIG. 15, in the case that DM-RS identity of PUSCH is defined to indicate a transmission/reception point different from the serving transmission/reception point, the SRS may be transmitted to the serving transmission/reception point. Accordingly, the SRS and PUSCH may be separately transmitted.

FIG. 16 illustrates transmitting an SRS to a serving transmission/reception point when PUSCH and PUCCH are transmitted to a transmission/reception point other than the serving transmission/reception point, in a CoMP environment in which transmission/reception points use different cell identities (e.g., cell ID #1 and cell ID #2).

FIG. 17 illustrates transmitting an SRS to a serving transmission/reception point when PUSCH and PUCCH are transmitted to a transmission/reception point other than the serving transmission/reception point, in a CoMP environment in which transmission/reception points use the same cell identity (e.g., cell ID #0).

Referring to FIG. 16 and FIG. 17, in the case that DM-RS identities of PUSCH and PUCCH are defined to indicate a transmission/reception point different from a serving transmission/reception point, the SRS may be transmitted to the serving transmission/reception point. Accordingly, the SRS and PUSCH/PUCCH may be separately transmitted.

In an SRS transmission method as described in FIG. 11, an SRS generated based on a physical cell identity of a serving transmission/reception point may be at least one of a periodic SRS and an aperiodic SRS. Accordingly, the periodic SRS and the aperiodic SRS may be transmitted to the serving transmission/reception point, independently from an uplink channel. In at least one embodiment, one of the periodic SRS and the aperiodic SRS may be generated using the cell identity of the serving transmission/reception point, and the other SRS may be generated using an uplink reference signal identity.

That is, a sequence group number and a base sequence number of an aperiodic SRS sequence may be defined according to a sequence configuration of PUCCH or PUSCH. However, a sequence group number and a base sequence number of the periodic SRS sequence may be defined such that the periodic SRS is transmitted to the serving transmission/reception point.

In other words, an aperiodic SRS may be generated using a reference signal identity  $n_{ID}^{RS}$  associated with PUCCH or a reference signal identity  $n_{ID}^{RS'}$  associated with PUSCH, as described in Formula 1 to Formula 6. Meanwhile, a periodic SRS may be generated using a cell ID  $N_{ID}^{cell}$ . Hereinafter, a variety of embodiments for such SRS generation will be described with reference to FIG. 18 and FIG. 19.

FIG. 18 illustrates transmitting a periodic SRS to a serving transmission/reception point and transmitting an aperiodic SRS in association with PUCCH when the PUCCH is transmitted to a transmission/reception point other than the serving transmission/reception point, in a CoMP environment in which transmission/reception points use different cell identities (e.g., cell ID #1 and cell ID #2).

FIG. 19 illustrates transmitting a periodic SRS to a serving transmission/reception point and transmitting an aperiodic SRS in association with PUCCH when the PUCCH is transmitted to a transmission/reception point other than the serving transmission/reception point, in a

CoMP environment in which transmission/reception points use the same cell identity (e.g., cell ID #0).

As described in FIG. 18 and FIG. 19, the periodic SRS may be transmitted to the serving transmission/reception point, and the aperiodic SRS may be transmitted in association with the PUCCH, but the present [invention] disclosure is not limited thereto. On the contrary, the aperiodic SRS may be transmitted to the serving transmission/reception point, and the periodic SRS may be transmitted in association with the PUCCH. In some embodiments of the present [invention] disclosure, the aperiodic SRS or the periodic SRS may be associated with PUSCH other than the PUCCH.

Referring to FIG. 11, FIG. 18, and FIG. 19, in an SRS generation procedure of step S1120, one of a periodic SRS and an aperiodic SRS may be generated using a physical cell identity of a serving transmission/reception point (e.g., eNB 110), and the other SRS may be generated using an uplink reference signal identity. In an SRS transmission procedure of S1140, one of the periodic SRS and the aperiodic SRS may be transmitted to the serving transmission/reception point (e.g., eNB 110), and the other SRS may be transmitted to a transmission/reception point (e.g., RRH 112) indicated by the uplink reference signal identity.

Referring back to FIG. 11, at step S1110, eNB 110 corresponding to a certain transmission/reception point may transmit UE-specific configuration information to user equipment 120 belonging to eNB 110. Accordingly, user equipment 120 may receive the UE-specific configuration information at step S1110.

The UE-specific configuration information may include UE-specific parameters which are specifically determined for user equipment 120 belonging to eNB 110. For example, the UE-specific configuration information may include UE-specific parameters indicating a reference signal identity  $n_{ID}^{RS}$  associated with PUCCH and a reference signal identity  $n_{ID}^{RS'}$  associated with PUSCH. Herein, the reference signal identity  $n_{ID}^{RS}$  associated with the PUCCH may be used to determine a UE-specific PUCCH sequence and a UE-specific reference signal sequence associated with the PUCCH. The reference signal identity  $n_{ID}^{RS'}$  associated with PUSCH may be used to determine a UE-specific PUSCH sequence and a UE-specific reference signal sequence associated with the PUSCH. UE-specific parameters indicating the reference signal identities  $n_{ID}^{RS}$  and  $n_{ID}^{RS'}$  associated with PUCCH/PUSCH may be different from a cell-specific parameter indicating a cell ID ( $N_{ID}^{cell}$ ) of a cell to which user equipment 120 belongs.

eNB 110 may dynamically transmit the UE-specific configuration information to user equipment 120 through PDCCH/EPDCCH. Herein, the UE-specific configuration information may include UE-specific parameters indicating a reference signal identity  $n_{ID}^{RS}$  associated with PUCCH and a reference signal identity  $n_{ID}^{RS'}$  associated with PUSCH. Alternatively, the UE-specific configuration information may be determined semi-statically by higher layers such as RRC layer, or be determined in advance through RRC. In this case, eNB 110 may provide indication information for use of the pre-determined UE-specific configuration information, through PDCCH/EPDCCH.

For each of PUCCH and PUSCH, user equipment 120 may generate a base sequence for each of a reference signal associated with PUCCH and/or a reference signal associated with PUSCH, using UE-specific configuration information. Herein, the UE-specific configuration information may include a reference signal identity  $n_{ID}^{RS}$  associated with PUCCH and/or a reference signal identity  $n_{ID}^{RS'}$  associated

with PUSCH. For example, in each case of PUSCH and PUCCH, user equipment 120 may generate base sequences  $\bar{r}_{u,v}(n)$  for DM-RS. Such base sequences (e.g., a base sequence for PUSCH and a base sequence for PUCCH) may be differently generated according to a sequence group number  $u$  and a base sequence number  $v$  within a corresponding sequence group. The reference signal identity  $n_{ID}^{RS}$  associated with the PUCCH and/or the reference signal identity  $n_{ID}^{RS'}$  associated with the PUSCH may be used in place of a cell ID  $N_{ID}^{cell}$  to determine the sequence group number  $u$  and the base sequence number  $v$  within the corresponding sequence group.

At step S1130, user equipment 120 may transmit a DM-RS through an assigned radio resource to a transmission/reception point (e.g., RRH 112) indicated by the reference signal identity  $n_{ID}^{RS}$  associated with the PUCCH or the reference signal identity  $n_{ID}^{RS'}$  associated with the PUSCH. Herein, the DM-RS may be generated using a base sequence, a cyclic shift, and an orthogonal code (or an orthogonal cover code). In case of an uplink DM-RS associated with PUCCH or PUSCH, user equipment 120 may transmit the uplink DM-RS using a maximum of three symbols per slot.

In addition, at step S1130, user equipment 120 may transmit PUCCH through the same frequency band as a frequency band assigned for an uplink DM-RS associated with the PUCCH. Furthermore, at step S1130, user equipment 120 may transmit PUSCH through the same frequency band as a frequency band assigned for an uplink DM-RS associated with the PUSCH. Only RRH 112 corresponding to a transmission/reception point capable of receiving DM-RS among transmission/reception points may receive the PUCCH or PUSCH using the received DM-RS.

At step S1120, user equipment 120 may generate an SRS using UE-specific configuration information including cell ID  $N_{ID}^{cell}$  of a serving transmission/reception point such that a receiving subject of the SRS is the serving transmission/reception point regardless of configuration of a reception point for PUSCH or PUCCH. An SRS generation procedure described at step S1120 may be substantially the same as an SRS generation procedure (step S420) of [Embodiment 1] the first embodiment (Embodiment 1) described with reference to FIG. 4, except that the cell ID  $N_{ID}^{cell}$  of the serving transmission/reception point is used when generating the SRS according to Formula 1 to Formula 6.

At step S1120, SRS sequence may be generated by Formula 1 using a base sequence defined by Formula 2 and a cyclic shift (CS)  $\alpha_p$  defined by Formula 6. Such SRS sequence generation procedure (S1120) may be performed by OFDM modulator 2010 shown in FIG. 20.

At step S1140, user equipment 120 may assign radio resources for SRS transmission, and transmit the generated SRS (S1120) through the assigned radio resources, to a transmission/reception point (e.g., eNB 110) indicated by  $N_{ID}^{cell}$ .

At step S1140, DM-RS sequences generated by Formula 1 may be mapped to corresponding symbols of a subframe. Such operation of S1140 may be performed through resource element mapper 2020 shown in FIG. 20.

As shown in FIG. 21 and FIG. 22, an SRS may be transmitted by the last symbol of a subframe. A sufficiently wideband SRS transmission may be performed such that channel quality of an entire frequency band of interest can be estimated with a single SRS transmission. Alternatively, a sequence of SRS transmissions may jointly cover the entire frequency band of interest, by transmitting a narrowband SRS using hopping in the frequency domain.

As described above, when the SRS is mapped to resource elements, SC-FDMA symbols may be generated by a SC-FDMA generator (not shown in FIG. 20). SRS signals corresponding to the generated SC-FDMA symbols may be transmitted to a corresponding transmission/reception point.

In *the second embodiment* (Embodiment 2) described above, in the case that reception points of PUCCH or PUSCH are determined as a transmission/reception points different from a serving transmission/reception point, a receiving subject of an SRS may be determined as the serving transmission/reception point. That is, the SRS may be transmitted in a state that an association relation between the SRS and the PUCCH/PUSCH is released. Such transmission of the SRS may allow for estimation of an uplink channel state of the serving transmission/reception point. Meanwhile, the PUCCH or PUSCH may be transmitted to a transmission/reception point different from the serving transmission/reception point such that MU-MIMO can be applied to secure channel reliability and to improve an uplink transmission speed. Herein, the different transmission/reception point may have a comparatively higher geometry. Accordingly, it may be possible to overcome a shortage of uplink coverage and to increase an uplink transmission speed.

As described in *the first and second embodiments* (Embodiment 1 and Embodiment 2), in the case of transmitting a periodic SRS and/or an aperiodic SRS, an SRS sequence may be defined independently from the PUCCH and/or the PUSCH. In the case that receiving subjects of the PUCCH and/or the PUSCH are not a serving transmission/reception point, an SRS sequence may be defined such that a receiving subject of the SRS is the serving transmission/reception point.

In some embodiments different from *the first and second embodiments* (Embodiment 1 and Embodiment 2), in the case of transmitting a periodic SRS and/or an aperiodic SRS, a sequence group number and a base sequence number of an SRS sequence for SRS generation may be generated in association with a PUCCH sequence or a PUSCH sequence.

Hereinafter, a transmission procedure of an uplink reference signal will be priorly described in order to explain a procedure transmitting an SRS in association with PUCCH or PUSCH.

FIG. 23 is a flowchart illustrating a method of transmitting an uplink reference signal in user equipment in accordance with at least one embodiment.

Referring to FIG. 23, at step S2310, user equipment 120 may receive UE-specific configuration information indicating an uplink reference signal identity from one transmission/reception point (e.g., eNB 110) [of] among a plurality of [different] transmission/reception points. Herein, the uplink reference signal identity may be independent of a physical cell identity of the one transmission/reception point (e.g., eNB 110) and be associated with an uplink channel. At step S2320, user equipment 120 may generate an uplink reference signal associated with the uplink channel, using the uplink reference signal identity. At step S2330, user equipment 120 may transmit the generated uplink reference signal to a transmission/reception point (e.g., RRH 112) indicated by the uplink reference signal identity.

In the above-described method of transmitting an uplink reference signal, the uplink reference signal may be a DM-RS for demodulation of a physical uplink channel. Herein, the physical uplink channel may be at least one of PUCCH and PUSCH.

According to an uplink reference signal transmission method described in FIG. 23, an uplink reference signal may

be generated from an uplink reference signal identity. Herein, the uplink reference signal identity may be an independent [of] identity distinguished from a physical cell identity of a transmission/reception point (e.g., eNB 110) performing a downlink channel transmission to user equipment 120. Accordingly, a receiving subject of the uplink reference signal transmitted by user equipment 120 may be determined as a transmission/reception point (e.g., RRH 112) other than the transmission/reception point (e.g., eNB 110) performing a downlink channel transmission. In at least one embodiment, even though not shown in FIG. 4, as long as a receiving subject of an uplink reference signal is necessary to be independently determined, the receiving subject of the uplink reference signal may be the transmission/reception point (e.g., eNB 110) performing a downlink channel transmission.

When an uplink reference signal is generated from an independent uplink reference signal identity as described in FIG. 23, an SRS may also be generated from the same uplink reference signal identity.

As described above, when an uplink reference signal sequence and an SRS sequence are generated from the same uplink reference signal identity, receiving subjects of these sequences may be the same by establishing an association relation between a physical uplink channel and an SRS. That is, the SRS may be transmitted in association with the uplink channel.

As described above, the SRS may include at least one of a periodic SRS and an aperiodic SRS.

According to an uplink reference signal transmission method described in FIG. 23, receiving subjects of an uplink reference signal may be variously changed. In case of transmitting an SRS associated with such uplink reference signal, periodic or aperiodic SRSs may be associated with a physical uplink channel, i.e., PUCCH or PUSCH. In this case, a variety of embodiments may be present.

Hereinafter, a method of transmitting an SRS associated with an uplink reference signal as shown in FIG. 23 will be described according to each of *a third embodiment* (Embodiment 3) and *a fourth embodiment* (Embodiment 4) below.

Embodiment 3: Association with PUCCH

*The third embodiment* (Embodiment 3) may represent a case in which a physical uplink channel is PUCCH. In other words, in *the third embodiment* (Embodiment 3), an SRS may be transmitted in association with PUCCH. *The fourth embodiment* (Embodiment 4) may represent a case in which a physical uplink channel is PUSCH. In other words, in *the fourth* (Embodiment 4), an SRS may be transmitted in association with PUSCH.

FIG. 24 is a flowchart illustrating a method of transmitting an SRS associated with PUCCH in accordance with at least one embodiment. In an SRS transmission method described in FIG. 24, an SRS may be transmitted in association with an uplink reference signal. Accordingly, the flowchart shown in FIG. 24 may include a transmission procedure transmitting an uplink reference signal and a physical uplink channel associated with the uplink reference signal as shown in FIG. 23.

Referring to FIG. 24, at step S2410 in an SRS transmission method according to *the third embodiment* (Embodiment 3), user equipment 120 may receive UE-specific configuration information indicating an uplink reference signal identity from one transmission/reception point (e.g., eNB 110) of a plurality of different transmission/reception points. Herein, the uplink reference signal identity may be an independent [of] identity distinguished from a physical cell identity of the one transmission/reception point (e.g., eNB



110) and be associated with PUCCH. At step S2420, user equipment 120 may generate at least a portion of an SRS (i.e., all or a portion of an SRS), using the uplink reference signal identity. At step S2430, user equipment 120 may transmit a reference signal associated with the PUCCH, to a transmission/reception point (e.g., RRH 112) indicated by the uplink reference signal identity. At step S2440, user equipment 120 may transmit PUCCH to the transmission/reception point (e.g., RRH 112) indicated by the uplink reference signal identity. At step S2450, user equipment 120 may transmit the generated SRS to the transmission/reception point (e.g., RRH 112) indicated by the uplink reference signal identity.

In FIG. 24, steps S2430 and S2440 may be simultaneously performed. The SRS and the PUCCH may be transmitted together in one subframe.

According to *the third embodiment* (Embodiment 3) shown in FIG. 24, a reception point of PUCCH may be determined as a transmission/reception point different from a serving transmission/reception point to which user equipment belongs. That is, a PUCCH transmission to the different transmission/reception points may be performed by defining a UE-specific PUCCH sequence and a UE-specific reference signal sequence associated with the PUCCH when PUCCH sequence and a reference signal sequence associated with the PUCCH sequence are generated. In this case, a periodic SRS or an aperiodic SRS may be defined according to a sequence configuration for PUCCH and a reference signal associated with the PUCCH. Accordingly, the PUCCH and an SRS may be transmitted to the same target transmission/reception point through an uplink.

FIG. 25 to FIG. 30 illustrate a variety of embodiments transmitting at least a portion of an SRS associated with PUCCH, according to an SRS transmission method shown in FIG. 24.

FIG. 25 illustrates transmitting all uplink-related channels to a transmission/reception point different from a serving transmission/reception point to which user equipment belongs, in a CoMP environment in which transmission/reception points use different cell identities (e.g., cell ID #1 and cell ID #2).

FIG. 26 illustrates transmitting all uplink-related channels to a transmission/reception point different from a serving transmission/reception point to which user equipment belongs, in a CoMP environment in which transmission/reception points use the same cell identity (e.g., cell ID #0).

Referring to FIG. 25 and FIG. 26, an SRS and PUCCH may be transmitted to the same transmission/reception point due to association between the SRS and the PUCCH. When PUCCH and PUSCH are transmitted to a transmission/reception points (e.g., RRH 112) different from a serving transmission/reception point (e.g., eNB 110) to which user equipment 120 belongs, an SRS of user equipment 120 may be transmitted along with the PUCCH and the PUSCH, to the different transmission/reception point (e.g., RRH 112). Herein, the different transmission/reception points (e.g., RRH 112) may have a comparatively higher geometry and a comparatively better channel quality. Accordingly, all uplink channels (e.g., PUCCH, PUSCH, and SRS) may be transmitted to the different transmission/reception points (e.g., RRH 112).

FIG. 27 illustrates transmitting an SRS in association with PUCCH, in a CoMP environment in which transmission/reception points use different cell identities (e.g., cell ID #1 and cell ID #2).

FIG. 28 illustrates transmitting an SRS in association with PUCCH, in a CoMP environment in which transmission/reception points use the same cell identity (e.g., cell ID #0).

Referring to FIG. 27 and FIG. 28, a physical downlink control channel (PDCCH) and a physical downlink shared channel (PDSCH) may be received from a serving transmission/reception point (e.g., eNB 110) to which user equipment 120 belongs. PUSCH may be transmitted to the serving transmission/reception point (e.g., eNB 110) to which user equipment 120 belongs. PUCCH and an SRS may be transmitted to a transmission/reception point (e.g., RRH 112) different from the serving transmission/reception point (e.g., eNB 110) to which user equipment 120 belongs. Herein, the PUCCH corresponding to one of uplink channels may transmit ACK/NACK corresponding to a response to a downlink transmission, channel state information, and so forth.

FIG. 29 illustrates transmitting an aperiodic SRS in association with PUCCH, in a CoMP environment in which transmission/reception points use different cell identities (e.g., cell ID #1 and cell ID #2).

FIG. 30 illustrates transmitting an aperiodic SRS in association with PUCCH, in a CoMP environment in which transmission/reception points use the same cell identity (e.g., cell ID #0).

Referring to FIG. 29 and FIG. 30, PDCCH and PDSCH may be received from a serving transmission/reception point (e.g., eNB 110) to which user equipment 120 belongs. PUSCH and a periodic SRS may be transmitted to the serving transmission/reception point (e.g., eNB 110) to which user equipment 120 belongs. PUCCH and an aperiodic SRS may be transmitted to a transmission/reception point (e.g., RRH 112) different from the serving transmission/reception point (e.g., eNB 110) to which user equipment 120 belongs. Herein, the PUCCH corresponding to one of uplink channels may transmit ACK/NACK corresponding to a response to a downlink transmission, channel state information, and so forth.

According to an uplink reference signal transmission method described with reference to FIG. 23, and *the third embodiment* (Embodiment 3) related to an SRS transmission described with reference to FIG. 24 to FIG. 30, UE-specific configuration information received by user equipment may include reference signal identities  $n_{ID}^{RS}$  and  $n_{ID}^{RS'}$ . Herein, the reference signal identity  $n_{ID}^{RS}$  may be used to determine a UE-specific PUCCH and a UE-specific reference signal identity associated with PUCCH. The reference signal identity  $n_{ID}^{RS'}$  may be used to determine a UE-specific PUSCH and a UE-specific reference signal identity associated with PUSCH. In this case, the reference signal identity  $n_{ID}^{RS}$  associated with the PUCCH and the reference signal identity  $n_{ID}^{RS'}$  associated with the PUSCH may be different from or the same as a cell-specific parameter indicating a cell ID ( $N_{ID}^{cell}$ ) of a cell to which user equipment 120 belongs. A receiving subject of a physical uplink channel (e.g., PUCCH or PUSCH) may be determined as a transmission/reception point different from a serving transmission/reception point (e.g., eNB 110) serving user equipment 120, by independently defining a reference signal identity for PUCCH/PUSCH generation. In the case that a reference signal identity associated with the PUCCH is  $n_{ID}^{RS}$ , an SRS identity may be identically defined as  $n_{ID}^{RS}$ . Accordingly, when generating an SRS,  $n_{ID}^{RS}$  may be used in place of a serving cell ID  $N_{ID}^{cell}$ . That is, in Formula 1 to Formula 6 used in an SRS sequence generation procedure, an SRS may be generated using the reference signal identity  $n_{ID}^{RS}$  associated with the PUCCH. The generated SRS may be trans-

mitted to a transmission/reception point (e.g., RRH 112) indicated by the used reference signal identity. In addition,  $n_{ID}^{RS}$  may not necessarily indicate a transmission/reception point (e.g., RRH 112) different from a serving transmission/reception point, and may indicate the serving transmission/reception point (e.g., eNB 110).

Furthermore, in FIG. 24, an SRS may be at least one of a periodic SRS and an aperiodic SRS. Accordingly, only the aperiodic SRS may be transmitted in association with PUCCH, as described with reference to FIG. 29 and FIG. 30.

Receiving subjects may be different according to whether an SRS to be transmitted is a periodic SRS or an aperiodic SRS. For example, the periodic SRS may be transmitted to a serving transmission/reception point serving user equipment 120. The aperiodic SRS may be defined according to a sequence configuration used for PUCCH. Accordingly, the PUCCH and the aperiodic SRS may be transmitted to the same target transmission/reception point.

In other words, the aperiodic SRS may be generated using the reference signal identity  $n_{ID}^{RS}$  associated with PUCCH, in Formula 1 to Formula 6. The generated aperiodic SRS may be transmitted to a transmission/reception point (e.g., RRH 112) indicated by the reference signal identity  $n_{ID}^{RS}$  associated with the PUCCH. Meanwhile, the periodic SRS may be generated using a cell ID ( $N_{ID}^{cell}$ ) of a serving transmission/reception point (e.g., eNB 110) in Formula 1 to Formula 6. The periodic SRS may be transmitted to the serving transmission/reception point.

On the contrary, even though it is not shown in figures, an aperiodic SRS may be transmitted to a serving transmission/reception point serving user equipment 120. A periodic SRS may be defined according to a sequence configuration used for PUCCH. Accordingly, the PUCCH and the periodic SRS may be transmitted to the same target transmission/reception point.

In an SRS transmission method according to *the third embodiment* (Embodiment 3), an SRS transmission associated with PUCCH may make it to estimate an uplink channel state of a transmission/reception points different from a serving transmission/reception point. Accordingly, overcoming a shortage of uplink coverage may be possible.

Further, a TDD system may independently measure downlink channel quality of a serving transmission/reception point and a downlink channel quality of a different transmission/reception point (i.e., a transmission/reception points different from a serving transmission/reception point). Herein, the TDD system may use an uplink channel quality measurement and a channel reciprocity for the serving transmission/reception point and the different transmission/reception point. Furthermore, the SRS transmission method may make it possible to recognize a location or a geometry of user equipment, using an SRS. Accordingly, in the case that user equipment is located on edge of a cell or at the center of the cell, it may be possible to improve data throughput for a downlink by using a UE-specific downlink transmission method.

In at least one embodiment, only an aperiodic SRS may be transmitted in association with PUCCH. In such embodiment, an aperiodic SRS transmission triggered by a base station may make it to estimate an uplink channel state of a transmission/reception point different from a serving transmission/reception point. Accordingly, overcoming a shortage of uplink coverage may be possible.

Embodiment 4: Association with PUSCH

*The fourth embodiment* (Embodiment 4) may represent a case in which at least a portion of an SRS is transmitted in

association with PUSCH. Hereinafter, *the fourth embodiment* (Embodiment 4) will be described with reference to FIG. 31 to FIG. 35.

FIG. 31 is a flowchart illustrating a method of transmitting a sounding reference signal (SRS) associated with PUSCH in accordance with at least one embodiment.

Such as shown in FIG. 24, in an SRS transmission method described in FIG. 31, an SRS may be transmitted in association with an uplink reference signal. Accordingly, the flowchart shown in FIG. 31 may include a transmission procedure transmitting an uplink reference signal and a physical uplink channel associated with the uplink reference signal as shown in FIG. 23.

Referring to FIG. 31, at step S3110 in an SRS transmission method according to at least one embodiment, user equipment 120 may receive UE-specific configuration information indicating an uplink reference signal identity from one transmission/reception point (e.g., eNB 110) [of] among a plurality of different transmission/reception points. Herein, the uplink reference signal identity may be an independent [of] identify distinguished from a physical cell identity of the one transmission/reception point (e.g., eNB 110) and be associated with PUSCH. At step S3120, user equipment 120 may generate at least a portion of an SRS, using the uplink reference signal identity. At step S3130, user equipment 120 may transmit a reference signal associated with the PUSCH, to a transmission/reception point (e.g., RRH 112) indicated by the uplink reference signal identity. At step S3140, user equipment 120 may transmit the PUSCH to the transmission/reception point (e.g., RRH 112) indicated by the uplink reference signal identity. At step S3150, user equipment 120 may transmit the generated SRS to the transmission/reception point (e.g., RRH 112) indicated by the uplink reference signal identity.

In FIG. 31, steps S3130 and S3140 may be simultaneously performed. The SRS and the PUSCH may be transmitted together in one subframe. Alternatively, the SRS, the PUSCH, and PUCCH may be simultaneously transmitted in one subframe.

According to *the fourth embodiment* (Embodiment 4), a reception point of PUSCH may be determined as a transmission/reception point different from a serving transmission/reception to which user equipment belongs. That is, a PUSCH transmission to the different transmission/reception points may performed by defining a UE-specific PUSCH sequence and a UE-specific reference signal sequence associated with the PUSCH when PUSCH sequence and a reference signal sequence associated with the PUSCH sequence are generated. In this case, a periodic SRS or an aperiodic SRS may be defined according to a sequence configuration used for the PUSCH and a reference signal associated with the PUSCH. Accordingly, the PUSCH and an SRS may be transmitted to the same target transmission/reception point through an uplink.

In this case, receiving subjects of PUSCH may be the same as receiving subjects of periodic and/or aperiodic SRSs. In the case that receiving subjects of the PUSCH and PUCCH are the same, embodiments of an SRS transmission described with reference to FIG. 25 and FIG. 26 among descriptions of [Embodiment 1] *the first embodiment* (Embodiment 1) may be applied to *the fourth embodiment* (Embodiment 4).

FIG. 32 to FIG. 35 illustrate a variety of embodiments transmitting an SRS associated with PUSCH, according to SRS transmission methods shown in FIG. 25, FIG. 26, and FIG. 31.

FIG. 32 illustrates transmitting an SRS in association with PUSCH, in a CoMP environment in which transmission/reception points use different cell identities (e.g., cell ID #1 and cell ID #2).

FIG. 33 illustrates transmitting an SRS in association with PUSCH, in a CoMP environment in which transmission/reception points use the same cell identity (e.g., cell ID #0).

Referring to FIG. 32 and FIG. 33, PDCCH and PDSCH may be received from a serving transmission/reception point (e.g., eNB 110) to which user equipment 120 belongs. PUCCH corresponding to one of the uplink channels may be transmitted to the serving transmission/reception point (e.g., eNB 110) to which user equipment 120 belongs. Herein, the PUCCH may transmit ACK/NACK corresponding to a response to a downlink transmission, channel state information, and so forth. PUSCH and an SRS may be transmitted to a transmission/reception point (e.g., RRH 112) different from the serving transmission/reception point (e.g., eNB 110) to which user equipment 120 belongs.

FIG. 34 illustrates transmitting an aperiodic SRS in association with PUSCH, in a CoMP environment in which transmission/reception points use different cell identities (e.g., cell ID #1 and cell ID #2).

FIG. 35 illustrates transmitting an aperiodic SRS in association with PUSCH, in a CoMP environment in which transmission/reception points use the same cell identity (e.g., cell ID #0).

Referring to FIG. 34 and FIG. 35, PDCCH and PDSCH may be received from a serving transmission/reception point (e.g., eNB 110) to which user equipment 120 belongs. PUCCH and a periodic SRS may be transmitted to the serving transmission/reception point (e.g., eNB 110) to which user equipment 120 belongs. Herein, the PUCCH corresponding to one of uplink channels may transmit ACK/NACK corresponding to a response to a downlink transmission, channel state information, and so forth. PUSCH and an aperiodic SRS may be transmitted to a transmission/reception point (e.g., RRH 112) different from the serving transmission/reception point (e.g., eNB 110) to which user equipment 120 belongs.

According to *the fourth embodiment* (Embodiment 4) described with reference to FIG. 31 to FIG. 35, in the case that a reference signal identity associated with PUSCH is  $n_{ID}^{RS'}$ , an SRS identity may be identically defined as  $n_{ID}^{RS'}$ . Accordingly, when generating an SRS,  $n_{ID}^{RS'}$  may be used in place of a serving cell ID  $n_{ID}^{cell}$ . That is, in Formula 1 to Formula 6 used in an SRS sequence generation procedure, an SRS may be generated using the reference signal identity  $n_{ID}^{RS'}$  associated with the PUSCH. The generated SRS may be transmitted to a transmission/reception point (e.g., RRH 112) indicated by the used reference signal identity  $n_{ID}^{RS'}$ . In addition,  $n_{ID}^{RS'}$  may not necessarily indicate a transmission/reception point (e.g., RRH 112) different from a serving transmission/reception point, and may indicate the serving transmission/reception point (e.g., eNB 110).

Furthermore, in FIG. 31, an SRS may be at least one of a periodic SRS and an aperiodic SRS. Accordingly, only the aperiodic SRS may be transmitted in association with PUSCH, as described with reference to FIG. 34 and FIG. 35.

Receiving subjects may be different according to whether an SRS to be transmitted is a periodic SRS or an aperiodic SRS. For example, the periodic SRS may be transmitted to a serving transmission/reception point serving user equipment 120. The aperiodic SRS may be defined according to a sequence configuration used for PUSCH. Accordingly, the PUSCH and the aperiodic SRS may be transmitted to the same target transmission/reception point through an uplink.

In other words, an aperiodic SRS may be generated using the reference signal identity  $n_{ID}^{RS'}$  associated with PUSCH, in Formula 1 to Formula 6. The generated aperiodic SRS may be transmitted to a transmission/reception point (e.g., RRH 112) indicated by the reference signal identity  $n_{ID}^{RS'}$  associated with the PUSCH. Meanwhile, a periodic SRS may be generated using a cell ID ( $N_{ID}^{cell}$ ) of a serving transmission/reception point (e.g., eNB 110) in Formula 1 to Formula 6. The periodic SRS may be transmitted to the serving transmission/reception point.

Alternatively, although not shown in figures, an aperiodic SRS may be transmitted to a serving transmission/reception point serving user equipment 120. A periodic SRS may be defined according to a sequence configuration used for PUSCH. Accordingly, the PUSCH and the periodic SRS may be transmitted to the same target transmission/reception point through an uplink.

In an SRS transmission method according to *the fourth embodiment* (Embodiment 4), an SRS transmission associated with PUSCH may allow for estimation of an uplink channel state of a transmission/reception point different from a serving transmission/reception point. Accordingly, overcoming a shortage of uplink coverage may be possible.

Further, a TDD system may independently measure a downlink channel quality of a serving transmission/reception point and a downlink channel quality of a different transmission/reception point (i.e., a transmission/reception point different from the serving transmission/reception point). Herein, the TDD system may use an uplink channel quality measurement and a channel reciprocity for the serving transmission/reception point and the different transmission/reception point. Furthermore, the SRS transmission method may make it possible to recognize a location or a geometry of user equipment, using an SRS. Accordingly, in the case that user equipment is located on edge of a cell or at the center of the cell, it may be possible to improve data throughput for a downlink by using a UE-specific downlink transmission method.

In at least one embodiment, only an aperiodic SRS may be transmitted in association with PUSCH. In such embodiment, an aperiodic SRS transmission triggered by a base station may allow for estimation of a channel state of uplink associated with a transmission/reception points other than a serving transmission/reception point. Accordingly, overcoming a shortage of uplink coverage may be possible.

FIG. 36 illustrates user equipment in accordance with at least one embodiment.

Referring to FIG. 36, user equipment 3600 may include [receiving unit] receiver 3610, [control unit] controller 3620, and [transmitting unit] transmitter 3630 in accordance with [at least] one embodiment. [Receiving unit] Receiver 3610 may receive UE-specific configuration information indicating an SRS identity from one transmission/reception point of a plurality of different transmission/reception points. Herein, the SRS identity may be [independently] *an independent identify* distinguished from an uplink reference signal identity for a physical uplink channel. [Control unit] Controller 3620 may generate an SRS using the uplink reference signal identity. [Transmitting] Transmitter unit 3630 may transmit the generated SRS to a transmission/reception point indicated by the SRS identity.

As shown in FIG. 36, user equipment 3600 in accordance with at least one embodiment may transmit an SRS independently from the physical uplink channel according to an SRS transmission method described in FIG. 4.

FIG. 37 illustrates user equipment in accordance with [other embodiments of the present invention] *another embodiment*.

Referring to FIG. 37, user equipment 3700 may include [receiving unit] receiver 3710[,] and transmitter 3715 in accordance with another embodiment. Transmitter 3715 may further include uplink channel transmission unit 3720, SRS generating unit 3730, and transmitting unit 3740 in accordance with [at least one] another embodiment. [Receiving unit] Receiver 3710 may receive UE-specific configuration information indicating an uplink reference signal identity from one transmission/reception point of a plurality of different transmission/reception points. Herein, the uplink reference signal identity is an independent [of] identify distinguished from a physical cell identity of the one transmission/reception point and is associated with an uplink channel. Uplink channel transmission unit 3720 may transmit an uplink channel to a transmission/reception point indicated by the uplink reference signal identity, using the uplink reference signal identity. SRS generating unit 3730 may generate an SRS using a physical cell identity of the one transmission/reception point. SRS transmitting unit 3740 may transmit the generated SRS to the one transmission/reception point.

Herein, uplink channel transmission unit 3720 and transmitting unit 3740 may be implemented with the same hardware resource or different hardware resources.

Referring to FIG. 37, user equipment in accordance with at least one embodiment may transmit an SRS separately or independently from a physical uplink channel, to a serving transmission/reception point, according to an SRS transmission method described in FIG. 11.

FIG. 38 illustrates a base station (BS) in accordance with at least one embodiment.

Referring to FIG. 38, a base station (BS) 3800 may control unit 3810, transmitting unit 3820, and receiving unit 3830 in accordance with at least one embodiment.

Control unit 3810 may control operations of base station 3800, according to a CoMP operation and an uplink reference signal transmission required for performing operations described in the present [invention] disclosure.

Transmitting unit 3820 and receiving unit 3830 may transmit or receive signals, messages, and/or data required for performing operations described in the present [invention] disclosure, in connection with user equipment.

Although contents of technical standards referred to in the above-described embodiments is omitted for brief descriptions of the specification, the related contents of the technical standards may constitute a portion of the present specification. Accordingly, adding a portion of the standards-related content in the specification and/or the claims will be construed as being included in the scope of the present [invention] disclosure.

More specifically, the attached documents below may constitute a portion of the present specification as a portion of published documents. Accordingly, adding a portion of standards-related contents and/or standard documents in the description and/or the claims will be construed as being included in the scope of the present [invention] disclosure.

As described above, since the technical idea of the present invention is described by exemplary embodiments, various forms of substitutions, modifications and alterations may be made by those skilled in the art from the above description without departing from essential features of the present [invention] disclosure. Therefore, the embodiments disclosed in the present invention are intended to illustrate the technical idea of the present invention, and the scope of the

present invention is not limited by the embodiment. The scope of the present [invention] disclosure shall be construed on the basis of the accompanying claims in such a manner that all of the technical ideas included within the scope equivalent to the claims belong to the present [invention] disclosure.

What is claimed is:

1. A method of transmitting an uplink sounding reference signal (SRS) in user equipment (UE) in a coordinated multi-point transmission/reception system (CoMP system), the method comprising:

receiving, by the user equipment, UE-specific configuration information including an uplink reference signal identity associated with an uplink channel, from a first transmission/reception point of a plurality of different transmission/reception points, wherein the uplink reference signal identity is independent of a physical cell identity of the first transmission/reception point and indicates a second transmission/reception point as a reception entity of the uplink channel; and

performing, by the user equipment, an independent transmission of the uplink channel and an SRS to different transmission/reception points, using the uplink reference signal identity or the physical cell identity according to a type of an uplink transmission,

wherein when the type of the uplink transmission is an uplink channel transmission,

the performing includes:

obtaining the uplink reference signal identity from the received UE-specific configuration information;

determining the second transmission/reception point indicated by the uplink reference signal identity, as an uplink channel reception entity, wherein the second transmission/reception point is different from the first transmission/reception point; and

transmitting, by the user equipment, the uplink channel to the determined second transmission/reception point, using the uplink reference signal identity;

wherein when the type of the uplink transmission is an SRS transmission,

the performing includes:

generating, by the user equipment, an SRS independent of the uplink channel, using the physical cell identity of the first transmission/reception point;

determining the first transmission/reception point which has transmitted the UE-specific configuration information to the user equipment, as an SRS reception entity; and

transmitting, by the user equipment, the generated SRS to the determined first transmission/reception point;

wherein:

the SRS includes [at least one of] a periodic SRS and an aperiodic SRS,

the generating an SRS includes generating both the periodic SRS and the aperiodic SRS using the physical cell identity of the first transmission/reception point, and

the transmitting the generated SRS includes transmitting one of the periodic SRS and the aperiodic SRS to the first transmission/reception point indicated by the physical cell identity;

wherein the uplink channel is at least one of a physical uplink shared channel and a physical uplink control channel; and

wherein the receiving UE-specific configuration information includes receiving, from the first transmission/reception point, the UE-specific configuration information including the uplink reference signal identity,

41

either through a UE-specific parameter, or dynamically through at least one of a physical downlink control channel (PDCCH) and an enhanced physical downlink control channel (EPDCCH).

**[2.** The method of claim 1, wherein:

the generating an SRS includes generating one of the periodic SRS and the aperiodic SRS using the physical cell identity of the first transmission/reception point, and the other SRS using the uplink reference signal identity; and

the transmitting the generated SRS includes transmitting one of the periodic SRS and the aperiodic SRS to the first transmission/reception point, and the other SRS to the second transmission/reception point indicated by the uplink reference signal identity.]

**[3.** User equipment in a coordinated multi-point transmission/reception system (CoMP system), the user equipment comprising:

a receiver configured to receive UE-specific configuration information including an uplink reference signal identity associated with an uplink channel, from a first transmission/reception point of a plurality of different transmission/reception points, wherein the uplink reference signal identity is independent of a physical cell identity of the first transmission/reception point and indicates a second transmission/reception point as a reception entity of the uplink channel; and

a transmitter configured to perform an independent transmission of the uplink channel and a sounding reference signal (SRS) to different transmission/reception points, using the uplink reference signal identity or the physical cell identity according to whether a type of an uplink transmission is an uplink channel transmission or an SRS transmission,

wherein the transmitter includes:

an uplink channel transmission unit configured to obtain the uplink reference signal identity from the received UE-specific configuration information; to determine the second transmission/reception point indicated by the uplink reference signal identity, as an uplink channel reception entity; and to transmit the uplink channel to the determined second transmission/reception point, using the uplink reference signal identity, wherein the second transmission/reception point is different from the first transmission/reception point;

an SRS generating unit configured to generate an SRS being independent of the uplink channel, using the physical cell identity of the first transmission/reception point; and

an SRS transmitting unit configured to determine the first transmission/reception point which has transmitted the UE-specific configuration information to the user equipment, as an SRS reception entity, and to transmit the generated SRS to the determined first transmission/reception point;

wherein:

the SRS includes at least one of a periodic SRS and an aperiodic SRS,

the SRS generating unit is configured to generate both the periodic SRS and the aperiodic SRS using the physical cell identity of the first transmission/reception point, and

the SRS transmitting unit is configured to transmit one of the periodic SRS and the aperiodic SRS to the first transmission/reception point indicated by the physical cell identity;

42

wherein the uplink channel is at least one of a physical uplink shared channel and a physical uplink control channel; and

wherein the receiver is configured to receive, from the first transmission/reception point, the UE-specific configuration information including the uplink reference signal identity, either through a UE-specific parameter, or dynamically through at least one of a physical downlink control channel (PDCCH) and an enhanced physical downlink control channel (EPDCCH).]

**[4.** The user equipment of claim 3, wherein:

the SRS generating unit is configured to generate one of the periodic SRS and the aperiodic SRS using the physical cell identity of the first transmission/reception point, and to generate the other SRS using the uplink reference signal identity; and

the SRS transmitting unit is configured to transmit one of the periodic SRS and the aperiodic SRS to the first transmission/reception point, and to transmit the other SRS to the second transmission/reception point indicated by the uplink reference signal identity.]

**[5.** A method of transmitting an uplink sounding reference signal (SRS) in user equipment (UE) in a coordinated multi-point transmission/reception system (CoMP system), the method comprising:

receiving, by the user equipment, UE-specific configuration information including a sounding reference signal (SRS) identity from a first transmission/reception point of a plurality of different transmission/reception points, wherein the SRS identity is independently determined to be distinguished from an uplink reference signal identity for an uplink channel and indicates a second transmission/reception point as a reception entity of an SRS; and

performing, by the user equipment, an independent transmission of the uplink channel and the SRS to different transmission/reception points, using the uplink reference signal identity or the SRS identity according to a type of an uplink transmission,

wherein when the type of the uplink transmission is an SRS transmission,

the performing includes:

obtaining, by the user equipment, the SRS identity from the received UE-specific configuration information; generating, by the user equipment, an SRS using the SRS identity;

determining the second transmission/reception point UE-specifically indicated by the SRS identity, as an SRS reception entity, wherein the second transmission/reception point is different from the first transmission/reception point which has transmitted the UE-specific configuration information to the user equipment; and

transmitting, by the user equipment, the generated SRS to the determined second transmission/reception point;

wherein the SRS includes at least one of a periodic SRS and an aperiodic SRS;

wherein the generating an SRS includes generating both the periodic SRS and the aperiodic SRS using the SRS identity; and

wherein the receiving UE-specific configuration information includes receiving, from the first transmission/reception point, the UE-specific configuration information including the SRS identity, either through a UE-specific parameter, or dynamically through at least

43

one of a physical downlink control channel (PDCCH) and an enhanced physical downlink control channel (EPDCCH).]

[6. The method of claim 5, wherein: the UE-specific configuration information includes a same reference signal identity for the periodic SRS and the aperiodic SRS.]

[7. The method of claim 5, wherein: the UE-specific configuration information includes a different reference signal identity for each of the periodic SRS and the aperiodic SRS.]

[8. The method of claim 5, wherein: the generating an SRS includes generating one of the periodic SRS and the aperiodic SRS using the SRS identity, and the other SRS using a physical cell identity of the first transmission/reception point; and the transmitting the generated SRS includes transmitting one of the periodic SRS and the aperiodic SRS to the second transmission/reception point indicated by the SRS identity, and the other SRS to the first transmission/reception point.]

9. A method of transmitting an uplink sounding reference signal (SRS) in user equipment (UE) in a coordinated multi-point transmission/reception system (CoMP system) including a first transmission/reception point and a second transmission/reception point, the method comprising:

receiving, by the user equipment, UE-specific configuration information including an uplink reference signal identity which is an independent identity distinguished from a physical cell identity of the first transmission/reception point and indicates the second transmission/reception point as a reception entity of the uplink channel from the first transmission/reception point through either a UE-specific parameter or dynamically through at least one of a physical downlink control channel (PDCCH) and an enhanced physical downlink control channel (EPDCCH);

determining, by the user equipment, the second transmission/reception point indicated by the uplink reference signal identity included in the received UE-specific configuration information as an uplink channel reception entity, and transmitting the uplink channel to the determined second transmission/reception point, using the uplink reference signal identity; and

generating, by the user equipment, both a periodic SRS and an aperiodic SRS, using the physical cell identity of the first transmission/reception point, determining the first transmission/reception point as an SRS reception entity, and transmitting the generated periodic SRS and aperiodic SRS to the determined first transmission/reception point indicated by the physical cell identity through the uplink channels.

10. The method of claim 9, wherein the second transmission/reception point is different from the first transmission/reception point.

11. The method of the claim 9, wherein the uplink channel includes a PUCCH and a PUSCH.

12. User equipment in a coordinated multi-point transmission/reception system (CoMP system) including a first transmission/reception point and a second transmission/reception point, the user equipment comprising:

a receiver configured to receive UE-specific configuration information including an uplink reference signal identity which is an independent identify distinguished from of a physical cell identity of the first transmission/reception point and indicates the second transmission/reception point as a reception entity of the uplink

44

channel from the first transmission/reception point through either a UE-specific parameter or dynamically through at least one of a physical downlink control channel (PDCCH) and an enhanced physical downlink control channel (EPDCCH); and

a transmitter configured to determine the second transmission/reception point indicated by the uplink reference signal identity included in the received UE-specific configuration information as an uplink channel reception entity and transmit the uplink channel to the determined second transmission/reception point, using the uplink reference signal identity, and generate both a periodic SRS and an aperiodic SRS, using the physical cell identity of the first transmission/reception point, determine the first transmission/reception point as an SRS reception entity and transmit the generated periodic SRS and aperiodic SRS to the determined first transmission/reception point indicated by the physical cell identity through the uplink channel.

13. The user equipment of claim 12, wherein the second transmission/reception point is different from the first transmission/reception point.

14. The user equipment of claim 13, wherein the uplink channel includes a PUCCH and a PUSCH.

15. A method of transmitting an uplink sounding reference signal (SRS) in user equipment (UE) in a coordinated multi-point transmission/reception system (CoMP system), the method comprising:

receiving, by the user equipment, UE-specific configuration information including a sounding reference signal (SRS) identity from a first transmission/reception point among a plurality of different transmission/reception points, wherein the SRS identity is independently determined to be distinguished from an uplink reference signal identity for an uplink channel and indicates a second transmission/reception point as a reception entity of an SRS; and

performing, by the user equipment, an independent transmission of the uplink channel and the SRS to different transmission/reception points, using the uplink reference signal identity or the SRS identity according to a type of an uplink transmission,

wherein when the type of the uplink transmission is an SRS transmission, the performing includes:

generating, by the user equipment, an SRS using the SRS identity included in the received UE-specific configuration information;

determining the second transmission/reception point UE-specifically indicated by the SRS identity, as an SRS reception entity, wherein the second transmission/reception point is different from the first transmission/reception point which has transmitted the UE-specific configuration information to the user equipment; and

transmitting, by the user equipment, the generated SRS to the determined second transmission/reception point;

wherein the SRS includes a periodic SRS and an aperiodic SRS;

wherein the generating an SRS includes generating both the periodic SRS and the aperiodic SRS using the SRS identity; and

wherein the receiving UE-specific configuration information includes receiving, from the first transmission/reception point, the UE-specific configuration information including the SRS identity, either through a UE-specific parameter, or dynamically through at least

*one of a physical downlink control channel (PDCCH)  
and an enhanced physical downlink control channel  
(EPDCCH).*

*16. The method of claim 15, wherein:*

*the UE-specific configuration information includes the 5  
sounding reference signal identity which is the same for  
the periodic SRS and the aperiodic SRS.*

*17. The method of claim 15, wherein:*

*the UE-specific configuration information includes the  
sounding reference signal identity which is different for 10  
the periodic SRS and the aperiodic SRS.*

\* \* \* \* \*