



US00RE49288E

(19) **United States**
(12) **Reissued Patent**
Ramalho et al.

(10) **Patent Number: US RE49,288 E**
(45) **Date of Reissued Patent: Nov. 8, 2022**

(54) **ENDPOINT PROXIMITY PAIRING USING ACOUSTIC SPREAD SPECTRUM TOKEN EXCHANGE AND RANGING INFORMATION**

5,331,602 A * 7/1994 McLaren G01S 5/0009
367/127

(Continued)

(71) Applicant: **Cisco Technology, Inc.**, San Jose, CA (US)

FOREIGN PATENT DOCUMENTS

(72) Inventors: **Michael A. Ramalho**, Lakewood Ranch, FL (US); **Mihailo Zilovic**, Lawrenceville, NJ (US)

CN 104753561 A 7/2015

(73) Assignee: **CISCO TECHNOLOGY, INC.**, San Jose, CA (US)

OTHER PUBLICATIONS

(21) Appl. No.: **17/104,845**

(22) Filed: **Nov. 25, 2020**

T. Yoshioka, et al., "Making Machines Understand Us in Reverberant Rooms", [Robustness against reverberation for automatic speech recognition], Fundamental Technologies in Modern Speech Recognition, IEEE Signal Processing Magazine, Nov. 2012, 13 pages.

(Continued)

Related U.S. Patent Documents

Reissue of:

(64) Patent No.: **10,141,973**
Issued: **Nov. 27, 2018**
Appl. No.: **15/631,679**
Filed: **Jun. 23, 2017**

Primary Examiner — Colin M Larose

(74) *Attorney, Agent, or Firm* — Edell, Shapiro & Finnan, LLC

(51) **Int. Cl.**
H04B 1/709 (2011.01)
H04R 1/34 (2006.01)
(Continued)

(57) **ABSTRACT**

A first endpoint generates an acoustic spread spectrum signal including a pilot sequence and a data sequence representing a token synchronized to the pilot sequence, transmits the acoustic spread spectrum signal, and records a transmit time at which the acoustic spread spectrum signal is transmitted. A receive time at which a second endpoint received the acoustic spread spectrum signal transmitted by the first endpoint is received from the second endpoint along with an indication of a second token as recovered from the received acoustic spread spectrum signal by the second endpoint. A separation distance between the first endpoint and the second endpoint is computed based on a time difference between the transmit time and the receive time. The first endpoint is paired with the second endpoint when the token matches the second token and the computed distance is less than a threshold distance.

(52) **U.S. Cl.**
CPC **H04B 1/709** (2013.01); **H04B 1/707** (2013.01); **H04H 20/30** (2013.01); **H04J 13/107** (2013.01);
(Continued)

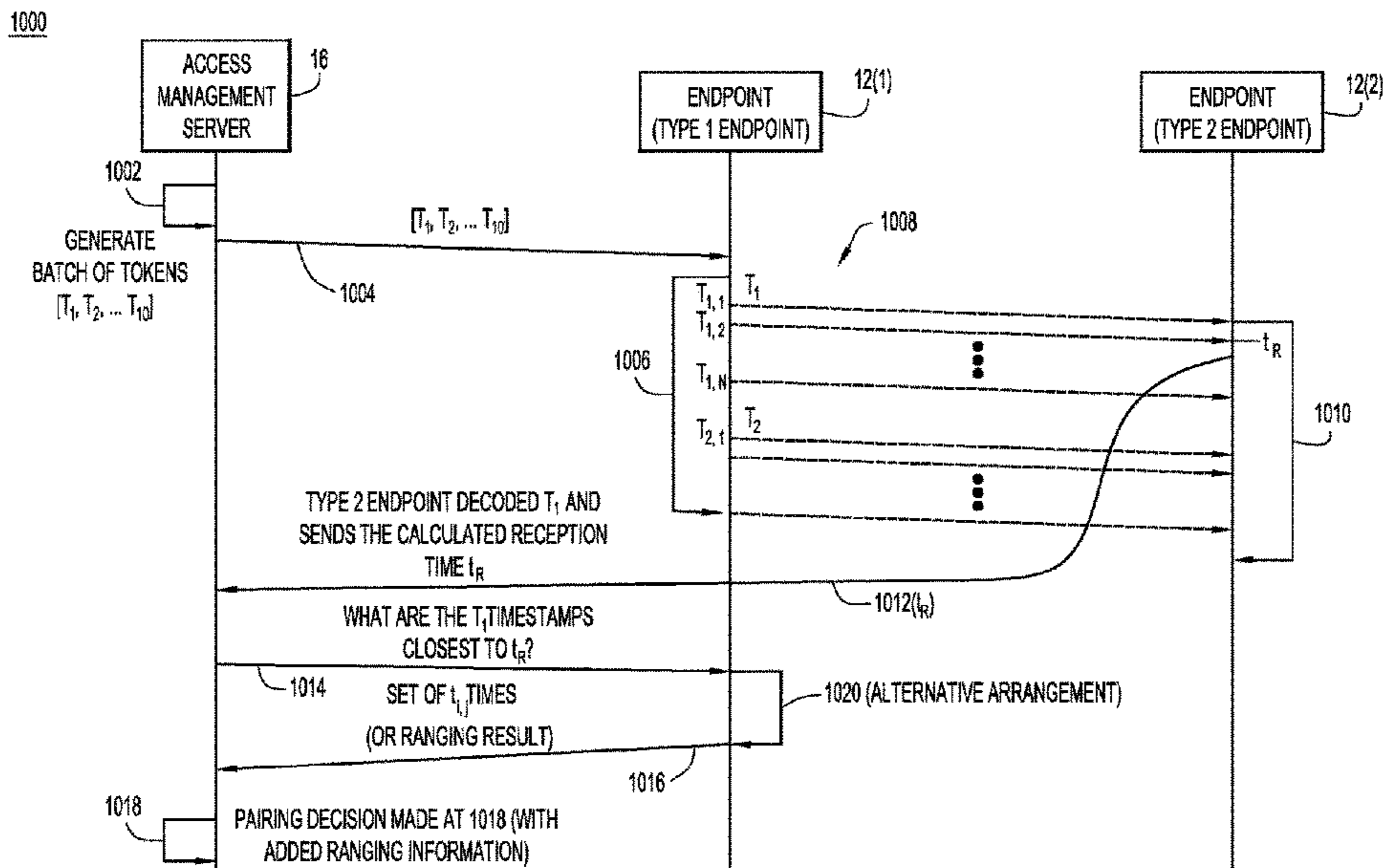
(58) **Field of Classification Search**
CPC H04B 1/709; H04B 1/707; H04H 20/30; H04J 13/107; H04N 21/42203;
(Continued)

(56) **References Cited**

U.S. PATENT DOCUMENTS

5,228,056 A * 7/1993 Schilling H04W 52/346
380/34

26 Claims, 17 Drawing Sheets



(51) **Int. Cl.**
H04N 21/422 (2011.01)
H04H 20/30 (2008.01)
H04B 1/707 (2011.01)
H04J 13/10 (2011.01)
H04R 3/00 (2006.01)
H04S 7/00 (2006.01)

(52) **U.S. Cl.**
 CPC *H04N 21/42203* (2013.01); *H04R 1/345*
 (2013.01); *H04R 3/00* (2013.01); *H04R*
2420/07 (2013.01); *H04S 7/305* (2013.01)

(58) **Field of Classification Search**
 CPC H04R 1/345; H04R 3/00; H04R 2420/07;
 H04S 7/305
 See application file for complete search history.

(56) **References Cited**
 U.S. PATENT DOCUMENTS

6,141,332 A *	10/2000	Lavean	H04J 13/0048 370/335	10,003,377 B1	6/2018	Ramalho et al.
6,141,337 A	10/2000	Uta et al.		10,084,833 B2 *	9/2018	McDonnell H04L 65/1069
7,729,204 B2	6/2010	Peng et al.		10,177,859 B2	1/2019	Barth et al.
7,852,318 B2	12/2010	Altman		10,277,332 B2	4/2019	Barth et al.
8,259,603 B2	9/2012	Kuroda et al.		10,473,751 B2	11/2019	Birkenes
8,787,942 B2 *	7/2014	Hannan	G01S 5/0036 370/328	10,491,311 B2	11/2019	Barth et al.
8,818,273 B2 *	8/2014	Jung	H04B 1/02 455/41.2	10,530,417 B2	1/2020	Ramalho et al.
9,130,914 B2 *	9/2015	Miura	H04L 63/0869	2003/0043775 A1	3/2003	Kikuchi
9,241,016 B2	1/2016	Barth et al.		2004/0071195 A1	4/2004	Huang et al.
9,246,956 B2 *	1/2016	Vadla Ravnas	G06Q 10/10	2006/0267841 A1 *	11/2006	Lee G01S 5/0081 342/463
9,319,096 B1	4/2016	Rifkin et al.		2010/0118989 A1	5/2010	Sayana et al.
9,319,633 B1	4/2016	Birkenes et al.		2010/0227549 A1 *	9/2010	Kozlay H04W 12/50 455/26.1
9,473,580 B2	10/2016	Barth et al.		2011/0179182 A1	7/2011	Vadla Ravnäs
9,591,148 B2	3/2017	Dimitroff et al.		2012/0328101 A1 *	12/2012	Lakshminarayanan H04L 63/0823 380/258
9,621,659 B1 *	4/2017	Ghazanfari	H04W 4/80	2013/0315079 A1 *	11/2013	Edge H04W 4/02 370/252
9,628,514 B2 *	4/2017	Kaufman	H04W 12/50	2013/0316727 A1 *	11/2013	Edge H04W 4/02 455/456.1
9,648,654 B2 *	5/2017	Kiernans	H04W 12/069	2014/0192622 A1	7/2014	Rowe et al.
9,775,184 B2 *	9/2017	Lee	H04W 8/005	2015/0139343 A1	5/2015	Chen et al.
9,801,222 B1 *	10/2017	Pezdirc	H04W 4/025	2015/0327001 A1	11/2015	Kirshenberg et al.
9,912,415 B2 *	3/2018	Tsfaty	G01S 5/18	2016/0178748 A1 *	6/2016	Shin G01S 15/42 367/99
9,973,928 B2 *	5/2018	Bengtsson	H04L 63/08	2016/0356876 A1	12/2016	Lazik et al.
				2016/0360341 A1 *	12/2016	Srivatsa H04W 76/14
				2018/0091565 A1 *	3/2018	Arsenault H04L 63/08
				2018/0098367 A1 *	4/2018	Pezdirc H04W 76/10
				2020/0059305 A1	2/2020	Barth et al.
				2020/0116820 A1	4/2020	Birkenes
				2020/0195297 A1	6/2020	Ramalho et al.

OTHER PUBLICATIONS

K.K. Wong, et al., "Spread Spectrum Techniques for Indoor Wireless IR Communications", *Optical Wireless Communications*, IEEE Wireless Communications, Apr. 2003, 11 pages.

H. Delic, et al., "The Prometheus Orthonormal Set for Wideband CDMA", IEEE MELECON 2004, May 12-15, 2004, Dubrovnik, Croatia, 4 pages.

* cited by examiner

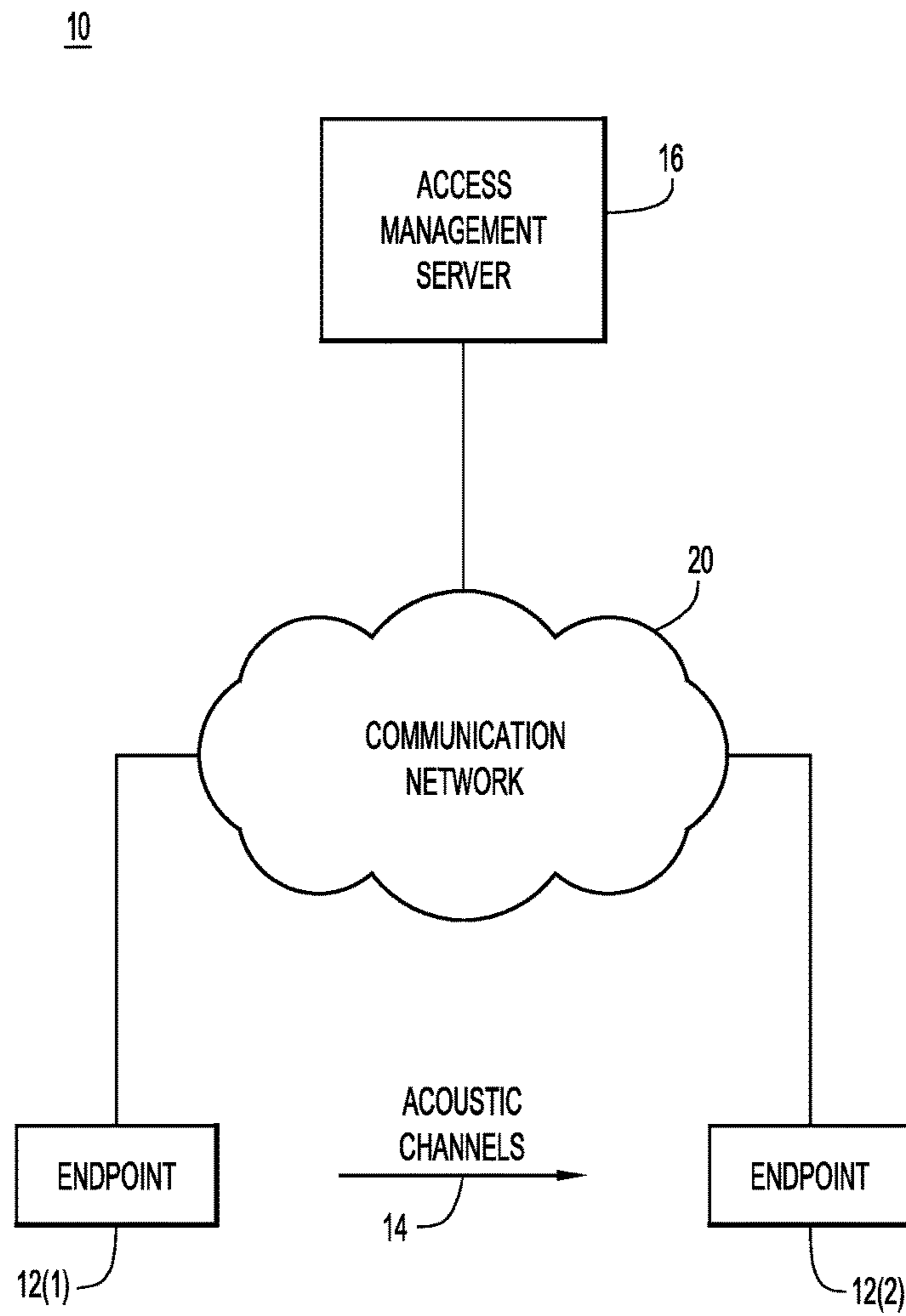


FIG.1A

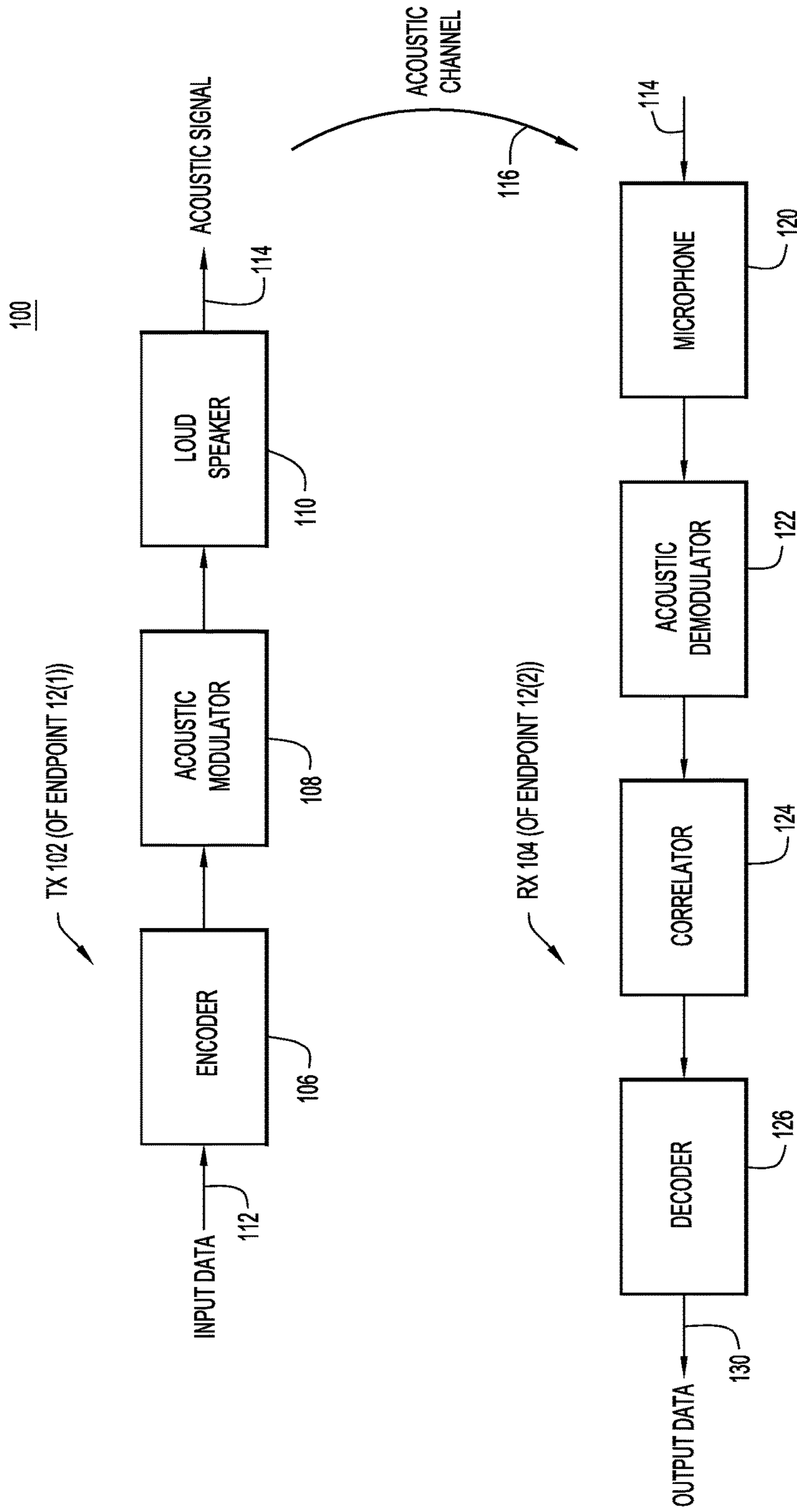


FIG.1B

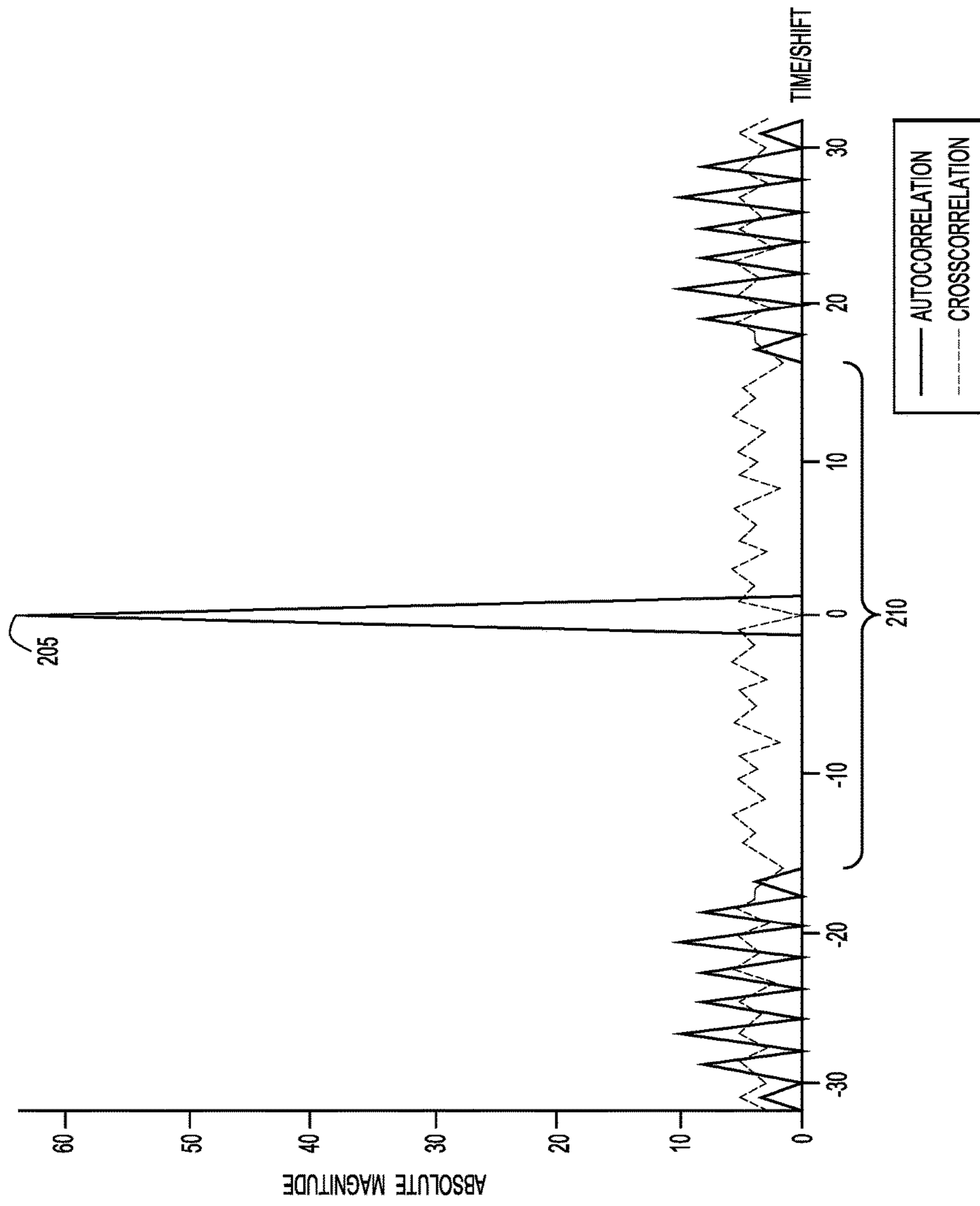


FIG.2

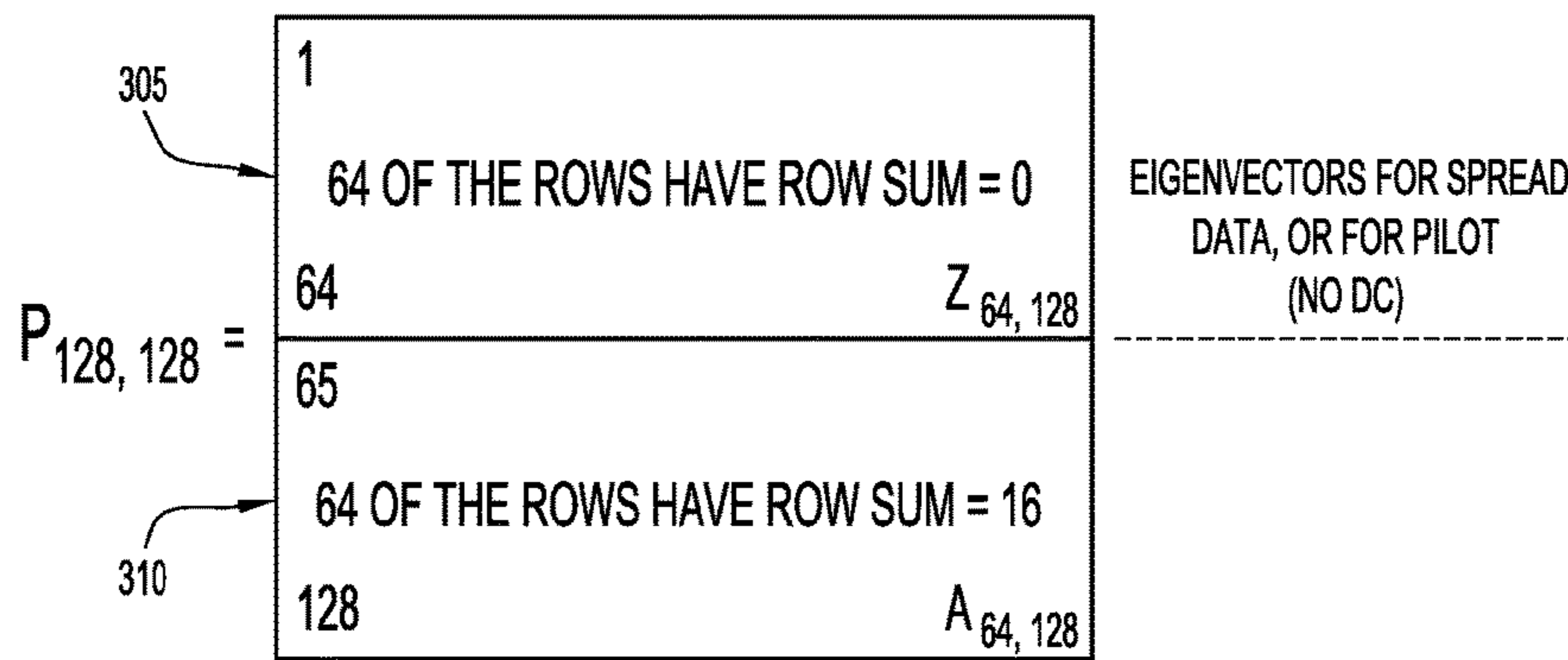


FIG.3

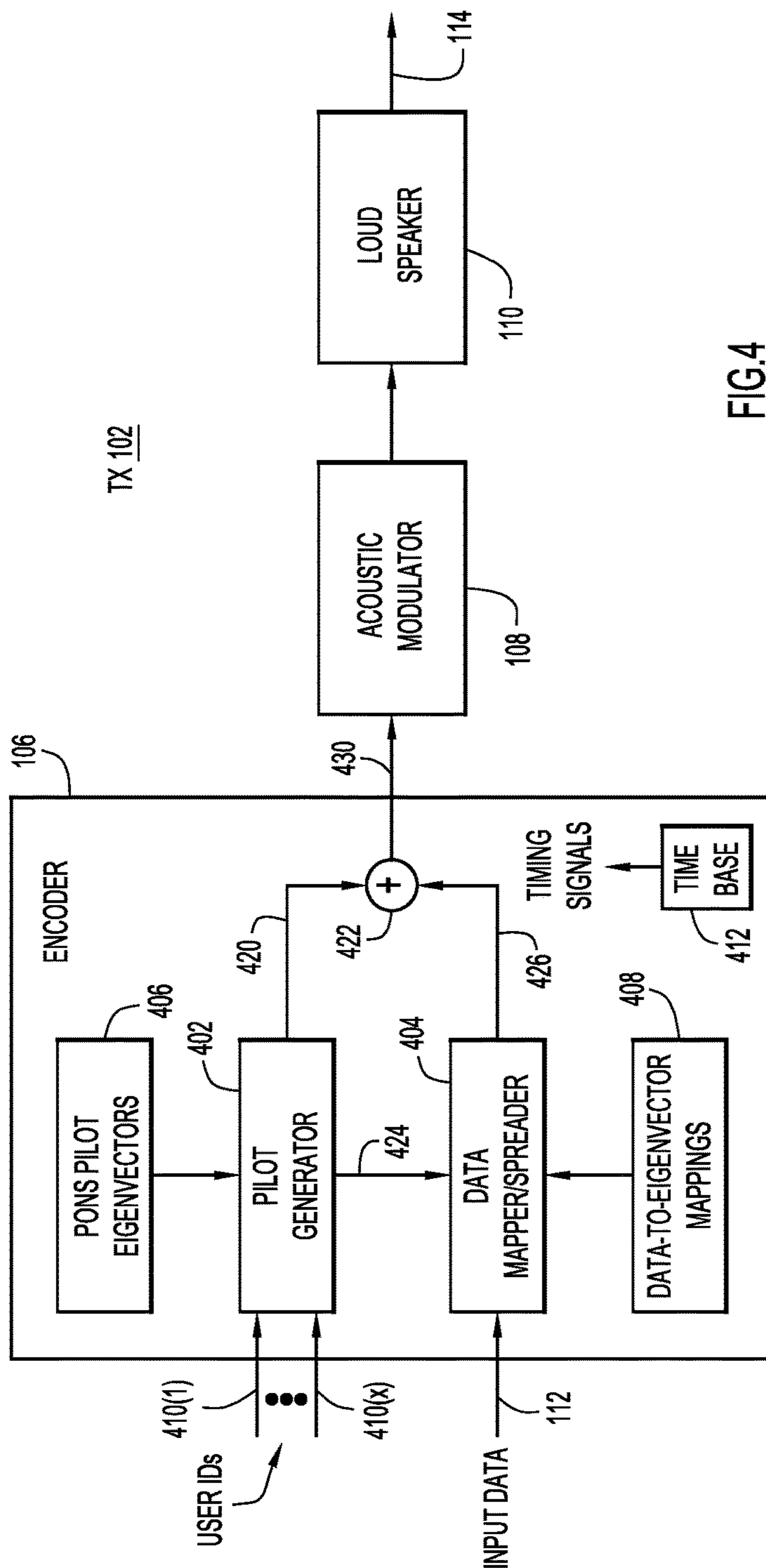


FIG.4

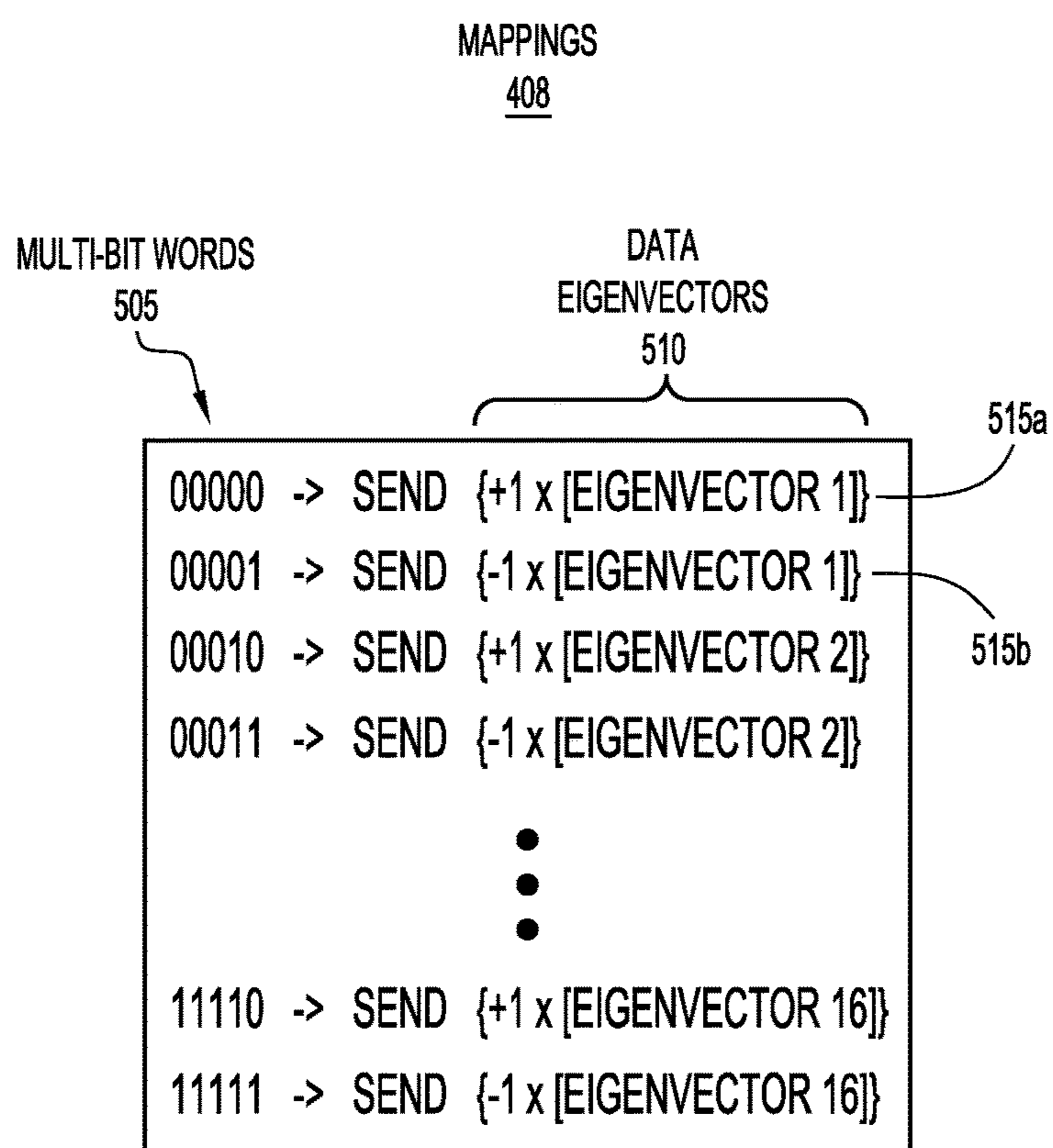


FIG.5

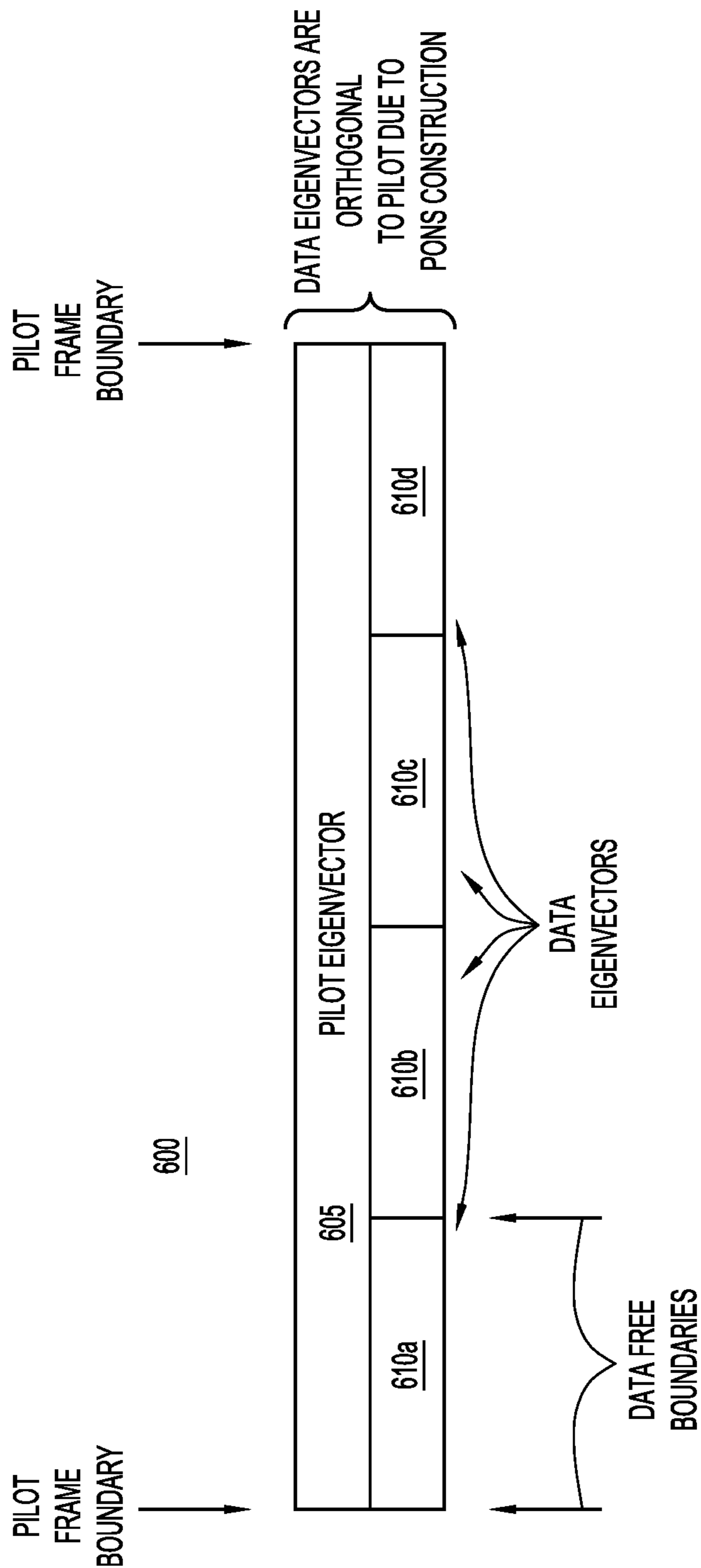


FIG.6

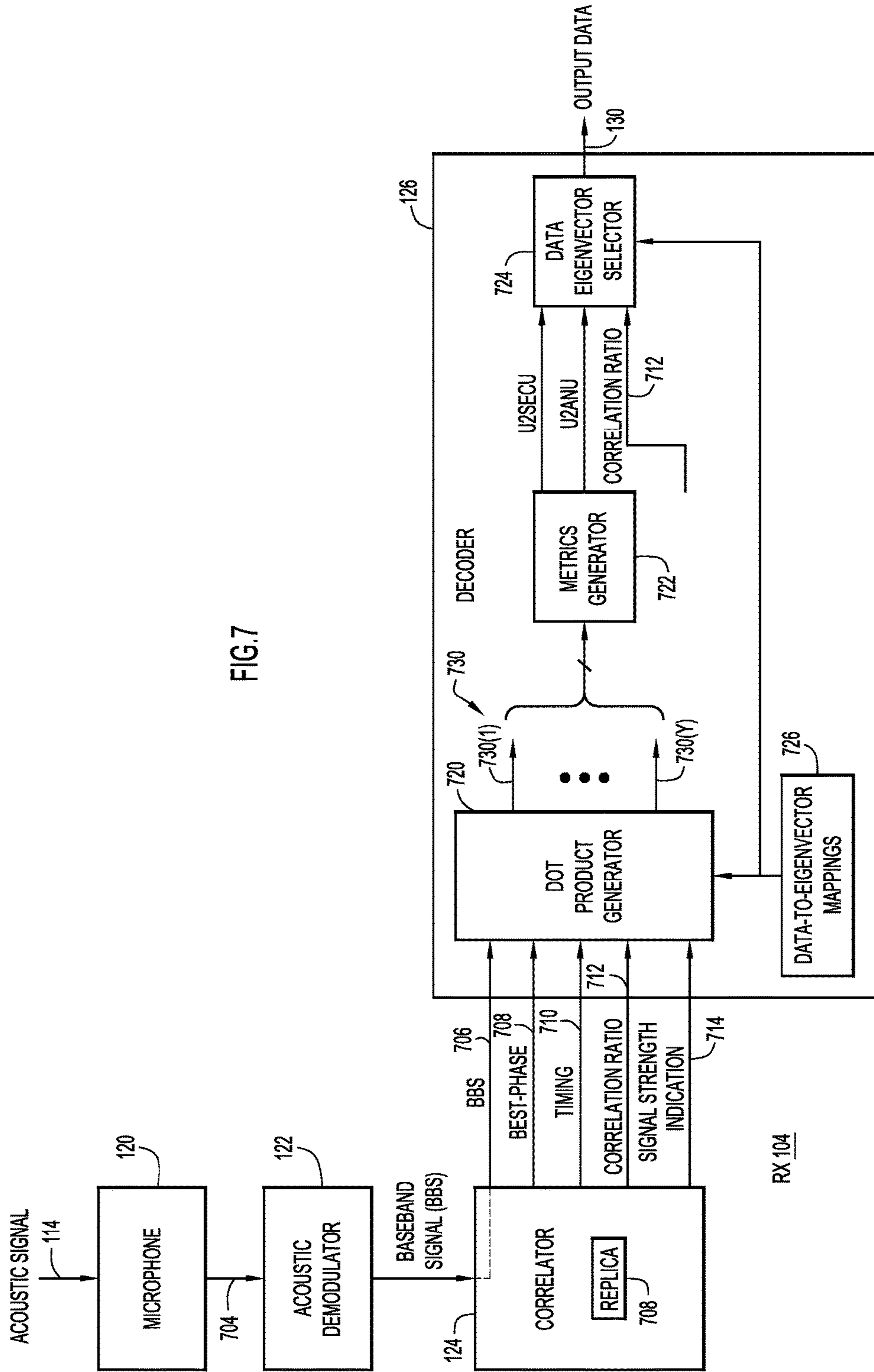


FIG. 7

RX 104

800

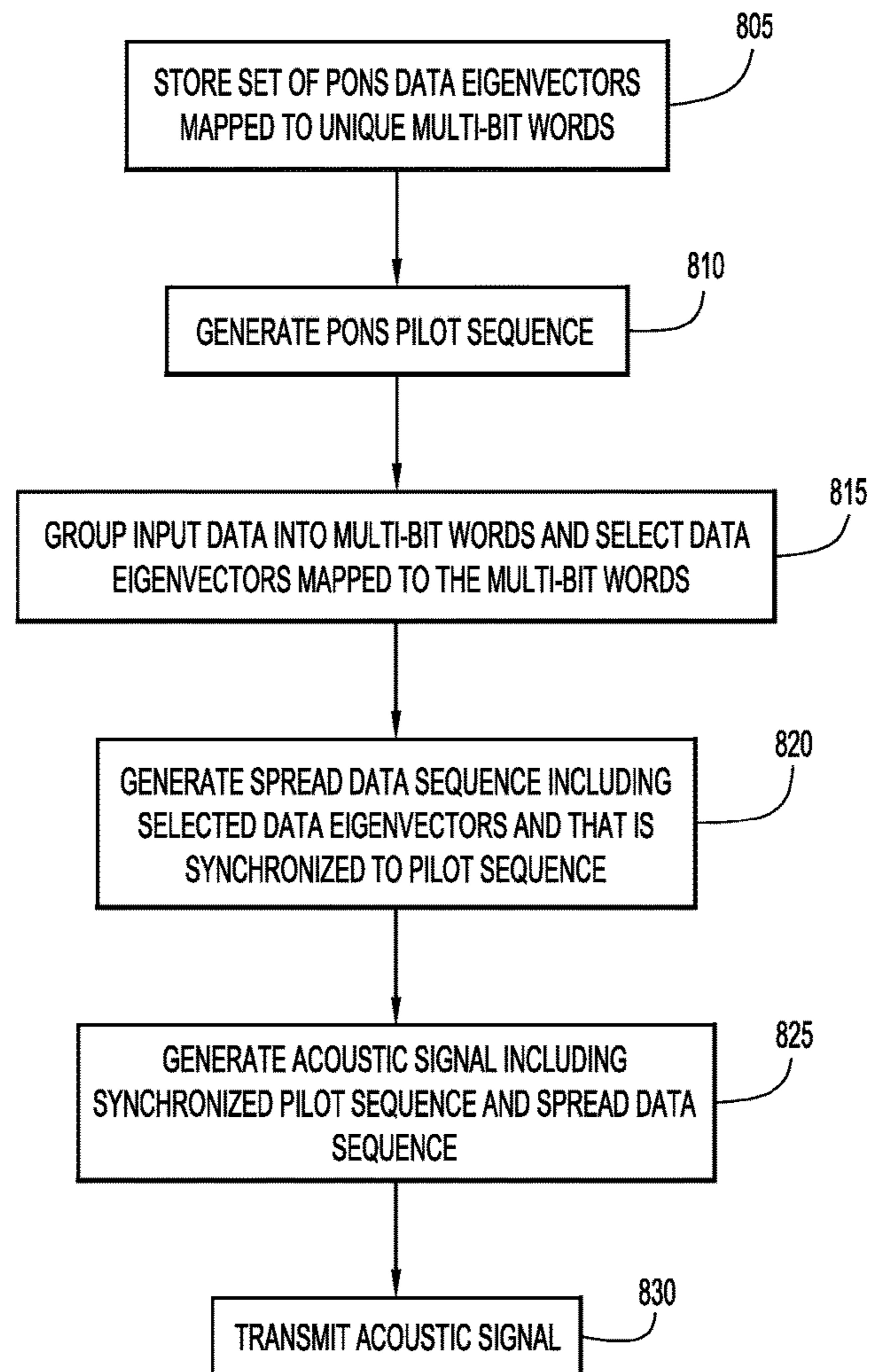


FIG.8

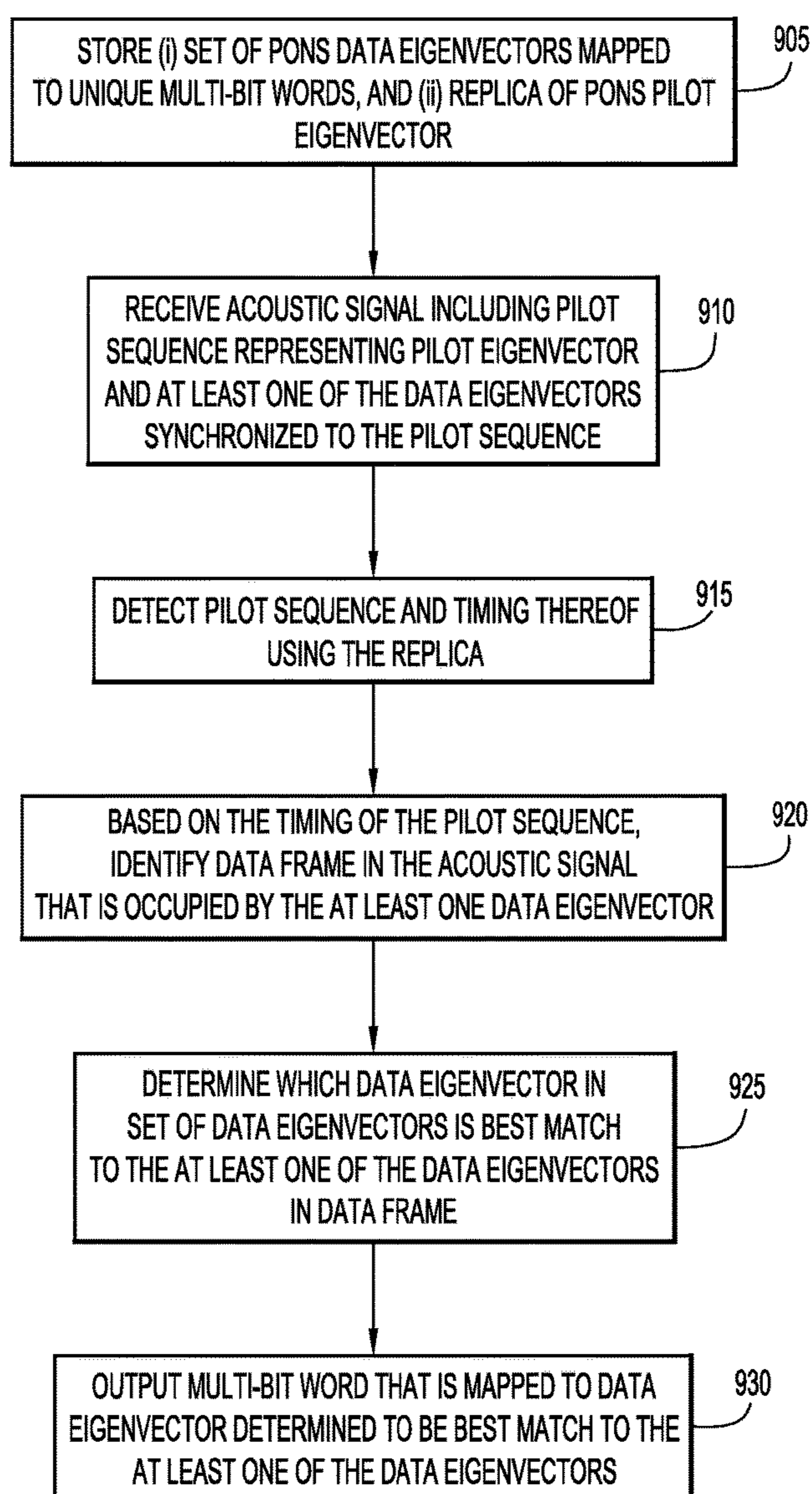
900

FIG.9

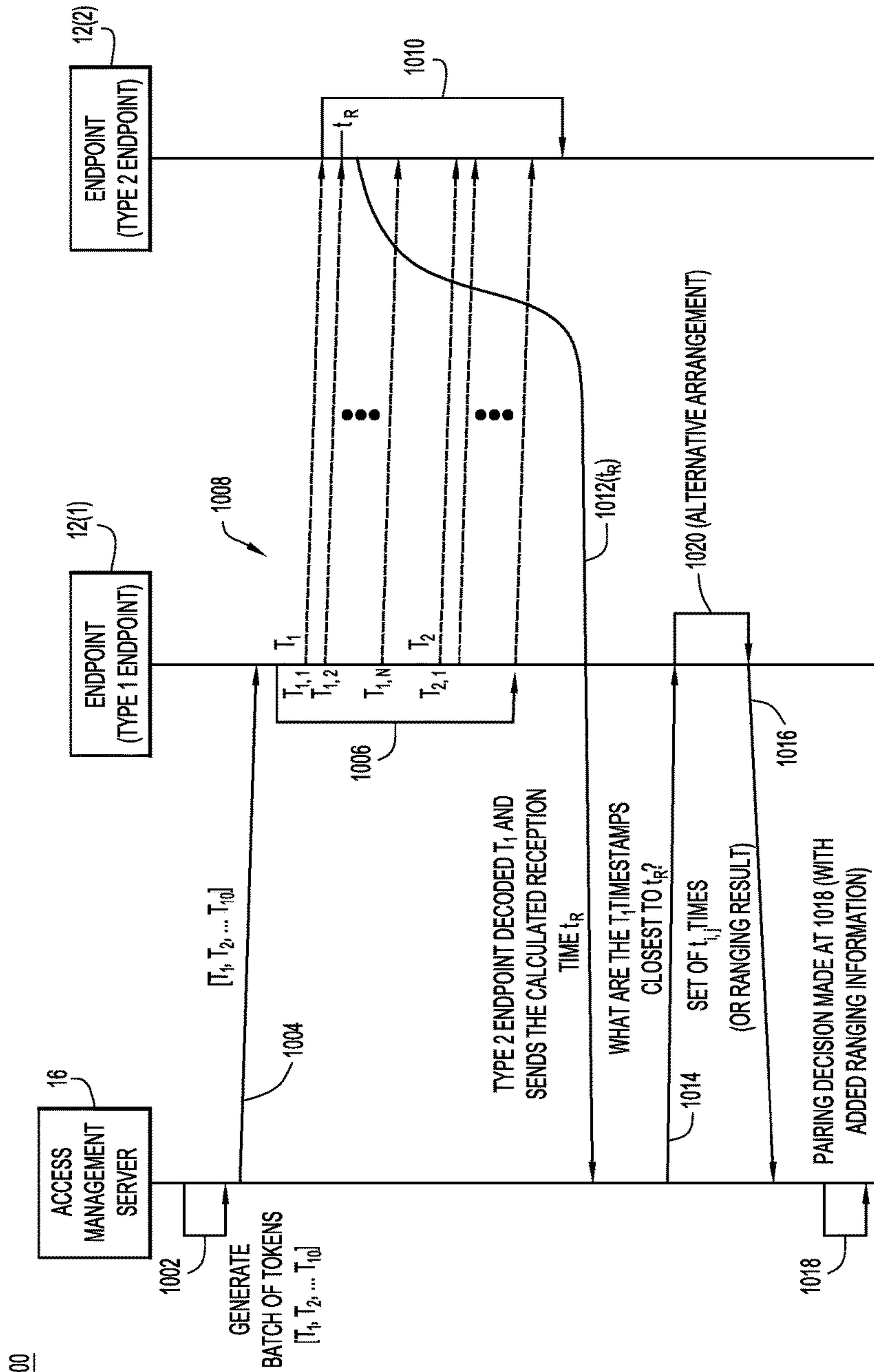


FIG.10

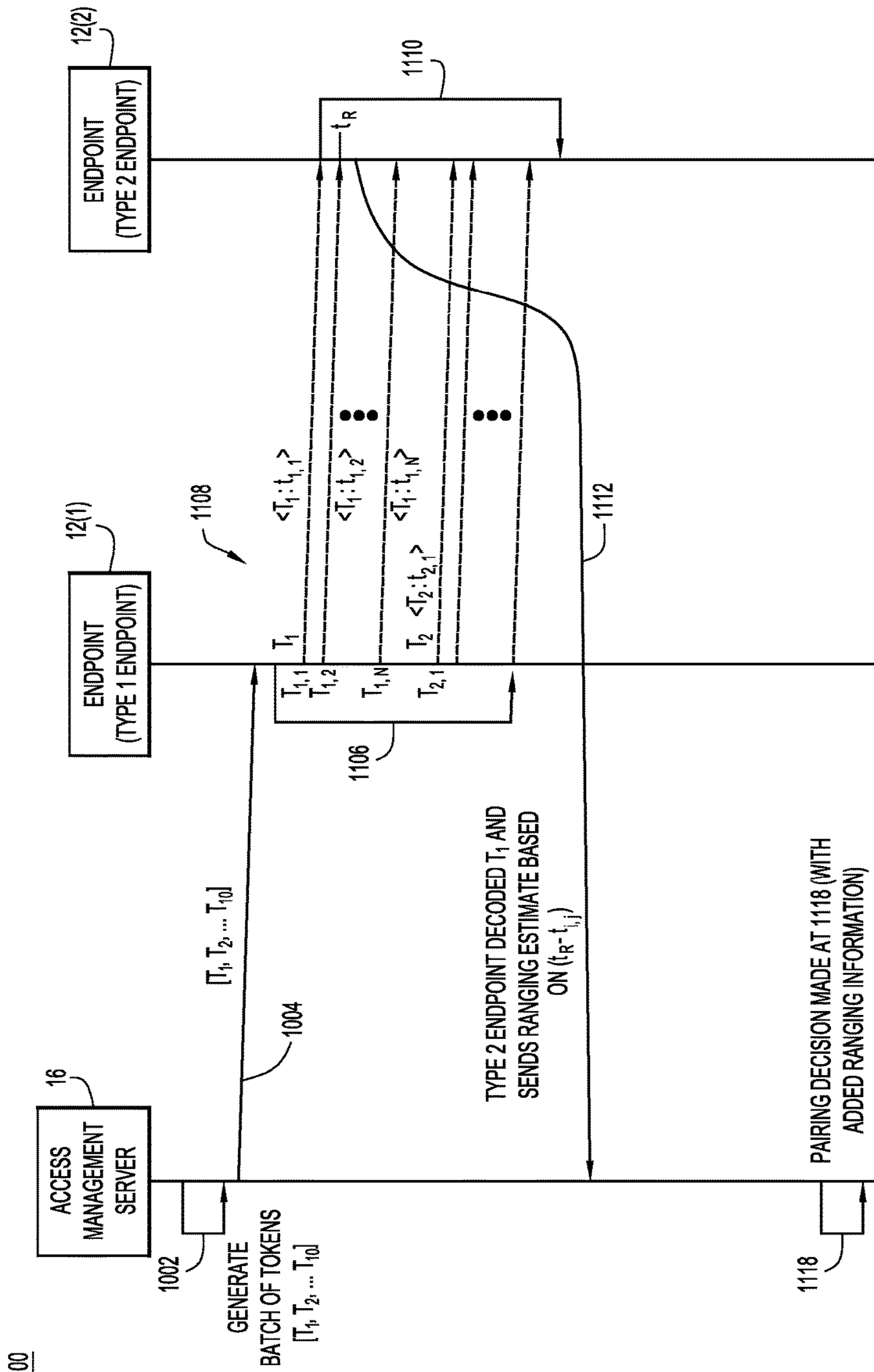


FIG.11

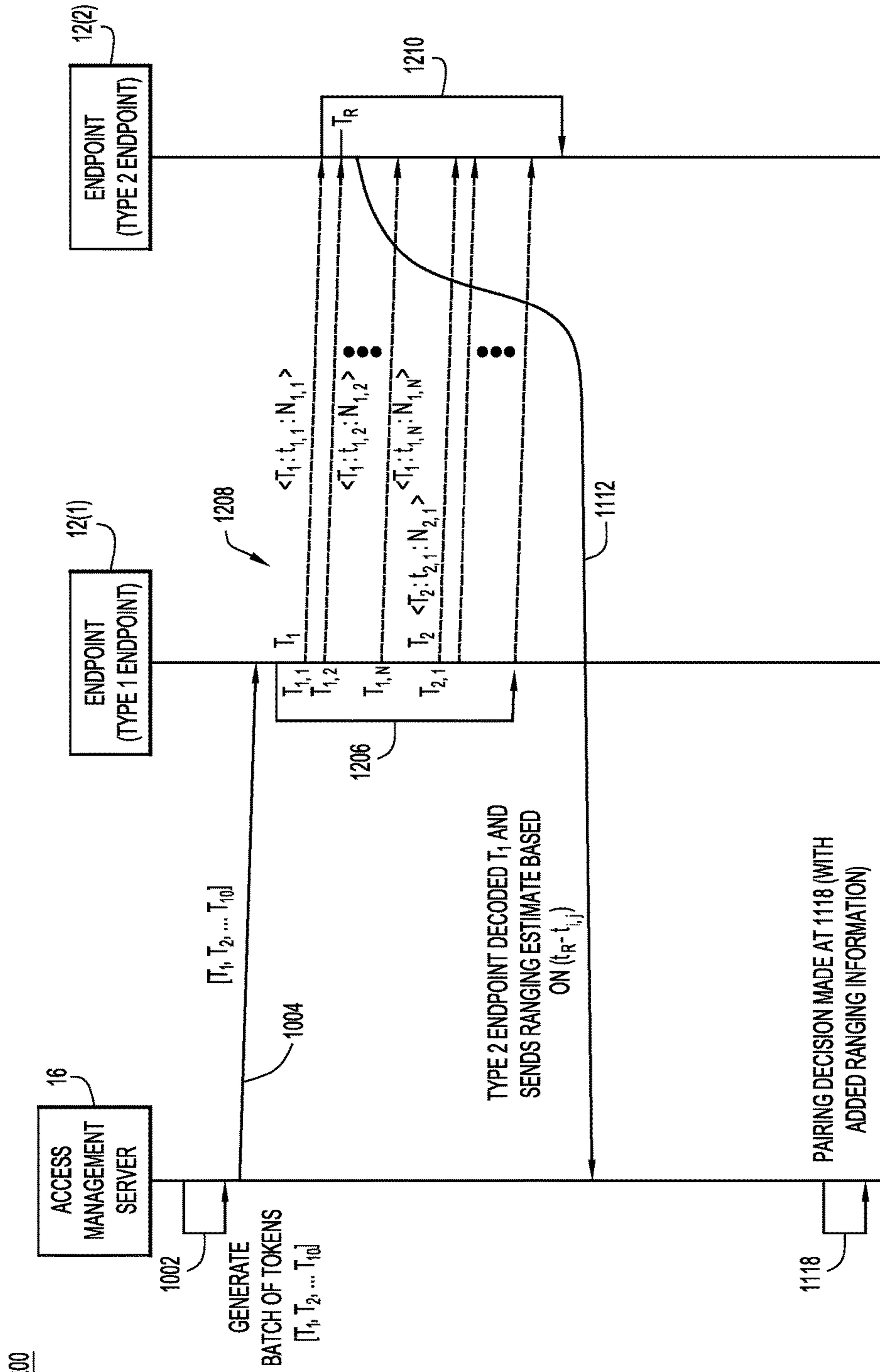


FIG.12

1200

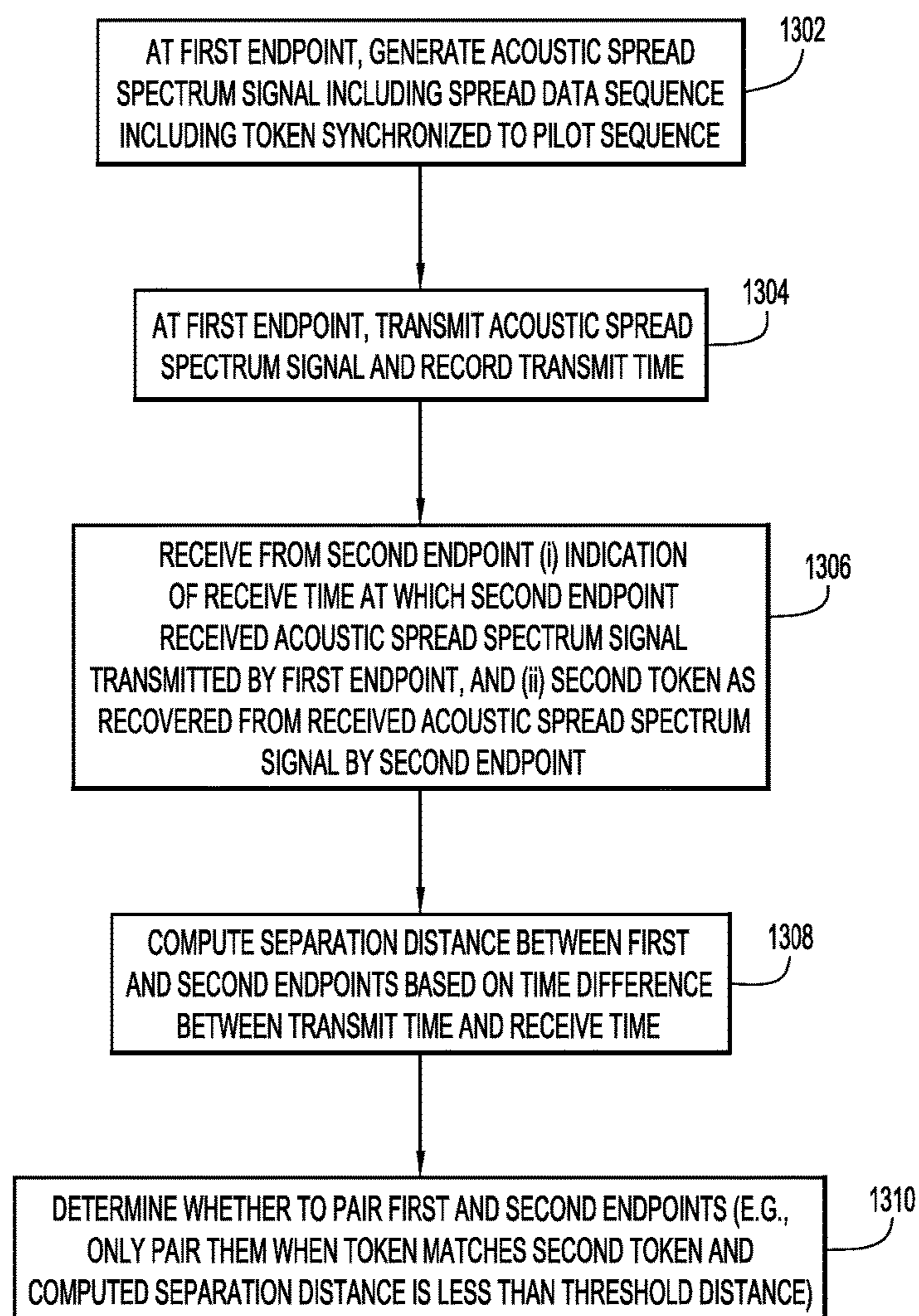
1300

FIG.13

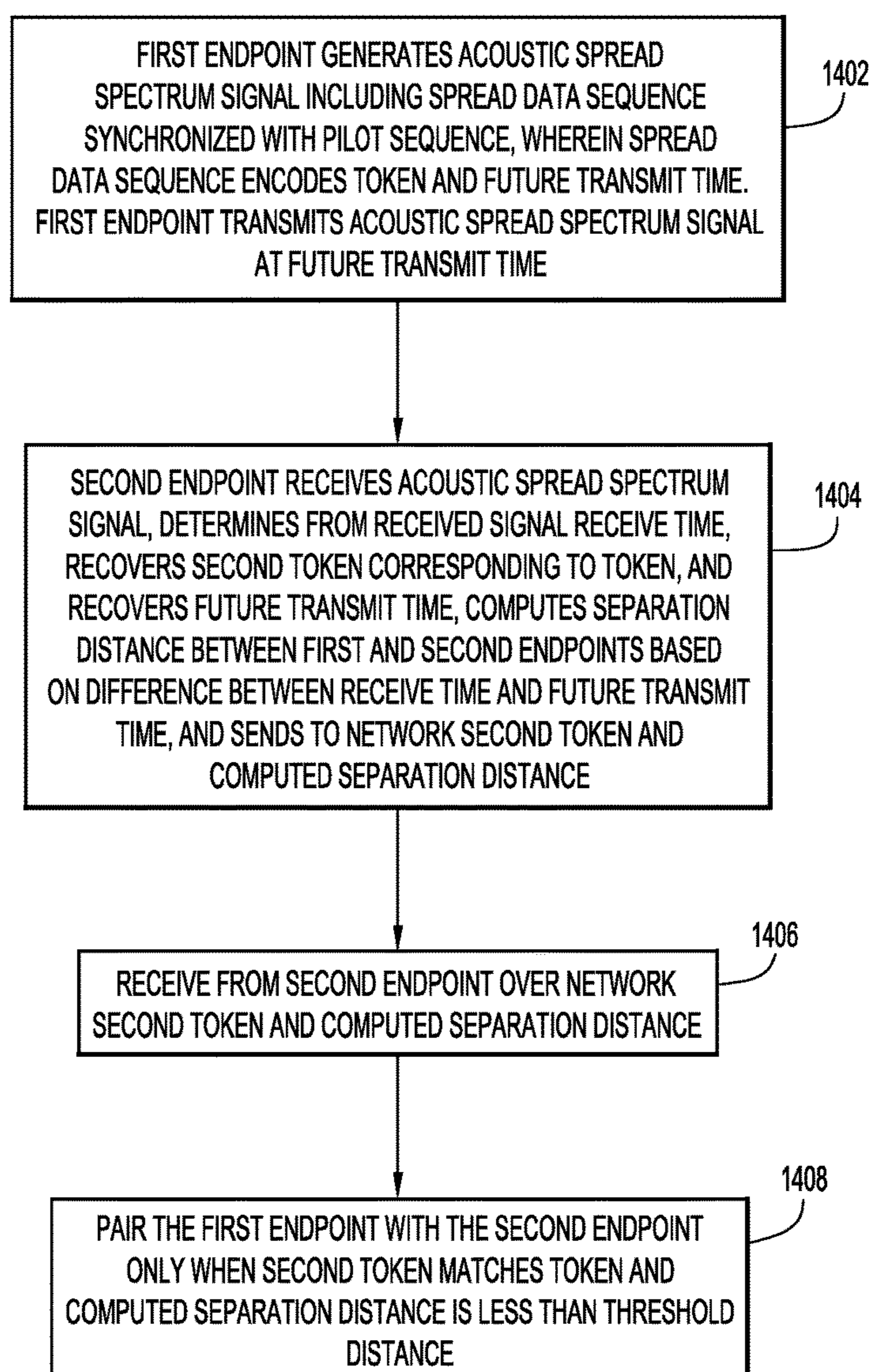
1400

FIG.14

1500

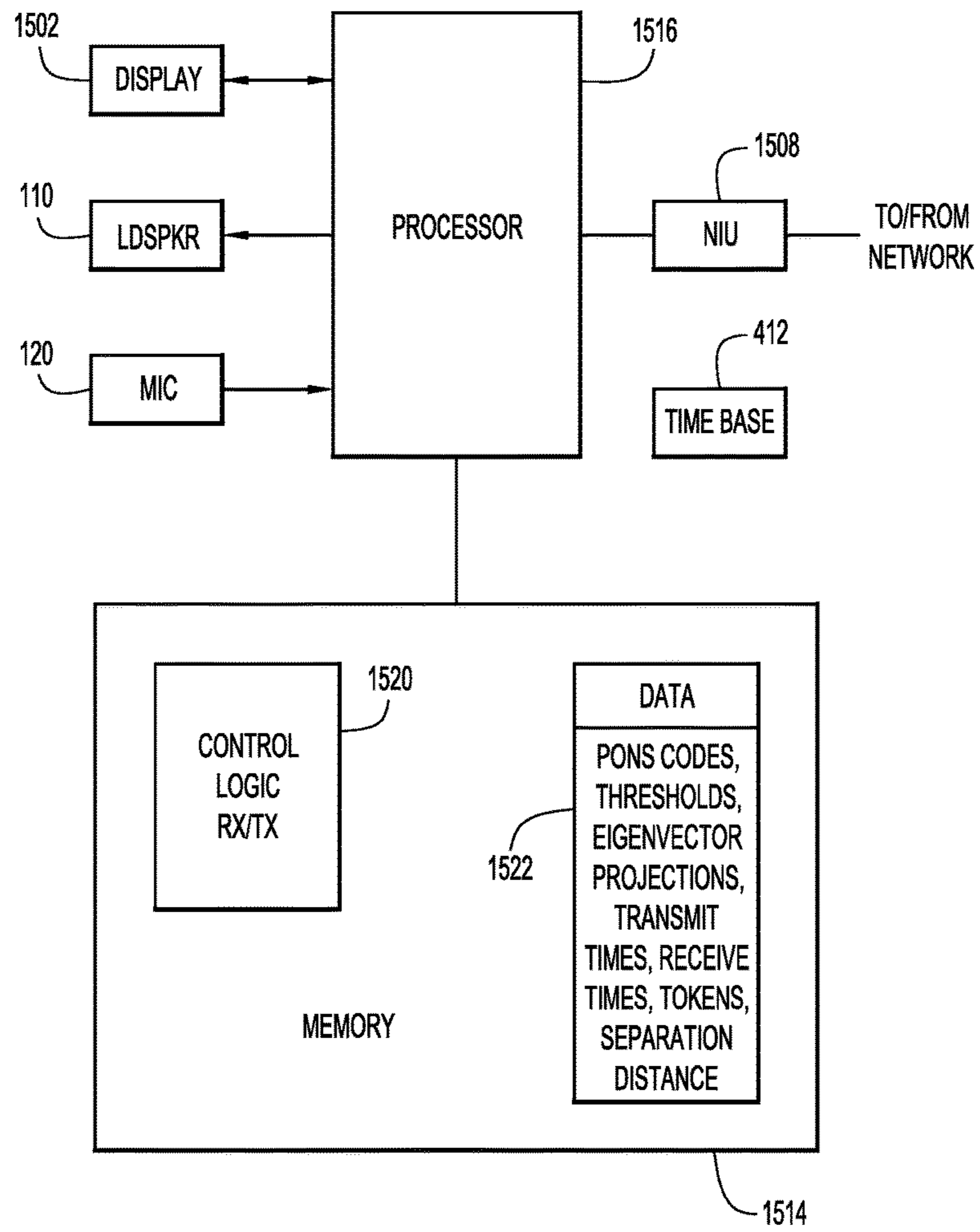


FIG.15

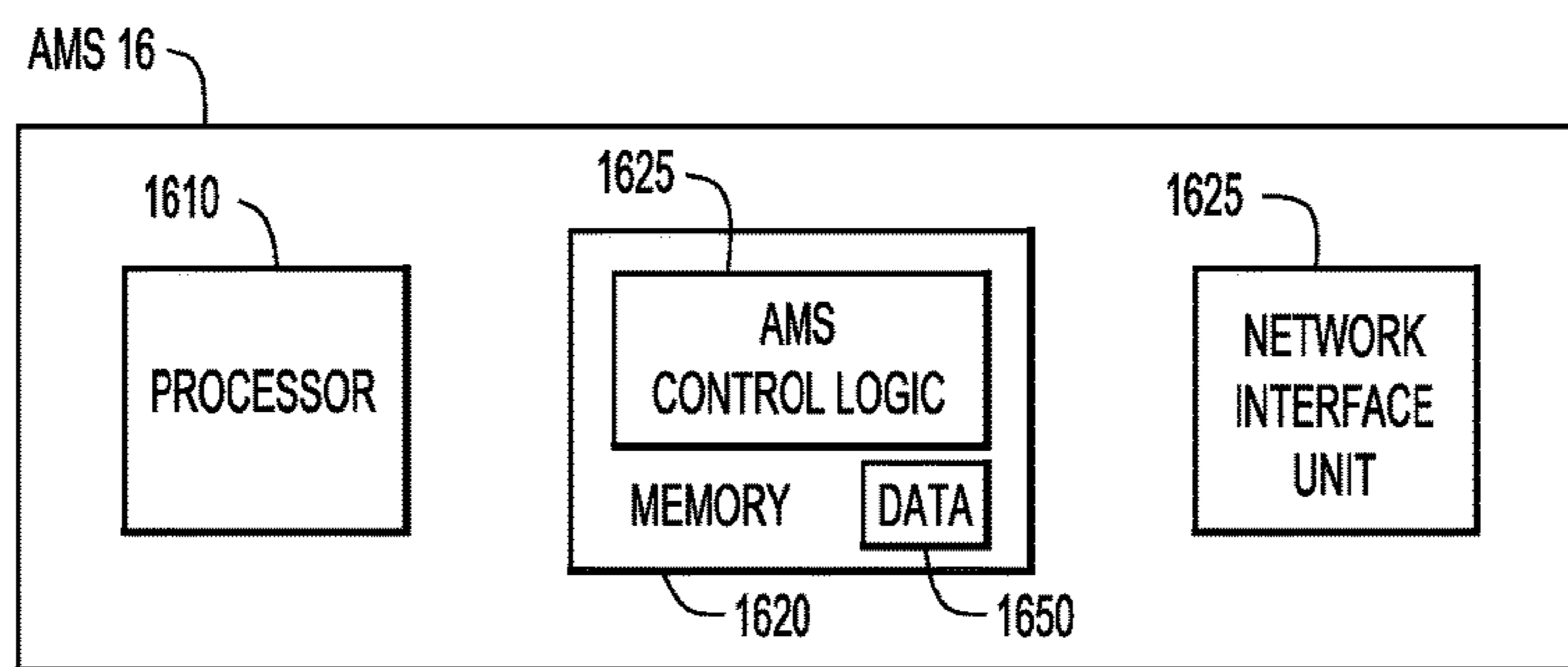


FIG.16

1

ENDPOINT PROXIMITY PAIRING USING ACOUSTIC SPREAD SPECTRUM TOKEN EXCHANGE AND RANGING INFORMATION

Matter enclosed in heavy brackets [] appears in the original patent but forms no part of this reissue specification; matter printed in italics indicates the additions made by reissue; a claim printed with strikethrough indicates that the claim was canceled, disclaimed, or held invalid by a prior post-patent action or proceeding.

TECHNICAL FIELD

The present disclosure relates to proximity pairing of endpoints using acoustic spread spectrum communications.

BACKGROUND

Room environments are challenging for transmission of information via acoustic signals. This is due to the extreme multi-path nature of an impulse response of the room from the transmission source (loudspeaker) to wherever the capture device (microphone) resides. Although humans are well adapted for this environment, traditional forms of communications (e.g. using acoustic tones and pulses) have difficulty operating reliably in such an environment. As an example, direct path sound may be as much as 20 dB below a sum of reverberant sound (non-direct path sound) when the loudspeaker and the microphone are separated by 30 feet in a typical conference room. Proximity pairing of endpoint devices is used to associate the endpoint devices with each other prior to establishing a communication session between the devices. Proximity pairing involves an exchange of signals between the endpoint devices to be paired, but the exchange of signals often suffers from the extreme multipath mentioned above, which may prevent appropriate pairing, or possibly result in inappropriate pairing.

BRIEF DESCRIPTION OF THE DRAWINGS

FIG. 1A is an illustration of a communication environment in which embodiments directed to proximity verification using acoustic spread spectrum techniques for token exchange and derivation of ranging information may be implemented.

FIG. 1B is a block diagram of an acoustic spread spectrum communication system, including a spread spectrum acoustic transmitter and a spread spectrum acoustic receiver, in which a pilot sequence and data spreading codes based on a Prometheus Orthonormal Set (PONS) may be used, according to an example embodiment.

FIG. 2 is an absolute magnitude vs. time-shift plot of PONS cross-correlation and autocorrelation averages for PONS codes or eigenvectors of order 2^K where $K=6$, according to an example embodiment.

FIG. 3 is an illustration of the PONS matrix $P_{128,128}$, which defines PONS eigenvectors of order 2^7 , according to an example embodiment.

FIG. 4 is a block diagram of the spread spectrum acoustic transmitter that expands on an encoder of the transmitter, according to an example embodiment.

FIG. 5 is an illustration of data-to-eigenvector mappings used in the spread spectrum acoustic transmitter, according to an embodiment.

FIG. 6 is an illustration of a timing relationship between a PONS pilot eigenvector and a sequence of PONS data

2

eigenvectors generated by the spread spectrum acoustic transmitter, according to an embodiment.

FIG. 7 is a block diagram of the spread spectrum acoustic receiver that expands on a decoder of the receiver, according to an embodiment, according to an embodiment.

FIG. 8 is a flowchart of a transmit method performed by the spread spectrum acoustic transmitter, according to an example embodiment.

FIG. 9 is a flowchart of a receive method performed by the spread spectrum acoustic receiver, according to an example embodiment.

FIG. 10 is a transaction diagram by which proximity verification/authentication using an acoustic spread spectrum signal for token exchange and ranging information is achieved in the environment of FIG. 1A, according to a first embodiment.

FIG. 11 is a transaction diagram by which proximity verification/authentication using an acoustic spread spectrum signal for token exchange and ranging information is achieved in the environment of FIG. 1A, according to a second embodiment.

FIG. 12 is a transaction diagram by which proximity verification/authentication using an acoustic spread spectrum signal for token exchange and ranging information is achieved in the environment of FIG. 1A, according to a third embodiment.

FIG. 13 is a flowchart of a method of pairing endpoints using an acoustic spread spectrum signal for token exchange and ranging information including operations from the method of FIG. 10, according to an embodiment.

FIG. 14 is a flowchart of a method of pairing endpoints using an acoustic spread spectrum signal for token exchange and ranging information including operations from the method of FIGS. 11 and 12, according to an embodiment.

FIG. 15 is a block diagram of a communication device, e.g., an endpoint device, in which the spread spectrum acoustic transmitter and the spread spectrum acoustic receiver may be implemented, according to an example embodiment.

FIG. 16 is a simplified block diagram of an access management server from FIG. 1A, according to an embodiment.

DESCRIPTION OF EXAMPLE EMBODIMENTS

Overview

In a first embodiment, a first endpoint device generates an acoustic spread spectrum signal including a pilot sequence and a spread data sequence representing a token synchronized to the pilot sequence, transmits the acoustic spread spectrum signal, and records a transmit time at which the acoustic spread spectrum signal is transmitted. A receive time at which a second endpoint device received the acoustic spread spectrum signal transmitted by the first endpoint device is received from the second endpoint device along with an indication of a second token as recovered from the received acoustic spread spectrum signal by the second endpoint device. A separation distance between the first endpoint device and the second endpoint device is computed based on a time difference between the transmit time and the receive time. The first endpoint device is paired with the second endpoint device when the token matches the second token and the computed distance is less than a threshold distance.

In a second embodiment, a first endpoint device generates an acoustic spread spectrum signal including a pilot sequence and a spread data sequence synchronized with the pilot sequence. The spread data sequence encodes both a

token and a future transmit time at which the acoustic spread spectrum signal will be transmitted. The first endpoint device transmits the acoustic spread spectrum signal at the future transmit time. A second endpoint device receives the acoustic spread spectrum signal, determines from the received acoustic spread spectrum signal a receive time, a second token corresponding to the token, and the future transmit time. A separation distance between the first endpoint device and the second endpoint device is computed based on a difference between the receive time and the future transmit time, and the second token and the computed separation distance are sent to a network. The second token and the computed separation distance are received from the second endpoint device over the network. The first endpoint device is paired with the second endpoint device when the second token matches the token and the computed separation distance is less than a threshold distance.

Example Embodiments

With reference to FIG. 1A, there is an illustration of a communication environment **10** in which embodiments directed to proximity verification using acoustic spread spectrum techniques for token exchange and ranging information may be implemented. Communication environment **10** includes: a first endpoint device **12(1)** equipped for audio/visual communication, such as a video conference device, a voice over Internet Protocol (VOIP) phone, or the like; a second endpoint device **12(2)** configured to communicate with the first endpoint device when in range of the first endpoint device over one or more acoustic channels **14**, each of the endpoint devices operated by a respective user (not shown in FIG. 1); and an access management server (AMS) **16** (referred to more simply as “management server” **16** or “management entity” **16**) that communicates with each of the endpoint devices over a communication network **20** connected with the endpoint devices, and the AMS. Communication network **20** may include one or more of a wired or wireless local area network (LAN) and wired or wireless wide area network (WAN), including the Internet. Network **20** may support a variety of protocols, including, without limitations, the Internet Protocol (IP), the Session Initiation Protocol (SIP), the Hypertext Transfer Protocol (HTTP), and the Real-time Transport Protocol (RTP), and so on. Endpoint devices **12(1)** and **12(2)** may be deployed in a shared work space or in different rooms in a building, for example. Moreover, endpoints **12** may move between the rooms over time. Communication environment **10** is shown by way of example, only, and it is understood, that the communication environment may support any number of endpoint devices.

Endpoint devices **12(1)** and **12(2)** (referred to individually as an “endpoint **12**” and collectively as “endpoints **12**”) are each configured to transmit and receive acoustic signals, including acoustic spread spectrum signals. Thus, endpoint **12(2)** may communicate with endpoint **12(1)** over one or more acoustic channels **14** established between the endpoints. Endpoints **12** may use any known or hereafter developed technique for channelizing audio to create the acoustic channels, such as: Time Division Multiplexing (TDM), in which different time slots are assigned to different channels; Frequency Division Multiplexing (FDM), in which different carrier frequencies or different frequency bands are assigned to different acoustic channels; Code Division Multiplexing, in (CDM), in which different spreading codes, e.g., spread spectrum codes, are assigned to different channels.

Endpoints **12** are considered to be in range of each other if an acoustic signal transmitted by one of the endpoints may be received, detected, and processed by the other endpoint,

e.g., when the two endpoints occupy the same room. When in range of each other, endpoints **12** may establish and engage in an audio/visual conference session with each other, and may also communicate with other endpoints (not shown in FIG. 1) over network **20**. Once the conference session is established, the participating endpoints, e.g., endpoints **12**, exchange information/content over acoustic channels **14**, and in turn exchange the information/content with network **20**.

According to embodiments presented herein, AMS **16** interacts with endpoint **12(1)** and endpoint **12(2)** to detect whether endpoint **12(2)** is in range of endpoint **12(1)** at any given time, and then authenticate endpoint **12(2)** based on a token exchange communication protocol implemented by and between the AMS and the endpoints, as will be described in detail below. Once a given endpoint has been authenticated, various operations may be performed with respect to that endpoint. For example, user profile information (e.g., a user phone number and an email address) stored in a centralized user profile database may be downloaded from the database to endpoint **12(1)** for subsequent use with respect to the authenticated endpoint (e.g., endpoint **12(2)**), such as for receiving and making phone calls via endpoint **12(1)**. Also, each authenticated endpoint (e.g., endpoint **12(2)**) may be assigned, and granted access to, a secure acoustic channel between the given endpoint and endpoint **12(1)** and over which the endpoint may exchange information/content during a conference session.

The above-described detecting and authenticating together represent “pairing” of endpoint **12(1)** with endpoint **12(2)** when in range of each other. Such pairing is also referred to herein as “proximity verification” of endpoints **12** because the pairing verifies the authenticity of the endpoints that are in range of each other (i.e., proximate each other). After proximity verification/authentication, endpoint **12(1)** and endpoint **12(1)** are referred to as “paired devices” or “paired endpoints.”

As mentioned briefly above, endpoints **12** employ acoustic spread spectrum techniques to communicate with each other over one or more acoustic channels **14**. Such acoustic spread spectrum techniques are described by way of example below in connection with FIGS. 1B and 2-9. The acoustic spread spectrum techniques form the basis for proximity pairing presented herein. Accordingly, after the spread spectrum techniques have been described below, embodiments directed to proximity pairing will be described in detail in connection with FIGS. 10-14.

Spread Spectrum Techniques

With reference to FIG. 1B, there is shown a block diagram of an example spread spectrum (SS) acoustic communication system **100** including portions of endpoints **12** in which spreading codes based on the Prometheus Orthonormal Set (PONS) may be used. Communication system **100** includes a spread spectrum acoustic transmitter (TX) **102** of endpoint **12(1)** and a spread spectrum acoustic receiver (RX) **104** of endpoint **12(2)**. Acoustic transmitter **102** includes an encoder **106**, an acoustic modulator **108**, and a loudspeaker **110** that perform sequential signal processing to convert input data **112** to a spread spectrum acoustic signal **114** that includes a pilot sequence and a spread data sequence that are time synchronized with each other. Loudspeaker **110** transmits acoustic signal **114** over an acoustic channel **116**. Acoustic signal **114** may have a frequency spectrum in an audible frequency band of human hearing (e.g., up to 20 kHz), an ultrasound frequency band (e.g., above 20 kHz), or a frequency band that spans both the audible and the ultrasound frequency bands. Acoustic receiver **104** includes

5

a microphone **120**, acoustic demodulator **122**, a correlator **124**, and a decoder **126** that perform sequential signal processing on acoustic signal **114** (when received) to convert the received acoustic signal to output data **130** representative of input data **112**.

TX **102** employs spreading codes based on the PONS (referred to as “PONS codes” or “PONS sequences”) to generate acoustic signal **114** from input data **112**, and RX **102** employs the PONS codes to recover output data **130** from the acoustic signal. The PONS codes are based on Shapiro polynomials, which have coefficients ± 1 . That is, each PONS code includes a sequence of coefficients in which each of the coefficients is ± 1 . PONS codes are generated based on a PONS construction. The PONS construction expands the Shapiro polynomials via a concatenation rule defined below. Working with sequences formed by the polynomial coefficients, various PONS matrices are as follows.

Starting with:

$$P_1 = \begin{bmatrix} P_{1,1} \\ Q_{1,1} \end{bmatrix} = \begin{bmatrix} 1 & 1 \\ 1 & -1 \end{bmatrix},$$

Concatenation leads to:

$$P_2 = \begin{bmatrix} P_{2,1} \\ Q_{2,1} \\ P_{2,2} \\ Q_{2,2} \end{bmatrix} = \begin{bmatrix} P_{1,1} & Q_{1,1} \\ P_{1,1} & -Q_{1,1} \\ Q_{1,1} & P_{1,1} \\ -Q_{2,2} & P_{1,1} \end{bmatrix} = \begin{bmatrix} 1 & 1 & 1 & -1 \\ 1 & 1 & -1 & 1 \\ 1 & -1 & 1 & 1 \\ -1 & 1 & 1 & 1 \end{bmatrix},$$

and letting

$$P_{m-1} = \begin{bmatrix} P_{m-1,1} \\ Q_{m-1,1} \\ \vdots \\ P_{m-1,2^{m-2}} \\ Q_{m-1,2^{m-2}} \end{bmatrix}$$

which is of dimensions $2^{m-1} \times 2^{m-1}$ with each row being one of the 2^{m-1} PONS sequences, the $2^m \times 2^m$ PONS matrix is obtained by

$$P_m = \begin{bmatrix} P_{m,1} \\ Q_{m,1} \\ P_{m,2} \\ Q_{m,2} \\ \vdots \\ P_{m,2^{m-1}-1} \\ Q_{m,2^{m-1}-1} \\ P_{m,2^{m-1}} \\ Q_{m,2^{m-1}} \end{bmatrix} = \begin{bmatrix} P_{m-1,1} & Q_{m-1,1} \\ P_{m-1,1} & -Q_{m-1,1} \\ Q_{m-1,1} & P_{m-1,1} \\ -Q_{m-1,1} & P_{m-1,1} \\ \vdots & \vdots \\ P_{m-1,2^{m-2}} & Q_{m-1,2^{m-2}} \\ P_{m-1,2^{m-2}} & -Q_{m-1,2^{m-2}} \\ Q_{m-1,2^{m-2}} & P_{m-1,2^{m-2}} \\ -Q_{m-1,2^{m-2}} & P_{m-1,2^{m-2}} \end{bmatrix}.$$

Thus, in one example of a 4×4 PONS matrix:

$$P_{2^2,2^2} = \begin{bmatrix} 1 & 1 & 1 & -1 \\ 1 & 1 & -1 & 1 \\ 1 & -1 & 1 & 1 \\ -1 & 1 & 1 & 1 \end{bmatrix}$$

$$P_{2^2,2^2} * P_{2^2,2^2}^T = 4 * I$$

$$P_{2^K,2^K} * P_{2^K,2^K}^T = 2^K * I$$

and any row/column can be negated and still have $P * P^T = (2^K) * I$.

6

According to the PONS construction described above, PONS codes are defined in a PONS matrix P having 2^K rows and 2^K columns of PONS coefficients each equal to ± 1 . Each row/column represents a code that may be used (i) to spread input data **112** to produce a spread data sequence that achieves spread spectrum gain, or (ii) directly as a pilot signal (i.e., pilot sequence) having autocorrelation properties useful for pilot synchronization, as described below in connection with FIG. 2. In the ensuing description, the term “PONS eigenvector” may be used synonymously and interchangeably with the terms “PONS code” or “PONS sequence.” Thus, a “PONS eigenvector” or simply “eigenvector” refers to a sequence of PONS coefficients.

With reference to FIG. 2, there is a magnitude vs. time-shift plot of PONS cross-correlation and autocorrelation magnitude amplitude averages for PONS codes or eigenvectors of order 2^K where $K=6$, i.e., defined in the PONS matrix $P_{64,64}$. PONS matrix $P_{64,64}$ defines 64 PONS eigenvectors (rows), each having a length of 64 PONS coefficients (i.e., 2^6 PONS coefficients). The autocorrelation plot includes an autocorrelation peak **205** at time shift zero (corresponding to when a PONS eigenvector is time-aligned with itself). Autocorrelation peak **205** is centered in time within a relatively wide zero-autocorrelation-zone (ZAZ) **210** equal to $\frac{1}{2}$ the length of the PONS eigenvector. When TX **102** generates acoustic signal **114** so as to include one of the PONS eigenvectors as a pilot sequence, RX **104** exploits ZAZ **210** for pilot sequence synchronization, as described below.

With reference to FIG. 3, there is an illustration of the PONS matrix $P_{128,128}$, which defines PONS eigenvectors of order 2^7 , i.e., $K=7$. That is, PONS matrix $P_{128,128}$ defines a set of 128 (2^7) PONS eigenvectors (rows) each having a length of 128 PONS coefficients. The set of 128 PONS eigenvectors is divided in half into a first half/subset **305** of PONS eigenvectors and a second half/subset **310** of PONS eigenvectors. Each PONS eigenvector in first half **305** includes 128 PONS coefficients that sum together to a value of zero. These PONS eigenvectors are referred to as “zero-sum” eigenvectors. Each PONS eigenvector in second half **310** includes 128 PONS coefficients whose row elements sum together to a value of 16. This exemplifies a general property of the PONS construction, which, when K is odd (e.g., $K=7$ for PONS matrix $P_{128,128}$), half of the PONS eigenvectors in the corresponding PONS matrix P are zero-sum PONS eigenvectors, while the other half are not. The zero-sum and the non-zero sum PONS eigenvectors may be used both as pilot sequences and to spread input data to produce spread data sequences; however, it is advantageous to use the zero-sum PONS eigenvectors because their use eliminates a direct current (DC) component from the resulting pilot sequences and spread data sequences. The use of zero-sum eigenvectors is thus especially useful for baseband (i.e., non-modulated) implementations of this invention.

Another property of zero-sum PONS eigenvectors exploited in embodiments presented herein is that the zero-sum PONS eigenvectors are timewise orthogonal to each other across different eigenvector lengths that are odd powers of 2 (i.e., across lengths of 2^K , where K takes on a range of odd values). For example, there are many subsets of 4 concatenated PONS eigenvectors each of length 2^9 , when time-aligned with a specific PONS eigenvector of length 2^{11} , are each orthogonal to the longer PONS eigenvector. The longer PONS eigenvector is referred to as a pilot eigenvector and the shorter PONS eigenvector subset is referred to as a user or data eigenvector for reasons to be apparent shortly. The timewise orthogonality of carefully crafted subsets

occurs over many different pairs of odd powers of two, such as pairs of lengths including $2^{13}/2^{11}$, $2^{11}/2^9$, and $2^9/2^7$. Orthogonality also occurs across odd powers of two greater than two, such as $2^{13}/2^9$. The design of such user eigenvector subsets is outside the scope of the present invention and is not described here. An example of such orthogonality will be described in connection with FIG. 6.

With reference to FIG. 4, there is a block diagram of TX 102 that shows details of encoder 106, according to an embodiment. Encoder 106 includes a pilot generator 402 and a data mapper/spreader 404. Encoder 106 stores PONS pilot eigenvectors 406 in a memory of TX 102 (not shown), each of which may be used to generate a pilot sequence for spread spectrum synchronization. Encoder 106 also stores in the memory data-to-eigenvector mappings 408 configured to map multi-bit words of input data 112 to PONS data eigenvectors (also referred to as "user eigenvectors" because they are used to spread user data) based on the values of the multi-bit words, such that each mapping uniquely maps a respective one of the multi-bit words to a corresponding one of the PONS data eigenvectors. Thus, each PONS data eigenvector represents a spread version of its mapped multi-bit word in order to achieve spread spectrum gain in communication system 100 (assuming each bit of the multi-bit word corresponds to multiple PONS coefficients).

Pilot generator 402 receives distinct user identifiers (IDs) 410(1)-410(X) to identify different users and selects a PONS pilot eigenvector from PONS pilot eigenvectors 406 corresponding to one of the user identifiers. In this way, pilot generator 402 may select different ones of PONS pilot eigenvectors 406 corresponding to different ones of user identifiers 410(1)-410(X). In accordance with pilot generator timing signals synthesized by a time base 412, pilot generator 402 generates/outputs the selected pilot eigenvector as a pilot sequence 420 that extends across a pilot frame, such that the pilot sequence begins and ends where the pilot frame begins and ends in time, respectively. Pilot generator 402 provides pilot sequence 420 to a mixer 422. Pilot generator 402 also provides to data mapper/spreader 404 a timing or synchronization signal 424 representative of the pilot generator timing used to generate pilot sequence 420, i.e., representative of the pilot frame.

Data mapper/spreader 404 receives input data 112, groups the input data as it arrives into multi-bit words or "tokens," and maps each of the multi-bit words (i.e., tokens) to a corresponding data eigenvector based on data-to-eigenvector mappings 408. Data mapper/spreader 404 outputs the corresponding data eigenvectors in sequence as a spread data sequence 426 based on synchronization signal 424, such that the sequence of data eigenvectors collectively spans and is time-aligned (i.e., synchronized) with pilot sequence 420 (i.e., with the pilot frame). The output data eigenvectors span/occupy respective sequential data frames that are time-aligned with the pilot frame, such that a first one of the data eigenvectors/data frames in the sequence of data eigenvectors/data frames begins where pilot sequence 420 (i.e., the pilot frame) begins, and a last one of the data eigenvectors/data frames ends where the pilot sequence/pilot frame ends in time. Mixer 422 mixes pilot sequence 420 with spread data sequence 426 (i.e., the sequence of data eigenvectors spanning the pilot frame) to produce a spread spectrum baseband signal 430 that includes the pilot sequence and the data eigenvectors time-aligned or synchronized with each other. In addition, based on synchronization signal 424 and the timing signals from time base 412, encoder 106 records times at which the pilot frame begins and ends, and times at which each of the data frames

synchronized with the pilot frame begins and ends, and makes the recorded times available for other processing, described below in connection with FIGS. 10-14. The recorded times may be represented as digital words having a sub-millisecond resolution for example. Over time as encoder 106 receives input data 112, pilot generator 402 and data mapper/spreader 404 repeatedly perform their respective operations described above to generate time-aligned pilot sequences and spread data sequences.

Acoustic modulator 108 and loudspeaker 110 together generate acoustic signal 114 from baseband signal 430 and transmit the acoustic signal over acoustic channel 116. Acoustic modulator 108 can move the frequency spectrum occupied by acoustic signal 114 arbitrarily in frequency via amplitude modulation, although other forms of narrowband modulation are possible (e.g., low-index frequency or phase modulation). In an example, acoustic modulator may include an up-sampler followed by a root raised cosine filter.

With reference to FIG. 5, there is an illustration of example data-to-eigenvector mappings for mappings 408. In the example of FIG. 5, mappings 408 include 32 5-bit words 505 (0000-11111) mapped to corresponding ones of 32 data eigenvectors 510. Each data eigenvector (e.g., data eigenvector 515a) has a corresponding data eigenvector (e.g., 515b) that is a negated version of the data eigenvector (e.g., of data eigenvector 515a). Thus, data eigenvectors 510 include a first subset of 16 data eigenvectors and a second subset of 16 data eigenvectors for a total of 32 data eigenvectors, where each data eigenvector in the second subset is a negated version of a corresponding one of the data eigenvectors in the first set.

In the example of FIG. 5, the 16 possible positive data eigenvectors (choices) yields 32 different possible data eigenvectors (i.e., the 16 positive data eigenvectors and their negatives) to mix with pilot sequence 420. All of the 32 data eigenvectors can be uniquely resolved at RX 104. Because 32 data eigenvectors translates to 2^5 possibilities, encoder 106 can take 5 bits (i.e., a 5-bit word) and, dependent on the value of the bits, send one of the 32 data eigenvectors to RX 104. Upon reception of the one of the data eigenvectors, RX 104 can map-back to the 5 bits. The process performed at RX 104 will be described more fully below in connection with FIG. 7.

More generally, each data eigenvector of data-to-eigenvector mappings 408 is a PONS eigenvector of order 2^M (M is odd), and each pilot eigenvector of PONS pilot eigenvectors 406 is a PONS eigenvector of order 2^{M+K} (K is even and >0). In an example, $K=2$. As mentioned above, use of pilot eigenvectors and data eigenvectors having respective lengths that are different odd powers of 2 ensures that any chosen pilot eigenvector is timewise orthogonal with any of the specially designed subsets of data eigenvectors when a specific pilot eigenvector is aligned with the data eigenvector. As a result, in FIG. 4, pilot sequence 420 (representing the pilot eigenvector selected from PONS pilot eigenvectors 404 according a given user ID 410(i)) is orthogonal to each of the data eigenvectors in spread data sequence 426 time-aligned with the pilot sequence.

With reference to FIG. 6, there is an illustration of an example timing relationship 600 between a pilot sequence 605 (the selected pilot eigenvector) and a sequence of contiguous data eigenvectors 610a, 610b, 610c, and 610d as would exist in baseband signal 430 and correspondingly in acoustic signal 114. Pilot sequence 605 spans a pilot frame and each of data eigenvectors 610i spans a respective data frame in acoustic signal 114. In the example of FIG. 6, each data eigenvector 610i is of order 2^9 (length=512 coeffi-

cients), while pilot eigenvector **605** is of order 2^{11} (length=2048 coefficients, or 4 times the length of the data eigenvector). With the illustrated timing relationship in which the full extent of data eigenvectors **610a-610d** begins and ends in time alignment with pilot eigenvector **605**, and due to the properties of the PONS construction (and pilot selection and user eigenvector subset selection), each data eigenvector **610i** is orthogonal to the portion of the pilot eigenvector of the same length. Such orthogonality advantageously simplifies decoding of acoustic signal **114** at RX **104** because the pilot sequence need not be removed/subtracted from the acoustic signal prior to it being decoded.

In the example of FIG. 6, there is a minimum difference in odd powers of two between pilot sequence **605** and data eigenvectors **610** (which is 2, such as $2^{11}/2^9$), which yields the largest possible ZAZ for the data eigenvectors. If there is reverberation in a room in which communication system **100** is deployed resulting in data eigenvector reflections within the ZAZ of the data eigenvector, such reflections will be cancelled at RX **104**. Reverberations outside of the ZAZ of the data eigenvector appear as uncorrelated noise. As long as there is sufficient spread spectrum gain (due to data spreading) to overcome the uncorrelated noise, it will be possible for RX **104** to decode individual data eigenvectors. Thus, communication system **100** exploits both the ZAZ property of the PONS codes and spread spectrum gain to overcome room reflections and reverberation.

With reference to FIG. 7, there is a block diagram of RX **104** that expands on decoder **126**, according to an embodiment. When RX **104** receives acoustic signal **114**, microphone **120** detects acoustic signal **114** to produce detected acoustic signal **704**. Acoustic demodulator **122** demodulates detected acoustic signal **704** to produce a baseband signal **706**, and provides the baseband signal to correlator **124**. In an example, acoustic demodulator includes a root raised cosine filter followed by a down-sampler. Correlator **124** correlates baseband signal **706** with a replica **708** of the pilot eigenvector selected by pilot generator **402** and used to generate pilot sequence **420** in TX **102**, to produce correlation amplitudes that are used to detect the presence of the pilot sequence (i.e., the selected pilot eigenvector) in baseband signal **706**. Correlator **124** detects the pilot sequence as a correlation peak (i.e., an autocorrelation peak) among the correlation amplitudes. The magnitude (level) of the autocorrelation peak relative to the non-peak values defines a quality of "lock" of correlator **124** on the pilot sequence (e.g., lower amplitude corresponds to lower quality lock or even failure to lock, and vice versa).

Correlator **124** also derives (i) a best sampling phase **708** for sampling baseband signal **706**, and (ii) a timing signal **710** indicative of pilot frame timing and thus data frame timing (e.g., the time position of the pilot and data frames in baseband signal **706**) based on the detected autocorrelation peak magnitude. Timing signal **710** may include digital time words having sub-millisecond resolution/accuracy that are representative of various receive times associated with baseband signal **706**, such as times for the pilot sequence and data frame boundaries in the baseband signal, and the autocorrelation peak. Timing signal **710** may be provided to other processing discussed below in connection with FIGS. **10-14**. Correlator **124** provides best sampling phase **708**, timing signal **710**, and baseband signal **706** to decoder **126**. Correlator **124** may also derive a correlation ratio metric **712** indicative of whether correlator **124** has detected and locked-onto the pilot sequence. A correlation ratio (value) below a predetermined correlation ratio threshold indicates that correlator **124** has detected and locked-onto the pilot

sequence, while a correlation ratio equal to or above the correlation ratio threshold indicates that the correlator has not detected and locked-onto the pilot sequence.

The quality of lock, as indicated by the correlation ratio, is described briefly. When an acoustic space, such as a room, in which RX **104** is deployed is sounded with an acoustic signal that includes only a pilot sequence (i.e. no data eigenvector is mixed with the pilot sequence), correlator **124** produces a cross-correlation result that is a smoothed version of the impulse response of the room. RX **104** locks-on to energy from a dominant signal path, even if that energy is a time-delayed version of a direct signal path. However, whenever the direct signal path and the dominant signal path deliver energy of similar magnitudes, the time difference between the two paths is generally no more than about 10 milliseconds. For this reason, the quality of lock is given by an inverse ratio of a peak absolute magnitude of the cross-correlation to a secondary peak absolute magnitude which occurs in a region of 50 milliseconds to 10 milliseconds before the peak absolute magnitude occurs. In an embodiment, this is the above-mentioned correlation ratio. The 50 to 10 millisecond region is within the ZAZ of the pilot sequence (i.e., when no data eigenvector is present, the secondary peak absolute magnitude should be zero, and thus the correlation ratio is zero).

The correlation ratio takes into account pilot sequence power relative to spread data sequence power and a length of the pilot sequence relative to that of the data eigenvectors. The correlation ratio, in the absence of any noise is well below 0.2. The correlation ratio can degrade (i.e., increase) due to room reverberation (aka multi-path in other disciplines) and other room noise. A correlation ratio below 0.75 is adequate to determine a quality lock in highly reverberant rooms.

In addition to the correlation ratio metric, another signal-strength metric may optionally be generated from the cross-correlation peak. Using similar methodology to the correlation ratio metric, an average power is computed from the samples in the region 50 milliseconds to 10 milliseconds before the peak by summing the squared value of those samples and dividing by the number of those samples. A signal strength metric can be formed by the power of the cross-correlation peak (its squared value) divided by the average power found in the 50 to 10 millisecond region. Such a metric, expressed in dB, has been useful in determining how strong the received signal is in comparison to the received noise. The optional signal-strength metric is depicted as signal strength indication **714** in FIG. 7, and may be used in conjunction with the correlation ratio metric.

Decoder **126** derives/recovers output data **130** from baseband signal **706** based on best sampling phase **708** and timing signal **710**. Decoder **126** operates as a data despreader/demapper because it performs operations reverse to those performed by data mapper/spreader **404**. In one embodiment, decoder **126** recovers output data **130** from baseband signal **706** in the presence of the pilot sequence, i.e., without removing the pilot sequence from the baseband signal. This is practically achievable because the time-aligned pilot sequence and data eigenvectors representing the output data are orthogonal to each other based on the PONS construction. In another embodiment, decoder **126** (or correlator **124**) removes/subtracts the pilot sequence from baseband signal **706** before the decoder recovers output data **130**, i.e., the output data is recovered in the absence of the pilot sequence.

Decoder **126** includes a dot-product generator **720**, a metrics generator **722**, a data eigenvector selector **724**, and

data-to-eigenvector mappings **726** stored in a memory of RX **104** (not shown), which are copies of mappings **408** in TX **102**. For each data frame spanned by the pilot frame in baseband signal **706**, dot-product generator **720** performs a respective dot-product operation between each data eigenvector in mappings **726** and the signal energy in the data frame, to produce respective ones of dot-product amplitudes **730** indicative of respective similarities between the signal energy and the corresponding data eigenvectors (e.g., the higher the dot-product amplitude the more similar are the signal energy and the corresponding eigenvector) for that data frame. Dot-product amplitudes **730** are also referred to as “eigenvector projections.” For example, dot-product generator **720** performs: a first dot-product operation between a first data eigenvector in mappings **726** and the data frame, to produce a first dot-product amplitude **730(1)** indicative of a similarity between the energy in the data frame and the first data eigenvector; a second dot-product operation between the data frame and a second data eigenvector in mappings **726**, to produce a second dot-product amplitude **730(2)** indicative of a similarity between the energy in the data frame and the second data eigenvector; and so on across *Y* data eigenvectors in mappings **726**. More generally, dot-product generator **720** projects each of the data eigenvectors in mappings **726** onto the energy in the data frame (which is simply a time segment of baseband signal **706** equal to a length of a data eigenvector) to produce respective projected amplitudes **730** indicative of similarity. Although the pilot sequence may contribute undesired energy to the data frame, the undesired energy does not contribute to any of the projected amplitudes due to orthogonality between the pilot sequence and each of the projected data eigenvectors. Other operations besides dot-product operations may be used to generate such projections/amplitudes indications of similarity.

In the absence of any noise, all of the energy/power in the data frame should project on the data eigenvector that occupies the data frame (as inserted by encoder **106**). To the extent that the projection onto other data eigenvectors in the set of data eigenvectors yields significant energy in those eigenvector projections, this indicates imperfect reception. In the limit, when noise is sufficient to overcome an ability of RX **104** to recover the data eigenvectors from acoustic signal **114**, the projected energy is spread equally over all possibilities/data eigenvectors. Accordingly, metrics generator **722** generates two power metrics used to determine a level of confidence that a highest one of the eigenvector projections represents a correct data eigenvalue.

Metrics generator **722** computes the two confidence metrics based on eigenvector projections **730** as now described. Metrics generator **722** determines a largest eigenvector projection $P(\text{Largest})$ and a next largest eigenvector projection $P(\text{Next_Largest})$ among eigenvector projections **730**. Metrics generator **722** also computes an average P_{AVG} of all eigenvector projections **730** except the $P(\text{Largest})$ projection. Metrics generator **722** computes a first power metric “user-to-next largest ratio” $U2SecU$, in dB, which is a ratio of largest eigenvector projection $P(\text{Largest})$ to next largest eigenvector projection $P(\text{Next_Largest})$, as follows:

$$U2SecU=10*\log_{10} [P(\text{Largest})/P(\text{Next_Largest})].$$

Metrics generator **722** computes a second power metric “user-to-average-non-user ratio” $U2ANU$, in dB, which is a ratio of largest eigenvalue projection $P(\text{Largest})$ to average P_{AVG} , as follows:

$$U2ANU=10*\log_{10} [P(\text{Largest})/P_{AVG}].$$

Metrics generator **722** provides the first and second power metrics to data eigenvector selector **724**.

Data eigenvector selector **724** receives power metrics $U2SecU$ and $U2ANU$, and may also receive correlation ratio **712**. In an embodiment, selector **724** tests whether power metric $U2SecU$ is above a first predetermined threshold and whether second power metric $U2ANU$ is above a second predetermined threshold. If both tests pass, then data selector **724** selects the data eigenvector among mappings **726** whose dot-product resulted in largest eigenvector projection $P(\text{Largest})$ as a best match to the energy in the data frame, and outputs the multi-bit word mapped to that (best matched) data eigenvector in mappings **726**. If both tests do not pass, then data selector **724** does not select one of the data eigenvectors from mappings **726** and does not output any multi-bit word.

In another embodiment, selector **724** tests whether power metric $U2SecU$ is above the first predetermined threshold, whether second power metric $U2ANU$ is above the second predetermined threshold, and whether the correlation ratio is below the correlation ratio threshold (mentioned above). If all three tests pass, then data selector **724** selects the data eigenvector among mappings **726** whose dot-product resulted in largest eigenvector projection $P(\text{Largest})$ as a best match to the energy in the data frame, and outputs the multi-bit word mapped to that data eigenvector. If all three tests do not pass, then data selector **724** does not select one of the data eigenvectors from mappings **726** and does not output any multi-bit word. In an example, the first threshold is 2 dB, the second threshold is 11 dB, and the correlation ratio threshold is 0.7, although other values for these thresholds may be used.

Decoder **126** repeats its above-described operations for each data frame in the pilot frame to recover respective multi-bit words for each of the data frames. Decoder **126** repeats this process over time for each received pilot frame.

Communication system **100** relies on spread spectrum gain and the PONS code *ZAZ* properties to overcome room acoustics. The PONS codes used for the pilot eigenvector and data eigenvectors as described above allows for successful decode when the desired signal is well below the noise (i.e., at negative SNRs). For example, a -6 dB in-band signal-to-noise ratio (SNR) has been attained using pilot sequence/data eigenvector orders $2^{11}/2^9$ (and a pilot to data amplitude ratio of 60%). If it is desired to improve correct decoding of the transmitted acoustic signal at a close distance, while a listener at a further distance is not necessarily able to be decoded correctly, a lower spread spectrum gain (i.e., lower-order spreading codes) may be used. The converse is also possible (higher spread spectrum gain with larger order spreading codes). Thus, communication system **100** may advantageously “tune spreading as a function of expected reverberation.”

Communication system **100** may be used in shared work spaces because multiple ones of the communication systems can exist in the same room/volume if different pilot sequences (pilot eigenvectors) are used by the different communication systems and different communication systems are sufficiently closely synchronized in time. This can be achieved using different ones of user IDs **410**. Since the speed of sound is relatively slow relative to radio waves, this is possible using services, such as running the Network Time Protocol (NTP), on different components of the communication systems.

The embodiments presented herein provide many advantages.

- a. The embodiments employ spread spectrum gain to overcome room reverberation in all spaces/rooms of interests (e.g., rooms not requiring presenter amplification). This allows for decoding of the dominant energy path signal in the presence of much larger reverberant energy.
- b. The embodiments, by using the same code construction for both the pilot and spread data sequences/signals, render the pilot signal orthogonal to the spread data signal which allows for a simple decoder design.
- c. The embodiments, by using spreading codes with large ZAZs, effectively render to zero early reflection energy within the ZAZ in comparison to other types of spreading codes in systems that do not employ such large ZAZ spreading codes.
- d. The embodiments, by using pilot signals with ZAZs, allow for the creation of a robust synchronization metric (e.g., correlation ratio), which is advantageous for acoustic environment applications.
- e. The codes employed by the embodiments, being a power of two based construction, can be designed to have any desired spread spectrum gain; allowing the embodiments to be tailored to low spread spectrum gain to high spread spectrum gain designs/applications.
- f. Multiple communication systems, via pilot code design, can be made to operate in the same room volume—allowing for shared workspace designs.

With reference to FIG. 8, there is a flowchart of an example transmit method 800 performed by TX 102.

At 805, TX 102 stores a set of data eigenvectors in mappings 408 that are based on the Prometheus Orthonormal Set (PONS) code construction and orthogonal to each other, wherein each of the data eigenvectors is mapped to a unique multi-bit word.

At 810, TX 102 generates pilot sequence 420 representing a selected pilot eigenvector that is also based on the PONS construction and orthogonal to each of the data eigenvectors.

At 815, TX 102 groups input data 112 into multi-bit words and selects ones of the data eigenvectors mapped to the multi-bit words. Input data 112 may include multi-bit tokens from AMS 16.

At 820, TX 102 generates spread data sequence 426 including the selected ones of the data eigenvectors and that is synchronized to pilot sequence 420.

At 825, TX 102 generates acoustic signal 114 including synchronized pilot sequence 420 and spread data sequence 426. TX 102 records start and stop times for the pilot sequence and the data frames.

At 830, TX 102 transmits acoustic signal 114, and may generate and record one or more transmit times for transmitted acoustic signal 114. The one or more transmit times may include the recorded start and stop times for the pilot sequence and the data frames. Additionally, TX 102 may add to the recorded start and stop times calibrated time delays introduced by acoustic modulator 108 and/or loudspeaker 110 acoustic modulator, to produce the one or more transmit times as time-delayed versions of the recorded start and stop times.

With reference to FIG. 9, there is a flowchart of an example receive method 900 performed by RX 104.

At 905, RX 104 stores (i) a set of data eigenvectors in mappings 726 that are based on the Prometheus Orthonormal Set (PONS) code construction and orthogonal to each other, wherein each of the data eigenvectors is mapped to a unique multi-bit word, and (ii) replica 708 of a pilot eigenvector that is also based on the PONS and is orthogonal to each of the data eigenvectors.

At 910, RX 104 receives acoustic signal 114 including a pilot sequence representing the pilot eigenvector and at least one of the data eigenvectors synchronized to the pilot sequence.

At 915, RX 104 detects the pilot sequence and its associated timing using replica 708.

At 920, RX 104 identifies a data frame in the acoustic signal that is occupied by the at least one data eigenvector based on the timing of the detected pilot sequence. RX 104 also records times of the detected pilot sequence, autocorrelation peak, and the data frame.

At 925, RX 104 determines which data eigenvector in the set of data eigenvectors is a best match to the at least one of the data eigenvectors in the data frame.

At 930, RX 104 outputs the multi-bit word that is mapped to the data eigenvector determined to be the best match to the at least one of the data eigenvectors.

Proximity Pairing Embodiments

Having described spread spectrum techniques in detail above, proximity pairing embodiments that employ the spread spectrum techniques to exchange tokens and derive ranging information used for the pairing are now described in connection with FIGS. 10-14.

With reference to FIG. 10, there is an example transaction diagram 1000 by which proximity verification/authentication using acoustic spread spectrum techniques for token exchange and ranging information is achieved in environment 10, according to a first embodiment. Transaction diagram 1000 shows messages exchanged between AMS 16, endpoint 12(1) (referred to as a “type 1 endpoint”), and endpoint 12(2) (referred to as a “type 2 endpoint”). AMS 16 communicates with each of endpoints 12 over network 20, while endpoints 12 communicate with each other over one or more of acoustic channels 14. It is assumed that endpoints 12 are in acoustic range of each other, e.g., in the same room.

At 1002, AMS 16 generates a batch of tokens T_1 - T_{10} to be used for proximity verification.

At 1004, AMS 16 sends to endpoint 12(1) over network 20 one or more messages carrying tokens T_1 - T_{10} .

At 1006, in response to receiving tokens T_1 - T_{10} from AMS 16, endpoint 12(1) employs the operations described above in connection with method 800 to generate and transmit acoustic spread spectrum signals that convey tokens T_1 - T_{10} . Specifically, endpoint 12(1):

- a. generates a first acoustic spread spectrum signal including a respective pilot sequence and a respective spread data sequence representing token T_1 synchronized to the pilot sequence. In an example, with reference again to FIG. 6, the pilot sequence may include pilot eigenvector 605, while the token may be encoded as one of data eigenvectors 610i;
- b. repeatedly transmits the first spread spectrum signal (conveying first token T_1) N times at successive/sequential transmit times $t_{1,1}$ - $t_{1,N}$, where $t_{i,j}$ represents the j^{th} transmission of token T_i in the respective acoustic spread spectrum signal;
- c. records each transmit time $t_{i,j}$; and
- d. repeats the above-described operations (a)-(c) for each of remaining tokens T_2 - T_{10} . The repeated transmissions of the spread spectrum signals are shown generally at 1008.

In this way, for each token T_i , endpoint 12(1): generates a respective acoustic spread spectrum signal including a respective pilot sequence and a respective spread data sequence representing the token T_i ; repeatedly transmits for a predetermined number of times the respective acoustic spread spectrum signal; and records the (transmit) time for

each transmit iteration. Note that AMS 16 is typically programmed with information that conveys the approximate repeat intervals between token transmissions by endpoint 12(1) (and all such endpoints to which the AMS sends the tokens for transmission), and the AMS uses the information to ensure that a given token is transmitted by only one of these endpoints during a given time interval (thus ensuring “token uniqueness”).

At 1010, endpoint 12(2) receives each of the acoustic spread spectrum signals transmitted by endpoint 12(1). Endpoint 12(2) processes each received acoustic spread spectrum signal according to method 900 to (i) determine a respective receive time t_R of each received acoustic spread spectrum signal, and (ii) recover/decode a respective one of tokens T_1 - T_{10} from the received acoustic spread spectrum signal. As a practical matter, endpoint 12(2) will—after successfully decoding the token—generally have to “back-calculate” where the peak of the cross-correlation function was to determine when t_R occurred. That is, the actual decoding of the token generally occurs after t_R .

At 1012, endpoint 12(2) sends to AMS 16 over network 20 one or more messages including the first recovered token, e.g., token T_1 , and an indication of the corresponding receive time t_R . Endpoint 12(2) sends each token it decodes to AMS 16, along with the associated time t_R .

At 1014, in response to receiving the one or more messages including token T_1 and receive time t_R from endpoint 12(2), AMS 16 sends to endpoint 12(1) over network 20 a request for the transmit times $t_{1,1}$ - $t_{1,N}$ corresponding to the transmissions of tokens T_1 - T_{10} from endpoint 12(1).

At 1016, in response to receiving the request for the transmit times from AMS 16, endpoint 12(1) sends to AMS 16 over network 20 the recorded transmit times $t_{1,1}$ - $t_{1,N}$.

At 1018, in response to receiving the recorded transmit times $t_{1,1}$ - $t_{1,N}$ from endpoint 12(1), AMS 16 determines whether to pair/associate endpoint 12(1) with endpoint 12(2), i.e., performs pairing with respect to endpoints 12. To do this, AMS 16 performs the following operations. AMS 16 determines/selects the one of transmit times $t_{1,1}$ - $t_{1,N}$ that is closest in time to receive time t_R , and computes a time difference Δt between the determined/selected transmit time and receive time t_R . Then, AMS 16 computes a separation distance between endpoint 12(1) and endpoint 12(2) as the product Δt *the velocity of sound in air. The computed time difference Δt and the separation distance are referred to herein as “ranging information.” Care must be taken to account for maximum differences between endpoint 12(1) and endpoint 12(2) timebases (e.g., a maximum NTP difference), particularly for short acoustic transmission times. Since AMS 16 may have a better knowledge of the time accuracy of endpoints 12, there is a benefit of the AMS computing the separation distance.

Once AMS 16 has computed the separation distance, the AMS makes a pairing decision with respect to endpoints 12(1) and 102(2) based on (i) the computed separation distance, and (ii) the fact that token T_1 was received from endpoint 12(2) by the AMS, indicating a successful roundtrip transmission of the token T_1 from the AMS to endpoint 12(1), and then from endpoint 12(2) back to the AMS (i.e., indicating that the token received from endpoint 12(2) matches the token initially sent to endpoint 12(1) by the AMS). In one example, AMS 16 decides to pair endpoint 12(1) with endpoint 12(2) only if (i) the token T_1 was received from endpoint 12(2) (i.e., the token received from endpoint 12(2) matches the token the AMS initially sent to endpoint 12(1)), and (ii) the separation distance is less than a predetermined threshold separation distance, e.g., less than

20 feet. If both conditions are met, AMS 16 considers endpoints 12 as paired endpoints, otherwise, AMS 16 does not consider the endpoints as paired.

Assuming AMS 16 successfully pairs endpoints 12 with each other, the AMS may instruct endpoint 12(1) to grant endpoint 12(2) to communicate with and establish a secure channel between endpoint 12(1) and endpoint 12(2) and over which the two devices may exchange information/content in a conference session, for example. To grant endpoint 12(2) access to a secure channel, AMS 16 may send an identifier of the secure channel to endpoint 12(1) and endpoint 12(2) directly (over network 20) using existing techniques for secure channel set up (e.g., TLS/SSL), or AMS 16 may send the identifier to endpoint 12(2) via endpoint 12(1). The identifier may identify a particular pilot sequence used to encode and decode the secure channel. Also, AMS 16 may download to endpoint 12(1) user profile information for the user associated with endpoint 12(2), such as a user phone number, an email address, and so on.

An alternative arrangement to that described above shifts the responsibility of computing time difference Δt and the separation distance from AMS 16 to endpoint 12(1), while the responsibility of performing the pairing decision remains with the AMS. In the alternative arrangement, at 1014, AMS 16 sends to endpoint 12(1) over network 20 a request to compute the separation distance, instead of the request for transmit times $t_{1,1}$ - $t_{1,N}$ described above. The request to compute the separation distance includes receive time t_R . In the alternative arrangement, at 1020, in response to receiving the request to compute the separation distance from AMS 16, endpoint 12(1) computes the separation distance as described above. At 1016, endpoint 12(1) sends the computed separation distance to AMS 16, instead of transmit times $t_{1,1}$ - $t_{1,N}$ described above. Then, at 1018, AMS 16 makes the pairing decision using the computed separation distance provided by endpoint 12(1), as described above.

With reference to FIG. 11, there is an example transaction diagram 1100 by which proximity verification/authentication using acoustic spread spectrum techniques for token exchange and ranging information is achieved in environment 10, according to a second embodiment. The second embodiment is similar to the first embodiment depicted in FIG. 10, except for differences described below.

At 1002 and 1004, AMS 16 generates tokens T_1 - T_{10} and sends the tokens to endpoint 12(1) as described above.

At 1106, in response to receiving tokens T_1 - T_{10} from AMS 16, endpoint 12(1) generates and transmits acoustic spread spectrum signals encoded with tokens T_1 - T_{10} similarly to the way the endpoint generates and transmits the acoustic spread spectrum signals in operation 1006, except that the endpoint also encodes an indication of the respective time $t_{i,j}$ at which each acoustic spread spectrum signal is to be transmitted into the spread spectrum signal along with the token T_i . That is, the spread data sequence encoded into each spread spectrum signal includes both the token T_i and the respective transmit time as indicated by the descriptors $\langle T_i; t_{i,j} \rangle$ in FIG. 11. For example, with reference again to FIG. 6, each token may be encoded as one of data eigenvectors 610i (e.g., 610a), while the time $t_{i,j}$ may replace one of the other eigenvectors (e.g., 610b).

To do this, endpoint 12(1) determines/estimates the future time at which each acoustic spread spectrum signal will be transmitted (i.e., transmit time $t_{i,j}$), encodes the future time into the acoustic spread spectrum signal, and then transmits the acoustic spread spectrum signal at the future time. The repeated transmissions of the spread spectrum signals encoded with both tokens and transmit times are shown

generally at **1108** in FIG. **11**. As a practical matter, encoding the future transmit times requires encoder **106** to know all of the time delays in transmitter TX **102**, through acoustic modulator **108** and loudspeaker **11**. Such time delays may be added to the pilot sequence and data frame boundary times mentioned above in connection with FIG. **4** to arrive at the transmit times. It is useful to note several factors, including (i) the time difference between successive token transmissions is generally much greater than an actual acoustic transmission time, (ii) only approximate millisecond (ms) accuracy is required, and (iii) as a result, the times $t_{i,j}$ may be units of time less than 1 ms (e.g., $\frac{1}{2}$ ms) and be encoded relative to the nearest second of Coordinated Universal Time (UTC), e.g., as $2^{11}=2048$, a simple encoding of $t_{i,j}$ may require 11 bits.

At **1110**, endpoint **12(2)** receives each of the acoustic spread spectrum signals transmitted by endpoint **12(1)** at **1108**. Endpoint **12(2)** processes each received acoustic spread spectrum signal according to method **900** to (i) determine a respective receive time t_R of each received acoustic spread spectrum signal, (ii) recover a respective one of tokens T_1-T_{10} from the received acoustic spread spectrum signal, and (iii) recover the corresponding transmit time $t_{i,j}$ also encoded in the received acoustic spread spectrum signal along with the tokens.

Armed with both receive time t_R and the recovered transmit times $t_{i,j}$ (e.g., transmit times $t_{1,1}-t_{1,N}$), endpoint **12(2)** determines/selects the one of transmit times $t_{i,j}$, that is closest in time to receive time t_R , and computes a time difference Δt between the determined/selected transmit time and receive time t_R . Then, endpoint **12(2)** computes a separation distance between endpoint **12(1)** and endpoint **12(2)** as the product Δt *the velocity of sound in air.

At **1112**, endpoint **12(2)** sends to AMS **16** over network **20** one or more messages including token T_1 and the computed separation distance.

At **1118**, in response to receiving token T_1 and the computed separation distance from endpoint **12(2)**, AMS **16** determines whether to pair endpoint **12(1)** with endpoint **12(2)**, i.e., performs pairing with respect to endpoints **12**, as described above.

With reference to FIG. **12**, there is an example transaction diagram **1200** by which proximity verification/authentication using acoustic spread spectrum techniques for token exchange and ranging information is achieved in environment **10**, according to a third embodiment. The third embodiment is similar to the second embodiment depicted in FIG. **11**, except for differences described below.

At **1002** and **1004**, AMS **16** generates tokens T_1-T_{10} and sends the tokens to endpoint **12(1)** as described above.

At **1206**, in response to receiving tokens T_1-T_{10} from AMS **16**, endpoint **12(1)** generates and transmits acoustic spread spectrum signals encoded with tokens T_1-T_{10} similarly to the way the endpoint generates and transmits the acoustic spread spectrum signals in operation **1106**, except that the endpoint also encodes an indication of how many more times $N_{i,j}$ the token T_i encoded in the current acoustic spread spectrum signal will be transmitted before progressing to the next token T_{i+1} . Thus, each acoustic spread spectrum signal includes a spread data sequence that conveys token T_i , transmit time $t_{i,j}$, and number of subsequent transmissions $N_{i,j}$, as indicated by the tuple $\langle T_i:t_{i,j}:N_{i,j} \rangle$ in FIG. **12**. The repeated transmissions of the spread spectrum signals, each encoded with the respective tuple $\langle T_i:t_{i,j}:N_{i,j} \rangle$, are indicated generally at **1208** in FIG. **12**.

An advantage of encoding the remaining number of transmissions of the current token is that it enables endpoint

12(2) to make an informed decision on how long to go to into a sleep mode before it has to wake up to decode the next token. For example, if endpoint **12(2)** ranging estimates or other endpoint functionality (e.g., accelerometer) indicate that endpoint **12(2)** is no longer moving relative to endpoint **12(1)**, endpoint **12(2)** may go to sleep based on $N_{i,j}$. This saves decoding computes, and thus saves battery life in endpoint **12(2)**.

At **1210**, endpoint **12(2)** receives each of the acoustic spread spectrum signals transmitted by endpoint **12(1)** at **1208**. Endpoint **12(2)** processes each received acoustic spread spectrum signal according to method **900** to (i) determine a respective receive time t_R of each received acoustic spread spectrum signal, (ii) recover a respective one of tokens T_1-T_{10} from the received acoustic spread spectrum signal, and (iii) recover the corresponding transmit time $t_{i,j}$ (and number of remaining transmissions) also encoded in the received acoustic spread spectrum signal along with the tokens.

Armed with both receive time t_R and the recovered transmit times $t_{i,j}$ (e.g., transmit times $t_{1,1}-t_{1,N}$), endpoint **12(2)** determines/selects the one of transmit times $t_{i,j}$, that is closest in time to receive time t_R , and computes a time difference Δt between the determined/selected transmit time and receive time t_R . Then, endpoint **12(2)** computes a separation distance between endpoint **12(1)** and endpoint **12(2)** as the product Δt *the velocity of sound in air.

At **1112**, endpoint **12(2)** sends to AMS **16** over network **20** one or more messages including token T_1 and the computed separation distance.

At **1118**, in response to receiving token T_1 and the computed separation distance from endpoint **12(2)**, AMS **16** determines whether to pair endpoint **12(1)** with endpoint **12(2)**, i.e., performs pairing with respect to endpoints **12**, as described above.

With reference to FIG. **13**, there is a flowchart of an example method **1300** of pairing endpoints using acoustic spread spectrum techniques for token exchange and ranging information. Method **1300** includes operations described above in connection with FIG. **10** (the first embodiment).

At **1302**, a first endpoint (e.g., endpoint **12(1)**) generates an acoustic spread spectrum signal including a pilot sequence and a spread data sequence representing a token synchronized to the pilot sequence. In an example, the spread data sequence representing/encoded with the token is based on the PONS code construction and the pilot sequence is based on the PONS code construction and is orthogonal to the data sequence.

At **1304**, the first endpoint transmits the acoustic spread spectrum signal and records a transmit time at which the acoustic spread spectrum signal is transmitted.

At **1306**, an indication of a receive time (t_R) at which a second endpoint (e.g., endpoint **12(2)**) received the acoustic spread spectrum signal transmitted by the first endpoint is received and a second token, as recovered from the received acoustic spread spectrum signal by the second endpoint, is also received. For example, AMS **16** receives the receive time and the second token recovered and transmitted by the second endpoint.

At **1308**, a separation distance between the first endpoint and the second endpoint is computed based on a time difference between the transmit time and the receive time. For example, AMS **16** computes the separation distance. In an alternative arrangement, after having received the receive time from the second endpoint, AMS **16** transmits the

receive time to the first endpoint, which computes the separation distance and then sends the computed separation distance to the AMS.

At **1310**, the first endpoint device is paired with the second endpoint device when the token matches the second token and the computed separation distance is less than a threshold distance, e.g., less than 20 feet. For example, AMS **16** performs the pairing.

With reference to FIG. **14**, there is a flowchart of an example method **1400** of pairing endpoints using acoustic spread spectrum techniques for token exchange and ranging information. Method **1400** includes operations described above in connection with FIGS. **11** and **12** (the second and third embodiments).

At **1402**, a first endpoint (e.g., endpoint **12(1)**) generates an acoustic spread spectrum signal including a pilot sequence and a spread data sequence. The first endpoint encodes both a token and a future transmit time at which the acoustic spread spectrum signal will be transmitted into the acoustic spread spectrum signal. The first endpoint transmits the acoustic spread spectrum signal at the future transmit time.

At **1404**, a second endpoint (e.g., endpoint **12(2)**) receives the acoustic spread spectrum signal transmitted by the first endpoint, determines from the received acoustic spread spectrum signal a receive time, a second token corresponding to the token, and the future transmit time, computes a separation distance between the first and second endpoints based on a difference between the receive time and the future transmit time, and sends to a network the second token and the computed separation distance.

At **1406**, AMS **16** receives from the second endpoint over the network the second token and the computed separation distance.

At **1408**, AMS **16** pairs the first endpoint with the second endpoint device when the second token matches the token and the computed separation distance is less than a threshold distance.

With reference to FIG. **15**, there is a block diagram of an example communication device **1500** in which TX **102**, RX **104**, or both may be implemented. Example communication device **1500** may represent either of endpoints **12(1)** or **12(2)**. There are numerous possible configurations for device **1500** and FIG. **15** is meant to be an example. Examples of device **1500** include a tablet computer, a personal computer, a laptop computer, a mobile phone, such as a smartphone, or a video conference endpoint or base station, and so on. Device **1500** may include a display **1502**, loudspeaker **110**, microphone **120**, one or more network interface units (NIUs) **1508**, and memory **1514** each coupled to a processor **1516**, and timebase **412**. The one or more NIUs **1508** may include wired and/or wireless connection capability that allows processor **1516** to communicate over a communication network. For example, NIUs **1508** may include an Ethernet card to communicate over an Ethernet connection, a wireless RF transceiver to communicate wirelessly with cellular networks in the communication network, optical transceivers, and the like, as would be appreciated by one of ordinary skill in the relevant arts. Timebase **412** may include one or more oscillators and/or clocks, and may also include a Global Positioning Systems (GPS) receiver to recover location and time, which may be used to time-synchronize multiple ones of devices **1500**. Also, timebase **412** may include applications to implement time synchronization via NTP, and so on.

Processor **1516** may include a collection of microcontrollers and/or microprocessors, for example, each config-

ured to execute respective software instructions stored in the memory **1514**. The collection of microcontrollers may include, for example: a video controller to receive, send, and process video signals or images related to display **1502**; an audio processor to receive, send/transmit, and process audio/sound signals related to loudspeaker **110** and microphone **120** as described herein; and a high-level controller to provide overall control. Portions of memory **1514** (and the instructions therein) may be integrated with processor **1516**. As used herein, the terms “audio” and “sound” are synonymous and interchangeable.

The memory **1514** may include read only memory (ROM), random access memory (RAM), magnetic disk storage media devices, optical storage media devices, flash memory devices, electrical, optical, or other physical/tangible (e.g., non-transitory) memory storage devices. Thus, in general, the memory **1514** may comprise one or more computer readable storage media (e.g., a memory device) encoded with software comprising computer executable instructions and when the software is executed (by the processor **1516**) it is operable to perform the operations described herein. For example, the memory **1514** stores or is encoded with instructions for control logic **1520** to perform operations described herein related to TX **102** and RX **104**, including endpoint operations associated with methods **800**, **900**, **1300**, **1400**, and transaction diagrams **1000-1200**.

In addition, memory **1514** stores data/information **1522** used and generated by logic **1520**.

With reference to FIG. **16**, a simplified block diagram of access management server **16** is shown, according to an embodiment. Server **16** includes a processor **1610** to process instructions relevant to proximity verification in environment **10**, memory **1620** to store a variety of data and software instructions, including access management server control logic/software **1625**. Server **106** also includes a network interface unit **1625** similar to network interface unit **1508** described above that enables network communications so that the server can communicate with other devices, e.g., endpoints **12**. Memory **1620** may comprise read only memory (ROM), random access memory (RAM), magnetic disk storage media devices, optical storage media devices, flash memory devices, electrical, optical, or other physical/tangible (e.g., non-transitory) memory storage devices. Processor **1610** is, for example, a microprocessor or microcontroller that executes instructions for implementing the processes described herein. Thus, in general, memory **1620** may comprise one or more tangible (non-transitory) computer readable storage media (e.g., a memory device) encoded with software (e.g., the meeting server control logic/software **1625**) comprising computer executable instructions and when the software is executed (by the processor **1610**) it is operable to perform the AMS operations described herein, including operations associated with methods **1300** and **1400**, and transaction diagrams **1000-1200**.

Memory **1620** also stores data **1650** generated and used by logic **1625**.

In summary, embodiments presented herein are directed to proximity pairing of endpoints using acoustic spread spectrum token exchange and ranging information. The embodiments add an acoustic ranging feature as an additional metric upon which a pairing/association decision can be based. By recording the time instant of the sending of an ultrasound token from an ultrasound speaker and recording the time instance(s) of the reception of the same ultrasound token at a microphone of a capture device (via detection of a cross-correlation peak) the “flight time” of the token can

be determined. This is the flight time of the dominant path from the ultrasound speaker to the microphone at the capture device (which may include reflections). This flight time is linearly related to the distance of the dominant path between the speaker and the microphone. Thus the apparent distance can be determined. In an example, an endpoint using NTP can resolve times to sub-millisecond accuracy. An endpoint using other means may attain even more time accuracy. By comparing the time at which the cross-correlation peak occurs at the receiver with the time of the beginning of the pilot sequence that was sent at the sender, and knowing the speed of sound, the acoustic time of flight and separation of the dominant path can be determined. Assuming sub-millisecond accuracy, e.g., the sending and receiving endpoints have a sub-millisecond synchronization to NTP, the dominant path separations may be determined to within approximately 11 inches, which is sufficient for making a pairing decision.

In summary, in one form, a method is provided comprising: at a first endpoint device, generating an acoustic spread spectrum signal including a pilot sequence and a spread data sequence representing a token synchronized to the pilot sequence; at the first endpoint device, transmitting the acoustic spread spectrum signal and recording a transmit time at which the acoustic spread spectrum signal is transmitted; receiving from a second endpoint device an indication of a receive time at which the second endpoint device received the acoustic spread spectrum signal transmitted by the first endpoint device and a second token as recovered from the received acoustic spread spectrum signal by the second endpoint device; computing a separation distance between the first endpoint device and the second endpoint device based on a time difference between the transmit time and the receive time; and pairing the first endpoint device with the second endpoint device when the token matches the second token and the computed distance is less than a threshold distance.

In another form, a system is provided comprising: a first endpoint including: an encoder and a modulator to generate an acoustic spread spectrum signal including a pilot sequence and a spread data sequence representing a token synchronized to the pilot sequence; and a loudspeaker to transmit the acoustic spread spectrum signal, wherein the first endpoint device is configured to record a transmit time at which the acoustic spread spectrum signal is transmitted; and a management entity including: a network interface to communicate with a network; and a processor coupled with the network interface and configured to: receive from a second endpoint device an indication of a receive time at which the second endpoint device received the acoustic spread spectrum signal transmitted by the first endpoint device and a second token as recovered from the received acoustic spread spectrum signal by the second endpoint device; compute a separation distance between the first endpoint device and the second endpoint device based on a difference between the transmit time and the receive time; and pair the first endpoint device with the second endpoint device when the token matches the second token and the computed separation distance is within a threshold distance.

In yet another form, a method is provided comprising: at a first endpoint device: generating an acoustic spread spectrum signal including a pilot sequence and a spread data sequence synchronized with the pilot sequence, wherein the spread data sequence encodes a token and a future transmit time at which the acoustic spread spectrum signal will be transmitted; and transmitting the acoustic spread spectrum signal at the future transmit time; at a second endpoint

device: receiving the acoustic spread spectrum signal; determining from the received acoustic spread spectrum signal a receive time, a second token corresponding to the token, and the future transmit time; computing a separation distance between the first endpoint device and the second endpoint device based on a difference between the receive time and the future transmit time; and sending to the network the second token and the computed separation distance; receiving from the second endpoint device over the network the second token and the computed separation distance; and pairing the first endpoint device with the second endpoint device when the second token matches the token and the computed separation distance is less than a threshold distance.

The methods described herein can also be embodied by software instructions stored in a non-transitory computer readable storage medium, that when executed by at least one processor, cause the processor to perform the operations of the respective methods described herein.

Further still, in another form, an device is provided that includes a processor, a transmitter and a receiver. The processor generates an acoustic spread spectrum signal including a pilot sequence and a spread data sequence representing a token synchronized to the pilot sequence. The transmitter transmits the acoustic spread spectrum signal and records a transmit time at which the acoustic spread spectrum signal is transmitted. The receiver receives from another device an indication of a receive time at which the other device received the acoustic spread spectrum signal transmitted by the device and a second token as recovered from the received acoustic spread spectrum signal by the other device. The processor computes a separation distance between the device and the other device based on a time difference between the transmit time and the receive time. The device may be paired with the other device when the token matches the second token and the computed distance is less than a threshold distance.

The above description is intended by way of example only. Various modifications and structural changes may be made therein without departing from the scope of the concepts described herein and within the scope and range of equivalents of the claims.

What is claimed is:

1. A method comprising:

[at a first endpoint device, generating an acoustic spread spectrum signal including a pilot sequence and a spread data sequence representing a token synchronized to the pilot sequence;]

at [the] a first endpoint device, transmitting [the] an acoustic spread spectrum signal and recording a transmit time at which the acoustic spread spectrum signal is transmitted, *wherein the acoustic spread spectrum signal is encoded with a token;*

receiving *over a network* from a second endpoint device an indication of a receive time at which the second endpoint device received the acoustic spread spectrum signal transmitted by the first endpoint device and a second token as recovered from the received acoustic spread spectrum signal by the second endpoint device; computing [a separation distance between the first endpoint device and the second endpoint device] *ranging information* based on [a time difference between] the transmit time and the receive time; and

responsive to the token matching the second token, and a comparison of the ranging information to a threshold value, pairing the first endpoint device with the second

23

endpoint device [when the token matches the second token and the computed distance is less than a threshold distance].

2. The method of claim 1, wherein the pairing includes permitting the second endpoint device access to an information carrying channel between the first endpoint device and the second endpoint device.

3. The method of claim [1] 24, further comprising, at the second endpoint device:

receiving the acoustic spread spectrum signal transmitted by the first endpoint device;

correlating the received acoustic spread spectrum signal with a replica of the pilot sequence to produce a correlation peak indicative of a presence of the pilot sequence;

decoding the data sequence based on timing of the correlation peak to recover the second token from the data sequence; and

determining the receive time based on the timing of the correlation peak.

4. The method of claim 1, further comprising:

repeatedly transmitting the acoustic spread spectrum signal and recording a respective transmit time at which each repeated acoustic spread spectrum signal is transmitted;

determining which of the recorded transmit times is nearest in time to the receive time;

wherein the computing includes computing the [separation distance] ranging information based on the receive time and the transmit time determined to be nearest in time to the receive time.

5. The method of claim [1] 24, wherein the data sequence representing the token is based on a Prometheus Orthonormal Set (PONS) code construction and the pilot sequence is based on the PONS code construction and is orthogonal to the data sequence.

6. The method of claim 5, wherein each of the data sequence and the pilot sequence includes a respective sequence of PONS coefficients that sum together to a value of zero.

7. The method of claim 5, wherein the data sequence includes a sequence of PONS coefficients having a length equal to a first odd power of 2 and the pilot sequence includes a sequence of PONS coefficients having a second length equal to a second odd power of 2.

8. The method of claim 1, further comprising:

initially sending a message carrying the token from a management entity, configured to communicate with the first endpoint device and the second endpoint device over a network, to the first endpoint device to cause the first endpoint device to perform [the generating.] the transmitting[,] and the recording.

9. The method of claim 8, further comprising, at the management entity:

sending to the first endpoint device a request for the transmit time;

receiving from the first endpoint device a message indicating the transmit time,

wherein the computing the [separation distance] ranging information and the pairing are each performed at the management entity.

10. The method of claim 8, wherein the receiving includes receiving at the management entity the indication of the receive time and the second token, and the method further comprises:

sending from the management entity to the first endpoint device the indication of the receive time;

24

performing the computing the [separation distance] ranging information at the first endpoint device; and sending the computed [separation distance] ranging information from the first endpoint device to the management entity,

wherein the pairing is performed at the management entity.

11. A system comprising:

a first endpoint device including: [an encoder and a modulator to generate an acoustic spread spectrum signal including a pilot sequence and a spread data sequence representing a token synchronized to the pilot sequence; and] a loudspeaker to transmit [the] a acoustic spread spectrum signal, wherein the first endpoint device is configured to record a transmit time at which the acoustic spread spectrum signal is transmitted, and the acoustic spread spectrum signal is encoded with a token; and

a management entity including:

a network interface to communicate with a network; and

a processor coupled with the network interface and configured to:

receive from a second endpoint device an indication of a receive time at which the second endpoint device received the acoustic spread spectrum signal transmitted by the first endpoint device and a second token as recovered from the received acoustic spread spectrum signal by the second endpoint device;

compute [a separation distance between the first endpoint device and the second endpoint device] ranging information based on [a difference between] the transmit time and the receive time; and

responsive to the token matching the second token, and a comparison of the ranging information to a threshold value, pair the first endpoint device with the second endpoint device [when the token matches the second token and the computed separation distance is within a threshold distance].

12. The system of claim 11, wherein the processor is configured to pair by permitting the second endpoint device access to an information carrying channel between the first endpoint device and the second endpoint device.

13. The system of claim [11] 25, wherein the second endpoint device is configured to:

receive the acoustic spread spectrum signal transmitted by the first endpoint device;

correlate the received acoustic spread spectrum signal with a replica of the pilot sequence to produce a correlation peak indicative of a presence of the pilot sequence;

decode the data sequence based on timing of the correlation peak to recover the second token from the data sequence; and

determine the receive time based on the timing of the correlation peak.

14. The system of claim [11] 25, wherein the data sequence representing the token is based on a Prometheus Orthonormal Set (PONS) code construction and the pilot sequence is based on the PONS code construction and is orthogonal to the data sequence.

15. The [method] system of claim 11, wherein the processor is further [configured] configured to:

25

initially send a message carrying the token to the first endpoint device over the network to cause the first endpoint device to perform the operations to [generate,] transmit[,] and record.

16. A method comprising:

at a first endpoint device: [generating an acoustic spread spectrum signal including a pilot sequence and a spread data sequence synchronized with the pilot sequence, wherein the spread data sequence encodes a token and a future transmit time at which the acoustic spread spectrum signal will be transmitted; and] transmitting [the] an acoustic spread spectrum signal at [the] a future transmit time, *wherein the acoustic spread spectrum signal is encoded with a token and a future time at which the acoustic spread spectrum signal will be transmitted;*

at a second endpoint device: receiving the acoustic spread spectrum signal; determining from the received acoustic spread spectrum signal a receive time, a second token corresponding to the token, and the future transmit time; computing [a separation distance between the first endpoint device and the second endpoint device] ranging information based on [a difference between] the receive time and the future transmit time; and sending to [the] a network the second token and the computed [separation distance] ranging information;

receiving from the second endpoint device over the network the second token and the computed [separation distance] ranging information; and responsive to the token matching the second token, and a comparison of the ranging information to a threshold value, pairing the first endpoint device with the second endpoint device [when the second token matches the token and the computed separation distance is less than a threshold distance].

17. The method of claim [16] 26, wherein the spread data sequence encoding the token is based on a Prometheus Orthonormal Set (PONS) code construction and the pilot sequence is based on the PONS code construction and is orthogonal to the data sequence.

18. The method of claim 16, further comprising:

[wherein the] generating [includes encoding] acoustic spread spectrum signals encoded with the token and respective incrementally increasing future times [into

26

respective acoustic spread spectrum signals into which the token is encoded], and transmitting the respective acoustic spread spectrum signals at the respective incrementally increasing future times.

5 19. The method of claim 18, wherein the generating includes generating a sequence of acoustic spread spectrum signals each including a respective token of a sequence of tokens.

10 20. The method of claim 16, wherein the [generating further includes encoding] acoustic spread spectrum signal is encoded with an indication of a number of remaining times will be transmitted before transitioning to a next token.

15 21. The method of claim 1, wherein the ranging information is a separation distance between the first endpoint device and the second endpoint device, the threshold value is a threshold distance, and the separation distance is less than the threshold distance.

20 22. The system of claim 11, wherein the ranging information is a separation distance between the first endpoint device and the second endpoint device, the threshold value is a threshold distance, and the separation distance is less than the threshold distance.

25 23. The method of claim 16, wherein the ranging information is a separation distance between the first endpoint device and the second endpoint device, the threshold value is a threshold distance, and the separation distance is less than the threshold distance.

30 24. The method of claim 1, wherein the acoustic spread spectrum signal includes a pilot sequence and a spread data sequence representing the token synchronized to the pilot sequence.

35 25. The system of claim 11, wherein the acoustic spread spectrum signal includes a pilot sequence and a spread data sequence representing the token synchronized to the pilot sequence.

40 26. The method of claim 16, wherein the acoustic spread spectrum signal includes a pilot sequence and a spread data sequence synchronized with the pilot sequence, and the spread data sequence encodes the token and the future transmit time.

* * * * *