



US00RE48579E

(19) **United States**
(12) **Reissued Patent**
Shusman

(10) **Patent Number:** **US RE48,579 E**
(45) **Date of Reissued Patent:** **Jun. 1, 2021**

(54) **METHOD AND APPARATUS FOR INTERNET-BASED INTERACTIVE PROGRAMMING**

FOREIGN PATENT DOCUMENTS

DE 4201696 7/1993
DE 4201696 A1 7/1993

(Continued)

(71) Applicant: **MEDIA IP, INC.**, Rydal, PA (US)
(72) Inventor: **Chad W. Shusman**, Rydal, PA (US)

OTHER PUBLICATIONS

(73) Assignee: **MEDIA IP, INC.**, Rydal, PA (US)

Van Tassel, "Digital TV over Broadband Harvesting Bandwidth," (2001).

(21) Appl. No.: **15/054,127**

(Continued)

(22) Filed: **Feb. 25, 2016**

Related U.S. Patent Documents

Reissue of:

(64) Patent No.: **8,661,490**
Issued: **Feb. 25, 2014**
Appl. No.: **13/597,185**
Filed: **Aug. 28, 2012**

Primary Examiner — Dennis G Bonshock

(74) *Attorney, Agent, or Firm* — Volpe Koenig

U.S. Applications:

(63) Continuation of application No. 11/335,200, filed on Jan. 18, 2006, now Pat. No. 8,255,966, which is a (Continued)

(57) **ABSTRACT**

A method and system for the creation of interactive programming incorporating viewer interactions. An interactive program includes moderator content generated by the moderator and edited participant commentary, such as interactive messages, and is served by a moderator server. Moderators create and manage interactive programs using a Web site. Viewers register to be participants in interactive programs using the Web site. The interactive programs can be distributed as electronic documents written in a markup language such as HTML or XML over a communications network such as the Internet. The interactive programs can also be converted to conventional interactive television content for distribution over an interactive television network. The interactive programs can also be distributed over a virtual private network for use as a collaboration tool by an enterprise such as a business concern. The interactive programs can be embedded within other Web processes such as electronic commerce and television commerce transactions.

(51) **Int. Cl.**
H04N 7/15 (2006.01)
H04N 7/14 (2006.01)

(52) **U.S. Cl.**
CPC *H04N 7/15* (2013.01); *H04N 7/14* (2013.01); *H04N 7/157* (2013.01)

(58) **Field of Classification Search**
CPC *H04N 7/14*; *H04N 7/15*; *H04N 7/157*
(Continued)

(56) **References Cited**

U.S. PATENT DOCUMENTS

3,493,674 A 2/1970 Houghton
3,947,624 A 3/1976 Miyake

(Continued)

64 Claims, 38 Drawing Sheets

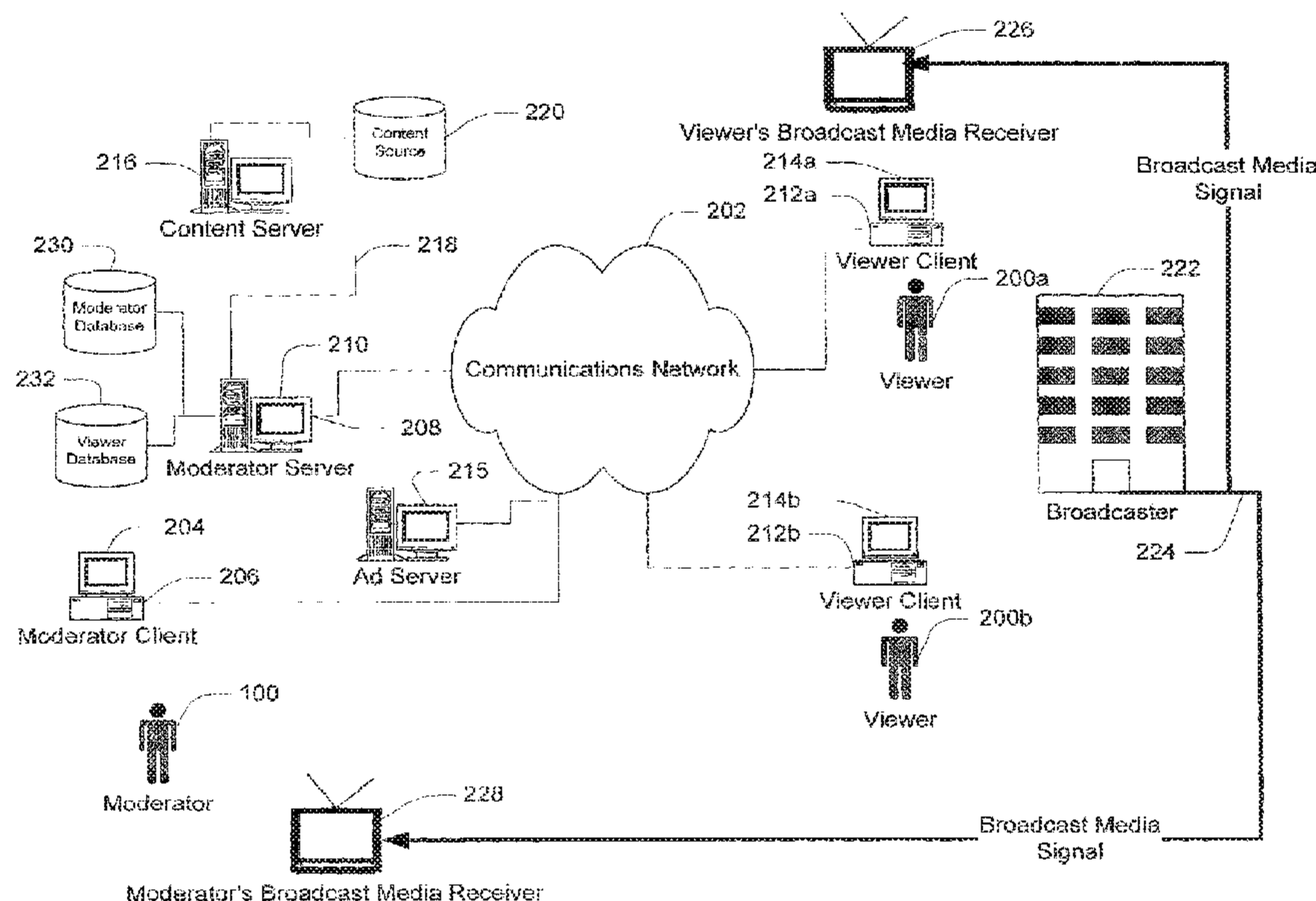

Related U.S. Application Data

continuation of application No. 10/123,618, filed on Apr. 15, 2002, now abandoned.

(58) **Field of Classification Search**

USPC 725/24, 32, 61, 91, 98, 100, 105, 109, 725/110, 114, 131, 733, 734; 348/14.01, 348/14.02, 14.03, 468

See application file for complete search history.

(56) **References Cited**

U.S. PATENT DOCUMENTS

3,947,972 A	4/1976	Freeman	5,251,324 A	10/1993	McMullan, Jr.
4,107,735 A	8/1978	Frohbach	5,260,778 A	11/1993	Kauffman et al.
4,205,343 A	5/1980	Barrett	5,260,788 A	11/1993	Takano et al.
4,305,131 A	12/1981	Best	5,319,455 A	6/1994	Hoarty et al.
4,308,554 A	12/1981	Percy et al.	5,340,317 A	8/1994	Freeman
4,337,483 A	6/1982	Guillou	5,375,160 A	12/1994	Guidon et al.
4,355,372 A	10/1982	Johnson et al.	5,381,477 A	1/1995	Beyers, II et al.
4,377,870 A	3/1983	Anderson et al.	5,382,970 A	1/1995	Kiefl
4,393,404 A	7/1983	Cox et al.	5,388,197 A	2/1995	Rayner
4,486,779 A	12/1984	Marti	5,390,027 A	2/1995	Henmi et al.
4,546,382 A	10/1985	McKenna et al.	5,410,359 A	4/1995	Odijk et al.
4,566,030 A	1/1986	Nickerson et al.	5,420,923 A	5/1995	Beyers, II et al.
4,567,511 A	1/1986	Smith et al.	5,438,355 A	8/1995	Palmer
4,569,026 A	2/1986	Best	5,446,490 A	8/1995	Blahut et al.
4,573,072 A	2/1986	Freeman	5,465,384 A	11/1995	Bejan et al.
4,578,700 A	3/1986	Roberts et al.	5,490,207 A	2/1996	Schorr
4,600,921 A	7/1986	Thomas	5,497,185 A	3/1996	Dufresne et al.
4,602,279 A	7/1986	Freeman	5,519,780 A	5/1996	Woo et al.
4,626,904 A	12/1986	Lurie	5,524,195 A	6/1996	Clanton, III et al.
4,630,108 A	12/1986	Gomersall	5,530,469 A	6/1996	Garfinkle
4,644,509 A	2/1987	Kiewit et al.	5,532,732 A	7/1996	Yuen et al.
4,646,145 A	2/1987	Percy et al.	5,537,141 A	7/1996	Harper et al.
4,658,290 A	4/1987	McKenna et al.	5,537,408 A	7/1996	Branstad et al.
4,684,980 A	8/1987	Rast et al.	5,539,471 A	7/1996	Myhrvold et al.
4,689,619 A	8/1987	O'Brien, Jr.	5,539,658 A	7/1996	McCullough
4,695,879 A	9/1987	Weinblatt	5,539,822 A	7/1996	Lett
4,750,036 A	6/1988	Martinez	5,543,818 A	8/1996	Scott
4,829,569 A	5/1989	Seth-Smith et al.	5,557,724 A	9/1996	Sampat et al.
4,847,698 A	7/1989	Freeman	5,563,648 A	10/1996	Menand et al.
4,847,699 A	7/1989	Freeman	5,583,563 A	12/1996	Wanderscheid et al.
4,847,700 A	7/1989	Freeman	5,585,858 A	12/1996	Harper et al.
4,866,770 A	9/1989	Seth-Smith et al.	5,585,865 A	12/1996	Amano et al.
4,876,592 A	10/1989	Von Kohorn	5,589,892 A	12/1996	Knee et al.
4,890,321 A	12/1989	Seth-Smith et al.	5,596,373 A	1/1997	White et al.
4,905,080 A	2/1990	Watanabe et al.	5,604,542 A	2/1997	Dedrick
4,918,516 A	4/1990	Freeman	5,623,613 A	4/1997	Rowe et al.
4,924,303 A	5/1990	Brandon et al.	5,632,007 A	5/1997	Freeman
4,926,255 A	5/1990	Von Kohorn	5,635,979 A	6/1997	Kostreski et al.
4,930,011 A	5/1990	Kiewit	5,638,113 A	6/1997	Lappington et al.
4,943,963 A	7/1990	Waechter et al.	5,654,763 A	8/1997	Bruckner et al.
4,953,022 A	8/1990	Bugg	5,682,196 A	10/1997	Freeman
4,989,233 A	1/1991	Schakowsky et al.	5,689,799 A	11/1997	Dougherty et al.
4,991,011 A	2/1991	Johnson et al.	5,694,163 A	12/1997	Harrison
5,008,750 A	4/1991	Gomikawa	5,703,795 A	12/1997	Mankovitz
5,014,125 A	5/1991	Pocock et al.	5,715,400 A	2/1998	Reimer
5,036,389 A	7/1991	Morales	5,721,583 A	2/1998	Harada et al.
5,038,211 A	8/1991	Hallenbeck	5,724,091 A	3/1998	Freeman et al.
5,038,212 A	8/1991	Van Den Hombergh et al.	5,761,606 A	6/1998	Wolzien
5,063,610 A	11/1991	Alwadish	5,768,539 A	6/1998	Metz et al.
5,073,931 A	12/1991	Audebert et al.	5,774,664 A	6/1998	Hidary et al.
5,081,680 A	1/1992	Bennett	5,778,181 A	7/1998	Hidary et al.
5,101,267 A	3/1992	Morales-Garza	5,781,228 A	7/1998	Sposato
5,103,038 A	4/1992	Chen et al.	5,802,284 A	9/1998	Karlton et al.
5,108,115 A	4/1992	Berman et al.	5,812,642 A	9/1998	Leroy
5,120,076 A	6/1992	Luxenberg et al.	5,812,931 A	9/1998	Yuen
5,155,762 A	10/1992	Croquet et al.	5,818,440 A	10/1998	Allibhoy et al.
5,157,491 A	10/1992	Kassatly	5,819,036 A	10/1998	Adams et al.
5,177,604 A	1/1993	Martinez	5,822,530 A	10/1998	Brown
5,189,630 A	2/1993	Barstow et al.	5,848,352 A	12/1998	Dougherty et al.
5,191,410 A	3/1993	McCalley et al.	5,859,670 A	1/1999	Van Gestel
5,200,823 A	4/1993	Yoneda et al.	5,860,023 A	1/1999	Tognazzini
5,214,792 A	5/1993	Alwadish	5,861,881 A	1/1999	Freeman et al.
RE34,340 E	8/1993	Freeman	5,896,382 A	4/1999	Davis et al.
			5,900,905 A	5/1999	Shoff et al.
			5,903,262 A	5/1999	Ichihashi et al.
			5,903,816 A	5/1999	Broadwin et al.
			5,905,537 A	5/1999	Van Gestel
			5,929,850 A	7/1999	Broadwin et al.
			5,931,908 A	8/1999	Gerba et al.
			5,936,661 A	8/1999	Trew
			5,956,491 A *	9/1999	Marks G06Q 10/10 709/250
			5,974,449 A	10/1999	Chang et al.
			5,977,962 A	11/1999	Chapman et al.
			5,982,445 A	11/1999	Eyer et al.
			5,987,504 A	11/1999	Toga
			5,993,314 A	11/1999	Dannenberg et al.
			5,995,134 A	11/1999	Hayashi
			5,996,006 A	11/1999	Speicher

(56)

References Cited

U.S. PATENT DOCUMENTS

5,996,022	A	11/1999	Krueger et al.	EP	0954179	A2	11/1999
6,005,561	A	12/1999	Hawkins et al.	EP	0982943	A2	3/2000
6,005,565	A	12/1999	Legall et al.	EP	0620669	B1	8/2000
6,005,601	A	12/1999	Ohkura et al.	EP	1087565	A2	3/2001
6,005,602	A	12/1999	Matthews, III	EP	1089201	A1	4/2001
6,006,256	A	12/1999	Zdepski et al.	EP	1091582	A2	4/2001
6,014,689	A	1/2000	Budge et al.	EP	1111926	A2	6/2001
6,018,768	A	1/2000	Ullman et al.	EP	1119192	A2	7/2001
6,049,823	A	4/2000	Hwang	EP	1124173	A2	8/2001
6,067,107	A	5/2000	Travaille et al.	EP	0858225	B1	7/2002
6,072,532	A	6/2000	Chieh et al.	EP	0873772	B1	3/2003
6,093,026	A	7/2000	Walker et al.	EP	0954179	B1	9/2004
6,097,441	A	8/2000	Allport	EP	0982943	B1	8/2005
6,134,531	A	10/2000	Trewitt et al.	EP	1119192	B1	5/2011
6,141,678	A	10/2000	Britt, Jr.	EP	1111926	B1	10/2015
6,151,626	A	11/2000	Tims et al.	GB	2348346		8/2000
6,167,432	A	12/2000	Jiang	GB	2348346	A1	9/2000
6,175,378	B1	1/2001	Maillard	WO	96/05699	A1	2/1996
6,195,530	B1	2/2001	Smith et al.	WO	96/19074	A1	6/1996
6,195,692	B1	2/2001	Hsu	WO	96/10974		6/1996
6,198,509	B1	3/2001	Dougherty et al.	WO	96/27982	A1	9/1996
6,204,885	B1	3/2001	Kwoh	WO	96/27982		9/1996
6,209,100	B1	3/2001	Robertson et al.	WO	97/01245	A1	1/1997
6,211,869	B1	4/2001	Loveman et al.	WO	97/02699	A1	1/1997
6,223,213	B1	4/2001	Cleron et al.	WO	97/01245		1/1997
6,275,989	B1	8/2001	Broadwin et al.	WO	97/02699		1/1997
6,477,579	B1	11/2002	Kunkel et al.	WO	97/18673	A1	5/1997
6,518,771	B2	2/2003	Frotscher et al.	WO	97/18673		5/1997
6,823,363	B1 *	11/2004	Noveck H04L 12/1813	WO	97/28502	A1	8/1997
			709/204	WO	97/29458		8/1997
7,007,235	B1 *	2/2006	Hussein G06Q 10/10	WO	97/29458		8/1997
			715/751	WO	97/31479		8/1997
7,031,952	B1 *	4/2006	Heumann G06N 5/022	WO	97/33434	A1	9/1997
7,165,213	B1 *	1/2007	Busey H04L 12/1813	WO	97/34419	A1	9/1997
			709/202	WO	97/33434		9/1997
7,650,621	B2 *	1/2010	Thomas G06F 3/0481	WO	97/34419		9/1997
			725/87	WO	97/47143	A2	12/1997
2001/0001160	A1	5/2001	Shoff et al.	WO	97/47143		12/1997
2001/0002852	A1	6/2001	Kwoh	WO	98/00974	A1	1/1998
2001/0003099	A1 *	6/2001	Von Kohorn H04N 7/0884	WO	98/00975	A1	1/1998
			463/40	WO	98/00975		1/1998
2001/0004743	A1	6/2001	Krueger et al.	WO	98/17064	A1	4/1998
2001/0047516	A1	11/2001	Swain et al.	WO	98/17064		4/1998
2002/0053077	A1	5/2002	Shah-Nazaroff et al.	WO	98/21664	A1	5/1998
2002/0087969	A1 *	7/2002	Brunheroto H04H 20/38	WO	98/22880	A1	5/1998
			725/13	WO	98/21664		5/1998
2002/0112002	A1 *	8/2002	Abato G06F 9/465	WO	98/22880		5/1998
			709/203	WO	98/26595	A1	6/1998
2002/0194054	A1 *	12/2002	Frengut G06Q 30/02	WO	98/26595		6/1998
			705/7.33	WO	98/41020	A1	9/1998
2003/0034999	A1 *	2/2003	Coughlin, III G09B 7/00	WO	98/41020		9/1998
			715/738	WO	98/48566	A2	10/1998
2003/0078972	A1	4/2003	Tapissier et al. ... H04L 12/1822	WO	98/48566		10/1998
			709/204	WO	99/04342	A1	1/1999
2003/0101450	A1	5/2003	Davidsson et al.	WO	99/04342		1/1999
2003/0145331	A1	7/2003	Escobar et al.	WO	99/08390	A2	2/1999
2003/0187932	A1 *	10/2003	Kennedy H04L 63/10	WO	99/08390		2/1999
			709/205	WO	99/14948	A1	3/1999
2003/0191805	A1 *	10/2003	Seymour H04L 67/42	WO	99/14948		3/1999
			709/204	WO	99/30497	A1	6/1999
2008/0008297	A1 *	1/2008	Gurfein H04M 3/493	WO	99/30497		6/1999
			379/88.01	WO	99/30500	A1	6/1999
				WO	99/30497		6/1999
				WO	99/30500		6/1999
				WO	99/49390	A1	9/1999
				WO	99/49658	A1	9/1999
				WO	99/49390		9/1999
				WO	99/49658		9/1999
				WO	99/52036	A1	10/1999
				WO	99/52036		10/1999
EP	0314572	A2	5/1989	WO	99/60789	A1	11/1999
EP	0402809	A2	12/1990	WO	99/60789		11/1999
EP	0402809	A3	12/1990	WO	99/62248	A1	12/1999
EP	0314572	B1	5/1994	WO	99/63757	A1	12/1999
EP	0620669	A1	10/1994	WO	99/66726	A1	12/1999
EP	0858225	A1	8/1998	WO	99/66727	A1	12/1999
EP	0873772	A1	10/1998	WO	99/66732	A1	12/1999
EP	0917333	A1	5/1999	WO			

FOREIGN PATENT DOCUMENTS

(56)

References Cited

FOREIGN PATENT DOCUMENTS			WO			
WO	WO 99/62248	12/1999	WO	01/01677	A1	1/2001
WO	WO 99/63757	12/1999	WO	01/01684	A1	1/2001
WO	WO 99/66726	12/1999	WO	01/01690	A1	1/2001
WO	WO 99/66727	12/1999	WO	01/05152	A1	1/2001
WO	WO 99/66732	12/1999	WO	01/06784	A2	1/2001
WO	00/04707	A1 1/2000	WO	01/01232		1/2001
WO	WO 00/04707	1/2000	WO	WO 01/01270	A1	1/2001
WO	00/05885	A1 2/2000	WO	WO 01/01677	A1	1/2001
WO	00/07336	A1 2/2000	WO	WO 01/01684	A1	1/2001
WO	00/08855	A1 2/2000	WO	WO 01/01690	A1	1/2001
WO	WO 00/05885	2/2000	WO	WO 01/05152	A1	1/2001
WO	WO 00/07336	2/2000	WO	WO 01/06784	A1	1/2001
WO	WO 00/08855	2/2000	WO	01/09714	A2	2/2001
WO	00/13415	A2 3/2000	WO	01/10115	A1	2/2001
WO	00/13416	A1 3/2000	WO	01/10118	A1	2/2001
WO	00/14965	A1 3/2000	WO	01/11887	A1	2/2001
WO	00/16209	A1 3/2000	WO	01/12279	A2	2/2001
WO	00/16544	A2 3/2000	WO	WO 01/09714	A2	2/2001
WO	00/18114	A1 3/2000	WO	WO 01/10115	A1	2/2001
WO	WO 00/13415	3/2000	WO	WO 01/10118	A1	2/2001
WO	WO 00/13416	3/2000	WO	WO 01/11887	A1	2/2001
WO	WO 00/14965	3/2000	WO	WO 01/12279	A2	2/2001
WO	WO 00/16209	3/2000	WO	01/15437	A1	3/2001
WO	WO 00/16544	3/2000	WO	01/16856	A1	3/2001
WO	WO 00/18114	3/2000	WO	01/18678	A2	3/2001
WO	00/21297	A1 4/2000	WO	01/19084	A1	3/2001
WO	00/24198	A1 4/2000	WO	01/20468	A1	3/2001
WO	WO 00/21297	4/2000	WO	01/20499	A1	3/2001
WO	WO 00/24198	4/2000	WO	WO 01/15437	A1	3/2001
WO	00/27115	A1 5/2000	WO	WO 01/16856	A1	3/2001
WO	00/28432	A2 5/2000	WO	WO 01/18678	A2	3/2001
WO	00/28739	A1 5/2000	WO	WO 01/19084	A1	3/2001
WO	WO 00/27115	5/2000	WO	WO 01/20468	A1	3/2001
WO	WO 00/28432	5/2000	WO	WO 01/20499	A1	3/2001
WO	WO 00/28739	5/2000	WO	01/24027	A1	4/2001
WO	00/31973	A1 6/2000	WO	01/24036	A2	4/2001
WO	00/33561	A2 6/2000	WO	01/25940	A1	4/2001
WO	00/33565	A2 6/2000	WO	01/26369	A1	4/2001
WO	00/33578	A1 6/2000	WO	WO 01/24027	A1	4/2001
WO	WO 00/31973	6/2000	WO	WO 01/24036	A1	4/2001
WO	WO 00/33561	6/2000	WO	WO 01/25940	A1	4/2001
WO	WO 00/33565	6/2000	WO	WO 01/26369	A1	4/2001
WO	00/44173	A1 7/2000	WO	01/33833	A1	5/2001
WO	WO 00/44173	7/2000	WO	01/33847	A1	5/2001
WO	00/51310	A1 8/2000	WO	01/33858	A1	5/2001
WO	WO 00/51310	8/2000	WO	01/37557	A1	5/2001
WO	00/54506	A1 9/2000	WO	01/39494	A1	5/2001
WO	00/56066	A1 9/2000	WO	01/39501	A1	5/2001
WO	00/56067	A1 9/2000	WO	WO 01/33833	A1	5/2001
WO	WO 00/54506	9/2000	WO	WO 01/33847	A1	5/2001
WO	WO 00/56067	9/2000	WO	WO 01/33858	A1	5/2001
WO	00/60865	A1 10/2000	WO	WO 01/37557	A1	5/2001
WO	00/63817	A2 10/2000	WO	WO 01/39494	A1	5/2001
WO	00/64150	A1 10/2000	WO	WO 01/39501	A1	5/2001
WO	00/64172	A1 10/2000	WO	01/43357	A2	6/2001
WO	WO 00/60865	10/2000	WO	01/44914	A1	6/2001
WO	WO 00/63817	10/2000	WO	01/45313	A2	6/2001
WO	WO 00/64150	10/2000	WO	01/45406	A1	6/2001
WO	WO 00/64172	10/2000	WO	01/45413	A1	6/2001
WO	00/70783	A1 11/2000	WO	01/46843	A2	6/2001
WO	00/72141	A2 11/2000	WO	01/47262	A2	6/2001
WO	WO 00/70783	11/2000	WO	WO 01/43357	A2	6/2001
WO	WO 00/72141	A2 11/2000	WO	WO 01/44914	A1	6/2001
WO	00/74338	A2 12/2000	WO	WO 01/45313	A2	6/2001
WO	00/76215	A1 12/2000	WO	WO 01/45406	A1	6/2001
WO	00/78033	A2 12/2000	WO	WO 01/45413	A1	6/2001
WO	00/78043	A1 12/2000	WO	WO 01/46843	A2	6/2001
WO	00/78050	A1 12/2000	WO	01/47262	A2	6/2001
WO	WO 00/74338	A2 12/2000	WO	01/49032	A1	7/2001
WO	WO 00/76215	A1 12/2000	WO	01/50309	A2	7/2001
WO	WO 00/78033	A2 12/2000	WO	01/50742	A1	7/2001
WO	WO 00/78043	A1 12/2000	WO	01/50753	A1	7/2001
WO	WO 00/78050	A1 12/2000	WO	01/50758	A2	7/2001
WO	01/01232	A1 1/2001	WO	01/54407	A1	7/2001
WO	01/01270	A1 1/2001	WO	WO 01/49032	A1	7/2001
			WO	WO 01/50309	A2	7/2001
			WO	WO 01/50742	A1	7/2001
			WO	WO 01/50753	A1	7/2001
			WO	WO 01/50758	A2	7/2001

(56)

References Cited

FOREIGN PATENT DOCUMENTS

WO	WO 01/54407	A1	7/2001
WO	01/56292	A1	8/2001
WO	01/56293	A1	8/2001
WO	01/58150	A2	8/2001
WO	01/59964	A2	8/2001
WO	01/60071	A2	8/2001
WO	01/60072	A2	8/2001
WO	01/63929	A1	8/2001
WO	WO 01/56292	A1	8/2001
WO	WO 01/56293	A1	8/2001
WO	WO 01/58150	A2	8/2001
WO	WO 01/59964	A2	8/2001
WO	WO 01/60071	A2	8/2001
WO	WO 01/60072	A2	8/2001
WO	01/69369	A1	9/2001
WO	01/69940	A1	9/2001
WO	01/73525	A2	10/2001
WO	WO 01/73525	A2	10/2001

OTHER PUBLICATIONS

Hurwicz et al., Special Edition Using Macromedia Flash Mix, Que Corporation (2003).

Towes, Macromedia Flash Communication Server MX, Pangaea NewMedia, Inc. (2003).

Van Tassel, Joan M., Digital TV over Broadband Harvesting Bandwidth; Copyright 2001.

* cited by examiner

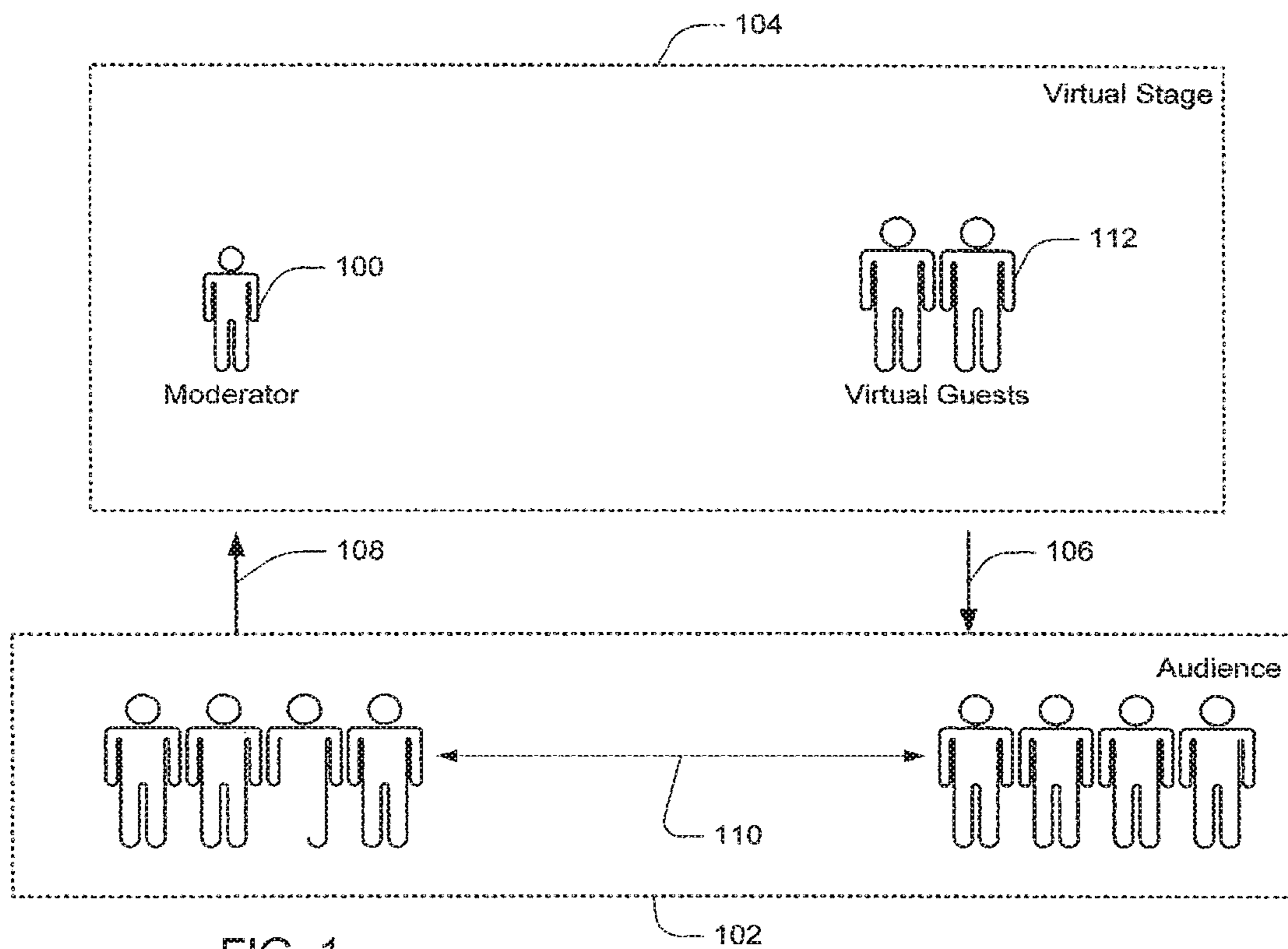
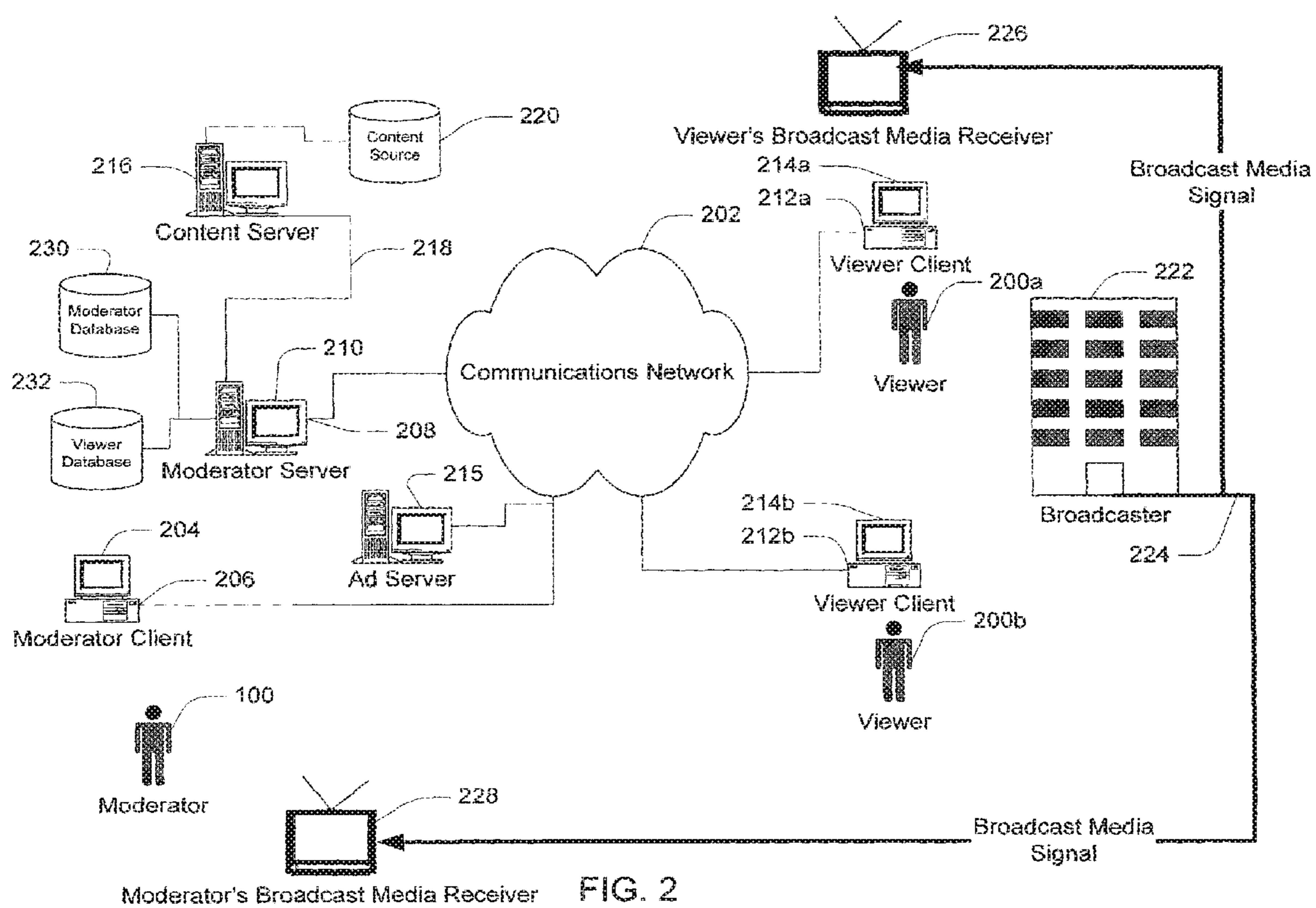

FIG. 1



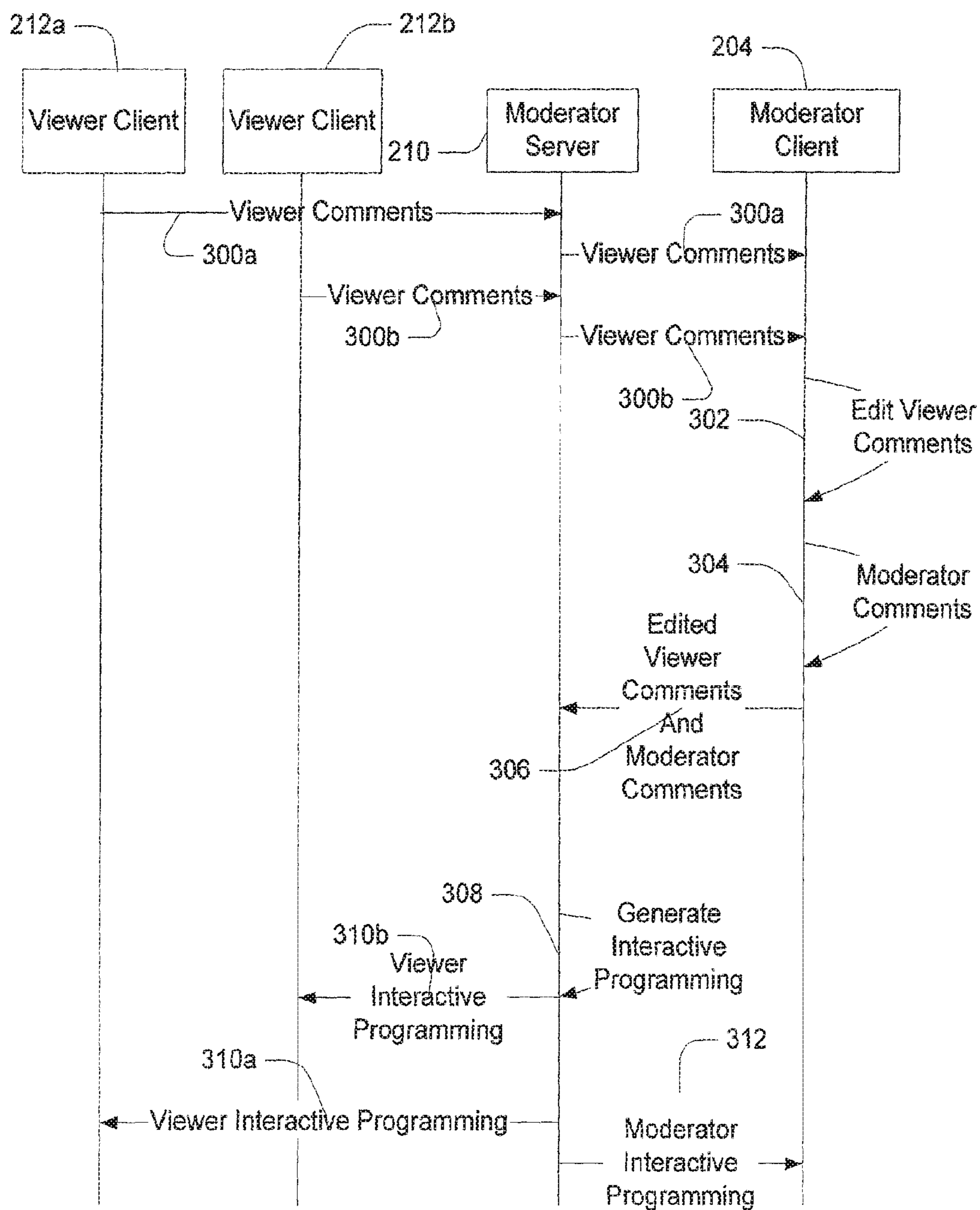

FIG. 3

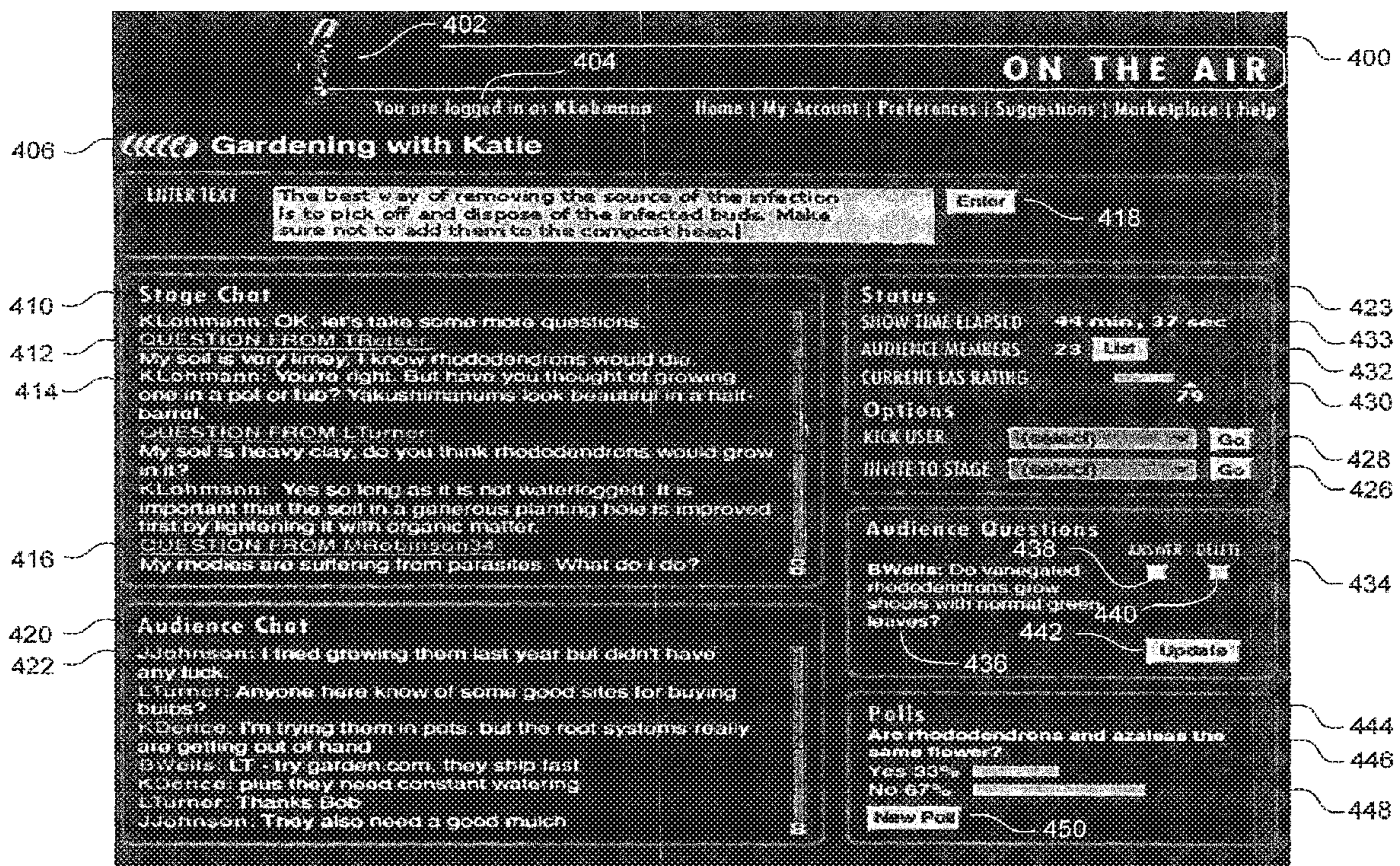

FIG. 4

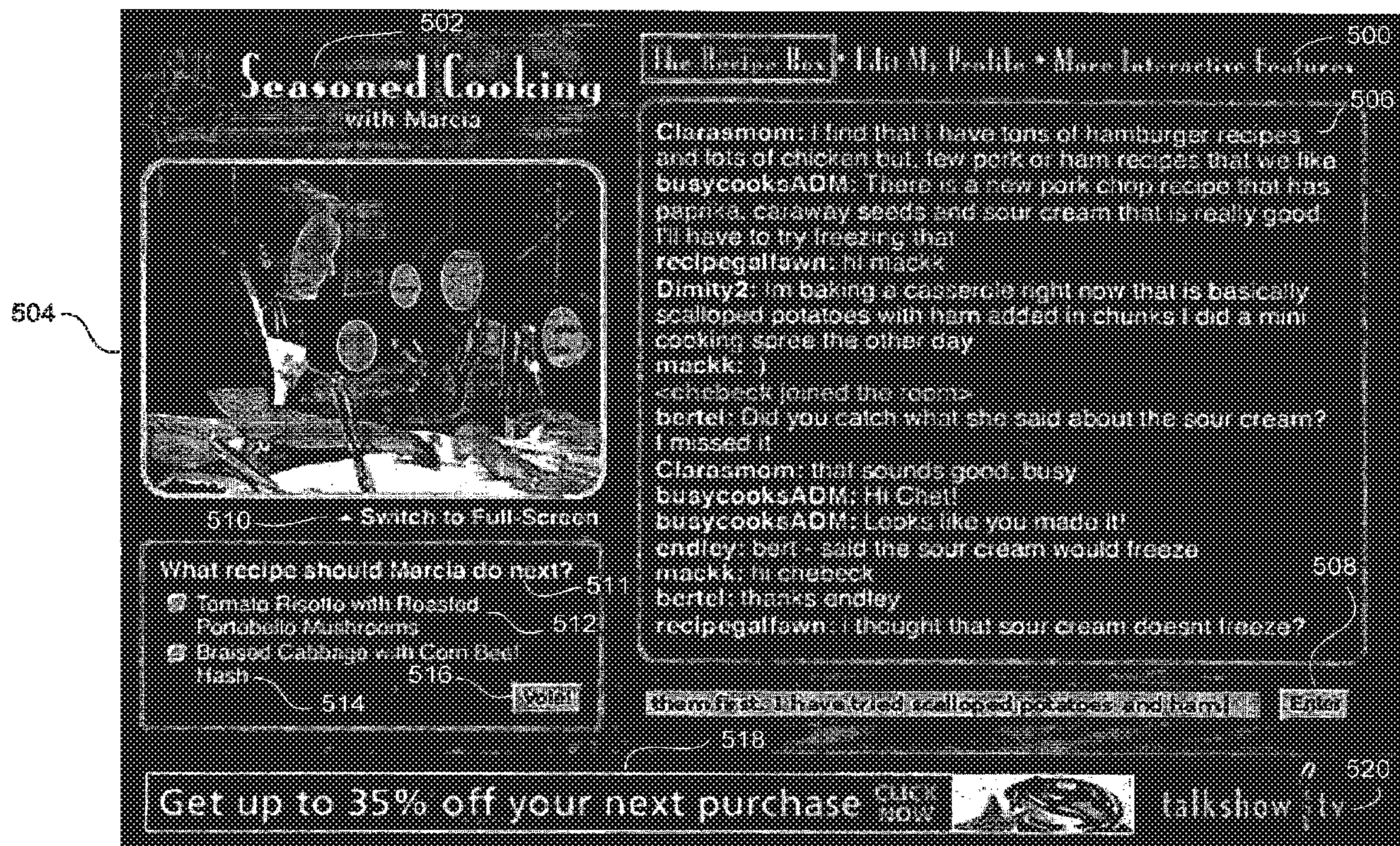

FIG. 5

ELICITED APPROVAL SYSTEM (EAS)

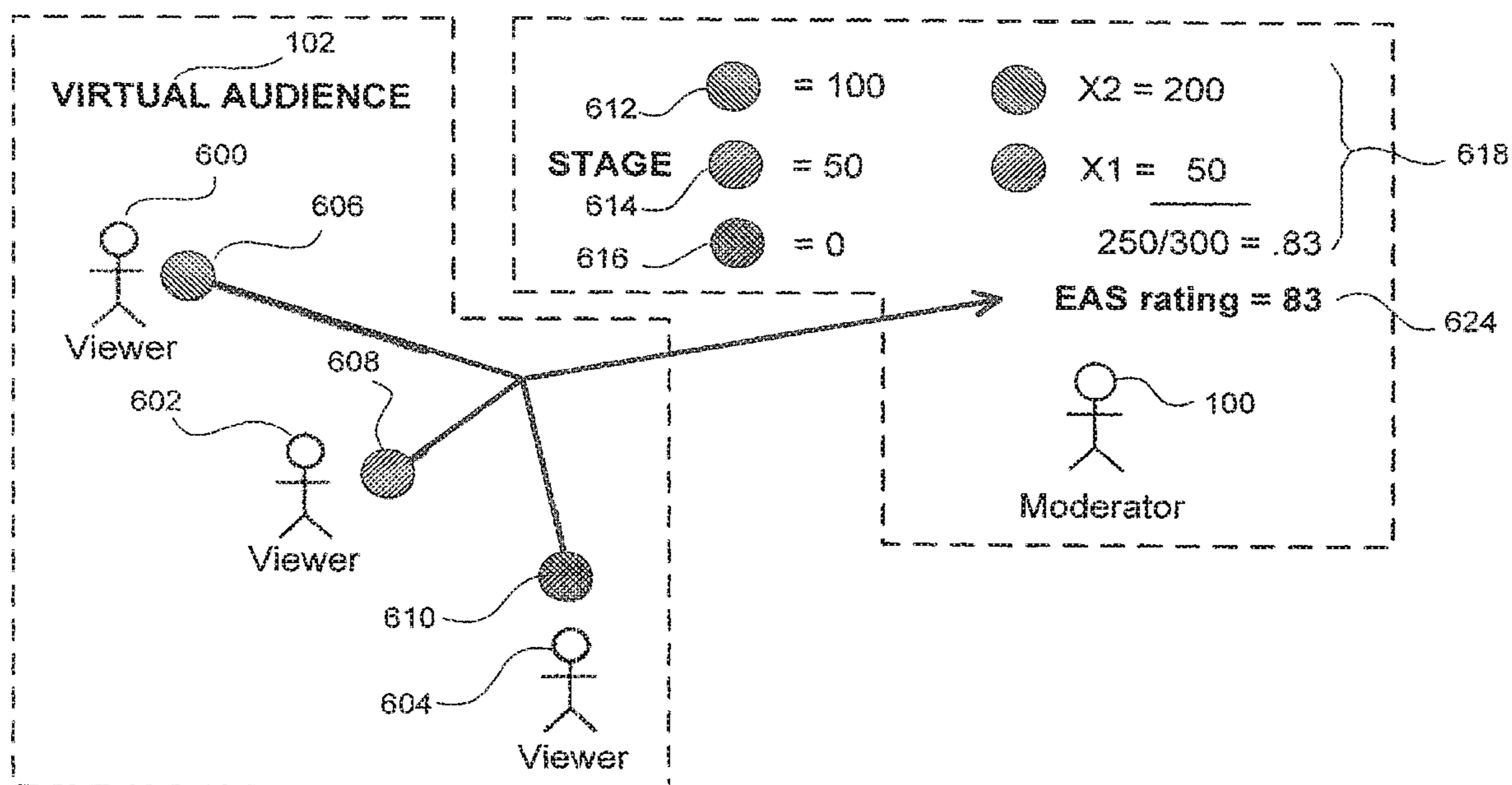

FIG. 6

MODERATOR PARTICIPATION

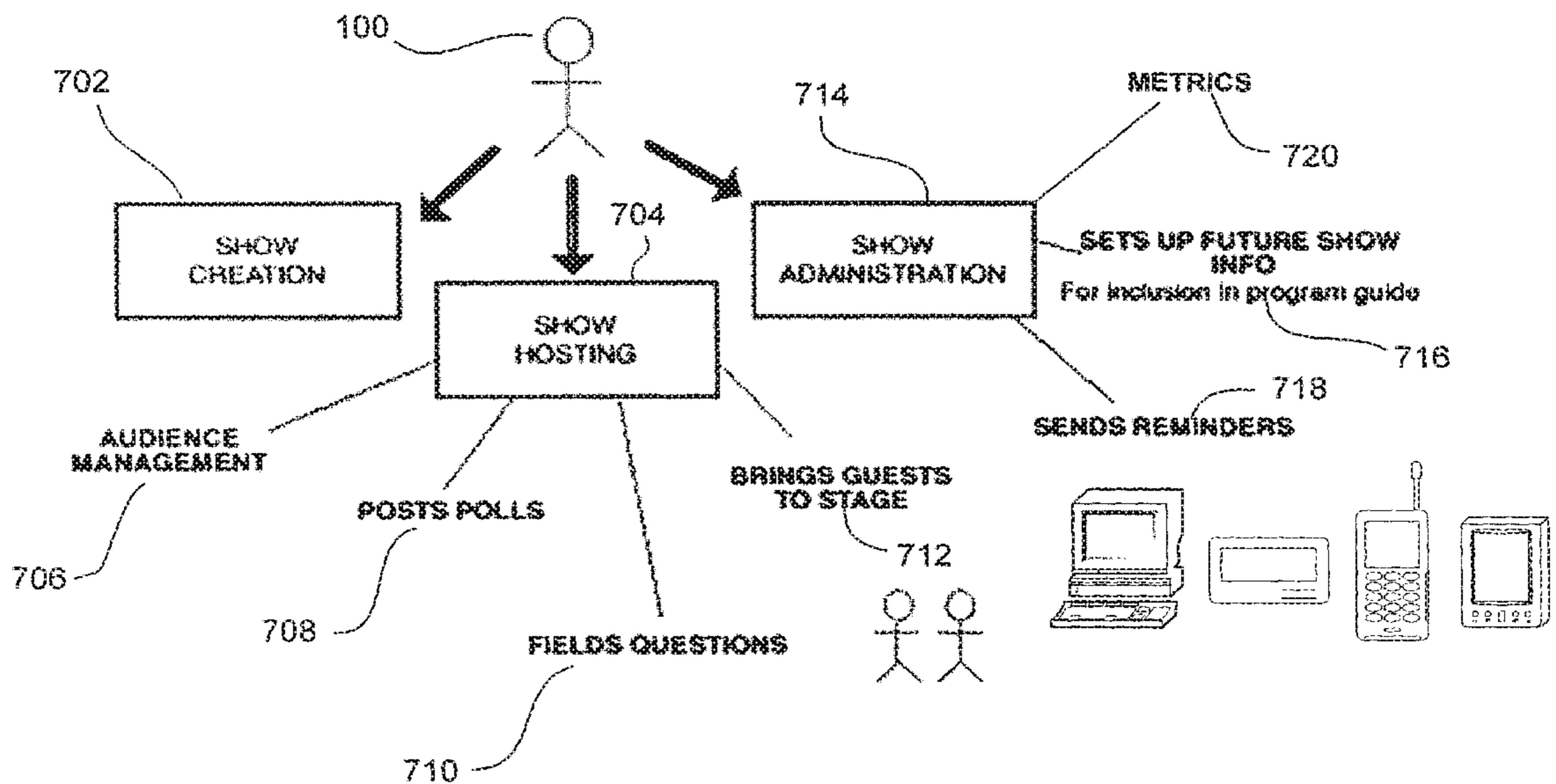

FIG. 7

AUDIENCE MEMBER PARTICIPATION

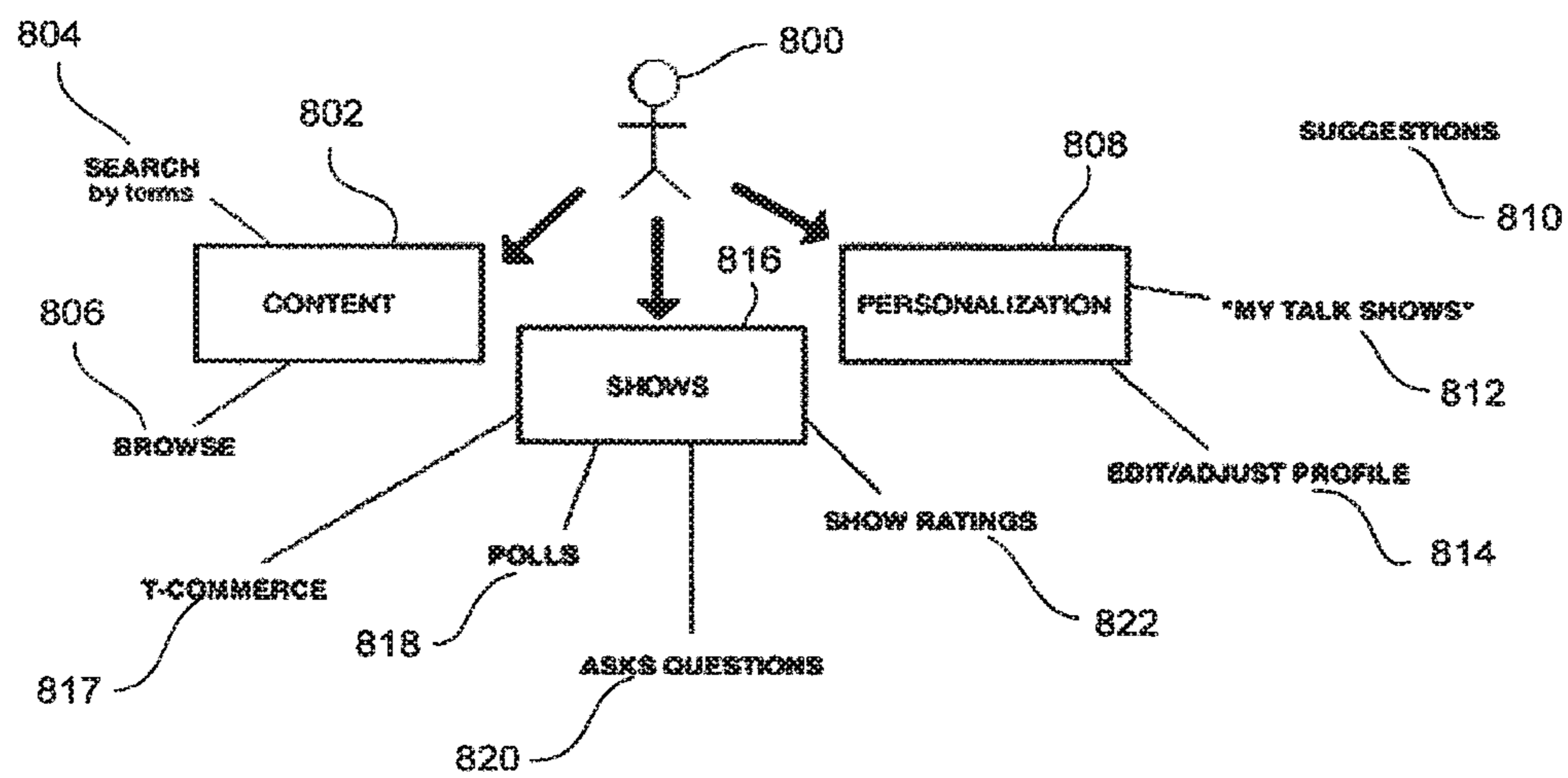

FIG. 8

SITE MAP

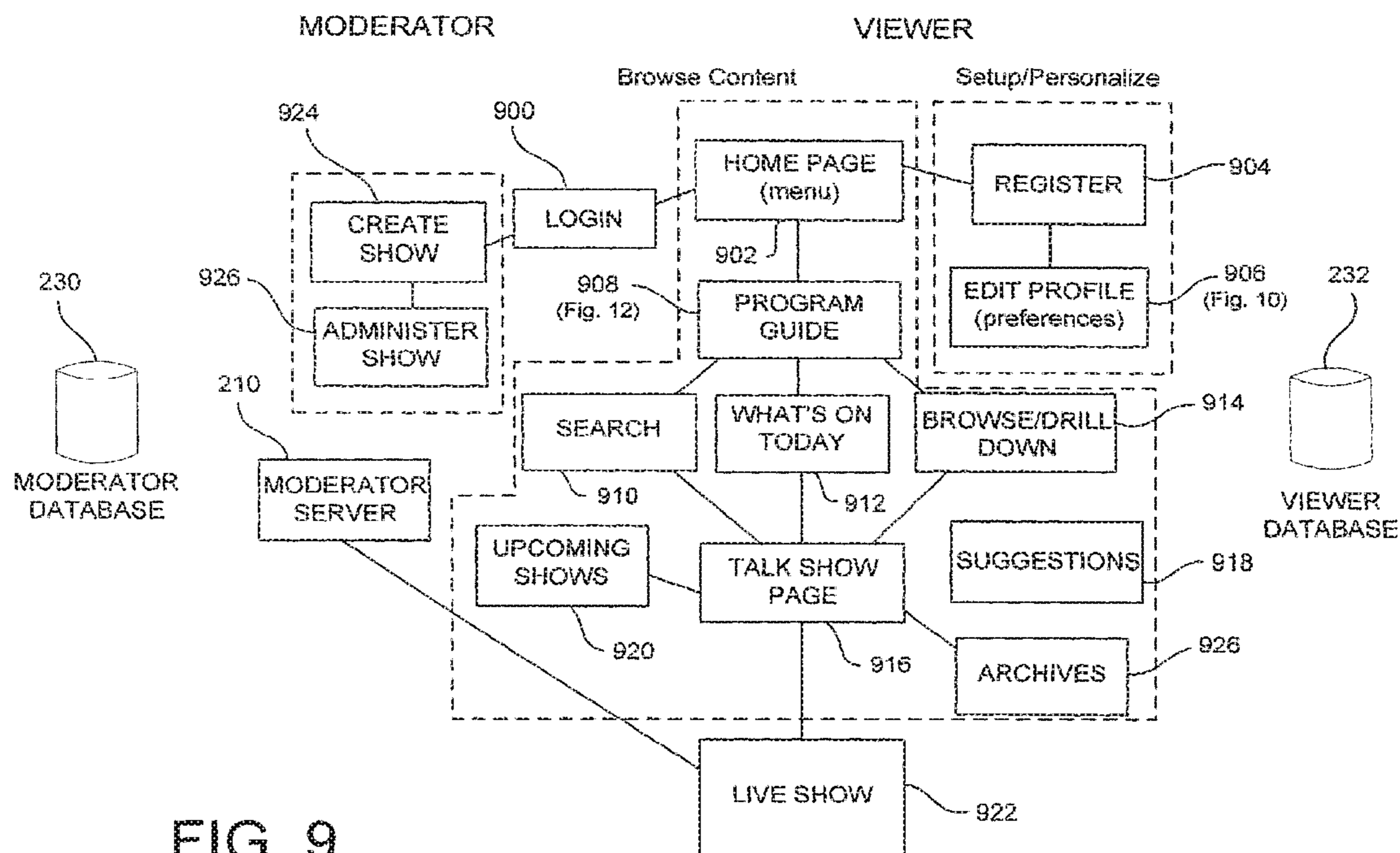

FIG. 9

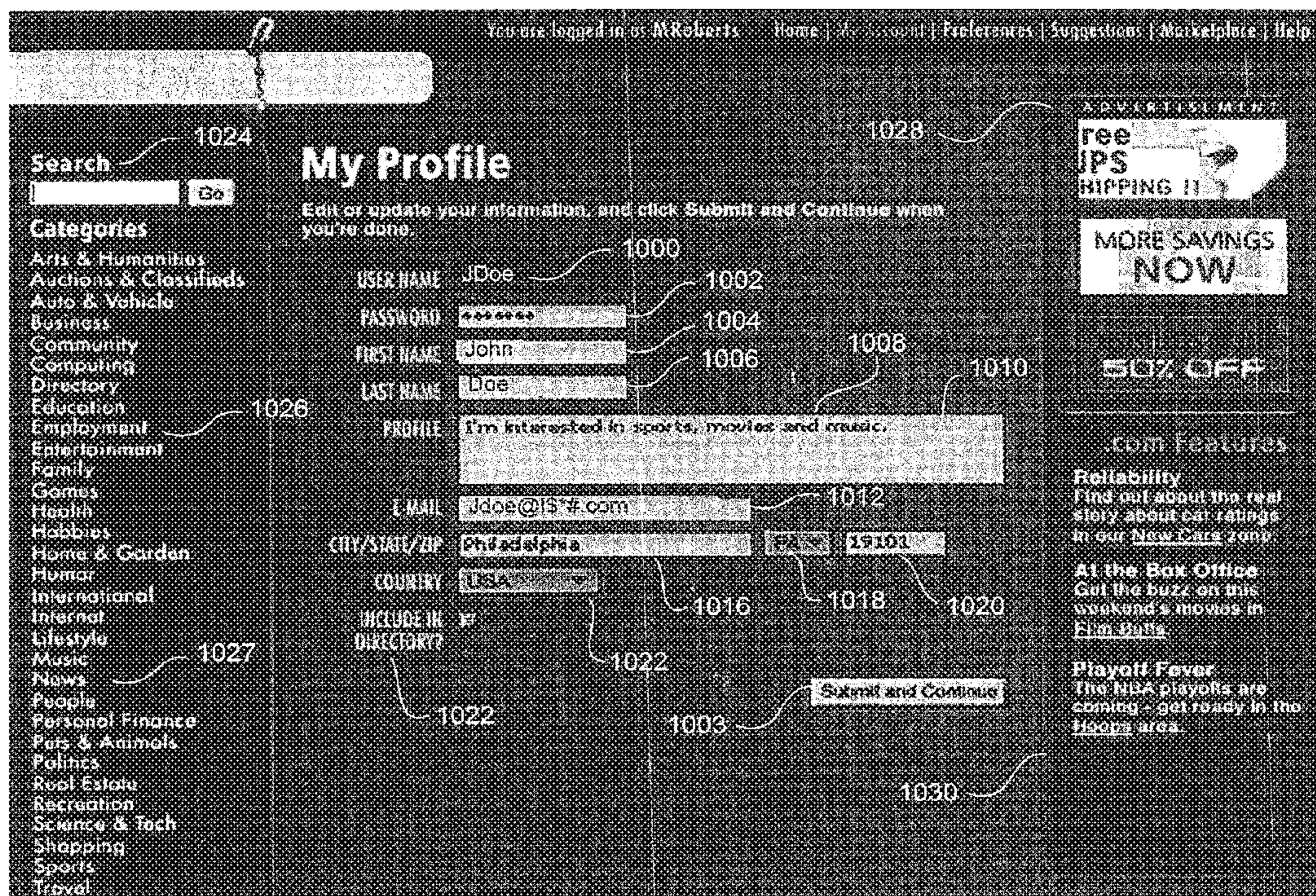

FIG. 10



FIG. 11

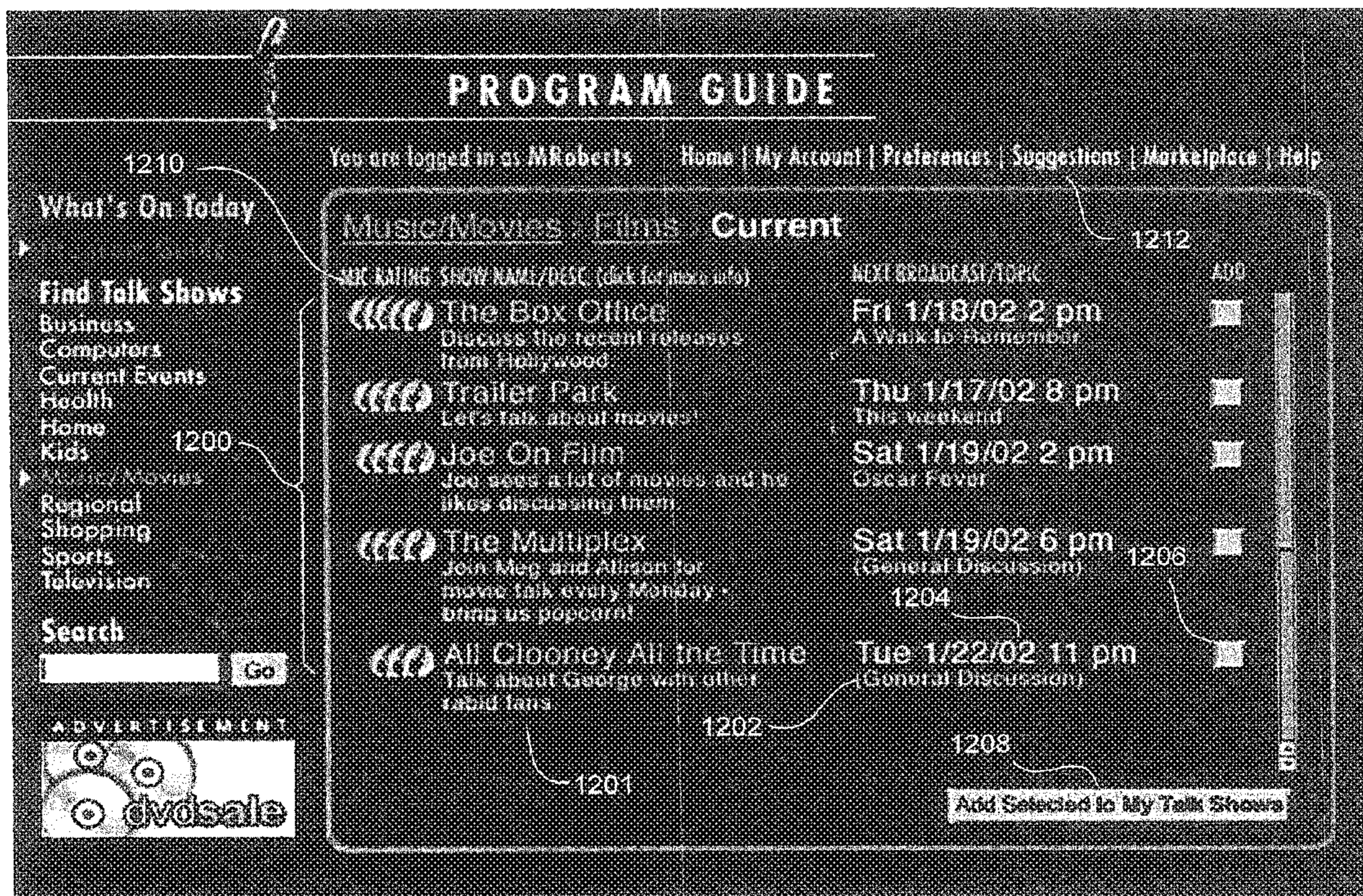

FIG. 12

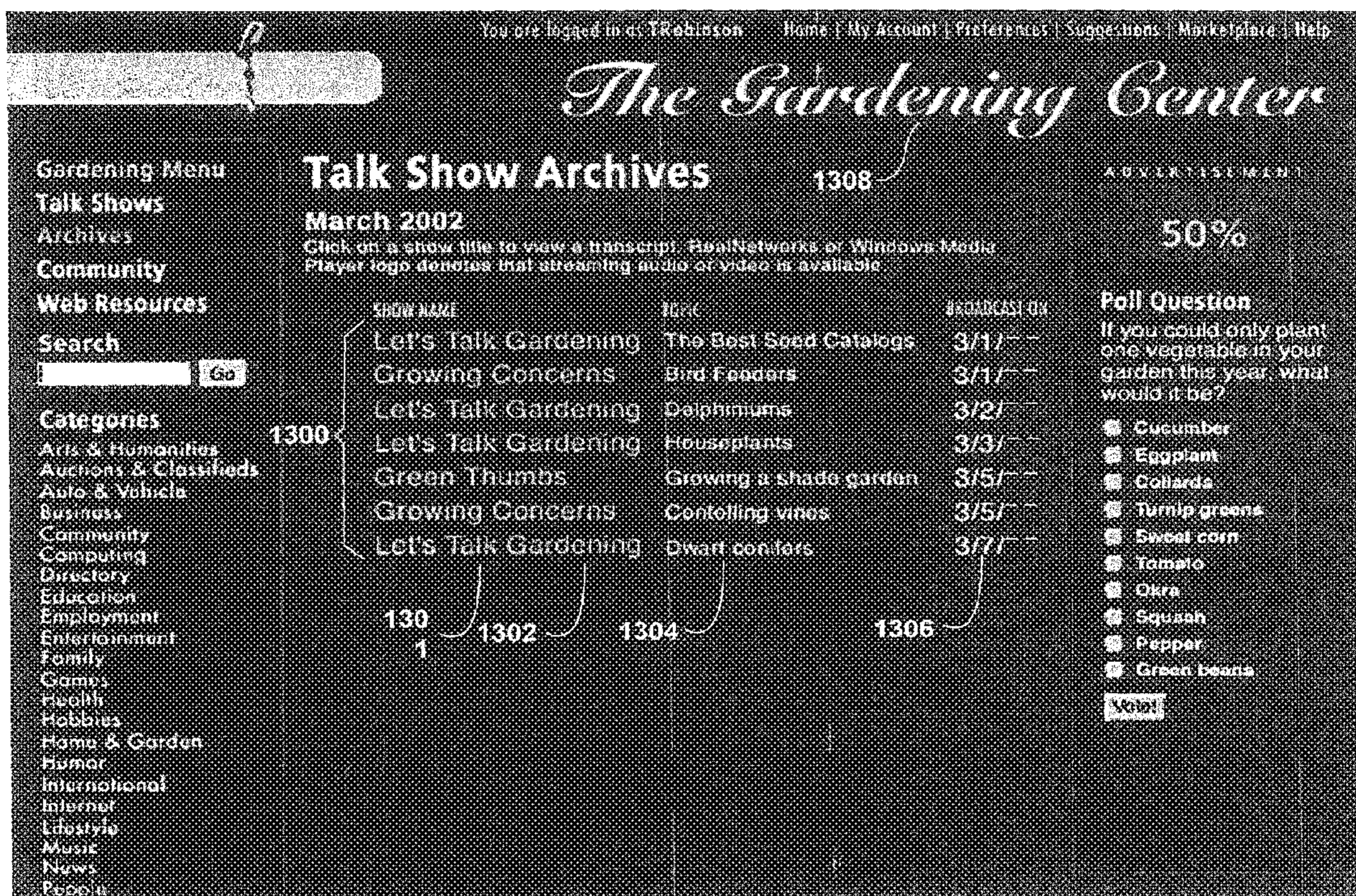

FIG. 13

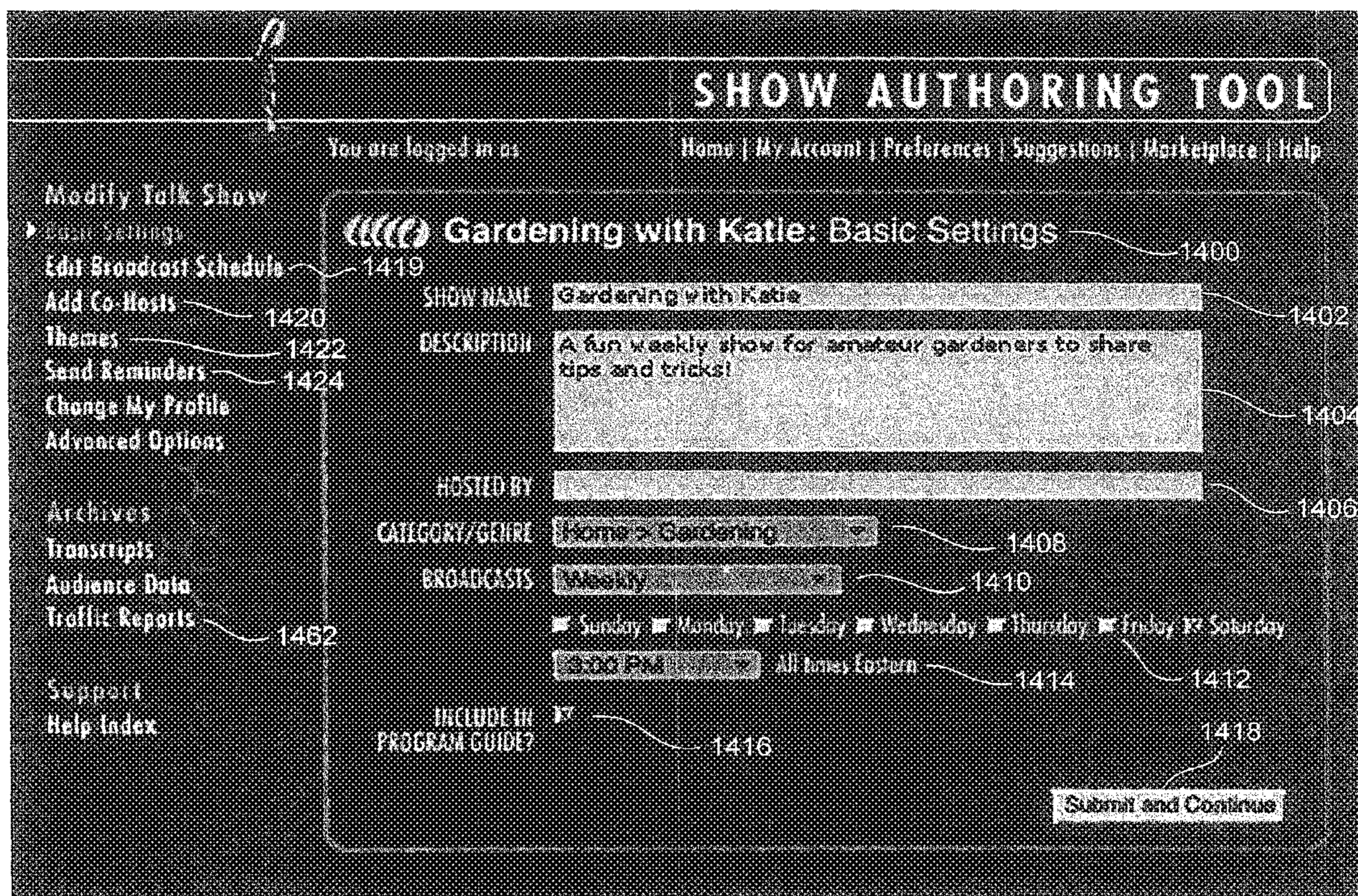

FIG. 14

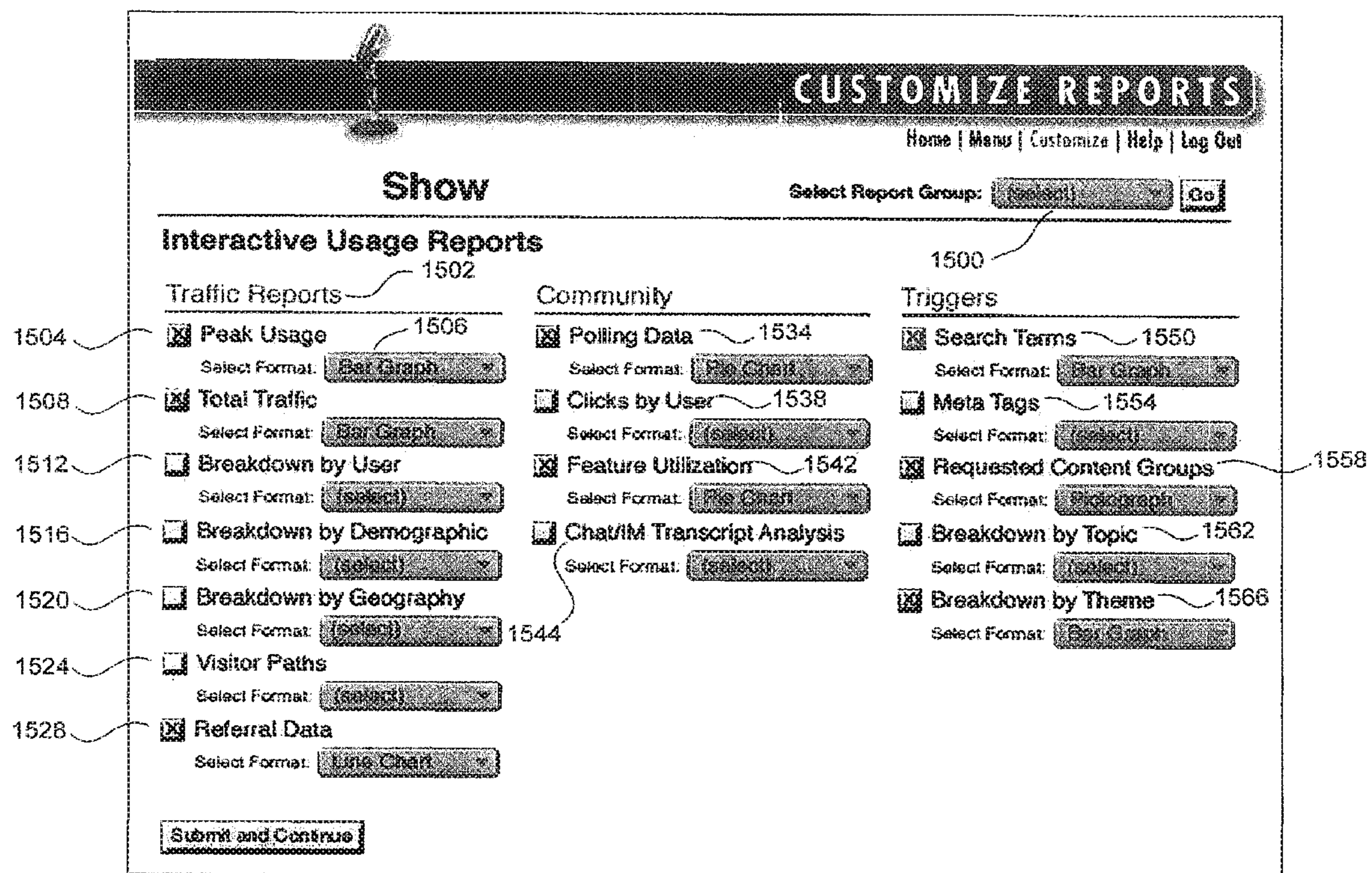
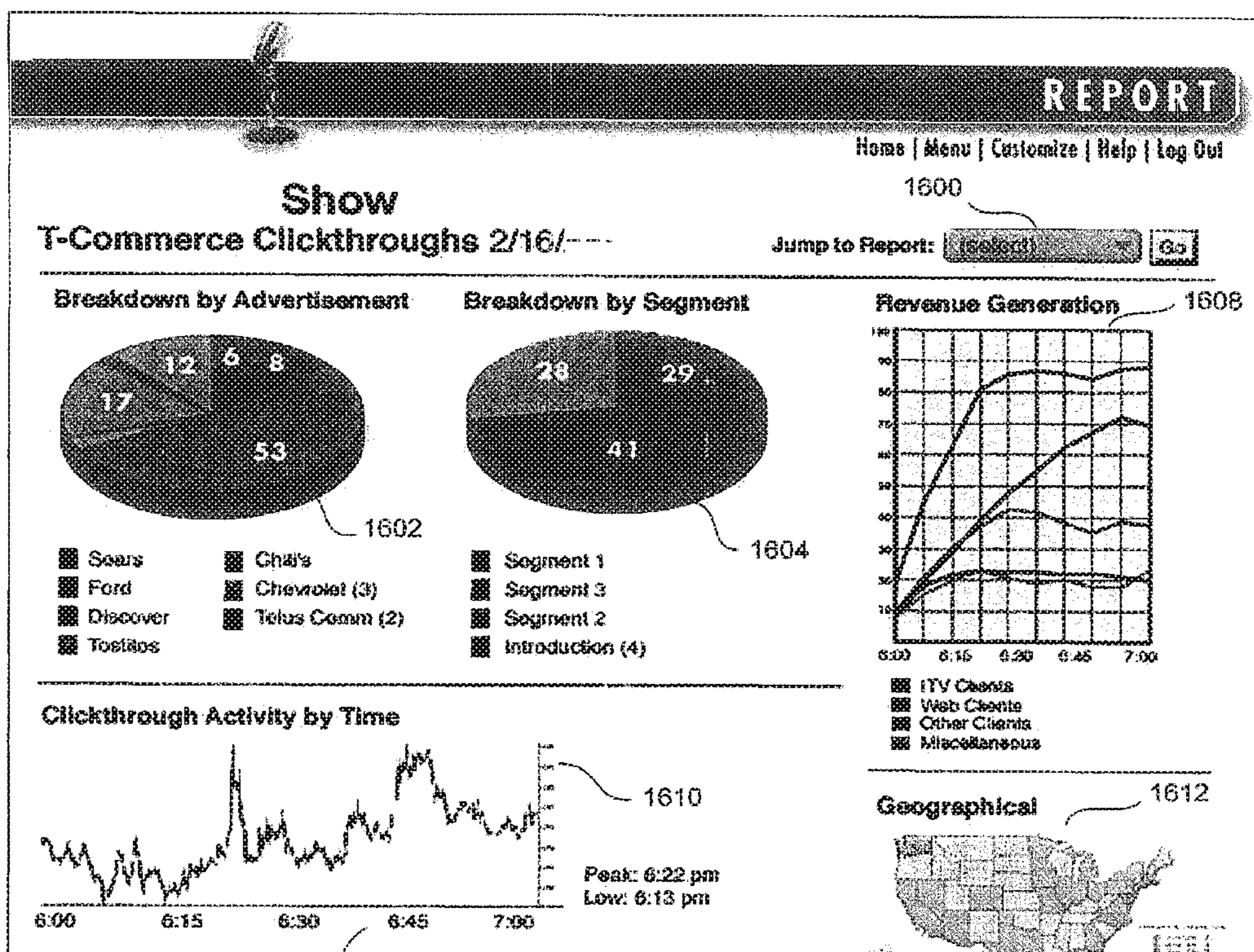

FIG. 15



1611

FIG. 16

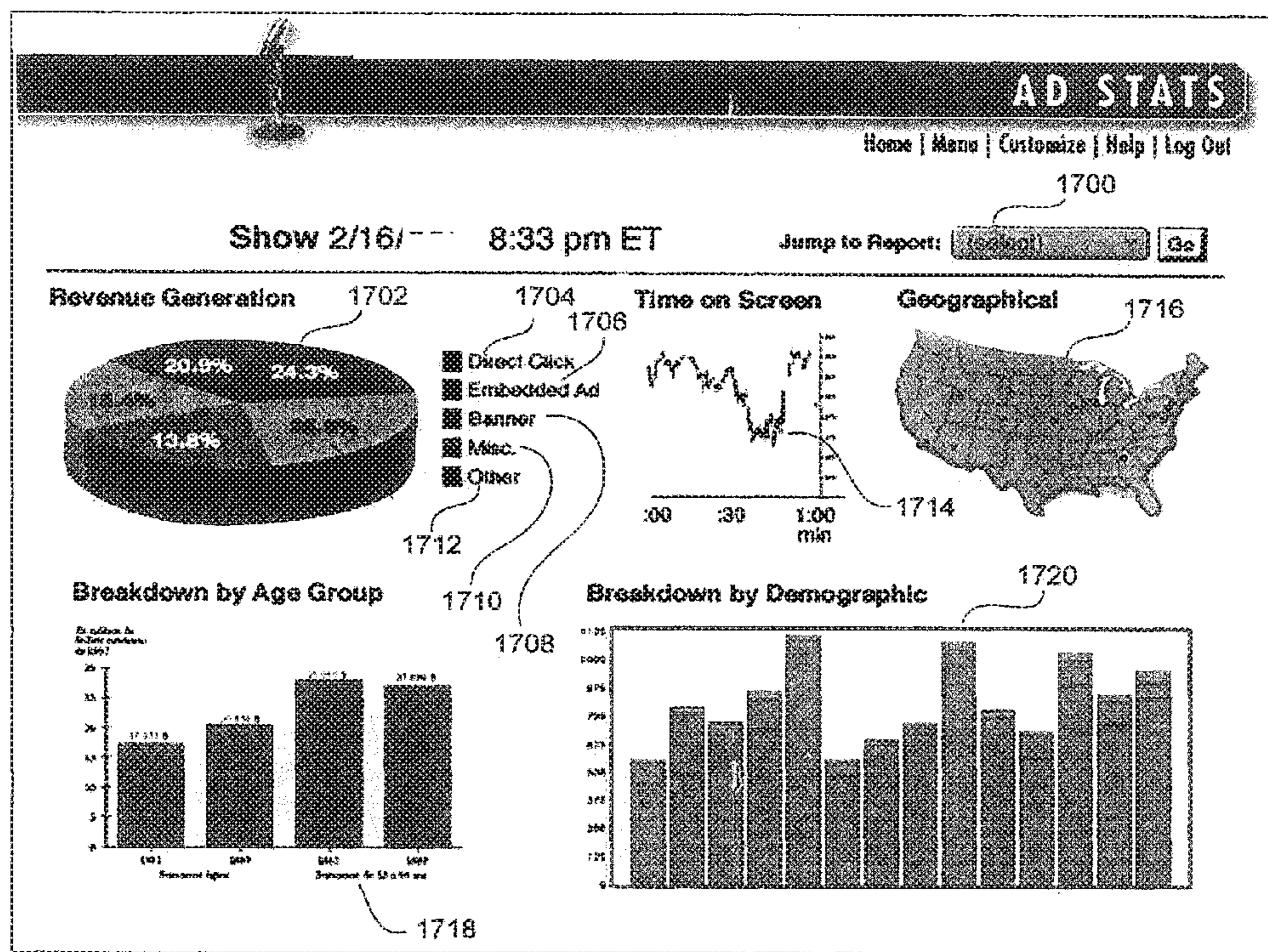

FIG. 17

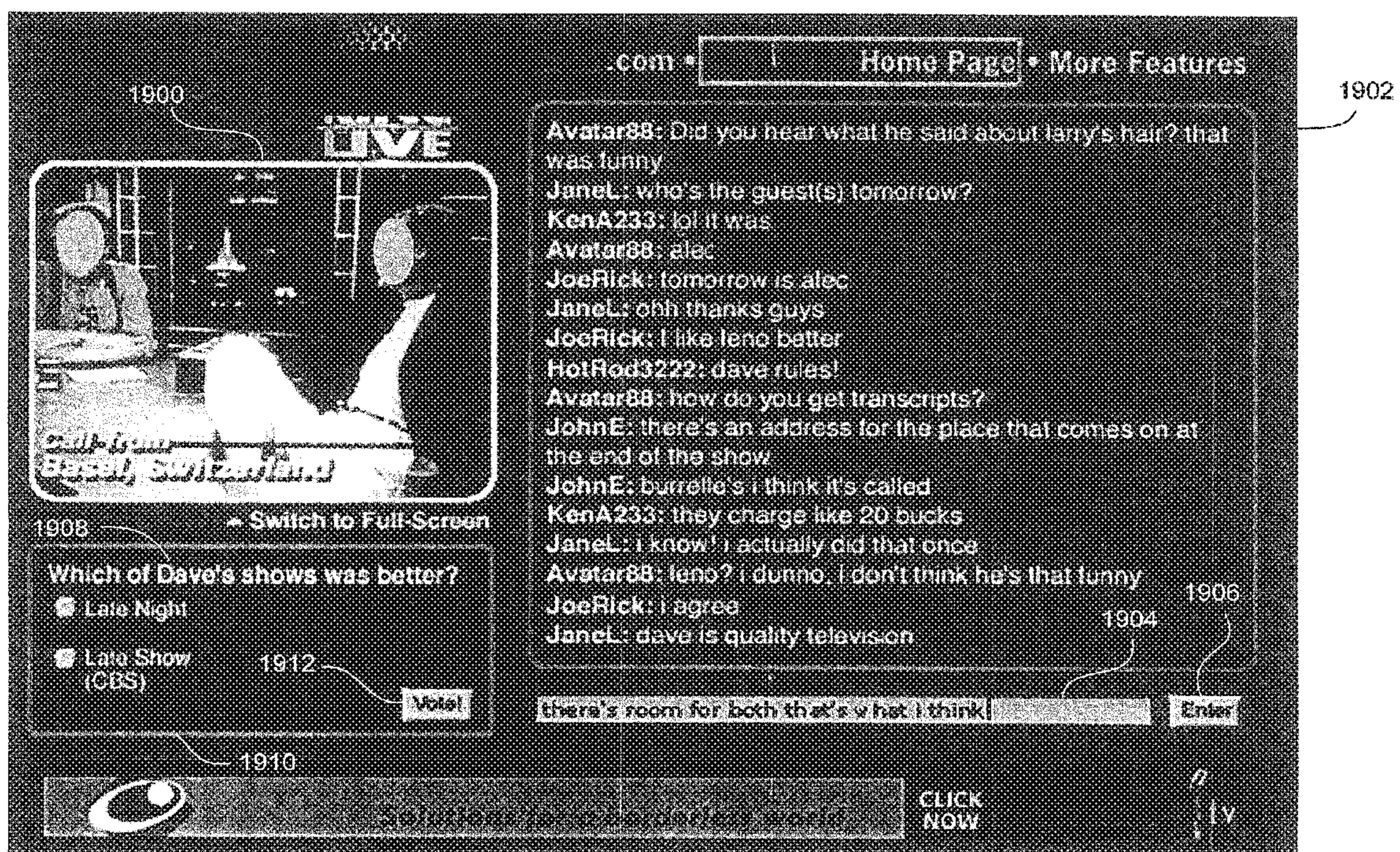

FIG. 19

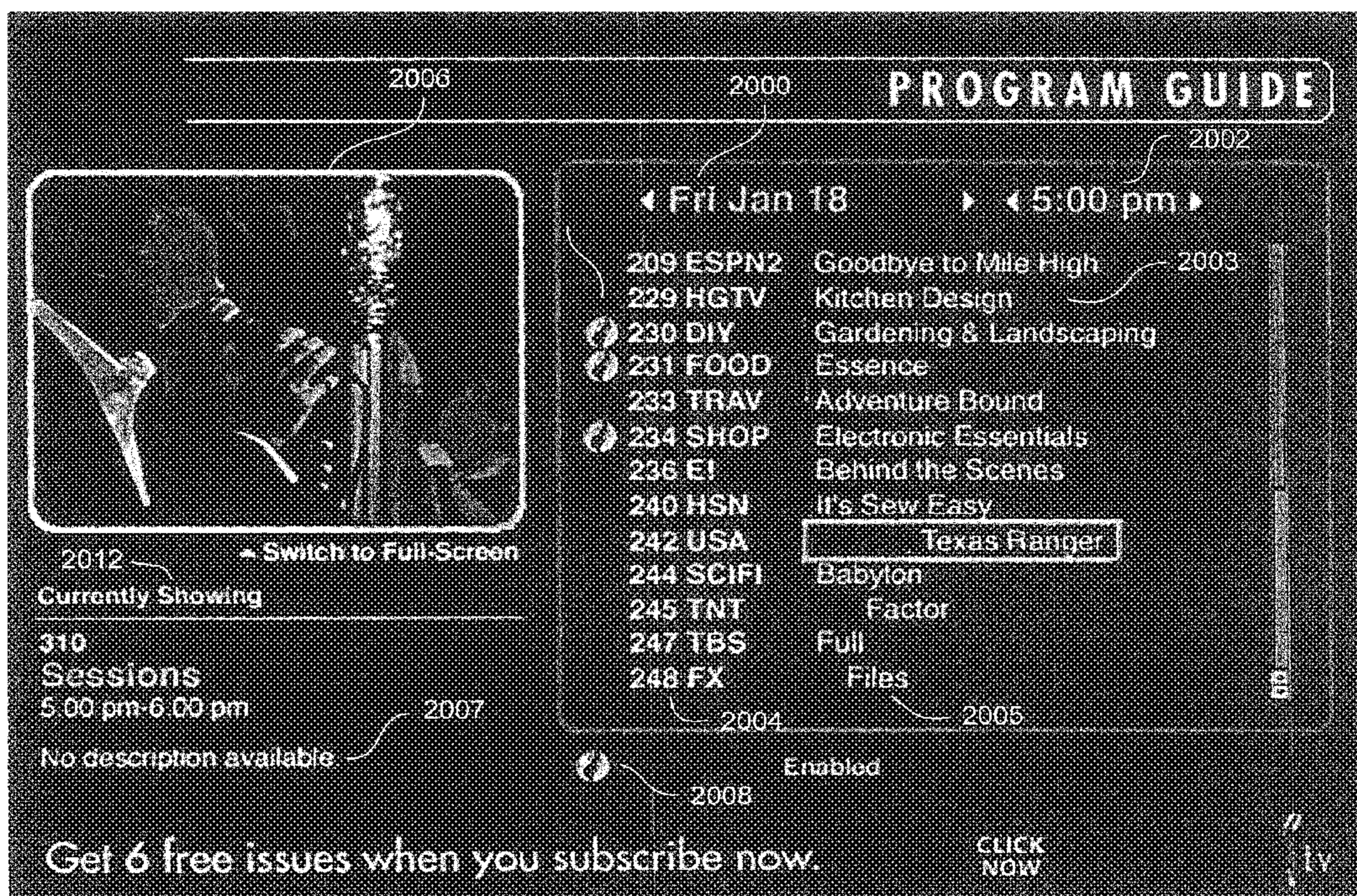

FIG. 20

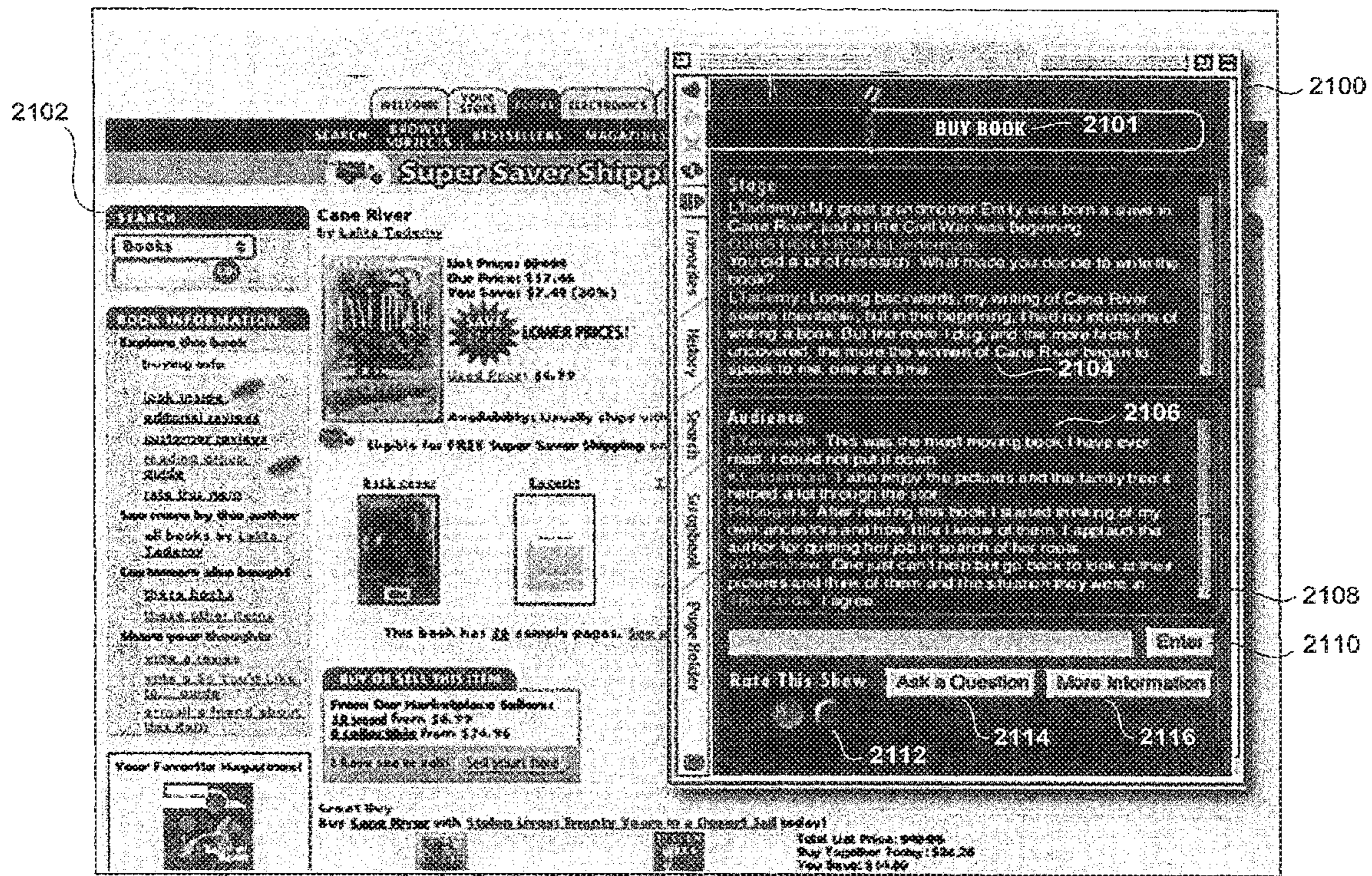

FIG. 21

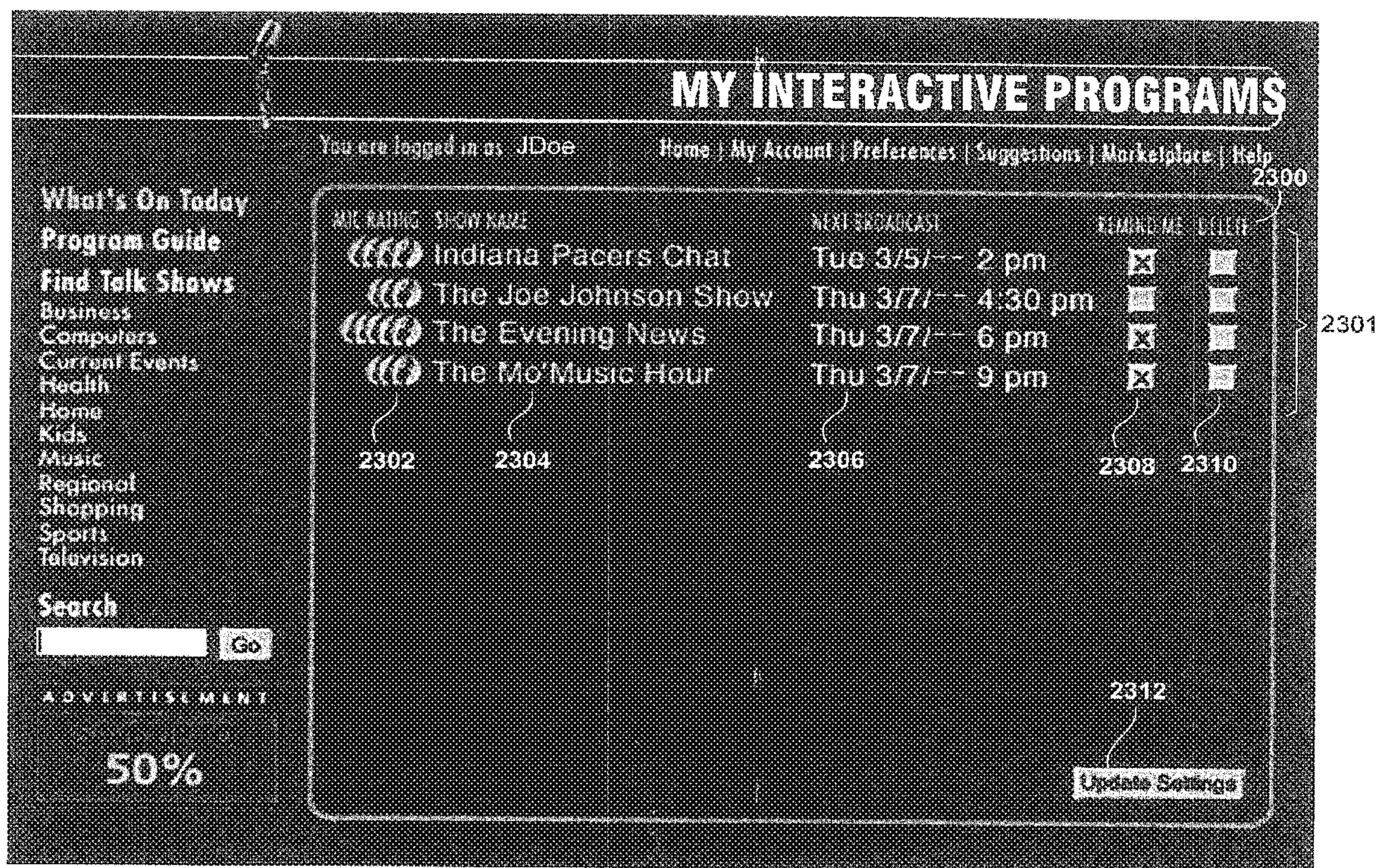

FIG. 23

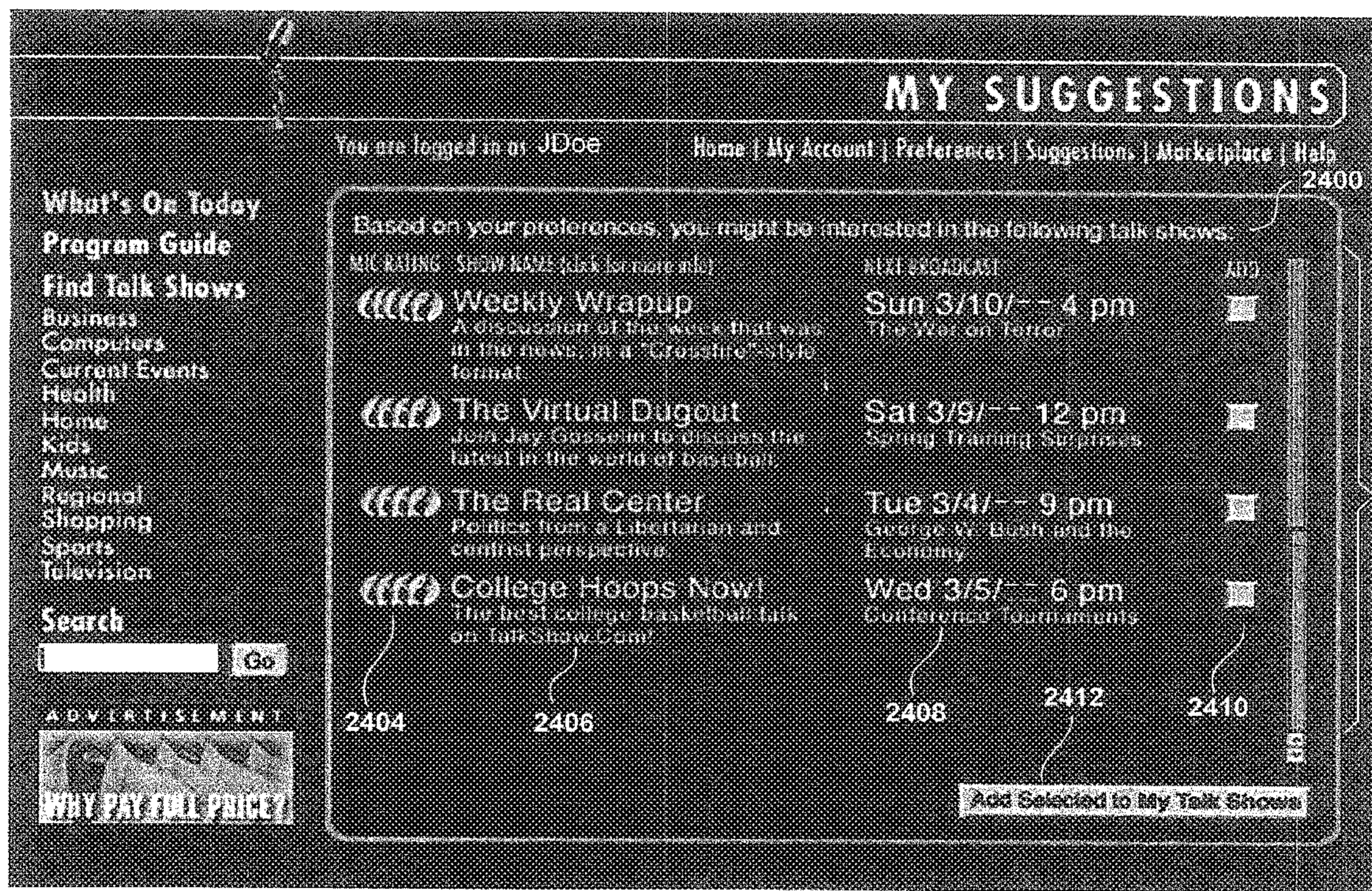

FIG. 24

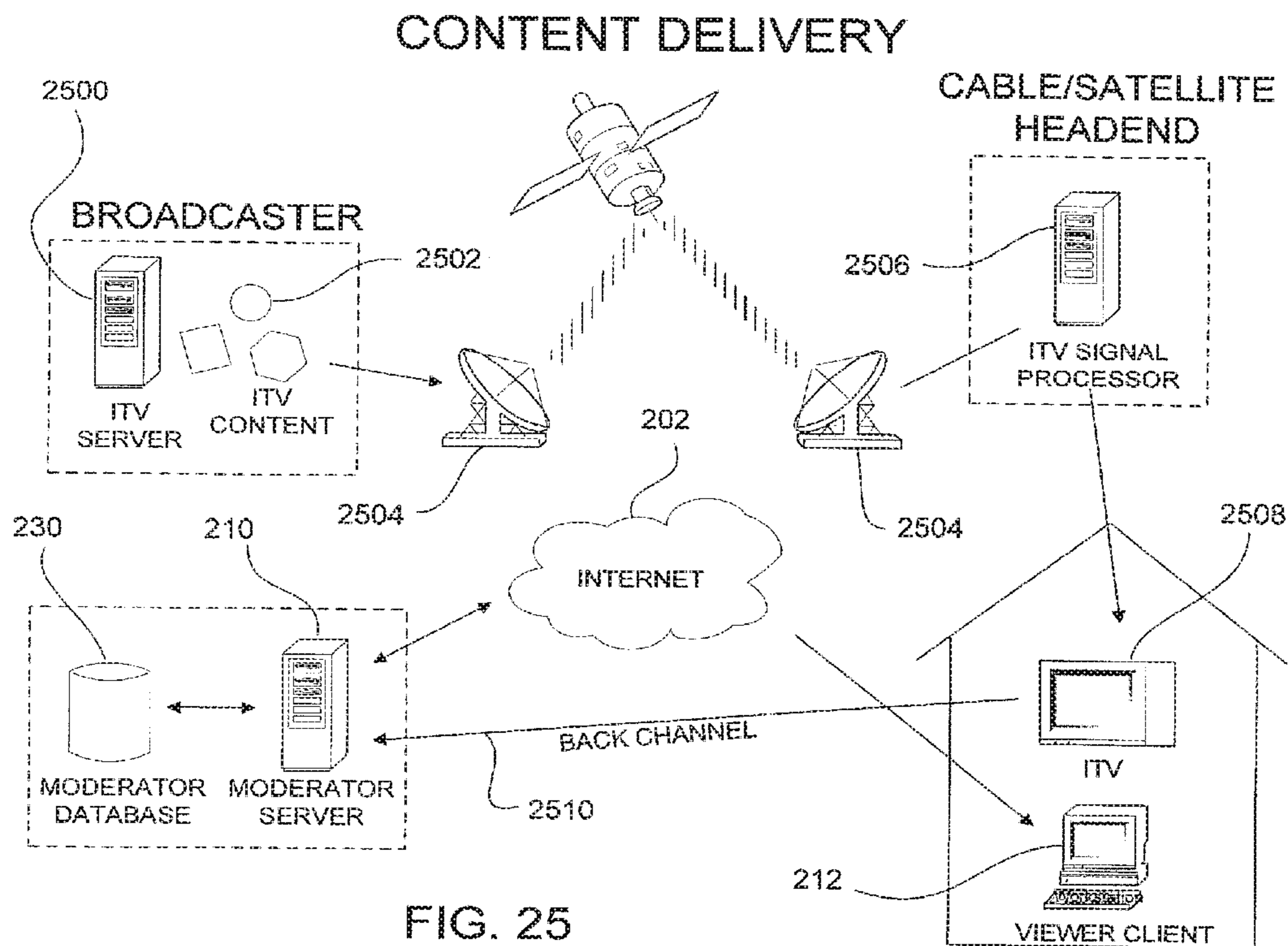

FIG. 25

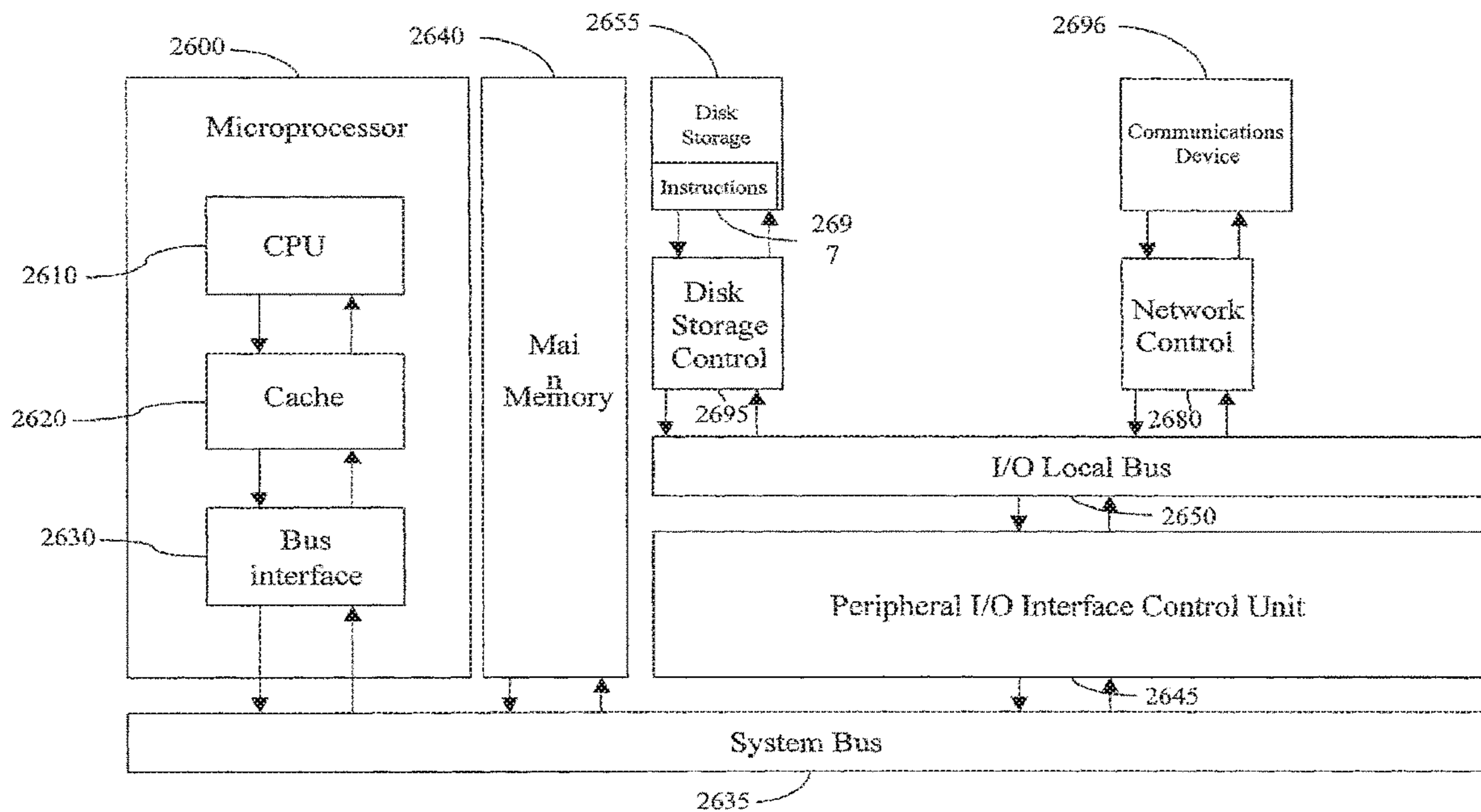
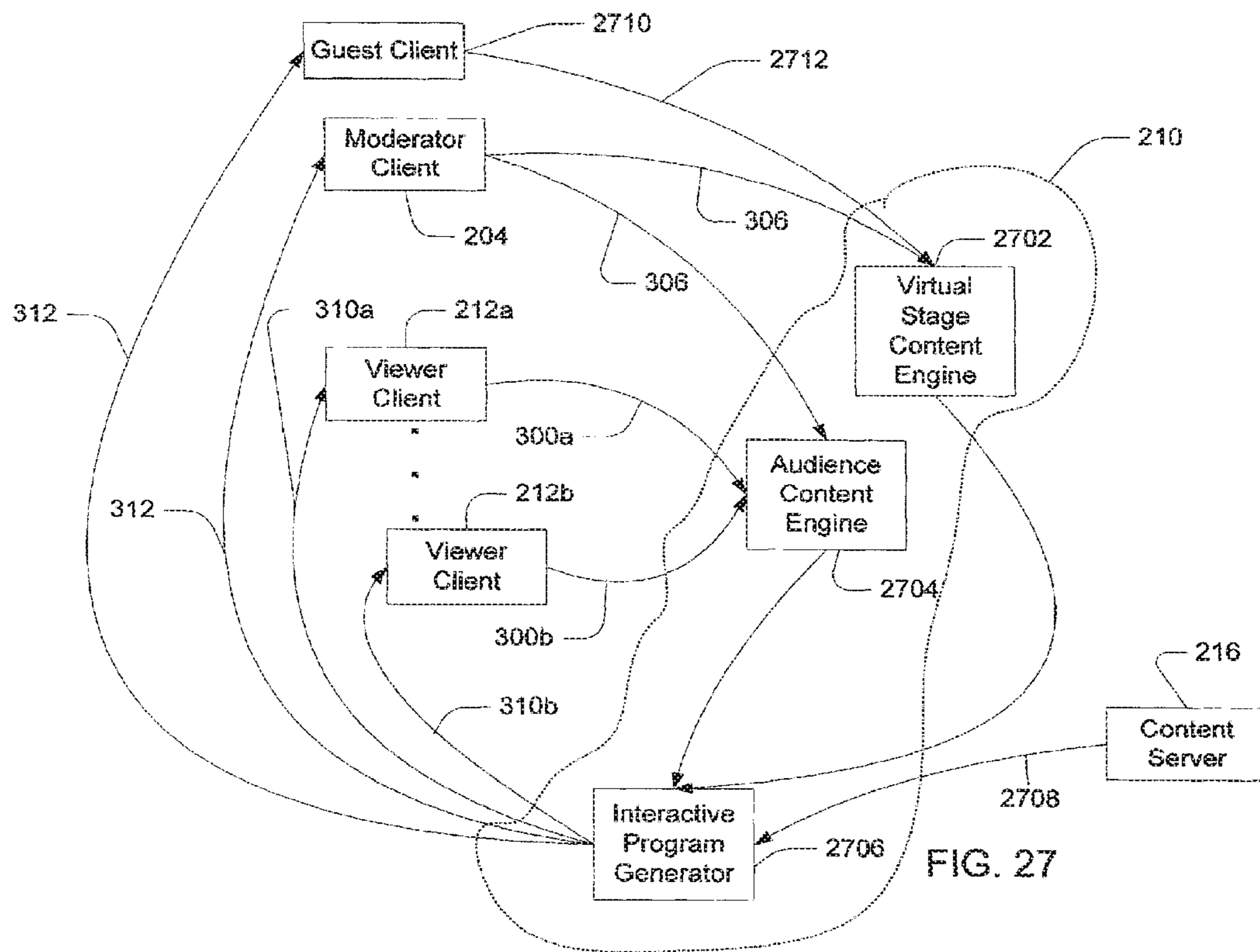

FIG. 26



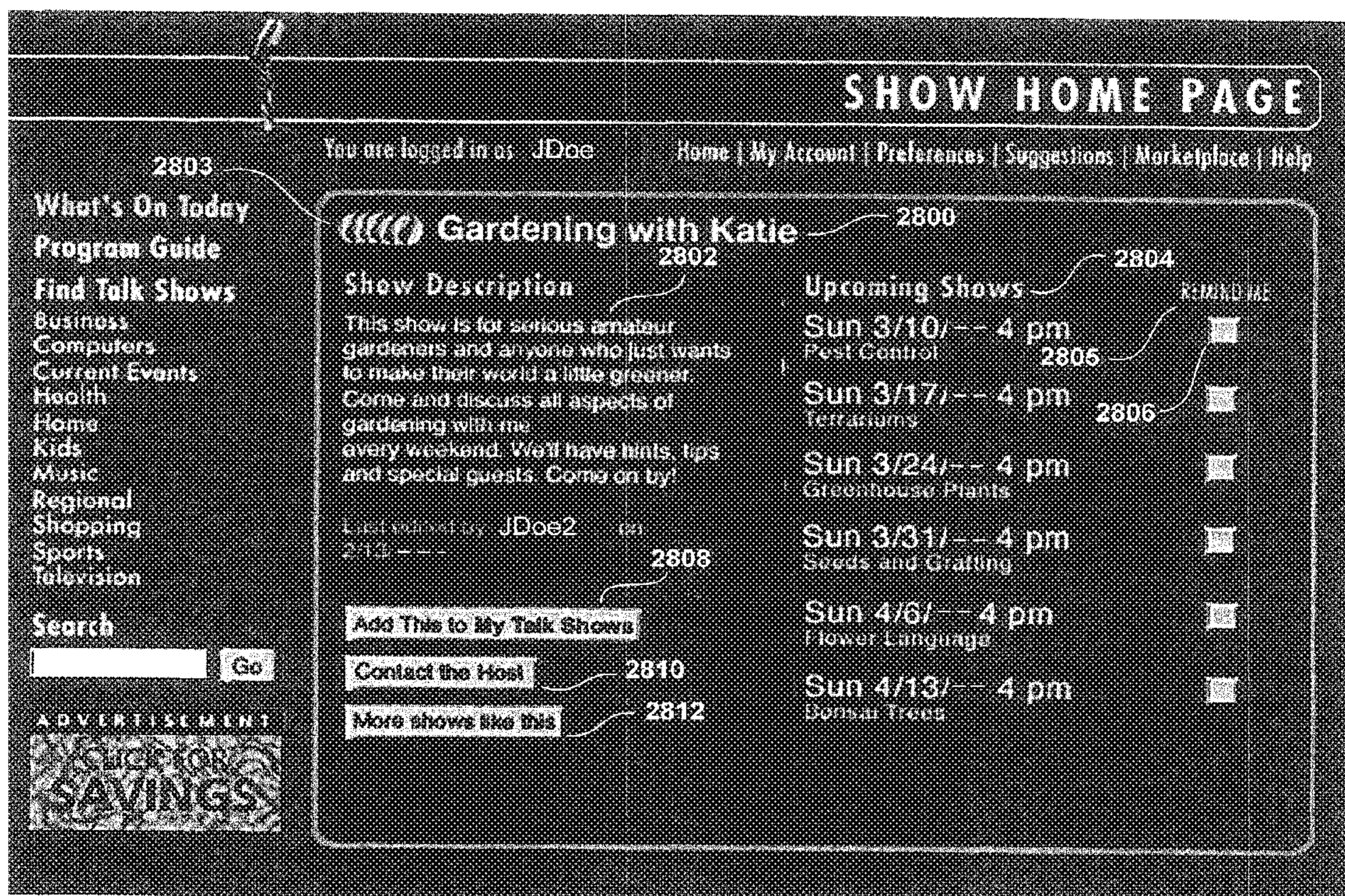

FIG. 28

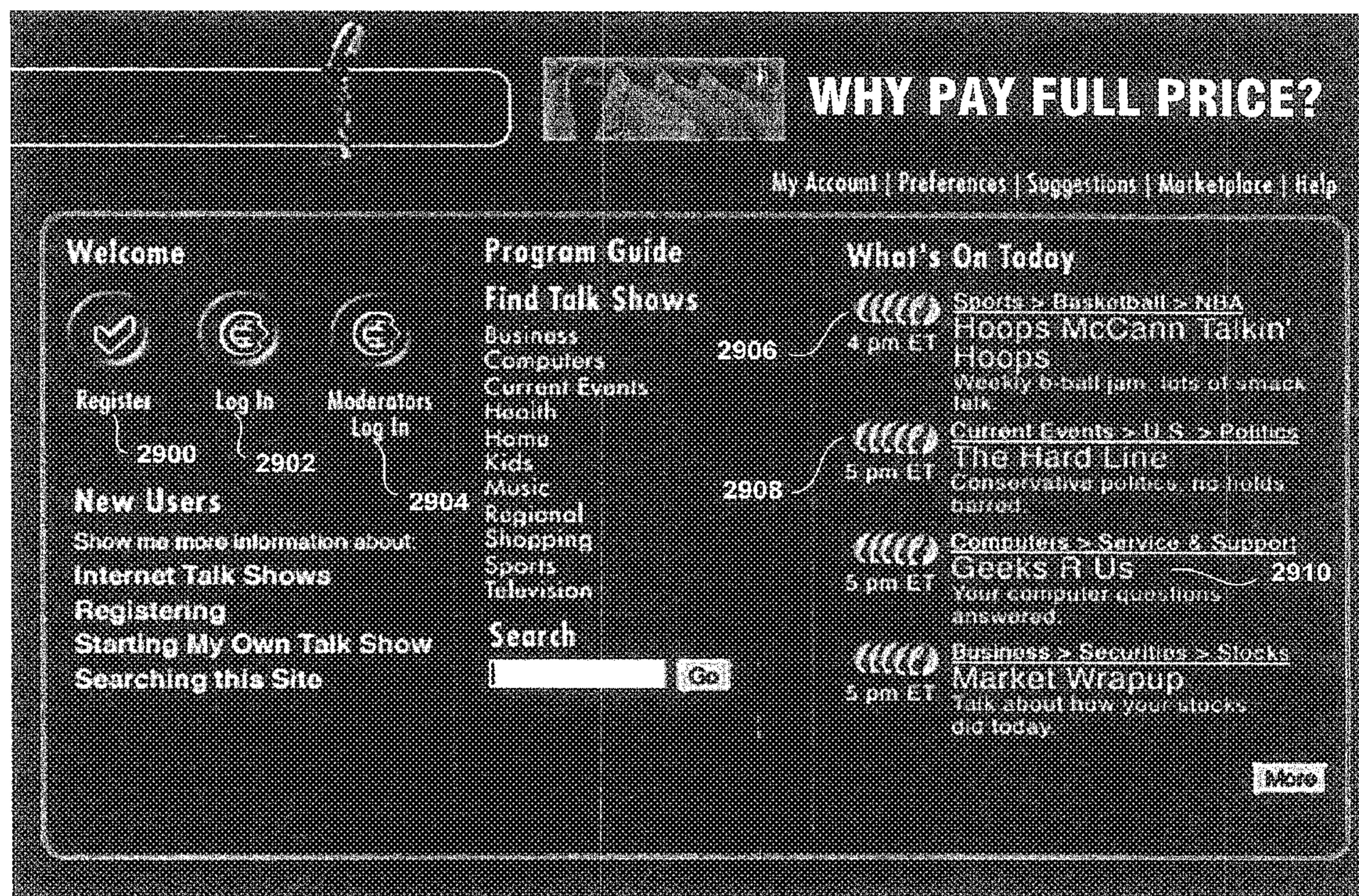

FIG. 29

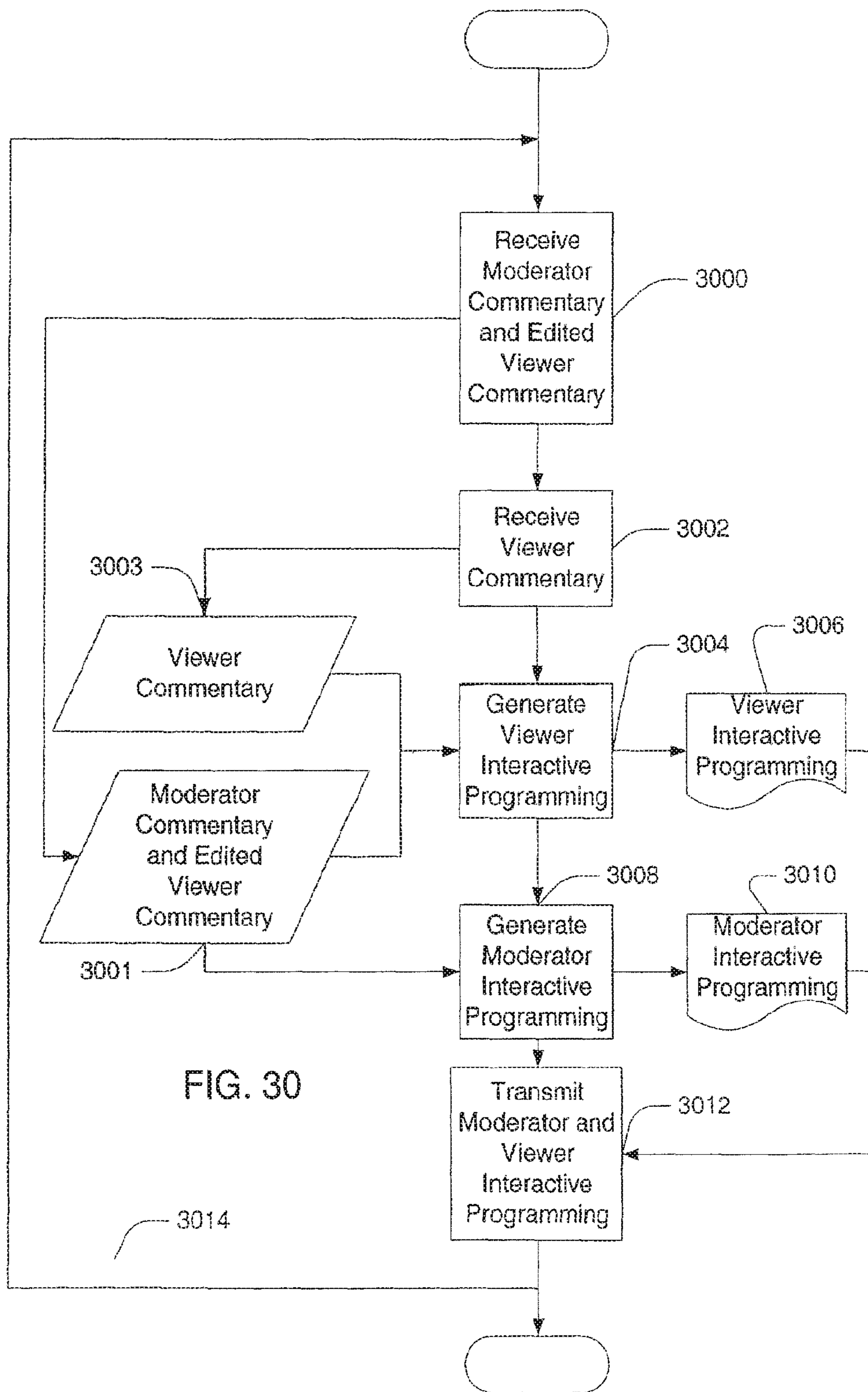

FIG. 30

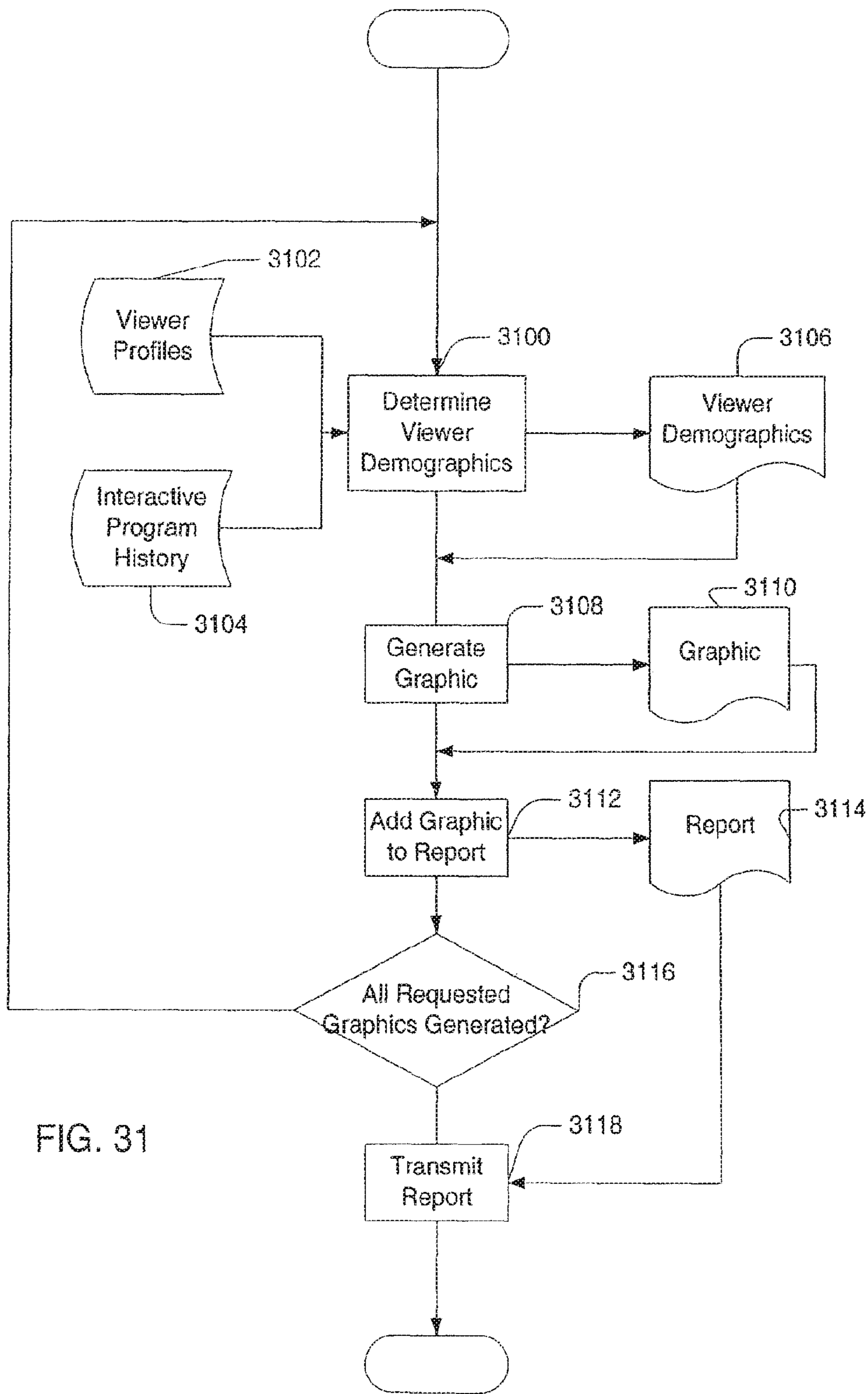

FIG. 31

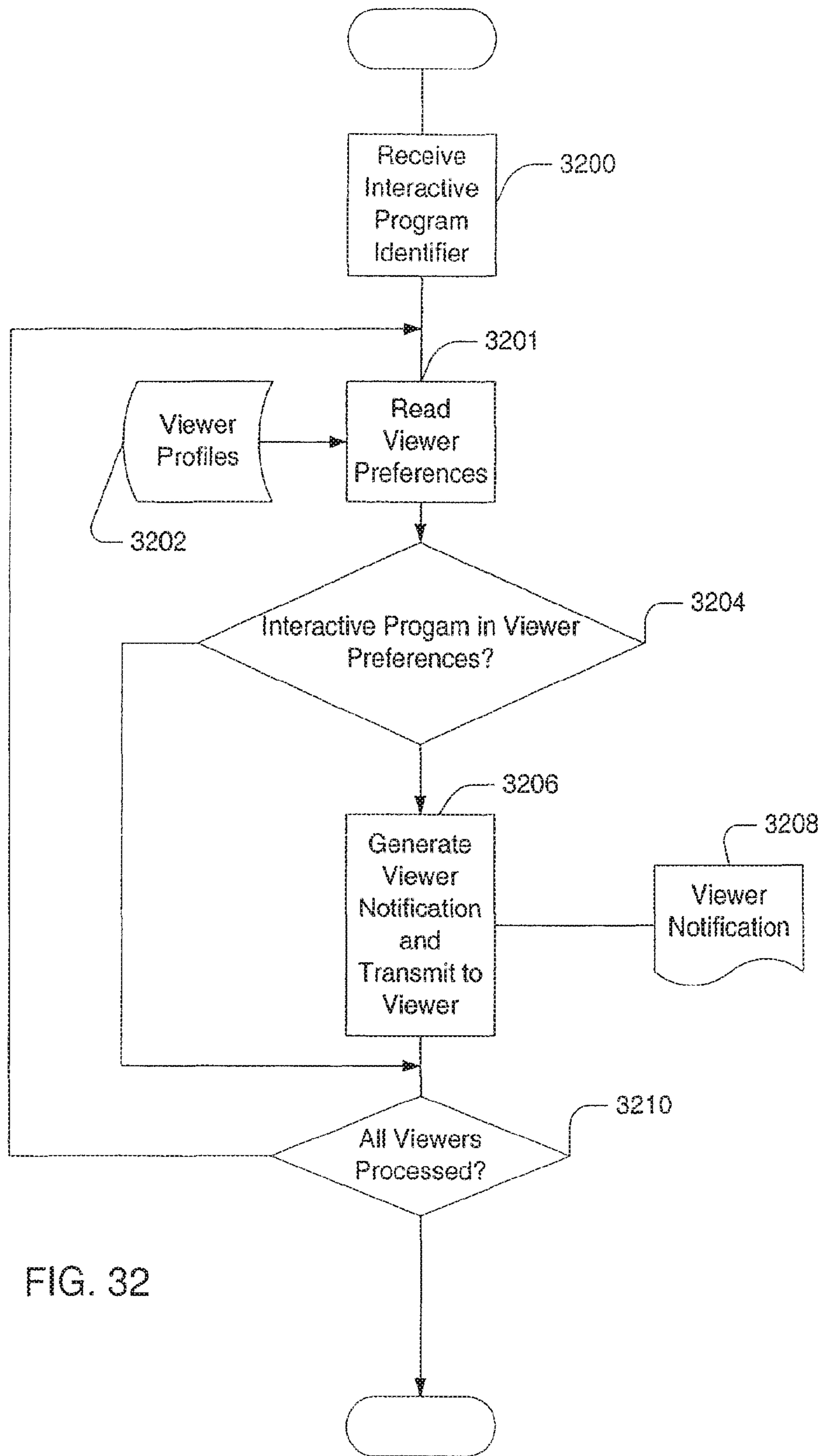

FIG. 32

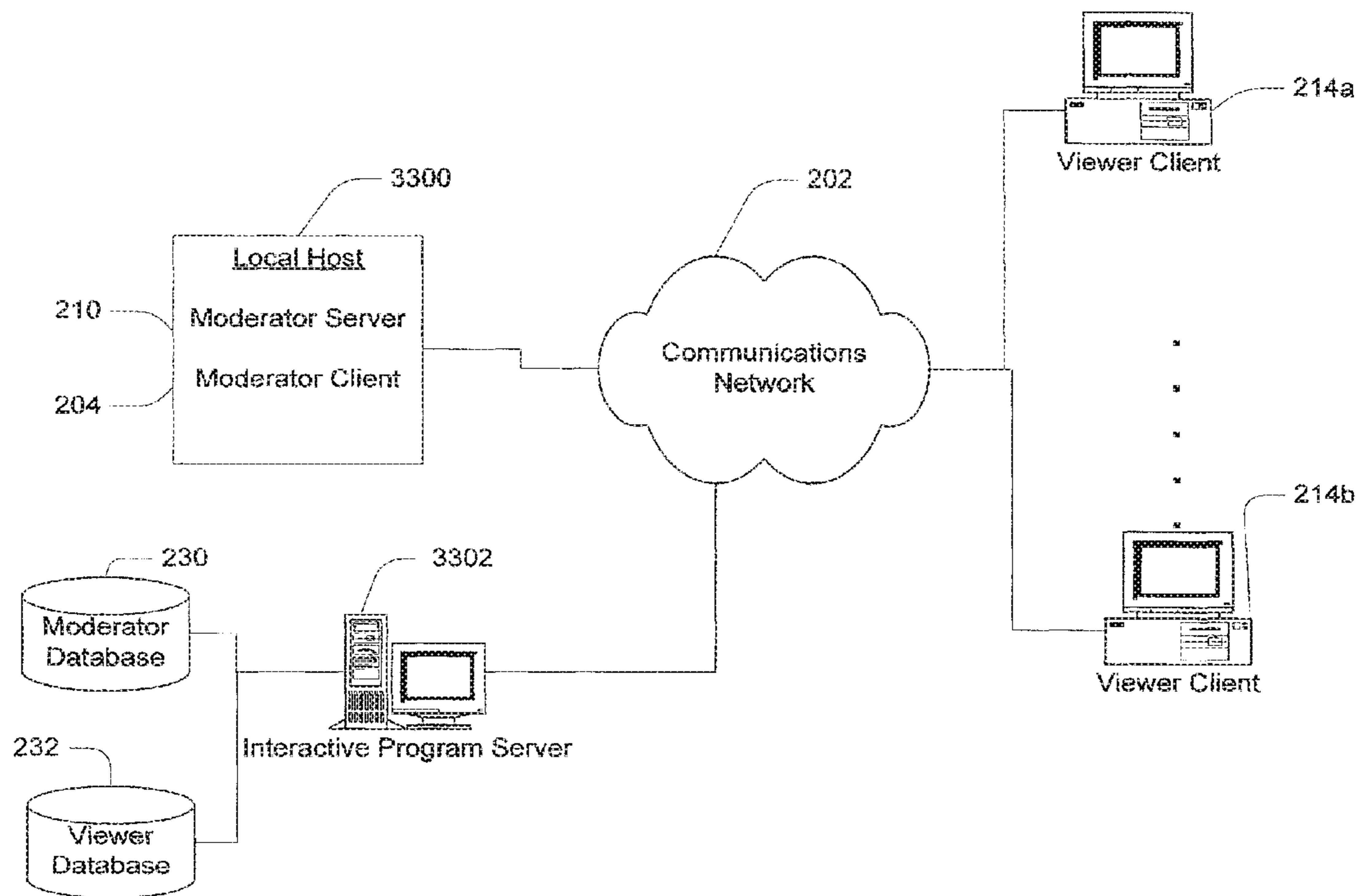
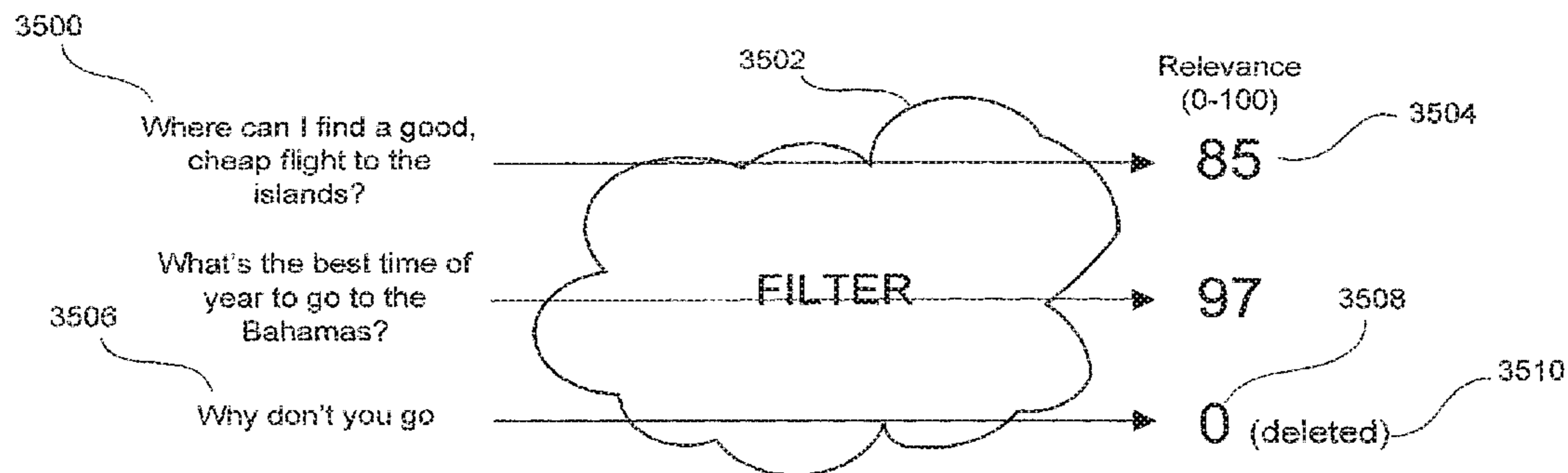
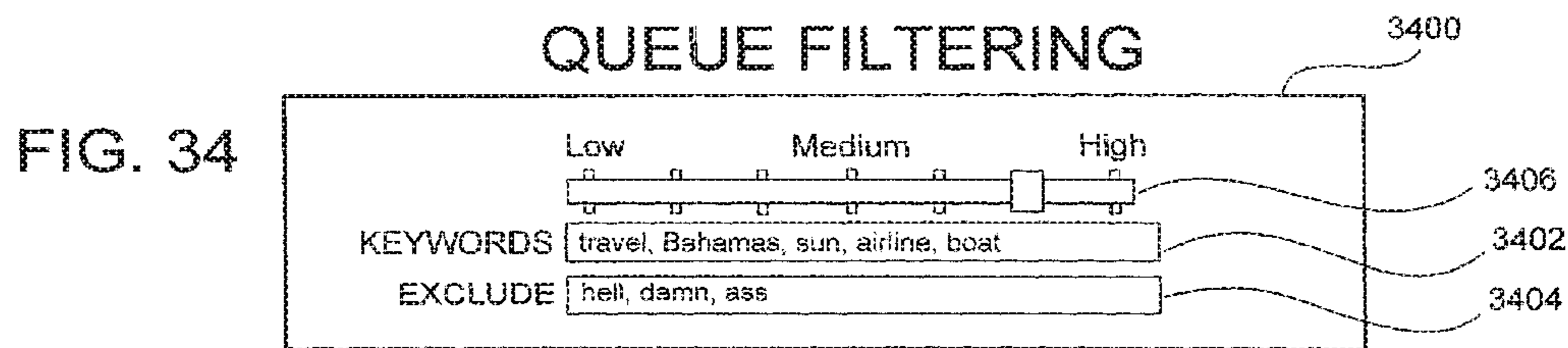

FIG. 33



Using TalkShow.Com's queue filter, the moderator can view questions in a descending order of relevance based on keywords and closeness to the show's topic.

FIG. 35

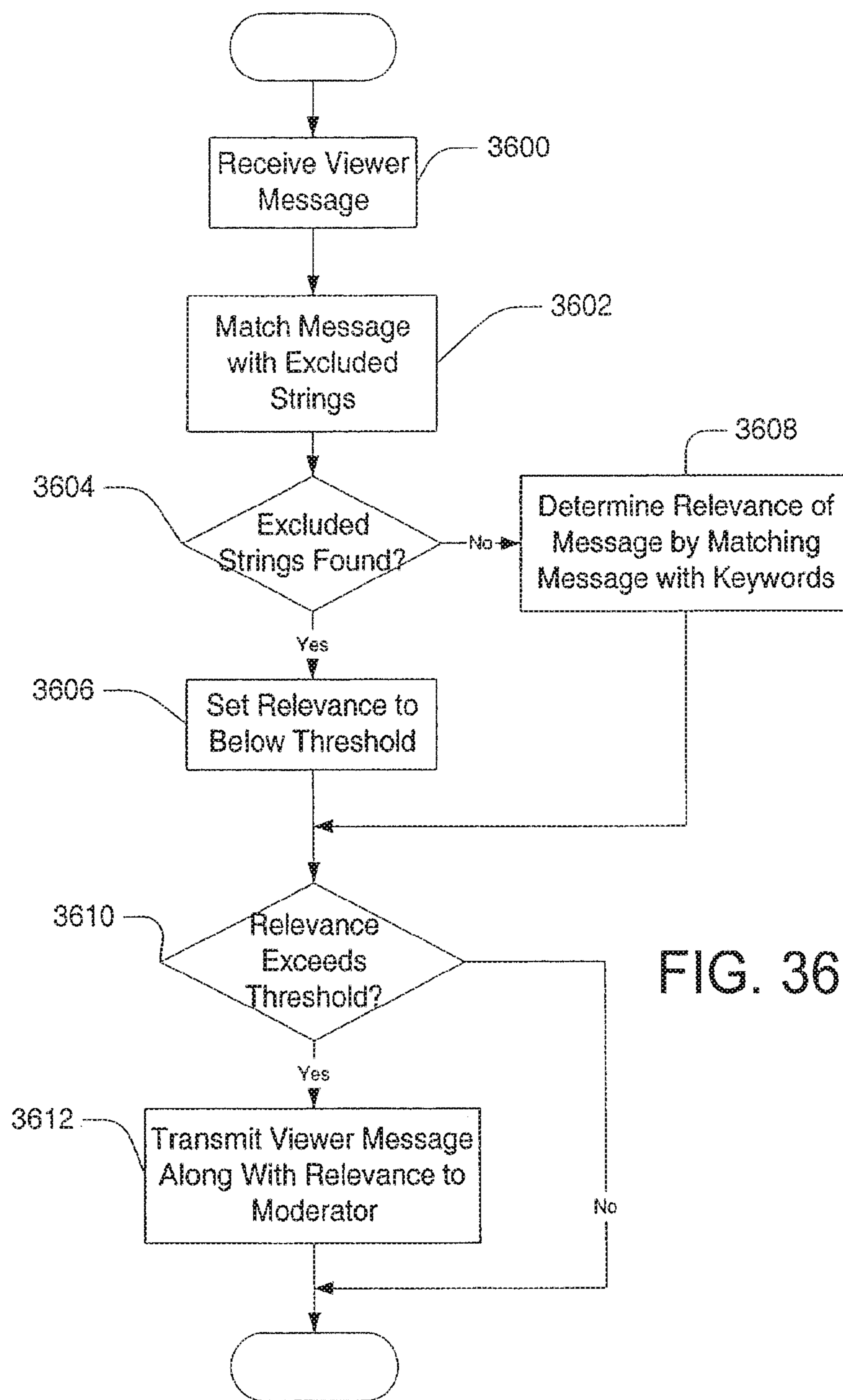

FIG. 36

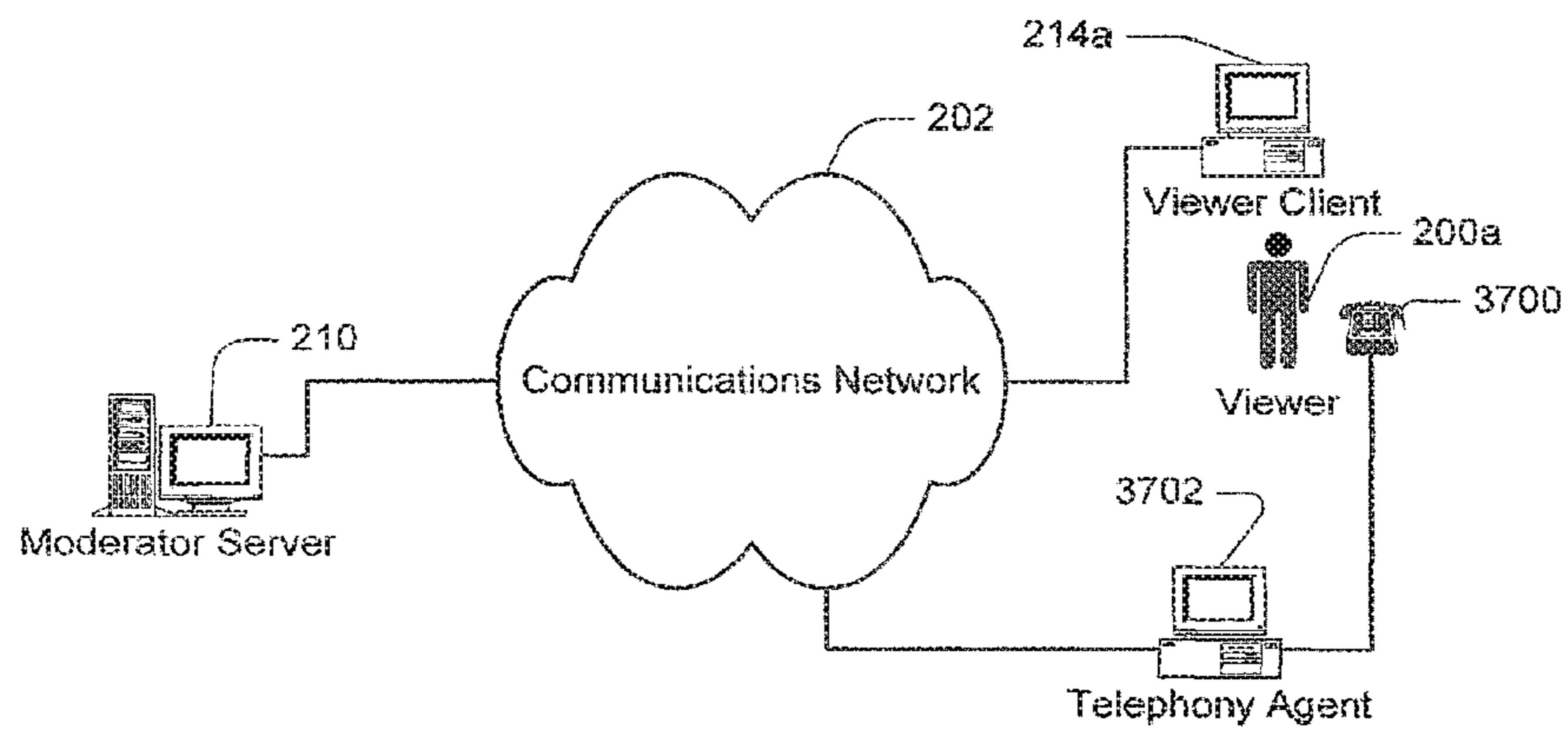

FIG. 37

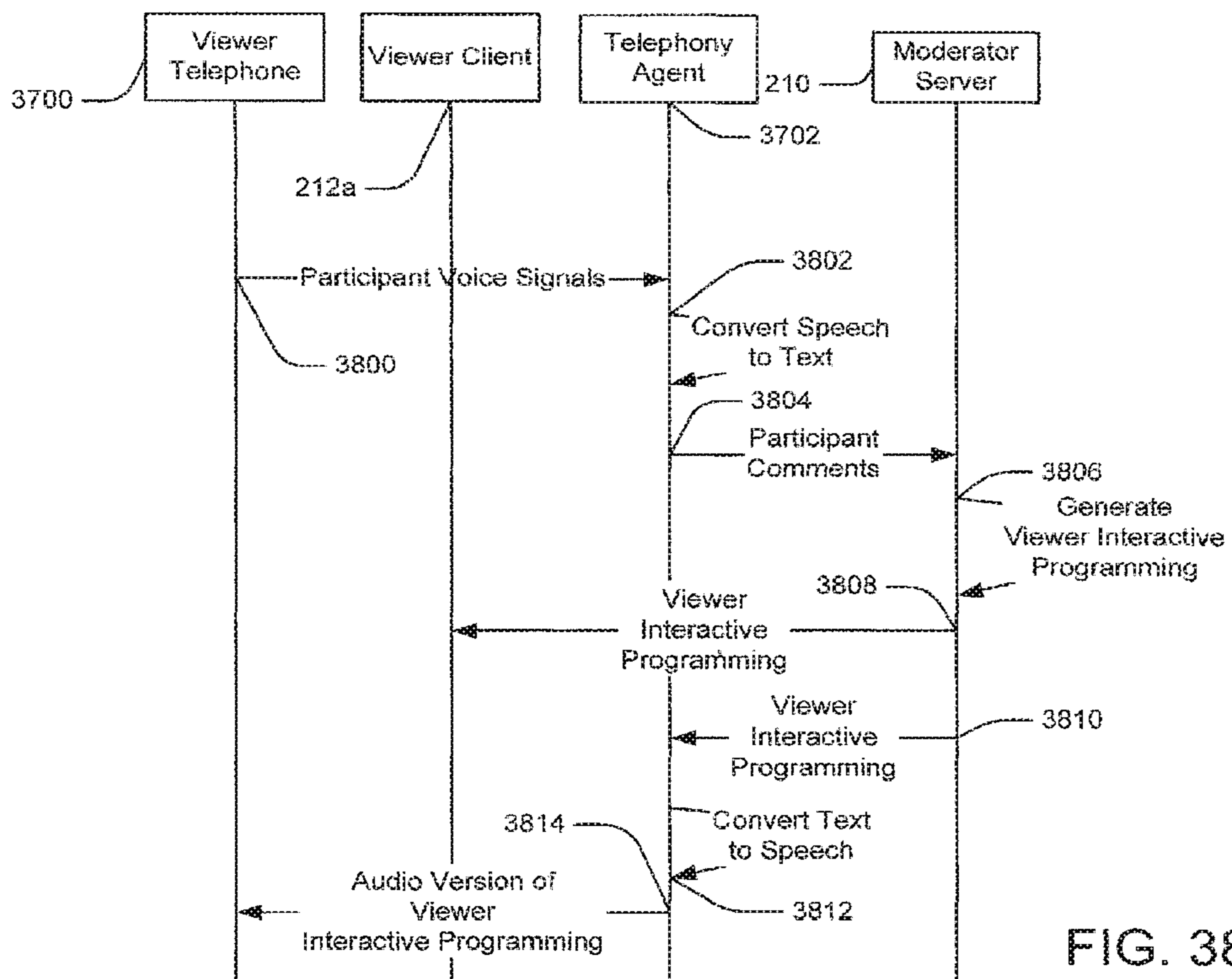

FIG. 38

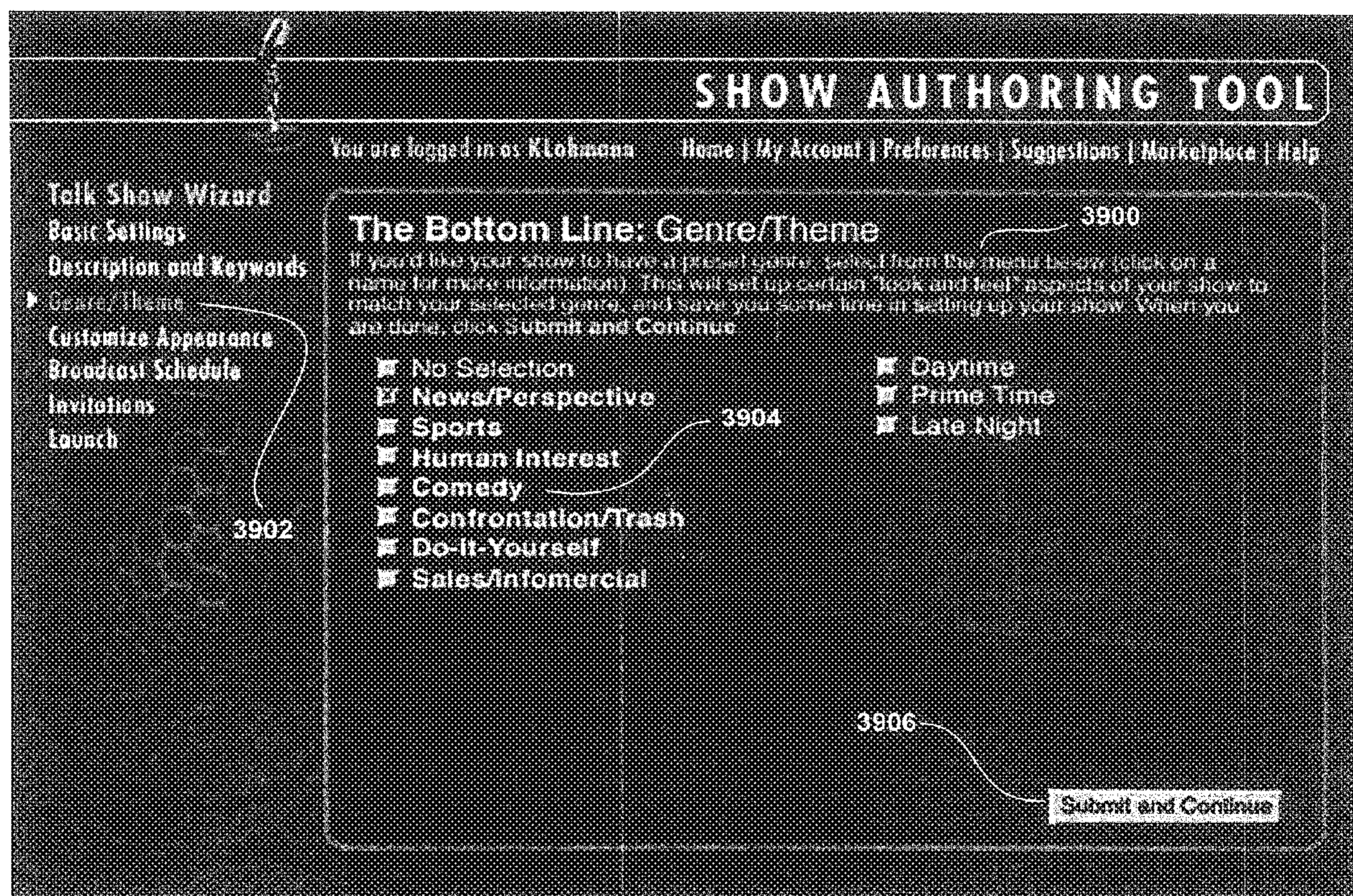

FIG. 39

**METHOD AND APPARATUS FOR
INTERNET-BASED INTERACTIVE
PROGRAMMING**

Matter enclosed in heavy brackets [] appears in the original patent but forms no part of this reissue specification; matter printed in italics indicates the additions made by reissue; a claim printed with strikethrough indicates that the claim was canceled, disclaimed, or held invalid by a prior post-patent action or proceeding.

CROSS-REFERENCE TO RELATED
APPLICATION(S)

This application is a *reissue of U.S. Pat. No. 8,661,490, issued on Feb. 25, 2014, from U.S. patent application Ser. No. 13/597,185, filed on Aug. 28, 2012, which is a continuation of U.S. patent application Ser. No. 11/335,200, filed Jan. 18, 2006, now U.S. Pat. No. 8,255,966, which is a continuation of U.S. patent application Ser. No. 10/123,618, filed Apr. 15, 2002, now abandoned, the entire contents of all of which are hereby incorporated by reference as if set forth in full herein.*

BACKGROUND OF THE INVENTION

This invention pertains generally to the field of interactive programming and more specifically to creating interactive programming including participants' interactions.

Television has traditionally been a serial process where a television program having a series of images and sounds are broadcast to a viewer in an audience with limited opportunity for the viewer to participate, in the television program. The evolution to a more interactive form of television, or television where the viewer is allowed to participate, was slow given the lack of bidirectional communication channels between the viewer and the television program broadcaster. When bidirectional communication channels were created, they tended to be of insufficient bandwidth for communication of complex viewer interactions with the television program.

Development of a nearly ubiquitous communications network, namely the Internet, has greatly expanded the use of interactive television. However, viewer participation has so far been limited to choosing television content, responding to advertising messages, and answering viewer questionnaires or polls. This is primarily because most interactive television programming follows a conventional television paradigm wherein the television programming is wrapped in advertisements; and the only responses needed from an audience are to watch linear pre-recorded programs and to buy advertised items or services. Little has been done to fully involve the audience in a rich participatory experience where the audience has as much control and influence over the content of an interactive program as the originator of the interactive program. This is in contrast to the expectations of some viewers who want a richer and more satisfying participatory experience within the context of an interactive program.

Some interactive television formats also have a disadvantage in that, although they may use the Internet as a bidirectional communication channel, the interactive television format is dependent upon set-top-boxes and middleware that a viewer either purchases or leases from a broadcaster such as a cable operator. While these devices may have a variety of functional features, they may require an additional expenditure that a viewer or a Multiple Systems

Operator (MSO) may not want to incur, especially if the viewer already has an Internet-enabled device such as a home computer. This makes most existing interactive television programming "heavy" in the sense that specialized hardware is needed to take advantage of the interactive content embedded in an interactive programming signal. Additionally, the combination of a required set-top-box and specialized interactive television formats make interactive programming distributed over an interactive television network difficult to integrate with conventional Web content such as Web pages available from a Web site.

Therefore, a need exists for a light-weight interactive programming system allowing for rich viewer participation which is easily integrated with existing Web content. The present invention meets such need.

SUMMARY OF THE INVENTION

In one aspect of the invention, an interactive program includes moderator content generated by the moderator and edited participant commentary that is served by a moderator server. Moderators create and manage interactive programs using a Web site. Viewers register to be participants in interactive programs using the Web site as well. The interactive programs can be distributed as electronic documents written in a markup language such as HTML or XML over the Internet. The interactive programs can also be converted to conventional interactive television content for distribution over an interactive television network. The interactive programs can also be distributed over a Virtual Private Network (VPN) for use as a secure collaboration tool by an enterprise such as a business concern. The interactive programs require few processing resources so the interactive programs can be embedded within other Web processes such as electronic commerce (eCommerce) or television commerce (t-Commerce) transactions.

In another aspect of the invention, a method is provided for creating and transmitting an interactive program over a communications network. A moderator server is operably coupled to the communications network. A moderator client and a plurality of viewer clients are operably coupled to the moderator server via the communications network. In operation, participant comment signals are received by the moderator server via the communications network from the plurality of viewer clients and transmitted by the moderator server via the communications network to the moderator client. The moderator server then receives from the moderator client edited participant comment signals and moderator signals and generates interactive program signals using the edited participant comment signals and the moderator signals. The interactive program signals are then transmitted by the moderator server via the communications network to the plurality of viewer clients.

In another aspect of the invention, a data processing system is adapted for creating and transmitting an interactive program to a plurality of viewer clients as described above. In addition, the data processing system receives content signals from a content server and generates the interactive program signals using the content signals, edited participant comment signals, and the moderator signals.

In another aspect of the invention, the data processing system receives content signals from a content server and transmits the content signals via the communications network to the viewer clients while incorporating the content signals into the interactive program.

In another aspect of the invention, the communications network is a virtual private network thus enabling private and secure transmission of an interactive program throughout an enterprise.

In another aspect of the invention, the participant comment signals further include an interactive program rating signal indicating a level of audience satisfaction with the interactive program.

In another aspect of the invention, the moderator signals further include a participant exclusion signal corresponding to a specific viewer client from the plurality of viewer clients. The participant exclusion signal is used to exclude participant comments received from the specific viewer client thus preventing specified viewers from participating in the interactive program.

BRIEF DESCRIPTION OF THE DRAWINGS

These and other features, aspects, and advantages of the present invention will become better understood with regard to the following description, appended claims, and accompanying drawings where:

FIG. 1 is a conceptual diagram of a system for creating an interactive program incorporating participant interactions in accordance with an exemplary embodiment of the present invention;

FIG. 2 is a deployment diagram of a system for creating an interactive program in accordance with an exemplary embodiment of the present invention;

FIG. 3 is a sequence diagram of the operations within a system for creating an interactive program in accordance with an exemplary embodiment of the present invention;

FIG. 4 is a screen capture of a moderator's interface used to control generation of an interactive program in accordance with an exemplary embodiment of the present invention;

FIG. 5 is a screen capture of a viewer's interface used to view and interact with an interactive program in accordance with an exemplary embodiment of the present invention;

FIG. 6 is a diagram depicting a process for receiving viewer reactions to an interactive program and calculating an audience approval system rating for the interactive program in accordance with an exemplary embodiment of the present invention;

FIG. 7 is a diagram depicting the ways in which a moderator may interact with a system for creating an interactive program in accordance with an exemplary embodiment of the present invention;

FIG. 8 is a use case diagram depicting ways in which a viewer may interact with a system for creating an interactive program in accordance with an exemplary embodiment of the present invention;

FIG. 9 is a Web site diagram of an interactive program creation system in accordance with an exemplary embodiment of the present invention;

FIG. 10 is a screen capture of an edit profile viewer interface in accordance with an exemplary embodiment of the present invention;

FIG. 11 is a screen capture of a hub viewer interface in accordance with an exemplary embodiment of the present invention;

FIG. 12 is a screen capture of a program guide viewer interface in accordance with an exemplary embodiment of the present invention;

FIG. 13 is a screen capture of an interactive program archive viewer interface in accordance with an exemplary embodiment of the present invention;

FIG. 14 is a screen capture of a moderator interface for an interactive program authoring tool in accordance with an exemplary embodiment of the present invention;

FIG. 15 is a screen capture of a moderator interface for an interactive program reporting tool in accordance with an exemplary embodiment of the present invention;

FIG. 16 is a screen capture of a moderator interface for a participant interaction report generated in accordance with an exemplary embodiment of the present invention;

FIG. 17 is a screen capture of a moderator interface for an advertising report generated in accordance with an exemplary embodiment of the present invention;

FIG. 18 is a database entity relation diagram for a moderator database in accordance with an exemplary embodiment of the present invention;

FIG. 19 is a screen capture of a viewer interface for a non-moderator based interactive program associated with a broadcast in accordance with an exemplary embodiment of the present invention;

FIG. 20 is a screen capture of a viewer interface for a broadcast program guide in accordance with an exemplary embodiment of the present invention;

FIG. 21 is a screen capture of a viewer interface for an interactive program incorporating Web content in accordance with an exemplary embodiment of the present invention;

FIG. 22 is a screen capture of a viewer interface for an interactive program incorporating Web content in accordance with another exemplary embodiment of the present invention;

FIG. 23 is a screen capture of a viewer interface for a facility to manage a viewer's personal favorite interactive programs in accordance with an exemplary embodiment of the present invention;

FIG. 24 is a screen capture of a viewer interface for a facility to suggest programs to a viewer in accordance with an exemplary embodiment of the present invention;

FIG. 25 is a deployment diagram of a process for conversion and delivery of interactive programs via an interactive television network in accordance with an exemplary embodiment of the present invention;

FIG. 26 is a hardware architecture diagram of a computing device suitable for use as a moderator server host in accordance with an exemplary embodiment of the present invention;

FIG. 27 is a collaboration diagram depicting an interactive programming generation process in accordance with an exemplary embodiment of the present invention;

FIG. 28 is a screen capture of an interactive program home viewer interface in accordance with an exemplary embodiment of the present invention;

FIG. 29 is a screen capture of an interactive program system log-in interface in accordance with an exemplary embodiment of the present invention;

FIG. 30 is a process flow diagram of an interactive program generation process in accordance with an exemplary embodiment of the present invention;

FIG. 31 is a process flow diagram of an interactive program report generation process in accordance with an exemplary embodiment of the present invention;

FIG. 32 is a process flow diagram of a viewer notification process in accordance with an exemplary embodiment of the present invention;

FIG. 33 is a deployment diagram of a locally hosted moderator server in accordance with an exemplary embodiment of the present invention;

5

FIG. 34 is a participant question filtering moderator interface in accordance with an exemplary embodiment of the present invention;

FIG. 35 is an illustration of the operation of a participant question filtering facility in accordance with an exemplary embodiment of the present invention;

FIG. 36 is a process flow diagram of a participant question filter process in accordance with an embodiment of the present invention;

FIG. 37 is a deployment diagram for a telephony system for delivery of an interactive program in accordance with an embodiment of the present invention;

FIG. 38 is a sequence diagram for a telephony process as used by a telephony system for delivery of an interactive program in accordance with an embodiment of the present invention; and

FIG. 39 is a screen capture of an interactive program authoring wizard in accordance with an exemplary embodiment of the present invention.

DETAILED DESCRIPTION OF THE INVENTION

FIG. 1 is a conceptual diagram of a system for creating an interactive program incorporating participant interactions in accordance with an exemplary embodiment of the present invention. A moderator 100 hosts an interactive program, such as a broadcast program with a talk show format, that is transmitted to an audience having a plurality of viewers 102. The interactive program takes place on a virtual stage 104 where the moderator generates interactive programming for transmission to the viewers. The moderator transmits the interactive program 106 to the viewers. The viewers may passively watch the interactive program or may become active participants by generating their own comments 108 that are transmitted back to the moderator. The moderator edits or filters the participant comments and retransmits the edited participant comments as part of the interactive program. The viewers may communicate with each other during the interactive program by exchanging audience interactive messages 110 between themselves.

The moderator controls the content of the interactive program in a variety of ways. The moderator introduces the initial topic or content for audience interaction. For example, the moderator may introduce a topical event such as a news story and then ask for participant comments. The moderator may also use previously prepared content such as a non-interactive program that is transmitted to the audience in order to elicit audience member responses and engage viewers. The moderator can invite virtual guests 112 from the audience onto the virtual stage. While on the virtual stage, the virtual guests exchange interactive messages directly with the moderator rather than with other audience members or participants. The moderator may also exclude a participant or viewer from the audience. Additionally, the moderator may generate additional interactive programming for use by the audience such as polls so that the audience can participate in the interactive program by selecting responses to a question from a list of answers. The results of the participant responses are aggregated for inclusion in the interactive program.

In one system for creating an interactive program incorporating participant interactions in accordance with an exemplary embodiment of the present invention, the interactive programs are talk shows hosted by independent moderators and delivered to an audience via the Internet. This system allows a moderator to be recognized as an

6

expert or respected voice in a particular field while building a community of viewer participants interested in that particular field. The system allows the moderator to create a controlled and moderated environment where the moderator directs the flow of information and has complete control over the medium. The system is cost-effective because no special hardware or training is needed to operate the system. The system features a customizable Web-based interface for moderators and viewers to use in creating customized collaborative interactive programs.

FIG. 2 is a deployment diagram of a system for creating an interactive program incorporating participant interactions in accordance with an exemplary embodiment of the present invention. A moderator 100 transmits an interactive program to a plurality of viewers, as exemplified by viewers 200a and 200b, via a communications network 202 such as the Internet. The moderator uses a moderator client 204 to transmit moderator signals over communications link 206 and communications link 208 to a moderator server 210. The moderator server uses the moderator signals to generate an interactive program that is transmitted over communication link 208 and communications links 212a and 212b to a plurality of viewer clients as exemplified by viewer clients 214a and 214b. The viewers become participants by responding to the interactive program by generating and transmitting to the moderator server a plurality of participant comment signals using the viewer clients. The participant comment signals encode the participants' commentary about the interactive program. The moderator server receives the participant comment signals and retransmits them to the moderator client where the moderator edits the participant comment signals. The moderator generates new moderator signals that are transmitted to the moderator server along with the edited participant comment signals. The moderator server uses the moderator signals and the edited user comment signals to generate additional interactive program signals that are transmitted to the viewers' clients. The process of receiving participant comment signals, editing the user comment signals, and generating new interactive program signals is repetitively performed in order to generate an interactive program incorporating viewer interactions.

In a system for creating an interactive program incorporating viewer interactions in accordance with an exemplary embodiment of the present invention, the moderator server is operably coupled to content server 216 via a communications link 218. The content server hosts a content source 220 including content suitable for broadcast by the moderator server. Such content may include past broadcast programs that the moderator is using as a topic for further discussion within the audience. The moderator instructs the moderator server to request and receive content signals from the content server and the moderator server generates an interactive program including the content signals. In this way, non-interactive content may be enhanced with an interactive component thus leveraging non-interactive content by creating an interactive program using content without an interactive component. In another embodiment of enhanced content, the content is synchronized with the interactive component and the content is transmitted to the viewer client from a server other than the moderator server in program synchronous fashion.

In a system for creating an interactive program incorporating viewer interactions in accordance with an exemplary embodiment of the present invention, the moderator server hosts software facilities for the moderator to use in generating an interactive program. The moderator server is operably coupled to a moderator database 230 including mod-

erator information describing the type of interactive program the moderator produces and the moderator's interactive program broadcast schedule. The moderator information may be used to automatically generate a dynamic programming guide thus helping viewers find the moderator's interactive program. In addition, the moderator server records viewer interaction data describing the amount, timing, and type of viewer interactions with the moderator's produced interactive programming. The moderator may access the viewer interaction data to generate reports regarding the moderator's interactive programming.

In a system for creating an interactive program incorporating viewer interactions in accordance with an exemplary embodiment of the present invention, the moderator server hosts a viewer database **232** including viewer profile information. Viewer profile information includes information about viewer preferences and viewer notification requests. The viewer preferences are used by the moderator server to suggest interactive programming generated by a moderator which may match the viewer's stated preferences. The viewer notification requests are used by the moderator server to generate viewer notifications that are transmitted to a viewer in order to notify a viewer when a specific interactive program is about to be broadcast.

In one embodiment of a viewer notification generation process in accordance with the present invention, the privacy of the viewer is protected by not allowing the moderator access to viewer profiles. For example, the moderator may initiate a notification process but the moderator is never allowed to see to which viewers the notifications are sent. In addition, any viewership reports generated on behalf of a moderator use aggregate data for the viewers so that the viewers' identifications are not associated with the individual viewership reports.

In a system for creating an interactive program incorporating viewer interactions in accordance with an exemplary embodiment of the present invention, the audience and moderator comment on a broadcast program over which the moderator has minimal control. In this embodiment, a broadcaster **222** transmits a broadcast media signal **224** received by a viewer's broadcast media receiver **226** and a moderator's broadcast media receiver **228**. In this embodiment, the moderator and the audience watch the broadcast program and exchange commentary about the broadcast program over the communications network as described above. In this way, non-interactive programming can be supplemented with an interactive component. Exemplary broadcast programs include broadcasts of real-time events, such as sporting events or breaking news stories, and pre-recorded programming such entertainment programs or documentaries.

FIG. 3 is a sequence diagram of a process within a system for creating an interactive program incorporating viewer interactions in accordance with an exemplary embodiment of the present invention. A moderator server **210** receives participant comments **300a** and **300b** from a plurality of viewer clients as exemplified by viewer clients **212a** and **212b**. The moderator server transmits the participant comments, **300a** and **300b**, to a moderator client **204**. A moderator uses the moderator client to edit (**302**) the participant comments and generate (**304**) moderator comments. The edited participant comments and the moderator comments **306** are transmitted to the moderator server. The moderator server uses the moderator comments and the edited participant comments to generate (**308**) viewer interactive programming, **310a** and **310b**, that is transmitted to the plurality of viewer clients and moderator interactive programming

312 that is transmitted to the moderator client. The process is repeated indefinitely to generate an interactive program with the plurality of viewer's interacting with the viewer interactive programming and the moderator using the moderator interactive programming to moderate the generation process.

In one embodiment of a system for creating an interactive program in accordance with an exemplary embodiment of the present invention, the interactive programming generated by the moderator server is stored in a moderator database for archival purposes. The interactive programming can be indexed and cataloged for generation of an archive listing describing the archived interactive programming. A viewer can then request archived interactive programming for viewing at a later time for "on-demand" viewing.

In one embodiment of a system for creating an interactive program in accordance with an exemplary embodiment of the present invention, a viewer can initiate the creation of an archive for an interactive program. As the interactive program is produced and transmitted to the viewer, the interactive program signals are stored for the viewer's own use. For example, a viewer can initiate the creation of an archive for a short period of time so that the viewer can leave the interactive program and rejoin the interactive program and be able to view the portions of the interactive program that the viewer missed. As another example, the viewer can create a personal archive of past interactive programs in a manner similar to a personal video recorder.

In another system for creating an interactive program in accordance with an exemplary embodiment of the present invention, the communications network is the Internet and the viewer clients and moderator client are Web browsers. The moderator server receives moderator and participant comment signals in the form of POST requests and generates the interactive program as an interactive electronic document written in a document markup language such as Hyper Text Markup Language (HTML) or eXtensible Markup Language (XML) that is transmitted to the viewer clients. The viewer clients parse the electronic document and generate viewer displays using the instructions in the electronic document. The viewers respond to the viewer displays by entering text and selecting elements from the viewer displays. These viewer interactions are transmitted to the moderator server by the viewer's clients in subsequent POST messages. The moderator receives a different set of interactive moderator electronic documents that implement a moderator user interface enabling the moderator to control the operations of the moderator server.

In one system for creating an interactive program in accordance with an exemplary embodiment of the present invention, the system is deployed using the Microsoft® TV platform which is a standards-based, client and server software middleware system for deploying interactive programming. The platform includes a client software application hosted by a set-top-box and a server software application operably coupled by a communications network. The client software application includes a Web browser that can be used much like a conventional Web browser and an application programming interface for building native applications that are hosted by the set-top-box. The server includes several management functions including t-commerce and client management applications.

In another system for creating an interactive program in accordance with an exemplary embodiment of the present invention, the interactive programming generated by the moderator server further includes "click-through" style ban-

ner ads for selection by a viewer. If a viewer selects a click-through banner ad, the viewer's interaction with the banner ad is recorded in a moderator database in order to generate click-through activity related to the interactive programming. The banner ads may come either from the moderator server or an ad server not affiliated with the moderator server.

FIG. 37 is a deployment diagram for a telephony system for delivery of an interactive program in accordance with an embodiment of the present invention. A previously described moderator server 210 is operably coupled via a communications network 202 to previously described viewer client 214a. A viewer 200a, views an interactive program by accessing the moderator server using the viewer client. To participate, the viewer uses a telephone device 3700 to connect to a telephony agent 3702 operably coupled to the moderator server via the communications network. In operation, the viewer uses the telephone to dial up the telephony agent. The telephony agent receives audio signals and converts the audio signals to text signals that are transmitted to the moderator server via the communications network. In turn, the moderator server reroutes the textual component signals of an interactive program to the telephony agent. The telephony agent receives the textual component signals and converts the textual component signals into audio signals for transmission to the viewer via the telephone.

In another interactive program creation system in accordance with an embodiment of the present invention, a viewer downloads and installs a custom client plug-in that allows a viewer a built-in microphone on the viewer client. Using a control panel, participants direct their questions or comments to either the virtual stage or the audience interactive message area. The spoken words are digitized by the viewer client, analyzed, translated into text form, and transmitted via the communications link to the moderator server. The question or comment then appears in the interactive program. The plug-in allows viewers to participate in an interactive program in a traditional, voice-based way if they choose to.

In another interactive program creation system in accordance with an embodiment of the present invention, the spoken words are not translated to text. Instead, the digitized voice is transmitted directly over the communications link to the moderator server such as in Voice over Internet Protocol (VoIP) transmissions.

FIG. 38 is sequence diagram for a telephony process as used by a telephony system for delivery of an interactive program in accordance with an embodiment of the present invention. A viewer uses a telephone device 3700 to send participant voice signals to a telephony agent 3702. The telephony agent converts 3802 the participant voice signals to text in a speech-to-text conversion process. The textual participant comments 3804 are transmitted to the moderator server. The textual participant comments are used to generate 3806 viewer interactive programming signals 3808 in a to-be-described process. The moderator server transmits the viewer interactive programming signals to the viewer client and transmits a second set of viewer interactive programming signals 3810 to the telephony agent. The telephony agent converts 3812 the textual portions of the viewer interactive programming to signals for an audio version of the viewer interactive programming 3814 in a text to speech conversion process. In this way, a viewer can participate in an interactive program using a telephone device for the generation of viewer interaction signals.

In another telephony process as used by a telephony system for delivery of an interactive program in accordance with an embodiment of the present invention, the video components of the interactive program are dispensed with and the participant interacts with the textual components of the interactive program using the telephone device. In this way, an interactive program can be created by a moderator with only textual or audio and textual components that is accessible to a participant using only a telephone device.

FIG. 27 is a collaboration diagram depicting an interactive programming generation process in accordance with an exemplary embodiment of the present invention. A moderator server 210 includes a virtual stage content engine 2702 and an audience content engine 2704. These content engines generate content, such as the content for a chat room, and transmit the content to an interactive program generator 2706 included in the moderator server. The virtual stage content engine receives previously described moderator comments and edited participant comments 306 from the previously described moderator client. The virtual stage content engine uses the moderator's comments and edited participant comments to generate moderator content for a to-be-described stage section or area in an interactive program. The audience content engine receives previously described participant comments, 300a and 300b, from the previously described viewer clients, 212a and 212b, edited participant comments and moderator comments 306 from the moderator client, and uses the participant comments, edited participant comments, and moderator comments to generate audience content for a to-be-described audience section or area in an interactive program.

The interactive program generator receives the moderator content and the audience content and uses the content to generate enhanced interactive programming. The interactive programming includes viewer interactive programming 310a and 310b that is transmitted to the viewer clients for display and use of the viewers. The interactive programming further includes moderator interactive programming 312 transmitted to the moderator for viewing and use by the moderator. The cycle of receiving participant, moderator and edited participant comments and using the comments to generate interactive programming for transmission to the moderator and viewer is repeated indefinitely to create a continuous interactive program.

In an interactive program creation system in accordance with an exemplary embodiment of the present invention, content 2708 from a previously described content server 216 is received by the interactive program generator and the content is included in the generated interactive programming. In an interactive program creation system in accordance with another exemplary embodiment of the present invention, a virtual guest client 2710 transmits virtual guest comments 2712 to the virtual stage content engine for inclusion in the virtual stage content generated by the virtual content engine.

In an interactive program creation system in accordance with another exemplary embodiment of the present invention, the moderator, participant, and guest interactive messages are chat messages and the virtual stage and audience content engines are chat engines. The text-based output from the chat engines is used by the interactive program generator generate interactive programming including electronic documents, such as transcripts, composed in a document markup language such as HTML or XML.

FIG. 30 is a process flow diagram of an interactive program generation process in accordance with an exemplary embodiment of the present invention. A moderator

server receives (3000) moderator commentary and edited participant commentary 3001 from a moderator. The moderator server receives (3002) participant commentary 3003 from viewers in an audience. The moderator server uses the participant commentary, the moderator commentary, and the edited participant commentary to generate (3004) viewer interactive programming 3006 for transmission to viewers in the audience. The moderator server uses the moderator commentary and the edited participant commentary to generate (3008) moderator interactive programming 3010 for transmission to the moderator. The moderator then transmits (3012) the moderator interactive programming to the moderator and the viewer interactive programming to the viewers in an audience. The process is repeated (3014) continuously to generate an interactive program.

FIG. 4 is a screen capture of a moderator interface used to control generation of an interactive program in accordance with an exemplary embodiment of the present invention. A moderator's interface 400 includes a trademark field 402 for display of a moderator server operator's trademark, in this screen capture, talkshow.comSM is a service mark of Lakeview Capital Trust, a Pennsylvania Trust. The moderator interface has a moderator identification field 404 for the display of the moderator's identification and an interactive program identifier field 406 for identification of the interactive program being produced by the moderator.

In one embodiment of a moderator server in accordance with the present invention, the moderator server is operated in an application service provider (ASP) mode. In this mode, the moderator server is used to create a "private label" interactive program creation system. In this mode, the moderator server provides services that an operator can embed into another system such that a viewer perceives the interactive program creation system as being owned by individual operators. In some instances an indication of source, such as a "powered by" notice, is included in the interactive program creation system.

The moderator's interface is broken up into several operational sections. A "stage interaction" section 410 displays the moderator's direct interaction with a virtual guest on a virtual stage. The stage interaction section includes a plurality of fields for display of virtual guests' previous questions as exemplified by previous question field 412. For each answered virtual guest question, a moderator response field, as exemplified by moderator response held 414, displays the moderator's response to the virtual guest's previous question. The stage interaction section further includes a current question field 416 for display of a virtual guest's current question. A moderator uses a moderator text entry section 418 to enter responses to the current virtual guest question.

An audience interaction section 420 displays audience comments. The audience interaction comments 422 are comments made by participants to other participants in the audience.

A moderator uses a status section 423 to monitor the progress of the interactive program. The moderator invites audience members to the virtual stage to be virtual guests using an "invite to stage" selector 426. The moderator can select a viewer to invite on to the virtual stage by using a pull down menu of viewer names and selecting a viewer to invite. Once a viewer is invited to the virtual stage, the viewer's interactive messages are displayed in the stage interaction section and not in the audience interaction section. The moderator can also exclude a participant by selecting a participant from a "kick user out" pull down menu 428. Once excluded, the moderator server removes the excluded participant's comment signals from the plurality of

participant comment signals edited by the moderator and used by the moderator server to generate the interactive program. In this way, the moderator exercises direct control over the participants participating in the interactive program.

In another interactive program creation system, the participant's exchange video clips and files directly with each other in a peer-to-peer relationship. In this mode, the moderator server is not directly involved in the message exchanges occurring between audience members interacting with each other.

The status section further includes an audience approval system indicator 430 for indicating to the moderator how the audience feels about the progress of the show. Viewer responses are aggregated in a to-be-described process and displayed to the moderator as a colored indicator and as a numerical value. A moderator uses the audience member counter field 432 and pull down menu to determine the number and identification of the viewers receiving the transmitted interactive program. The status section further includes an elapsed time field 433 for display of the elapsed time of the interactive program.

An audience question section 434 displays an audience question 436 that the moderator may answer by selecting an answer question button 438 or delete by selecting a delete question button 440. The moderator can get a new audience question by selecting the update button 442.

A polls section 444 includes a poll question display field 446 for display of a current poll question and a poll results display field 448 for display of viewer's responses to the poll. The moderator selects a new poll button 450 to enter a new poll question whenever the moderator feels that a new poll should be created.

FIG. 34 is a participant question filtering moderator interface in accordance with an exemplary embodiment of the present invention. A participant question filtering interface 3400 includes a keyword entry field 3402 for entry of keywords that the moderator would like to have included by viewers in questions sent to the moderator. Questions with the entered keywords will be given a higher relevance, and thus priority, than questions without the keywords. The participant question filtering interface further includes an "exclude" entry field 3404 for words which the moderator does not want to see in questions, such as expletives or vulgarities. Any participant question having an excluded word will be deleted from a participant question queue managed by the moderator. The participant question filtering interface further includes a facility for setting a relevance threshold 3406. A moderator uses the relevance threshold setting facility to establish a threshold relevance value that a question should have before the question will be added to the question queue.

FIG. 35 is an illustration of the operation of a participant question filtering facility in accordance with an exemplary embodiment of the present invention. A participant question 3500 is processed in a participant question filter 3502 and assigned a relevance value 3504. A moderator uses the relevance value to determine which participant questions the moderator would like to answer. If a participant question 3506 has an excluded word, then the relevance of the participant question is assigned a value 3508 of 0 and deleted 3510 from a participant question queue. In one embodiment of a participant question filter in accordance with the present invention, the participant question is deleted if the participant question's relevance value does not exceed the threshold relevance value set by the moderator. A moderator uses the participant question filtering facility in order to process large numbers of participant questions

without becoming overwhelmed and to filter out offensive participant questions. This allows the moderator to automatically moderate an interactive program having a large number of participants, thus facilitating scalability from few participants to many participants.

FIG. 36 is a process flow diagram of a participant question filter process in accordance with an embodiment of the present invention. The filter process receives (3600) a participant question 3601. The filter process attempts to match (3602) words in the participant question with the moderator's excluded words 3603. If it is determined (3604) that an excluded word is in the question, the relevance of the participant question is set (3606) to a value below the moderator's previously described threshold relevance value 3607.

If no excluded words are found in the participant question, the filter process determines (3608) the relevance of the participant question by matching the moderator's keywords 3609 to the words in the participant question. If it is determined (3610) that the relevance of the participant question exceeds the threshold relevance value, then the participant question is added (3612) to a participant question queue 3614.

In an embodiment of a filtering process in accordance with the present invention, keywords and excluded words are matched to the participant question using approximate string matching techniques in order to determine the relevance value of a participant question including misspelled keywords or excluded words.

FIG. 5 is a screen capture of a viewer interface used to view and interact with an interactive program in accordance with an exemplary embodiment of the present invention. The viewer interface 500 includes an interactive program identifier field 502 for display of the name of the interactive program being viewed by the viewer. A content display section 504 is included for display of a content portion of the interactive program. The content of an interactive program may be text-based, audio-based, or video-based in any combination dependent on the capabilities and desires of the moderator. An audience interactive message section 506 is included for display of audience interactive messages that the audience is exchanging amongst themselves. An interactive message entry field 508 is used by the viewer to enter interactive messages for display in the audience interactive message section and to interact with the moderator when the moderator invites the viewer onto the virtual stage.

A poll section 510 displays a poll question 511 asked by the moderator of the viewers. The poll section includes a plurality of response buttons, exemplified by response buttons 512 and 514, selectable by the viewer to indicate the viewer's response to the poll. The viewer selects an answer to the poll question by selecting one of the response buttons and then selects the "Vote!" button 516 to register the viewer's poll answer with the moderator server. The viewer interface further includes sections for banner advertising 518 and for placement of a trademark or service mark 520 to identify the operator of the moderator server. By allowing banner ads, the moderator server allows a moderator to collect revenue from t-commerce interactions with the moderator's hosted interactive program.

In another embodiment of an interactive program creation system in accordance with the present invention, a poll is created using a plurality of participant questions for selection by participants. The participant question from the plurality of participant questions receiving the most participant selections is selected for submission to the moderator.

Referring again to FIG. 4, a current audience approval system rating field 430 is provided for the display of viewer's rating of an interactive program. Referring now to FIG. 6, a diagram depicting a process for receiving viewer reactions to the interactive program and calculating an audience approval system rating for an interactive program in accordance with an exemplary embodiment of the present invention is shown. A moderator 100 generates an interactive program and transmits the interactive program to an audience 102 as previously described. The audience includes a plurality of viewers, as exemplified by viewers 600, 602 and 604. Each viewer may have a different opinion of the quality of the interactive program; therefore, each viewer is provided with an individual audience approval system button as exemplified by audience approval system buttons 606, 608, and 610. Each viewer selects an audience approval system rating button corresponding to the viewer's subjective rating of the interactive program. The selection of an audience approval system button transmits a corresponding audience approval system signal to the moderator server (not shown) thus creating a plurality of audience approval system signals for evaluation by the moderator server. The moderator server receives the plurality of audience approval system signals and uses them to generate a single audience approval system rating signal and transmits the audience approval system rating signal for display on the moderator's interface (not shown).

In an audience approval system in accordance with an exemplary embodiment of the present invention, an audience approval system signal can take on three states, 612, 614, and 616, with each state representing a viewer's subjective opinion of the interactive program. In this embodiment, the three states are mapped to the corresponding numeric values of "100", "50", and "0", with "100" representing a viewer's complete satisfaction with the interactive program, "50" representing the viewer's partial satisfaction with the interactive program, and "0" representing the viewer's complete dissatisfaction with the interactive program. Each of the plurality of audience approval system signals are mapped to one of these numeric values. These numeric values are used to generate an arithmetic mean representing the audience approval system rating of the interactive program. In the illustrated example of FIG. 6, viewer 600 rates the interactive program at "100", viewer 602 rates the interactive program at "50", and viewer 604 rates the interactive program at "100". These values are used by the moderator server to generate (618) an arithmetic mean 624 of the plurality of mapped viewer's audience approval system signals. The arithmetic mean is presented to the moderator as the audience approval system rating of the moderator's interactive program. In one audience approval system in accordance with an exemplary embodiment of the present invention, the audience approval system rating is mapped to a color, with the numeric value of "100" being represented in green, the numeric value of "50" being represented in yellow, and the numeric value of "0" being represented in red.

FIG. 7 is a use case diagram depicting ways in which a moderator may interact with a system for creating an interactive program incorporating viewer interactions in accordance with an exemplary embodiment of the present invention. A moderator 100 accesses the system in order to create (702) an interactive program. In one system for creating an interactive program incorporating viewer interactions in accordance with an exemplary embodiment of the present invention, the moderator creates a talk show that is a periodically broadcast interactive program. Creation of an

interactive program may include selecting a theme for the talk show, establishing a broadcast time, and creating a brief description of the talk show. This interactive program information is stored in a moderator database **230** (FIG. **2**). The moderator database is used by a moderator server **210** (FIG. **2**) to generate a to-be-described programming guide.

The moderator also accesses the interactive program creation system to host (**704**) an interactive program. While the moderator is hosting an interactive program, the system provides facilities **706** for audience management allowing the moderator to restrict access to an interactive program. As previously described, the system provides facilities for the moderator to block interactive messages from viewers in the audience. The system also provides a facility **708** for posting polls during the interactive program. This allows a moderator to pose questions to the audience in order to receive and aggregate viewer's opinions about various subjects during an interactive program as previously described. The system further includes facilities **710** for answering questions presented by viewers to the moderator. As previously described, a moderator can receive questions from viewers and determine whether or not to answer them. Additionally, the system provides an invitation facility **712** for inviting viewers to participate in the interactive program as a virtual guest as previously described.

The moderator may also access the interactive program creation system to perform (**714**) administrative tasks associated with moderating a periodically presented interactive program. The interactive program creation system provides facilities **718** for sending scheduling reminders to viewers about upcoming interactive programs. Such scheduling reminders may be transmitted to a viewer by email, to a viewer's personal pager, to a viewer's wireless phone, or to a viewer's personal digital assistant. The interactive program creation system also includes facilities **720** for a moderator to review metrics collected by the system on a moderator's interactive program.

FIG. **8** is a use case diagram depicting ways in which a viewer may interact with a system for creating an interactive program incorporating viewer interactions in accordance with an exemplary embodiment of the present invention. A user **800** accesses the interactive program creation system in order to search for (**802**) interactive programs. The interactive program creation system includes facilities **804** for searching the interactive program creation system for interactive programs on particular topics that the viewer may be interested in. The interactive program creation system also includes browsing facilities **806** allowing the viewer to examine an interactive program creation system directory of interactive programs in a hierarchal manner.

The viewer may also access the interactive program creation system to view **816** and become part of an interactive program. The interactive program creation system includes facilities **817** allowing a viewer to interact with embedded advertising. The interactive program creation system also includes facilities **818** allowing a moderator to poll viewers during an interactive program as previously described. The interactive program creation system also includes facilities **820** allowing a viewer to ask questions of the moderator and virtual guests as previously described. The interactive program creation system also includes facilities **822** allowing a viewer to rate an interactive program as previously described.

The viewer may also access the interactive program creation system to personalize (**808**) the viewer's experience with the interactive program creation system. The interactive program creation system includes facilities **810** for

submitting suggestions by the interactive program creation system of interactive programs the viewer may be interested in based on viewer preferences as included in a viewer profile and previously viewed interactive programs. The interactive program creation system further includes facilities **812** for creation of a list of favorite interactive programs used by moderators to send scheduling reminders to the viewer about upcoming interactive programs as previously described. The interactive program creation system also includes facilities **814** allowing a viewer to create and edit a viewer profile including topics of interest to the viewer. In one embodiment of an interactive program creation system in accordance with the present invention, viewer profiles are stored in data files on the viewer client. In another embodiment of an interactive program creator system in accordance with the present invention, viewer profiles are stored on a central server and downloaded as XML documents to the viewer client as needed.

FIG. **9** is a Web site diagram of an interactive program creation system in accordance with an exemplary embodiment of the present invention. As previously described, in one interactive program creation system in accordance with an exemplary embodiment of the present invention, a moderator server hosts a Web site for accessing interactive programs by both moderators and viewers. A user, such as a moderator or viewer, accesses the Web site via a log-in page **900**.

FIG. **29** is a screen capture of an interactive program creation system log-in interface in accordance with an exemplary embodiment of the present invention. A user selects a register button **2900** to register as either a viewer or a moderator. If the user is registering as a viewer, the user obtains a viewer identifier and a viewer password. If the user is registering as a moderator, the user obtains a moderator identifier and a moderator password. The identifiers and passwords are used by the user to access the interactive program creation system on fixture visits and can be stored in "cookies" on the client the user is using to access the interactive program creation system.

A user selects a log-in button **2902** to access the interactive program creation system as a viewer or selects a moderator log-in button **2904** to access the interactive program creation system as a moderator. The interactive program creation system log-in interface further includes an upcoming program guide section **2906** for display of interactive programs that are scheduled to be produced by their moderators in the next 24 hours. The listings in the upcoming program guide section include a previously described "mic" viewer rating **2908** and a category link **2910** to a viewer interface where a viewer can find more interactive programs similar to the listed interactive program.

Referring again to FIG. **9**, if the user logs in as a viewer, the viewer is directed to a viewer home page **902**. From the viewer home page, the viewer may access a registration process **904**. Once registered, the viewer can access an edit profile process **906**.

FIG. **10** is a screen capture of an edit profile viewer interface in accordance with an exemplary embodiment of the present invention. The edit profile viewer interface is used by a viewer to edit the viewer's personal information stored in the viewer's profile. The edit profile viewer interface includes a viewer identification field **1000** for display of the viewer's identification and a password entry field for entry of the viewer's password. In operation, a user enters a new password into the password entry field and selects a "Submit and Continue" button **1003** to change the viewer's password. The viewer's identification and password are

associated together in the user database **232** (FIG. **9**) for use by the viewer as the viewer accesses different facilities of the interactive program creation system.

The edit profile viewer interface further includes personal information entry fields, such as a first name entry field **1004** and a last name entry field **1006**. Alternatively, the viewer may enter an anonymous viewer name rather than the viewer's real name in order to hide the viewer's identity. In operation, a viewer enters their personal information and selects the "Submit and Continue" button to store the viewer's personal information in the viewer's database. The personal information is used by the interactive program creation system to personalize the viewer's experience while using the interactive program creation system.

The edit profile viewer interface further includes a viewer profile entry field **1008**. In operation, the viewer enters the viewer's interests into the viewer profile entry field. The entered viewer profile is stored in the viewer database for use by the interactive program creation system to make suggestions of interactive programs that the viewer may want to participate in. To make suggestions, the viewer profile is queried and key terms are identified. For example, the illustrated viewer profile **1010** includes the key terms "sports", "movies", and "music". The interactive program creation system compares these key terms to key terms included in the moderator database **230** (FIG. **9**) by moderators who have created interactive program profiles. If a match is found, the interactive program creation system suggests the matching interactive program to the viewer.

In an embodiment of an interactive program creation system in accordance with the present invention, interactive programs are suggested to the viewer in a "pay-for-placement" mode. For example, if a plurality of interactive programs match the viewer's profile, the first interactive program suggested to the viewer is the interactive program whose moderator has paid the interactive program creation system's operator the most for being placed first.

The edit profile viewer interface further includes a viewer email address entry field **1012**, viewer city **1016**, viewer state **1018**, viewer zipcode **1020**, and viewer country **1022** entry fields. In operation, the viewer enters their email and address location and selects the "Submit and Continue" button to store the viewer address information in the viewer database. Moderators using the interactive program creation system can use the viewer address information to notify a viewer when the moderator's interactive program is to be broadcast. Additionally, the viewer may optionally select a "Include in Directory" button **1022** in order to exclude the viewer's address information from view by the moderators.

The edit profile viewer interface further includes an interactive program search entry field **1024**. A viewer uses the search entry field to enter a search term used to search the moderator database for interactive programs with terms matching the search term. The edit profile viewer interface further includes a category or hub selection field **1026**. A viewer may select an individual category, such as "News" **1027** to be taken to a hub process for accessing interactive programs related to the selected category.

The edit profile viewer interface further includes an advertising section for display of "click-through" style banner ads. A user selects one of the banner ads to be transferred to an advertiser's or retailer's Web site. The edit profile viewer interface further includes a feature section **1030** for display of links to featured hubs. By selecting a featured hub link, a viewer can quickly access a hub process for accessing interactive programs related to the selected feature category.

FIG. **11** is a screen capture of a hub viewer interface in accordance with an exemplary embodiment of the present invention. The screen capture is of an exemplary "News" **1100** hub. Other hubs may be created for other subjects such as "home improvement" and the like. The hub includes links for accessing by the viewer, interactive programs whose themes are national news **1102**, world news **1104**, business news **1106**, sports news **1108**, weather news **1110**, and entertainment news **1112**. In operation, a viewer selects one of the links to access a specialized program guide including links to interactive programs with a theme corresponding to the link title.

Referring again to FIG. **9**, a viewer may access an interactive program electronic program guide process **908**. A viewer uses the program guide process to add upcoming interactive programs to a viewer's interactive program list that is stored in the viewer database **232**.

FIG. **12** is a screen capture of a program guide viewer interface in accordance with an exemplary embodiment of the present invention. The program guide includes a plurality of listings for interactive programs available for viewing **1200**. Each of the listings include a title and brief description field **1201**, a current subject field **1202**, a time field **1204**, and a listing selection button **1206**. In operation, a viewer reads the listing title and brief description to determine if the viewer wants to participate in the interactive program. The viewer reads the time field to determine when the next interactive program will be available, and reads the current subject field to determine what the next subject to be discussed during the interactive program will be. The viewer then selects the listing selection button and the "Add Selected to My Talk Shows" button **1208** to add the listing to a viewer's list of interactive programs that the viewer wants to participate in. The list is maintained in the viewers database **232** (FIG. **9**).

The program guide viewer interface further includes an interactive program rating **1210** display. The interactive program rating is a viewer rating determined from viewer responses to the interactive program. In a program guide in accordance with an exemplary embodiment of the present invention, the viewer rating is expressed in terms of "mics" (short for microphone). The greater the number of mics, the higher the viewer rating of the interactive program. For example, the maximum number of mics an interactive program may receive is five mics for a popular program. A minimally popular interactive program may only receive only one mic.

The program guide viewer interface further includes a link to an interactive program suggestion **1212** process. As previously described, the interactive program creation system uses a viewer's profile stored in the viewer database and interactive program descriptions stored in the moderator database to suggest interactive programs that the viewer may be interested in.

In another program guide viewer interface in accordance with an embodiment of the present invention, the viewer may also access archived programs in an "on-demand" mode. In an on-demand mode, the program guide includes previously broadcast and archived interactive programs.

Referring again to FIG. **9**, a viewer may access the previously described search facilities **910** of the interactive program creation system from the program guide. Additionally, the program guide provides a link to an immediate program guide **912** for listing interactive programs that are scheduled to be broadcast within the next day. A viewer may also access a browsing facility **914**. Using the browsing

facility, a viewer can view a hierarchal list of interactive programs from which the viewer can select an interactive program to participate in.

The viewer may access a specific interactive program's home page **916** in a variety of ways, such as: selecting a link to an interactive program from the previously described search facility **910**; immediate program guide **912**; browsing facility **914**; and suggestion facility **918**. Additionally, included in a moderator database **230** is a schedule of upcoming interactive program broadcasts. The schedule of upcoming interactive program broadcasts may be accessed by the viewer using an upcoming interactive program facility **920**. From an interactive program's home page, a viewer may join a previously described actual interactive program **922**. Each interactive program is hosted by a previously described moderator server **210**.

FIG. **28** is a screen capture of an interactive program home viewer interface in accordance with an exemplary embodiment of the present invention. An interactive program home viewer interface is generated by a moderator server using information entered by a moderator and stored in the moderator database. The interactive program home viewer interface includes an identifier field **2800** for display of an interactive program's identifier. An interactive program description field **2802** is used to display a brief description of the interactive program as described by the moderator.

The interactive program home viewer interface further includes a schedule section **2804** where the schedule of upcoming transmissions of the interactive program are listed. An upcoming listing **2805** includes a reminder button **2806**. In operation, a viewer selects the reminder button for a listing and an entry is made by the interactive program creation system to the previously described viewer profile. The entry is used to transmit notifications to the viewer when the interactive program is about to be transmitted.

The interactive program home viewer interface further includes a preference addition button **2808** that the viewer selects to have the interactive program added to the previously described viewer's list of interactive program preferences. A contact button **2810** is provided for use by a viewer in sending an email message to a moderator. A search button **2812** is provided for the viewer to search for additional interactive programs that are related thematically to the interactive program represented in the interactive program home viewer interface.

The interactive program creation system further includes a facility **926** for retrieving archived previously broadcast interactive programs for viewing. A viewer uses the archive facility to view transcripts and enhanced content of interactive programs that the viewer may have missed or wants to view again. In one facility for retrieving archived interactive programs for viewing in accordance with an exemplary embodiment of the present invention, the archived interactive programs can be viewed on an "on-demand" or "pay-for-view" basis.

In another facility for retrieving interactive programs for viewing in accordance with an exemplary embodiment of the present invention, the archived interactive programs may be accessed for presentation in conjunction with other content such as in a syndication mode. For example, an archived interactive program whose theme was discussion about a particular product can be linked to an advertisement for that product on a separate Website. As another example, an interactive program with a topical theme may be syndicated by a live news Website.

FIG. **13** is a screen capture of an interactive program archive viewer interface in accordance with an exemplary embodiment of the present invention. An archive viewer interface includes a plurality of archive listings of previously broadcast and archived interactive programs **1300** with each archive listing **1301** including a title field **1302**, a subject field **1304**, and a date field **1306**. In operation, a viewer reviews the plurality of archive listings and selects the archive listing corresponding to an archived interactive program the viewer wants to view. After selecting the archive listing of the archived interactive program, the viewer views a replay of the archived interactive program corresponding to the archive listing. In an interactive program archive viewer interface in accordance with an exemplary embodiment of the present invention, archived listings are organized by themes, such as the illustrated "The Gardening Center" **1308** that is an archive with a gardening theme. In other interactive program archive viewer interfaces in accordance with an exemplary embodiment of the present invention, an entity, such as a corporation, sponsors the archive as a form of advertising. For example, a brokerage may sponsor an archive with a financial theme or a hardware retailer may sponsor an archive with a "do-it-yourself" theme.

Referring again to FIG. **9**, the interactive program creation system further includes facilities **924** for a moderator to create an interactive program. A moderator uses the facility to create an interactive program by entering information about the interactive program and the information is stored in the moderator database **230**.

FIG. **14** is a screen capture of a moderator interface for an interactive program authoring tool in accordance with an exemplary embodiment of the present invention. The interactive program creation moderator interface includes an interactive program identifier display field **1400** for displaying the interactive program's name. A moderator uses an interactive program identifier entry field **1402** to enter the name of the interactive program. The interactive program creation moderator interface further includes a description entry field **1404** for entry by the moderator of a brief description of the interactive program and a category/genre selection menu **1408** for selection by the moderator of a category under which the interactive program will be placed. The interactive program creation moderator interface further includes a host name entry field **1406** for entry of the moderator's name. The interactive program creation moderator interface further includes a broadcast scheduling selection menu **1410**, day selection buttons **1412**, and a time selection menu **1414** for selection of the broadcast time of the interactive program. In operation, a moderator enters in an interactive program name, interactive program description, and host name. The moderator selects a category, a broadcast schedule, the days of the week the interactive program will be broadcast, the time the interactive program will be broadcast, and selects a "Submit and Continue" button **1418** to store the entered and selected interactive broadcast information in the moderator database **230** (FIG. **9**). The moderator can also select an "Include in Program Guide" button **1416** to include the interactive program information in the previously described program guide.

FIG. **39** is a screen capture of an interactive program authoring wizard in accordance with an exemplary embodiment of the present invention. Within the interactive program authoring tool is a "wizard" which allows a host/moderator to easily set up a new interactive program. A "wizard" is a software tool that guides a user through the configuration of a software application. A wizard typically

includes a set of selectable configuration templates for use by a user and a dialog that guides the user through the configuration process. The interactive program authoring wizard can operate as a stand-alone application and may be used through a Web browser. The interactive program authoring wizard features beginner, intermediate, and expert levels and offers the ease of use of other mass market authoring tools making it easy for potential moderators to get started hosting their own interactive programs. During a setup process, the moderator selects from several preset genres allowing the moderator to quickly set the look and feel of their interactive programs. For example, these presets may include formats for defining interactive programs such as a news and perspective program, sports program, business program, human interest program, do-it-yourself program, etc. The interactive program authoring tool **3900** has a "genre/theme" link **3902** selectable by the moderator to bring up a list of themes **3904** that the moderator selects from. By selecting a theme, the moderator selects a configuration for the interactive program establishing backgrounds, layouts, and interactive areas for an interactive program. The moderator selects a theme and the selects a "submit and continue" button **3906** to configure the interactive program using a themed interactive program template.

The interactive program creation moderator interface further includes a link to a broadcast schedule editing facility **1419**. A moderator uses this link to access a more detailed interactive program scheduling entry facility. The interactive program creation moderator interface further includes a link to an add co-hosts facility **1420**. A moderator uses this link to access a facility for adding a co-host or additional, but subordinate moderator, such as a side-kick, panel of experts, or special guest to the interactive program.

The interactive program creation moderator interface further includes a link to a themes facility **1422**. A moderator uses this link to access a facility for assigning the interactive program to a thematic category for easier classification of interactive programs for browsing by a viewer.

The interactive program creation moderator interface further includes a link to a send reminders facility **1424**. A moderator uses this link to access a facility for transmitting reminders to viewers. The interactive program creation system uses the previously described viewer's lists of interactive programs to send notifications to each of the viewers who have added the moderator's interactive program to their list of interactive programs. Reminders may be sent by various communication links such as email, voice mail, and pager as agreed to by the viewer.

FIG. **32** is a process flow diagram of a viewer notification process in accordance with an exemplary embodiment of the present invention. A moderator server receives (**3200**) an interactive program identifier from a moderator for which the moderator would like to transmit reminders to viewers. The moderator server reads (**3201**) viewer preferences from previously described viewer profiles **3202**. Included in a viewer's profile is a list of interactive programs for which the viewer wants to be reminded of upcoming transmissions. If the moderator server determines (**3204**) that a viewer wants to receive notifications for the identified interactive program, the moderator server generates (**3206**) a viewer notification **3208** and transmits the viewer notification to the viewer. The moderator server then determines (**3210**) if all viewers have been processed. If not, the moderator server continues searching for viewers wishing to receive notifications. The moderator server continues processing until all

viewers wishing to receive notifications of the transmission of the interactive program have been notified.

In one viewer notification process in accordance with an exemplary embodiment of the present invention, a viewer notification is transmitted as an email message to the viewer. The viewer may retrieve the email message by any suitable device or client such as a personal digital assistant, personal computer, etc. In another viewer notification process in accordance with an exemplary embodiment of the present invention, the viewer notification is in the form of an audio reminder transmitted to a viewer's voice mail system or directly to a viewer's telephone. In another viewer notification process in accordance with an exemplary embodiment of the present invention, the viewer notification is in the form of an instant message that is transmitted to a viewer if the viewer is currently on a system that is accessible to the moderator server.

Referring again to FIG. **14**, the interactive program creation moderator interface further includes a link to a traffic report facility **1462**. A moderator uses this link to access a facility for generating reports describing the user interactions with an interactive program broadcast by the moderator.

FIG. **15** is a screen capture of a moderator interface for an interactive program reporting tool in accordance with an exemplary embodiment of the present invention. In general, a moderator uses an interactive program reporting tool to specify reports generated using data recorded about viewer interaction with an interactive program broadcast and stored in the moderator database as previously described. Additionally, the interactive program reporting tool is used by a moderator to generate a report regarding viewer access of archived interactive programs so that the moderator can determine the popularity of old content that was previously broadcast. The moderator can specify reports to analyze the data in a variety of ways using a variety of data mining techniques to yield customizable, comprehensive, and flexible reports. Additionally, viewer identifications associated with the viewer interaction data can be combined with the previously described viewer profile data to generate reports on the demographics and geographic locations of the viewers participating in an interactive program. In this mode, a viewer's privacy may be protected by aggregating the viewer data or stripping viewer identifiers from any data viewable by a moderator. The reporting tool moderator interface includes a select group report menu **1500** for selecting a specific set of reports to view.

The reporting tool moderator interface further includes entry fields for selection of types and formats of viewer interaction reports. Each of these sections is typified by a selection button **1504** and a format selection pull-down menu **1506**. A moderator selects a selection button to include the specific type of report in a viewer interaction report and uses the format pull-down menu to select the format of the specific report. The types of reports the moderator can include in a viewer interaction report include a peak usage report **1504**. A peak usage report is a report indicating the peak usage of the interactive program by the viewers.

A moderator can select a total traffic report **1508**. A total traffic report is a report depicting the total number of viewers and viewer interactions with the interactive program over the broadcast time of the interactive program.

A moderator can select a breakdown by user report **1512**. A breakdown by user report is reported depicting the interactions of single viewers.

A moderator can select a breakdown by demographic report **1516**. A breakdown by demographic report is a report depicting viewer interactions by viewers fitting certain demographic descriptions.

A moderator can select a breakdown by geography report **1520**. A breakdown by geography report is a report depicting where viewers participating in an interactive program are physically located.

A moderator can select a visitor path report **1524**. A visitor path report is a report depicting where viewer's are located on a network.

A moderator can select a referral report **1528**. A referral report is a report depicting from which locations viewers have been referred from such as an external Web site, etc.

A moderator can select a polling data report **1534**. A polling data report is a report depicting the results of polls taken by a moderator during an interactive program.

A moderator can select a "clicks by a viewer" report **1538**. A clicks by a viewer report is a report depicting how many selections viewers make during an interactive program.

A moderator can select a feature utilization report **1542**. A feature utilization report is a report depicting how many different features viewers are using during an interactive program.

A moderator can select a chat or interactive messaging report **1538**. A chat or interactive messaging report is a report depicting how many interactive messages are being sent between the audience members during an interactive program.

FIG. **16** is a screen capture of a moderator interface for a viewer interaction report generated in accordance with an exemplary embodiment of the present invention. The report moderator interface includes a report selection pull down menu **1600** for immediately viewing sections of the report without having to scroll through each of the reports.

Graph **1610** is a graph of click-through activity versus time for an interactive program. During an interactive program, individual instances of viewers selecting advertising banners is recorded in the previously described moderator database associated with the time of the selection of the advertising banner. An interactive program creation system can use the recorded advertising selection events and their associated times to generate the click-through activity versus time graph.

Graph **1612** is a geographically based graph depicting the geographic location of viewers participating in an interactive program. The viewers participating in an interactive program are recorded in the previously described moderator database. Each recorded viewer's geographic location can be determined from the previously described viewer's profile or by mapping the viewer's IP address to a specific geographic location. An interactive program creation system can use the recorded viewer identifications and viewer geographic locations to generate a graphic illustrating the geographic locations of the viewers.

The viewer interactivity reports are used by a moderator to determine the effectiveness of an interactive program. For example, the moderator can use the demographic charts to determine if the interactive program is reaching an audience with the demographic profile desired by the moderator. As a further example, the moderator can determine the effectiveness of various portions of an interactive program by analyzing participant interaction with the interactive program over time. Spikes in interactive message transmissions from the participants may indicate portions of the interactive program that the participants find most engaging.

FIG. **17** is a screen capture of a moderator interface for an advertising report generated in accordance with an exemplary embodiment of the present invention. A revenue generation graphic **1702** illustrates the relative amounts of revenue generated from the viewers participating in an interactive program. As the viewers participate in the interactive programs, the viewers' interactions with links and advertising banners included in the interactive program are recorded in the moderator database as previously described. An interactive program creation system can use the recorded viewer interactions to generate a graphic showing the relative contributions to total revenue by each of several possible viewer interaction modes. For example, in the illustrated graph, comparisons are made for selection of links **1704**, selection of embedded ads **1706**, selection of banner ads **1708**, and selection of other types of ads **1710** and **1712**, as a percentage of total revenue.

An advertising geographical graphic **1716** indicates the geographic viewer locations of viewers participating with the interactive program. As the viewers participate in the interactive programs, the viewers' interactions with links and advertising banners included in the interactive program are recorded in the moderator database as previously described. Additionally, a viewer identification for each viewer interaction is stored in the moderator database. Each viewer's geographic location can be determined from the previously described viewer's profile or by mapping the viewer's IP address to a specific geographic location. An interactive program creation system can use the recorded viewer interactions and viewer identifications to generate a graphic illustrating the geographic locations of advertising revenue generation. An interactive program creation system can use viewer interaction data, viewer identification data, and viewer profile data to generate a revenue by age graphic **1718** or a revenue by demographic description graphic **1720**.

FIG. **31** is a process flow diagram of an interactive program report generation process in accordance with an exemplary embodiment of the present invention. A moderator server determines (**3100**) a set of viewer demographics for an interactive program's viewing audience by using the interactive program's history **3104** along with a set of viewer profiles **3102**. For each viewer that participated in the interactive program when the interactive program was transmitted, the moderator server extracts the individual viewer's stored viewer profile. The moderator server aggregates the individual viewer profiles to generate viewer demographics **3106** for the interactive program transmission. The moderator server generates (**3108**) a graphical representation **3110** of the viewer demographics, for example a bar graph, and adds **3112** the graphical representation to a report **3114**. The moderator server determines (**3116**) if all requested graphics have been generated. If not, the moderator selects the next graphic to generate and repeats the process thereby adding a new graphic to the report. Once all of the graphics have been added to the report, the moderator server transmits (**3118**) the report to the moderator requesting the report.

FIG. **18** is a database entity relation diagram for a moderator database in accordance with an exemplary embodiment of the present invention. The database entity relation diagram is an expression of meta data describing how the data in the viewer and moderator databases are related. The moderator database includes information used to organize interactive programs created and administered by moderators and histories of interactive programs including viewer interactions with the interactive programs. Interactive programs are organized within categories as previously described. Category information is used to create hubs

of viewer interactions. A super category **1800** is associated with many categories **1802** but each category is only associated with one super category. A category or hub is associated with many interactive message rooms **1804** which is in turn associated with many interactive message lines **1806**.
 5 A viewer profile **1808** is associated with many interactive message lines. In operation, a plurality of viewers select a category and enter an interactive message room associated with the category. Viewer submissions within an interactive message room are used to generate individual interactive
 10 message lines that are viewed by the viewers as they exchange interactive messages.

A category is associated with a plurality of polls **1810** with each poll being associated with a plurality of poll responses **1812**. A viewer profile is associated with a plurality of poll responses. In operation, viewers respond to a poll associated with a specific category and the viewers' responses are recorded in the moderator database for future analysis.

A category is associated with a plurality of interactive programs **1814** and each interactive program is associated with a plurality of interactive program broadcasts or instances **1816**. Each interactive program broadcast is associated with a plurality of reminders **1818** with each reminder being associated with a single user profile. In operation, a moderator determines an interactive programming schedule of interactive program broadcasts and generates reminders that are transmitted to viewers who have expressed an interest in being reminded of the interactive program's broadcasts.
 20

A category is associated with a plurality of message boards **1820** with each message board being associated with a plurality of message board threads **1822**. Each message board thread is associated with a plurality of message board messages **1824** with each message board message being associated with a single viewer profile. A viewer profile may be associated with a plurality of message board messages. In operation, viewers leave messages grouped into message board threads on message boards maintained by moderators. The messages may be for the moderators or may be for other viewers.
 30

Keywords **1826** are stored in the moderator database so that viewers can search for categories **1802** and links **1832** associated with the categories. Additionally, all user inputs can be indexed and tagged to become interactive triggers that are linked to interactive programs served by the moderator server. Category keywords **1828** are associated with a plurality of categories. In operation, a viewer enters a category keyword into a previously described search facility and a set of categories for use by the viewer are generated that are associated with the category keyword. Link keywords **1830** associated with links to off-site resources are also stored in the moderator database. In operation, a viewer enters a link keyword in the previously described search facility and a set of links associated with the link keyword is generated for use by the viewer.
 40

Viewer profiles are associated with a plurality of viewer histories **1834**. In operation, a viewer history is recorded of a viewer's interactions when accessing an interactive program creation system while not actually participating in an interactive program.
 60

FIG. **19** is a screen capture of a viewer interface for a non-moderator based interactive program associated with a broadcast in accordance with an exemplary embodiment of the present invention. As previously described, an interactive program can include broadcast content from a source not associated with the interactive program, such as a

broadcast from a commercial broadcaster. In this case, an interactive program includes participant commentary but may not include moderator commentary. The viewer interface for a non-moderated interactive program includes a broadcast content section **1900** for display of non-interactive broadcast content. The viewer interface for a non-moderated interactive program further includes a viewer interactive message section **1902** for display of viewer interactive messages transmitted to a moderator server (not shown). The viewer interface for a non-moderated interactive program includes a viewer interactive message entry field **1904** for entry of viewer interactive messages. In operation, a viewer views the non-interactive broadcast content, enters interactive messages into the interactive message entry field and selects the "enter" button **1906** to submit the interactive message to the moderator server. The viewer's entered interactive message is then combined with other viewers' interactive messages to generate an interactive message display that is shown in the interactive message display section.
 20

In an interactive program creation system in accordance with an embodiment of the present invention, the broadcast program is synchronized to the interactive program using synchronization signals included in the interactive program signals. In this way, an interactive program may be synchronized with an external broadcast.
 25

FIG. **20** is a screen capture of a viewer interface for a broadcast program guide in accordance with an exemplary embodiment of the present invention. The broadcast program guide viewer interface includes a date selection/display field **2000** and a time selection/display field **2002**. A viewer uses the date selection/display field and time selection/display field to select and display a date and time for which the viewer wants to view scheduled broadcasts. Scheduled broadcasts for the selected date and time are shown in a listings section **2003**. The listings section includes a broadcast channel column **2004** for display of the broadcast channel of a particular program, and a program information column **2005** for display of information about a scheduled program.
 30

A current broadcast content section **2006** includes a display of broadcast content that is currently being broadcast on a selected broadcast channel. Information about the broadcast content is shown in a broadcast content information section **2007** formatted as a televised programming guide. The broadcast information includes a broadcast channel, a title, a broadcast time, and a description, if available, of the broadcast content. If a microphone indicator **2008** is shown next to a listing of a scheduled broadcast, this indicates that the scheduled broadcast is available as an interactive program including broadcast content as previously described. In operation, a viewer can select an interactive program that is currently being broadcast and view the broadcast content in the current broadcast content section. A viewer selects a "switch to full screen" button **2012** to participate in a currently broadcast interactive program corresponding to the currently broadcast content displayed in the current broadcast content section.
 45

FIG. **21** is a screen capture of a viewer interface for an interactive program incorporating Web content in accordance with an exemplary embodiment of the present invention. A viewer initiates participation with an interactive program displayed in an interactive program reduced screen viewer interface **2100**. The reduced screen viewer interface includes a link **2101** to a Web page **2102** that includes additional information about the interactive program's theme. For example, the link may be to an eCommerce Web
 65

site where a viewer may purchase a book that is currently being discussed by a moderator and viewers participating in the interactive program. The reduced screen viewer interface includes a stage interaction section **2104** for display of interactive messages exchanged between a moderator and a virtual guest or invited viewer as previously described. The reduced screen viewer interface further includes an audience interactive message display section **2106** for display of interactive messages exchanged between viewers as previously described. The reduced screen viewer interface further includes an interactive message entry field **2108**. In operation, a viewer enters an interactive message into the interactive message entry field and selects the "Enter" button **2110** to transmit the interactive message to a moderator server (not shown) for inclusion in the stage or audience interaction display section.

The reduced screen viewer interface further includes interactive program rating buttons **2112** for viewer rating of an interactive program as previously described. In operation, a viewer selects one of the interactive program rating buttons to indicate the viewer's satisfaction with the interactive program. Viewer ratings from a plurality of viewers are aggregated together and displayed to the moderator as previously described.

A moderator uses a reduced screen viewer interface to create a contextual commerce application using all interactive program. The moderator uses the interactive program to build a community from an audience attracted to the subject matter of the interactive program, such as a product line or a series of books. The moderator then links the reduced screen viewer interface to a location where a viewer can make a purchase of a product or item related to the subject matter of an interactive program. In addition, archived interactive programs can be accessed in an "on-demand" mode to be linked to an e-commerce Website in order to have a continually available sales tool such as an "infomercial" or testimonial for a product or item.

FIG. **22** is a screen capture of a viewer interface for an interactive program incorporating Web content in accordance with another exemplary embodiment of the present invention. A viewer initiates interaction with a previously described reduced screen viewer interface **2204** for an interactive program by selecting a link **2202** included in a Web page **2200**. For example, a seller offering items on an auction site may be a moderator for an interactive program in order to discuss the offered items with participating viewers. In this case, the seller includes a link to an interactive program for which the seller serves as a moderator.

FIG. **23** is a screen capture of a viewer interface for a facility to manage a viewer's personal favorite interactive programs in accordance with an exemplary embodiment of the present invention. The personal favorite viewer interface includes a listings display section **2300** for display of one or more listings **2301**. Each listing includes a viewer rating field **2302** for display of previously described viewer ratings of an interactive program displayed in the listing. The listing further includes a name field **2304** for display of an interactive program's name, a next broadcast field **2306** for display of the interactive program's next broadcast, a reminder button **2308**, and a delete button **2310**. In operation, a viewer selects the reminder button to receive previously described reminders from a listed interactive program's moderator and selects an "update settings" button **2312** to transmit the reminder request to a moderator server (not shown). To delete an interactive program from the viewer's personal favorite list, the viewer selects the delete

button and selects the update settings button to delete a listed interactive program to delete the listed interactive program.

FIG. **24** is a screen capture of a viewer interface for a facility to suggest programs to a viewer in accordance with an exemplary embodiment of the present invention. The suggested program viewer interface includes a suggested interactive program listing section **2400**. A suggested interactive program listing includes a field for display of a previously described viewer rating **2404**, a field for display of an interactive program's name and brief description **2406**, a next broadcast field **2408** for display of an interactive program's next display time, and an "add" button **2410** for adding a listed interactive program to the viewer's list of favorite interactive programs. In operation, a viewer selects the add button for a listed interactive program and selects an "Add Selected to My interactive Programs" button **2412** to add a listed interactive program to the viewer's previously described favorite interactive program.

FIG. **25** is a deployment diagram of a process for conversion and delivery of interactive programs via an interactive television network in accordance with an exemplary embodiment of the present invention. A moderator server **210** receives participant comments and moderator content from an audience and a moderator and generates interactive program for transmission over the Internet **202** to a viewer client **212** as previously described.

The same interactive program can be transmitted over a conventional interactive television (iTV) network as well. The moderator server transmits the interactive program to an iTV server **2500** and the iTV server generates iTV content **2502** from the interactive program. The iTV content is transmitted via communications network **2504** to an iTV signal processor **2506**. The iTV signal processor receives the iTV content and uses the iTV content to generate iTV signals for transmission to an iTV enabled television **2508** for viewing by a viewer. In this mode, triggers are generated from the interactive program signals and the viewer uses the triggers to participate in the interactive program, such as through the use of tags associated with the triggers included in the iTV signals' Vertical Blanking Interval (VBI), and the viewer's comments are transmitted via a back channel **2510** to the moderator server. In this way, a viewer can use either an iTV enabled television or a viewer client to participate in an interactive program as previously described.

FIG. **33** is a deployment diagram of a locally hosted moderator server in accordance with an exemplary embodiment of the present invention. A moderator server **210** implementing the previously described interactive program creation facilities is hosted by a local host **3300**. The local host may also host the previously described moderator client **204**. In this embodiment, the locally hosted moderator server is operably coupled to a plurality of previously described viewer clients, as exemplified by viewer clients **214a** and **214b**, via previously described communications network **202**. The moderator server is further coupled to an interactive program server **3302** via the communications network. The interactive program server is operably coupled to the previously described moderator database **230** and viewer database **232**.

In operation, the locally hosted moderator server is used by a moderator to create an interactive program for transmission to the viewer clients and moderator client as previously described. In this embodiment, viewer information is stored in the viewer database, moderator information is stored in the moderator database and the moderator server and the viewer clients access the information via the interactive program server. The local host may be any type of

29

programmable device capable of bidirectional communication with other devices over a communications network. For example, the local host can be a game console, or a personal computer, or a set-top-box, etc.

FIG. 26 is a hardware architecture diagram of a data processing system suitable for use as a moderator server host in accordance with an exemplary embodiment of the present invention. A microprocessor 2600, including a Central Processing Unit (CPU) 2610, a memory cache 2620, and a bus interface 2630, is operatively coupled via a system bus 2635 to a main memory 2640 and an I/O control unit 2645. The I/O interface control unit is operatively coupled via an I/O local bus 2650 to a disk storage controller 2695, and a network communications controller 2680. A communications device 2696 is operatively coupled to the network communications controller and is adapted to allow software objects hosted by the general purpose computer to communicate via a network with other software objects.

The disk storage controller is operatively coupled to a disk storage device 2655. Computer program instructions 2697 implementing a previously described moderator server are stored on the disk storage device until the microprocessor retrieves the computer program instructions and stores them in the main memory. The microprocessor then executes the computer program instructions stored in the main memory to implement the moderator server.

Although this invention has been described in certain specific embodiments, many additional modifications and variations would be apparent to those skilled in the art. It is therefore to be understood that this invention may be practiced otherwise than as specifically described. Thus, the present embodiments of the invention should be considered in all respects as illustrative and not restrictive, the scope of the invention to be determined by any claims supportable by this application and the claims' equivalents.

What is claimed is:

1. A method for creating and transmitting interactive programming content comprising an audience portion and a stage portion, hosted by a moderator Web browser on a stage, to an audience comprising a plurality of viewer Web browsers over a wide area network, comprising:

providing an interactive program creation tool, the interactive program creation tool including a moderator interface for the moderator Web browser;

operably coupling a moderator server to the wide area network;

operably coupling a content server to the moderator server;

operably coupling the moderator Web browser to the moderator server via the wide area network;

operably coupling the plurality of viewer Web browsers to the moderator server via the wide area network;

providing the moderator interface at the moderator Web browser, the moderator interface including one or more interactive elements to enable a user of the moderator Web browser to create a look for the interactive programming content by establishing at least one of graphics, a background, a layout, and an interactive area;

receiving by the moderator server from the content server a first set of content signals;

receiving by the moderator server via the wide area network from the moderator Web browser a first set of moderator [comments] comment signals;

generating by the moderator server a first interactive electronic document [using] including content generated from the first set of content signals and moderator

30

comments generated from the first set of moderator [comments] comment signals;

transmitting by the moderator server via the wide area network to the plurality of viewer Web browsers the first interactive electronic document;

receiving viewer comment messages responsive to the first interactive electronic document and directed to the stage from any and all of the plurality of viewer Web browsers by the moderator server via the wide area network;

receiving viewer interactive messages responsive to the first interactive electronic document and directed to the audience from any of the plurality of viewer Web browsers by the moderator server via the wide area network;

transmitting by the moderator server via the wide area network to the moderator Web browser the viewer comment messages directed to the stage;

receiving edited said viewer comment messages and a second set of moderator comments by the moderator server via the wide area network from the moderator Web browser;

receiving by the moderator server from the content server a second set of content signals;

generating by the moderator server a second interactive electronic document [using] including content generated from the second set of content signals, the edited viewer comment messages, the viewer interactive messages directed to the audience, and the second set of moderator comments; and

transmitting by the moderator server via the wide area network to the plurality of viewer Web browsers the second interactive electronic document,

wherein the viewer interactive messages directed to the audience are [transmitted] displayed via the audience portion and not via the stage portion, and the edited viewer comment messages and the second set of moderator comments are [transmitted] displayed via the stage portion, to provide the interactive program at the viewer clients with the look such that the second interactive electronic document, the viewer interactive messages, the edited viewer comment messages, and the second set of moderator comments are displayed in accordance with the at least one of the established graphics, background, layout, and interactive area.

2. The method of claim 1, wherein the viewer comment messages [directed to] displayed via the stage portion further include an interactive program rating [signal] corresponding to a viewer web Browser subjective rating of the interactive programming content.

3. The method of claim 1, [wherein] further comprising: [the moderator comments further include] receiving by the moderator server a viewer exclusion signal corresponding to a specific [viewer Web browser from] one of the plurality of viewer Web browsers[.]; and

[the generating by the moderator server of the second interactive electronic document further includes using] in response to the viewer exclusion signal [to exclude the], preventing viewer comment messages received from the specific one of the plurality of viewer Web [browser] browsers from being displayed.

4. The method of claim 1, [wherein] further comprising: [the second set of moderator comments further include] receiving by the moderator server a viewer invitation signal corresponding to a specific [viewer Web browser from] one of the plurality of viewer Web browsers[, and].

[the generating by the moderator server of the second interactive electronic document further includes using the viewer invitation signal, wherein]

in response to the viewer invitation signal, inviting the specific one of the plurality of viewer Web [browser is invited] browsers to join the stage with the moderator Web browser [by the viewer invitation signal,]; and

[corresponding ones of the] *displaying* viewer interactive messages [directed to the audience of] *from* the specific one of the plurality of viewer Web [browser are transmitted] *browsers* via the stage portion when the specific one of the plurality of viewer Web [browser] *browsers* is on the stage.

5. A method for creating and transmitting an interactive program comprising an audience portion and a stage portion, hosted by a moderator client on a stage, to an audience comprising a plurality of viewer clients over a communications network, comprising:

providing an interactive program creation tool, the interactive program creation tool including a moderator interface for the moderator client;

operably coupling the moderator client to a moderator server via the communications network;

operably coupling the plurality of viewer clients to the moderator server via the communications network;

providing the moderator interface at the moderator client, the moderator interface including one or more interactive elements to enable a user of the moderator client to create a look for the interactive program by establishing at least one of graphics, a background, a layout, and an interactive area;

receiving participant comment signals *corresponding to participant comments* directed to the stage from any and all of the plurality of viewer clients by the moderator server via the communications network;

receiving audience interactive signals *corresponding to audience interactive messages* directed to the audience from any of the plurality of viewer clients by the moderator server via the communications network;

transmitting by the moderator server via the communications network to the moderator client the participant comment signals directed to the stage;

receiving edited participant comment signals and moderator signals by the moderator server via the communications network from the moderator client;

generating interactive program signals by the moderator server using the edited participant comment signals, the audience interactive signals [directed to the audience], and the moderator signals; and

transmitting by the moderator server via the communications network to the plurality of viewer clients the interactive program signals,

wherein the *audience interactive messages corresponding to the audience interactive signals [directed to the audience] are [transmitted] displayed* via the audience portion *and not via the stage portion*, and *edited participant comment messages corresponding to the edited participant comment signals and moderator comments corresponding to the moderator signals are*

[transmitted] *displayed* via the stage portion, *to provide the interactive program at the viewer clients with the look such that the audience interactive messages corresponding to the audience interactive signals, the edited participant comment messages corresponding to the edited participant comment signals, and the moderator comments corresponding to the moderator sig-*

nals are displayed in accordance with the at least one of the established graphics, background, layout, and interactive area.

6. The method of claim 5, wherein the generating of the interactive program signals further includes:

receiving content signals by the moderator server from a content server; and

generating by the moderator server the interactive program signals using the content signals, the edited participant comment signals, the audience interactive signals [directed to the audience], and the moderator signals.

7. The method of claim 5, wherein the participant comment signals [directed to the stage] further include an interactive program rating signal corresponding to a viewer client subjective rating of the interactive program.

8. The method of claim 5, wherein the moderator signals further include a viewer exclusion signal corresponding to a specific [viewer client from] one of the plurality of viewer clients, and

the generating of the interactive program signals further includes using the viewer exclusion signal to exclude the participant comments received from the specific one of the plurality of viewer [client] *clients*.

9. The method of claim 5, wherein the moderator signals further include a viewer invitation signal corresponding to a specific [viewer client from] one of the plurality of viewer clients, and

the generating of the interactive program signals further includes using the viewer invitation signal, wherein the specific one of the plurality of viewer [client] *clients* is invited to join the stage with the moderator client [by] *in response to the viewer invitation signal*, and *audience interactive messages* corresponding ones of the audience interactive signals [directed to the audience] of the specific viewer client are [transmitted] *displayed* via the stage portion when the specific one of the plurality of viewer [client] *clients* is on the stage.

10. A moderator server for creating and transmitting an interactive program comprising an audience portion and a stage portion, hosted by a moderator Web browser on a stage, to an audience comprising a plurality of viewer Web browsers, the plurality of viewer Web browsers, the moderator Web browser, and a content server being operably coupled to the moderator server via a wide area network, the moderator server comprising:

a processor; and

a memory operably coupled to the processor and having program instructions stored therein, the processor being operable to execute the program instructions, the program instructions including:

providing an interactive program creation tool, the interactive program creation tool including a moderator interface for the moderator Web browser;

providing the moderator interface at the moderator Web browser, the moderator interface including one or more interactive elements to enable a user of the moderator Web browser to create a look for the interactive program by establishing at least one of graphics, a background, a layout, and an interactive area;

receiving by the moderator server from the content server a first set of content signals;

receiving by the moderator server via the wide area network from the moderator Web browser a first set of moderator [comments] *comment signals*;

33

generating by the moderator server a first interactive electronic document [using] *including content generated from the first set of content signals and moderator comments generated from the first set of moderator [comments] comment signals;* 5
 transmitting by the moderator server via the wide area network to the plurality of viewer Web browsers the first interactive electronic document;
 receiving viewer comment messages responsive to the first interactive electronic document and directed to 10
 the stage from any and all of the plurality of viewer Web browsers by the moderator server via the wide area network;
 receiving viewer interactive messages responsive to the first interactive electronic document and directed to 15
 the audience from any of the plurality of viewer Web browsers by the moderator server via the wide area network;
 transmitting by the moderator server via the wide area network to the moderator Web browser the viewer 20
 comment messages directed to the stage;
 receiving edited said viewer comment messages and a second set of moderator [comments] *comment signals* by the moderator server via the wide area network from the moderator Web browser; 25
 receiving by the moderator server from the content server a second set of content signals;
 generating by the moderator server a second interactive electronic document [using] *including content generated from the second set of content signals, the 30
 edited viewer comment messages, the viewer interactive messages directed to the audience, and the second set of moderator comments; and*
 transmitting by the moderator server via the wide area network to the plurality of viewer Web browsers the 35
 second interactive electronic document,
 wherein the viewer interactive messages directed to the audience are [transmitted] *displayed* via the audience portion *and not via the stage portion*, and the edited 40
 viewer comment messages and the second set of moderator comments are [transmitted] *displayed* via the stage portion, *to provide the interactive program at the viewer Web browsers with the look such that the second interactive electronic document, the viewer interactive messages, the edited viewer com- 45
 ment messages, and the second set of moderator comments are displayed in accordance with the at least one of the established graphics, background, layout, and interactive area.*

11. The moderator server of claim 10, wherein the viewer 50
 comment messages [directed to] *displayed* via the stage portion further include an interactive program rating [signal] corresponding to a viewer web Browser subjective rating of the interactive program.

12. The moderator server of claim 10, [wherein] *further 55
 comprising:*

receiving by the moderator [comments further include] server a viewer exclusion signal corresponding to a specific [viewer Web browser from] one of the plurality of viewer Web browsers[.]; and 60
 [the program instructions for the generating by the moderator server of the second interactive electronic document further include using] *in response to the viewer exclusion signal[to exclude], preventing the viewer comment messages received from the specific one of the plurality of viewer Web [browser] browsers from being displayed.* 65

34

13. The moderator server of claim 10, [wherein] *further comprising:*

[the second set of moderator comments further include] *receiving by the moderator server a viewer invitation signal corresponding to a specific [viewer Web browser from] one of the plurality of viewer Web browsers[, and];*

[the program instructions for the generating by the moderator server of the second interactive electronic document further include using the viewer invitation signal, wherein]

in response to the viewer invitation signal, inviting, by the moderator server, the specific one of the plurality of viewer Web [browser is invited] browsers to join the stage with the moderator Web browser[by the viewer invitation signal.]; and

[corresponding ones of] *displaying the viewer interactive messages [directed to the audience of] from the specific one of the plurality of viewer Web [browser are transmitted] browsers via the stage portion when the specific one of the plurality of viewer Web [browser] browsers is on the stage.*

14. A data processing system adapted for creating and transmitting an interactive program comprising an audience portion and a stage portion, hosted by a moderator client on a stage, to an audience comprising a plurality of viewer clients via a communications network, the data processing system comprising a moderator server, the moderator server comprising:

a processor; and

a memory operably coupled to the processor and having program instructions stored therein, the processor being operable to execute the program instructions, the program instructions including:

providing an interactive program creation tool, the interactive program creation tool including a moderator interface for the moderator client;

providing the moderator interface at the moderator client, the moderator interface including one or more interactive elements to enable a user of the moderator client to create a look for the interactive program by establishing at least one of graphics, a background, a layout, and an interactive area;

receiving participant comment signals corresponding to participant comments directed to the stage from any and all of the plurality of viewer clients by the moderator server via the communications network;
receiving audience interactive signals corresponding to audience interactive messages directed to the audience from any of the plurality of viewer clients by the moderator server via the communications network;

transmitting by the moderator server via the communications network to the moderator client the participant comment signals[directed to the stage];

receiving edited participant comment signals and moderator signals by the moderator server via the communications network from the moderator client;

generating interactive program signals by the moderator server using the edited participant comment signals, the audience interactive signals [directed to the audience], and the moderator signals; and

transmitting by the moderator server via the communications network to the plurality of viewer clients the interactive program signals,

wherein the audience interactive messages corresponding to the audience interactive signals [directed to the

35

audience] are [transmitted] displayed via the audience portion and not via the stage portion, and edited participant comment messages corresponding to the edited participant comment signals and moderator comments corresponding to the moderator signals are [transmitted] displayed via the stage portion, to provide the interactive program at the viewer clients with the look such that the audience interactive messages corresponding to the audience interactive signals, the edited participant comments corresponding to the edited participant comment signals, and the moderator comments corresponding to the moderator signals are displayed in accordance with the at least one of the established graphics, background, layout, and interactive area.

15. The data processing system of claim 14, wherein the program instructions for the generating of the interactive program signals further include:

receiving content signals by the moderator server from a content server; and
generating by the moderator server the interactive program signals using the content signals, the edited participant comment signals, the audience interactive signals [directed to the audience], and the moderator signals.

16. The data processing system of claim 14, wherein the participant comment signals [directed to the stage] further include an interactive program rating signal corresponding to a viewer [client] subjective rating of the interactive program.

17. The data processing system of claim 14, wherein the moderator signals further include a viewer exclusion signal corresponding to a specific [viewer client from] one of the plurality of viewer clients, and the program instructions for the generating of the interactive program signals further include using the viewer exclusion signal to exclude the participant comments received from the specific one of the plurality of viewer [client] clients.

18. The data processing system of claim 14, wherein the moderator signals further include a viewer invitation signal corresponding to a specific [viewer client from] one of the plurality of viewer clients, and

the program instructions for the generating of the interactive program signals further include using the viewer invitation signal, wherein

the specific one of the plurality of viewer [client] clients is invited to join the stage with the moderator client [by] in response to the viewer invitation signal, and audience interactive messages corresponding [ones of the] to audience interactive signals [directed to the audience of] from the specific one of the plurality of viewer [client] clients are [transmitted] displayed via the stage portion when the specific one of the plurality of viewer [client] clients is on the stage.

19. A method for creating and transmitting interactive programming content comprising an audience portion and a stage portion, hosted by a moderator client on a stage, to an audience comprising a plurality of viewer clients over a communication network, comprising:

providing an interactive program creation tool, the interactive program creation tool including a moderator interface for the moderator client;
operably coupling a moderator server to the communication network;
operably coupling a content server to the moderator server;

36

operably coupling the moderator client to the moderator server via the communication network;

providing the moderator interface at the moderator client, the moderator interface including one or more interactive elements to enable a user of the moderator client to create a look for the interactive programming content by establishing at least one of graphics, a background, a layout, and an interactive area;

receiving by the moderator server from the content server a first set of content signals;

receiving by the moderator server via the communication network from the moderator client a first set of moderator comment signals;

generating by the moderator server a first content including content generated from the first set of content signals and moderator comments generated from the first set of moderator comment signals;

transmitting by the moderator server via the communication network to the plurality of viewer clients the first content;

receiving viewer comment messages responsive to the first content and directed to the stage from any and all of the plurality of viewer clients by the moderator server via the communication network;

receiving viewer messages responsive to the first content and directed to the audience from any of the plurality of viewer clients by the moderator server via the communication network;

transmitting by the moderator server via the communication network to the moderator client the viewer comment messages directed to the stage;

receiving edited said viewer comment messages and a second set of moderator comments by the moderator server via the communication network from the moderator client;

receiving by the moderator server from the content server a second set of content signals;

generating by the moderator server a second content using the second set of content signals, the edited viewer comment messages, the viewer messages directed to the audience, and the second set of moderator comments; and

transmitting by the moderator server via the communication network to the plurality of viewer clients the second content,

wherein the viewer messages directed to the audience are displayed via the audience portion and not via the stage portion, and the edited viewer comment messages and the second set of moderator comments are displayed via the stage portion, to provide the interactive programming content at the viewer clients with the look such that the second content, the viewer messages, the edited viewer comment messages, and the second set of moderator comments are displayed in accordance with the at least one of the established graphics, background, layout, and interactive area.

20. The method of claim 19, wherein the viewer comment messages directed to the stage further include an interactive program rating corresponding to a viewer rating of the interactive programming content.

21. The method of claim 19, further comprising:
receiving by the moderator server a viewer exclusion signal corresponding to a specific one of the plurality of viewer clients; and

in response to the viewer exclusion signal, preventing, by the moderator server, viewer comment messages

37

received from the specific one of the plurality of viewer clients from being displayed.

22. The method of claim 19, further comprising:

receiving by the moderator server a viewer invitation signal corresponding to a specific one of the plurality of viewer clients;

in response to the viewer invitation signal, inviting, by the moderator server, the specific one of the plurality of viewer clients to join the stage with the moderator client; and

displaying viewer messages from the specific one of the plurality of viewer clients via the stage portion when the specific one of the plurality of viewer clients is on the stage.

23. A method for creating and transmitting an interactive program comprising an audience portion and a stage portion, hosted by a moderator client on a stage, to an audience comprising a plurality of viewer clients over a communications network, comprising:

providing an interactive program creation tool, the interactive program creation tool including a moderator interface for the moderator client;

operably coupling the moderator client to a moderator server via the communications network;

providing the moderator interface at the moderator client, the moderator interface including one or more interactive elements to enable a user of the moderator client to create a look for the interactive program by establishing at least one of graphics, a background, a layout, and an interactive area;

receiving participant comment signals corresponding to participant comments directed to the stage from any and all of the plurality of viewer clients by the moderator server via the communications network;

receiving audience interactive signals corresponding to audience interactive messages directed to the audience from any of the plurality of viewer clients by the moderator server via the communications network;

transmitting by the moderator server via the communications network to the moderator client the participant comment signals;

receiving edited participant comment signals and moderator signals by the moderator server via the communications network from the moderator client;

generating interactive program signals by the moderator server using the edited participant comment signals, the audience interactive signals, and the moderator signals; and

transmitting by the moderator server via the communications network to the plurality of viewer clients the interactive program signals,

wherein the audience interactive messages corresponding to the audience interactive signals are displayed via the audience portion and not via the stage portion, and edited participant comments corresponding to the edited participant comment signals and moderator comments corresponding to the moderator signals are displayed via the stage portion, to provide the interactive program at the viewer clients with the look such that the audience interactive messages corresponding to the audience interactive signals, the edited participant comments corresponding to the edited participant comment signals, and the moderator comments corresponding to the moderator signals are displayed in accordance with the at least one of the established graphics, background, layout, and interactive area.

38

24. The method of claim 23, wherein the generating of the interactive program signals further includes:

receiving content signals by the moderator server from a content server; and

generating by the moderator server the interactive program signals using the content signals, the edited participant comment signals, the audience interactive signals, and the moderator signals.

25. The method of claim 23, wherein the participant comment signals further include an interactive program rating signal corresponding to a viewer rating of the interactive program.

26. The method of claim 23, wherein the moderator signals further include a viewer exclusion signal corresponding to a specific one of the plurality of viewer clients, and

the generating of the interactive program signals further includes using the viewer exclusion signal to exclude the participant comments received from the specific one of the plurality of viewer clients.

27. The method of claim 23, wherein the moderator signals further include a viewer invitation signal corresponding to a specific viewer client from the plurality of viewer clients, and

the generating of the interactive program signals further includes using the viewer invitation signal, wherein the specific one of the plurality of viewer clients is invited to join the stage with the moderator client by the viewer invitation signal, and

viewer messages from the specific one of the plurality of viewer clients are displayed via the stage portion when the specific one of the plurality of viewer clients is on the stage.

28. A moderator server for creating and transmitting an interactive program comprising an audience portion and a stage portion, hosted by a moderator client on a stage, to an audience comprising a plurality of viewer clients, the plurality of viewer clients, the moderator client, and a content server being operably coupled to the moderator server via a communication network, the moderator server comprising:

a processor; and

a memory operably coupled to the processor and having program instructions stored therein, the processor being operable to execute the program instructions, the program instructions including:

providing an interactive program creation tool, the interactive program creation tool including a moderator interface for the moderator client;

providing the moderator interface at the moderator client, the moderator interface including one or more interactive elements to enable a user of the moderator client to create a look for the interactive program by establishing at least one of graphics, a background, a layout, and an interactive area;

receiving by the moderator server from the content server a first set of content signals;

receiving by the moderator server via the communication network from the moderator client a first set of moderator comment signals;

generating by the moderator server a first content including content generated from the first set of content signals and moderator comments generated from the first set of moderator comment signals;

transmitting by the moderator server via the communication network to the plurality of viewer clients the first content;

receiving viewer comment messages responsive to the first content and directed to the stage from any and all of the plurality of viewer clients by the moderator server via the communication network;

receiving viewer messages responsive to the first content and directed to the audience from any of the plurality of viewer clients by the moderator server via the communication network;

transmitting by the moderator server via the communication network to the moderator client the viewer comment messages directed to the stage;

receiving edited said viewer comment messages and a second set of moderator comments by the moderator server via the communication network from the moderator client;

receiving by the moderator server from the content server a second set of content signals;

generating by the moderator server a second content using the second set of content signals, the edited viewer comment messages, the viewer messages directed to the audience, and the second set of moderator comments; and

transmitting by the moderator server via the communication network to the plurality of viewer clients the second content,

wherein the viewer messages directed to the audience are displayed via the audience portion and not via the stage portion, and the edited viewer comment messages and the second set of moderator comments are displayed via the stage portion, to provide the interactive program at the viewer clients with the look such that the second content, the viewer messages, the edited viewer comment messages, and the second set of moderator comments are displayed in accordance with the at least one of the established graphics, background, layout, and interactive area.

29. The moderator server of claim 28, wherein the viewer comment messages directed to the stage portion further include an interactive program rating corresponding to a viewer rating of the interactive program.

30. The moderator server of claim 28, wherein the moderator comment signals further include a viewer exclusion signal corresponding to a specific one of the plurality of viewer clients, and the program instructions for the generating by the moderator server of the second content further include, in response to the viewer exclusion signal, preventing the viewer comment messages received from the specific one of the plurality of viewer clients from being displayed.

31. The moderator server of claim 28, wherein the second set of moderator comment signals further include a viewer invitation signal corresponding to a specific one of the plurality of viewer clients, and the program instructions for the generating by the moderator server of the second content further include, in response to the viewer invitation signal, inviting the specific one of the plurality of viewer clients is to join the stage with the moderator client, and displaying viewer messages from the specific one of the plurality of viewer clients via the stage portion when the specific one of the plurality of viewer clients is on the stage.

32. A data processing system adapted for creating and transmitting an interactive program comprising an audience portion and a stage portion, hosted by a moderator client on a stage, to an audience comprising a plurality of viewer

clients via a communications network, the data processing system comprising a moderator server, the moderator server comprising:

- a processor; and
- a memory operably coupled to the processor and having program instructions stored therein, the processor being operable to execute the program instructions, the program instructions including:
 - providing an interactive program creation tool, the interactive program creation tool including a moderator interface for the moderator client;
 - providing the moderator interface at the moderator client, the moderator interface including one or more interactive elements to enable a user of the moderator client to create a look for the interactive program by establishing at least one of graphics, a background, a layout, and an interactive area;
 - receiving participant comment signals corresponding to participant comments directed to the stage from any and all of the plurality of viewer clients by the moderator server via the communications network;
 - receiving audience interactive signals corresponding to audience interactive messages directed to the audience from any of the plurality of viewer clients by the moderator server via the communications network;
 - transmitting by the moderator server via the communications network to the moderator client the participant comment signals;
 - receiving edited said participant comment signals and moderator signals by the moderator server via the communications network from the moderator client;
 - generating interactive program signals by the moderator server using the participant comment signals, the edited participant comment signals, the audience interactive signals directed to the audience, and the moderator signals; and
 - transmitting by the moderator server via the communications network to the plurality of viewer clients the interactive program signals,

wherein the audience interactive message corresponding to the audience interactive signals are displayed via the audience portion and not via the stage portion, and edited participant comments corresponding to the edited participant comment signals and moderator comments corresponding to the moderator signals are displayed via the stage portion, to provide the interactive program at the viewer clients with the look such that the audience interactive messages corresponding to the audience interactive signals, the edited participant comments corresponding to the edited participant comment signals, and the moderator comments corresponding to the moderator signals are displayed in accordance with the at least one of the established graphics, background, layout, and interactive area.

33. The data processing system of claim 32, wherein the program instructions for the generating of the interactive program signals further include:

- receiving content signals by the moderator server from a content server; and
- generating by the moderator server the interactive program signals using the content signals, the edited participant comment signals, the audience interactive signals, and the moderator signals.

34. The data processing system of claim 32, wherein the participant comment signals further include an interactive program rating signal corresponding to a viewer rating of the interactive program.

41

35. The data processing system of claim 32, wherein the moderator signals further include a viewer exclusion signal corresponding to a specific one of the plurality of viewer clients, and the program instructions for the generating of the interactive program signals further include using the viewer exclusion signal to exclude the participant comments received from the specific one of the plurality of viewer clients.

36. The data processing system of claim 32, wherein the moderator signals further include a viewer invitation signal corresponding to a specific viewer client from the plurality of viewer clients, and the program instructions for the generating of the interactive program signals further include using the viewer invitation signal, wherein the specific one of the plurality of viewer clients is invited to join the stage with the moderator client by the viewer invitation signal, and viewer messages from the specific one of the plurality of viewer clients are transmitted via the stage portion when the specific one of the plurality of viewer clients is on the stage.

37. A method for creating and transmitting interactive programming content comprising an audience portion and a stage portion, hosted by a moderator client on a stage, to an audience comprising a plurality of viewer clients over a communication network, comprising:

- providing an interactive program creation tool, the interactive program creation tool including a moderator interface for the moderator client;
- operably coupling a moderator server to the communication network;
- operably coupling a content server to the moderator server;
- operably coupling the moderator client to the moderator server via the communication network;
- operably coupling the plurality of viewer clients to the moderator server via the communication network;
- providing the moderator interface at the moderator client, the moderator interface including one or more interactive elements to enable a user of the moderator client to create a look for the interactive programming content by establishing at least one of graphics, a background, a layout, and an interactive area;
- receiving by the moderator server from the content server a first set of content signals;
- receiving by the moderator server via the communication network from the moderator client a first set of moderator comment signals;
- generating by the moderator server a first content including content generated from the first set of content signals and moderator comments generated from the first set of moderator comment signals;
- transmitting by the moderator server via the communication network to the plurality of viewer clients the first content;
- receiving viewer comment messages responsive to the first content and directed to the stage from any and all of the plurality of viewer clients by the moderator server via the communication network;
- receiving viewer messages responsive to the first content and directed to the audience from any of the plurality of viewer clients by the moderator server via the communication network;

42

transmitting by the moderator server via the communication network to the moderator client the viewer comment messages directed to the stage;

receiving edited said viewer comment messages and a second set of moderator comments by the moderator server via the communication network from the moderator client;

receiving by the moderator server from the content server a second set of content signals;

generating by the moderator server a second content using the second set of content signals, the edited viewer comment messages, the viewer messages directed to the audience, and the second set of moderator comments; and

transmitting by the moderator server via the communication network to the plurality of viewer clients the second content, wherein the viewer messages directed to the audience are displayed via the audience portion and not via the stage portion, and the edited viewer comment messages and the second set of moderator comments are displayed via the stage portion, to provide the interactive programming content at the viewer clients with the look such that the second content, the viewer messages, and the edited viewer comment messages are displayed in accordance with the at least one of the established graphics, background, layout, and interactive area.

38. The method of claim 37, wherein the viewer comment messages directed to the stage further include an interactive program rating signal corresponding to a viewer rating of the interactive programming content.

39. The method of claim 37, further comprising:

- receiving by the moderator server a viewer exclusion signal corresponding to a specific one of the plurality of viewer clients; and
- in response to the viewer exclusion signal, preventing, by the moderator server, viewer comment messages received from the specific one of the plurality of viewer clients from being displayed.

40. The method of claim 37, further comprising:

- receiving by the moderator server a viewer invitation signal corresponding to a specific one of the plurality of viewer clients;
- in response to the viewer invitation signal, inviting, by the moderator server, the specific one of the plurality of viewer clients to join the stage with the moderator client; and
- displaying viewer messages from the specific one of the plurality of viewer clients via the stage portion when the specific one of the plurality of viewer clients is on the stage.

41. A method for creating and transmitting an interactive program comprising an audience portion and a stage portion, hosted by a moderator client on a stage, to an audience comprising a plurality of viewer clients over a communications network, comprising:

- providing an interactive program creation tool, the interactive program creation tool including a moderator interface for the moderator client;
- operably coupling the moderator client to a moderator server via the communications network;
- operably coupling the plurality of viewer clients to the moderator server via the communications network;
- providing the moderator interface to the moderator client, the moderator interface including one or more interactive elements to enable a user of the moderator client

43

to create a look for the interactive program by establishing at least one of graphics, a background, a layout, and an interactive area;

receiving participant comment signals corresponding to participant comments directed to the stage from any and all of the plurality of viewer clients by the moderator server via the communications network;

receiving audience interactive signals corresponding to audience interactive messages directed to the audience from any of the plurality of viewer clients by the moderator server via the communications network;

transmitting by the moderator server via the communications network to the moderator client the participant comment signals directed to the stage;

receiving edited participant comment signals and moderator signals by the moderator server via the communications network from the moderator client;

generating interactive program signals by the moderator server using the edited participant comment signals, the audience interactive signals directed to the audience, and the moderator signals; and

transmitting by the moderator server via the communications network to the plurality of viewer clients the interactive program signals,

wherein the audience interactive messages corresponding to the audience interactive signals are displayed via the audience portion and not via the stage portion, and edited participant comments corresponding to the edited participant comment signals and moderator comments corresponding to the moderator signals are via the stage portion, to provide the interactive program at the viewer clients with the look such that the audience messages corresponding to the audience interactive signals and the edited participant comments corresponding to the edited participant comment signals are displayed in accordance with the at least one of the established graphics, background, layout, and interactive area.

42. The method of claim 41, wherein the generating of the interactive program signals further includes:

receiving content signals by the moderator server from a content server; and

generating by the moderator server the interactive program signals using the content signals, the edited participant comment signals, the audience interactive signals, and the moderator signals.

43. The method of claim 41, wherein the participant comment signals further include an interactive program rating signal corresponding to a viewer rating of the interactive program.

44. The method of claim 41, wherein the moderator signals further include a viewer exclusion signal corresponding to a specific one of the plurality of viewer clients, and the generating of the interactive program signals further includes using the viewer exclusion signal to exclude participant comments received from the specific one of the plurality of viewer clients.

45. The method of claim 41, wherein the moderator signals further include a viewer invitation signal corresponding to a specific one of the plurality of viewer clients, and the generating of the interactive program signals further includes using the viewer invitation signal, wherein the specific one of the plurality of viewer clients is invited to join the stage with the moderator client in response to the viewer invitation signal, and

44

viewer messages from the specific one of the plurality of viewer clients are displayed via the stage portion when the specific one of the plurality of viewer clients is on the stage.

46. A moderator server for creating and transmitting an interactive program comprising an audience portion and a stage portion, hosted by a moderator client on a stage, to an audience comprising a plurality of viewer clients, the plurality of viewer clients, the moderator client, and a content server being operably coupled to the moderator server via a communication network, the moderator server comprising:

a processor; and

a memory operably coupled to the processor and having program instructions stored therein, the processor being operable to execute the program instructions, the program instructions including:

providing an interactive program creation tool, the interactive program creation tool including a moderator interface for the moderator client;

providing the moderator interface at the moderator client, the moderator interface including one or more interactive elements to enable the user of the moderator client to create a look for the interactive program by establishing at least one of graphics, a background, a layout, and an interactive area;

receiving by the moderator server from the content server a first set of content signals;

receiving by the moderator server via the communication network from the moderator client a first set of moderator comment signals;

generating by the moderator server a first content including content generated from the first set of content signals and moderator comments generated from the first set of moderator comment signals;

transmitting by the moderator server via the communication network to the plurality of viewer clients the first content;

receiving viewer comment messages responsive to the first content and directed to the stage from any and all of the plurality of viewer clients by the moderator server via the communication network;

receiving viewer messages responsive to the first content and directed to the audience from any of the plurality of viewer clients by the moderator server via the communication network;

transmitting by the moderator server via the communication network to the moderator client the viewer comment messages directed to the stage;

receiving edited said viewer comment messages and a second set of moderator comments by the moderator server via the communication network from the moderator client;

receiving by the moderator server from the content server a second set of content signals;

generating by the moderator server a second content using the second set of content signals, the edited viewer comment messages, the viewer messages directed to the audience, and the second set of moderator comments; and

transmitting by the moderator server via the communication network to the plurality of viewer clients the second content,

wherein the viewer messages directed to the audience are displayed via the audience portion and not via the stage portion, and the edited viewer comment messages and the second set of moderator comments are displayed

45

via the stage portion, to provide the interactive program at the viewer clients with the look such that the second content, the viewer messages and the edited viewer comment messages are displayed in accordance with the at least one of the established graphics, background, layout, and interactive area.

47. The moderator server of claim 46, wherein the viewer comment messages directed to the stage further include an interactive program rating corresponding to a viewer rating of the interactive program.

48. The moderator server of claim 46, wherein the moderator comment signals further include a viewer exclusion signal corresponding to a specific one of the plurality of viewer clients, and

the program instructions for the generating by the moderator server of the second content further include, in response to the viewer exclusion signal, preventing viewer comment messages received from the specific one of the plurality of viewer clients from being displayed.

49. The moderator server of claim 46, wherein the second set of moderator comment signals further include a viewer invitation signal corresponding to a specific one of the plurality of viewer clients, and the program instructions for the generating by the moderator server of the second content further include, in response to the viewer invitation signal, inviting the specific one of the plurality of viewer clients to join the stage with the moderator client, and displaying viewer messages from the specific one of the plurality of viewer client via the stage portion when the specific one of the plurality of viewer clients is on the stage.

50. A data processing system adapted for creating and transmitting an interactive program comprising an audience portion and a stage portion, hosted by a moderator client on a stage, to an audience comprising a plurality of viewer clients via a communications network, the data processing system comprising a moderator server, the moderator server comprising:

a processor; and

a memory operably coupled to the processor and having program instructions stored therein, the processor being operable to execute the program instructions, the program instructions including:

providing an interactive program creation tool, the interactive program creation tool including a moderator interface for the moderator client;

providing the moderator interface at the moderator client, the moderator interface including one or more interactive elements to enable the user of the moderator client to customize a look for the interactive program by establishing at least one of graphics, a background, a layout, and an interactive area;

receiving participant comment signals corresponding to participant comments directed to the stage from any and all of the plurality of viewer clients by the moderator server via the communications network;

receiving audience interactive signals corresponding to audience interactive messages directed to the audience from any of the plurality of viewer clients by the moderator server via the communications network;

transmitting by the moderator server via the communications network to the moderator client the participant comment signals;

46

receiving edited participant comment signals and moderator signals by the moderator server via the communications network from the moderator client;

generating interactive program signals by the moderator server using the edited participant comment signals, the audience interactive signals directed to the audience, and the moderator signals; and

transmitting by the moderator server via the communications network to the plurality of viewer clients the interactive program signals,

wherein the audience interactive messages corresponding to the audience interactive signals are displayed via the audience portion and not via the stage portion, and edited participant comments corresponding to the edited participant comment signals and moderator comments corresponding to the moderator signals are displayed via the stage portion, to provide the interactive program at the viewer clients with the look such that the audience messages corresponding to the audience interactive signals and the edited participant comments corresponding to the edited participant comments signals are displayed in accordance with the at least one of the established graphics, background, layout, and interactive area.

51. The data processing system of claim 50, wherein the program instructions for the generating of the interactive program signals further include:

receiving content signals by the moderator server from a content server; and

generating by the moderator server the interactive program signals using the content signals, the edited participant comment signals, the audience interactive signals, and the moderator signals.

52. The data processing system of claim 50, wherein the participant comment signals further include an interactive program rating signal corresponding to a viewer rating of the interactive program.

53. The data processing system of claim 50, wherein the moderator signals further include a viewer exclusion signal corresponding to a specific one of the plurality of viewer clients, and

the program instructions for the generating of the interactive program signals further include using the viewer exclusion signal to exclude the participant comments received from the specific one of the plurality of viewer clients.

54. The data processing system of claim 50, wherein the moderator signals further include a viewer invitation signal corresponding to a specific one of the plurality of viewer clients, and

the program instructions for the generating of the interactive program signals further include, in response to the viewer invitation signal,

inviting the specific one of the plurality of viewer clients to join the stage with the moderator client, and

displaying viewer messages from the specific one of the plurality of viewer clients via the stage portion when the specific one of the plurality of viewer clients is on the stage.

55. A system for providing an interactive program comprising an audience portion and a stage portion to a plurality of viewers via a communications network, the interactive program being hosted by a moderator operating a moderator client on a stage, the system comprising: a processor; and

47

a memory operably coupled to the processor and having program instructions stored therein, the processor being operable to execute the program instructions to cause the system to:

provide an interactive program creation tool, the interactive program creation tool including a moderator interface for the moderator client;

display the moderator interface at the moderator client, the moderator interface including one or more interactive elements to enable the moderator to create a look for the interactive program by establishing at least one of graphics, a background, a layout, and an interactive area;

receive via the communications network participant comment signals corresponding to participant comments directed to the stage from any and all of the plurality of viewers by a moderator server;

receive via the communications network audience interactive signals corresponding to audience interactive messages directed to the audience from any of the plurality of viewers by the moderator server;

receive via the communications network moderator signals from the moderator client;

transmitting via the communications network the participant comment signals directed to the moderator client;

receive via the communications network edited participant comment signals and moderator signals by the moderator server via the communications network from the moderator client;

generate interactive program signals using the edited participant comment signals, the audience interactive signals, and the moderator signals; and

transmit via the communications network to a plurality of viewer clients operated by the viewers the interactive program signals to cause the plurality of viewer clients to display the audience interactive messages corresponding to the audience interactive signals via an audience portion and not via a stage portion of the interactive program, and display edited participant comment messages corresponding to the edited participant comment signals and moderator comments corresponding to the moderator signals via the stage portion of the interactive program, to provide the interactive program at the viewers with the look such that the messages and the comments are displayed in accordance with the at least one of the established graphics, background, layout, and interactive area.

56. The system of claim 55, wherein the processor is further operable to execute the program instructions to cause the system to:

receive content signals from a content server; and

generate the interactive program signals using the content signals, the edited comment signals, the message signals, and the moderator signals.

57. The system of claim 55, wherein the comments include a viewer opinion of the interactive program.

58. The system of claim 55, wherein the program instructions further include program instructions for causing the system to prevent one or more of the comments and messages from being displayed by the viewer clients.

59. The system of claim 55, wherein the program instructions further include program instructions for causing the system to invite one of plurality of viewers to join the stage portion of the interactive program with the moderator and for causing messages from the invited viewer to be displayed by the viewer clients via the stage portion of the interactive

48

program when the invited viewer has joined the stage portion of the interactive program.

60. A system for providing an interactive program comprising an audience portion and a stage portion to a plurality of viewers via a communications network, the interactive program being hosted by a moderator using a moderator client on a stage and including an audience portion and a stage portion, the system comprising:

a processor; and

a memory operably coupled to the processor and having program instructions stored therein, the processor being operable to execute the program instructions to cause the system to:

provide an interactive program creation tool, the interactive program creation tool including a moderator interface for the moderator client;

display the moderator interface at the moderator client, the moderator interface including one or more interactive elements to enable the moderator to create a look for the interactive program by establishing at least one of graphics, a background, a layout, and an interactive area;

receive via the communications network from a content server first content signals;

receive via the communications network from the moderator client first moderator comments, the moderator client being operated by the moderator;

receive via the communications network audience interactive signals corresponding to audience interactive messages directed to the audience from any of the plurality of viewers by a moderator server;

generate first content using the first content signals and the first moderator comments;

transmit by the moderator server via the communications network to a plurality of viewer clients the first content, each of the plurality viewer clients being operated by one or more of respective ones of the plurality of viewers;

receive via the communications network, from any and all of the plurality of viewer clients, viewer reactions to the first content directed at the stage;

receive via the communications network from any of the plurality of viewer clients viewer messages;

transmit via the communications network to the moderator client the viewer reactions to the first content;

receive via the communications network from the moderator client second moderator comments and edited viewer reactions;

receive from the content server second content signals;

generate by the moderator server second content using the second content signals, the edited viewer reactions to the first content, the viewer messages, and the second moderator comments; and

transmit via the communications network to the plurality of viewer clients signals to cause the plurality of viewer clients to display the second content via a stage portion of the interactive program, display the edited viewer comment messages via an audience portion of the interactive program and not via the stage portion, and display the viewer reactions to the first content and the second moderator comments via the stage portion of the interactive program, to provide the interactive program at the viewers with the look such that the second content, the viewer messages, the viewer reactions are displayed in accordance with the at least one of the established graphics, background, layout, and interactive area.

61. The system of claim 60, wherein the viewer reactions include a viewer opinion of the interactive program.

62. The system of claim 60, wherein the program instructions further include program instructions for causing the system to prevent one or more of the viewer reactions and viewer messages from being displayed by the viewer clients. 5

63. The system of claim 60, wherein the program instructions further include program instructions for causing the system to invite one of the plurality of viewers to join the stage portion of the interactive program with the moderator and for causing viewer messages from the invited viewer to be displayed by the viewer clients via the stage portion of the interactive program when the invited viewer has joined the stage portion of the interactive program. 10

64. The system of claim 60, wherein the program instructions further include program instructions for causing the system to generate synchronization signals for the interactive program and to transmit the interactive program with the synchronization signals to the plurality of viewer clients to cause the plurality of viewer clients to display the non-interactive content with the interactive program in a synchronous manner. 15 20

* * * * *