



US00RE47859E

(19) **United States**
(12) **Reissued Patent**
Ladewig et al.

(10) **Patent Number: US RE47,859 E**
(45) **Date of Reissued Patent: Feb. 18, 2020**

(54) **AREA LIGHT FIXTURE**

- (71) Applicant: **Cooper Technologies Company**,
Houston, TX (US)
- (72) Inventors: **Christopher Ladewig**, Fayetteville, GA
(US); **Timothy Wright**, Peachtree City,
GA (US)
- (73) Assignee: **Eaton Intelligent Power Limited**,
Dublin (IE)
- (21) Appl. No.: **29/663,144**
- (22) Filed: **Sep. 12, 2018**

Related U.S. Patent Documents

Reissue of:

- (64) Patent No.: **Des. 766,485**
Issued: **Sep. 13, 2016**
Appl. No.: **29/525,451**
Filed: **Apr. 29, 2015**
- (51) **LOC (12) Cl.** **26-05**
- (52) **U.S. Cl.**
USPC **D26/71**
- (58) **Field of Classification Search**
USPC D26/67-71, 92
CPC F21V 17/104; F21V 19/0045; F21V 21/02;
F21V 15/01; F21S 9/03; F21S 8/085;
F21S 8/086; F21W 2131/103
See application file for complete search history.

(56) **References Cited**

U.S. PATENT DOCUMENTS

D220,778 S *	5/1971	Jablonski et al.	D26/71
D391,659 S	3/1998	Gaskins	
D609,384 S *	2/2010	Gray	D26/71
D615,234 S *	5/2010	Oblak	D26/71
D652,557 S	1/2012	Boissevain	
D672,491 S *	12/2012	Shin	D26/71
D676,173 S *	2/2013	Akinrele	D26/71
D676,174 S *	2/2013	Akinrele	D26/71

(Continued)

OTHER PUBLICATIONS

“Pure in the form and function, defining performance: Specification Grade Luminaires”. LED Solution. Philips. p. 1-21. Feb. 2015. www.philips.com/luminaires.

(Continued)

Primary Examiner — Philip S Hyder

(74) *Attorney, Agent, or Firm* — King & Spalding LLP

(57) **CLAIM**

The ornamental design for an area light fixture, as shown and described.

DESCRIPTION

FIG. 1 is a bottom perspective view of an area light fixture, showing our new design;
 FIG. 2 is a top perspective view thereof;
 FIG. 3 is a top plan view thereof;
 FIG. 4 is a bottom plan view thereof;
 FIG. 5 is a front elevation view thereof;
 FIG. 6 is a rear elevation view thereof;
 FIG. 7 is a right side elevation view thereof; and
 FIG. 8 is a left side elevation view thereof.
 FIG. 9 is a bottom perspective view of another embodiment of an area light fixture, showing our new design;
 FIG. 10 is a top perspective view thereof;
 FIG. 11 is a top plan view thereof;
 FIG. 12 is a bottom plan view thereof;
 FIG. 13 is a front elevation view thereof;
 FIG. 14 is a rear elevation view thereof;
 FIG. 15 is a right side elevation view thereof; and,
 FIG. 16 is a left side elevation view thereof.
 The broken lines shown represent unclaimed subject matter and form no part of the claimed design.

1 Claim, 12 Drawing Sheets

Matter enclosed in heavy brackets [] appears in the original patent but forms no part of this reissue; matter printed in italics indicates the additions made by reissue.

AMENDED

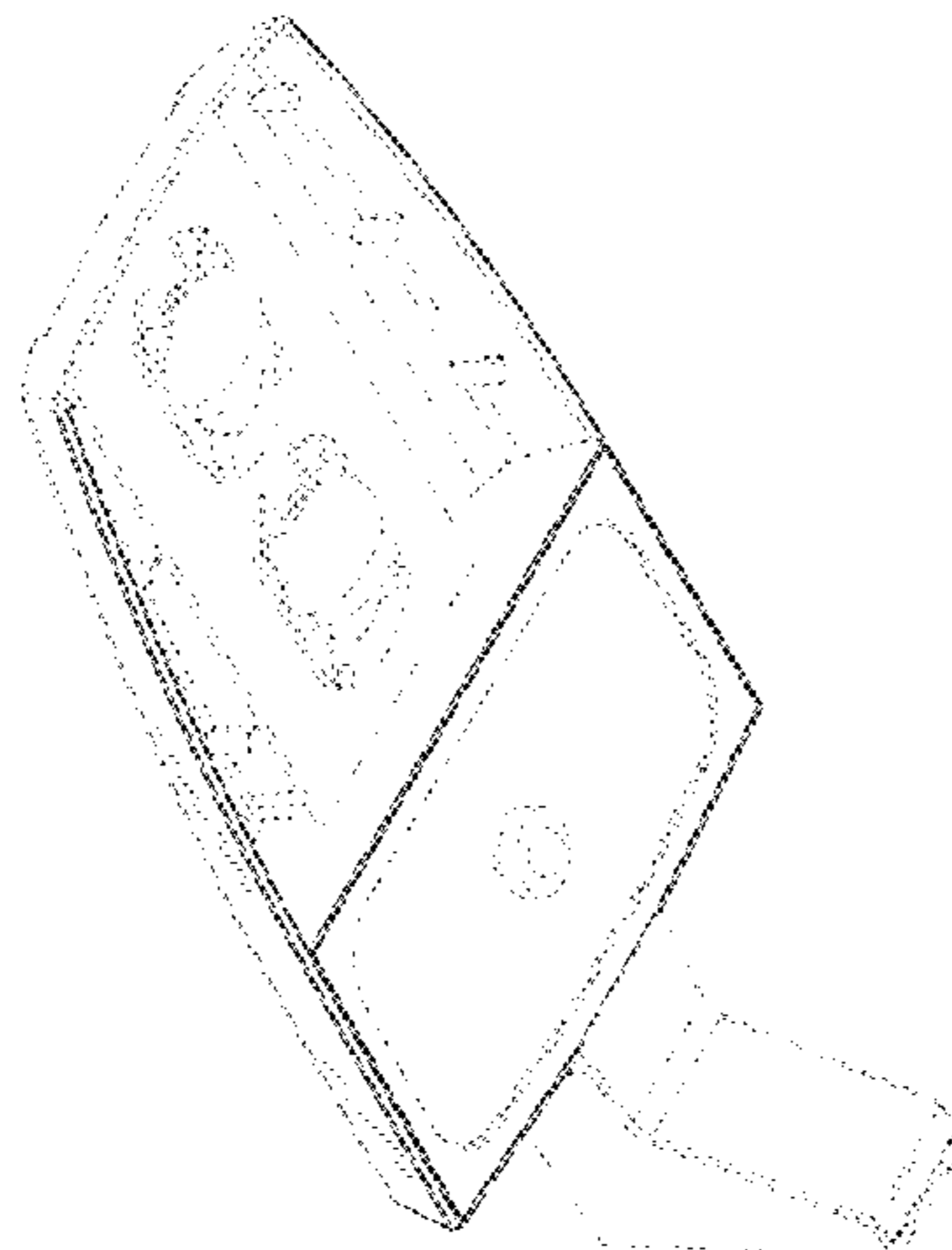

AMENDED

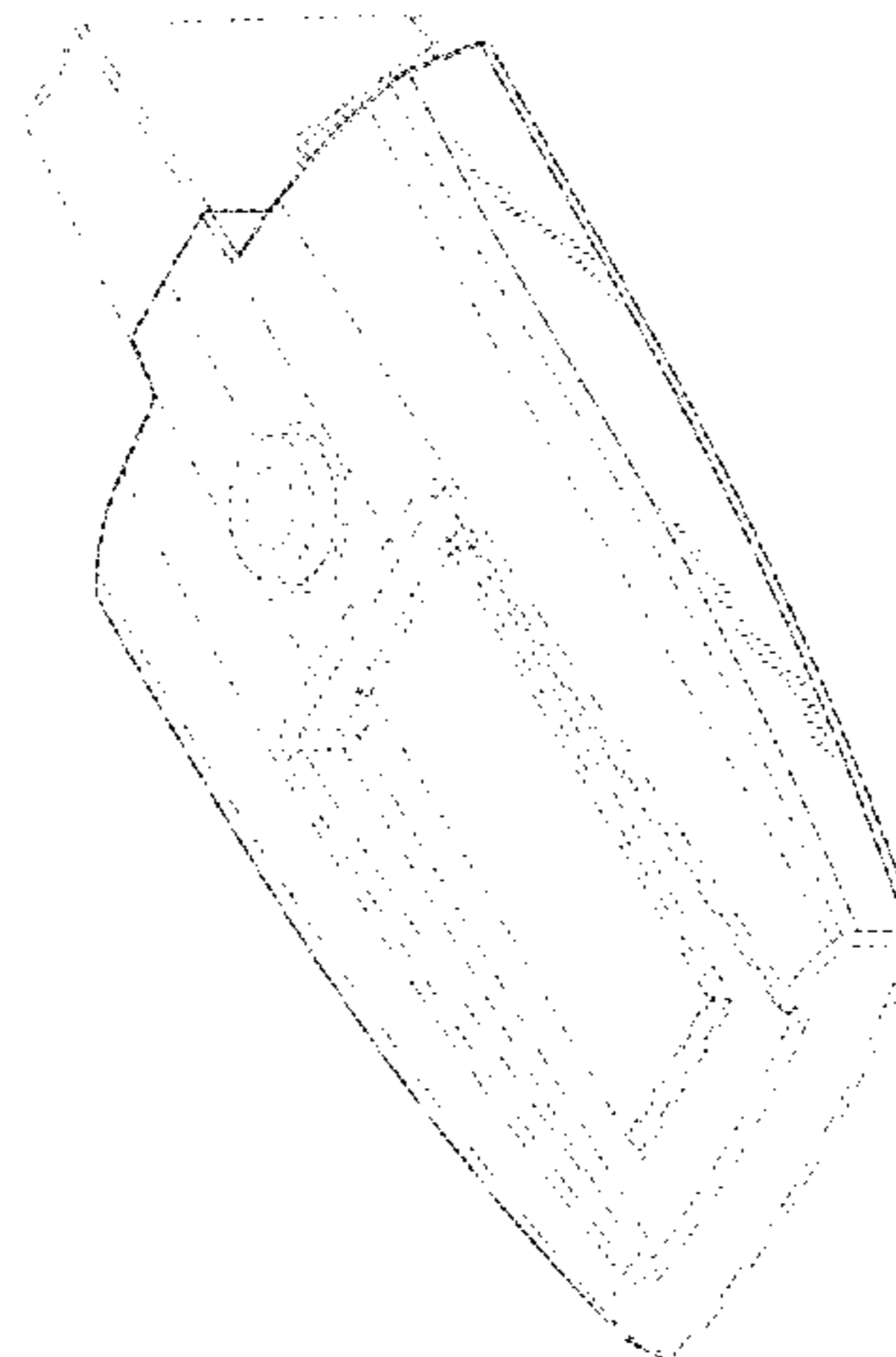

(56)

References Cited

U.S. PATENT DOCUMENTS

D676,175	S *	2/2013	Akinrele	D26/71
D676,176	S *	2/2013	Akinrele	D26/71
D676,177	S *	2/2013	Akinrele	D26/71
D676,178	S *	2/2013	Akinrele	D26/71
D688,404	S *	8/2013	Boissevain	D26/71
D689,233	S	9/2013	Boissevain	
D695,437	S *	12/2013	Johnson	D26/71
D710,046	S	7/2014	Mocek	
D717,989	S	11/2014	Heim	
D726,947	S	4/2015	Boyer	
D729,968	S *	5/2015	Szalontai	D26/71
D747,527	S *	1/2016	Guercio	D26/71
D760,935	S *	7/2016	Jurdana	D26/71
D760,936	S *	7/2016	Jurdana	D26/71
D760,937	S *	7/2016	Jurdana	D26/71
D766,485	S	9/2016	Ladewig et al.	
D793,601	S	8/2017	Ladewig et al.	
2010/0085751	A1	4/2010	Shaner	
2013/0188371	A1 *	7/2013	Ham	F21S 8/086 362/373
2014/0168932	A1	6/2014	Boomgaarden	
2015/0345772	A1	12/2015	Duckworth	

OTHER PUBLICATIONS

“OSQ Series: LED Area Light. Installation Instruction”. CREE. p. 1-3. May 28, 2014. www.cree.com/lighting.
 Lithonia Lighting; Universal Mounting Bracket; Brochure, Oct. 2013.
 Kim Lighting; Altitude Installation Instructions, Hubbell Lighting, Jul. 18, 2014.

* cited by examiner

FIG. 1
AMENDED

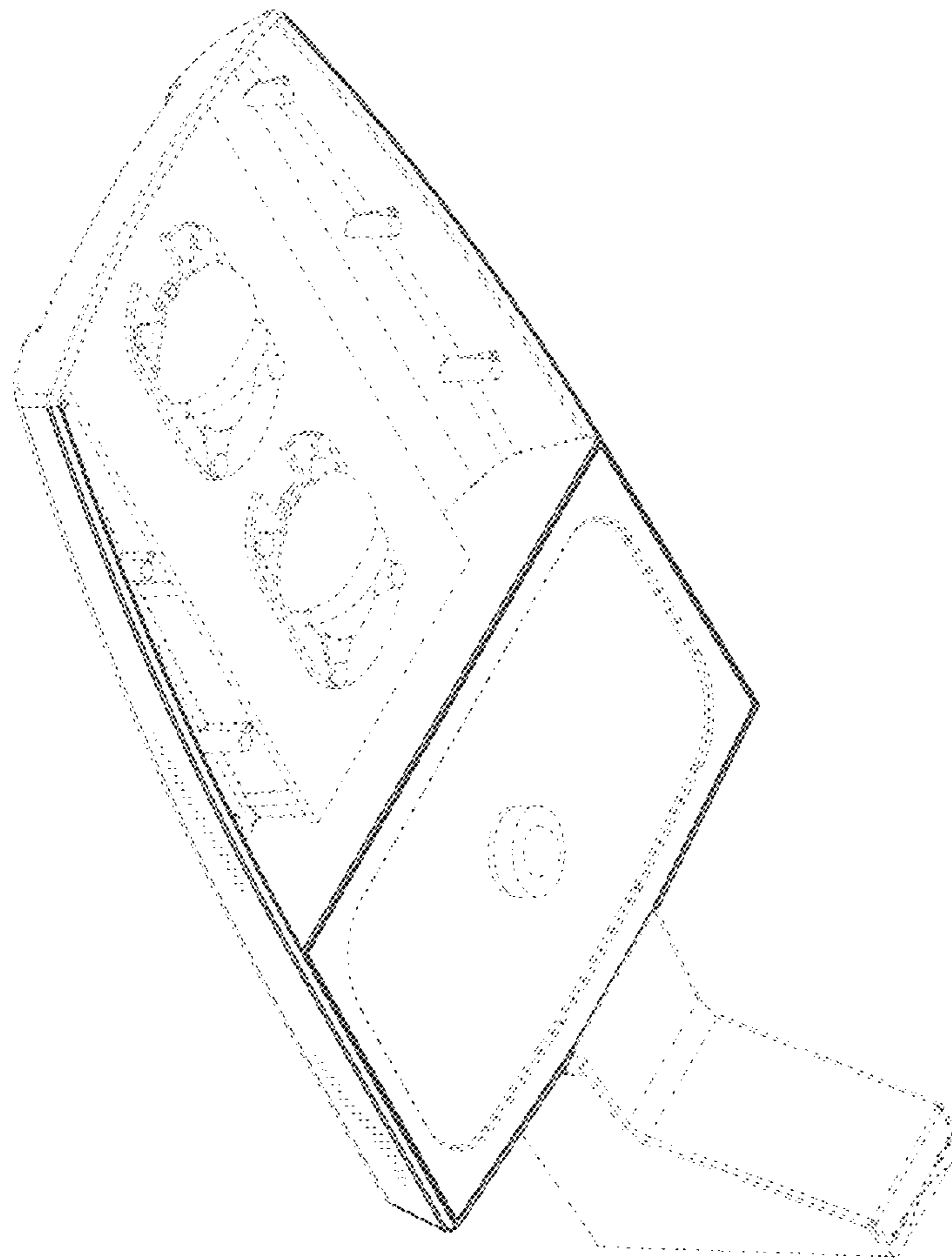

FIG. 2
AMENDED

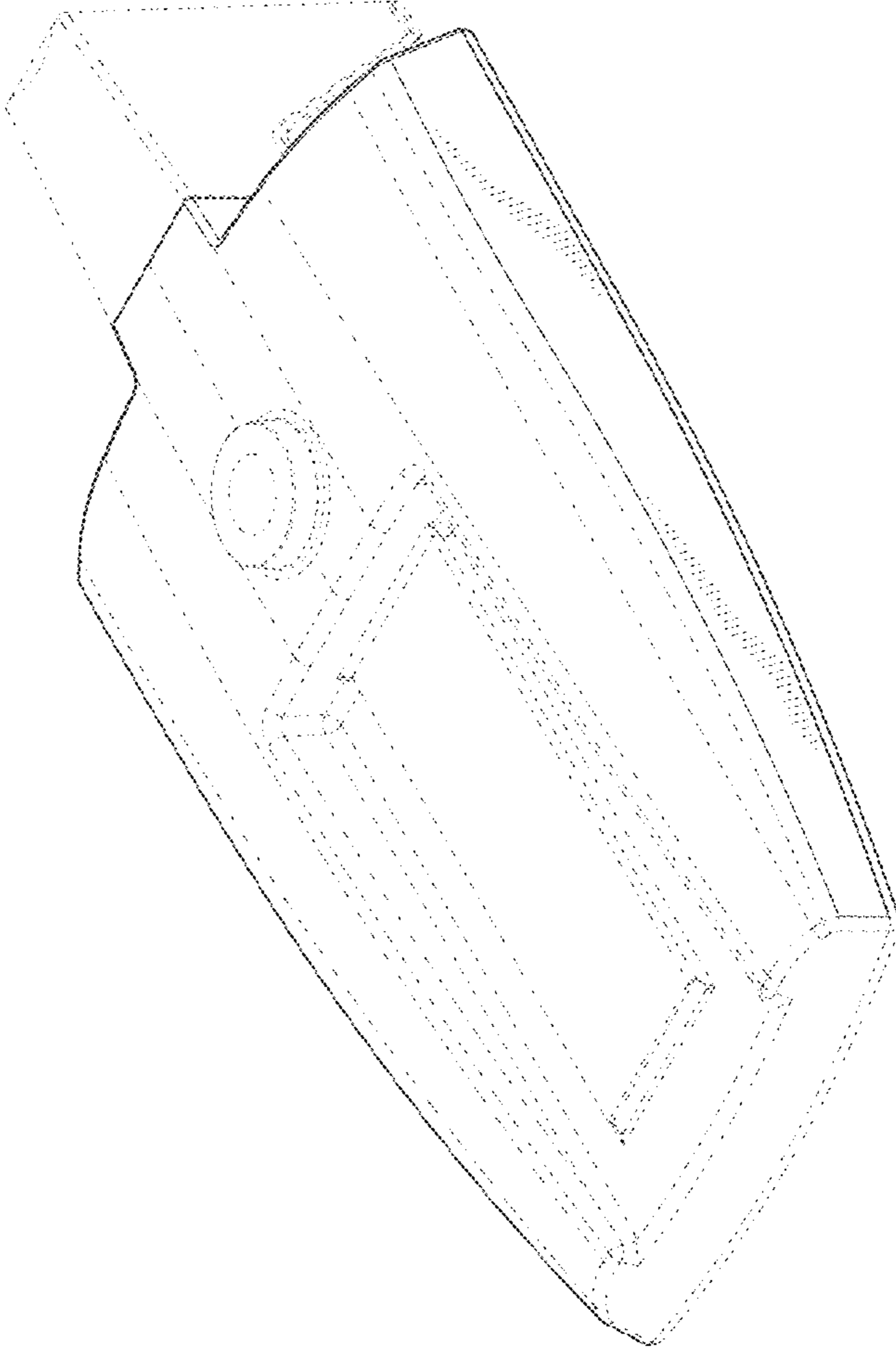

FIG. 3
AMENDED

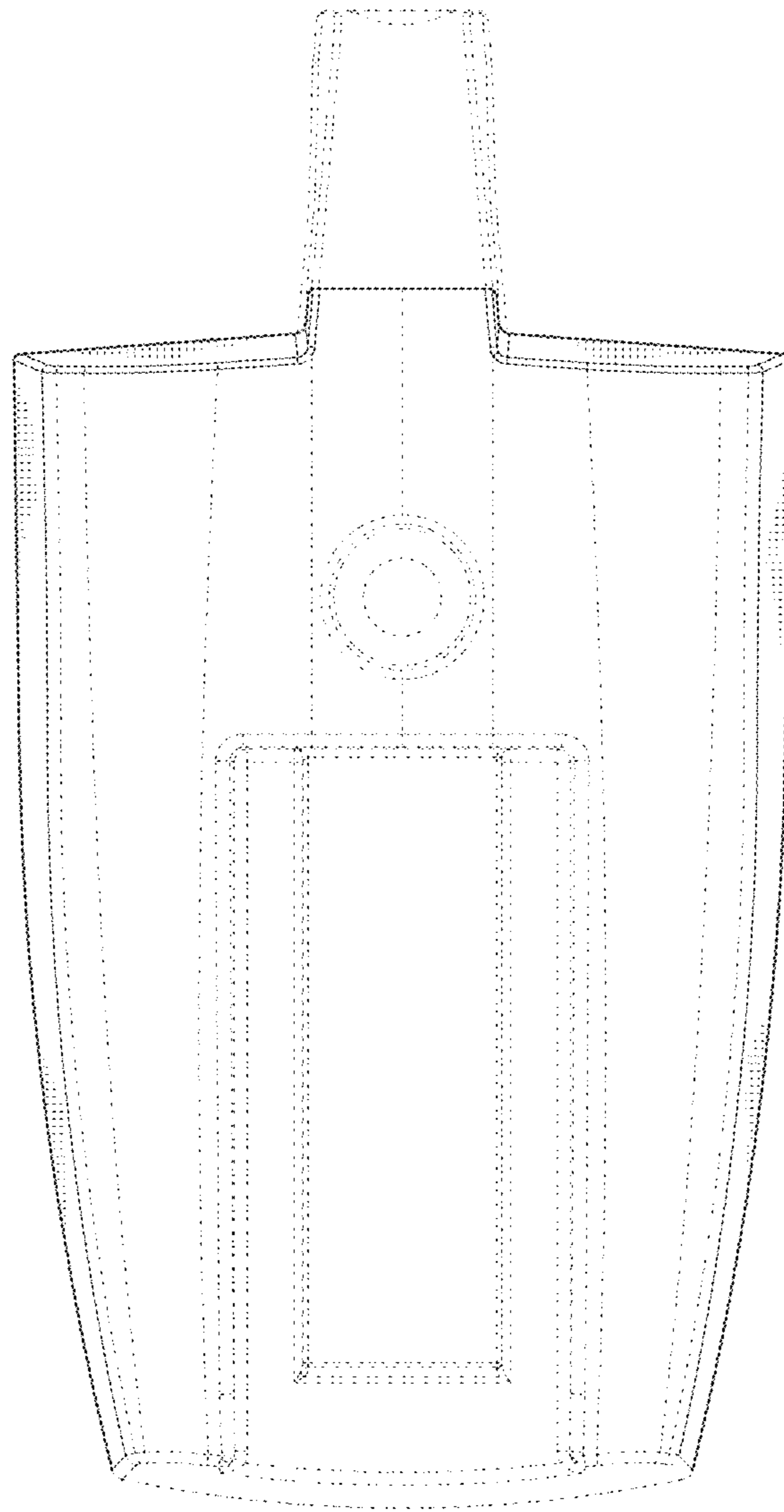

FIG. 4
AMENDED

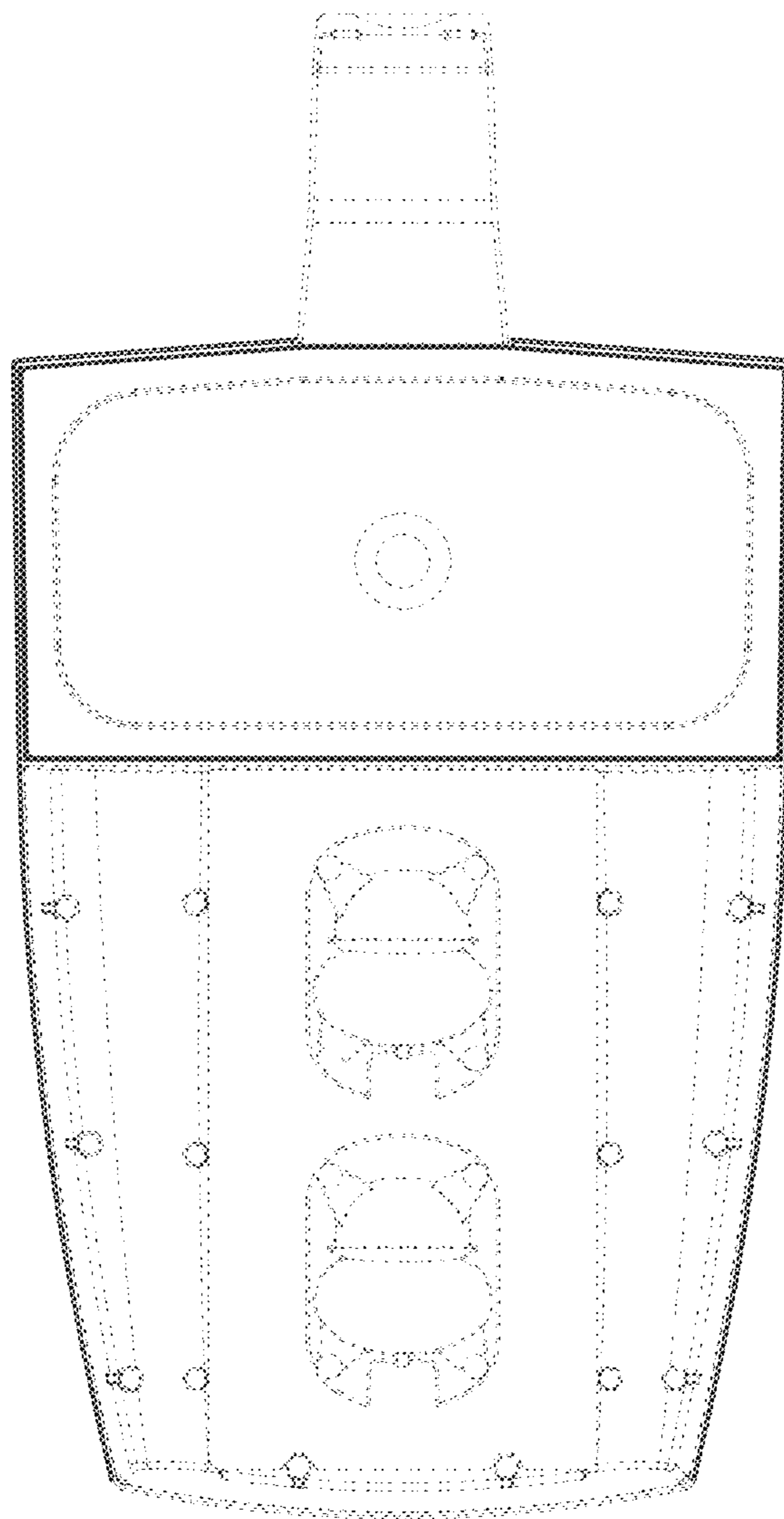

FIG. 5
AMENDED

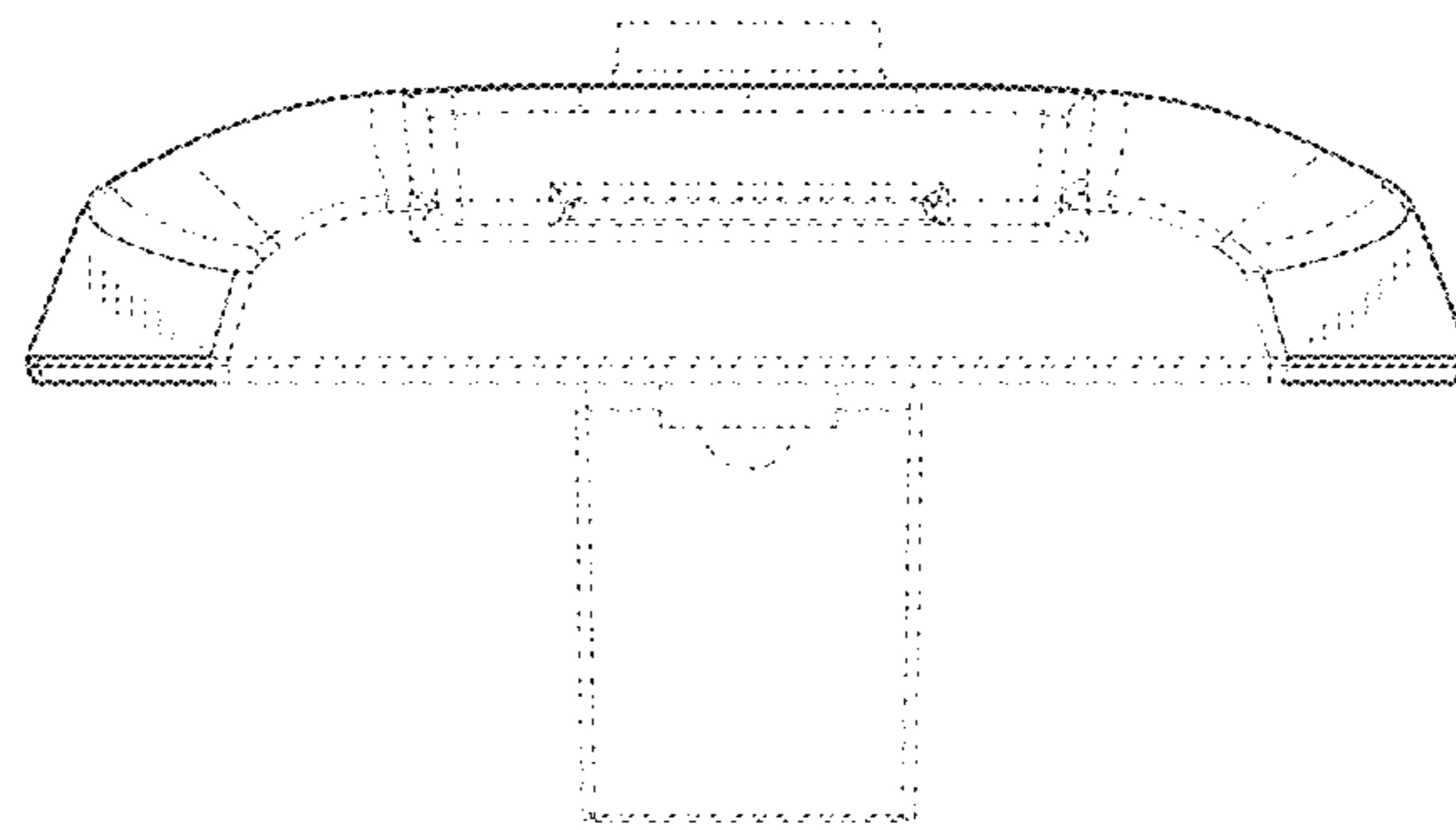

FIG. 6

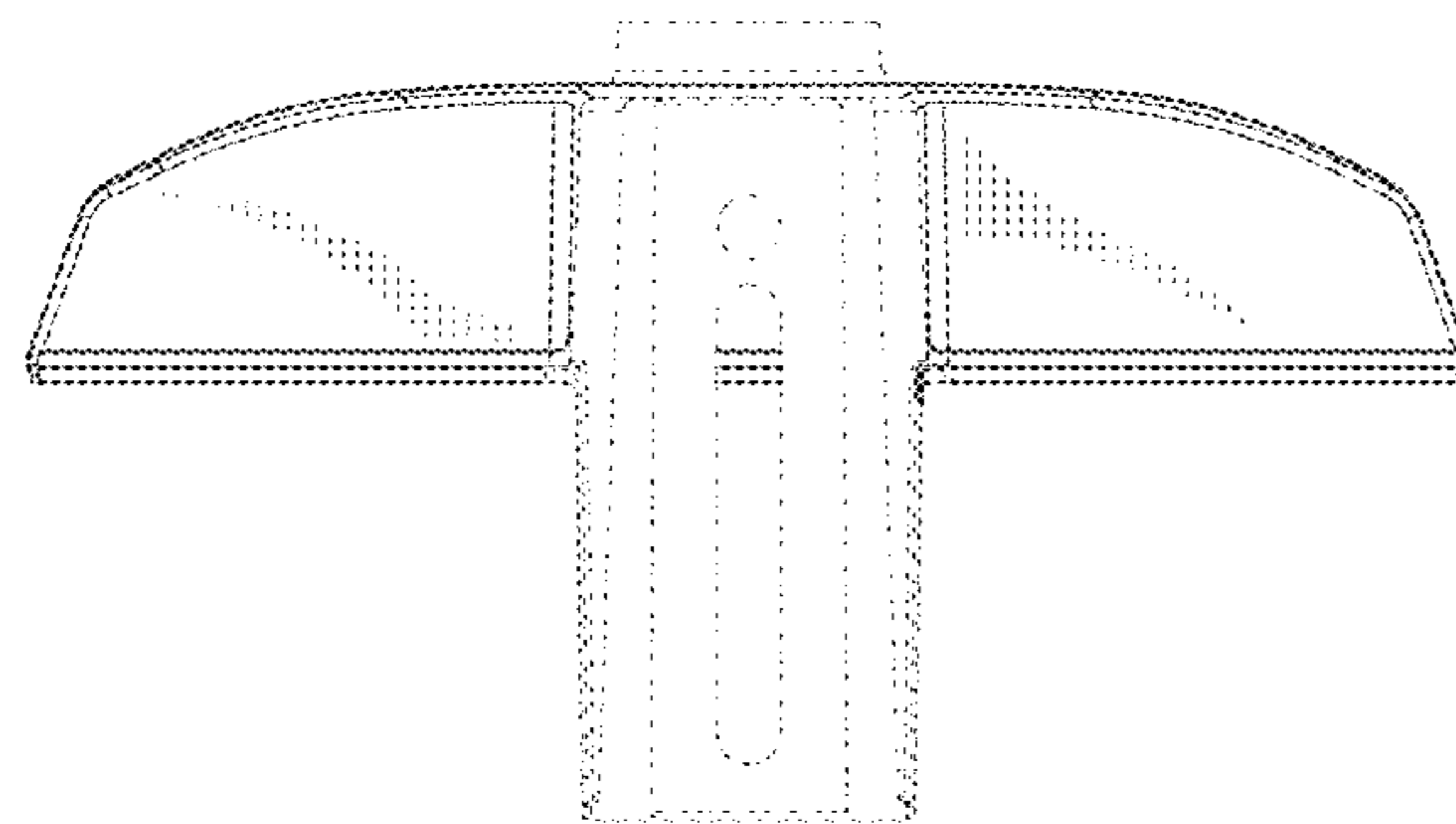

FIG. 7
AMENDED

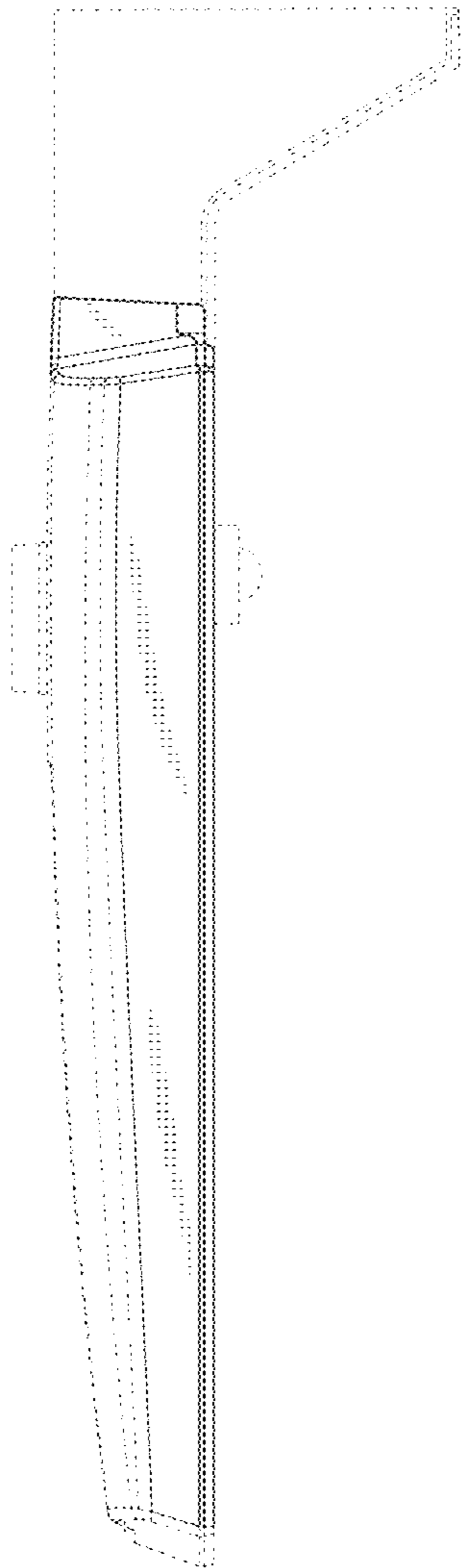

FIG. 8
AMENDED

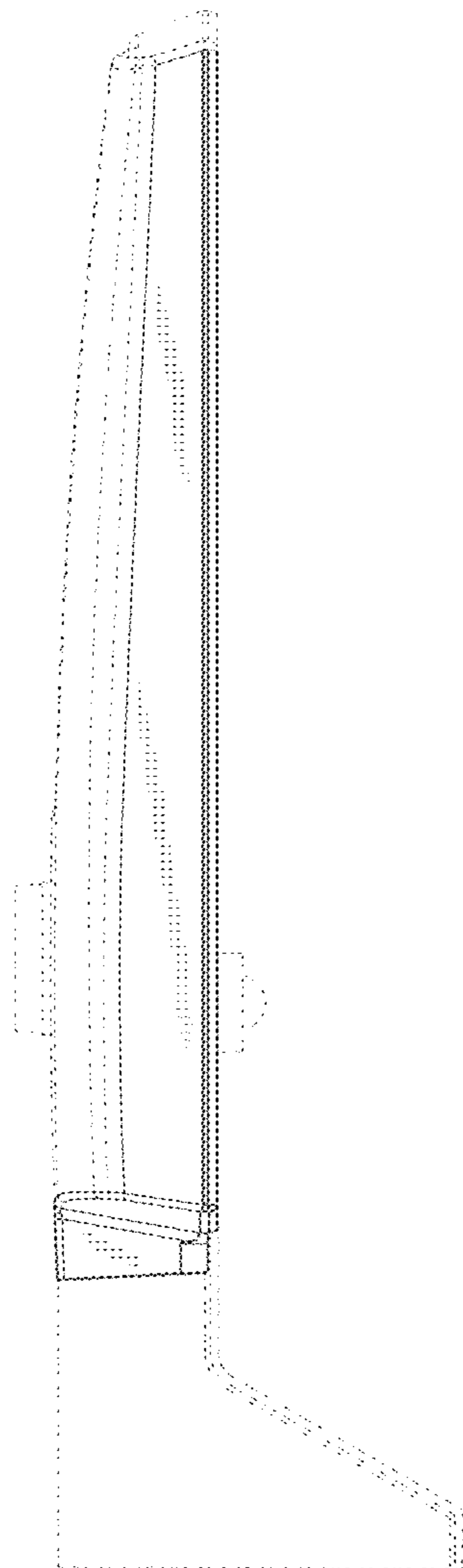

FIG. 9
AMENDED

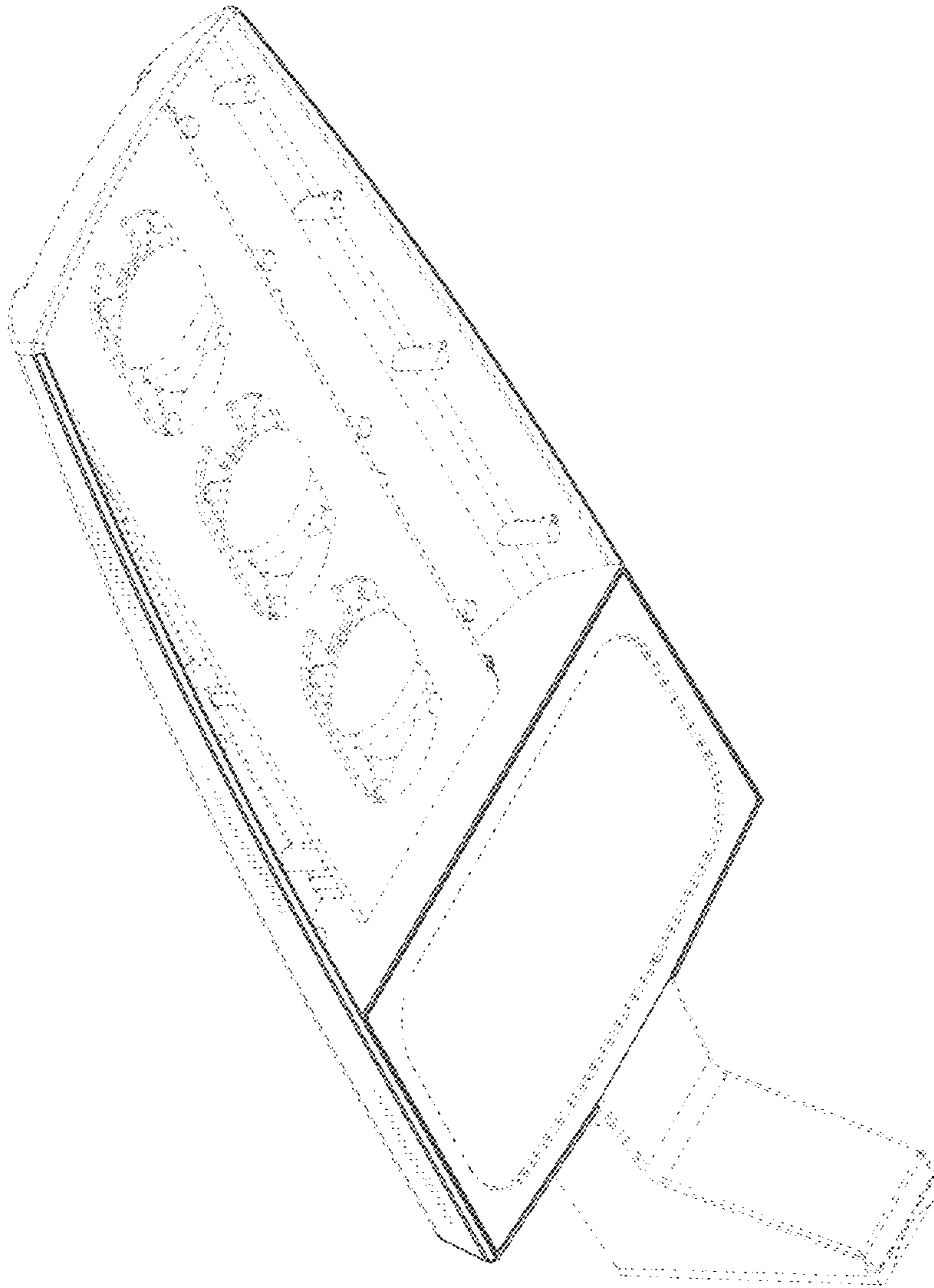

FIG. 10
AMENDED

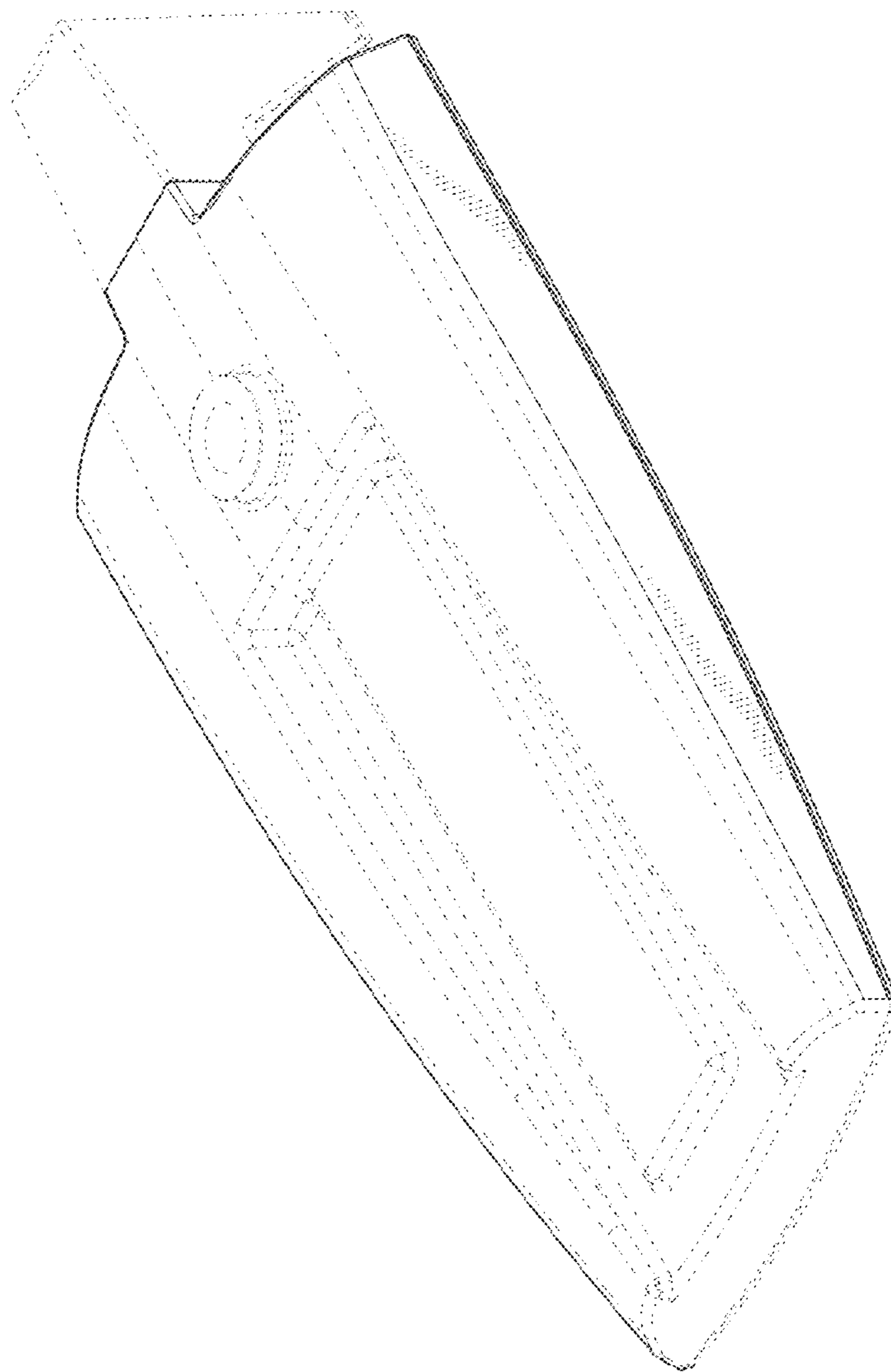

FIG. 11
AMENDED

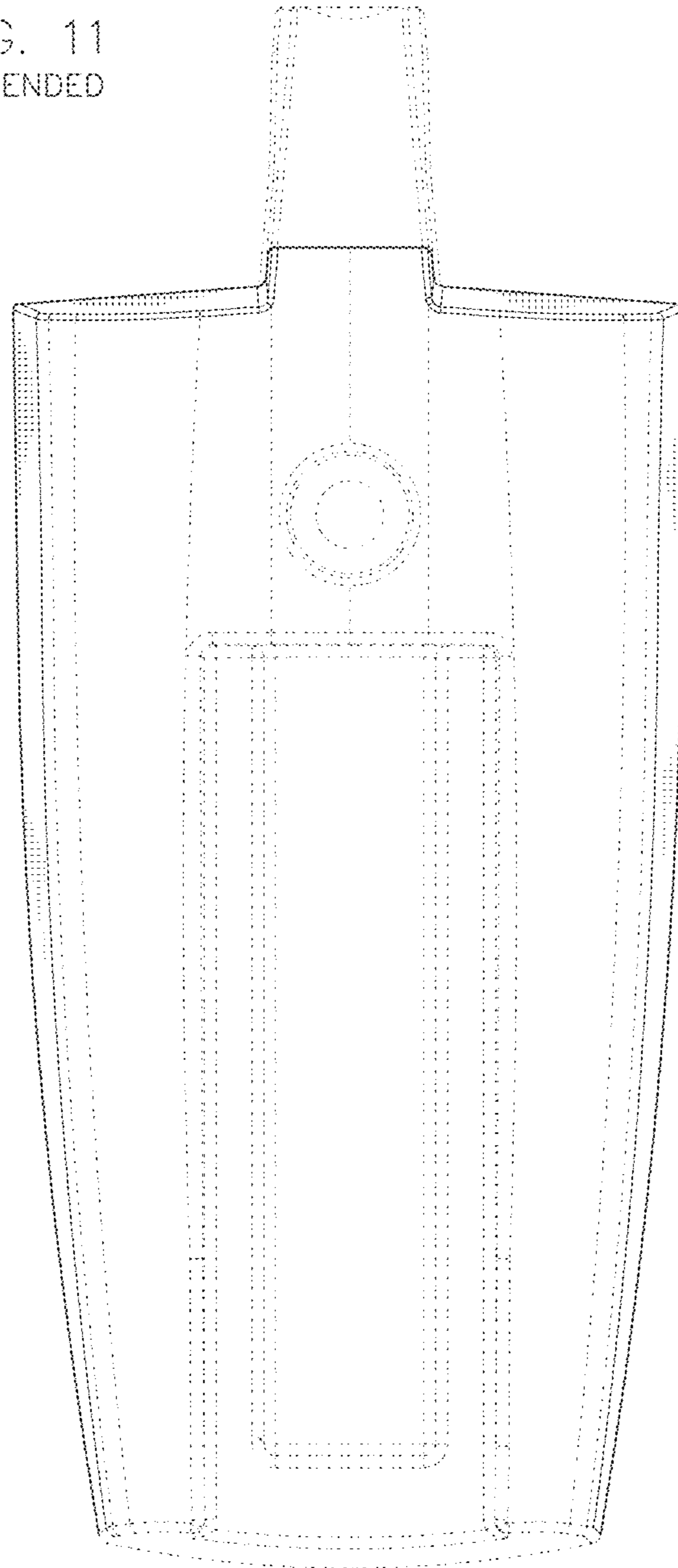

FIG. 12
AMENDED

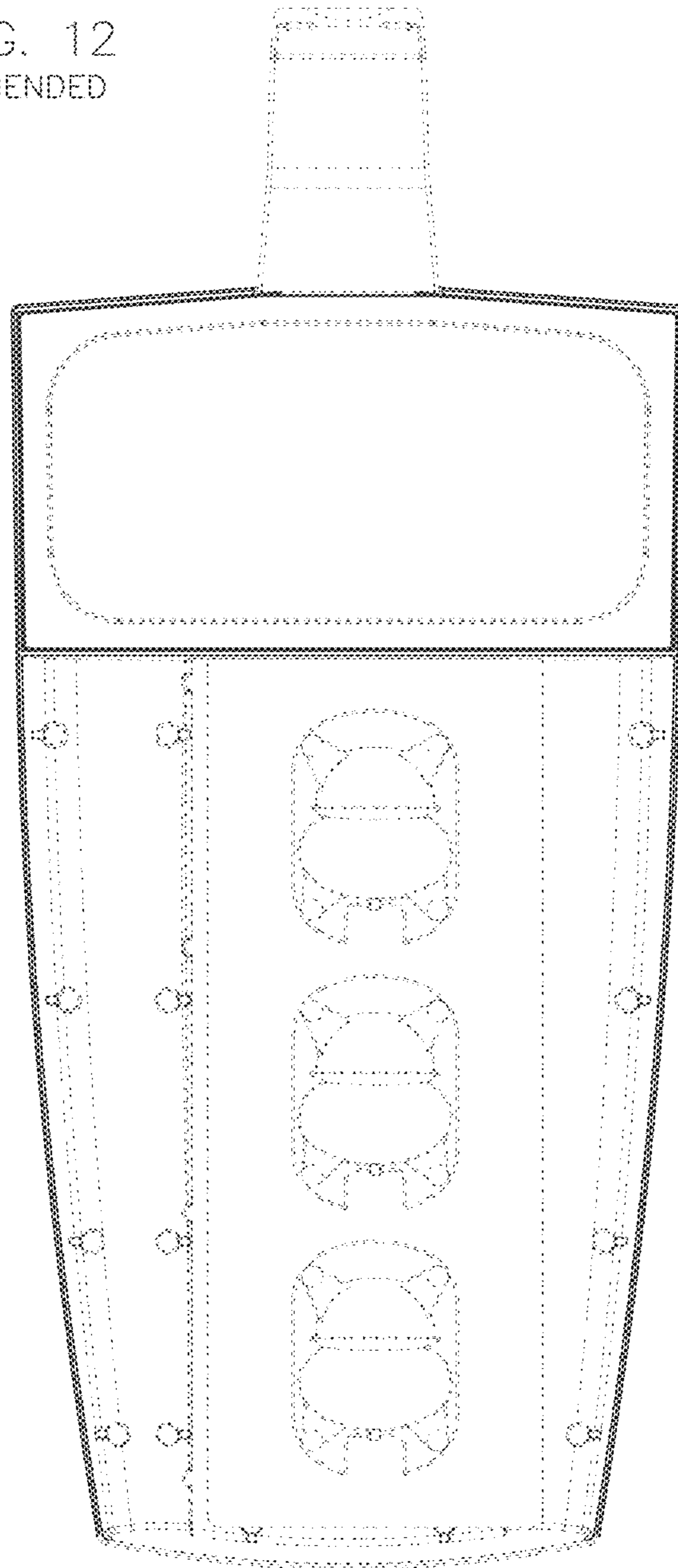

FIG. 13
AMENDED

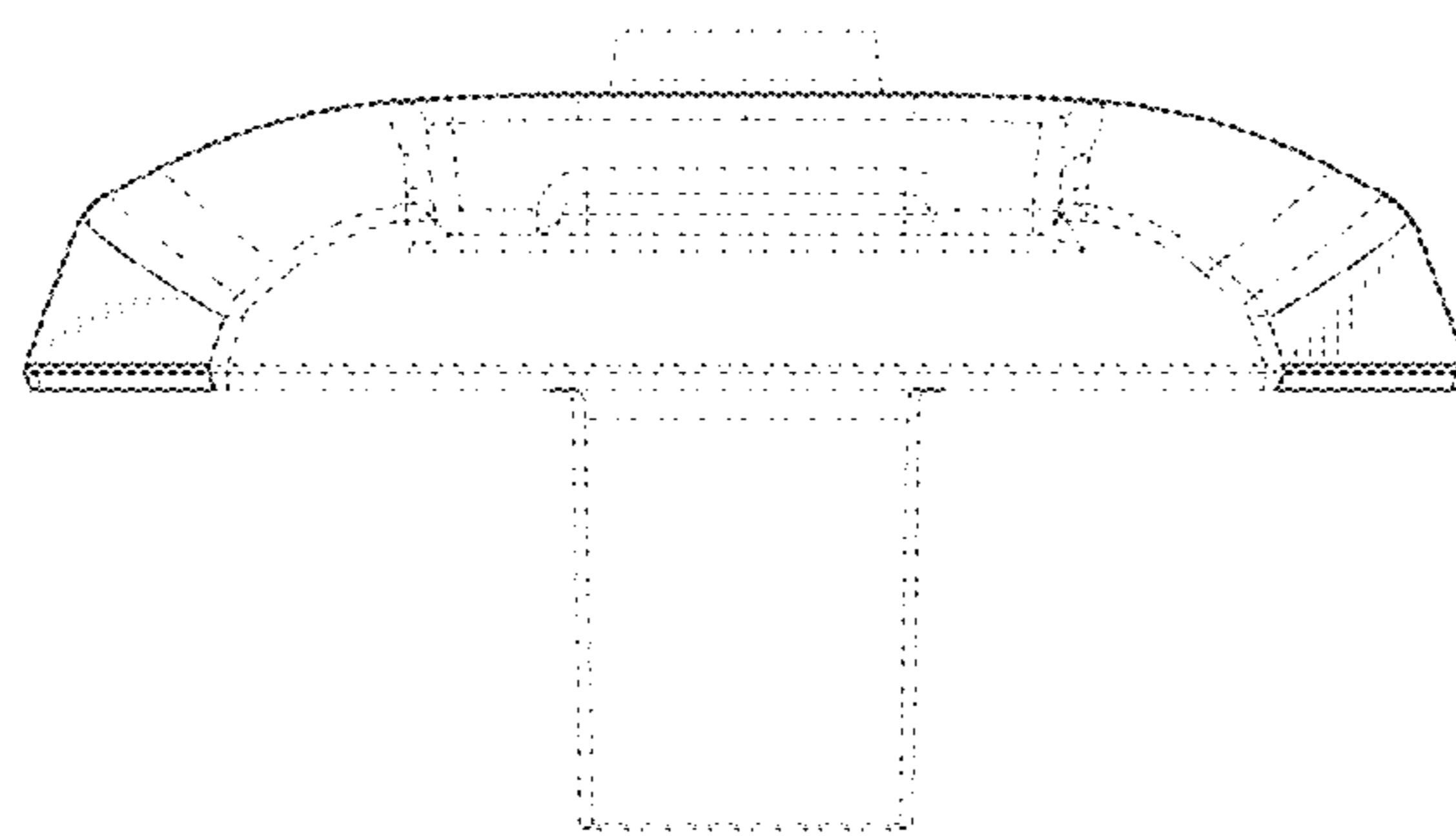

FIG. 14

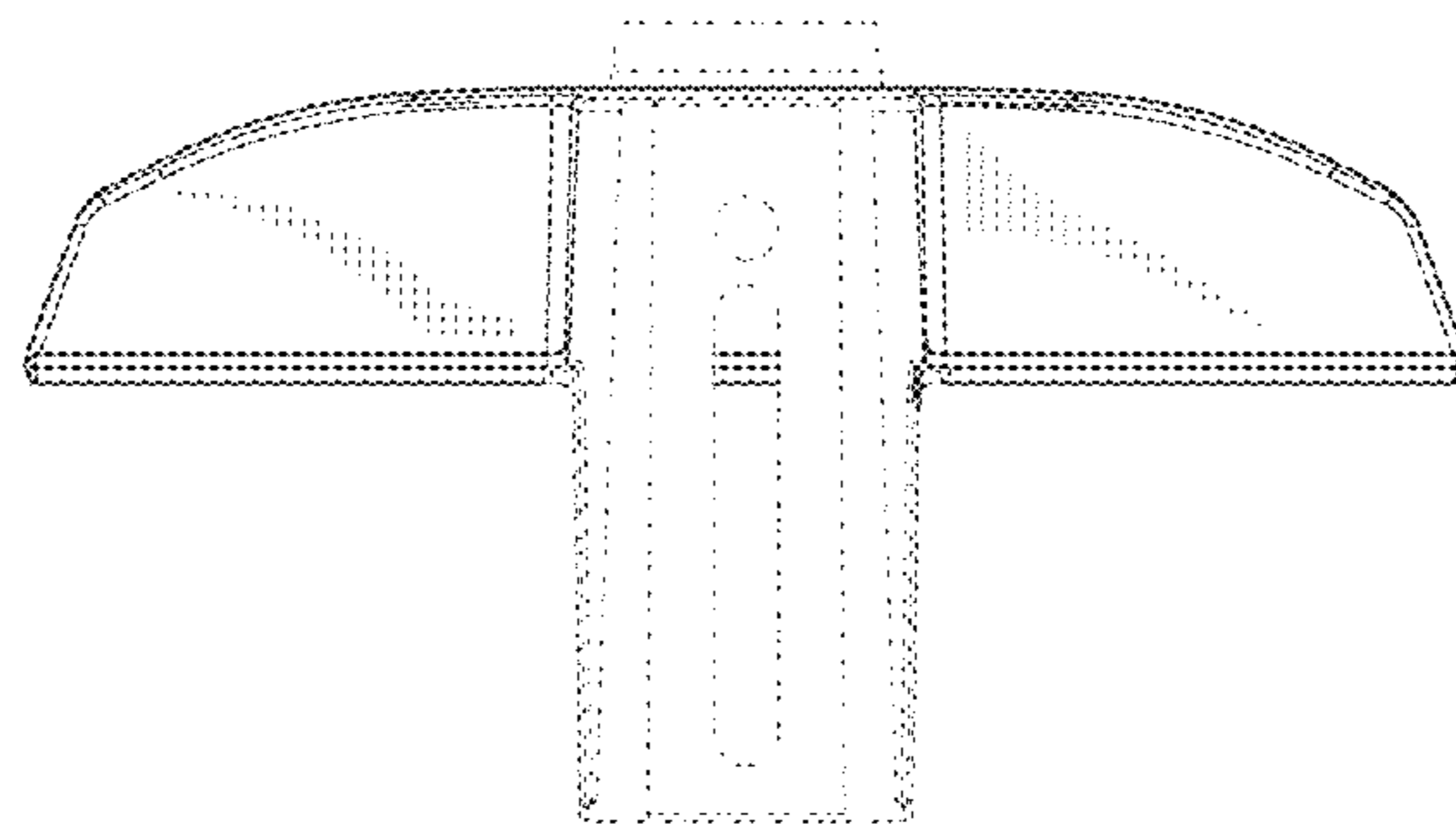

FIG. 15
AMENDED

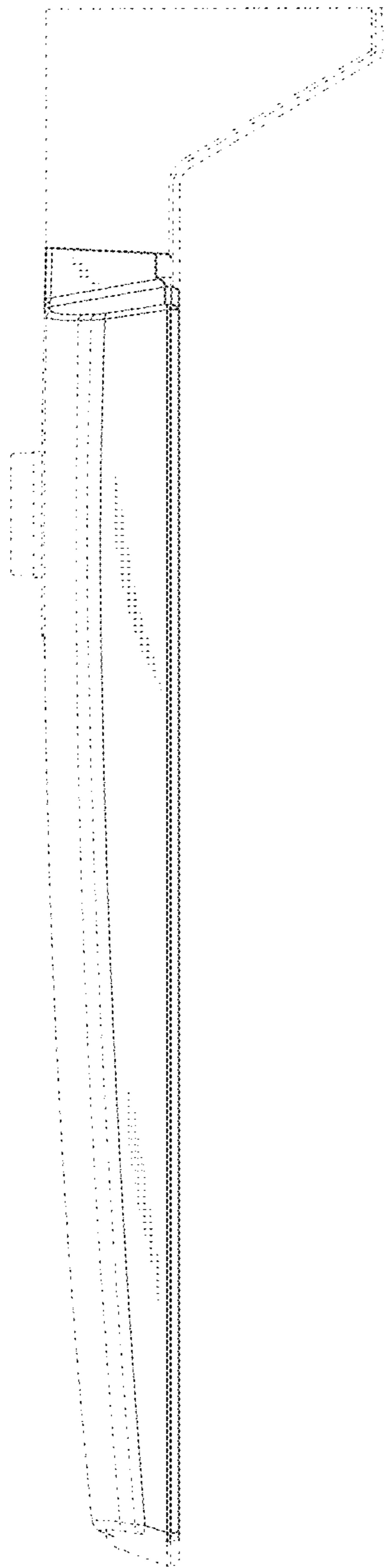

FIG. 16
AMENDED

