



US00RE46460E

(19) **United States**
(12) **Reissued Patent**
Kroll

(10) **Patent Number: US RE46,460 E**
(45) **Date of Reissued Patent: Jul. 4, 2017**

(54) **CROSS-SHAPED DISPLAY STAND**

(71) Applicant: **William F. Kroll**, Boca Raton, FL (US)

(72) Inventor: **William F. Kroll**, Boca Raton, FL (US)

(21) Appl. No.: **29/519,869**

(22) Filed: **Mar. 9, 2015**

Related U.S. Patent Documents

Reissue of:

(64) Patent No.: **Des. 659,431**
Issued: **May 15, 2012**
Appl. No.: **29/400,195**
Filed: **Aug. 24, 2011**

U.S. Applications:

(62) Division of application No. 29/463,818, filed on Mar. 12, 2014, now Pat. No. Re. 45,428, which is an application for the reissue of Pat. No. Des. 659,431.

(51) **LOC (10) Cl.** **06-04**

(52) **U.S. Cl.**
USPC **D6/674**

(58) **Field of Classification Search**
USPC D6/300-314, 674; D20/15; D11/157,
D11/125, 122; D99/5, 23, 27; D26/4, 94
CPC A47G 33/00; A47G 33/02
See application file for complete search history.

(56) **References Cited**

U.S. PATENT DOCUMENTS

D67,289	S	*	5/1925	Ladwwich	D99/23
D103,027	S	*	2/1937	Slattery	D99/27
D137,421	S	*	3/1944	Rasmussen	D99/23
D159,891	S	*	8/1950	Chevalier	D99/27
D160,900	S	*	11/1950	Suhren	D6/450
D168,686	S	*	1/1953	Hunter	D6/450

(Continued)

Primary Examiner — Phillip S Hyder

(74) *Attorney, Agent, or Firm* — Mark D. Bowen; Malin Haley DiMaggio & Bowen, P.A.

(57) **CLAIM**

The ornamental design for a cross-shaped display stand, as shown and described.

DESCRIPTION

This application is a reissue divisional application of 29/463,818, filed on Mar. 12, 2014, now U.S. Pat. No. RE45,428, which is an application for reissue of U.S. Design Pat. No. D659,431.

FIG. 1 is a front perspective view of a cross-shaped display stand in accordance with the present invention;

FIG. 2 is a rear perspective view thereof;

FIG. 3 is a bottom perspective view thereof;

FIG. 4 is a front *elevation* view thereof;

FIG. 5 is a rear *elevation* view thereof;

FIG. 6 is a side *elevation* view thereof, *the opposing side elevation view being a mirror image;*

FIG. 7 is a top *plan* view thereof; [and,]

FIG. 8 is a bottom *plan* view thereof[.];

FIG. 9 is a front perspective view of a second embodiment cross-shaped display stand in accordance with the present invention;

FIG. 10 is a rear perspective view thereof;

FIG. 11 is a bottom perspective view thereof;

FIG. 12 is a front elevation view thereof;

FIG. 13 is a rear elevation view thereof;

FIG. 14 is a side elevation view thereof, the opposing side elevation view being a mirror image;

FIG. 15 is a top view thereof; and,

FIG. 16 is a bottom view thereof.

The dot-dash broken lines in FIGS. 1 through 16 represent the boundaries between claimed and non-claimed subject matter.

1 Claim, 12 Drawing Sheets

Matter enclosed in heavy brackets [] appears in the original patent but forms no part of this reissue; matter printed in italics indicates the additions made by reissue.

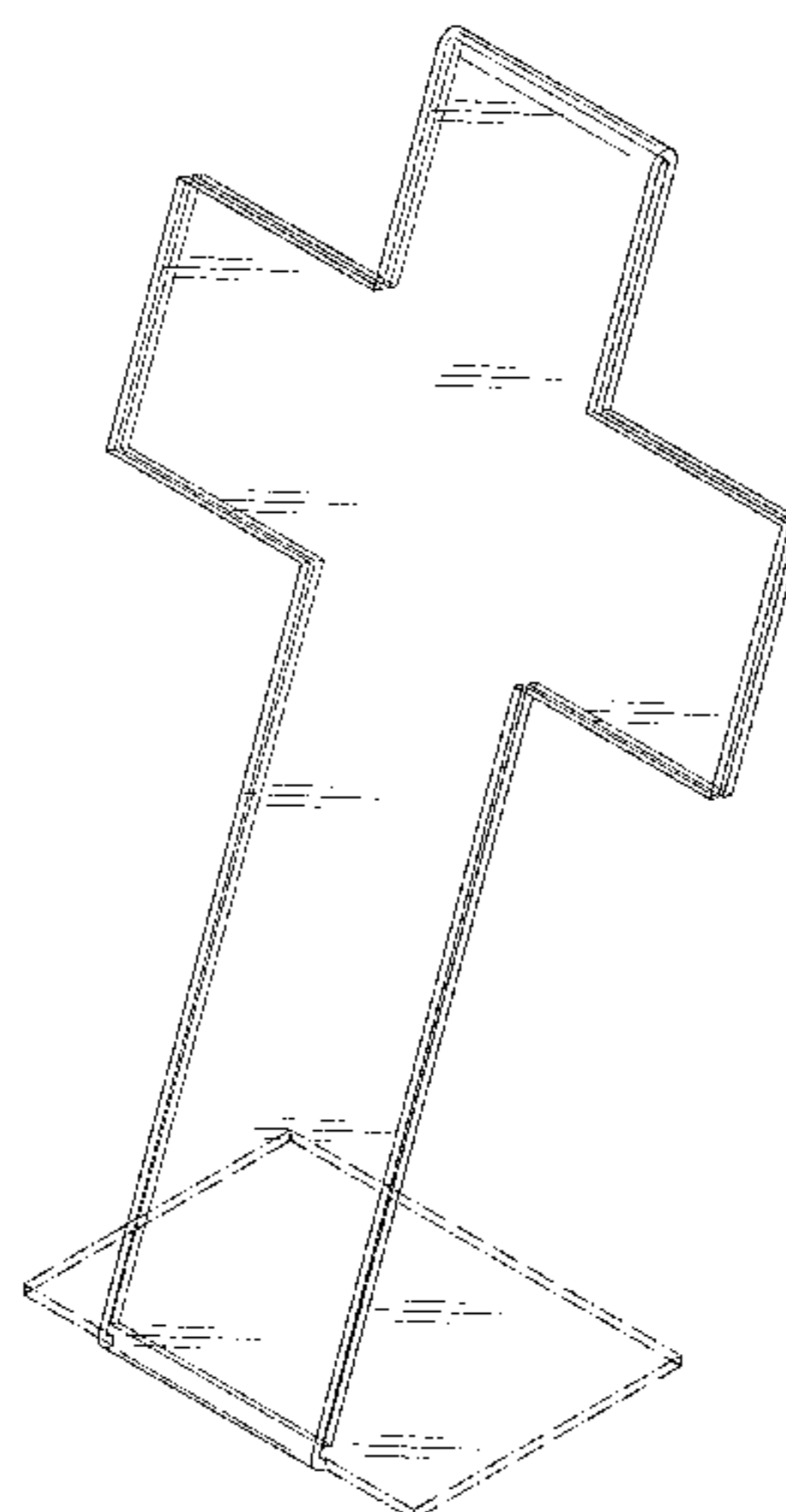

(Amended)

(56)

References Cited

U.S. PATENT DOCUMENTS

D256,398	S	8/1980	Mitchell	
D338,081	S *	8/1993	Klaffer	D26/94
D338,315	S	8/1993	Larson	
D370,282	S *	5/1996	Grether	D26/4
D408,653	S *	4/1999	Dotson et al.	D6/450
D412,461	S *	8/1999	McGrew	D11/122
D431,206	S *	9/2000	Byers	D11/125
D440,734	S *	4/2001	Berry	D99/23
D443,970	S *	6/2001	Stucker	D99/27
D481,223	S *	10/2003	Locker et al.	D6/470
D518,939	S *	4/2006	Borgerding	D99/5
D578,275	S *	10/2008	Shantz	D99/17
D618,135	S *	6/2010	Horst	D11/157
D619,926	S *	7/2010	Letney	D11/157
D649,594	S *	11/2011	Yi et al.	D20/15
D654,828	S	2/2012	Piric	
D685,675	S	7/2013	Dubow	

* cited by examiner

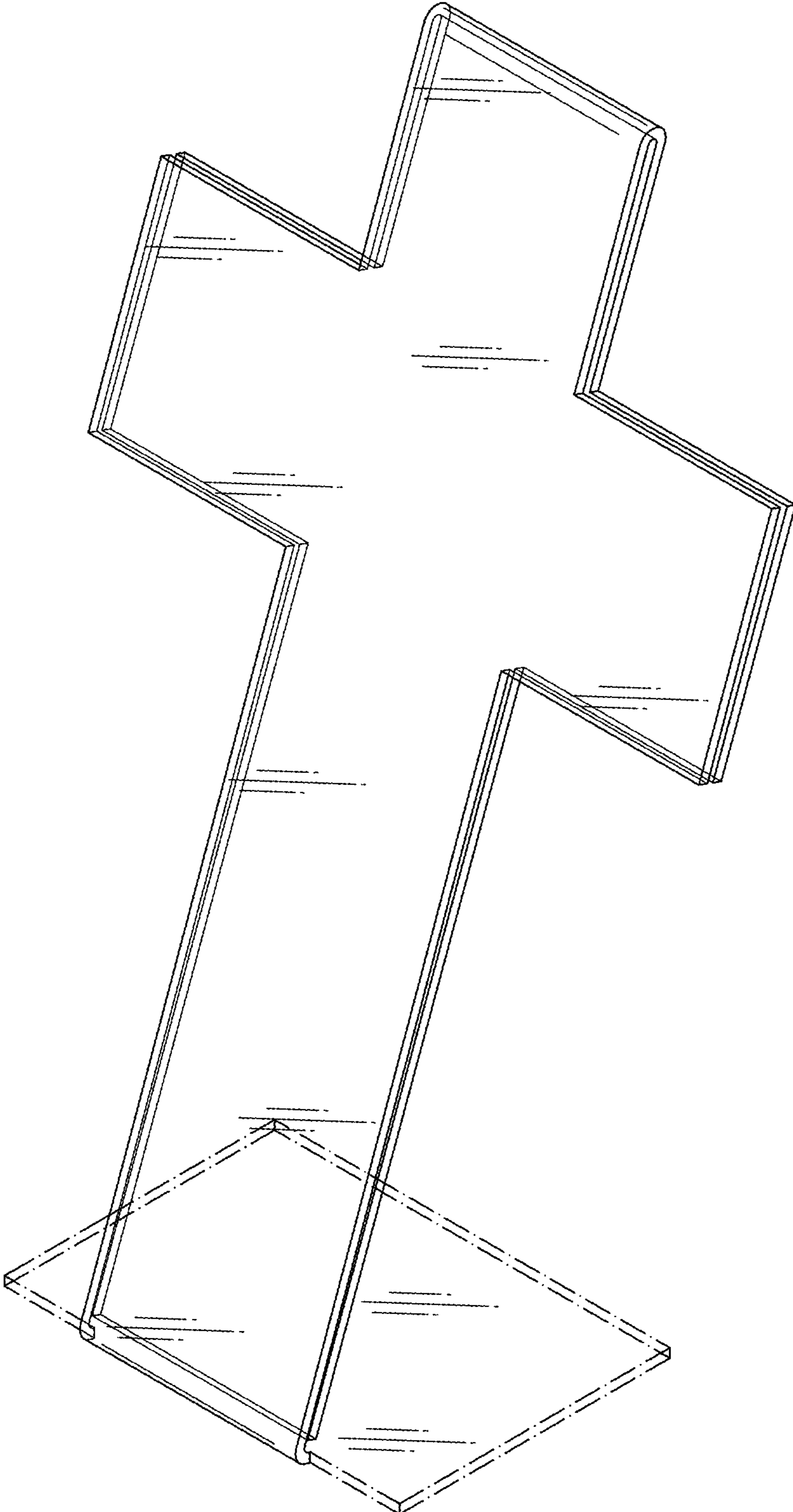

FIG. 1
(Amended)

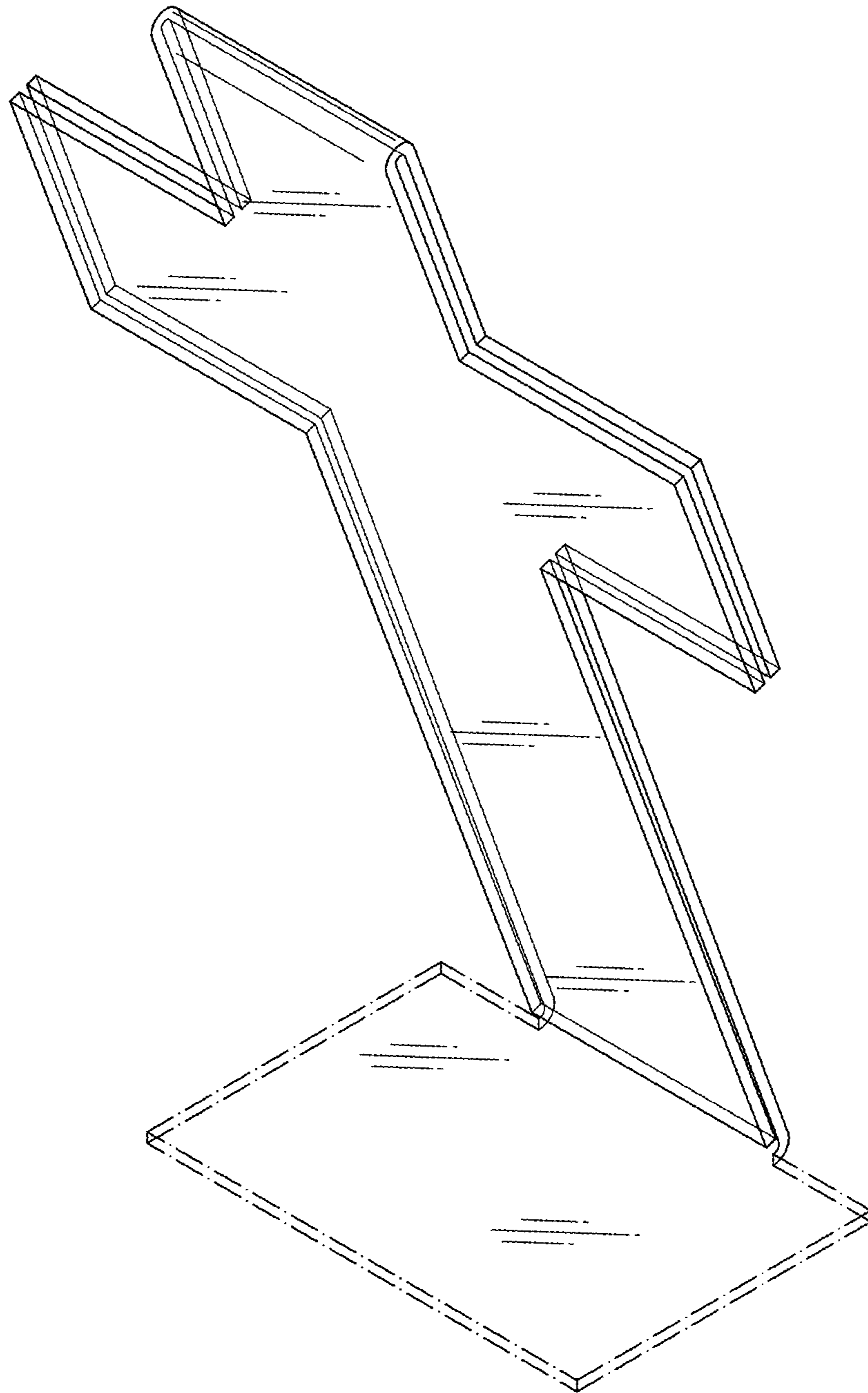

FIG. 2

(Amended)

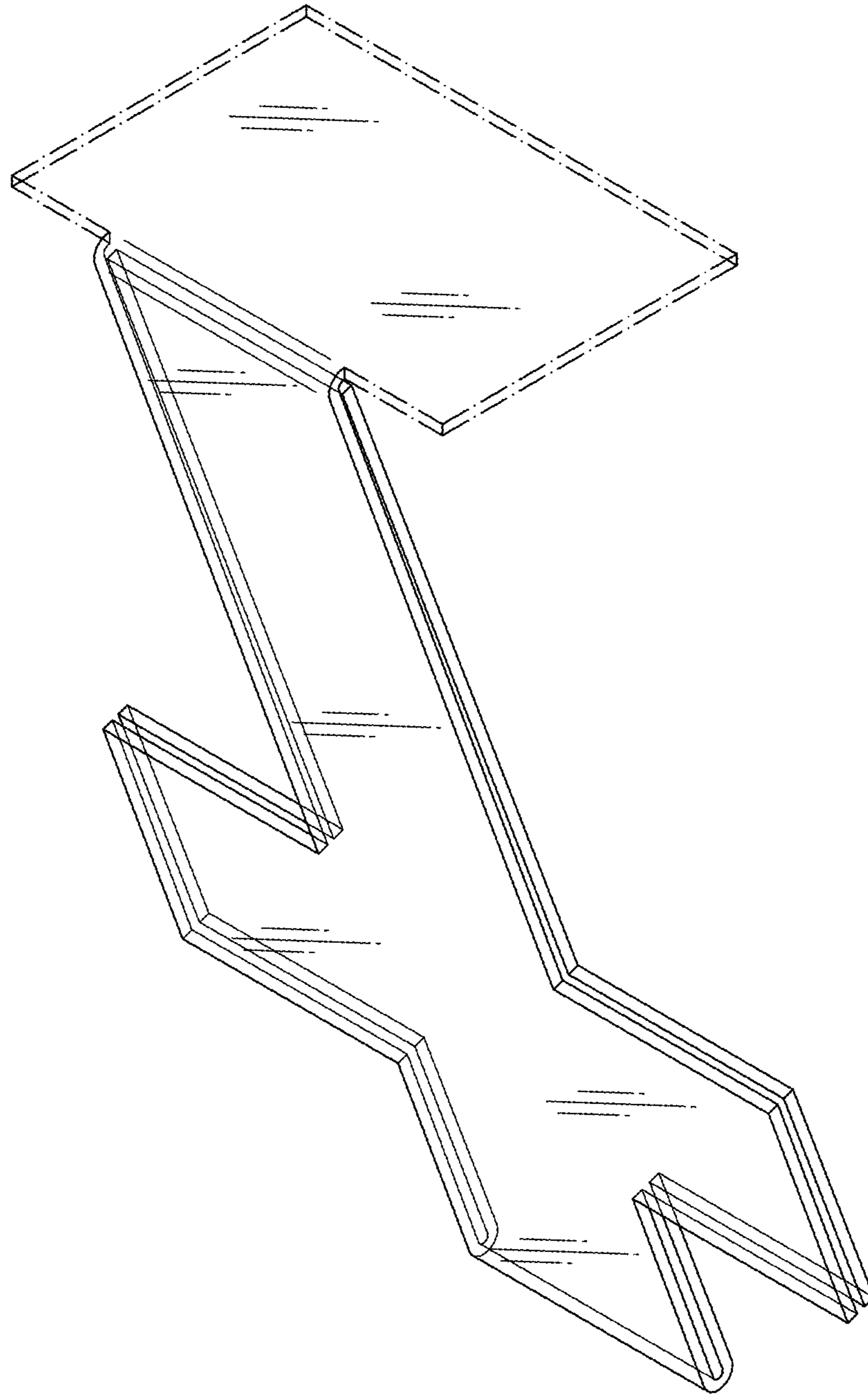

FIG. 3

(Amended)

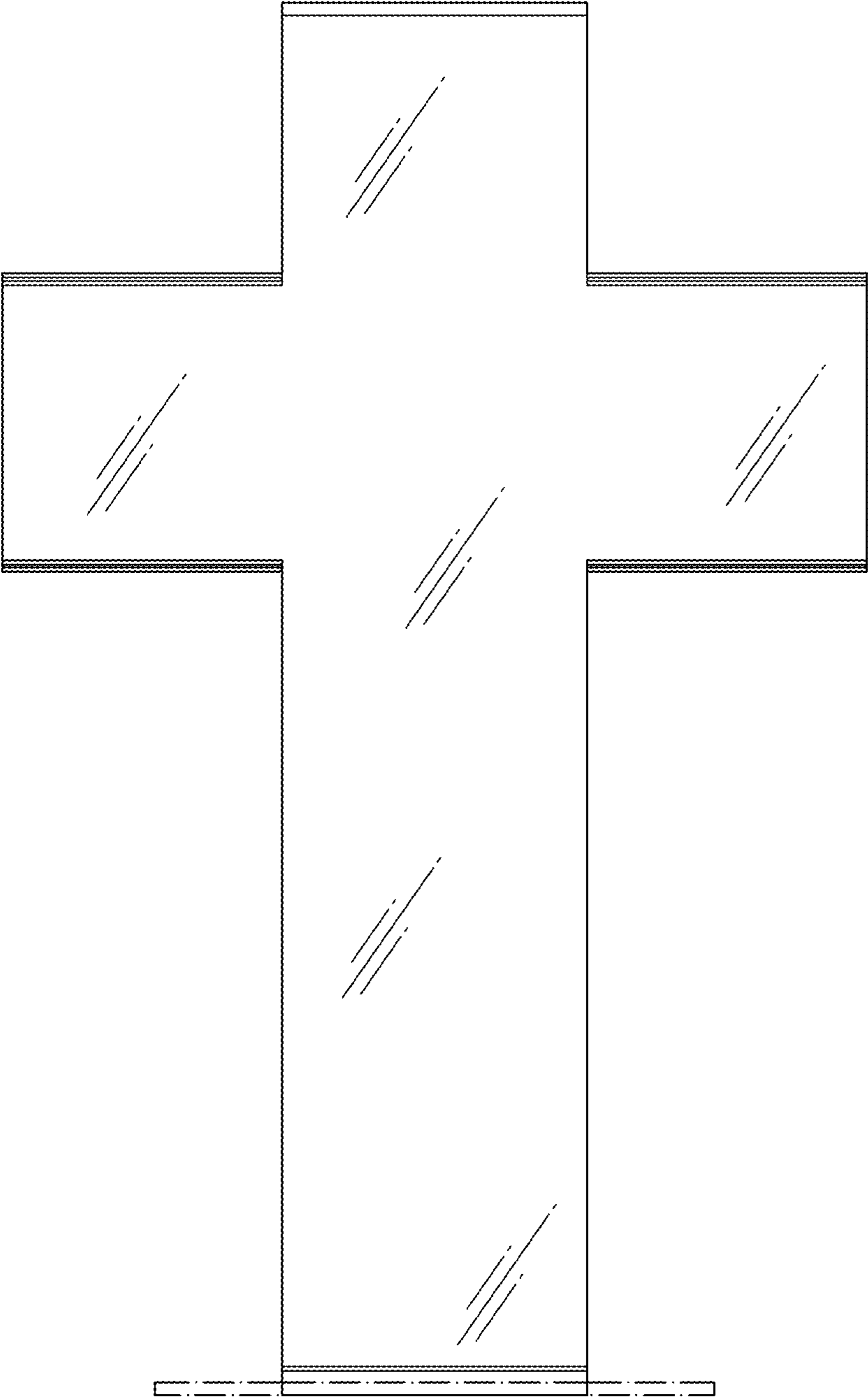

FIG. 4
(Amended)

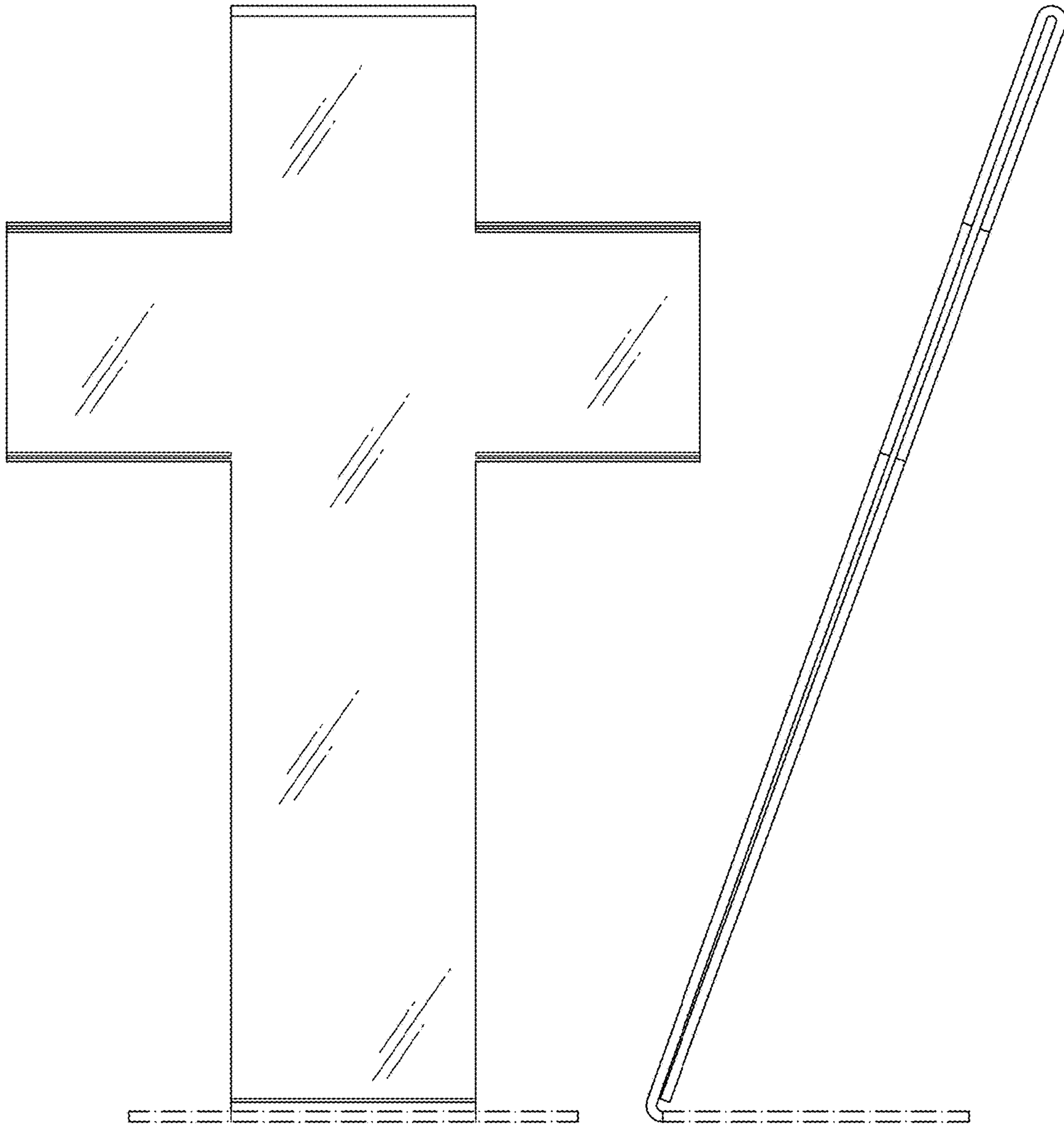

FIG. 5
(Amended)

FIG. 6
(Amended)

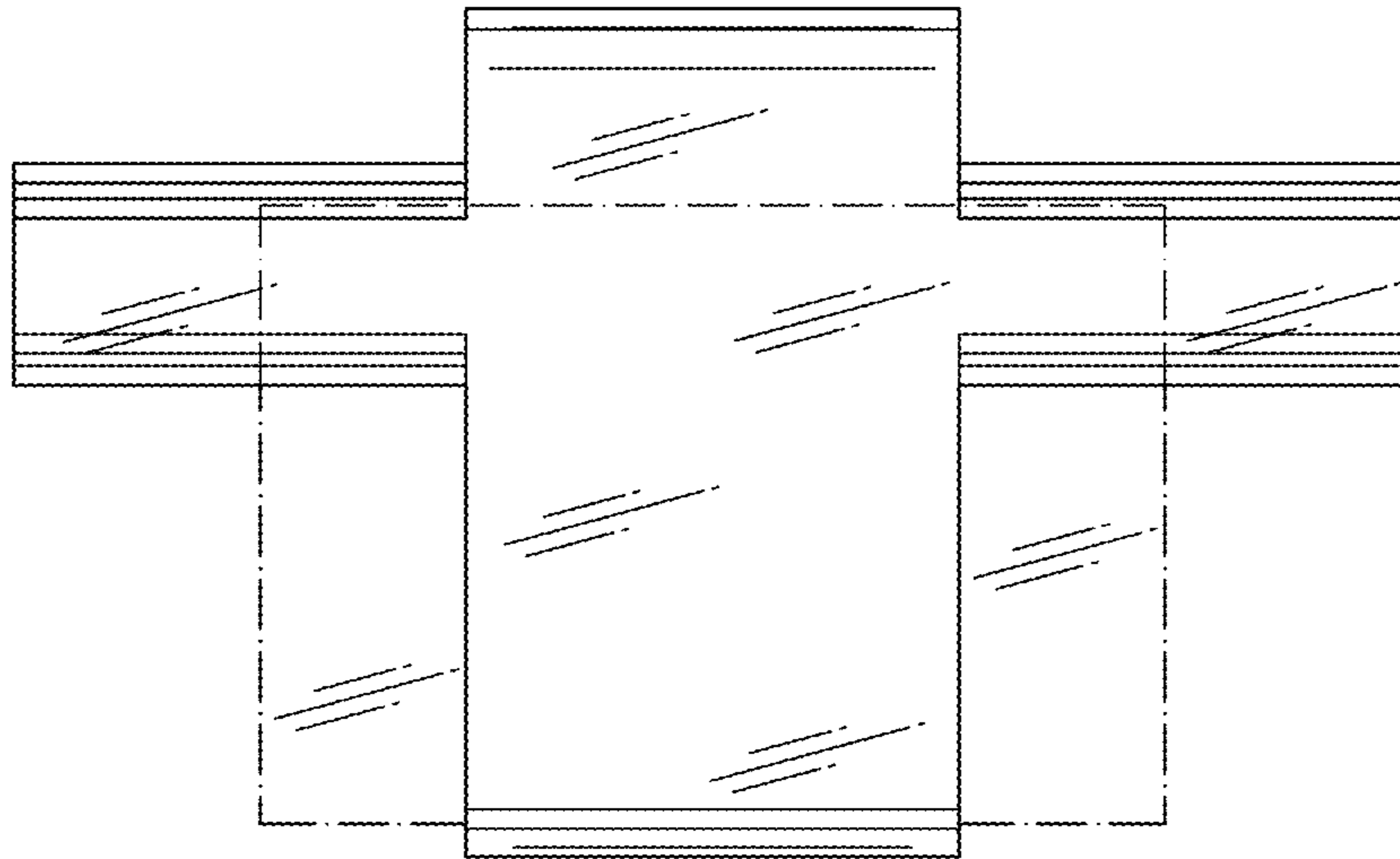

FIG. 7

(Amended)

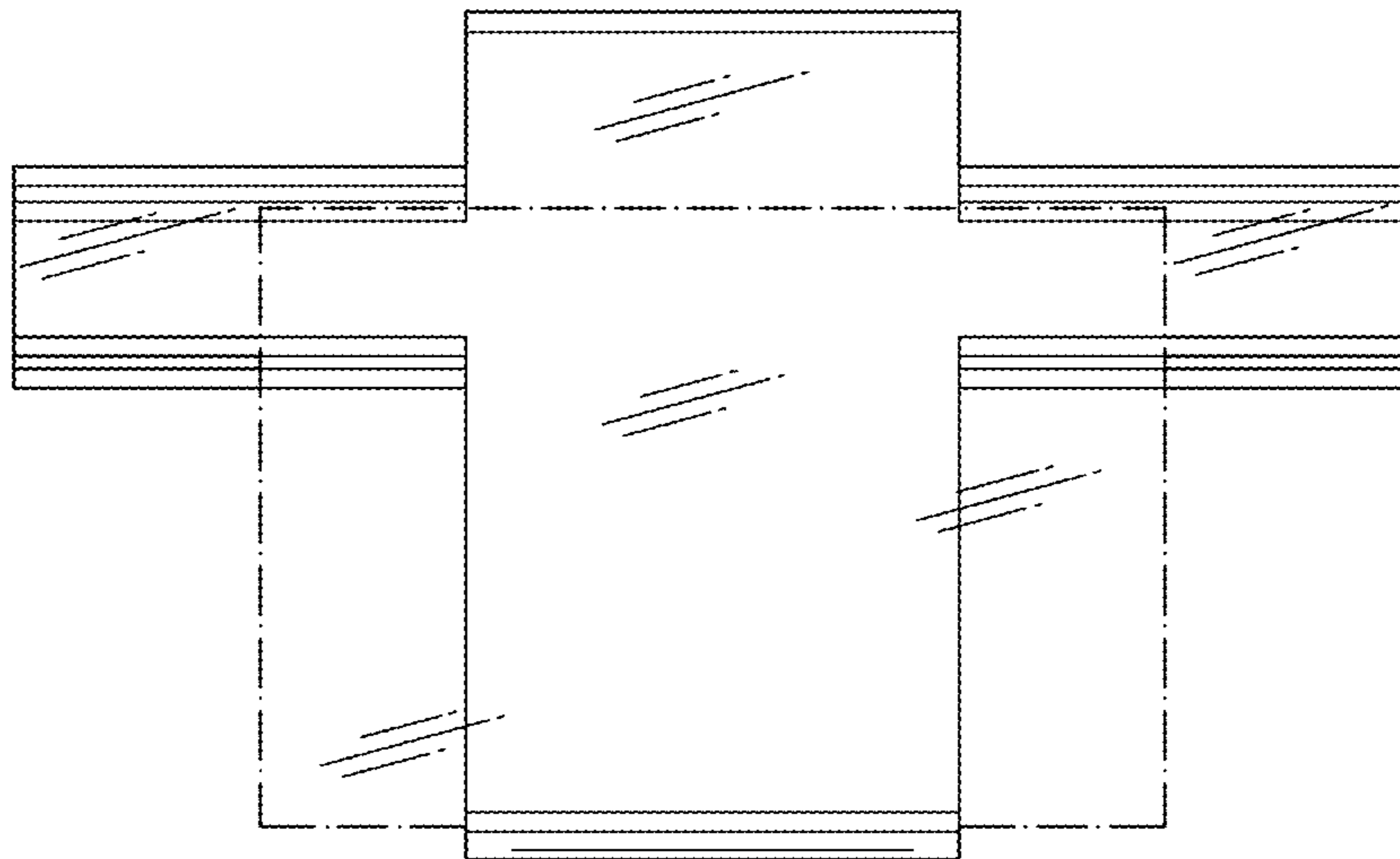

FIG. 8

(Amended)

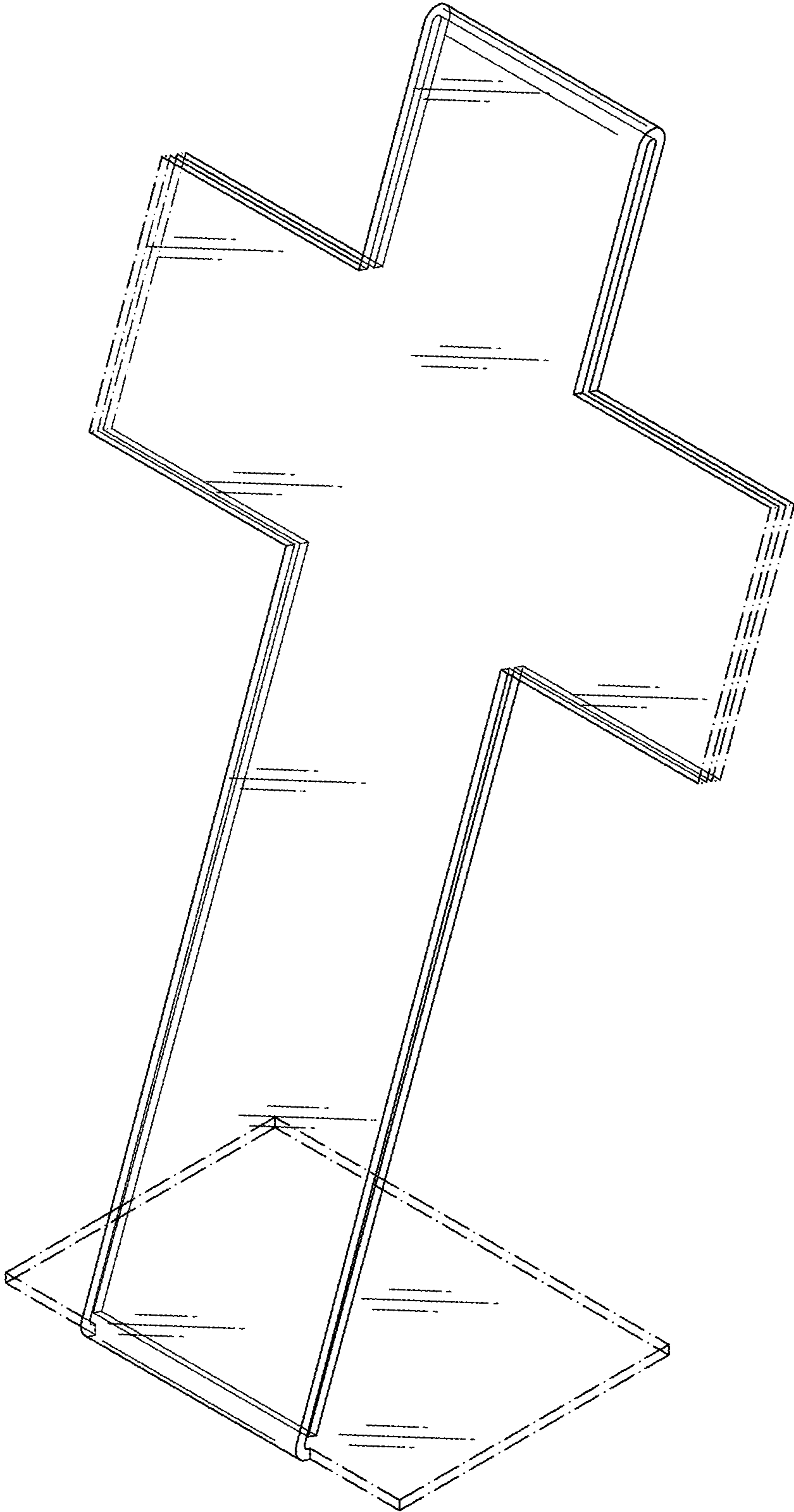

FIG. 9
(New)

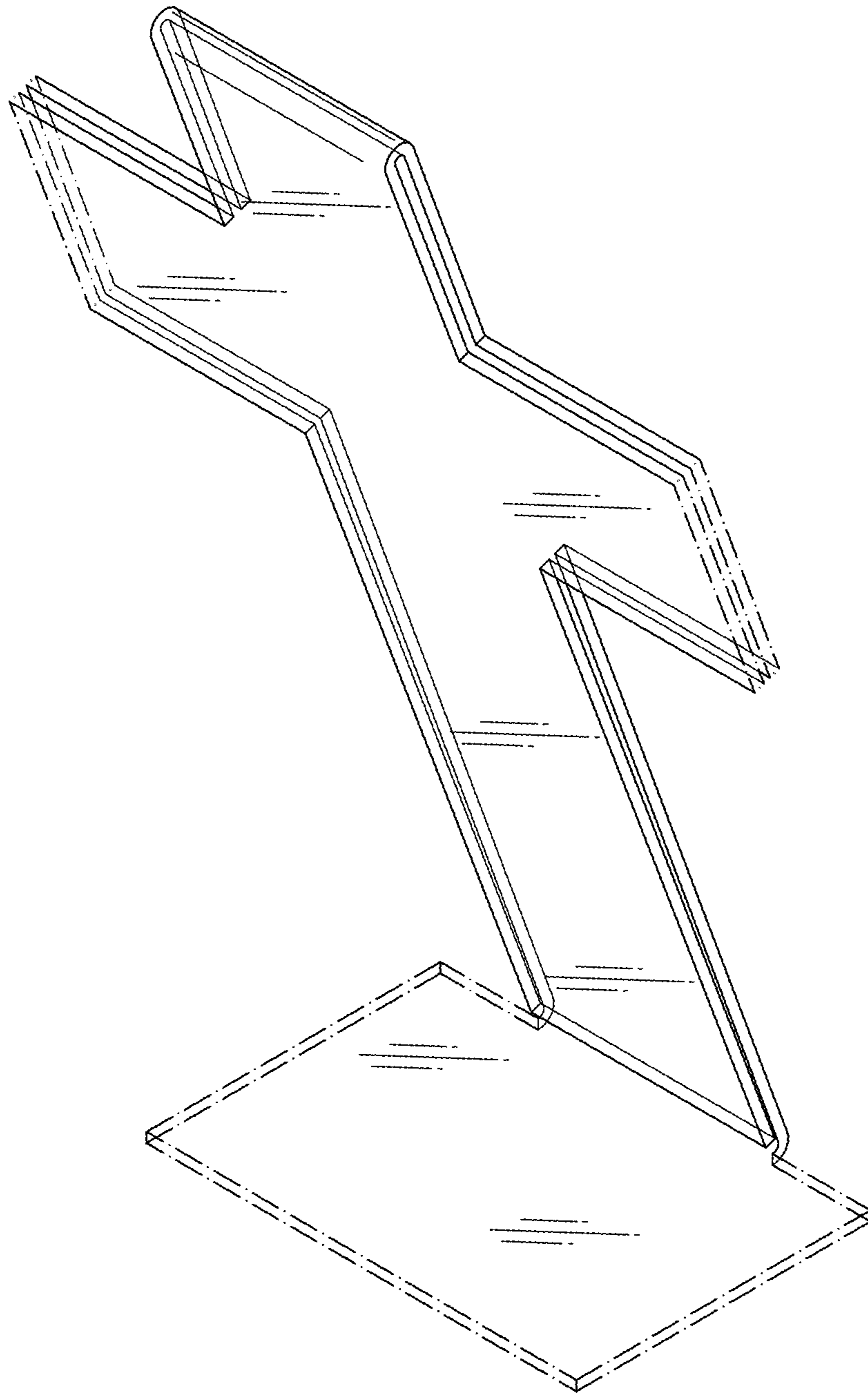

FIG. 10

(New)

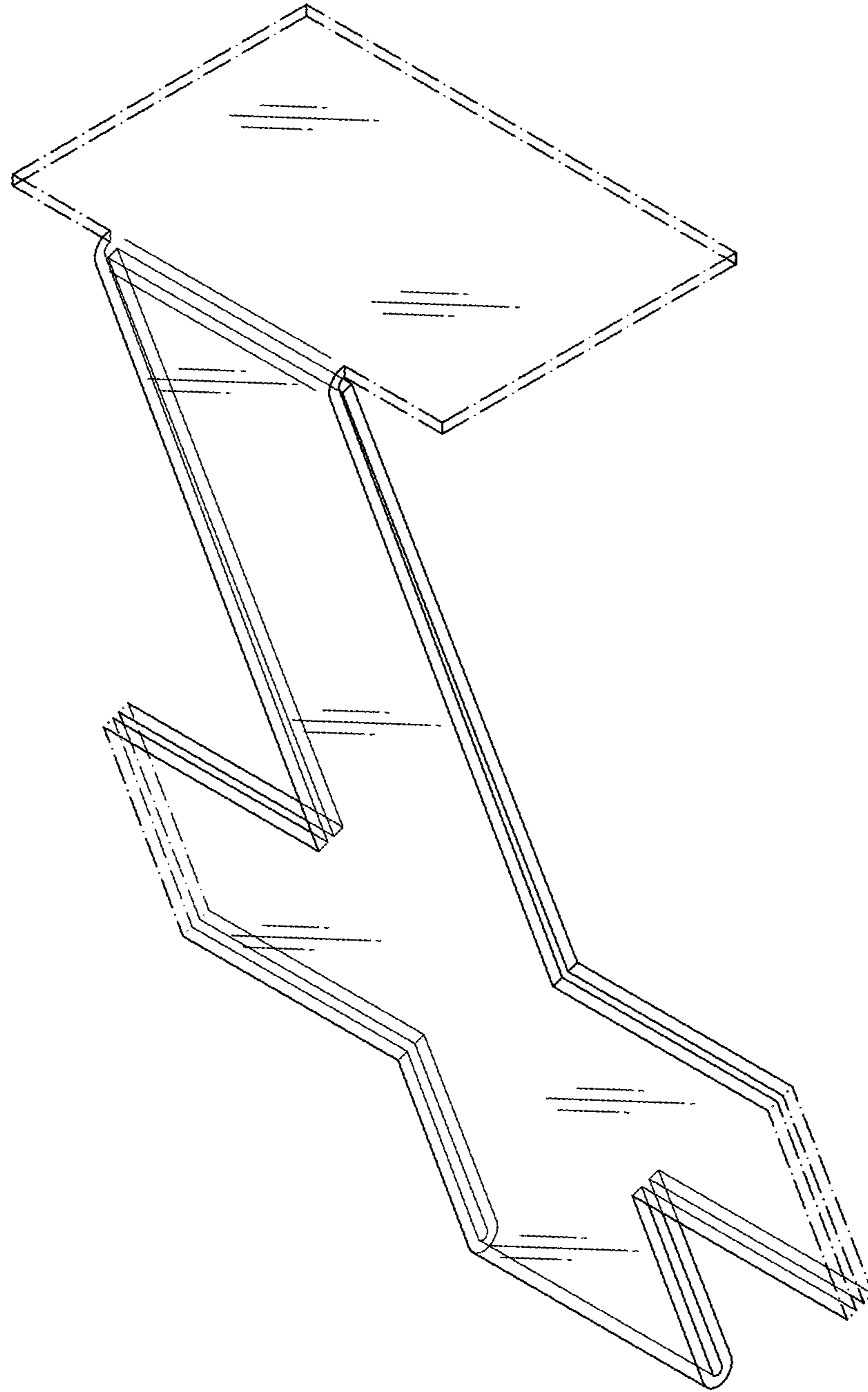

FIG. 11

(New)

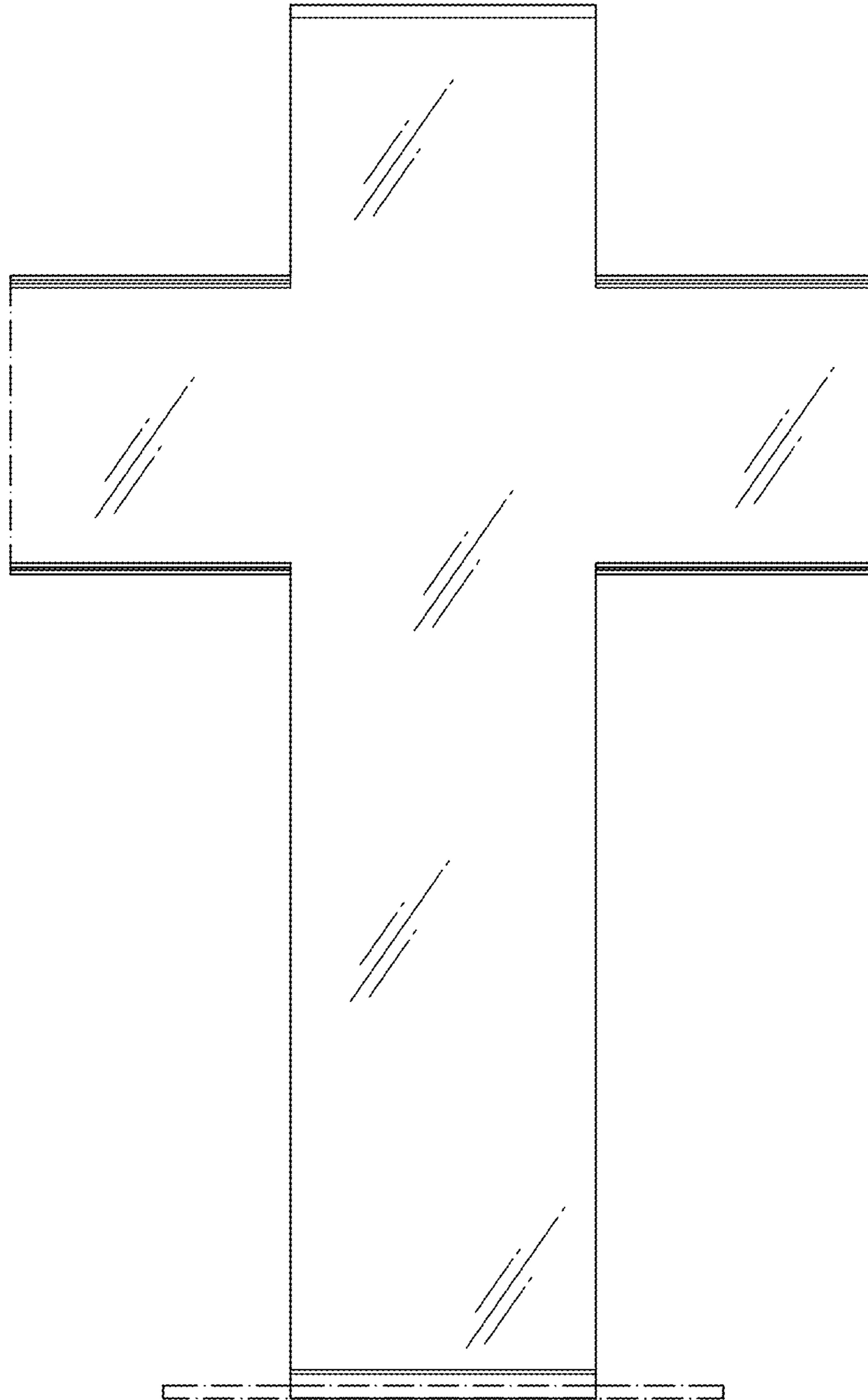

FIG. 12

(New)

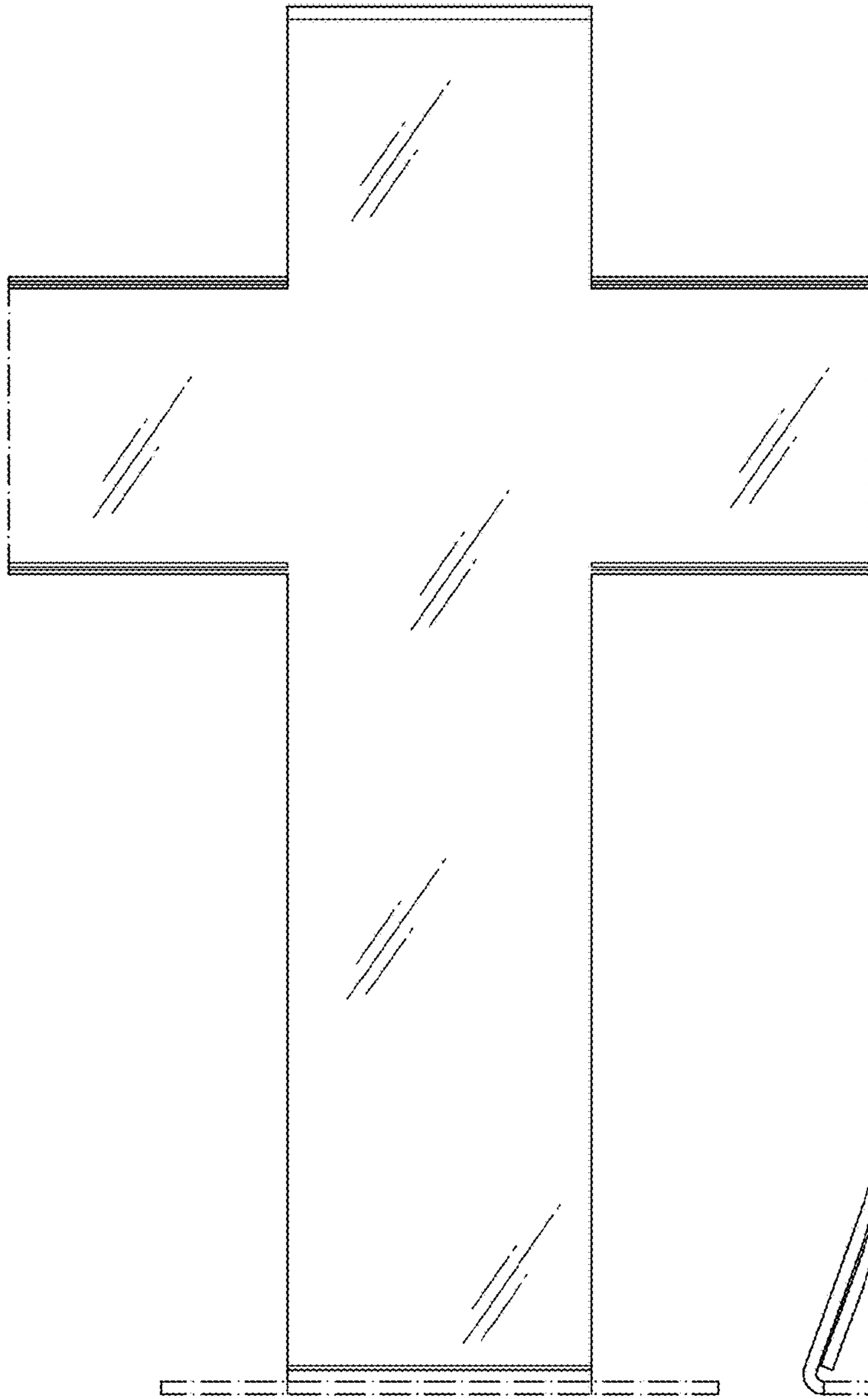

FIG. 13
(New)

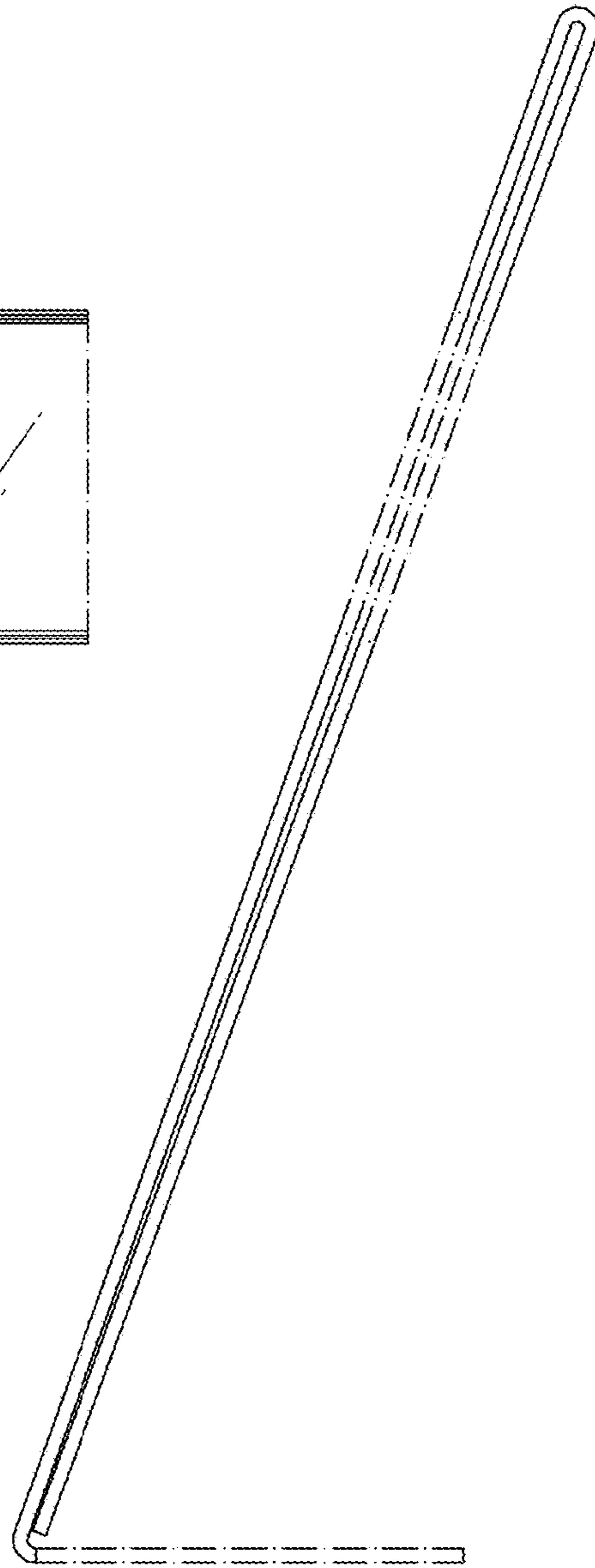

FIG. 14
(New)

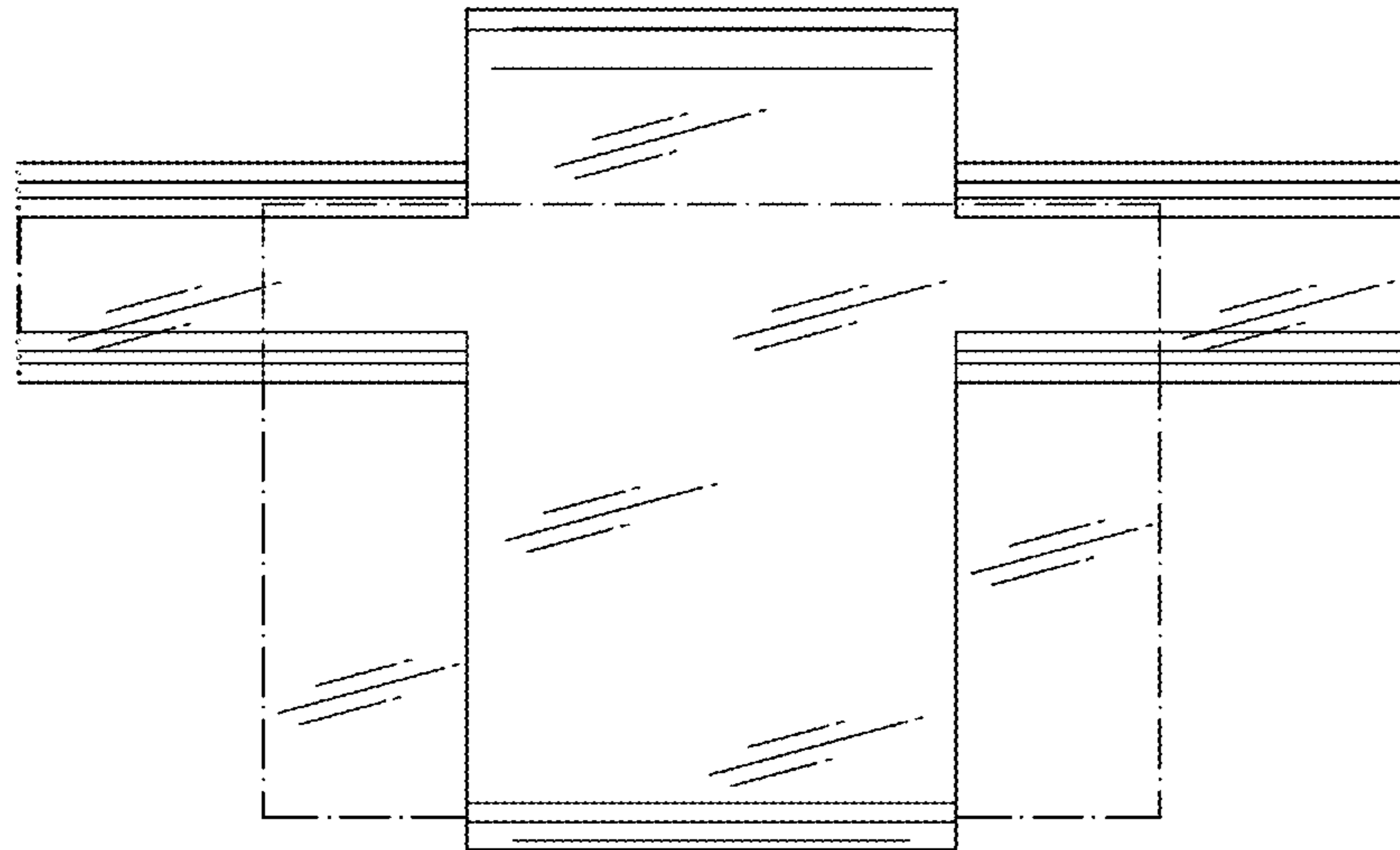

FIG. 15

(New)

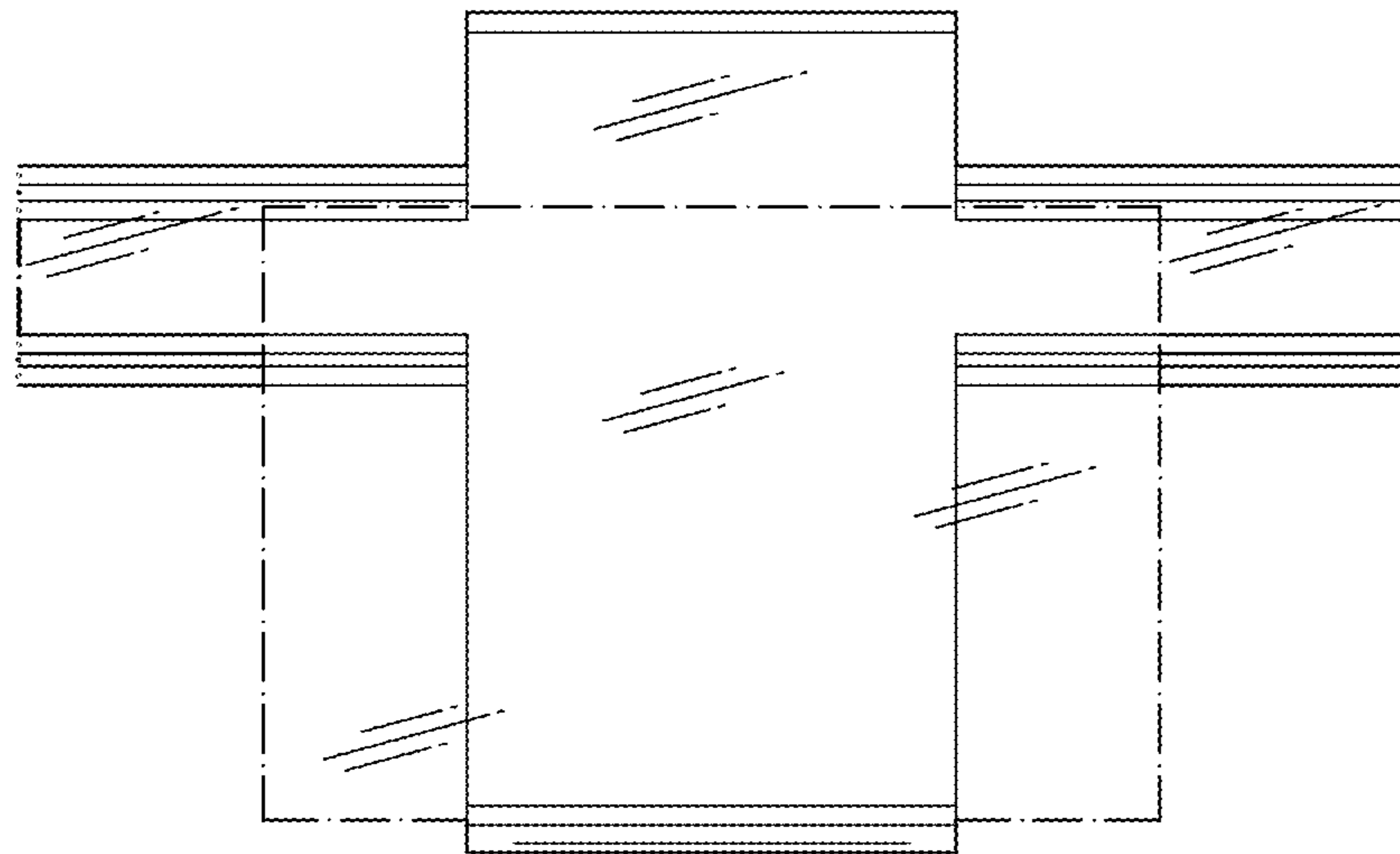

FIG. 16

(New)