

US00RE45985E

(19) **United States**
(12) **Reissued Patent**
McAuley et al.

(10) **Patent Number:** **US RE45,985 E**
(45) **Date of Reissued Patent:** **Apr. 26, 2016**

(54) **FACE MASK**
(75) Inventors: **Alastair Edwin McAuley**, Auckland (NZ); **Christopher Earl Nightingale**, Auckland (NZ); **Aidan Mark Shotbolt**, Highland Park (NZ)
(73) Assignee: **Fisher & Paykel Healthcare Limited**, Auckland (NZ)

6,926,004 B2 * 8/2005 Schumacher 128/206.27
D515,204 S * 2/2006 Guney et al. D24/110.1
D519,207 S * 4/2006 Raje et al. D24/110.1
D549,332 S * 8/2007 Matsumoto et al. D24/138
D558,334 S * 12/2007 Stallard et al. D24/110.1
D586,458 S * 2/2009 Kooij et al. D24/110.1
D586,906 S * 2/2009 Stallard et al. D24/110.1
D591,420 S * 4/2009 Selvarajan et al. D24/110.1
D594,112 S * 6/2009 Nga et al. D24/110.1

(Continued)

(21) Appl. No.: **29/382,614**
(22) Filed: **Jan. 5, 2011**

Primary Examiner — Phillip S Hyder

(74) *Attorney, Agent, or Firm* — Knobbe, Martens, Olson & Bear, LLP

Related U.S. Patent Documents

Reissue of:

(64) Patent No.: **Des. 584,400**
Issued: **Jan. 6, 2009**
Appl. No.: **29/210,289**
Filed: **Jul. 29, 2004**

(57) **CLAIM**

The ornamental design for a face mask, as shown and described.

(51) **LOC (10) Cl.** **29-02**
(52) **U.S. Cl.**
USPC **D24/110.1**

DESCRIPTION

(58) **Field of Classification Search**
USPC D24/110, 110.4, 110.5; 128/205.25, 128/206.12, 206.21, 206.28, 207.13
See application file for complete search history.

FIG. 1 is a perspective view of the face mask in accordance with our design;
FIG. 2 is a front elevational view of the face mask;
FIG. 3 is a left side elevational view of the face mask;
FIG. 4 is a right side elevational view of the face mask;
FIG. 5 is a top plan view of the face mask;
FIG. 6 is a bottom plan view of the face mask; and,
FIG. 7 is a rear elevational view of the face mask.

(56) **References Cited**

U.S. PATENT DOCUMENTS

D271,246 S * 11/1983 Matheson et al. D24/110.1
D303,587 S * 9/1989 Quinn et al.
D305,166 S * 12/1989 Quinn et al.
4,960,121 A * 10/1990 Nelson et al. 128/206.24
D323,908 S * 2/1992 Hollister et al.
D349,586 S * 8/1994 Handke
D397,215 S * 8/1998 Hoftman
D476,732 S * 7/2003 Smart D24/110.4
D492,992 S * 7/2004 Guney et al. D24/110.1
D493,885 S * 8/2004 Raje et al. D24/110.1
6,860,269 B2 * 3/2005 Kwok et al. 128/207.11
D506,827 S * 6/2005 Jones et al. D24/110.1
D507,831 S * 7/2005 Rosenkranz et al. D24/110.1

The portions of the face mask shown in dashed lines form no part of the claimed design. The portions of the face mask within the dashed line boundary surrounding an interior of the seal of the face mask in FIG. 7 for no part of the claimed design.

1 Claim, 7 Drawing Sheets

Matter enclosed in heavy brackets [] appears in the original patent but forms no part of this reissue; matter printed in italics indicates the additions made by reissue.

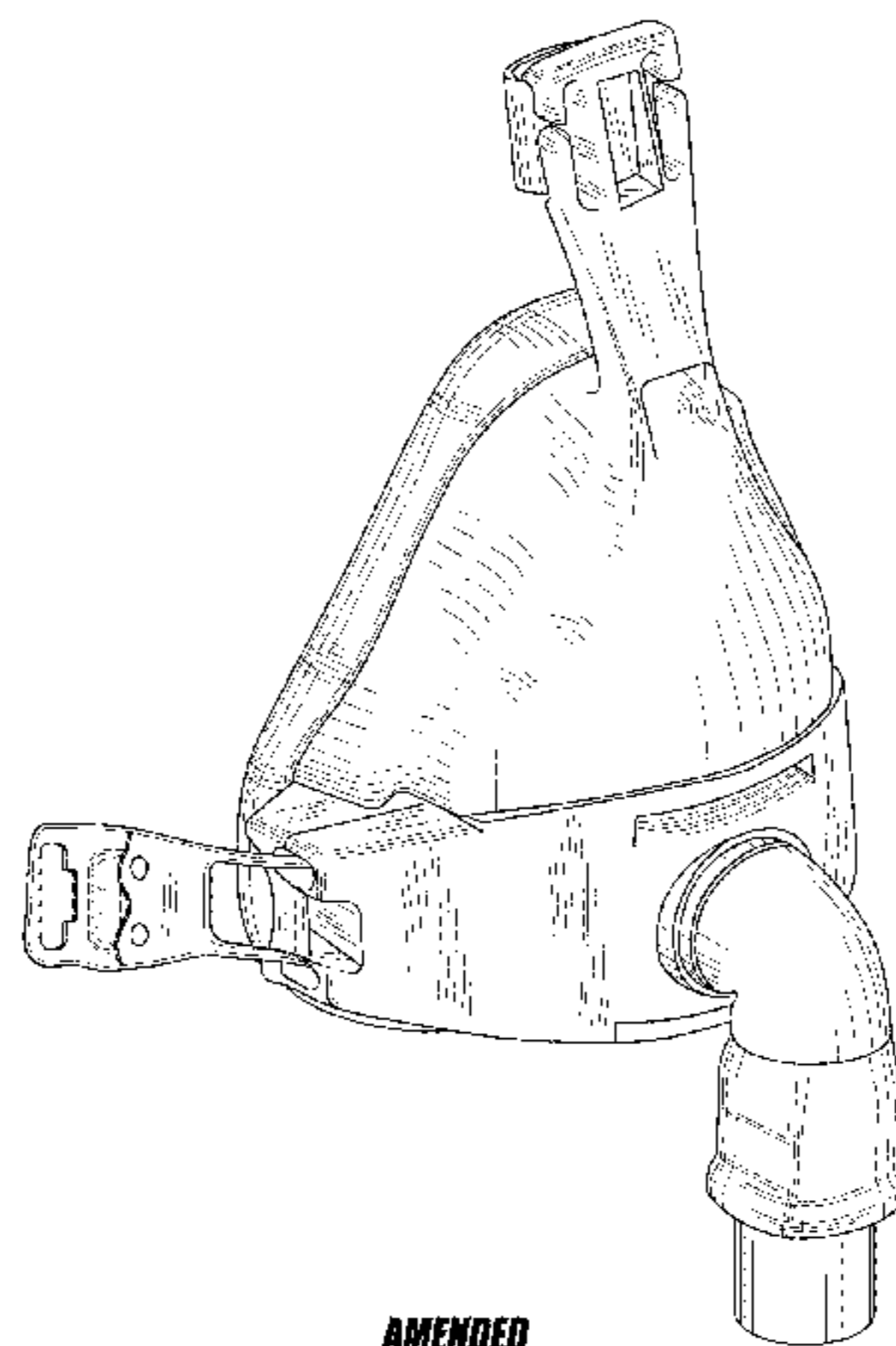

AMENDED

US RE45,985 E

Page 2

(56)

References Cited

U.S. PATENT DOCUMENTS

D597,202 S * 7/2009 Reid et al. D24/110.1
D597,660 S * 8/2009 Maurer D24/110.1
D597,661 S * 8/2009 Reid et al. D24/110.1

D612,932 S * 3/2010 Davidson et al. D24/110.1
D665,494 S * 8/2012 Stallard et al. D24/110.1
2003/0034034 A1 * 2/2003 Kwok et al. 128/206.21
2004/0118406 A1 * 6/2004 Lithgow et al. 128/206.24

* cited by examiner

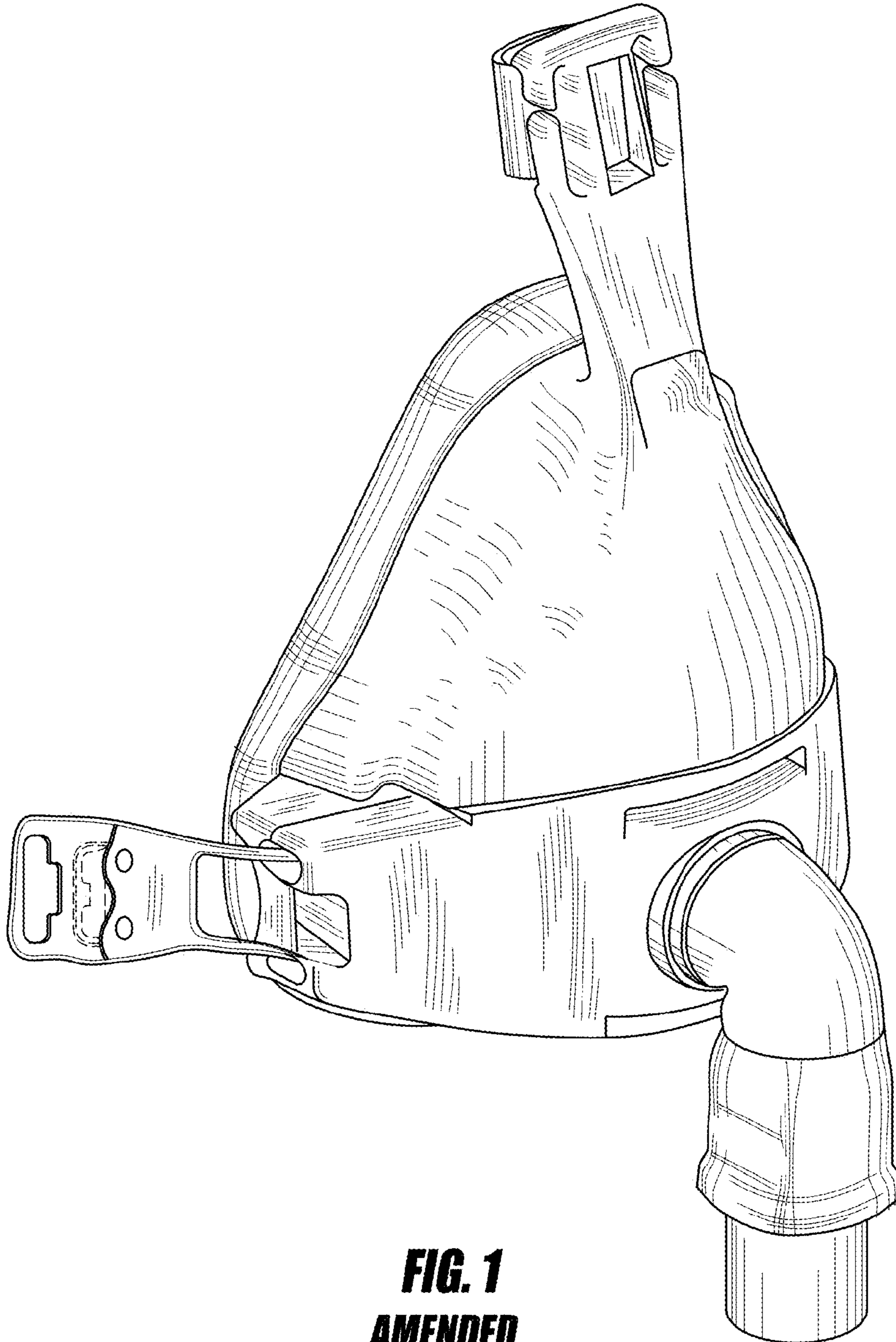

FIG. 1
AMENDED

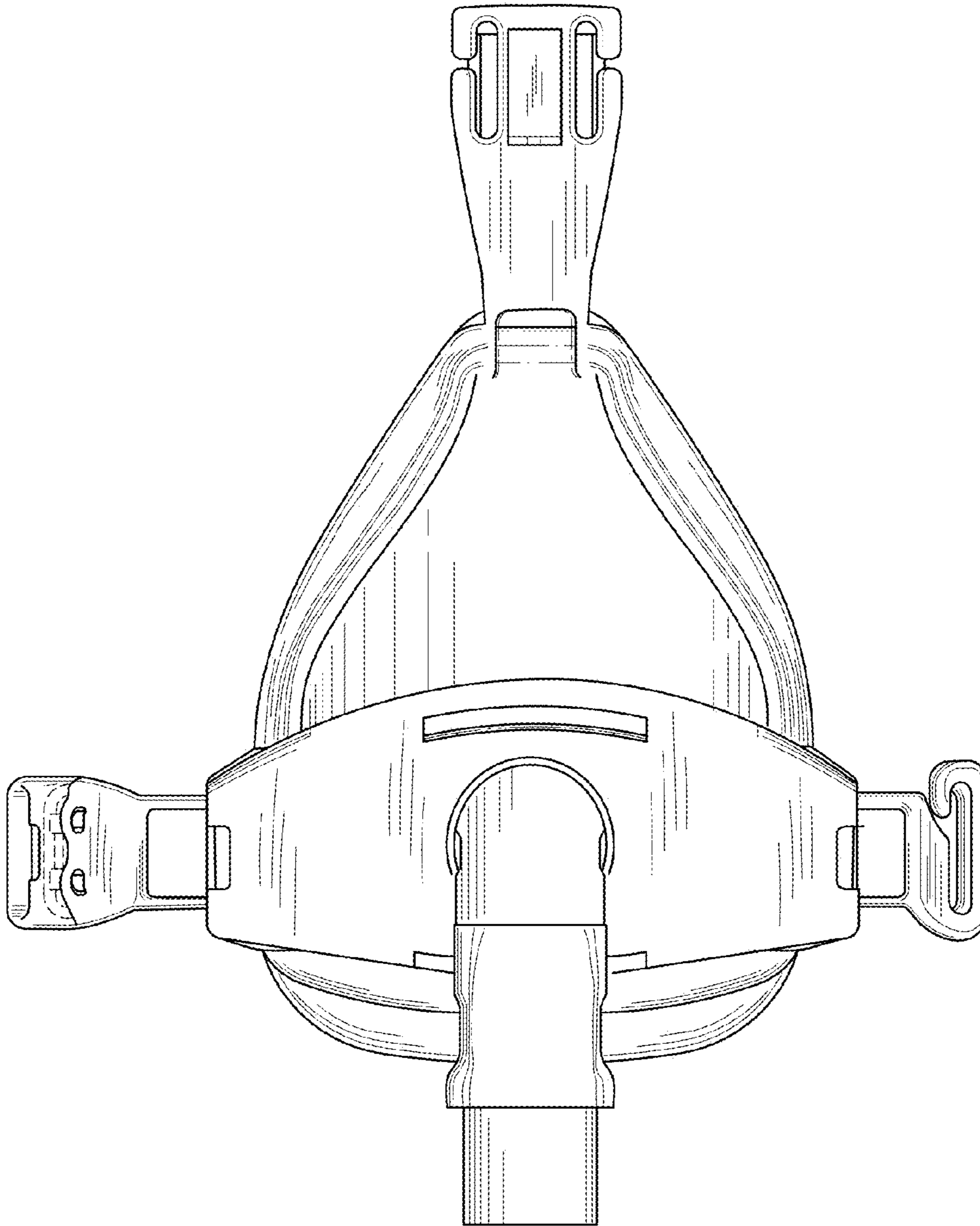

FIG. 2
AMENDED

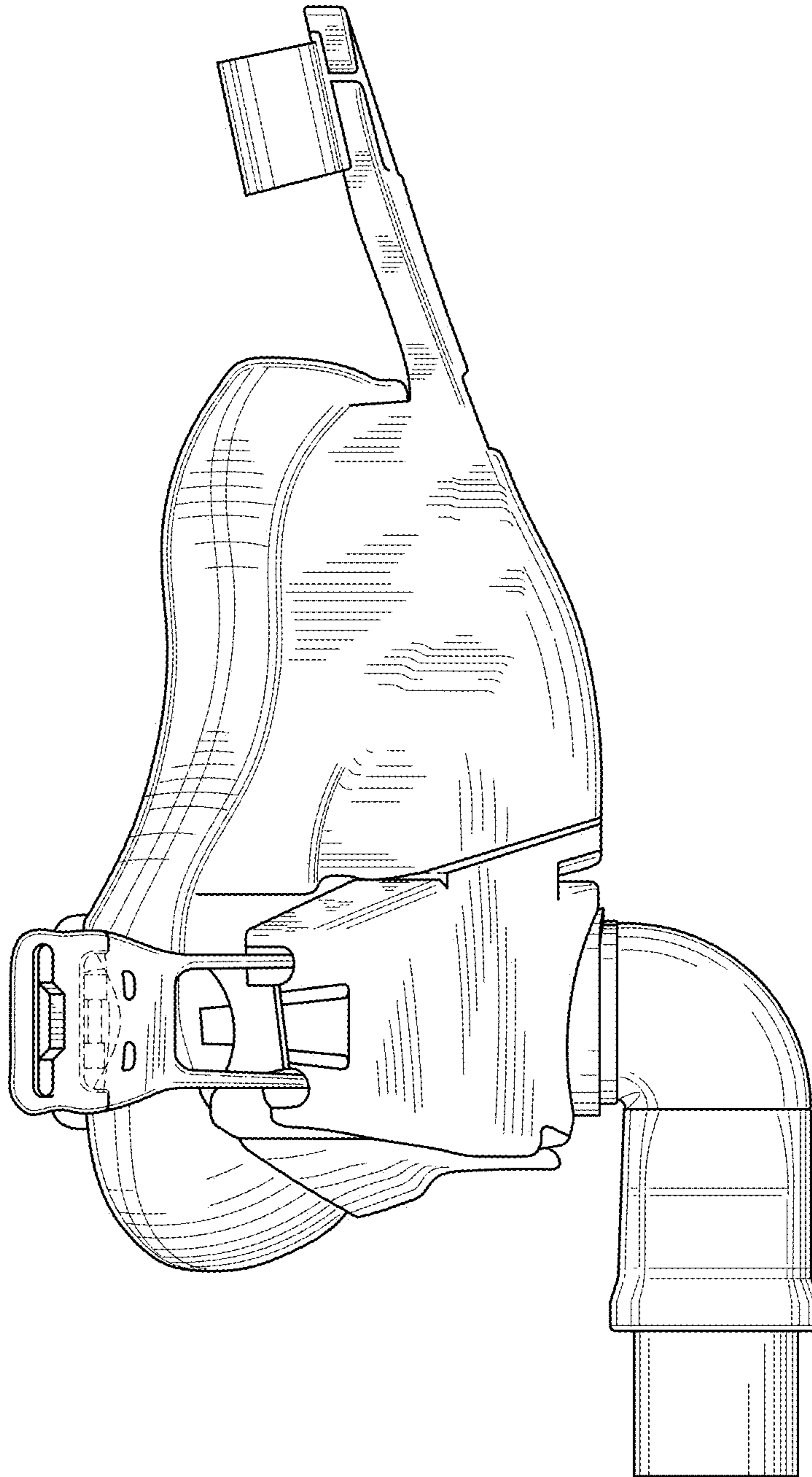

FIG. 3
AMENDED

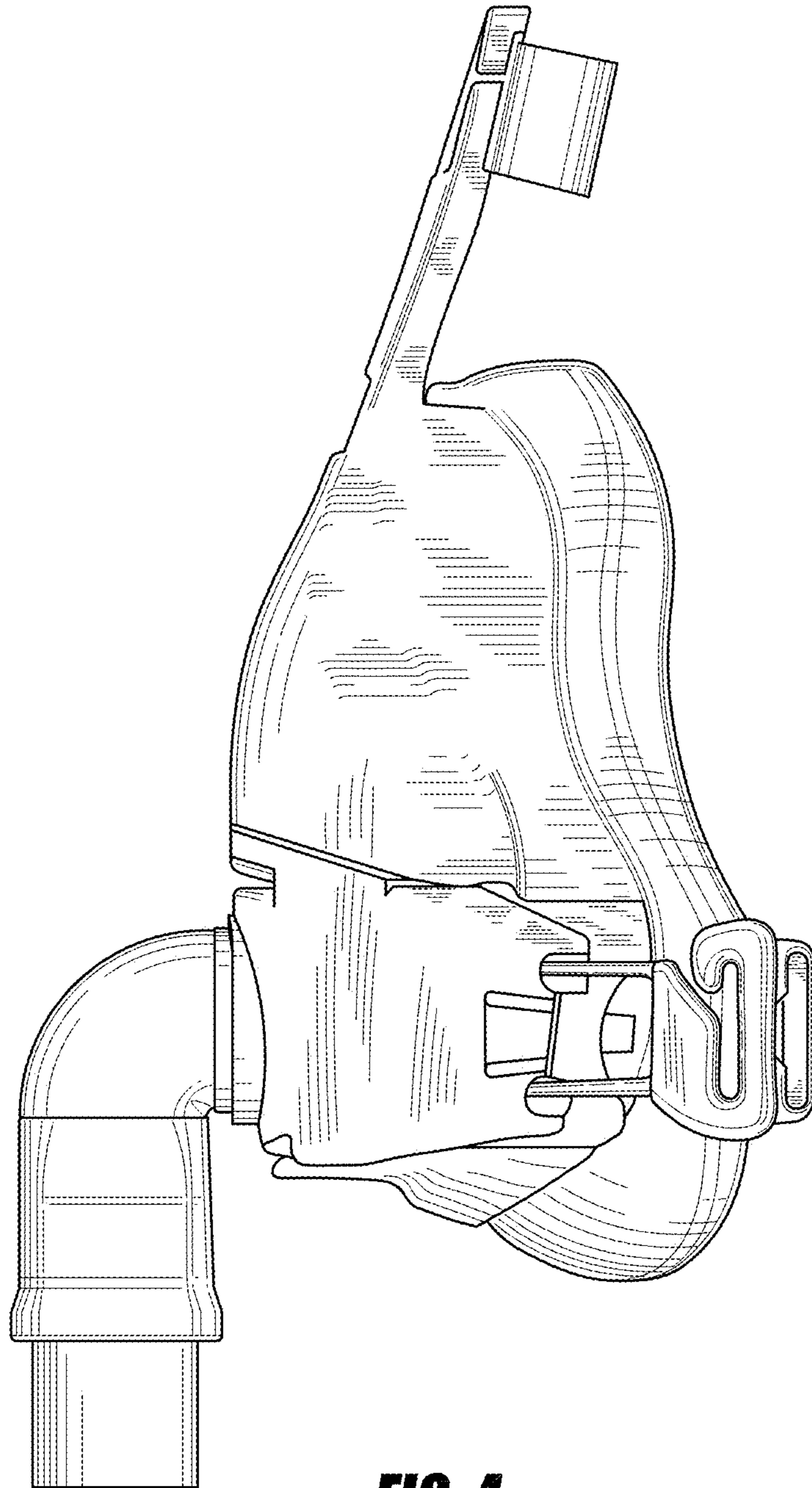

FIG. 4
AMENDED

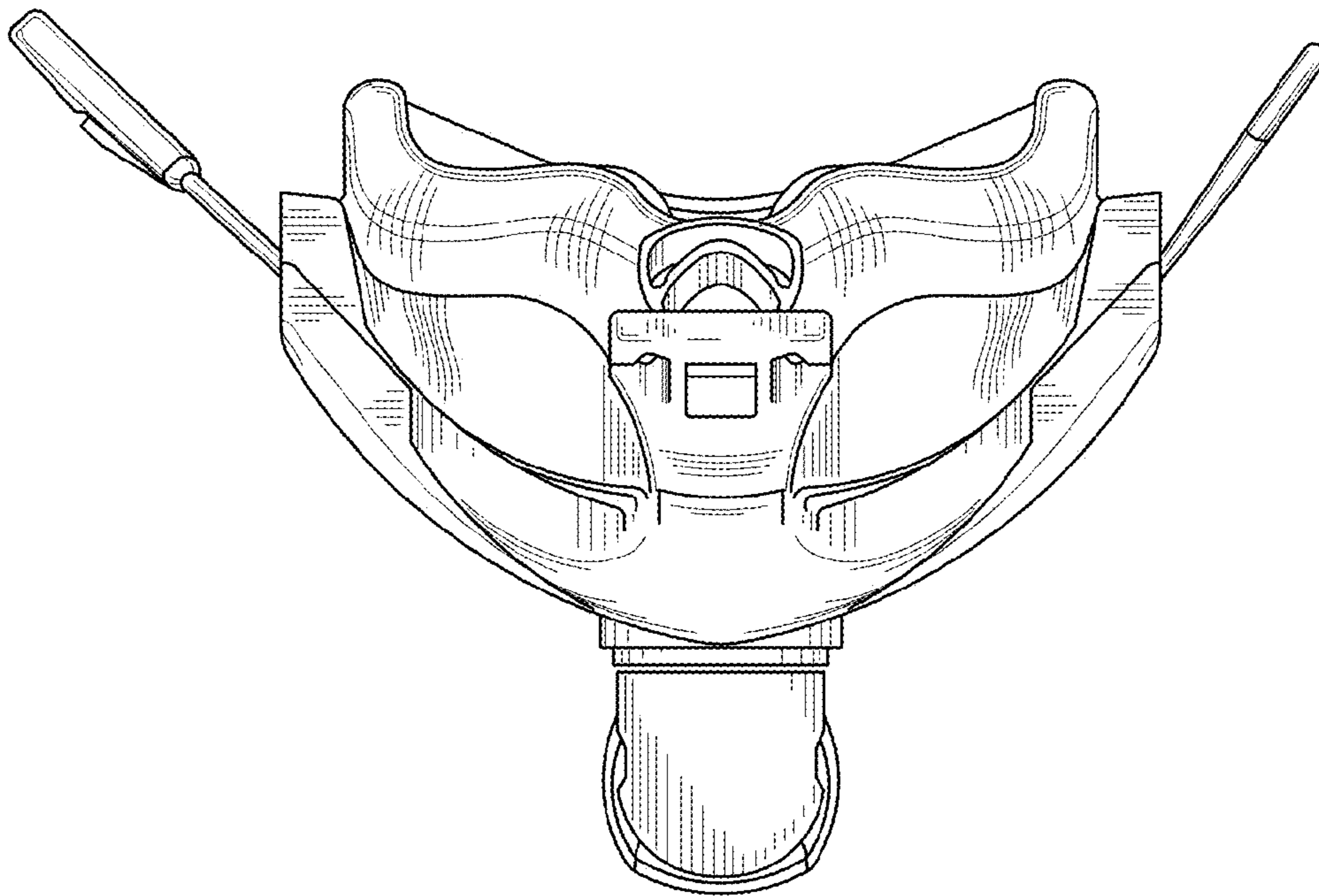

FIG. 5
AMENDED

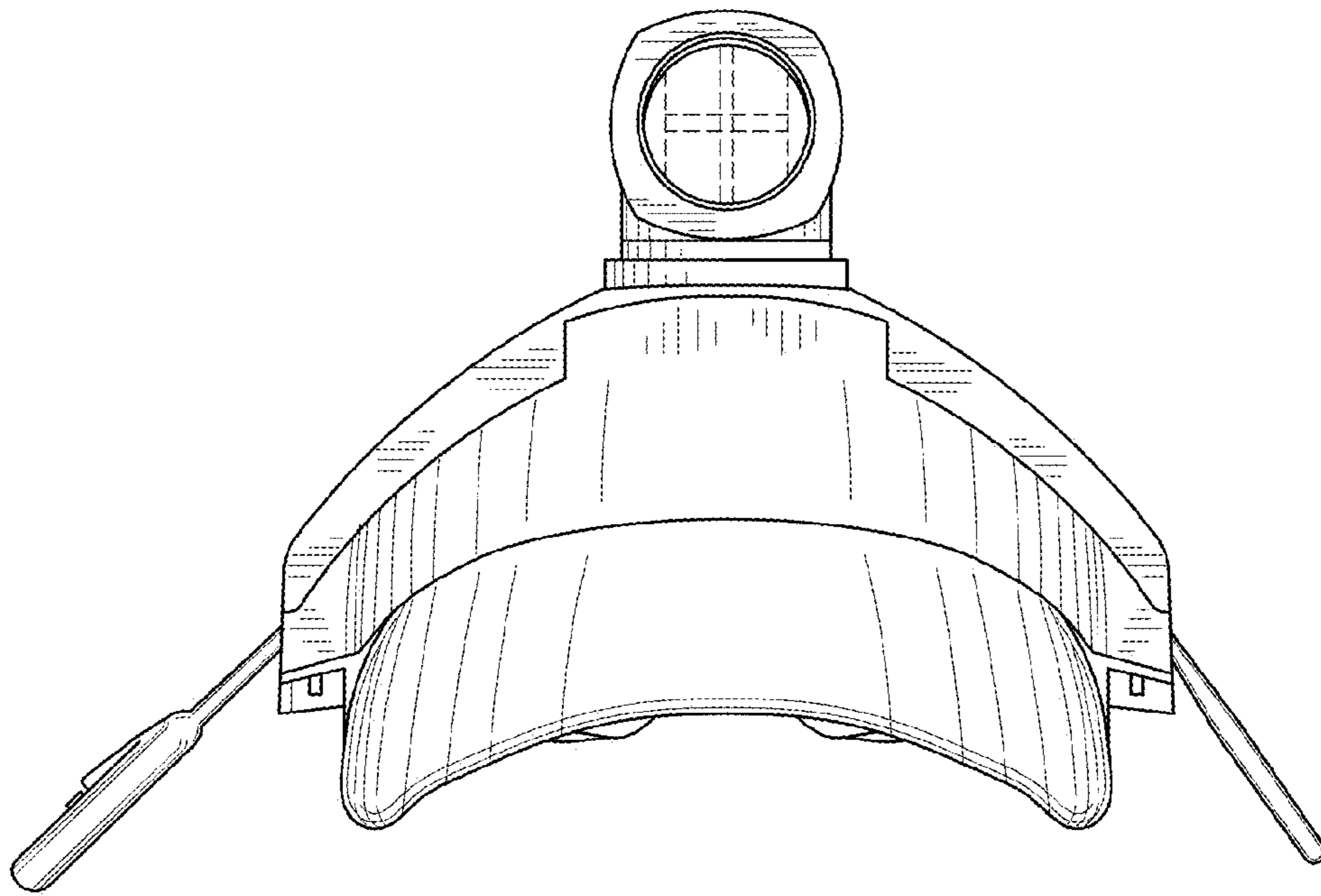

FIG. 6
AMENDED

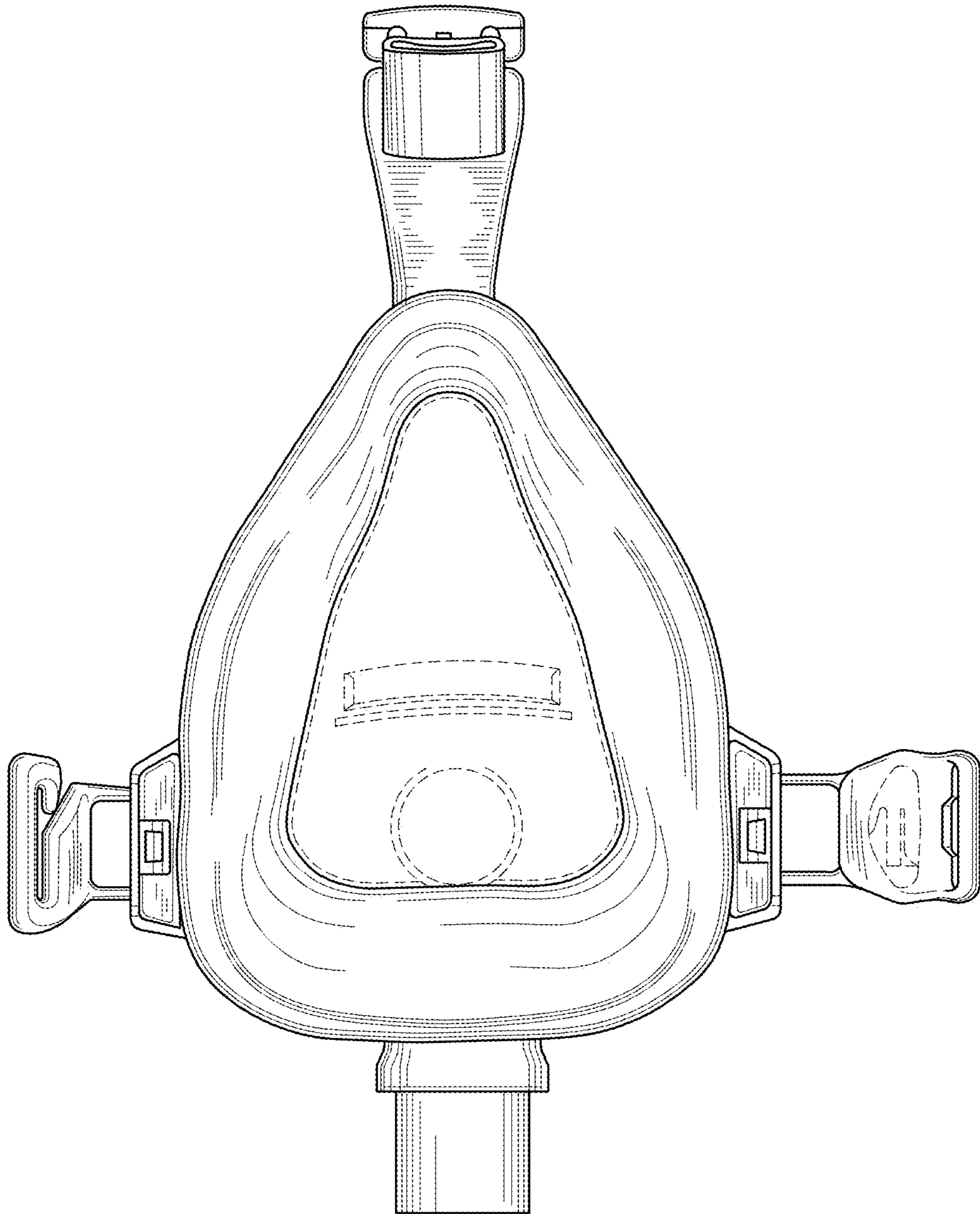

FIG. 7
AMENDED

UNITED STATES PATENT AND TRADEMARK OFFICE
CERTIFICATE OF CORRECTION

PATENT NO. : RE45,985 E
APPLICATION NO. : 29/382614
DATED : April 26, 2016
INVENTOR(S) : Alastair Edwin McAuley et al.

Page 1 of 1

It is certified that error appears in the above-identified patent and that said Letters Patent is hereby corrected as shown below:

On the Title Page

Page 1 (item 57, Claim) at line 11, Change "and," to --and--.

Page 1 (item 57, Claim) at line 16, Change "for" to --form--.

Signed and Sealed this
Twentieth Day of September, 2016



Michelle K. Lee
Director of the United States Patent and Trademark Office