



US00RE45961E

(19) **United States**
(12) **Reissued Patent**
Walter

(10) **Patent Number:** **US RE45,961 E**
(45) **Date of Reissued Patent:** **Apr. 5, 2016**

(54) **CART BASKET**

(71) Applicant: **AMSA, Inc.**, Boulder, CO (US)

(72) Inventor: **Ivor Michel Walter**, Boulder, CO (US)

(73) Assignee: **ASMA, Inc.**, Boulder, CO (US)

(21) Appl. No.: **29/486,266**

(22) Filed: **Mar. 27, 2014**

Related U.S. Patent Documents

Reissue of:

(64) Patent No.: **Des. 656,700**
Issued: **Mar. 27, 2012**
Appl. No.: **29/388,157**
Filed: **Mar. 24, 2011**

(51) **LOC (10) Cl.** **12-02**

(52) **U.S. Cl.**
USPC **D34/27**

(58) **Field of Classification Search**
USPC D34/12-27; 280/33.992, 33.991,
280/33.993, 47.34, 79.11; 220/334
See application file for complete search history.

(56) **References Cited**

U.S. PATENT DOCUMENTS

3,039,564 A 6/1962 Shaukis
D247,953 S * 5/1978 Rehrig D34/27

(Continued)

OTHER PUBLICATIONS

Technibilt 5141-D Scan of website [<http://www.technibilt.com/carts/detail.php?id=36>] showing prior art cart manufactured by Technibilt.
Cart shown is admitted prior art to current design by Applicant.

(Continued)

Primary Examiner — Phillip S Hyder

(74) *Attorney, Agent, or Firm* — Polson Intellectual Property Law, PC; Margaret Polson

(57) **CLAIM**

The ornamental design for a [set of] cart basket[s], as shown and described.

DESCRIPTION

FIG. 1 is a front perspective view of the first embodiment for a [set of] cart [baskets] *basket* showing my new design.

FIG. 2 is a side elevation view of the right and left sides, which are mirror images, of FIG. 1.

FIG. 3 is a front side elevation view of FIG. 1.

FIG. 4 is back side elevation view of FIG. 1.

FIG. 5 is a top plan view of FIG. 1.

FIG. 6 is a bottom plan view of FIG. 1.

FIG. 7 is a front perspective view of the second embodiment for a [set of] cart [baskets] *basket* showing my new design.

FIG. 8 is a side elevation view of the right and left sides, which are mirror images, of FIG. 7.

FIG. 9 is a front side elevation view of FIG. 7.

FIG. 10 is back side elevation view of FIG. 7.

FIG. 11 is a top plan view of FIG. 7.

FIG. 12 is a bottom plan view of FIG. 7.

FIG. 13 is a front perspective view of the third embodiment for a [set of] cart [baskets] *basket* showing my new design;

FIG. 14 is a side elevation view of the right and left sides, which are mirror images, of FIG. 13.

FIG. 15 is a front side elevation view of FIG. 13.

FIG. 16 is back side elevation view of FIG. 13.

FIG. 17 is a top plan view of FIG. 13; and,

FIG. 18 is a bottom plan view of FIG. 13.

The broken line showing of the frame, logo panel *bottom of the baskets*, and back gates is included for the purpose of illustrating elements of the cart and forms no part of the claimed design.

1 Claim, 18 Drawing Sheets

Matter enclosed in heavy brackets [] appears in the original patent but forms no part of this reissue; matter printed in italics indicates the additions made by reissue.

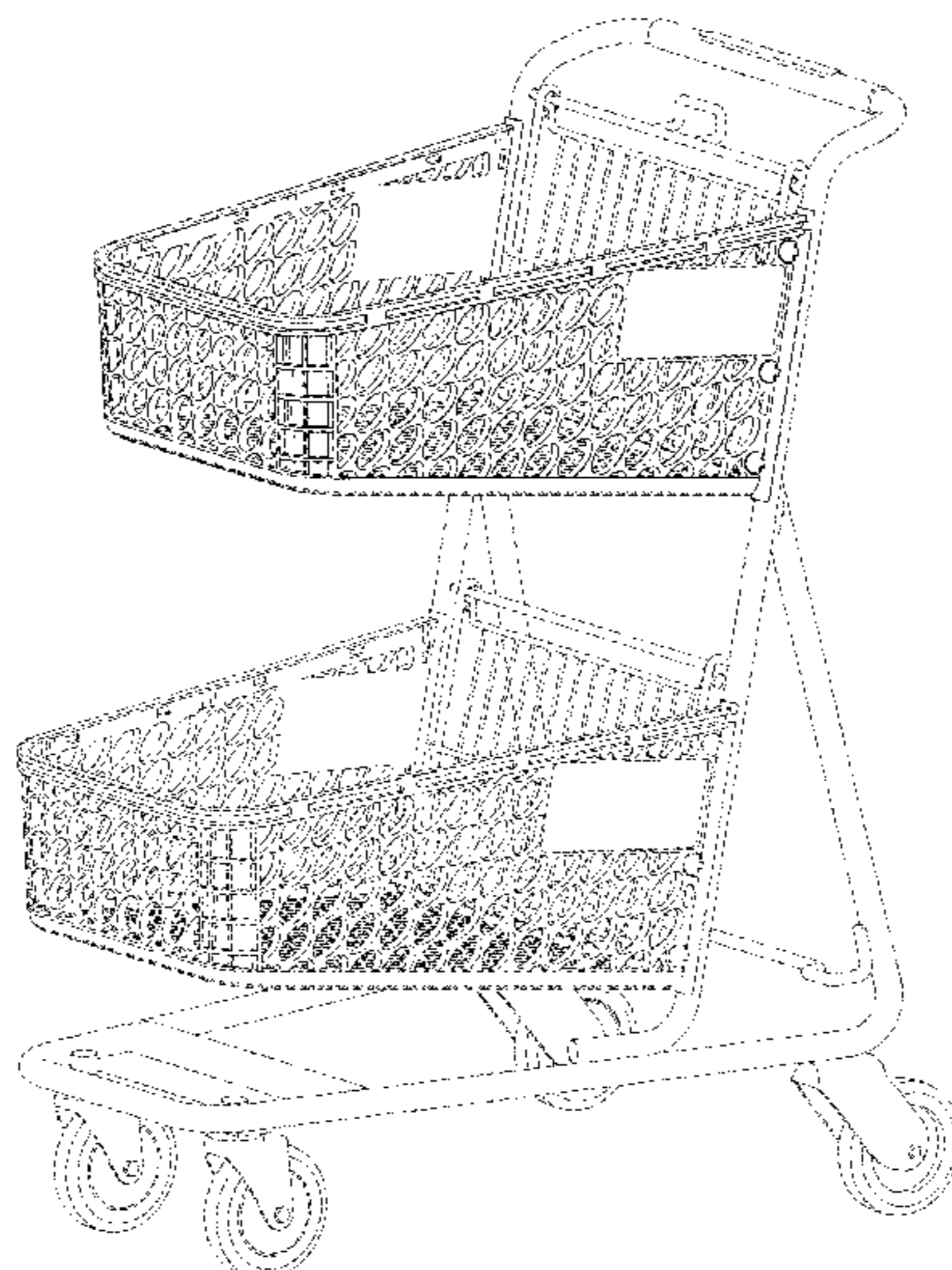

(56)

References Cited

U.S. PATENT DOCUMENTS

4,632,411	A	12/1986	Badger	
4,650,199	A *	3/1987	Rehrig	280/33.997
D294,419	S	2/1988	Rehrig	
D296,259	S *	6/1988	Rehrig	D34/27
D317,219	S *	5/1991	Rehrig	D34/27
D346,473	S	4/1994	Hubble	
D400,679	S *	11/1998	Kern et al.	D34/27
5,865,448	A *	2/1999	Kern et al.	280/33.992
D412,046	S	7/1999	Rehrig et al.	
5,947,313	A *	9/1999	Kern et al.	220/4.01
D426,365	S	6/2000	Rehrig et al.	
6,126,181	A	10/2000	Ondrasik	
6,533,297	B2	3/2003	Saccani	
6,644,674	B2	11/2003	Simard	
6,676,139	B1	1/2004	Saccani	
6,932,363	B2	8/2005	D'Angelo	
6,981,708	B1	1/2006	Tucker et al.	280/33.992
D528,732	S	9/2006	Hubbard et al.	D34/27
D538,501	S	3/2007	Walter	
D550,423	S *	9/2007	Splain et al.	D34/12
D556,413	S *	11/2007	Splain et al.	D34/12
D564,172	S *	3/2008	Steinhobel	D34/12
D580,619	S	11/2008	Walter	
D583,523	S	12/2008	Deal et al.	
D607,173	S	12/2009	Selvig et al.	
D628,759	S	12/2010	Walter	
D633,269	S	2/2011	Walter	
D638,602	S	5/2011	Walter	
D644,809	S	9/2011	Walter	
D645,222	S	9/2011	Walter	
D651,655	S	1/2012	Walter	
D656,288	S	3/2012	Walter	
D656,700	S	3/2012	Walter	
2001/0022436	A1	9/2001	Simard	
2003/0151219	A1	8/2003	Simard	

OTHER PUBLICATIONS

Technibilt 5341 Scan of website [<http://www.technibilt.com/carts/detail.php?id=30>] showing prior art cart manufactured by Technibilt. Cart shown is admitted prior art to current design by Applicant.

Technibilt 5640 Scan of website [<http://www.technibilt.com/carts/detail.php?id=28>] showing prior art cart manufactured by Technibilt. Cart shown is admitted prior art to current design by Applicant.

Unarco PC-41 U Scan of website [http://unarco.com/PC41_U.pdf] showing prior art cart manufactured by Unarco. Cart shown is admitted prior art to current design by Applicant.

Wanzl Tango Scan of website [http://wanzl.com/000/En/Home/Products/Self-Service_systems/Shopping_Trolleys/Shopping_Trolley_Series/Tango.html] showing prior art cart manufactured by Wanzl. Cart shown is admitted prior art to current design by Applicant.

First Amended Complaint and Jury Demand filed by *AMSA, Inc. dba Versacart, Inc. v. The Peggs Company, Inc.*, US District Court, District of Colorado, filed Apr. 18, 2014, for infringement of parent U.S. Pat. No. D656,700 and others. 46 pages.

Answer, Affirmative Defenses and Counterclaims to First Amended Complaint and Jury Demand filed by *AMSA, Inc. dba Versacart, Inc. v. The Peggs Company, Inc.*, US District Court, District of Colorado, filed May 9, 2014. 18 pages.

Plaintiff's Answer to Defendant's Answer, Affirmative Defenses and Counterclaims to First Amended Complaint and Jury Demand filed by *AMSA, Inc. dba Versacart, Inc. v. The Peggs Company, Inc.*, US District Court, District of Colorado, filed May 21, 2014. 9 pages.

Peggs KNM075GT Scan of website [http://www.thepeggscompany.com/shopping_carts/large_view/2_tier.html] showing prior art cart manufactured by Peggs.

Plasti-Cart Max 200 Scan of website [<http://www.plasti-cart.com/upload/assets/AllPlasticMax200.pdf>] showing prior art cart manufactured by Plasti-Cart.

Supercart neXus Scan of website [<http://supercart.com/data/products/627854469nexus.pdf>] showing prior art cart manufactured by Supercart.

Supercart XL 200 Scan of website [[http://supercart.com/data/products/1388572286xlcarrie\(xl200\).pdf](http://supercart.com/data/products/1388572286xlcarrie(xl200).pdf)] showing prior art cart manufactured by Supercart.

U.S. Appl. No. 29/334,767, filed Apr. 1, 2009; Inventor: Ivor Michel Walter.

U.S. Appl. No. 29/380,209, filed Dec. 1, 2010; Inventor: Ivor Michel Walter.

U.S. Appl. No. 29/380,622, filed Dec. 8, 2010; Inventor: Ivor Michel Walter.

U.S. Appl. No. 29/388,081, filed Mar. 23, 2011; Inventor: Ivor Michel Walter.

* cited by examiner

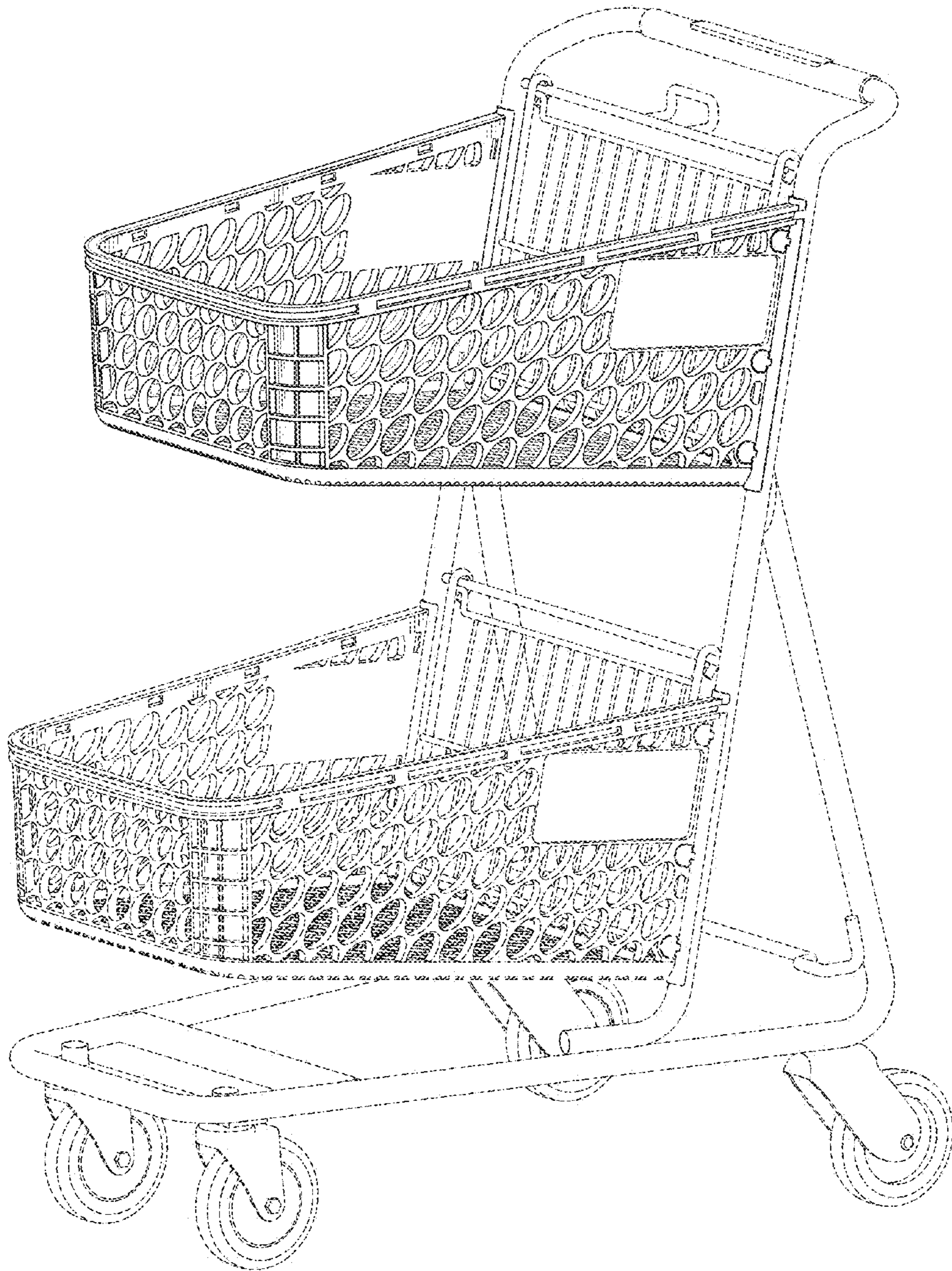

FIG.1

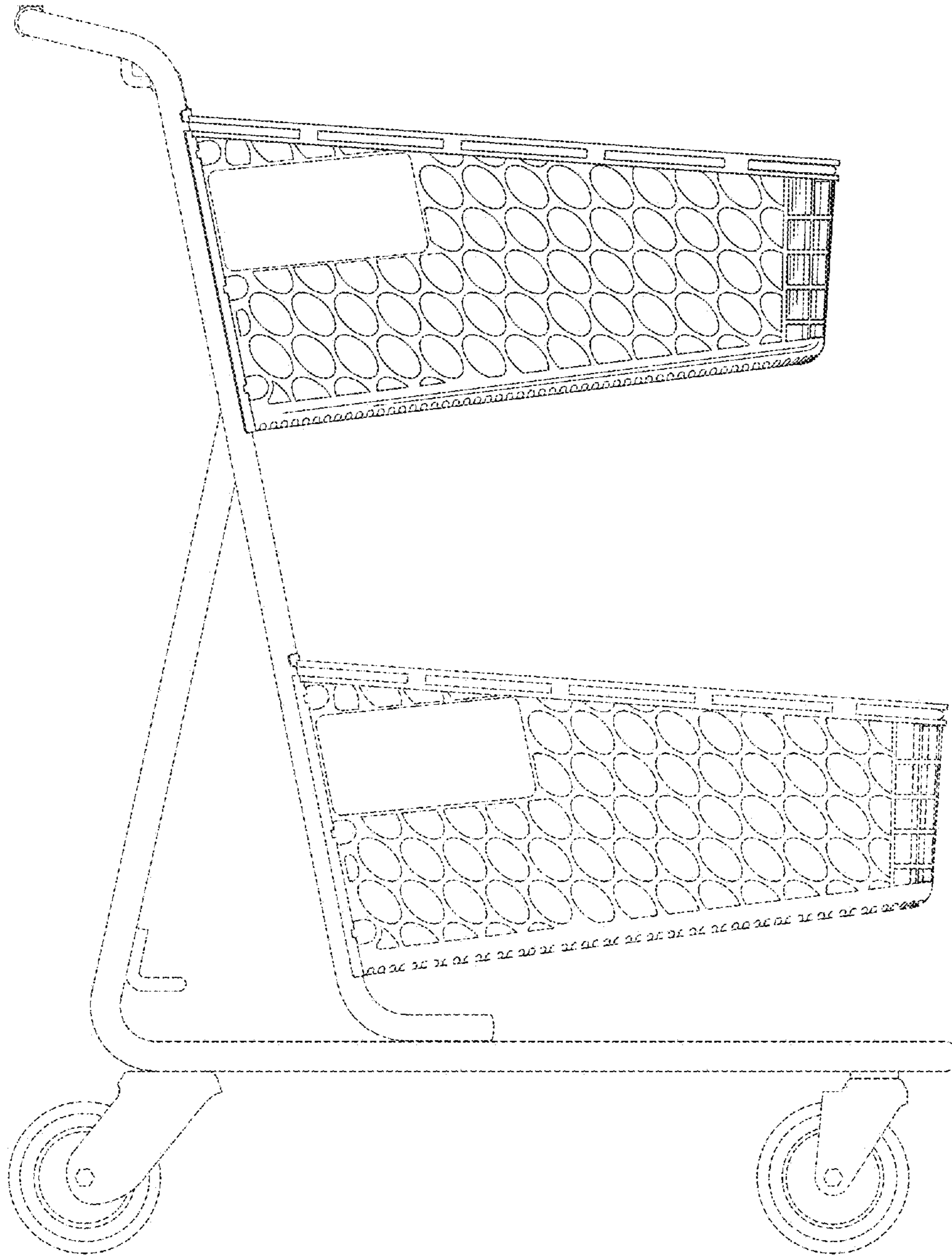

FIG. 2

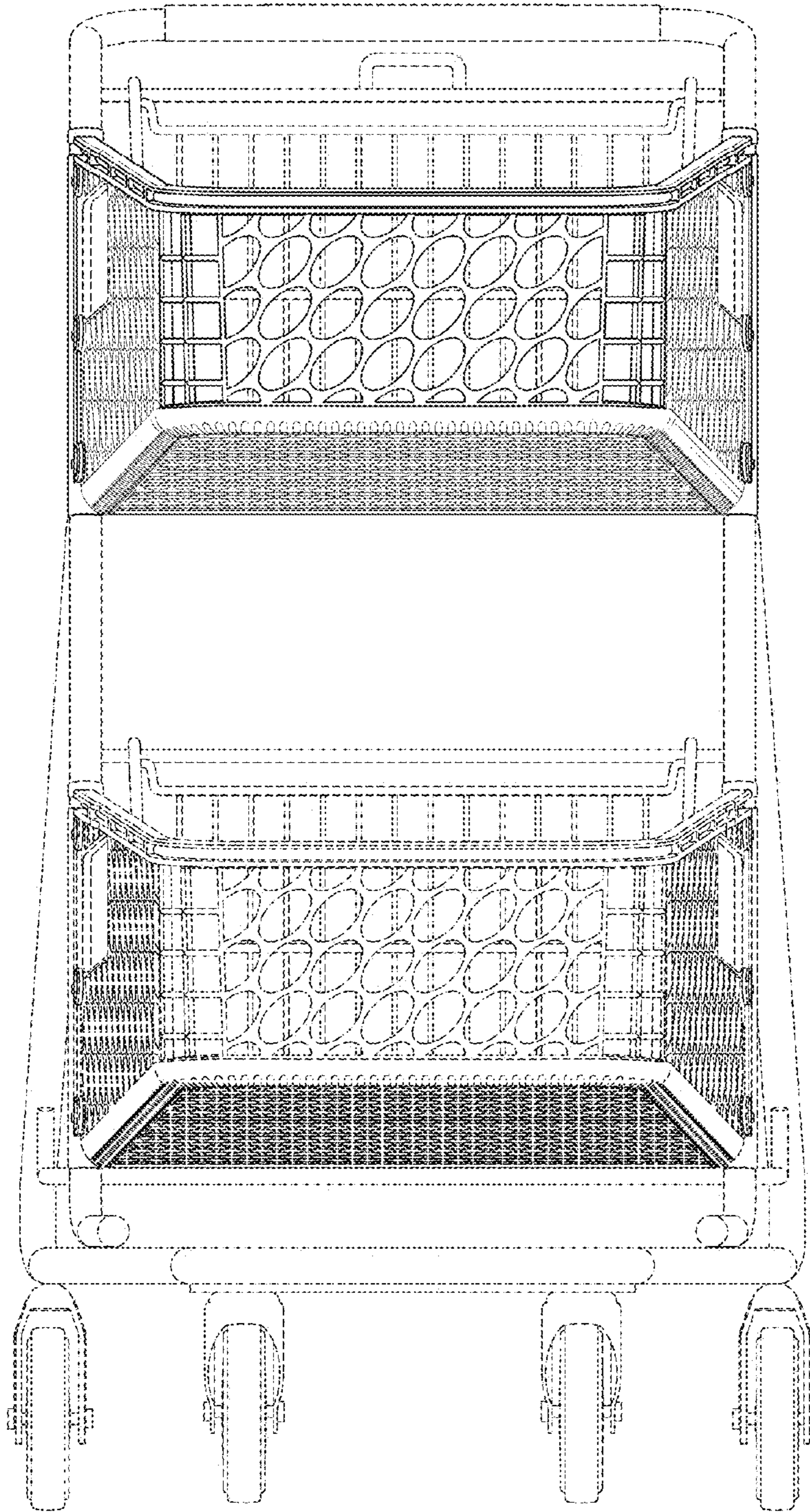

FIG.3

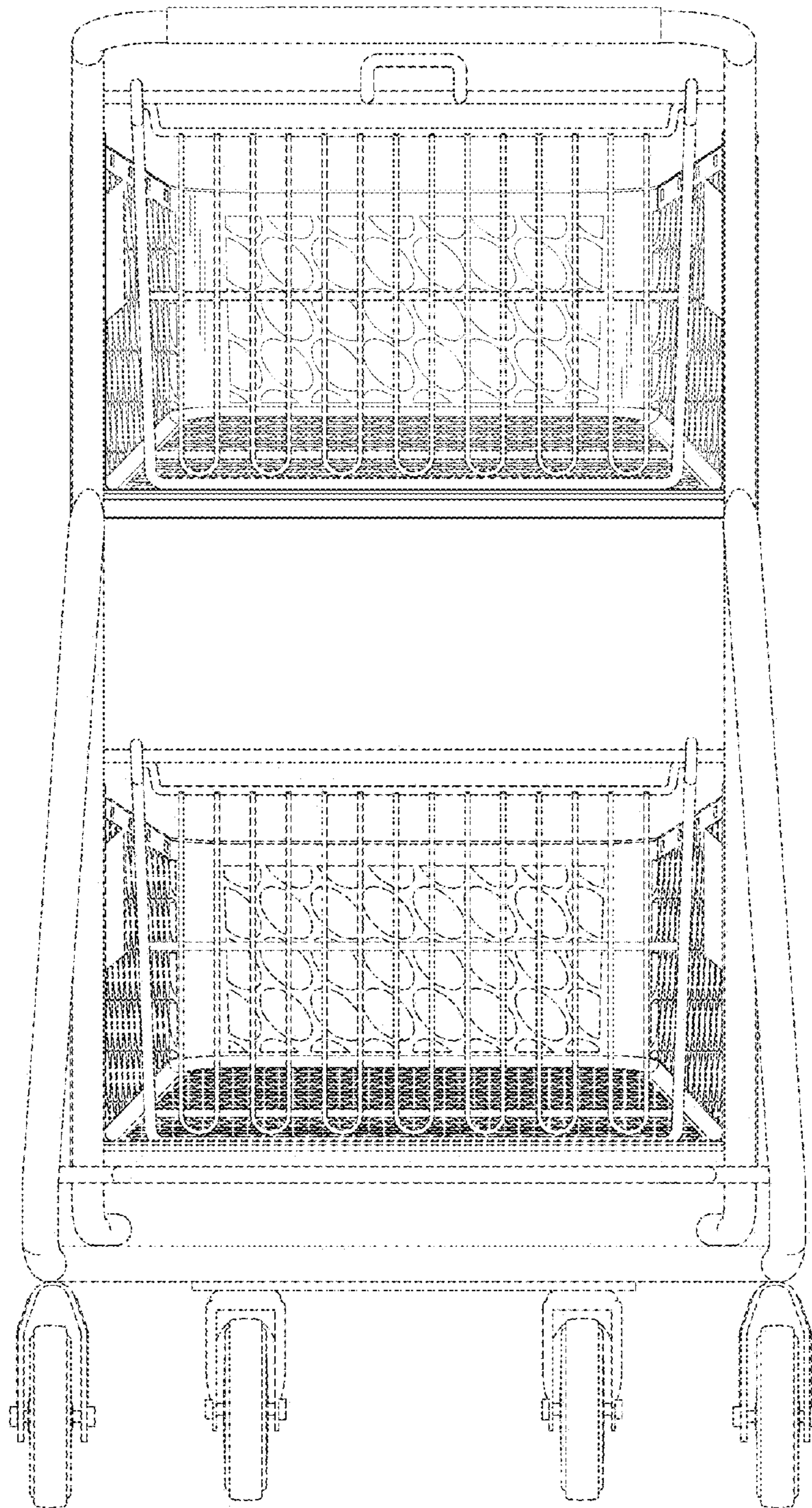

FIG.4

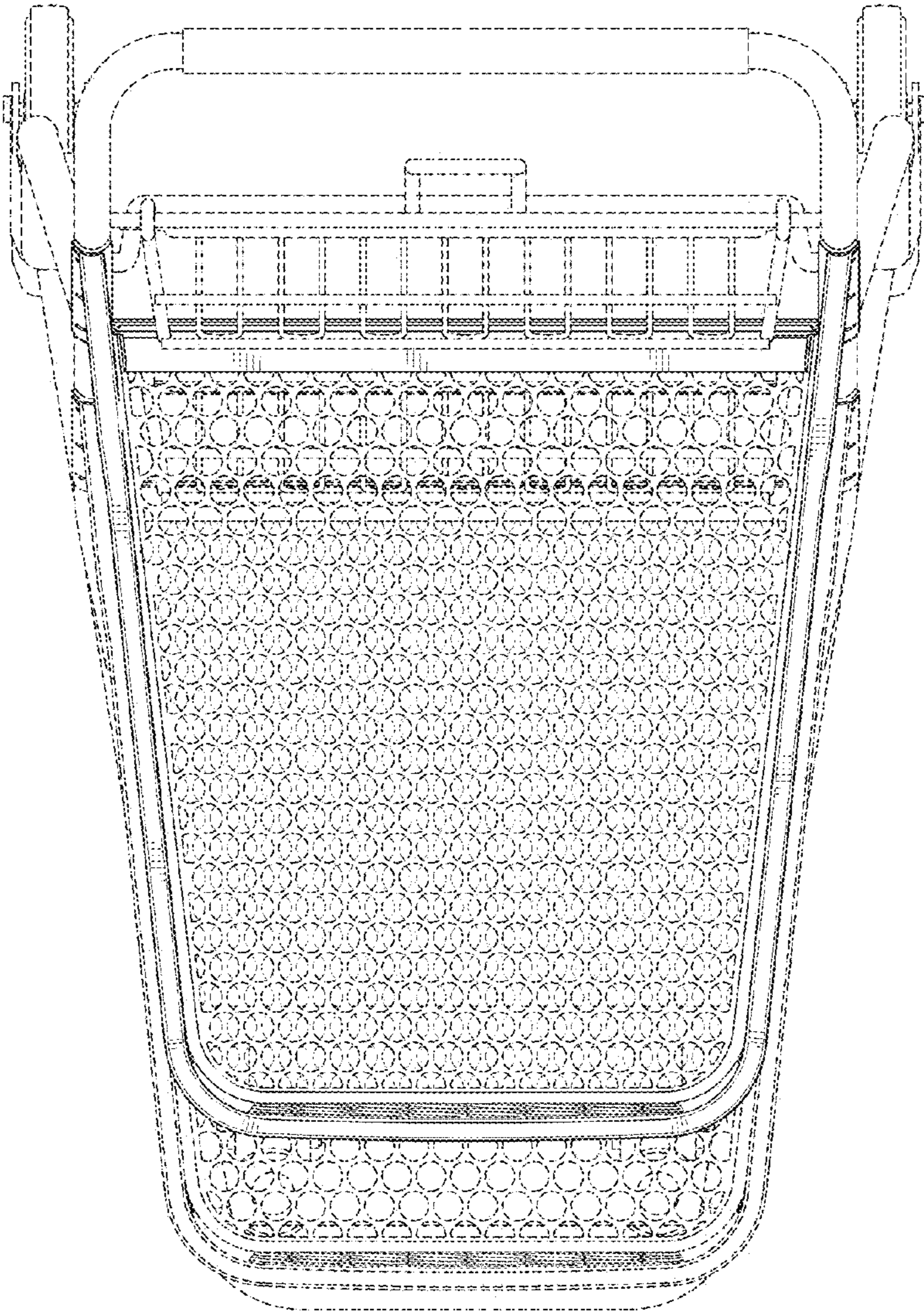

FIG.5

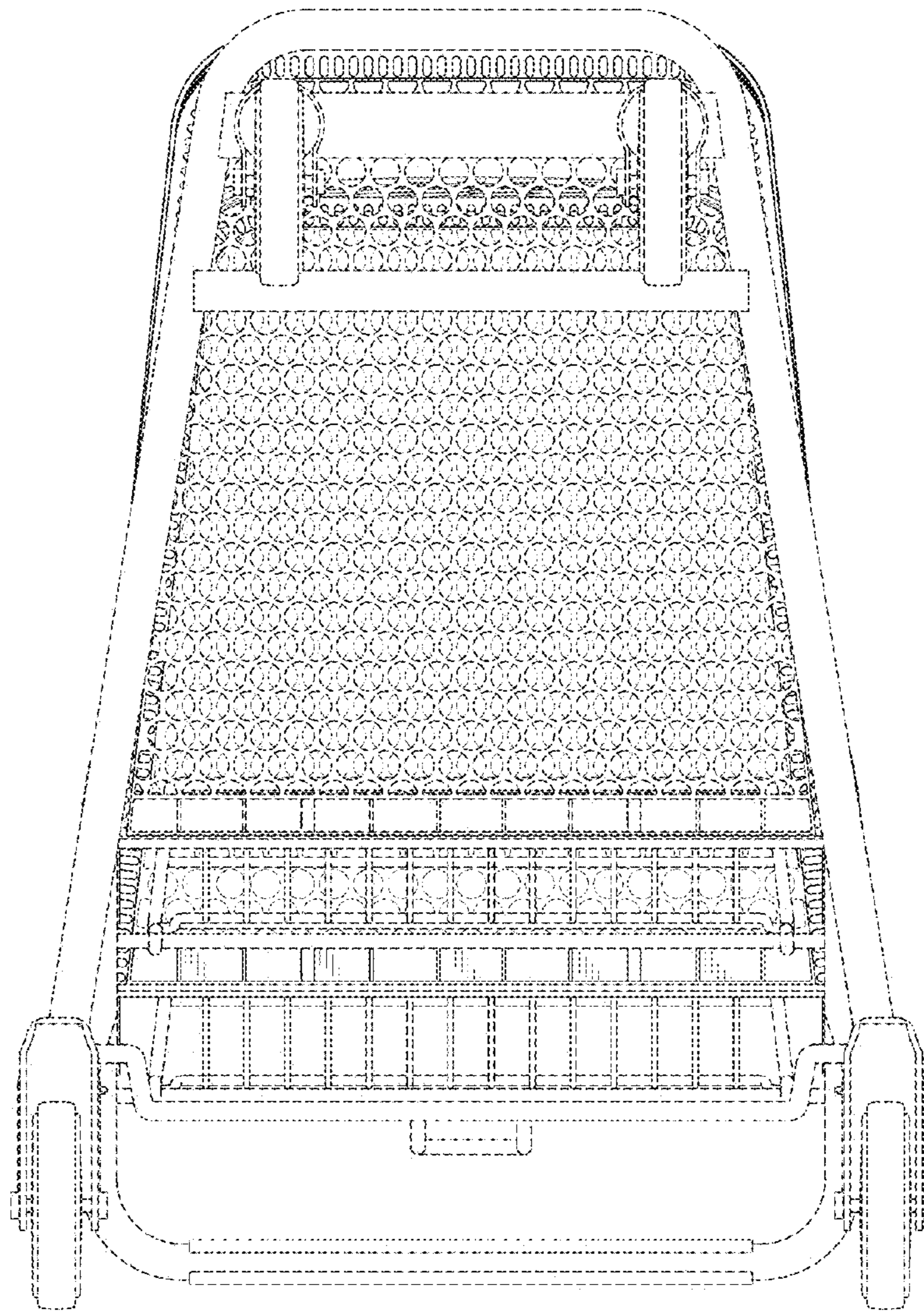

FIG.6

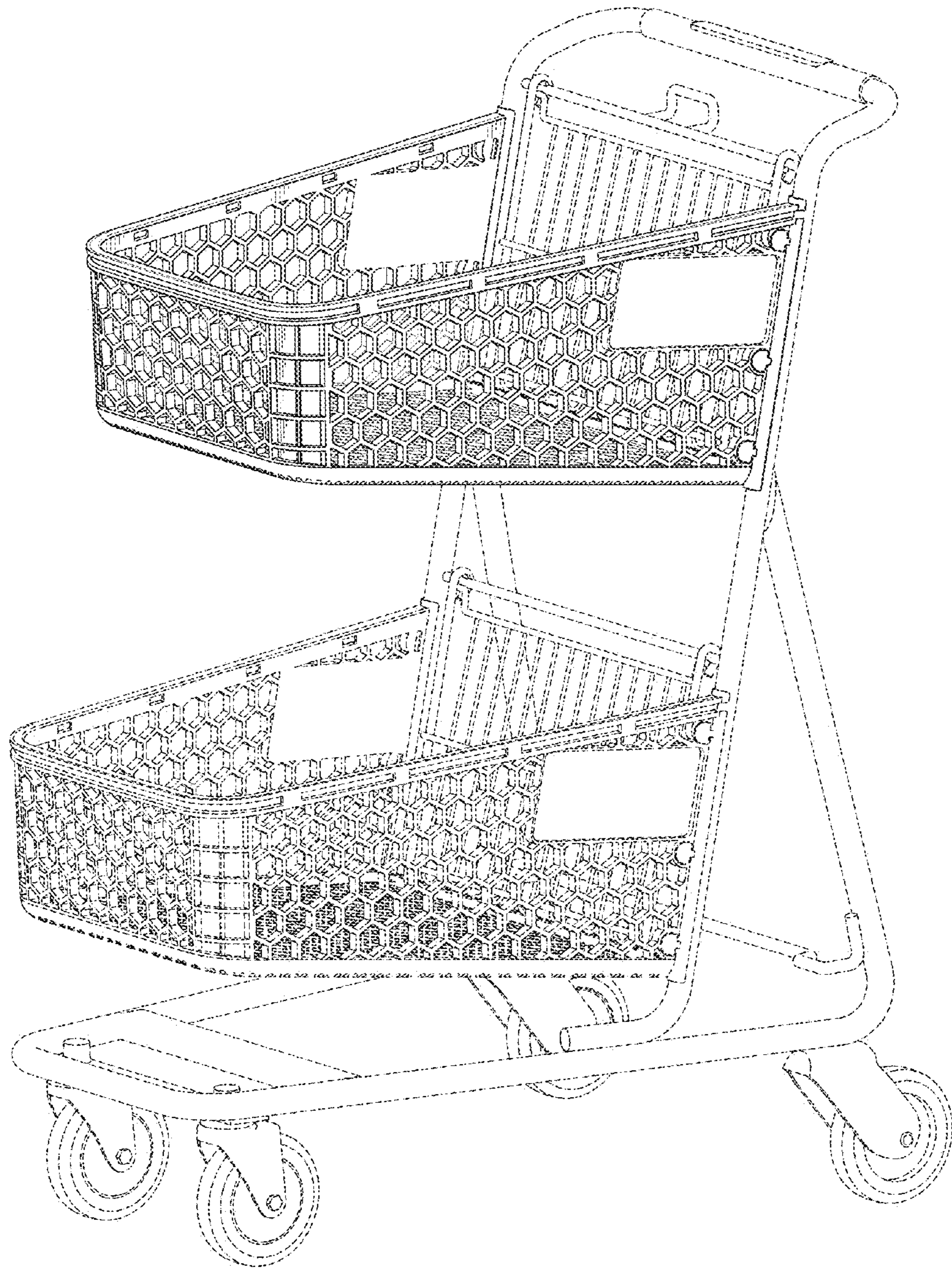

FIG. 7

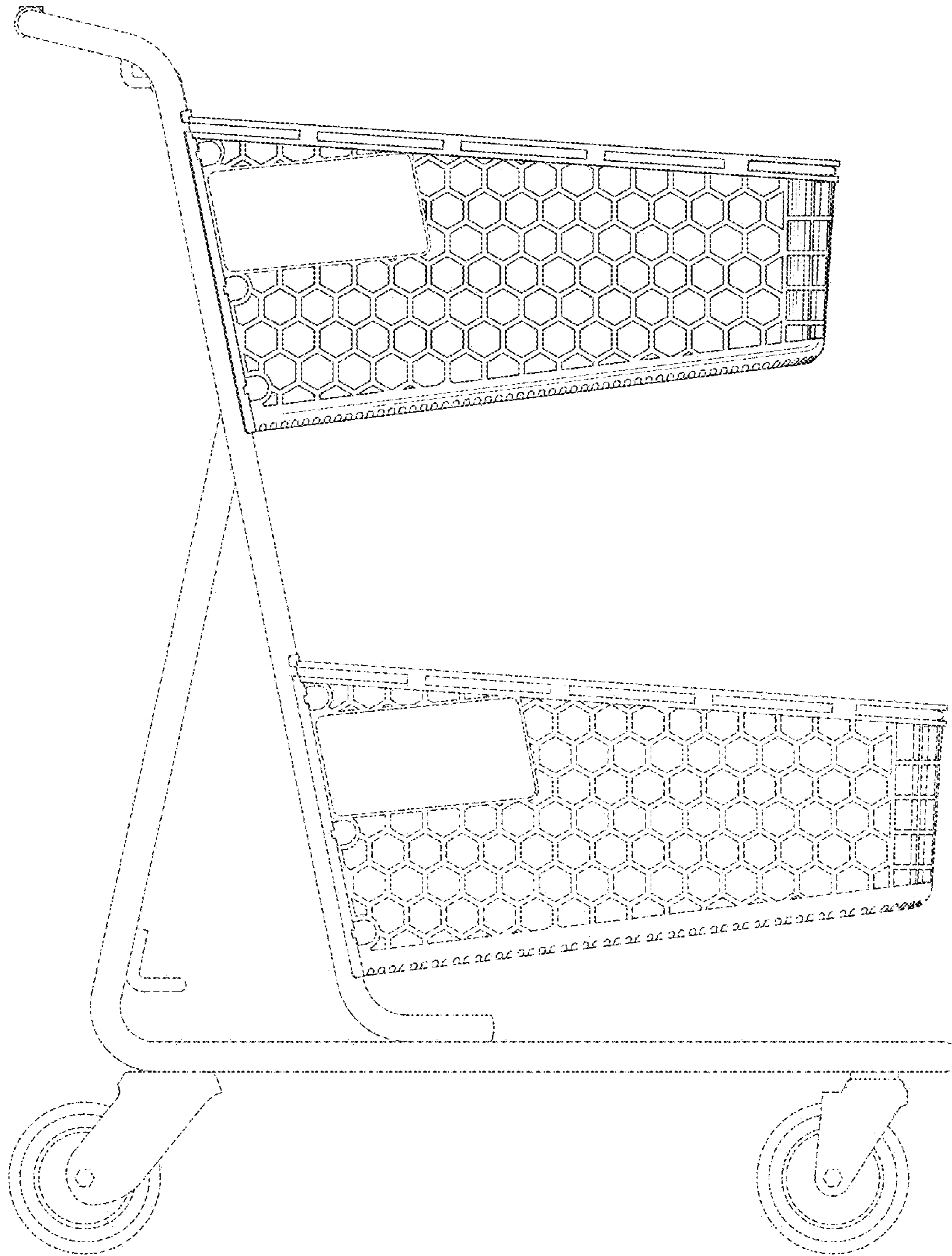

FIG. 8

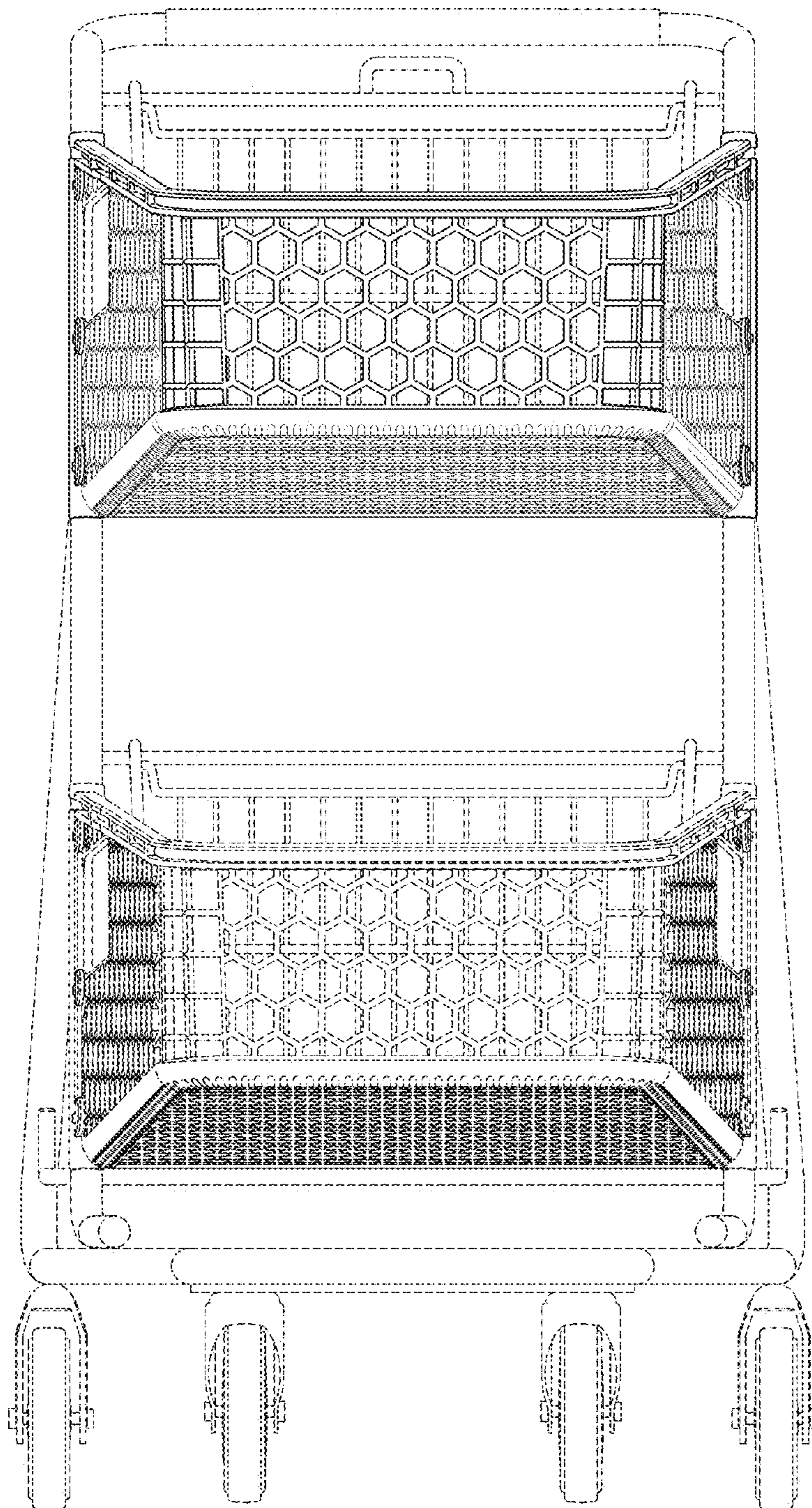

FIG.9

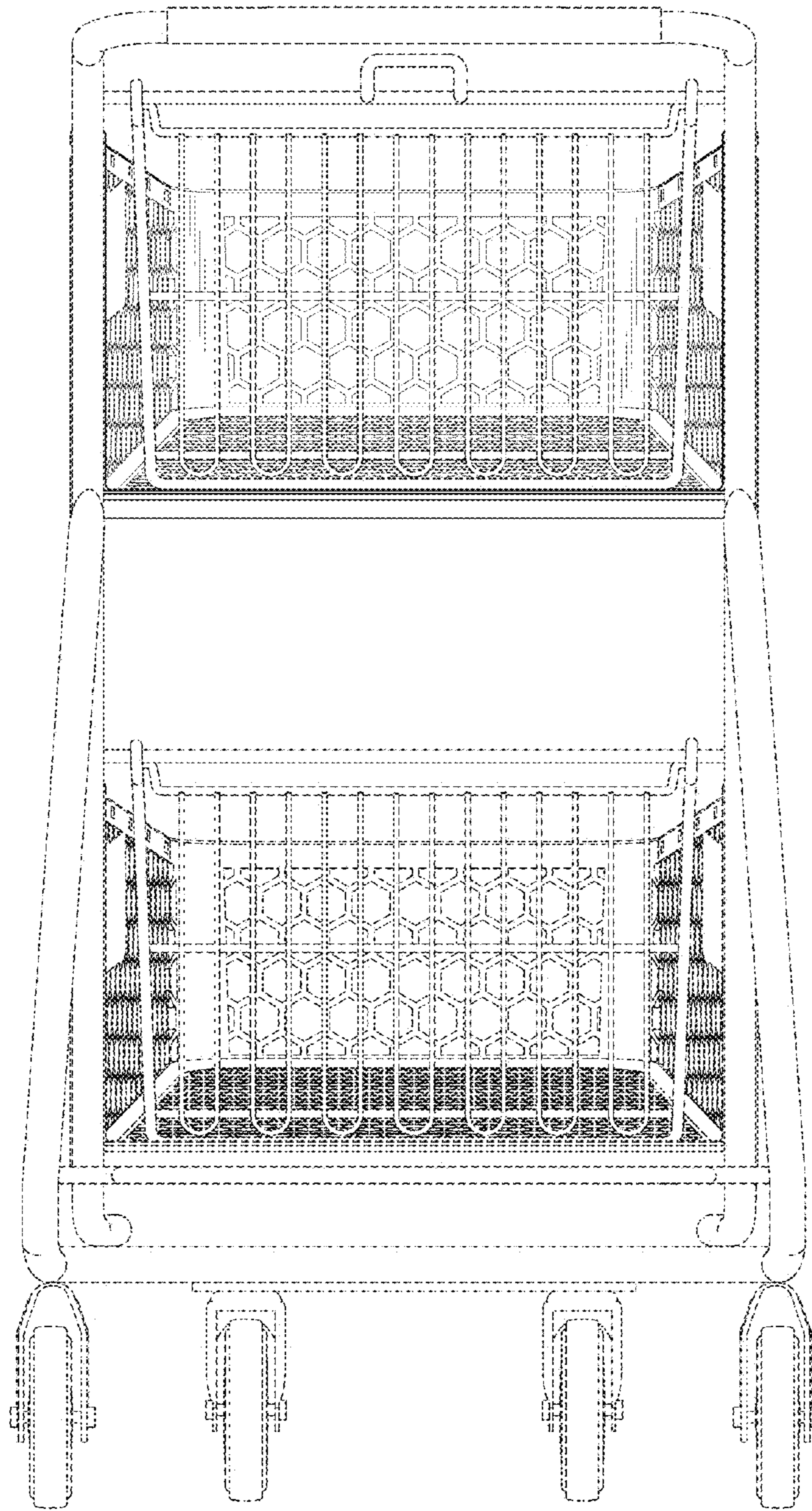

FIG.10

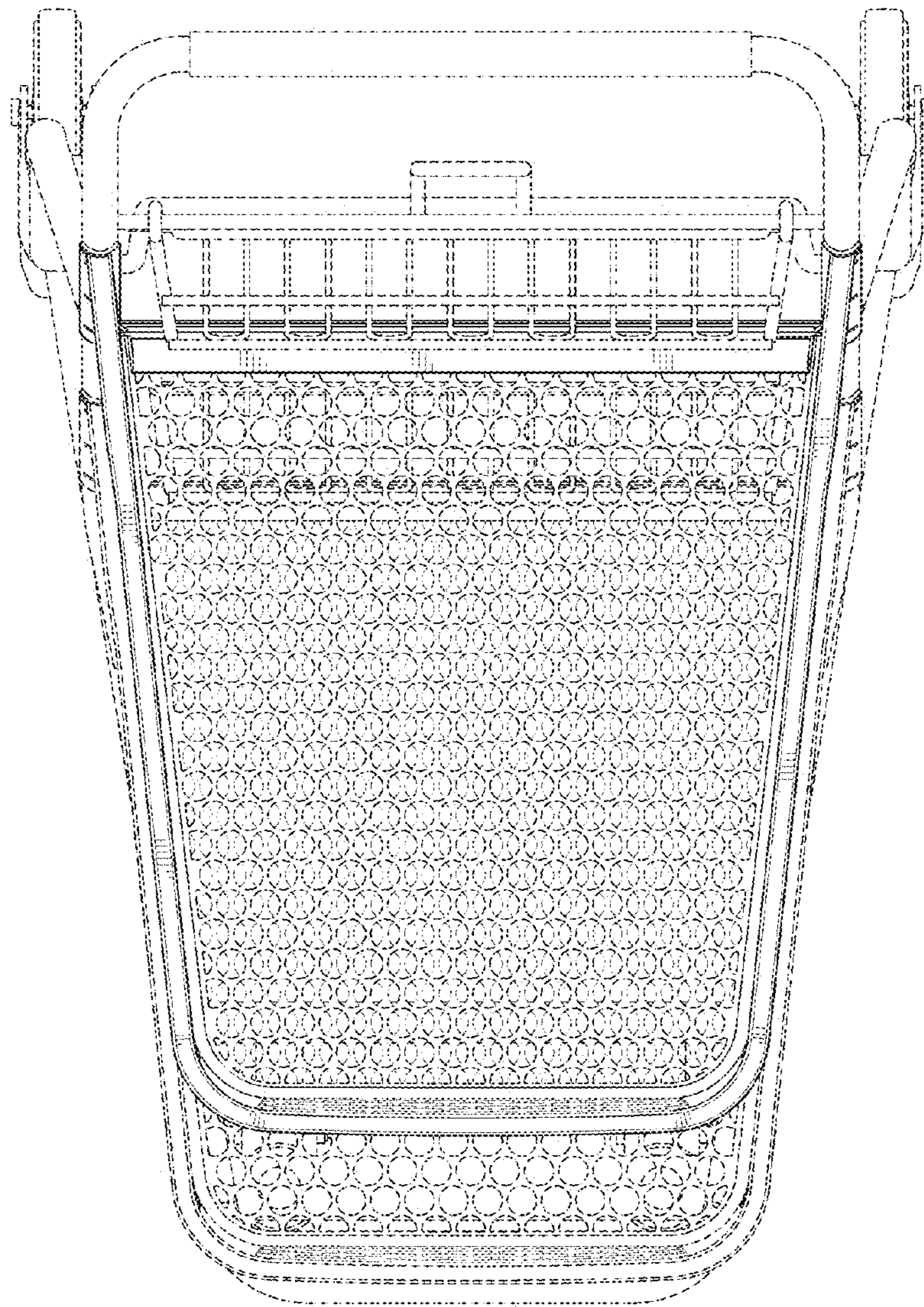

FIG.11

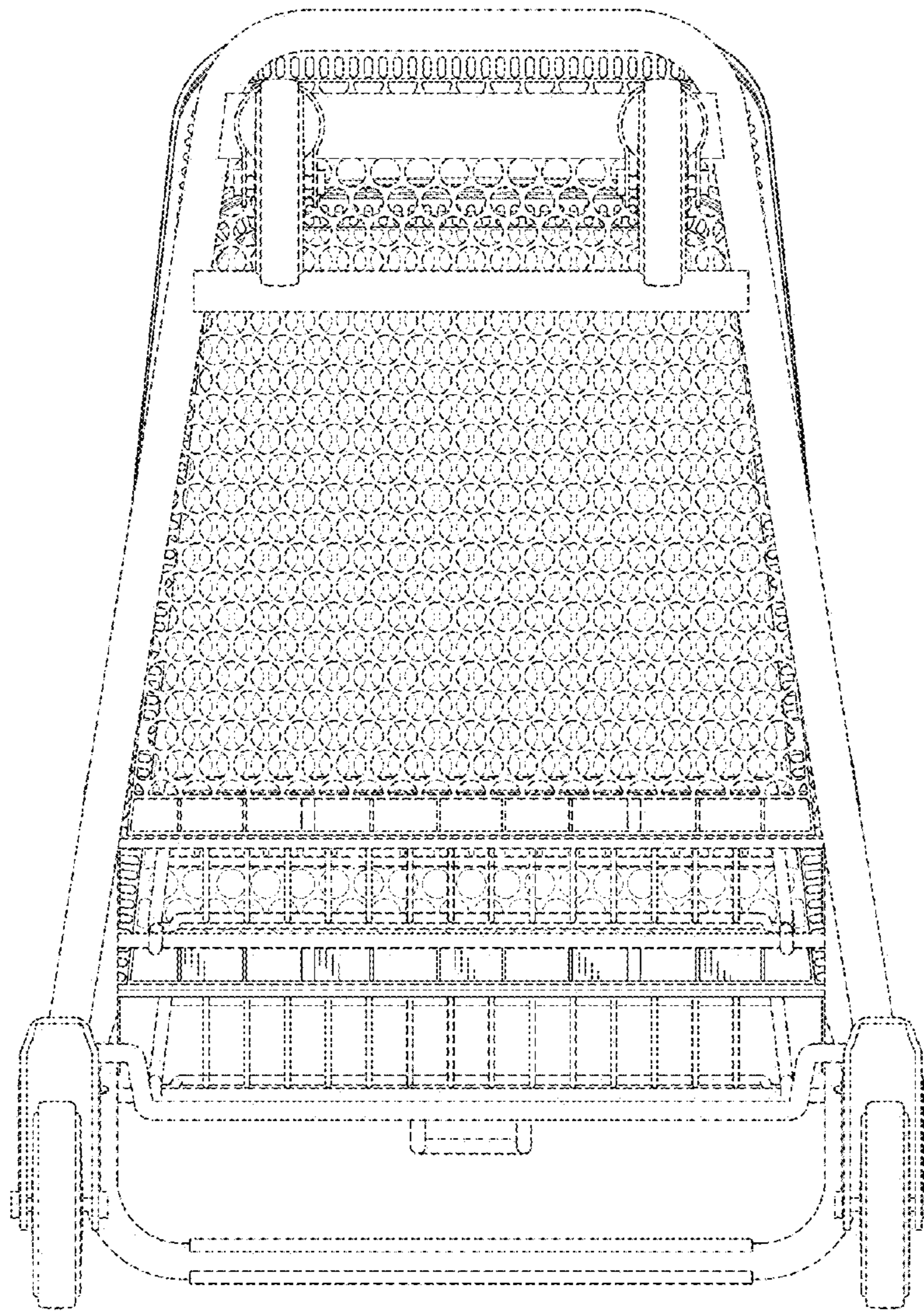

FIG.12

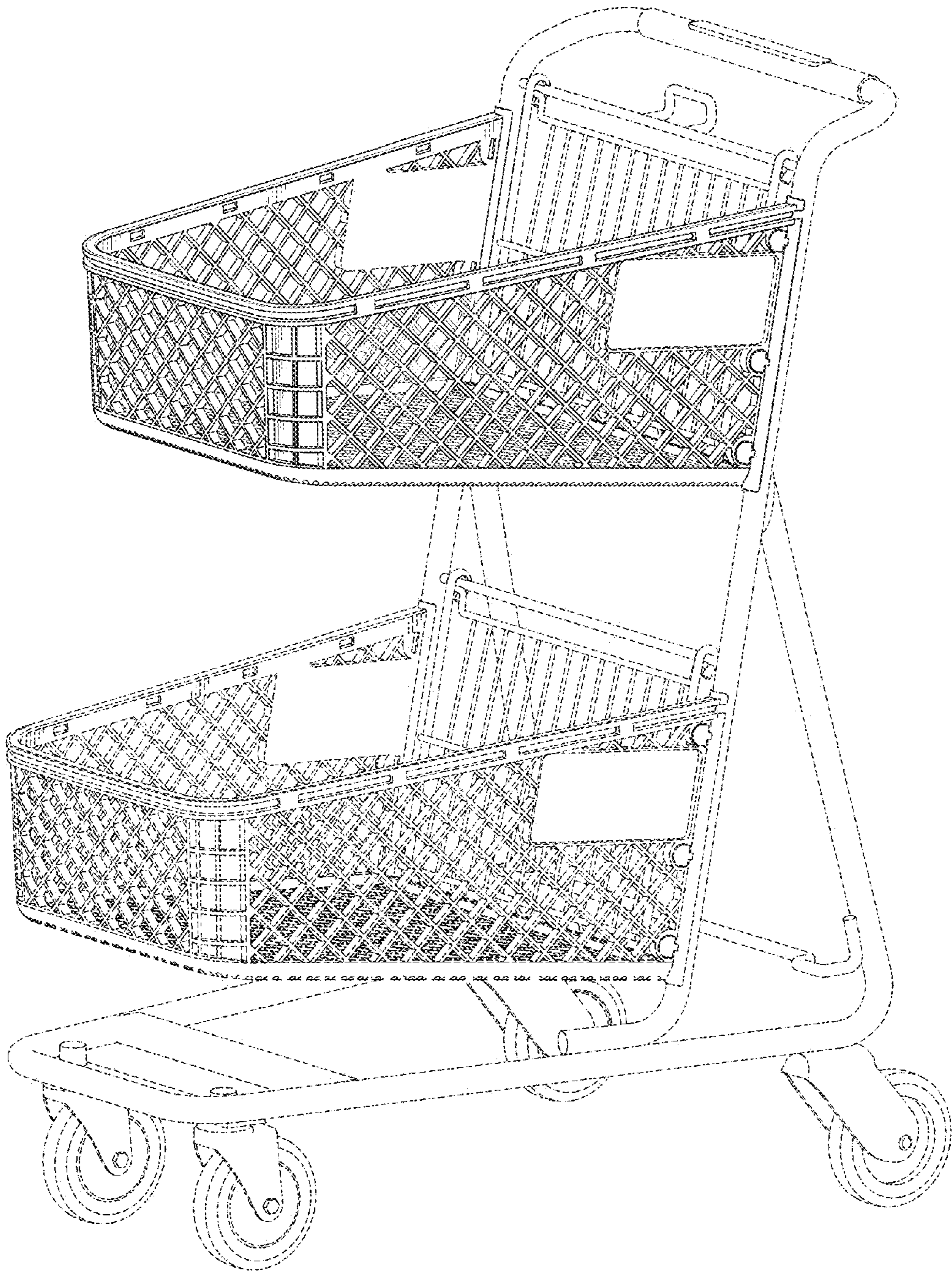

FIG.13

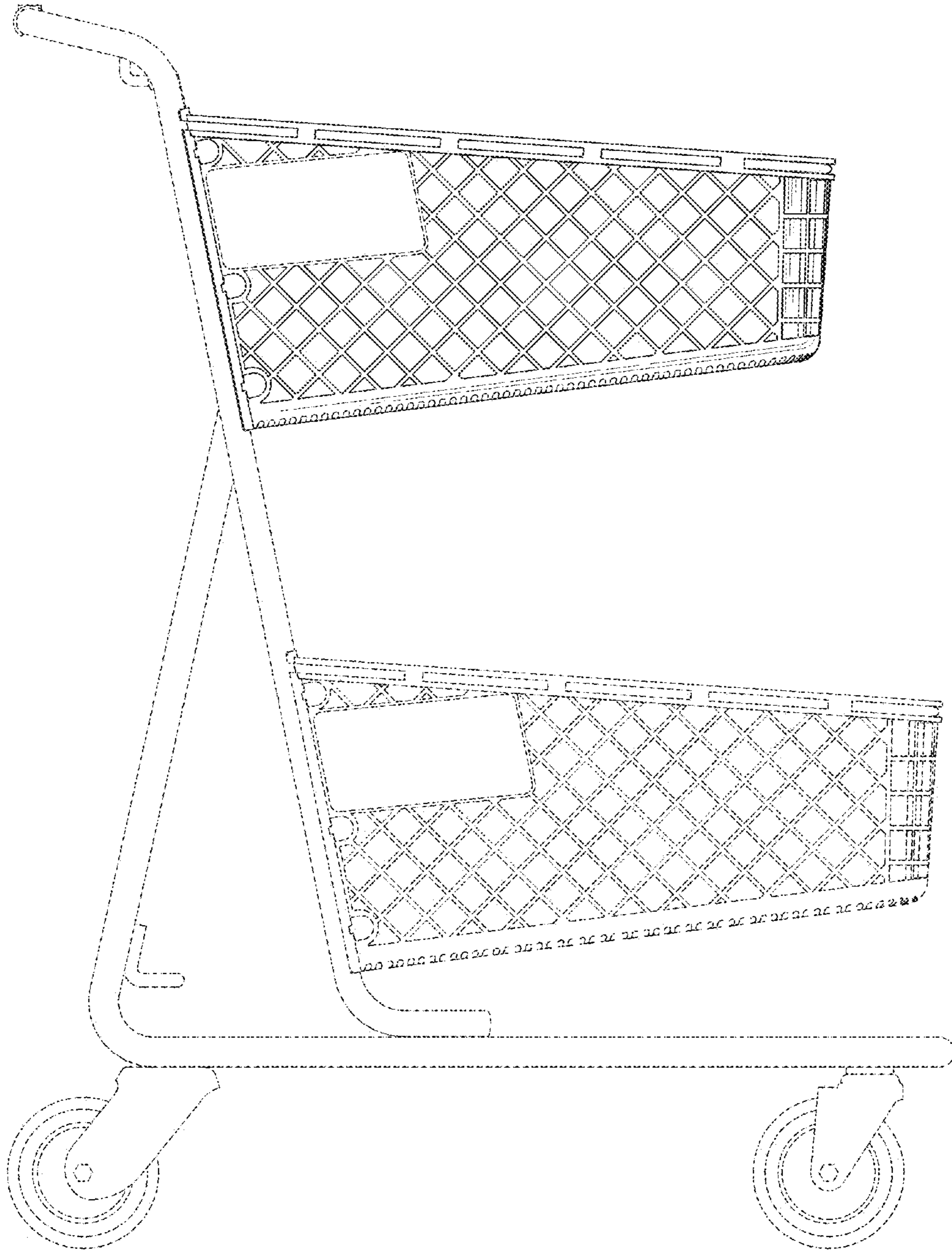

FIG.14

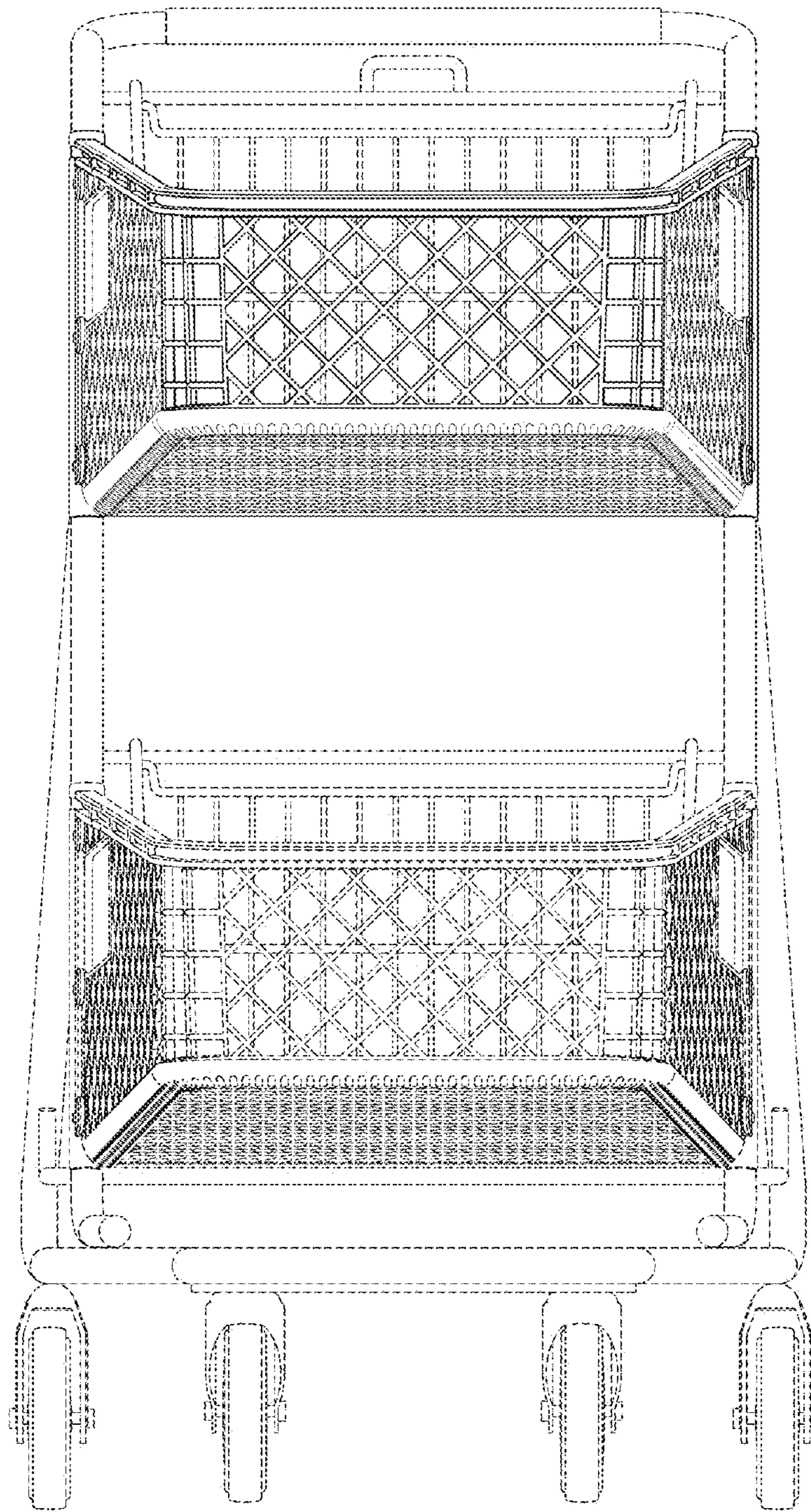

FIG.15

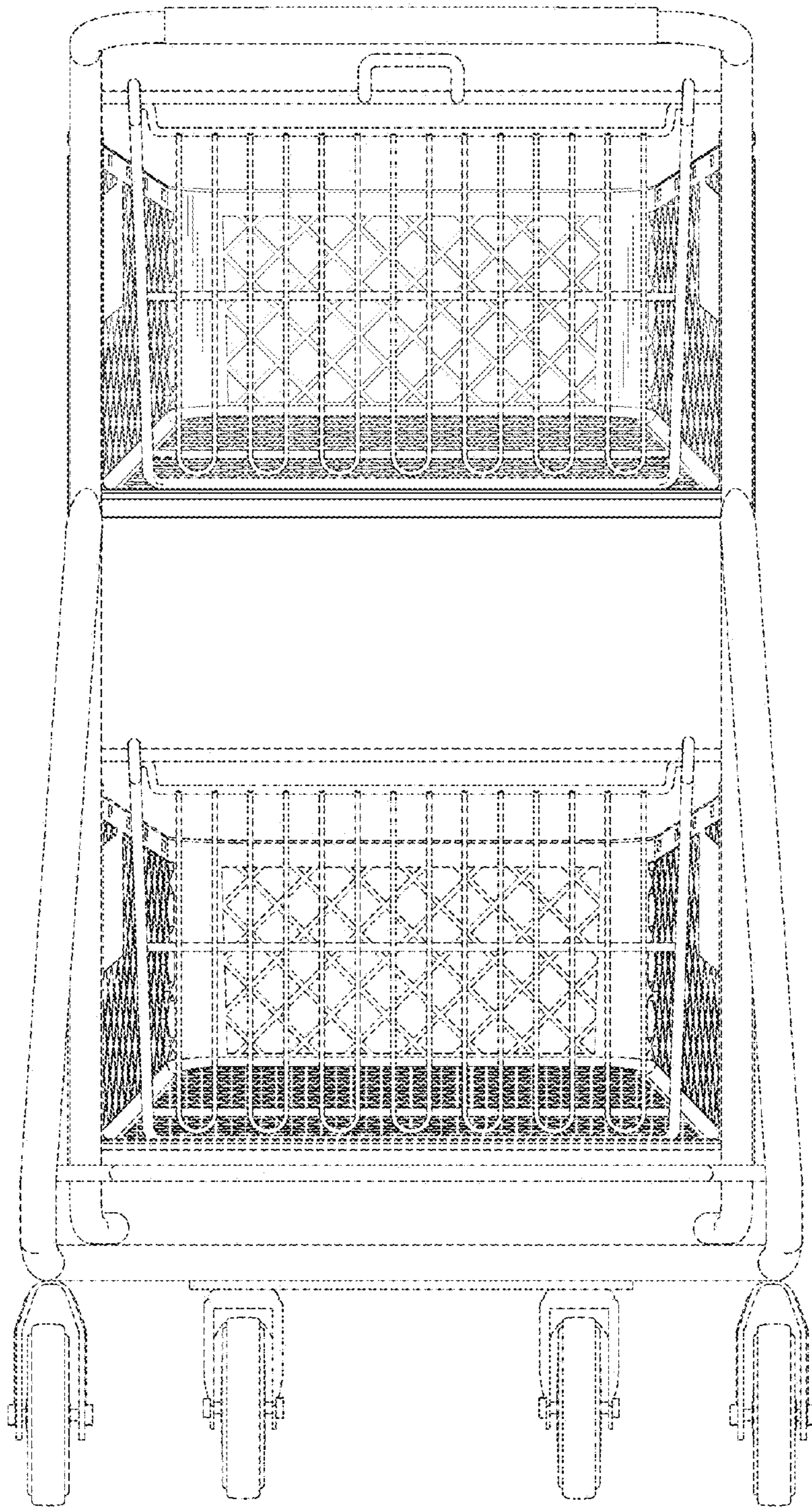

FIG.16

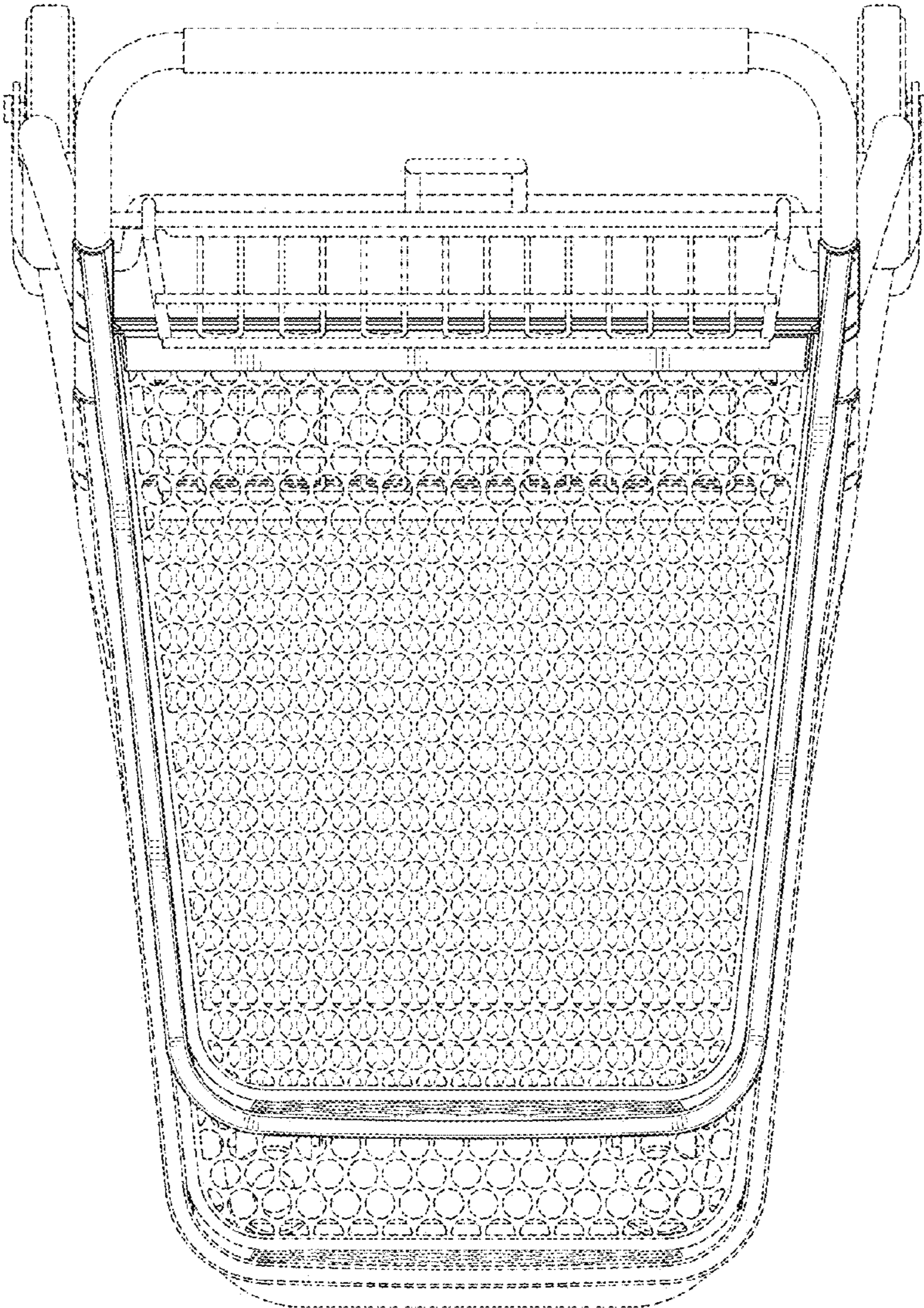

FIG.17

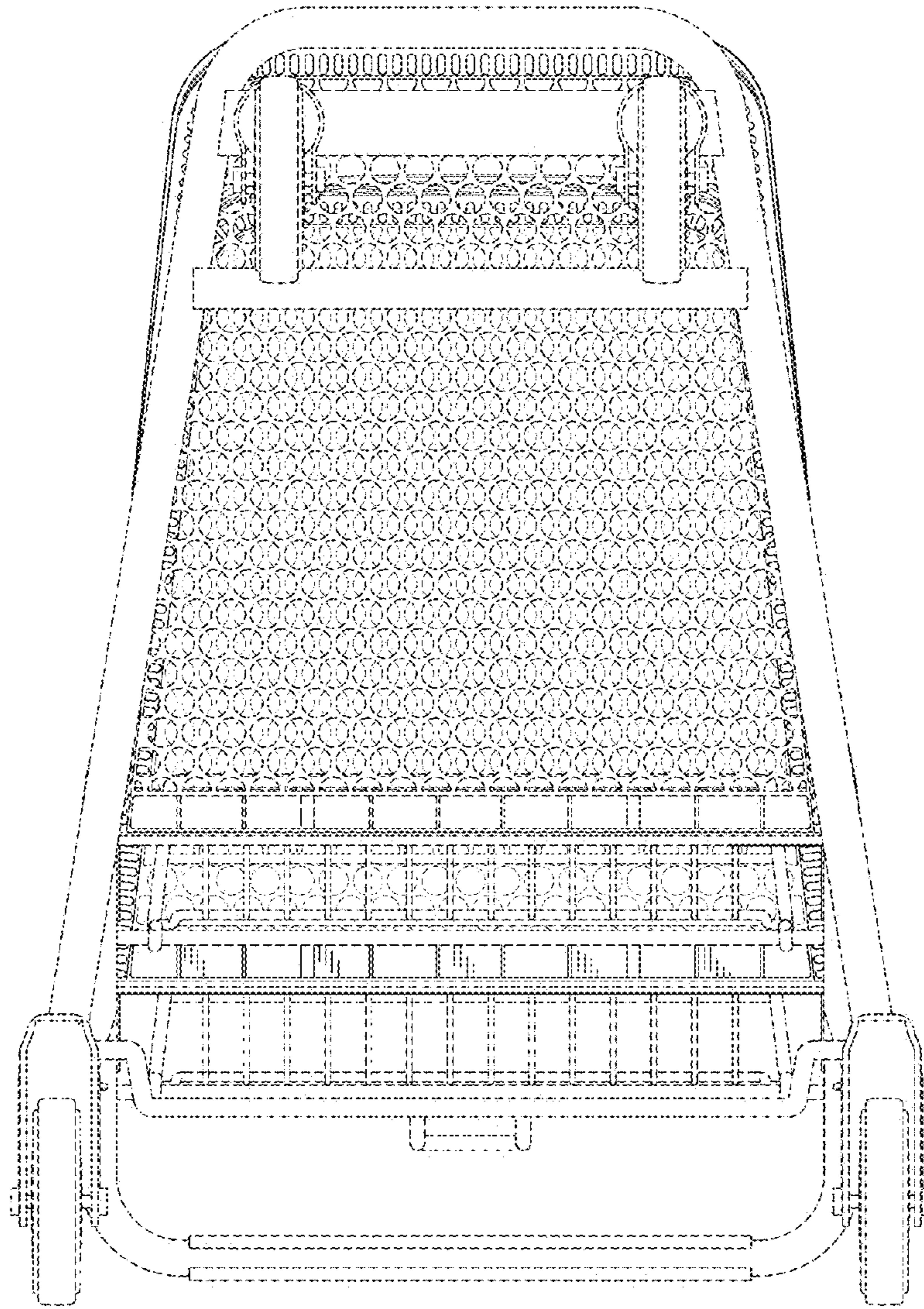

FIG.18

UNITED STATES PATENT AND TRADEMARK OFFICE
CERTIFICATE OF CORRECTION

PATENT NO. : RE45,961 E
APPLICATION NO. : 29/486266
DATED : April 5, 2016
INVENTOR(S) : Ivor Michel Walter et al.

Page 1 of 1

It is certified that error appears in the above-identified patent and that said Letters Patent is hereby corrected as shown below:

TITLE PAGE

Item 72 Inventors are Ivor Michel Walter, Jeroen Engle, and Wilson Zeng.

Signed and Sealed this
First Day of November, 2016



Michelle K. Lee
Director of the United States Patent and Trademark Office