



US00RE45669E

(19) **United States**
(12) **Reissued Patent**
Paterson et al.

(10) **Patent Number:** **US RE45,669 E**
(45) **Date of Reissued Patent:** **Sep. 15, 2015**

(54) **WATER CLOSET**

(75) Inventors: **Nicholas W. Paterson**, Sheboygan, WI (US); **Cecile Thalman-Gomez**, Ispra (IT)

(73) Assignee: **KOHLER CO.**, Kohler, WI (US)

(21) Appl. No.: **29/429,793**

(22) Filed: **Aug. 16, 2012**

Related U.S. Patent Documents

Reissue of:

(64) Patent No.: **Des. 621,918**
Issued: **Aug. 17, 2010**
Appl. No.: **29/343,895**
Filed: **Sep. 21, 2009**

(51) **LOC (10) Cl.** **23-02**

(52) **U.S. Cl.**
USPC **D23/295**

(58) **Field of Classification Search**
USPC D23/295, 301, 303, 309, 313; 4/300, 4/329, 353, 420

See application file for complete search history.

(56) **References Cited**

U.S. PATENT DOCUMENTS

D299,163	S	*	12/1988	Robinson	D23/274
D494,667	S	*	8/2004	Kergoet	D23/295
D496,444	S		9/2004	Kergoet		
D509,575	S	*	9/2005	Kergoet	D23/295
D559,367	S	*	1/2008	Maruhashi	D23/295
D559,961	S	*	1/2008	Maruhashi	D23/295
D594,945	S		6/2009	Nakasaki et al.		
D603,488	S	*	11/2009	Maruhashi	D23/295
D612,026	S	*	3/2010	Soulier	D23/295
D615,173	S	*	5/2010	Arets	D23/295

FOREIGN PATENT DOCUMENTS

CN	02374106.6	11/2002
CN	3302290	11/2002
CN	200630050690.8	1/2003
CN	3376251	9/2003

(Continued)

OTHER PUBLICATIONS

Hastings Bath Collection, "Verso Toilet and Bidet"; HomePortfolio.com online catalog. Copyright 1997-2007; HomePortfolio.com.

(Continued)

Primary Examiner — Phillip S Hyder

(74) *Attorney, Agent, or Firm* — Foley & Lardner LLP

(57) **CLAIM**

The ornamental design for a water closet, as shown and described.

DESCRIPTION

The present application is a broadening reissue of U.S. Pat. No. D621,918, which granted on Aug. 17, 2010, based on U.S. patent application Ser. No. 29/343,895, filed Sep. 21, 2009, the entire disclosure of which is incorporated herein by reference.

FIG. 1 is a right, top, front [perspective] *isometric* view of a water closet embodying our new design; FIG. 2 is a right side elevational view thereof; FIG. 3 is a left side elevational view thereof; FIG. 4 is a front elevational view thereof; FIG. 5 is a top plan view thereof; FIG. 6 is bottom plan view thereof; and, FIG. 7 is a rear elevational view thereof.

The broken line representations in the figures are for the purpose of illustration only, and form no part of the claimed design.

In a preferred embodiment, the nature of this product is a plumbing fixture in the form of a water closet, which is primarily useful for receiving the liquid and solid waste of humans.

1 Claim, 4 Drawing Sheets

Matter enclosed in heavy brackets [] appears in the original patent but forms no part of this reissue; matter printed in italics indicates the additions made by reissue.

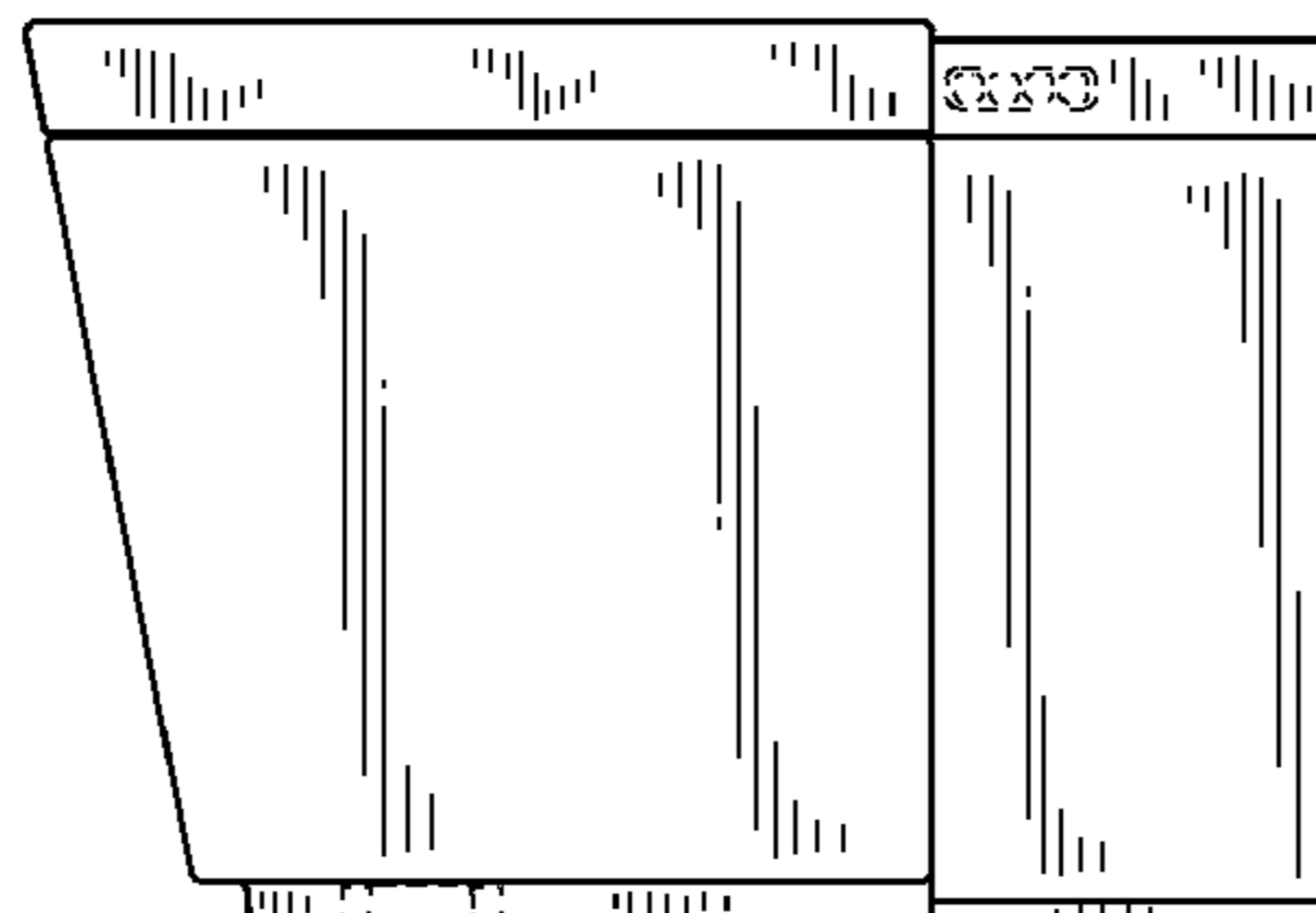

(56)

References Cited

FOREIGN PATENT DOCUMENTS

CN	3652563	4/2006
CN	300730493	12/2006
CN	300739614	4/2007
CN	300801484	7/2007
CN	200730349563.2	11/2007
CN	300894410	2/2008
CN	300905381	3/2008
CN	300917296	3/2008
EM	000110531-0002	4/2004
EM	00026450-0005	2/2005
EM	000264502-0001	2/2005
EM	000264502-0002	2/2005

EM	000264502-0005	2/2005
EM	000284502-0002	2/2005
EM	000833835-0002	1/2008
JP	843438	4/1992
JP	843438-2	4/1992
JP	843438-3	4/1992
JP	843438-3	9/1992
JP	1283637	9/2006

OTHER PUBLICATIONS

Kohler Co., "Escale Dual Flush Toilet Tank"; HomePortfolio.com online catalog. Copyright 1997-2007 HomePortfolio.com.
Duravit, "2nd Floor"; Model No. 011009; Duravit.com online catalog. Copyright 2008 Duravit.

* cited by examiner

FIG. 1

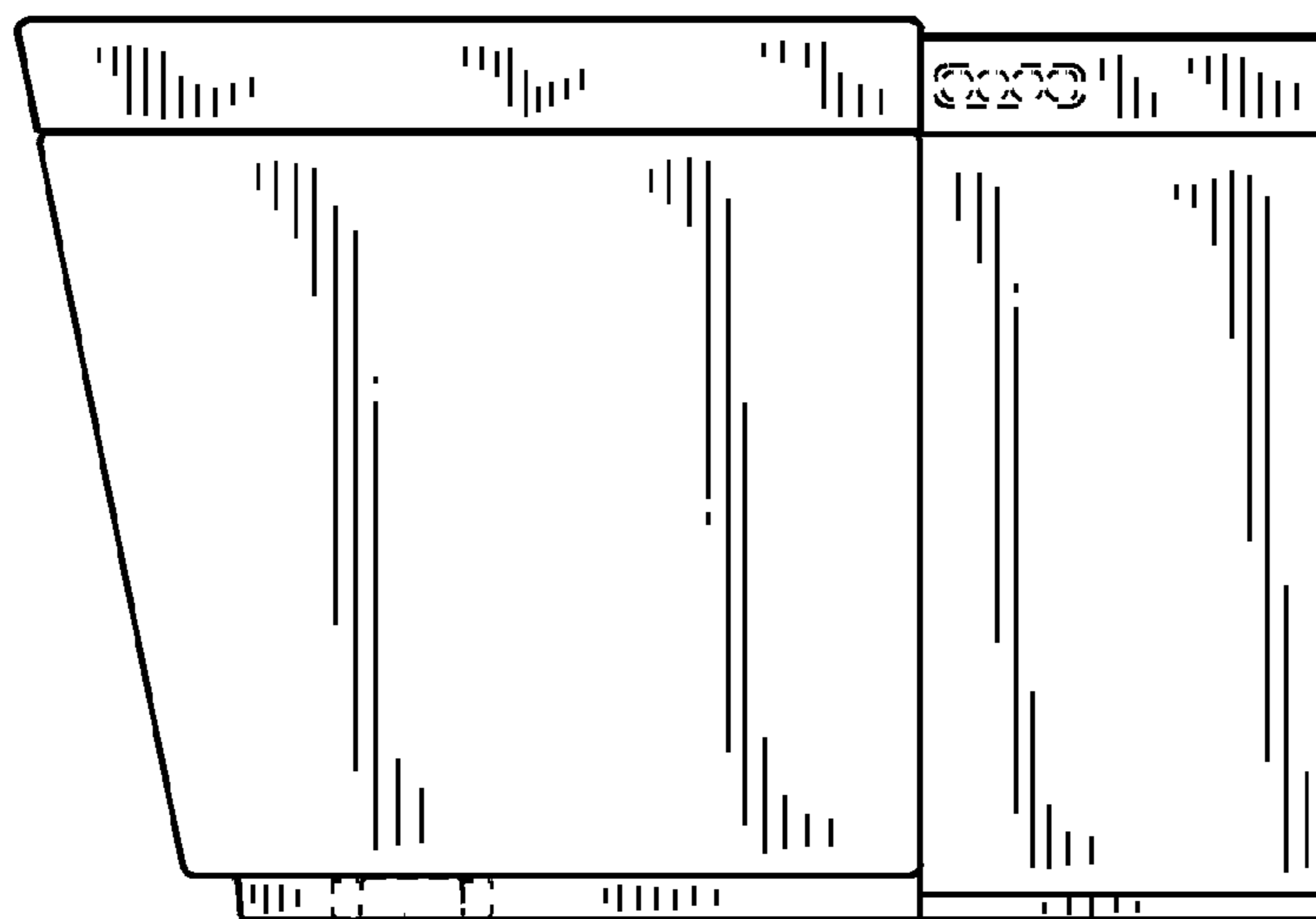
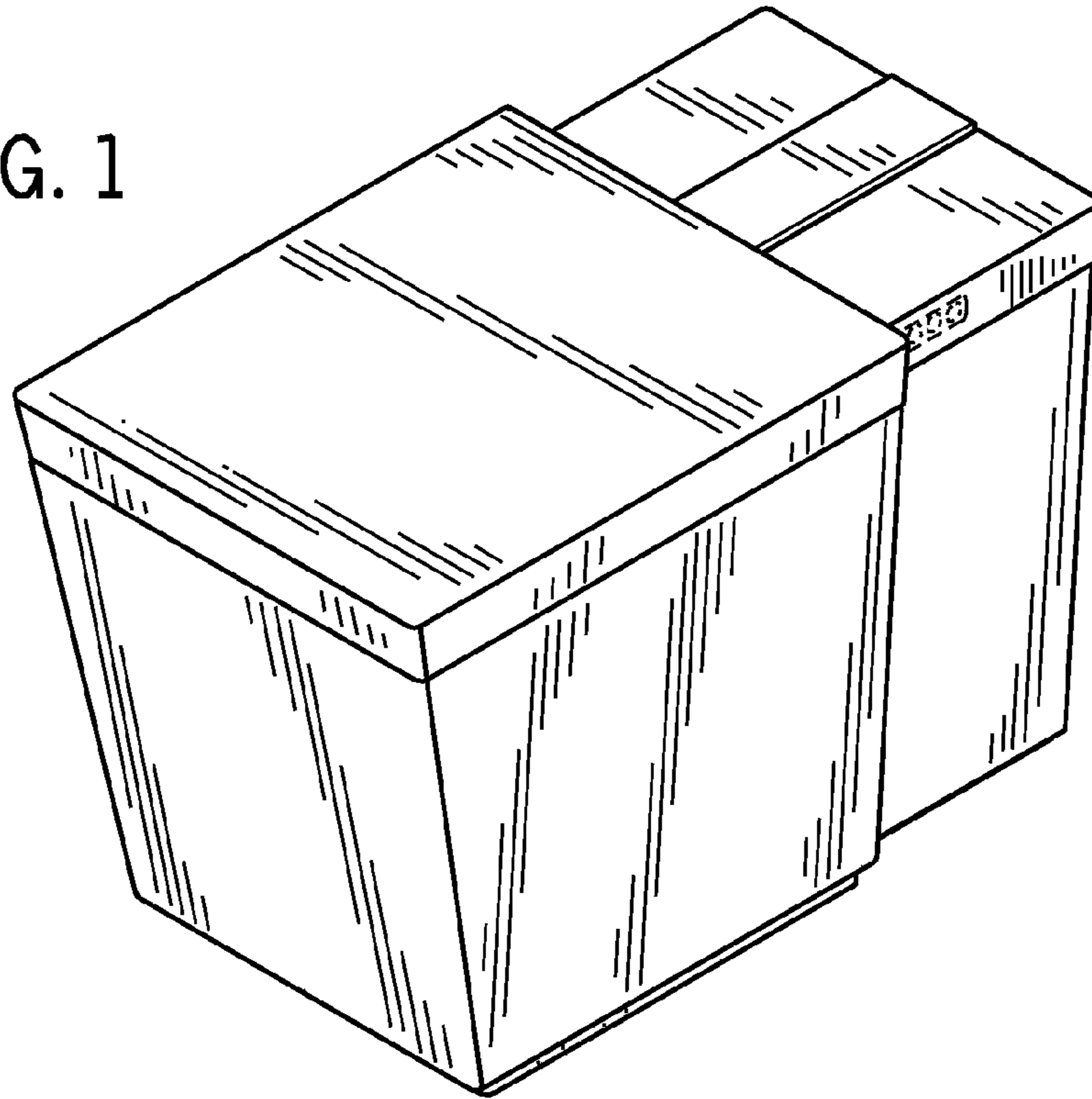

FIG. 2

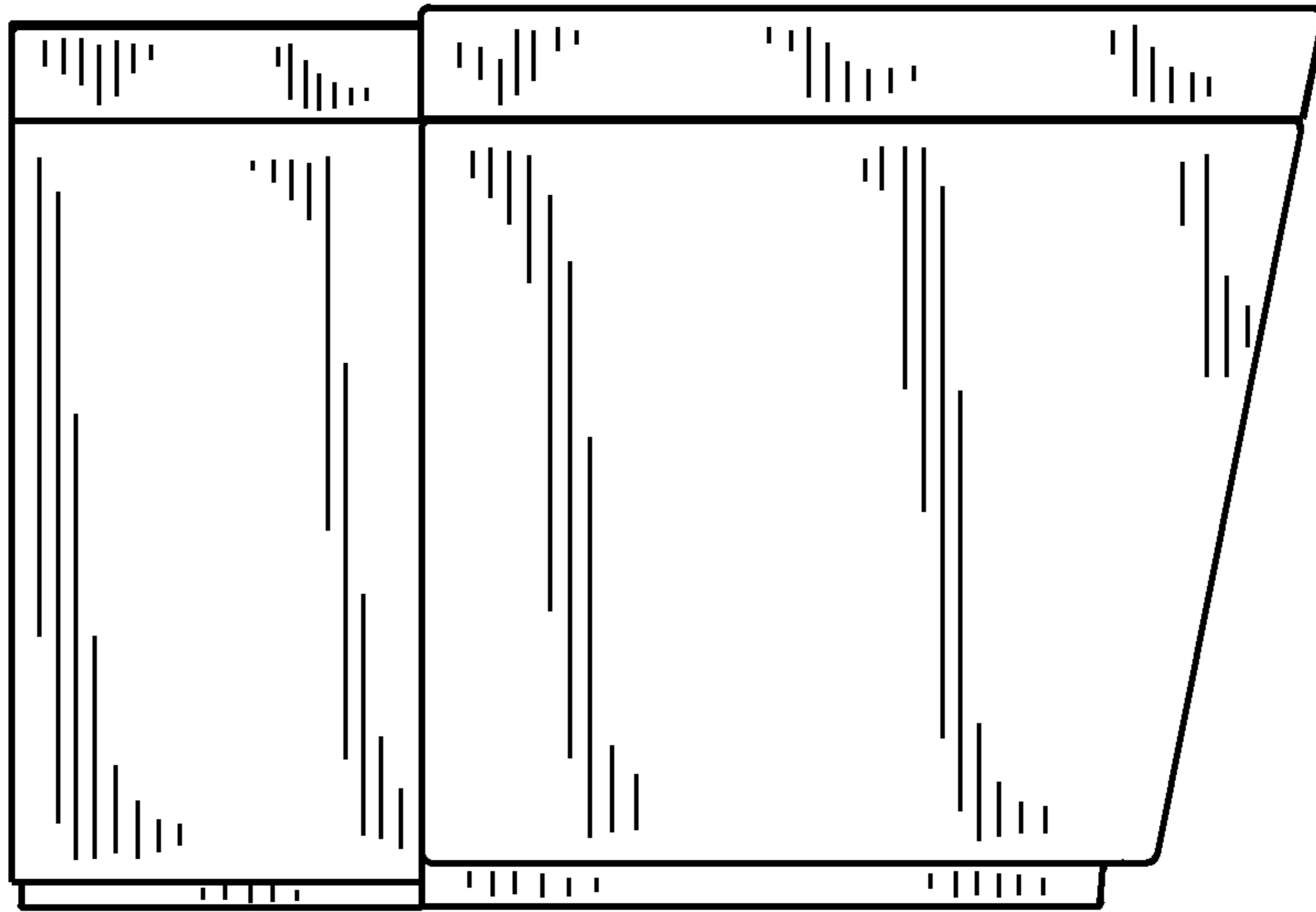

FIG. 3

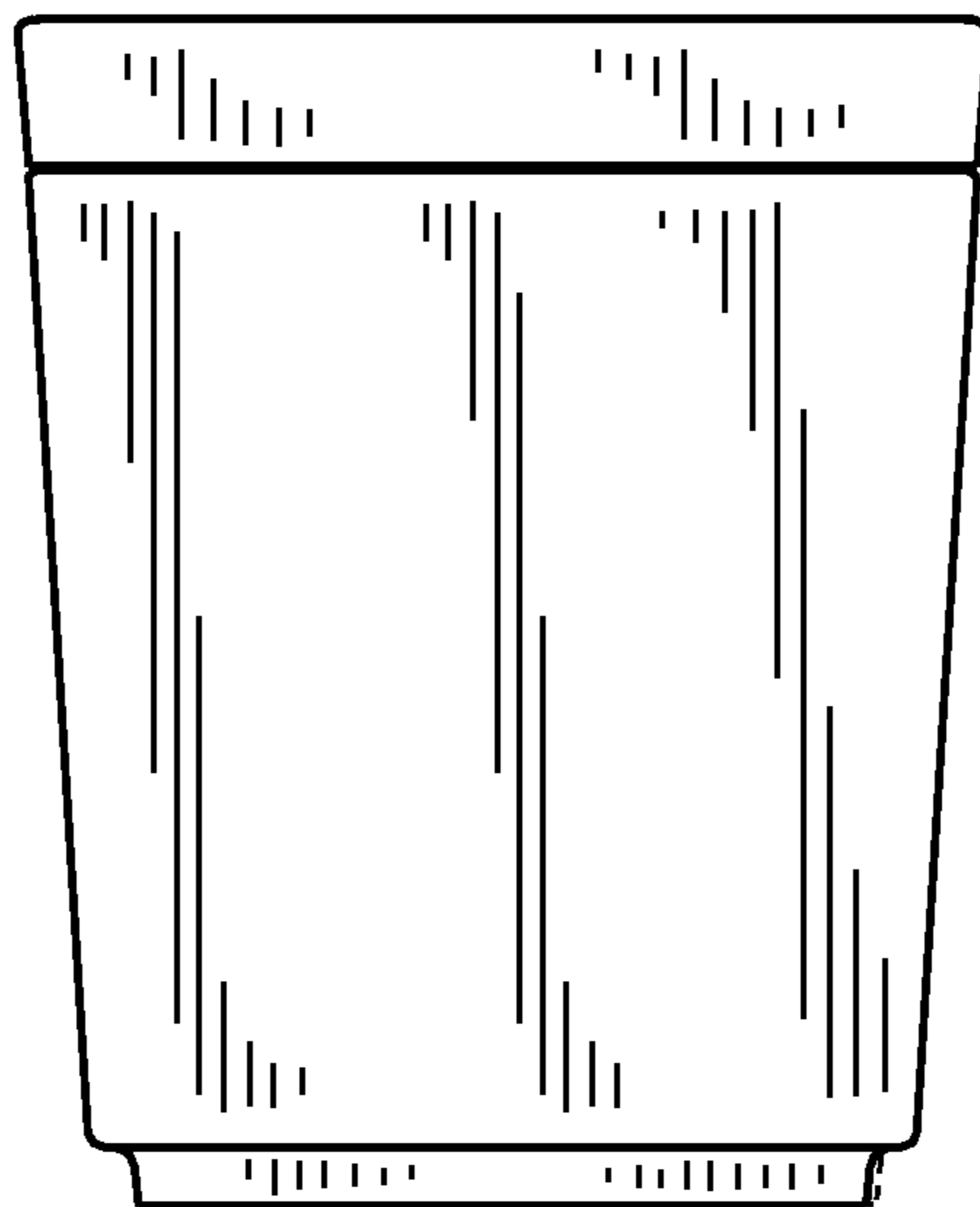

FIG. 4

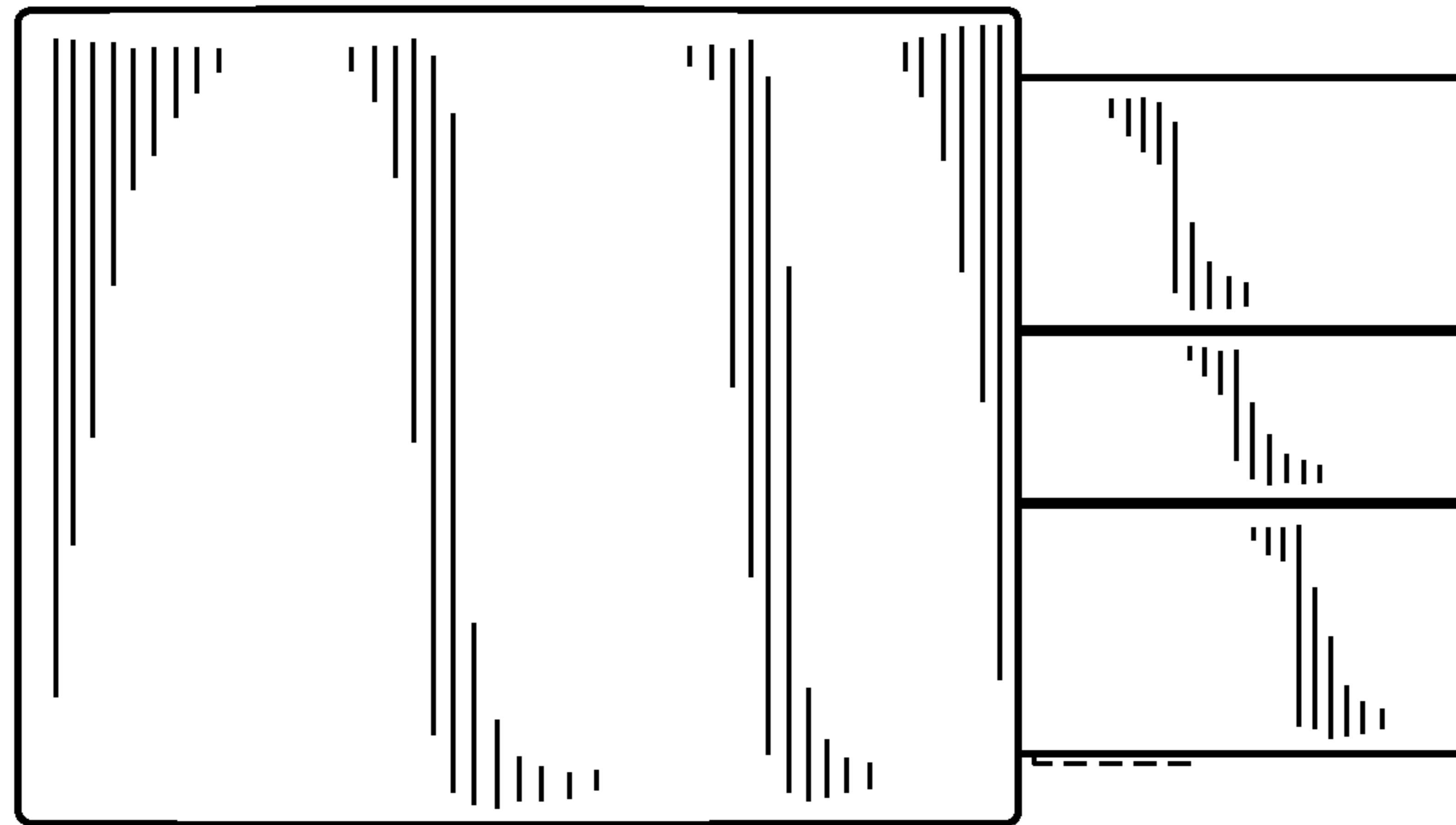

FIG. 5

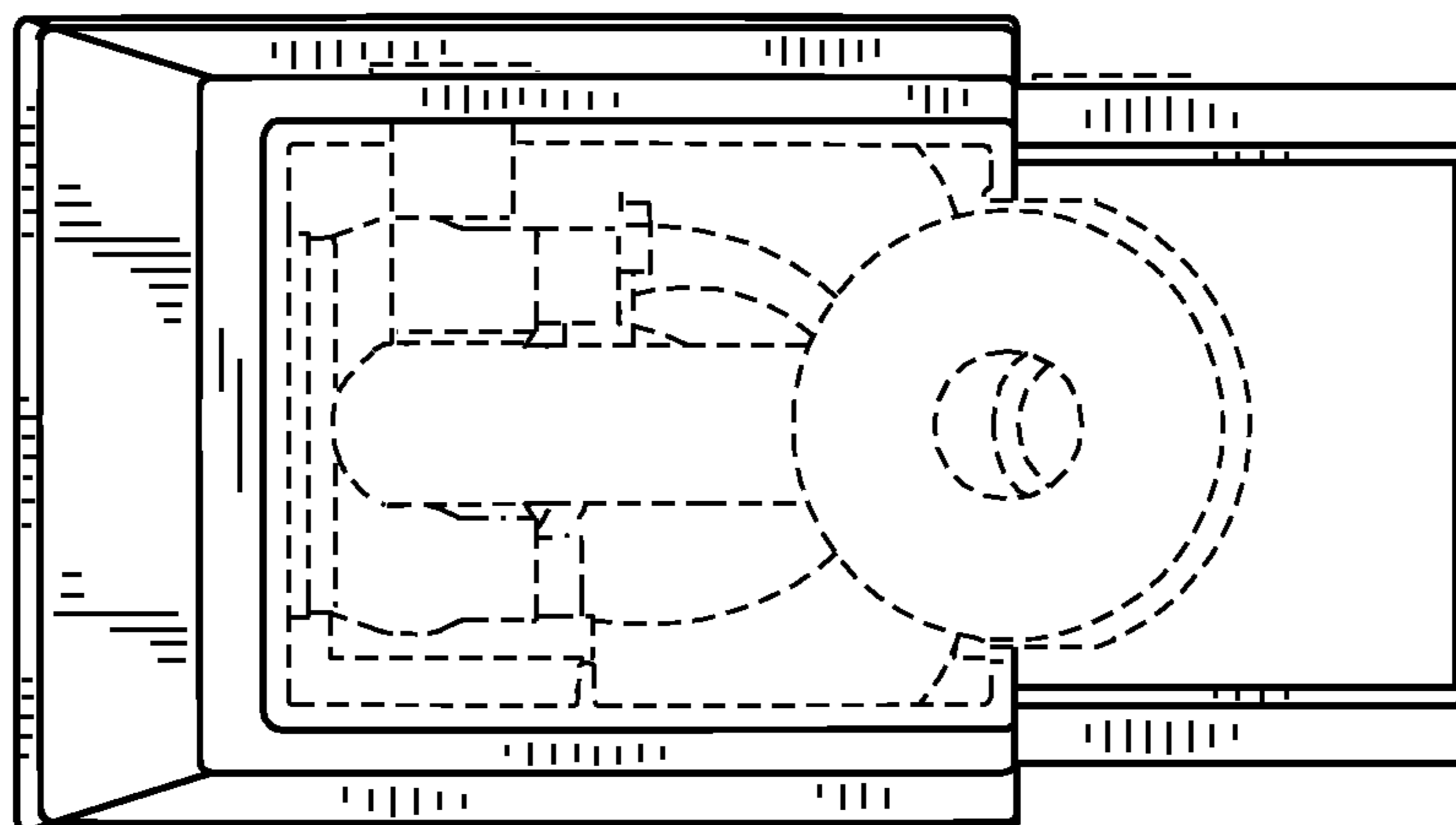

FIG. 6

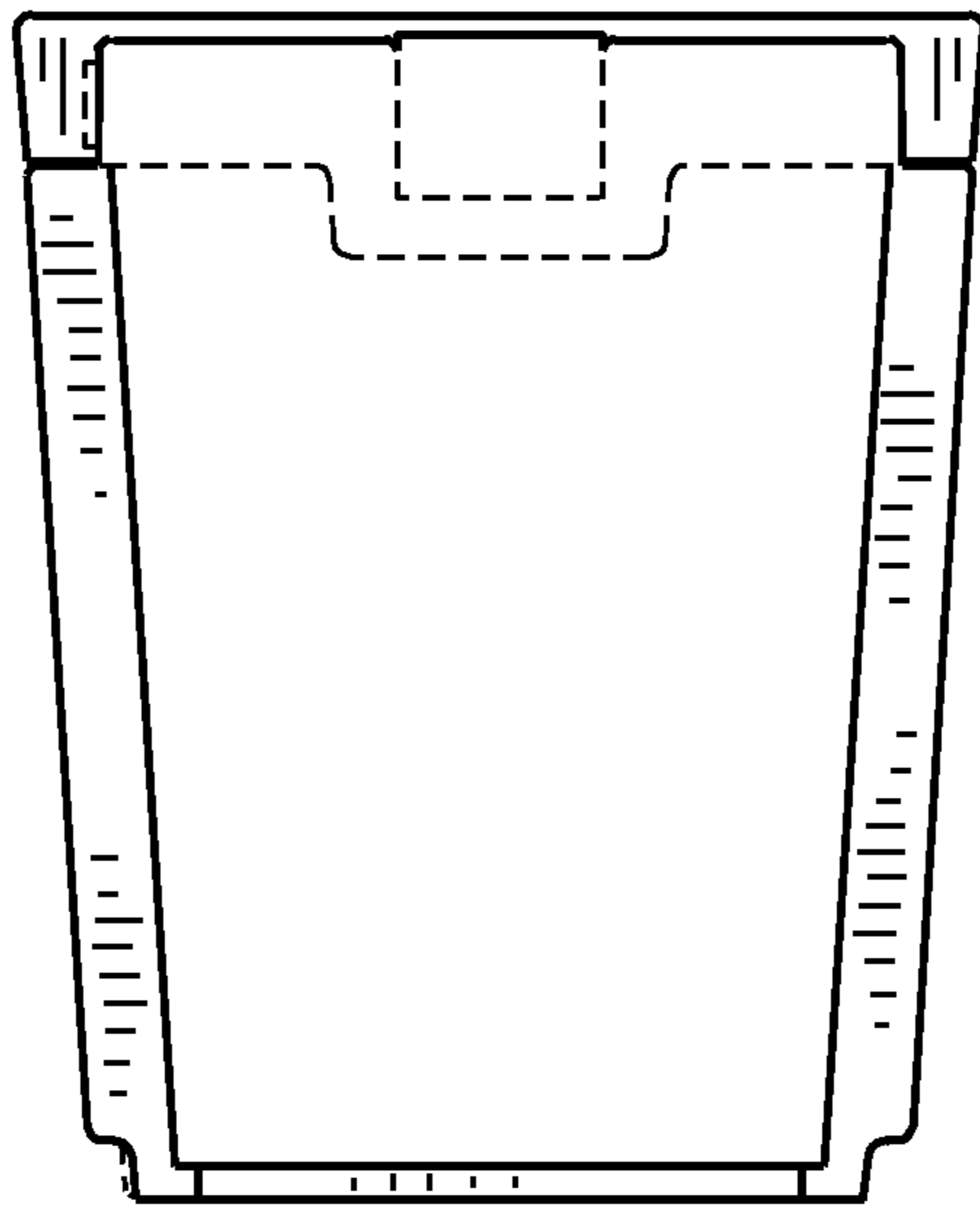

FIG. 7

UNITED STATES PATENT AND TRADEMARK OFFICE
CERTIFICATE OF CORRECTION

PATENT NO. : RE45,669 E
APPLICATION NO. : 29/429793
DATED : September 15, 2015
INVENTOR(S) : Nicholas W. Paterson and Cecile Thalmann-Gomez

Page 1 of 1

It is certified that error appears in the above-identified patent and that said Letters Patent is hereby corrected as shown below:

On the title page, item (75) Inventors:

The second inventor's name is spelled incorrectly as "Cecile Thalman-Gomez" and should be

--Cecile Thalmann-Gomez--.

Signed and Sealed this
Twentieth Day of December, 2016



Michelle K. Lee
Director of the United States Patent and Trademark Office