



US00RE45434E

(19) **United States**
(12) **Reissued Patent**
Okamoto

(10) **Patent Number:** **US RE45,434 E**
(45) **Date of Reissued Patent:** ***Mar. 24, 2015**

(54) **INFORMATION TRANSMITTING APPARATUS AND METHOD, INFORMATION RECEIVING APPARATUS AND METHOD, INFORMATION TRANSMITTING AND RECEIVING SYSTEM AND METHOD, RECORDING MEDIUM AND PROGRAM**

(52) **U.S. Cl.**
CPC **H04N 7/083** (2013.01)
USPC **370/535; 370/487; 370/252**
(58) **Field of Classification Search**
CPC H04N 7/083
USPC 370/535, 487, 252; 725/148
See application file for complete search history.

(71) Applicant: **Sony Corporation**, Tokyo (JP)
(72) Inventor: **Hiroshige Okamoto**, Kanagawa (JP)
(73) Assignee: **Sony Corporation** (JP)
(*) Notice: This patent is subject to a terminal disclaimer.

(56) **References Cited**
U.S. PATENT DOCUMENTS
4,589,018 A 5/1986 Haskell et al.
4,680,647 A * 7/1987 Moriyama 386/316
(Continued)

(21) Appl. No.: **13/934,892**
(22) Filed: **Jul. 3, 2013**

FOREIGN PATENT DOCUMENTS
EP 1 032 200 A2 8/2000
EP 1 231 795 A2 8/2002
(Continued)

Related U.S. Patent Documents

Reissue of:
(64) Patent No.: **8,064,361**
Issued: **Nov. 22, 2011**
Appl. No.: **12/586,756**
Filed: **Sep. 28, 2009**

OTHER PUBLICATIONS
Fibush, D.K., "Integrating Digital Audio Into the Serial Digital Video Signal", SMPTE Journal, vol. 103, No. 9, Sep. 1, 1994, pp. 574-579.
(Continued)

U.S. Applications:
(63) Continuation of application No. 11/724,770, filed on Mar. 16, 2007, now Pat. No. 7,688,868, which is a continuation of application No. 10/095,848, filed on Mar. 12, 2002, now Pat. No. 7,209,496.

Primary Examiner — John Pezzlo
(74) *Attorney, Agent, or Firm* — Lerner, David, Littenberg, Krumholz & Mentlik, LLP

(30) **Foreign Application Priority Data**
Mar. 12, 2001 (JP) P2001-067969

(57) **ABSTRACT**
An original blanking period of a video signal is shortened to a set blanking period, and audio data is multiplexed into a resulting superimposing period. Table distinguishing data indicating the length of the superimposing period is inserted into the period as a blanking signal. With this configuration, it is possible to enable transmission and reception of an audio signal in a system capable of transmitting and receiving a video signal.

(51) **Int. Cl.**
H04L 12/28 (2006.01)
H04N 7/083 (2006.01)
H04J 1/16 (2006.01)

28 Claims, 17 Drawing Sheets

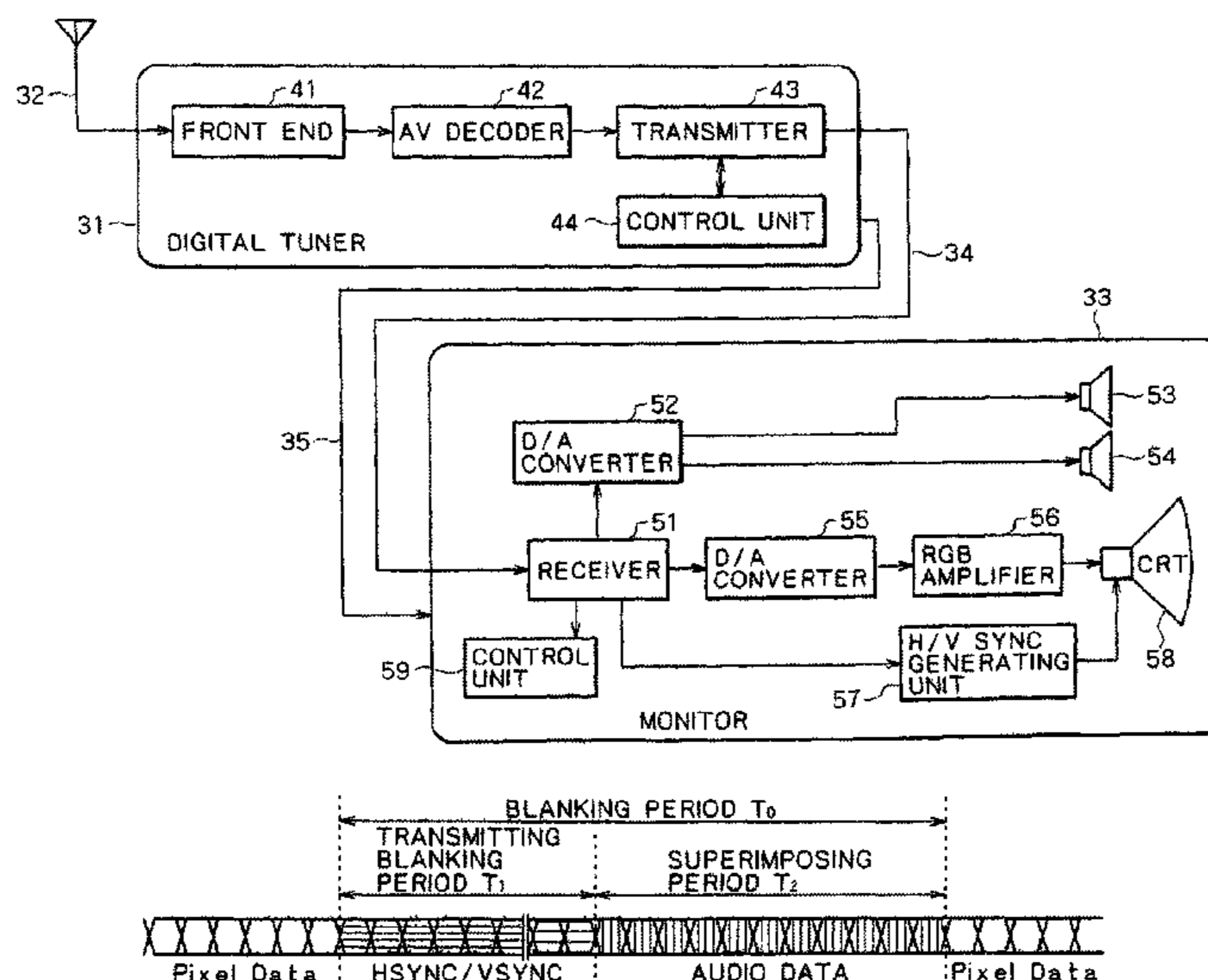

(56)

References Cited

U.S. PATENT DOCUMENTS

5,796,441	A	8/1998	Oshita et al.	
5,929,921	A	7/1999	Taniguchi et al.	
5,940,070	A	8/1999	Koo	
6,151,334	A	11/2000	Kim et al.	
6,243,469	B1	6/2001	Kataoka et al.	
6,297,797	B1	10/2001	Takeuchi et al.	
6,437,824	B1	8/2002	Suzuki et al.	
RE37,879	E	10/2002	Takeuchi	
6,678,333	B1	1/2004	Yamashita	
7,096,487	B1 *	8/2006	Gordon et al.	725/91
7,499,545	B1 *	3/2009	Bagshaw	380/212
7,499,628	B2	3/2009	Yuen et al.	
2001/0036193	A1 *	11/2001	Kori	370/402
2002/0171761	A1 *	11/2002	Suzuki et al.	348/484
2002/0199149	A1 *	12/2002	Nagasaki et al.	714/752
2003/0145336	A1 *	7/2003	Matsuzaki et al.	725/136
2009/0052471	A1 *	2/2009	Pasqualino et al.	370/493
2014/0078155	A1	3/2014	MacInnis et al.	

FOREIGN PATENT DOCUMENTS

EP	1303145	4/2003
EP	1303145 A1	4/2003

JP	4-284084	10/1992
JP	5-219488	8/1993
JP	06-78280	3/1994
JP	6-121313	4/1994
JP	9-046661	2/1997
JP	9-179536	7/1997
JP	2002-281464	9/2002
WO	97/48056 A1	12/1997
WO	99/12306 A1	3/1999
WO	00/14626 A1	3/2000
WO	02/09443 A1	1/2002

OTHER PUBLICATIONS

“Digital Visual Interface DVI Revision 1.0”, DDWG (Digital Display Working Group), Apr. 1999, p. 24-32 <http://www.ddwg.org/>.

“PanelLink NV: The Digital Solution for HDTV White Paper”, Silicon Image, Feb. 2001, p. 1-12 <http://www.siliconimage.com/docs/SiI-WP-003-A.pdf>.

European Search Report, EP 10172873, dated Nov. 3, 2010.

European Search Report, EP 10172870, dated Nov. 3, 2010.

European Search Report, EP 10172881, dated Nov. 3, 2010.

* cited by examiner

FIG. 1

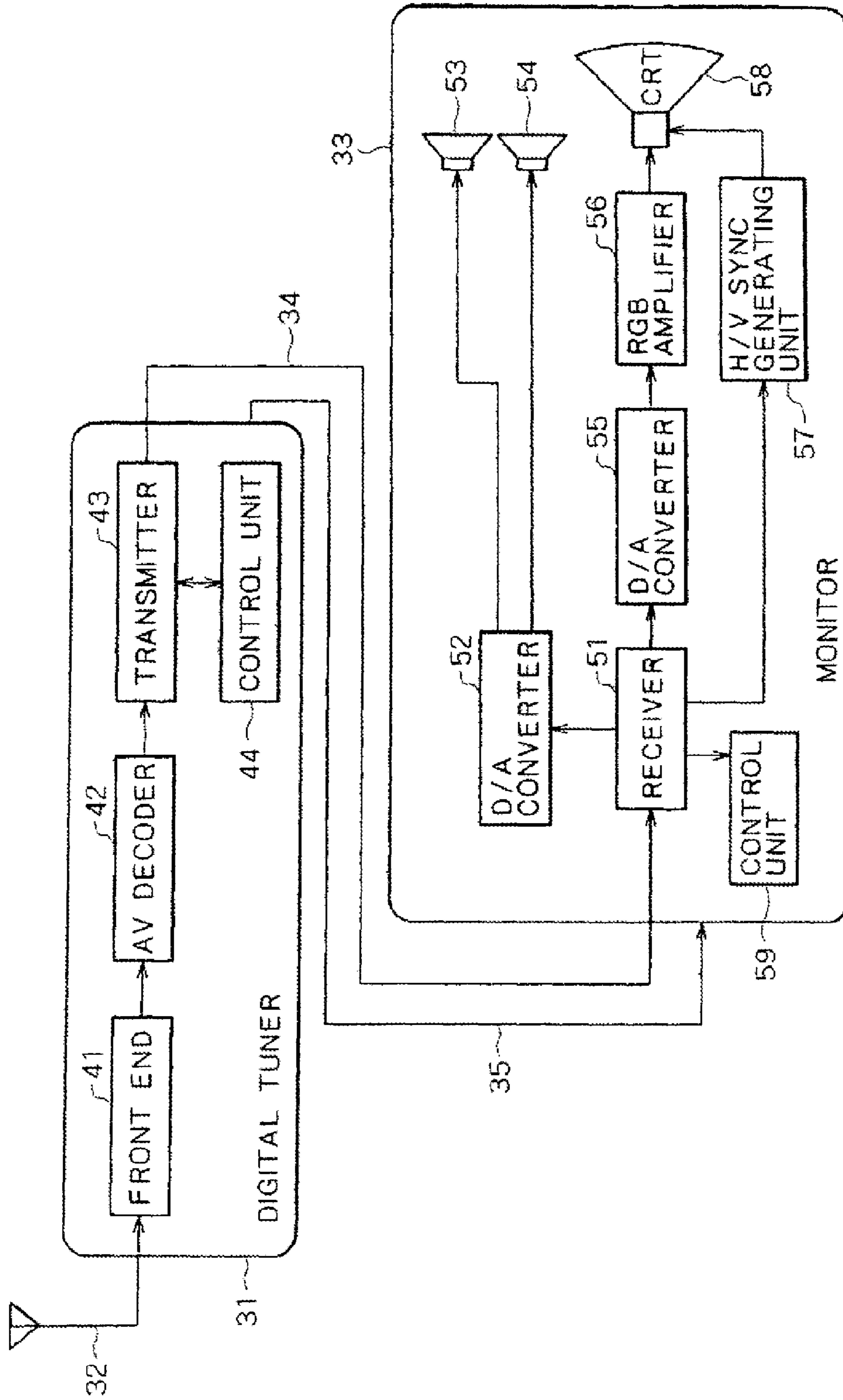

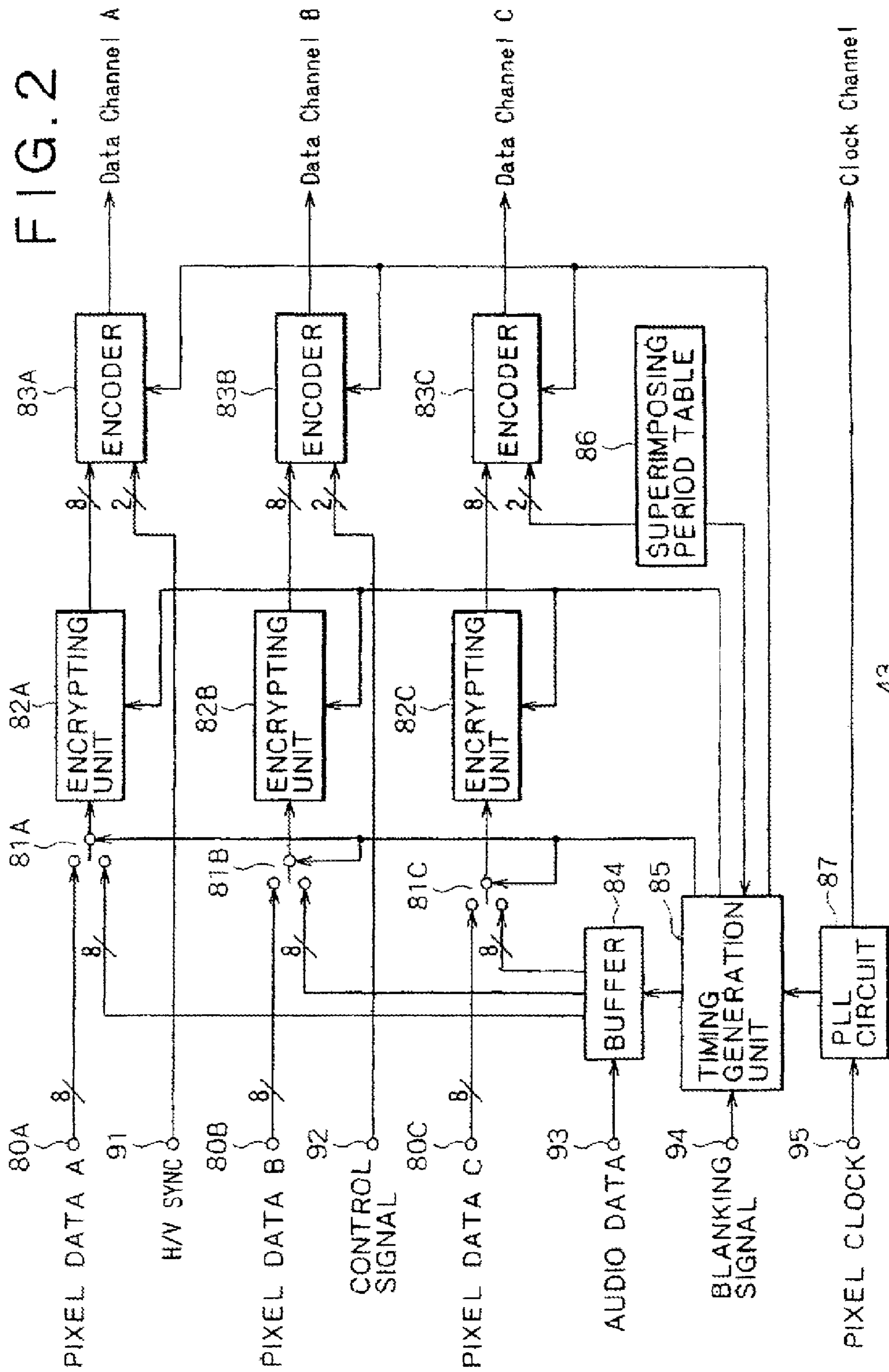

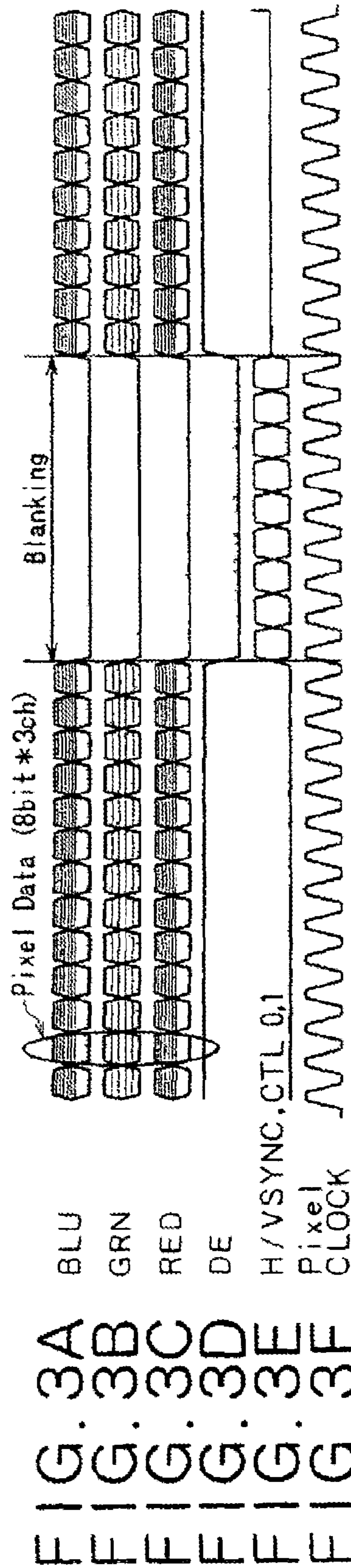

FIG. 4

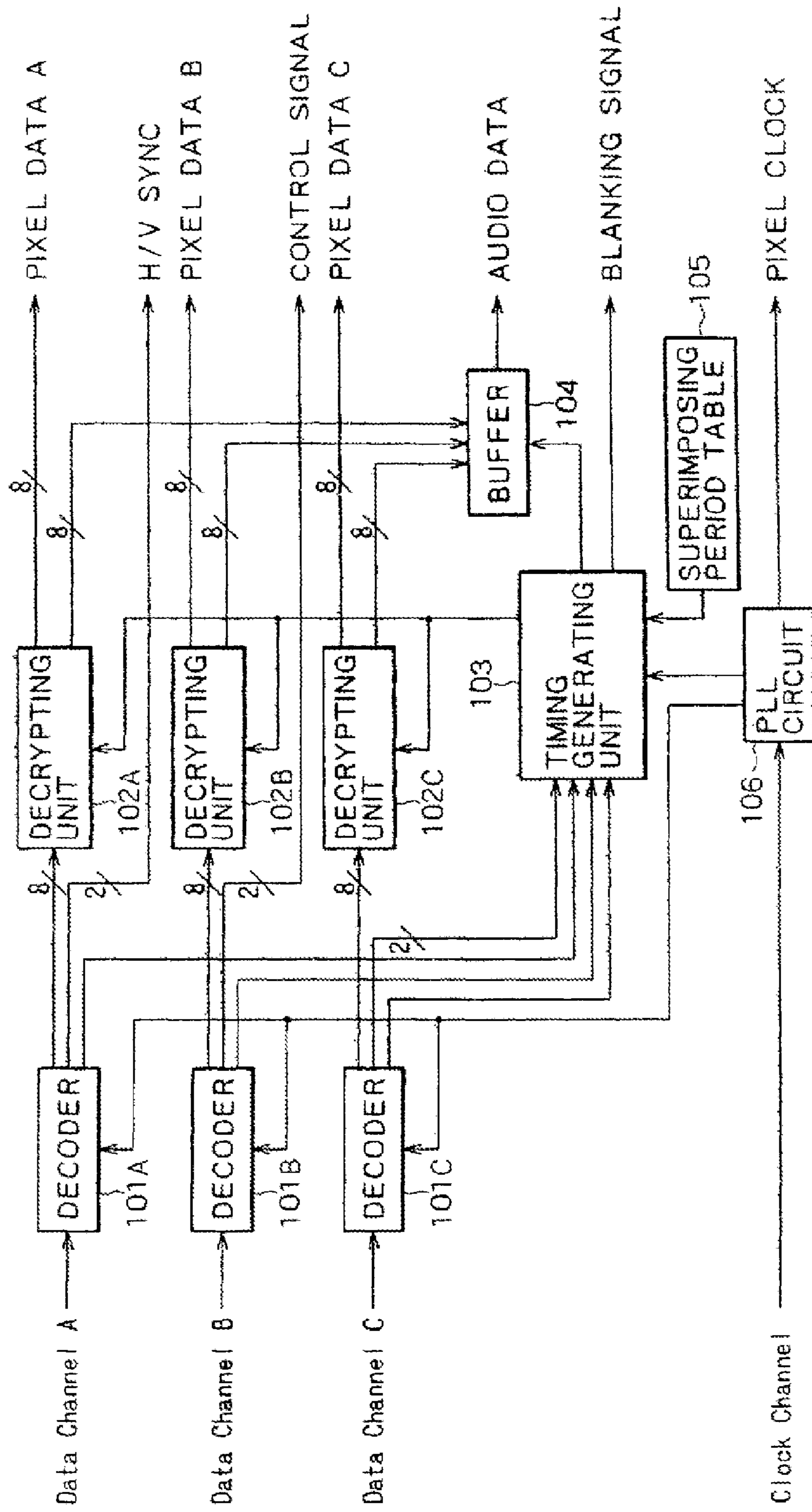

FIG. 5

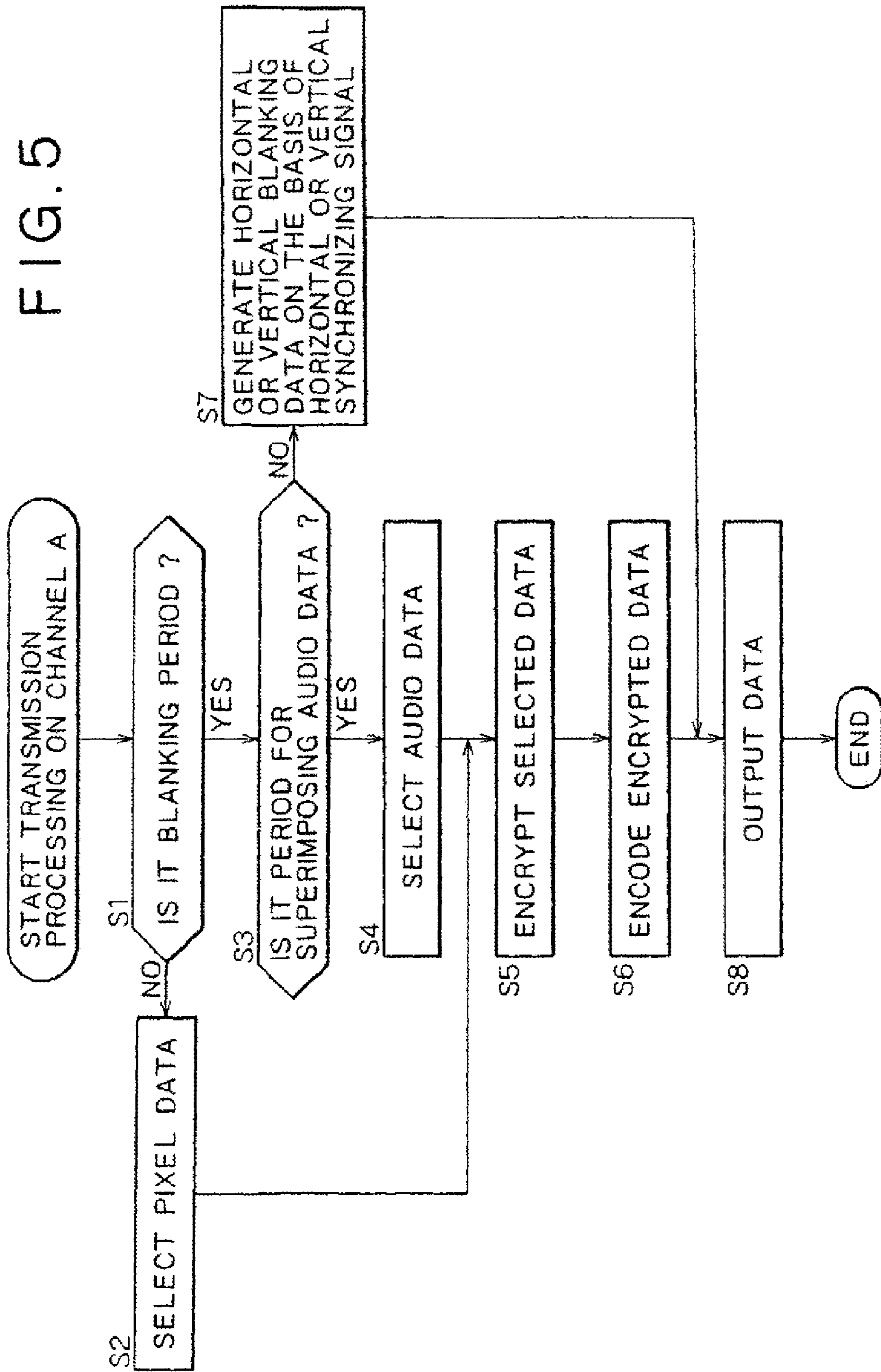

FIG. 6

C 1	C 0	CTL Code
0	0	0 0 1 0 1 0 1 0 1 1
0	1	1 1 0 1 0 1 0 1 0 0
1	0	0 0 1 0 1 0 1 0 1 0
1	1	1 1 0 1 0 1 0 1 0 1

FIG. 7

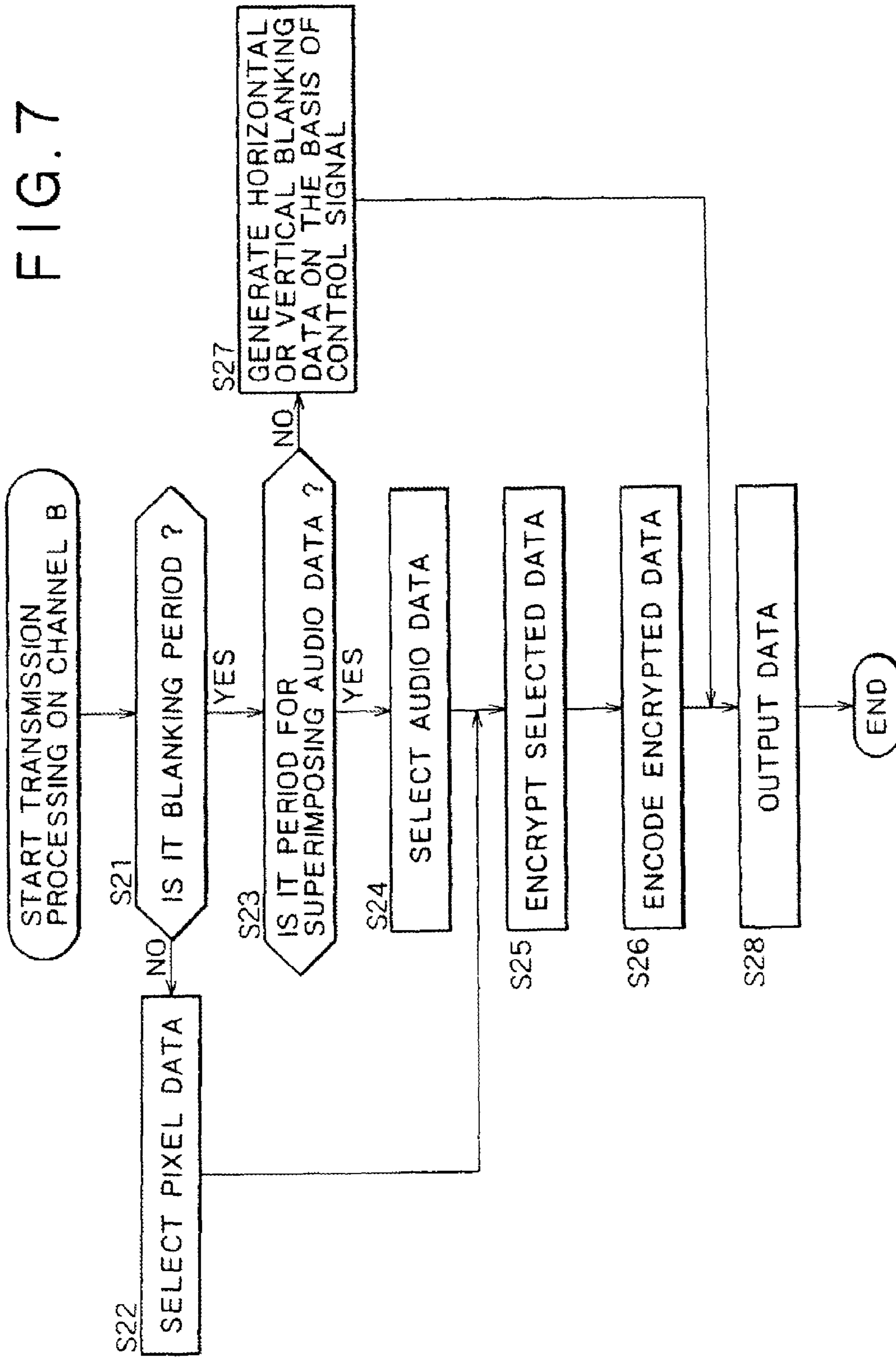
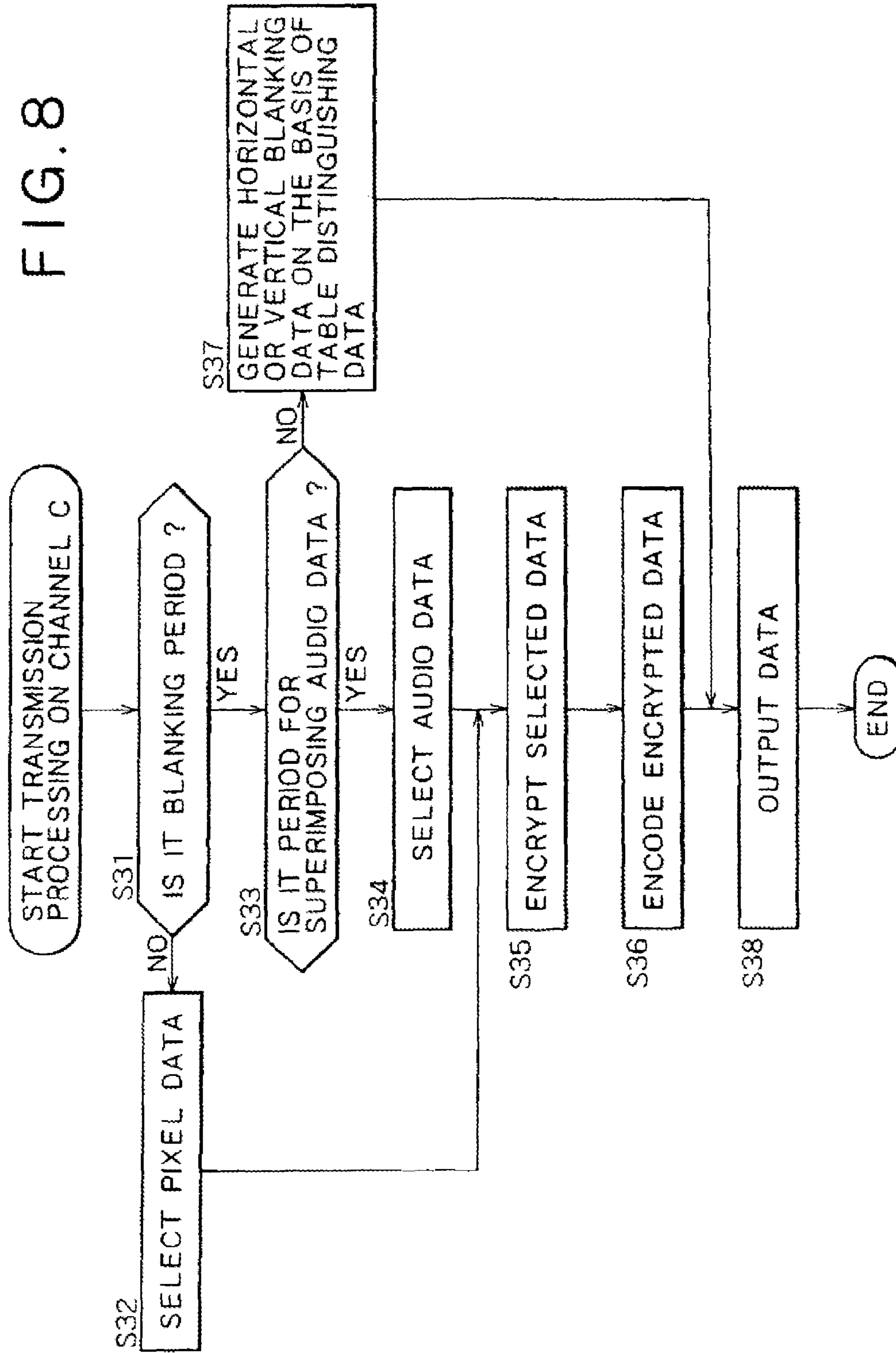

FIG. 8



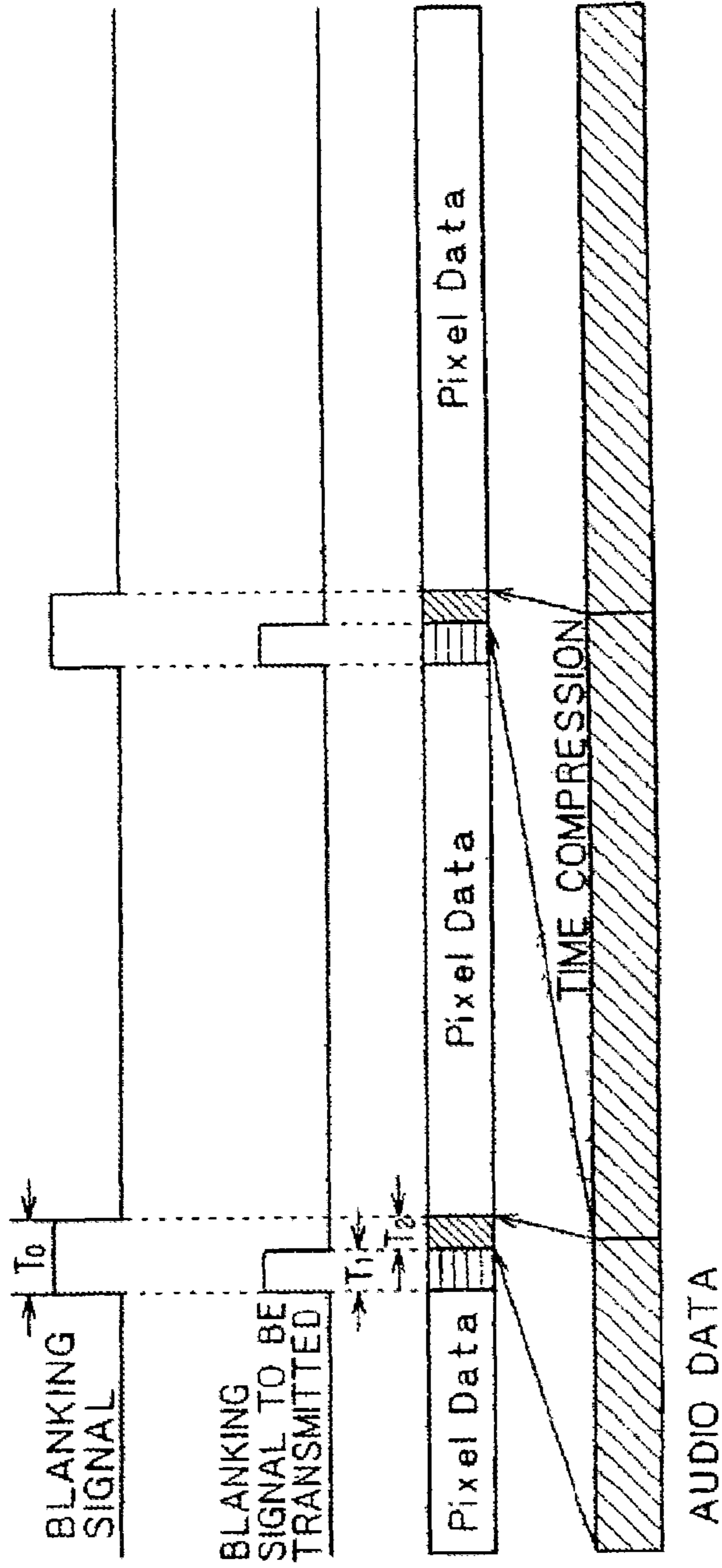

FIG. 9A

FIG. 9B

FIG. 9C

FIG. 9D

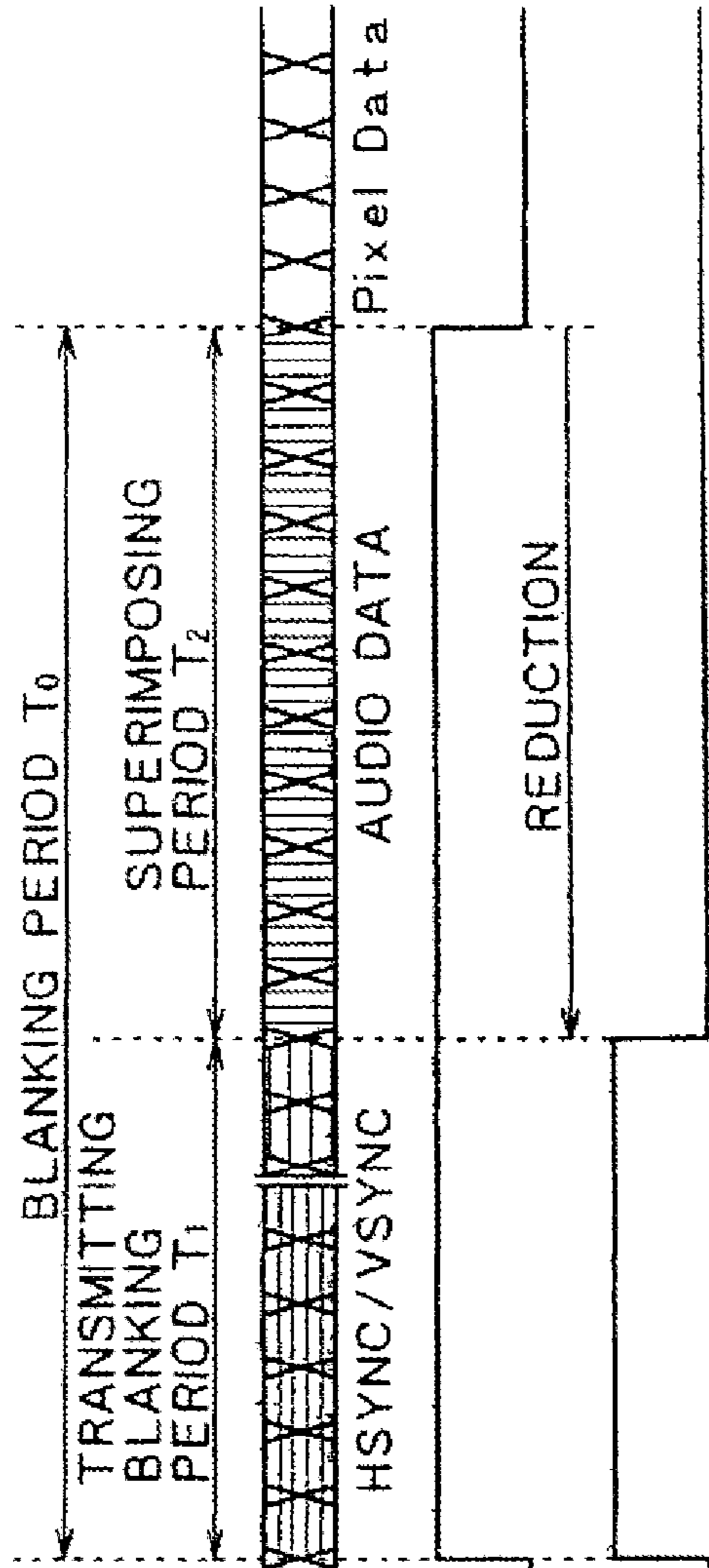

FIG. 10A

FIG. 10B

FIG. 10C

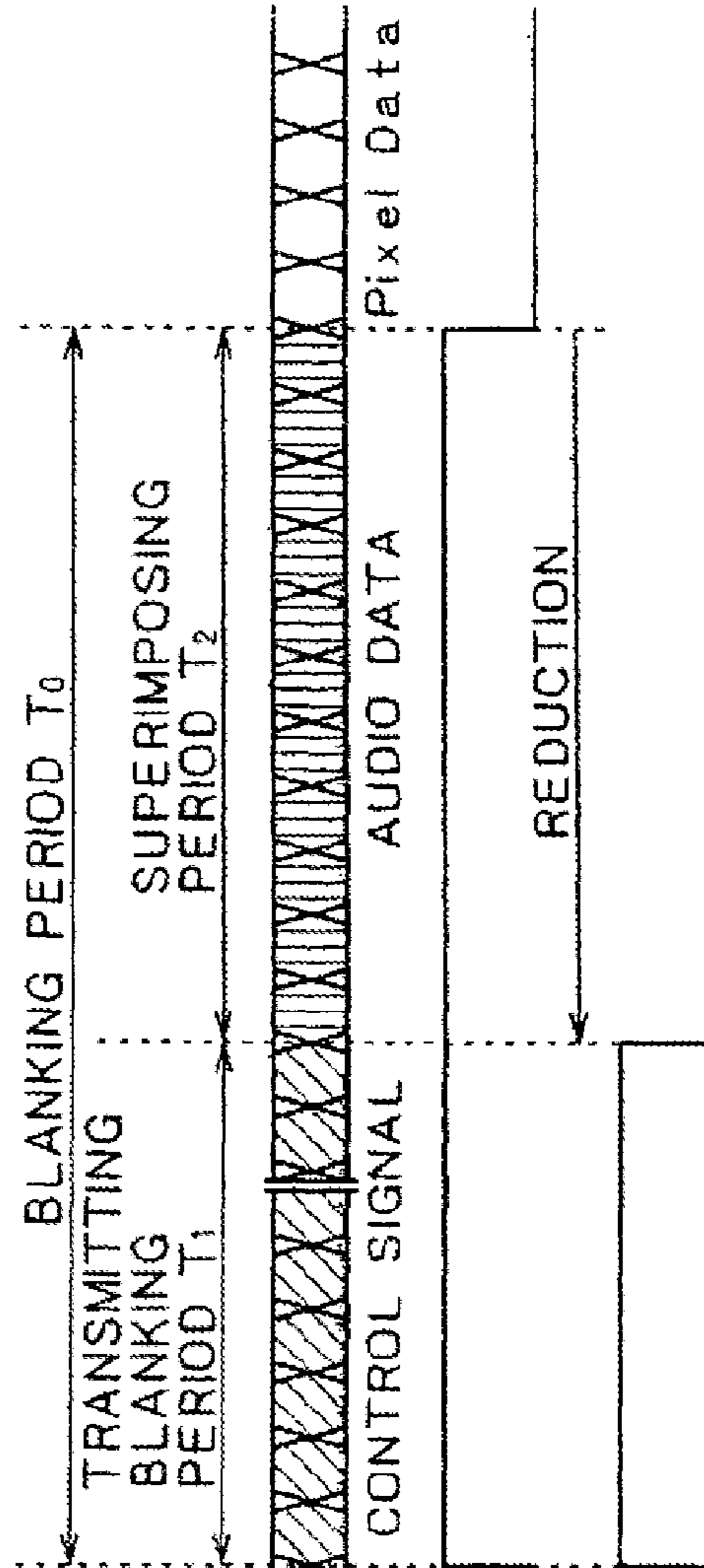

FIG. 11A

FIG. 11B

FIG. 11C

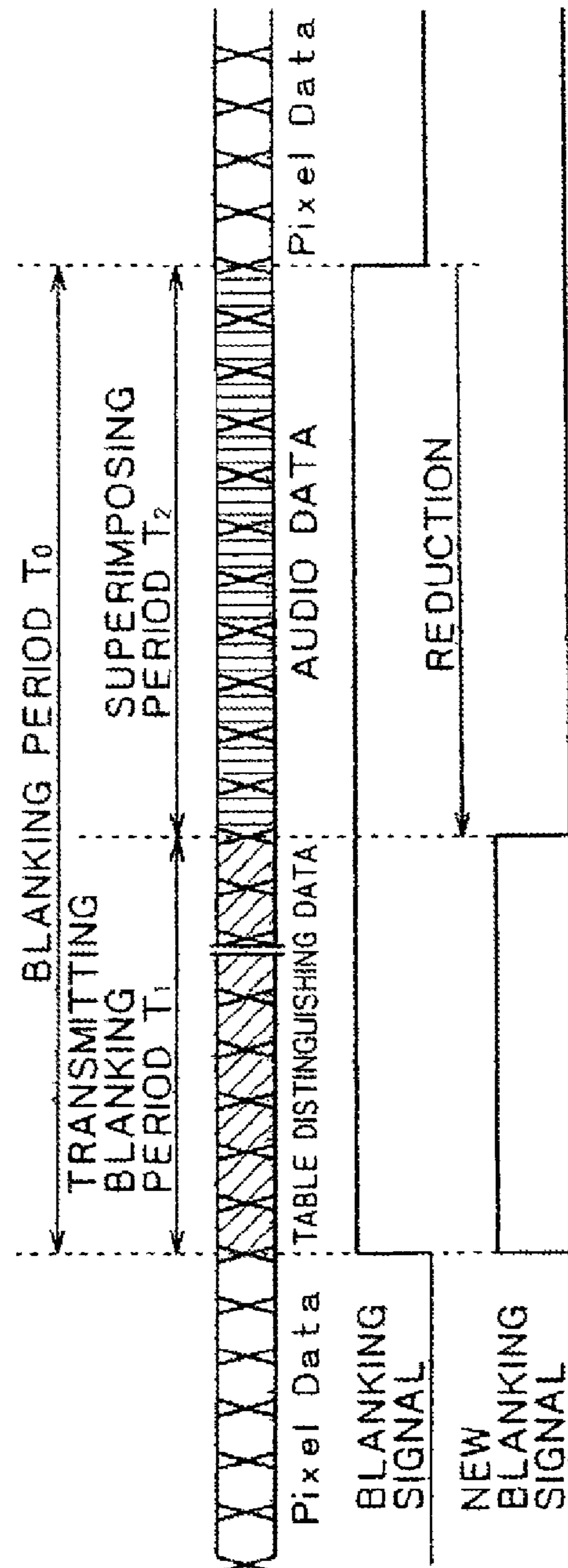

FIG. 12A

FIG. 12B

FIG. 12C

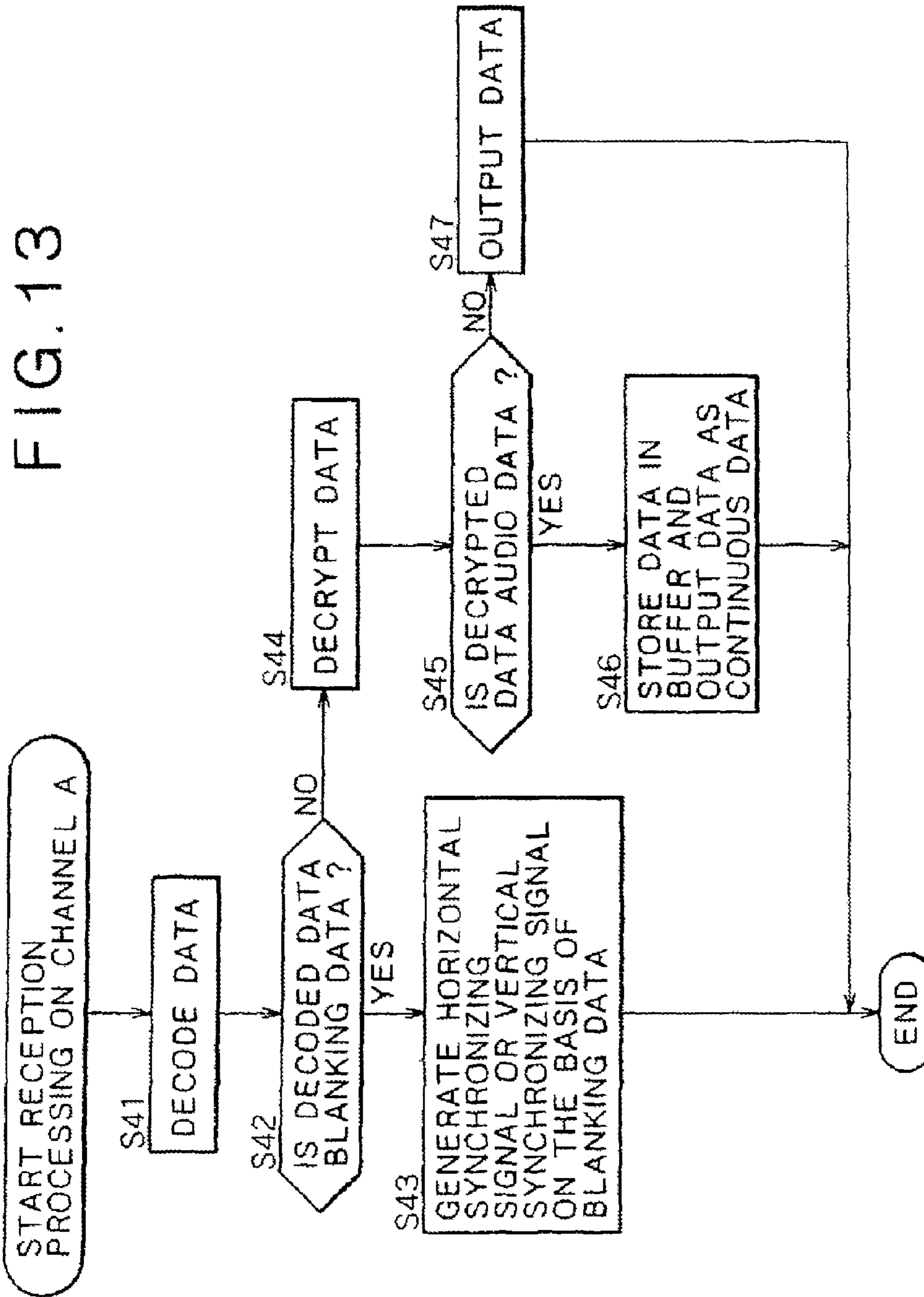

FIG. 14

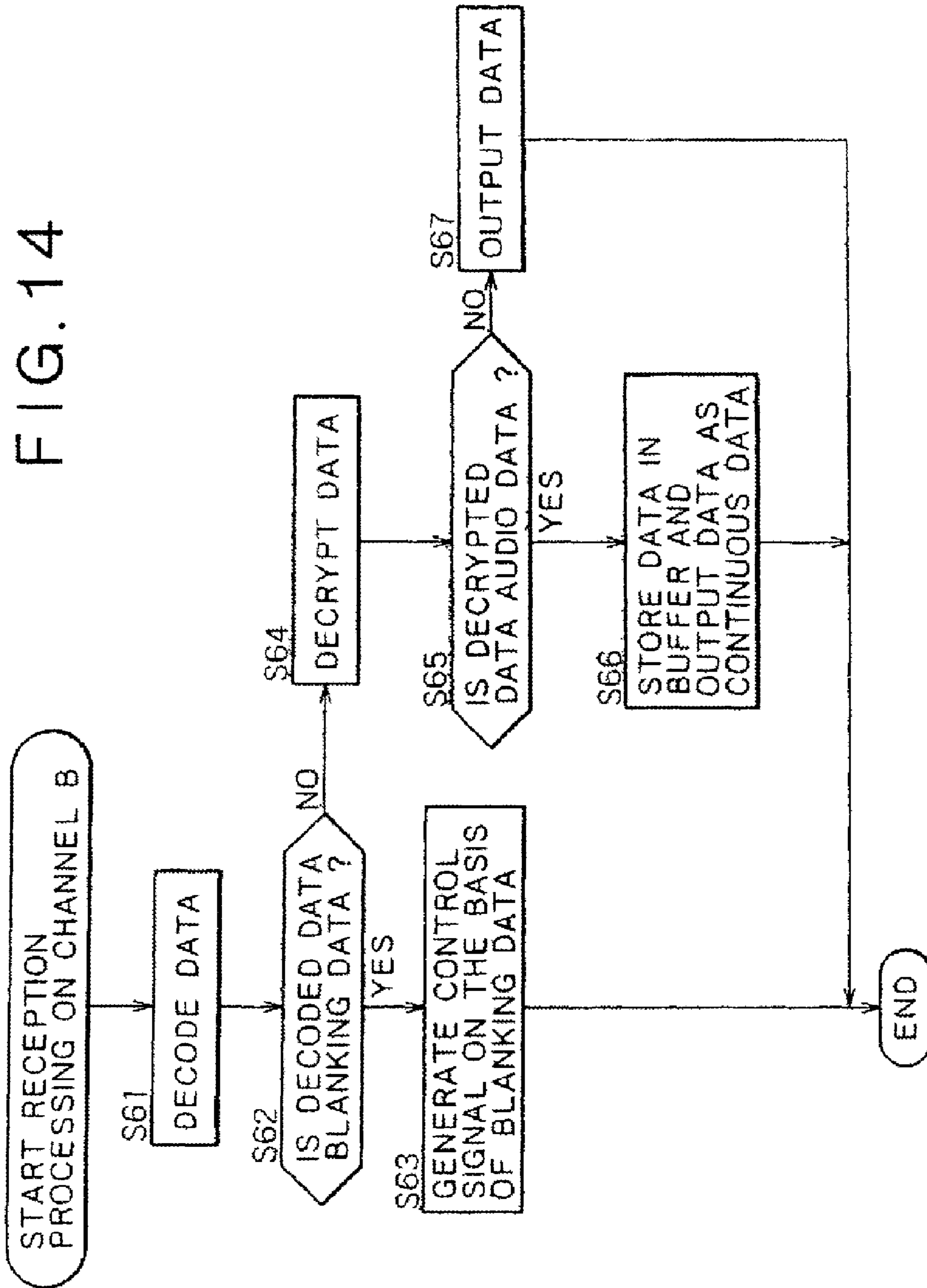
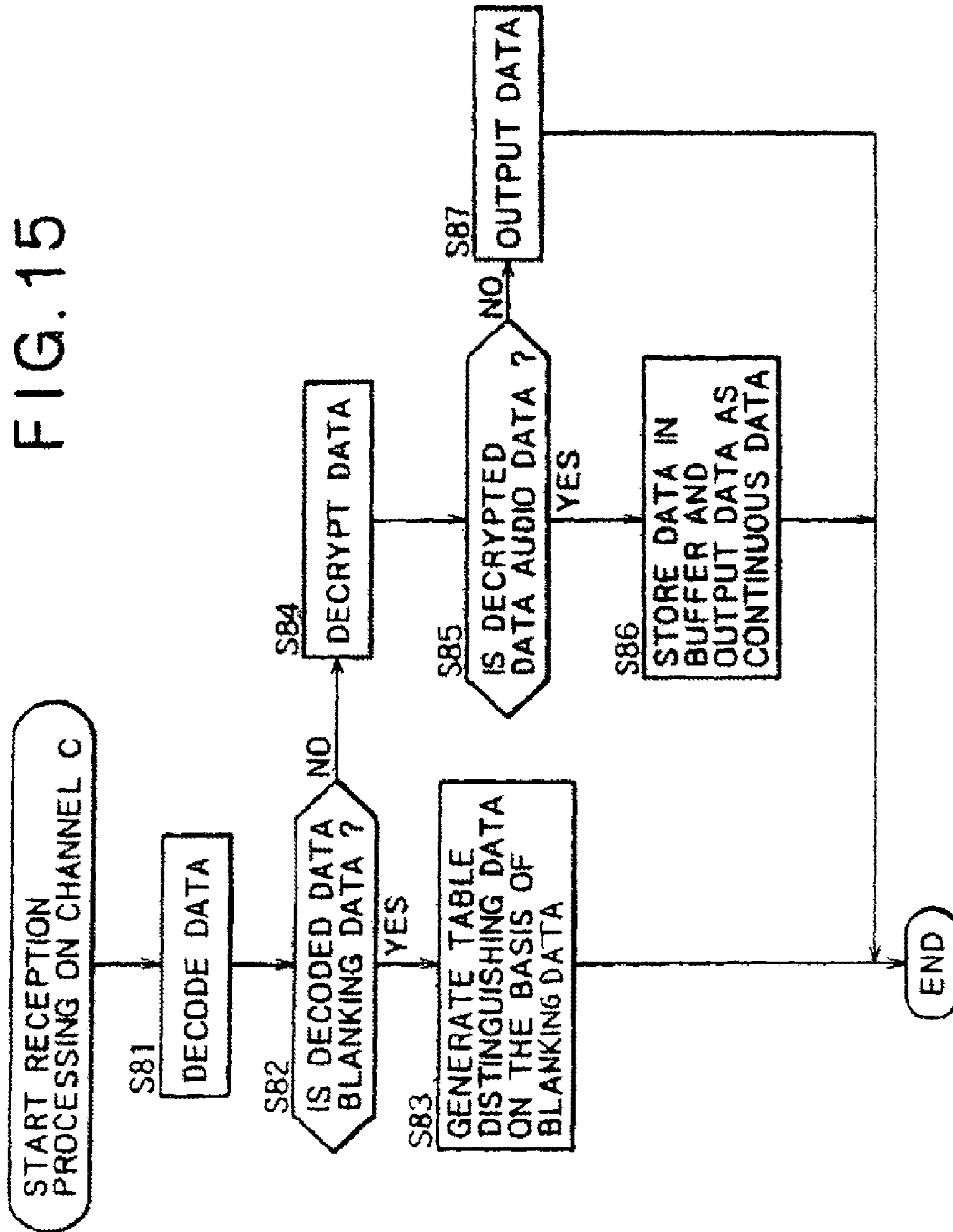

FIG. 15



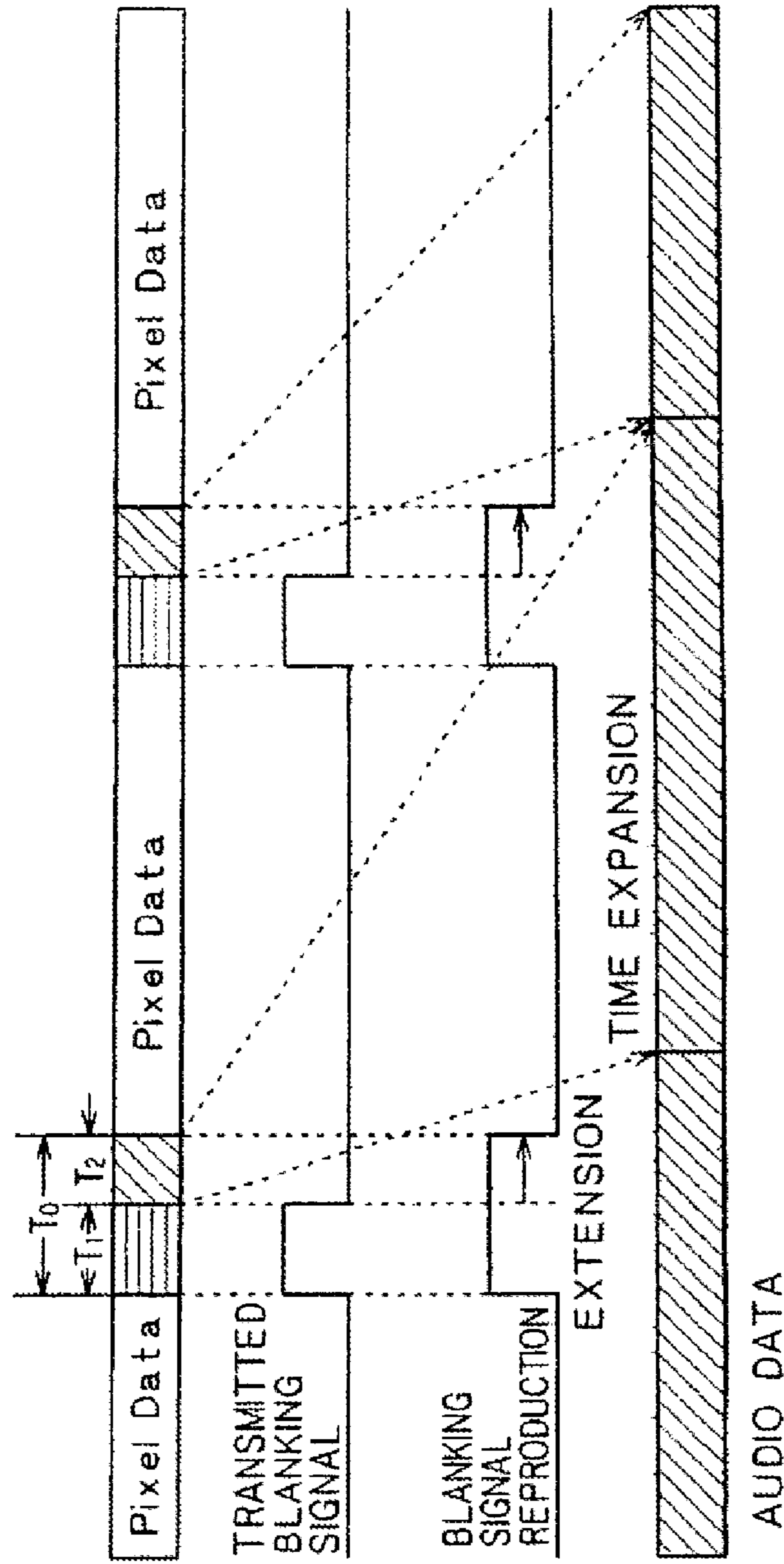

FIG. 16A

FIG. 16B

FIG. 16C

FIG. 16D

FIG. 17

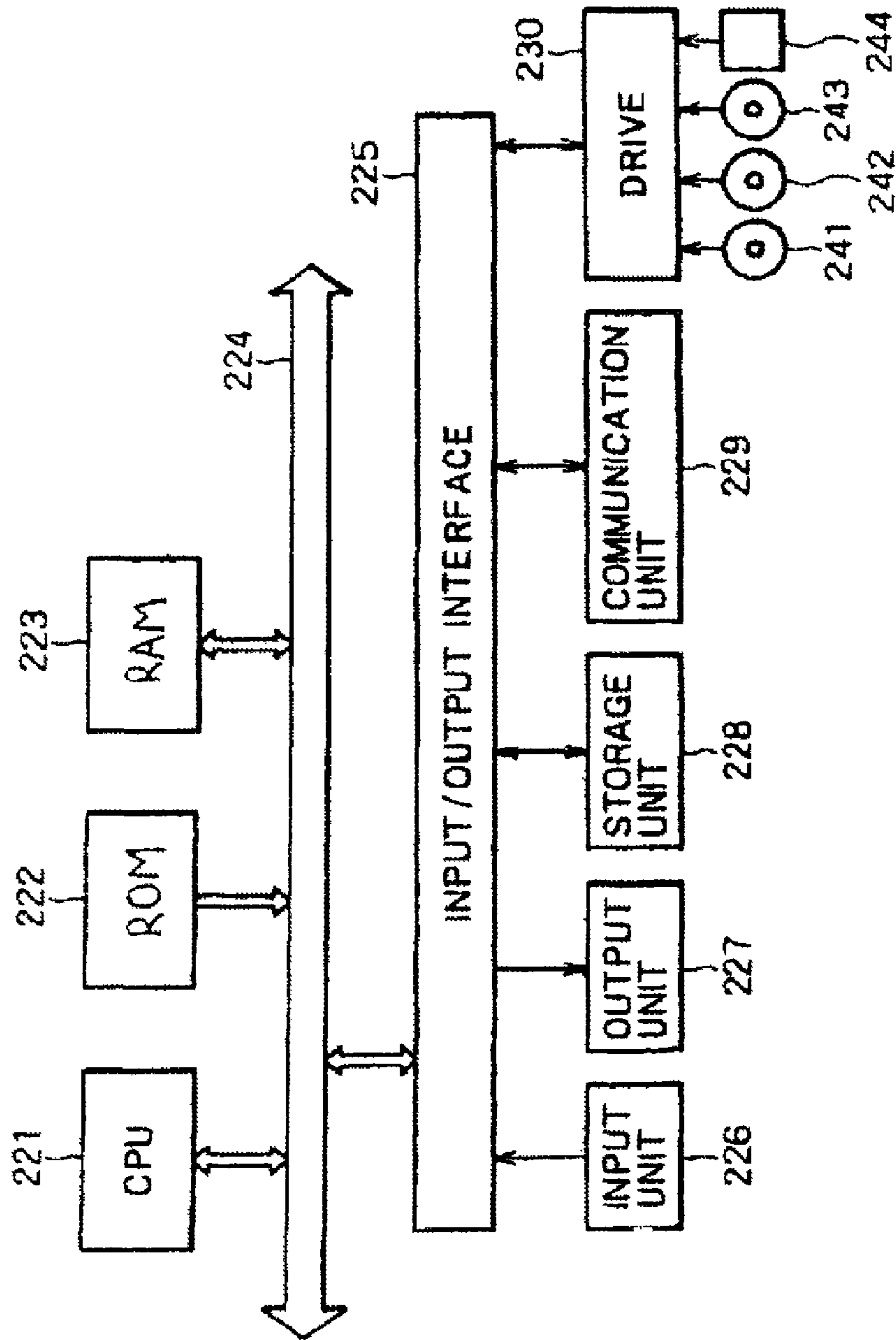

1

**INFORMATION TRANSMITTING
APPARATUS AND METHOD, INFORMATION
RECEIVING APPARATUS AND METHOD,
INFORMATION TRANSMITTING AND
RECEIVING SYSTEM AND METHOD,
RECORDING MEDIUM AND PROGRAM**

Matter enclosed in heavy brackets [] appears in the original patent but forms no part of this reissue specification; matter printed in italics indicates the additions made by reissue; a claim printed with strikethrough indicates that the claim was canceled, disclaimed, or held invalid by a prior post-patent action or proceeding.

NOTICE

This application is an application for reissue of U.S. Pat. No. 8,064,361, and is related to application Ser. No. 13/936,825, filed Jul. 8, 2013, which is a continuation reissue of this application, application Ser. No. 13/936,843, filed Jul. 8, 2013, which is a continuation reissue of this application, and application Ser. No. 13/936,871, filed Jul. 8, 2013, which is a continuation reissue of this application.

**CROSS-REFERENCE TO RELATED
APPLICATIONS**

The present application is a continuation of U.S. patent application Ser. No. 11/724,770, filed Mar. 16, 2007, which is a continuation of U.S. patent application Ser. No. 10/095,848, filed Mar. 12, 2002 and which claims priority from Japanese Application No. 2001-067969 filed Mar. 12, 2001, the disclosures of which are hereby incorporated by reference herein.

BACKGROUND OF THE INVENTION

The present invention relates to an apparatus and a method for transmitting information, an apparatus and a method for receiving information, a system and a method for transmitting and receiving information, a recording medium and a program, and particularly to an apparatus and a method for transmitting information, an apparatus and a method for receiving information, a system and a method for transmitting and receiving information, a recording medium and a program that make it possible to transmit audio data more efficiently by multiplexing the audio data into video data.

A blanking period of video data is often used when the video data has other data superimposed thereon for transmission. In teletext broadcasting, text data is inserted into a vertical blanking period, for example.

Since the blanking period is extremely short as compared with a period for transmitting original video data, however, types of data capable of being multiplexed are limited to low-volume data such as text data.

SUMMARY OF THE INVENTION

The present invention has been made in view of the above, and it is accordingly an object of the present invention to enable efficient transmission of data such as, for example, audio data which is low in volume as compared with video data, but high in volume as compared with text data or the like.

According to a first aspect of the present invention, there is provided an information transmitting apparatus including a first capturing unit operable to capture a video signal; a sec-

2

ond capturing unit operable to capture a compressed audio signal; a setting unit operable to set a blanking period of the video signal to a predetermined period of a length different from an original period; a multiplexing unit operable to multiplex the compressed audio signal into a differential period corresponding to a difference between the blanking period of the video signal and the predetermined period set by the setting unit; and a video signal transmitter operable to transmit the video signal having the compressed audio signal multiplexed therein.

The setting unit may set the blanking period to the predetermined period by disposing a blanking signal representing the blanking period only in the predetermined period other than the differential period of the blanking period of the video signal.

The blanking signal may form a control signal.

The information transmitting apparatus may further include a retaining unit operable to retain information on the differential period or the predetermined period, and the multiplexing unit may multiplex the compressed audio signal into the differential period on the basis of the information retained by the retaining unit.

The retaining unit may retain a correspondence between a type of the video signal and the differential period or the predetermined period as the information on the differential period or the predetermined period.

The information transmitting apparatus may further include a distinguishing information transmitter operable to transmit distinguishing information for distinguishing the differential period or the predetermined period.

The distinguishing information transmitting unit may transmit the distinguishing information in the predetermined period of the video signal as a type of blanking signal representing a blanking period.

The distinguishing information transmitting unit may transmit the distinguishing information in a vertical blanking period.

The distinguishing information transmitting unit may transmit the distinguishing information via a transmission line different from a transmission line of the video signal.

The distinguishing information may be information allowing determination of a period from a start point to an end point of the predetermined period or a period from a start point to an end point of the differential period.

The information transmitting apparatus may further include a compressing unit operable to compress the audio signal.

The information transmitting apparatus may further include an encrypting unit operable to encrypt the audio signal by a method common with the video signal.

According to a second aspect of the present invention, there is provided an information transmitting method, including capturing a video signal; capturing a compressed audio signal; setting a blanking period of the video signal to a predetermined period of a length different from an original period; multiplexing the compressed audio signal into a differential period corresponding to a difference between the blanking period of the video signal and the predetermined period set by the setting step; and transmitting the video signal having the compressed audio signal multiplexed therein.

According to a third aspect of the present invention, there is provided a recording medium recorded with a computer readable program for transmitting information, the program including capturing a video signal; capturing a compressed audio signal; setting a blanking period of the video signal to a predetermined period of a length different from an original period; multiplexing the compressed audio signal into a dif-

3

ferential period corresponding to a difference between the blanking period of the video signal and the predetermined period set by the setting step; and transmitting the video signal having the compressed audio signal multiplexed therein.

According to a fourth aspect of the present invention, there is provided a system for performing an information transmission process, including a processor for executing instructions; and instructions, the instructions including capturing a video signal; capturing a compressed audio signal; setting a blanking period of the video signal to a predetermined period of a length different from an original period; multiplexing the compressed audio signal into a differential period corresponding to a difference between the blanking period of the video signal and the predetermined period set by the setting step; and transmitting the video signal having the compressed audio signal multiplexed therein.

According to a fifth aspect of the present invention, there is provided an information receiving apparatus including a receiver operable to receive a transmitted signal; a first capturing unit operable to capture a video signal from the received signal; a detecting unit operable to detect a blanking period of the captured video signal, the blanking period being set to a length different from an original period; a second capturing unit operable to capture information on a multiplexing period in which a compressed audio signal is multiplexed; a third capturing unit operable to capture the multiplexed compressed audio signal from the captured video signal on the basis of the captured information on the multiplexing period; and a correcting unit operable to correct the detected blanking period on the basis of the captured information on the multiplexing period.

The information receiving apparatus may further include a converting unit operable to convert the compressed audio signal captured by the third capturing unit into a continuous signal.

A blanking signal representing the blanking period may form a control signal.

The information receiving apparatus may further include a retaining unit operable to retain the information on the multiplexing period, and the second capturing unit may capture the information on the multiplexing period from the information retained by the retaining unit.

The retaining unit may retain a correspondence between a type of the video signal and the multiplexing period as the information on the multiplexing period.

The information receiving apparatus may further include a distinguishing information extracting unit operable to extract distinguishing information for distinguishing the multiplexing period.

The distinguishing information extracting unit may extract the distinguishing information from a blanking signal representing the blanking period, the blanking signal being inserted in the blanking period of the video signal.

The distinguishing information extracting unit may extract the distinguishing information from the blanking signal in a vertical blanking period.

The distinguishing information extracting unit may extract the distinguishing information from a signal received via a transmission line different from a transmission line of the video signal.

The distinguishing information may be information allowing determination of a period from a start point to an end point of the multiplexing period or a period from a start point to an end point of the blanking period being set to the length different from the original period.

4

The information receiving apparatus may further include an expanding unit operable to expand the compressed audio signal.

The information receiving apparatus may further include a decrypting unit operable to decrypt the audio signal by a method common with the video signal, the audio signal being encrypted by a method common with the video signal.

According to a sixth aspect of the present invention, there is provided an information receiving method including receiving a transmitted signal; capturing a video signal from the received signal; detecting a blanking period of the captured video signal, the blanking period being set to a length different from an original period; capturing information on a multiplexing period in which a compressed audio signal is multiplexed; capturing the multiplexed compressed audio signal from the captured video signal on the basis of the captured information on the multiplexing period; and correcting the detected blanking period on the basis of the captured information on the multiplexing period.

According to a seventh aspect of the present invention, there is provided a recording medium recorded with a computer readable program for receiving information, the program including receiving a transmitted signal; capturing a video signal from the received signal; detecting a blanking period of the captured video signal, the blanking period being set to a length different from an original period; capturing information on a multiplexing period in which a compressed audio signal is multiplexed; capturing time multiplexed compressed audio signal from the captured video signal on the basis of the captured information on the multiplexing period; and correcting the detected blanking period on the basis of the captured information on the multiplexing period.

According to an eighth aspect of the present invention, there is provided a system for performing information reception, including a processor for executing instructions; and instructions, the instructions including receiving a transmitted signal; capturing a video signal from the received signal; detecting a blanking period of the captured video signal, the blanking period being set to a length different from an original period; capturing information on a multiplexing period in which a compressed audio signal is multiplexed; capturing the multiplexed compressed audio signal from the captured video signal on the basis of the captured information on the multiplexing period; and correcting the detected blanking period on the basis of the captured information on the multiplexing period.

According to a ninth aspect of the present invention, there is provided an information transmitting and receiving system, including an information transmitting apparatus; and an information receiving apparatus; the information transmitting apparatus including a first capturing unit operable to capture a video signal; a second capturing unit operable to capture a compressed audio signal; a setting unit operable to set a blanking period of the video signal to a predetermined period of a length different from an original period; a multiplexing unit operable to multiplex the compressed audio signal into a differential period corresponding to a difference between time blanking period of the video signal and the predetermined period set by the setting unit; and a video signal transmitter operable to transmit the video signal having the compressed audio signal multiplexed therein; and the information receiving apparatus including a receiver operable to receive a signal transmitted from the information transmitting apparatus; a third capturing unit operable to capture the video signal from the received signal; a detecting unit operable to detect the blanking period of the captured video signal, the blanking period being set to the predetermined period; a

5

fourth capturing unit operable to capture information on the differential period; a fifth capturing unit operable to capture the multiplexed compressed audio signal from the captured video signal on the basis of the captured information on the differential period; and a correcting unit operable to correct the detected blanking period on the basis of the captured information on the differential period.

According to a tenth aspect of the present invention, there is provided an information transmitting and receiving method, including capturing a video signal; capturing a compressed audio signal; setting a blanking period of the video signal to a predetermined period of a length different from an original period; multiplexing the compressed audio signal into a differential period corresponding to a difference between the blanking period of the video signal and the predetermined period set by the setting step; transmitting the video signal having the compressed audio signal multiplexed therein; receiving the transmitted signal; capturing the video signal from the received signal; detecting the blanking period of the captured video signal, the blanking period being set to the predetermined period; capturing information on the differential period; capturing the multiplexed compressed audio signal from the captured video signal on the basis of the captured information on the differential period; and correcting the detected blanking period on the basis of the captured information on the differential period.

According to an eleventh aspect of the present invention, there is provided a recording medium recorded with a program for transmitting and receiving information, the program including capturing a video signal; capturing a compressed audio signal; setting a blanking period of the video signal to a predetermined period of a length different from an original period; multiplexing the compressed audio signal into a differential period corresponding to a difference between the blanking period of the video signal and the predetermined period set by the setting step; transmitting the video signal having the compressed audio signal multiplexed therein; receiving the transmitted signal; capturing the video signal from the received signal; detecting the blanking period of the captured video signal, the blanking period being set to the predetermined period; capturing information on the differential period; capturing the multiplexed compressed audio signal from the captured video signal on the basis of the captured information on the differential period; and correcting the detected blanking period on the basis of the captured information on the differential period.

According to a twelfth aspect of the present invention, there is provided a system for performing information transmission and reception processes, including a processor for executing instructions; and instructions, the instructions including capturing a video signal; capturing a compressed audio signal; setting a blanking period of the video signal to a predetermined period of a length different from an original period; multiplexing the compressed audio signal into a differential period corresponding to a difference between the blanking period of the video signal and the predetermined period set by the setting step; transmitting the video signal having the compressed audio signal multiplexed therein; receiving the transmitted signal; capturing the video signal from the received signal; detecting the blanking period of the captured video signal, the blanking period being set to the predetermined period; capturing information on the differential period; capturing the multiplexed compressed audio signal from the captured video signal on the basis of the captured information on the differential period; and correcting the detected blanking period on the basis of the captured information on the differential period.

6

The apparatus and method for information transmission, and the program according to the present invention, multiplex the compressed audio signal into the differential period created by setting the blanking period of the video signal to the predetermined period.

The apparatus and method for information reception, and the program according to the present invention, capture the compressed audio signal superimposed in the multiplexing period of the received video signal, and correct the blanking period on the basis of the multiplexing period.

The system and method for information transmission and reception, and the program according to the present invention, multiplex the compressed audio signal into the differential period of the video signal, and thereby transmit the compressed audio signal from the information transmitting apparatus. The information receiving apparatus captures the compressed audio signal multiplexed in the differential period, and corrects the blanking period on the basis of the differential.

BRIEF DESCRIPTION OF THE DRAWINGS

FIG. 1 is a block diagram showing a configuration of an information transmitting and receiving system to which the present invention is applied;

FIG. 2 is a block diagram showing a configuration of a transmitter in FIG. 1;

FIGS. 3A, 3B, 3C, 3D, 3E, and 3F are diagrams of assistance in explaining signals input to the transmitter of FIG. 2;

FIG. 4 is a block diagram showing a configuration of a receiver in FIG. 1;

FIG. 5 is a flowchart of assistance in explaining transmission processing on a channel A of the transmitter of FIG. 2;

FIG. 6 is a diagram showing an example of blanking data;

FIG. 7 is a flowchart of assistance in explaining transmission processing on a channel B of the transmitter of FIG. 2;

FIG. 8 is a flowchart of assistance in explaining transmission processing on a channel C of the transmitter of FIG. 2;

FIGS. 9A, 9B, 9C, and 9D are tinting charts of assistance in explaining the transmission processing of the transmitter of FIG. 2;

FIGS. 10A, 10B, and 10C are timing charts of assistance in explaining the operation on the channel A of the transmitter of FIG. 2 around a blanking period;

FIGS. 11A, 11B, and 11C are timing charts of assistance in explaining the operation on the channel B of the transmitter of FIG. 2 around a blanking period;

FIGS. 12A, 12B, and 12C are timing charts of assistance in explaining the operation on the channel C of the transmitter of FIG. 2 around a blanking period;

FIG. 13 is a flowchart of assistance in explaining reception processing on a channel A of the receiver of FIG. 4;

FIG. 14 is a flowchart of assistance in explaining reception processing on a channel B of the receiver of FIG. 4;

FIG. 15 is a flowchart of assistance in explaining reception processing on a channel C of the receiver of FIG. 4;

FIGS. 16A, 16B, 16C, and 16D are timing charts of assistance in explaining operation of the receiver of FIG. 4; and

FIG. 17 is a block diagram showing another configuration of the digital tuner of FIG. 2.

DETAILED DESCRIPTION

Preferred embodiments of the present invention will hereinafter be described in detail with reference to the drawings.

FIG. 1 shows an example of a configuration of a transmitting and receiving system to which the present invention is

applied. A digital tuner **31** receives a broadcast radio wave via an antenna **32**, and supplies a demodulated output to a monitor **33** through a TMDS (Transition Minimized Differential Signaling) cord **34** (hereinafter described simply as a TMDS **34**) based on DVI (Digital Video Interface) standards. The digital tuner **31** is also connected to the monitor **33** by a DDC (Display Data Channel) bus **35** (hereinafter described simply as a DDC **35**) based on the DVI standards.

The digital tuner **31** has a front end **41**. The front end **41** demodulates the broadcast wave received via the antenna **32**, and then outputs video data and audio data (hereinafter also referred to as AV data) obtained by demodulating the broadcast wave to an AV decoder **42**. The AV decoder **42** decodes the AV data supplied from the front end **41**, and then outputs the result to a transmitter **43**. The transmitter **43** is controlled by a control unit **44**, and outputs the AV signal supplied from the AV decoder **42** to the monitor **33** via the TMDS **34**.

The monitor **33** incorporates a receiver **51**. The receiver **51** receives the AV data supplied from the transmitter **43** of the digital tuner **31** via the TMDS **34**, and then separates audio data, video data, and synchronizing data.

The audio data output from the receiver **51** is subjected to D/A conversion by a D/A converter **52**, and then output from left-channel and right-channel speakers **53** and **54**.

The video data output from the receiver **51** is subjected to D/A conversion by a D/A converter **55**, amplified by an RGB amplifier **56**, and output to a CRT **58**.

An H/V sync generating unit **57** generates a horizontal synchronizing signal and a vertical synchronizing signal on the basis of the synchronizing data supplied from the receiver **51**, and then supplies the horizontal synchronizing signal and the vertical synchronizing signal to a driving circuit of the CRT **58**.

FIG. 2 shows an example of a configuration of the transmitter **43**. Pixel data A, pixel data B, and pixel data C (for example blue (B), green (G), or red (R) pixel data as shown in FIG. 3A, 3B, or 3C, respectively) for three channels A, B, and C, which data forms the video data output from the AV decoder **42**, are supplied from terminals **80A**, **80B**, and **80C** to the upper input terminals (as viewed in the figure) of switches **81A**, **81B**, and **81C**, respectively. The pixel data of each of the colors (channels) for one pixel is expressed as data of 8 bits.

A terminal **91** is supplied with data of 2 bits forming horizontal synchronizing data and vertical synchronizing data. The 2-bit data is supplied to an encoder **83A**.

A terminal **92** is supplied with data of 2 bits forming a control signal (CTL0, CTL1) as shown in FIG. 3E, for example. The 2-bit data is supplied to an encoder **83B**.

A terminal **93** is supplied with audio data, in this example, as data to be superimposed (multiplexed). The audio data input from the terminal **93** is stored temporarily by a buffer **84**, and then supplied as data in units of 8 bits to the lower input terminal (as viewed in FIG. 2) of the switch **81A**, **81B**, or **81C**.

A terminal **94** is supplied with a blanking signal indicating a blanking period as shown in FIG. 3D. The blanking signal is supplied to a timing generation unit **85**.

A terminal **95** is supplied with a pixel clock of 25 MHz to 165 MHz as shown in FIG. 3F. The pixel clock is supplied to a PLL circuit **87**. The pixel clock is in synchronization with each of the pixels of the channels A, B, and C. The PLL circuit **87** generates a clock of a frequency ten times that of the input pixel clock in synchronization with the pixel clock, and then supplies the generated clock to the timing generating unit **85**. The PLL circuit **87** also outputs a stable pixel clock to the monitor **33**.

The timing generating unit **85** generates a timing signal to control the buffer **84**, the switches **81A**, **81B**, and **81C**, and encrypting units **82A**, **82B**, and **82C** in synchronization with the blanking signal and the pixel clock. The timing generating unit **85** also sets (shortens) the blanking signal to a predetermined length, and supplies the set blanking signal to encoders **83A**, **83B**, and **83C**.

The switches **81A**, **81B**, and **81C** are each turned to the upper input terminal or the lower input terminal in the figure on the basis of the timing signal supplied from the timing generating unit **85** to select the pixel data A to C or the audio data. The switches **81A**, **81B**, and **81C** output the selected pixel data or audio data to their corresponding encrypting units **82A**, **82B**, and **82C**, respectively.

The encrypting units **82A**, **82B**, and **82C** encrypt the video data (pixel data) or the audio data input thereto by a common algorithm, and then output the results to their corresponding encoders **83A**, **83B**, and **83C**.

A superimposing period table **86** prestores data on length of a horizontal blanking period and length of a vertical blanking period corresponding to the pixel data to be output from the encoders **83A** to **83C**.

For example, when pixel data to be encoded and output is 480p (the number represents the number of scanning lines, and p denotes a progressive system), the horizontal blanking period corresponds to a length of 138 pixels. When pixel data to be encoded and output is 720p, the length of the horizontal blanking period corresponds to 370 pixels. When pixel data to be encoded and output is 1080i (i denotes an interlacing system), the length of the horizontal blanking period corresponds to 280 pixels.

That is to say, data for displaying position (length) of a horizontal blanking period and position (length) of a vertical blanking period corresponding to the displaying system are stored in the superimposing period table **86**.

The timing generating unit **85** turns the switches **81A** and **81C** to the lower side thereof (as viewed in the figure) to select audio data for a superimposing period (multiplexing period) stored in the superimposing period table **86**.

During a period when the blanking signal set by the timing generating unit **85** (hereinafter referred to as the set blanking signal) is not supplied, the encoder **83A** encodes the 8-bit pixel data A or audio data supplied from the encrypting unit **82A** on the basis of a predetermined algorithm, and then outputs the result as 10-bit data of the data channel A.

During a period when the set blanking signal is input (hereinafter referred to as a set blanking period), the encoder **83A** encodes (generates) 10-bit blanking data on the basis of the 2-bit horizontal synchronizing signal or vertical synchronizing signal input from the terminal **91**, and then outputs the blanking data as data of the data channel A.

As with the encoder **83A**, during the period other than the set blanking period, the encoder **83B** or **83C** encodes the pixel data or audio data input from the encrypting unit **82B** or **82C**, respectively, and then outputs the result as 10-bit data. During the set blanking period, the encoder **83B** encodes (generates) 10-bit blanking data on the basis of the 2-bit control signal input from the terminal **92**, and the encoder **83C** encodes (generates) 10-bit blanking data on the basis of 2-bit data indicating the superimposing period supplied from the superimposing period table **86**. The output of the encoder **83B** and the output of the encoder **83C** are transmitted to the monitor **33** as an output of the data channel B and an output of the data channel C, respectively.

In addition, the pixel clock generated by the PLL circuit **87** is transmitted to the monitor **33** as data of a clock channel.

FIG. 4 shows a configuration of the receiver 51. Decoders 101A to 101C receive the 10-bit data of the data channels A to C, respectively, decode the 10-bit data, and then output the results as 8-bit data. The decoders 101A to 101C are supplied with a clock of a frequency ten times that of the pixel clock input to the clock channel in synchronization with the pixel clock, which clock of the frequency ten times that of the pixel clock is generated by a PLL circuit 106.

Eight-bit pixel data A or audio data decoded by the decoder 101A is supplied to a decrypting unit 102A. When the 10-bit blanking data is input, the decoder 101A converts the 10-bit blanking data into 2-bit horizontal synchronizing data or vertical synchronizing data, and then supplies the 2-bit horizontal synchronizing data or vertical synchronizing data to the H/V sync generating unit 57.

Eight-bit pixel data B or audio data output by the decoder 101B is supplied to a decrypting unit 102B. When the 10-bit blanking data is input, the decoder 101B converts the 10-bit blanking data into a 2-bit control signal, and then supplies the 2-bit control signal to a control unit 59 of the monitor 33.

Eight-bit pixel data C or audio data output by the decoder 101C is supplied to a decrypting unit 102C. When the 10-bit blanking data is input, the decoder 101C converts the 10-bit blanking data into 2-bit data indicating the superimposing period, and then supplies the 2-bit data to a timing generating unit 103.

The decoders 101A to 101C also output the set blanking signal (Data Enable) indicating the set blanking period to the timing generating unit 103. The timing generating unit 103 extends the set blanking period and thus generates a blanking signal of an original length by referring to a superimposing period table 105 (the same table as the superimposing period table 86 in FIG. 2 is retained), and then outputs the blanking signal to the H/V sync generating unit 57. The timing generating unit 103 is supplied with a stabilized pixel clock (clock of the same frequency as that of the pixel clock input to the terminal 95 of the transmitter 43) generated by the PLL circuit 106 in synchronization with the data of the clock channel. The timing generating unit 103 generates a timing signal on the basis of these pieces of data input thereto, and supplies the timing signal to the decrypting units 102A to 102C and a buffer 104.

The decrypting units 102A to 102C decrypt the 8-bit pixel data A or audio data, the pixel data B or audio data, and the pixel data C or audio data input thereto, respectively, and then output the pixel data to the D/A converter 55.

The 8-bit audio data decrypted by the decrypting units 102A to 102C is supplied to the buffer 104 to be converted into continuous data, and then output to the D/A converter 52.

The blanking signal generated by the timing generating unit 103 is supplied to the H/V sync generating unit 57 in conjunction with the pixel clock of the frequency $1/10$ that of the clock supplied to the decoders 101A to 101C, which pixel clock is generated by the PLL circuit 106 (clock of the same frequency as that of the pixel clock input to the terminal 95 of the transmitter 43 in FIG. 2).

The operation of the transmitting and receiving system will next be described. When the front end 41 of the digital tuner 31 receives a radio wave of a channel specified by a user via the antenna 32, the front end 41 of the digital tuner 31 demodulates the received signal, and then outputs the demodulated signal to the AV decoder 42. The AV decoder 42 decodes the received signal input thereto, and then outputs decoded audio data and video data to the transmitter 43. The transmitter 43 multiplexes the audio data into the horizontal blanking period of the video data input thereto, and then outputs the result to the monitor 33 via the TMDS 34.

The TMDS 34 is essentially an interface for personal computers, and therefore is in a format not allowing transmission of audio data. In this case, however, the audio data is multiplexed into the blanking period of the video data, and therefore the audio data can be transmitted via the TMDS 34.

The receiver 51 on the monitor 33 side receives the video data transmitted via the TMDS 34, separates the audio data inserted in the blanking period, and then outputs the audio data to the D/A converter 52. The D/A converter 52 converts the audio data input thereto into analog audio signals for a left and a right channel to be output from the speakers 53 and 54.

Horizontal synchronizing data and vertical synchronizing data also extracted and generated during the blanking period by the receiver 51 are supplied to the H/V sync generating unit 57. The H/V sync generating unit 57 generates a horizontal synchronizing signal and a vertical synchronizing signal on the basis of the data input thereto, and then outputs the horizontal synchronizing signal and the vertical synchronizing signal to the driving circuit of the CRT 58.

The receiver 51 also outputs pixel data extracted from the data input thereto to the D/A converter 55 to subject the pixel data to D/A conversion. RGB signals output from the D/A converter 55 (signals of the pixel data A to C) are amplified by the RGB amplifier 56, and then supplied to the CRT 58 for display. In this case, the CRT 58 is controlled in the scanning of scanning lines on the basis of the horizontal synchronizing signal and the vertical synchronizing signal generated by the H/V sync generating unit 57.

Transmission processing on the channel A of the transmitter 43 in FIG. 2 will next be described with reference to the flowchart of FIG. 5.

At a step S1, the timing generation unit 85 determines whether the timing generation unit 85 is now in a blanking period on the basis of input from the terminal 94. When the timing generation unit 85 is not in a blanking period, the processing proceeds to a step S2, at which the timing generation unit 85 generates a switch control signal and then outputs the switch control signal to the switch 81A to turn the switch 81A to the upper input terminal (as viewed in FIG. 2). The switch 81A thereby selects the pixel data A input from the terminal 80A (B data of RGB data, for example), and then supplies the pixel data A to the encrypting unit 82A.

At a next step S5, the encrypting unit 82A encrypts the data selected by the switch 81A (pixel data A in this case). At a step S6, the encoder 83A encodes the pixel data A encrypted by the encrypting unit 82A at the step S5, and at a step S8, the encoder 83A outputs the encoded data to the TMDS 34 as data of the data channel A.

When the timing generation unit 85 determines at the step S1 that the timing generation unit 85 is now in a blanking period, on the other hand, the processing proceeds to a step S3. At the step S3, the timing generation unit 85 refers to a table of the superimposing period table 86 to determine whether the timing generation unit 85 is in a period for superimposing (multiplexing) audio data. Specifically, as described above, a period for superimposing audio data (superimposing data) in a horizontal blanking period is predefined in the superimposing period table 86. The timing generation unit 85 determines on the basis of the definition whether the timing generation unit 85 is now in a period for superimposing (multiplexing) audio data.

When the timing generation unit 85 determines that the timing generation unit 85 is in a horizontal blanking period but not in a period for superimposing audio data, the processing proceeds to a step S7. At the step S7, the timing generation unit 85 controls the encoder 83A to generate 10-bit horizontal or vertical blanking data on the basis of 2-bit horizontal or

11

vertical synchronizing data input from the terminal 91 and then output the 10-bit horizontal or vertical blanking data.

When the 2-bit data is denoted by (C1, C0), the encoder 83A outputs 10-bit control (CTL) data provided for the 2-bit data as shown in FIG. 6, for example, as the horizontal or vertical blanking data.

In the example of FIG. 6, when a 2-bit input is '00,' the blanking data is '0010101011.' When the input is '01,' the blanking data is '1101010100.' When the input is '10,' the blanking data is '0010101010.' When the input is '11,' the blanking data is '1101010101.' The 10-bit blanking data is predetermined as blanking data, and is unique data used neither for video data (pixel data) nor for audio data.

Although the processing of the step S7 is basically performed over the entire blanking period, the processing of the step S7 in the present invention is performed only in a period when audio data is not superimposed. This means that the blanking period is set to a length shorter than the original period.

The step S7 is succeeded by a step S8, at which the encoder 83A outputs the blanking data generated at the step S7 via the TMDS 34.

When the timing generation unit 85 determines at the step S3 that the timing generation unit 85 is now in a period for superimposing audio data, on the other hand, the processing proceeds to a step S4. At the step S4, the timing generation unit 85 controls the switch 81A to turn the contact of the switch 81A to the lower side (as viewed in FIG. 2). At this step S4, the switch 81A selects audio data supplied from the buffer 84, and then outputs the audio data to the encrypting unit 82A.

At the step S5, the encrypting unit 82A encrypts the audio data input via the switch 81A, and then outputs the encrypted audio data to the encoder 83A. At the step S6, the encoder 83A encodes the encrypted audio data input from the encrypting unit 82A, and at the step S8, the encoder 83A outputs the encoded data to the TMDS 34. Thus, the video data (pixel data) and the audio data are encrypted by the common encrypting unit 82A. It is therefore possible to simplify the configuration, miniaturize the apparatus, and lower the cost as compared with a case where the video data (pixel data) and the audio data are provided as data separate from each other.

Transmission processing on the channel B will next be described with reference to the flowchart of FIG. 7.

The processing at steps S21 to S28 in FIG. 7 is basically the same as the processing at the steps S1 to S8 in the transmission processing of the channel A shown in FIG. 5. However, the pixel data selected by the switch 81B at the step S22 is pixel data B, and the data encrypted by the encrypting unit 82B at the step S25 is the pixel data B or the audio data supplied from the buffer 84 selected by the switch 81B.

In addition, at the step S27, the encoder 83B generates 10-bit horizontal or vertical blanking data (FIG. 6) on the basis of the 2-bit control signal supplied from the terminal 92.

The other processing is the same as in FIG. 5.

Transmission processing on the channel C is as shown in FIG. 8. Processing at steps S31 to S38 is basically the same as the processing at the steps S1 to S8 in the flowchart of FIG. 5. However, the data selected by the switch 81C at the step S32 and encrypted by the encrypting unit 82C at the step S35 is pixel data C supplied from the terminal 80C or the audio data supplied from the buffer 84. At the step S37, the encoder 83C generates 10-bit horizontal or vertical blanking data (FIG. 6) on the basis of 2-bit data indicating a superimposing period supplied from the superimposing period table 86.

The processing described above will be described further with reference to the timing charts of FIGS. 9A, 9B, 9C, and 9D. As shown in FIG. 9A, a blanking signal is generated in a

12

cycle of a horizontal scanning line. As described above, the period of the horizontal blanking signal corresponds to 138 pixels in the case of 480p pixel data, 370 pixels in the case of 720p pixel data, and 280 pixels in the case of 1080i pixel data.

As shown in FIG. 9B, a first period T_1 of the blanking period T_0 is a transmitting blanking period, and a remaining period T_2 of the blanking period T_0 is a period for multiplexing audio data.

The audio data, which is continuous data as shown in FIG. 9D, is compressed with respect to a time axis by being encoded by the encoders 83A to 83C, and multiplexed into the period T_2 as shown in FIG. 9C.

FIGS. 10A, 10B, and 10C show in enlarged dimension data around a blanking period of the channel A. As shown in FIG. 10B, although the period of an original blanking signal is T_0 , the blanking signal is multiplexed in a manner as shown in FIG. 10A and FIG. 10C only in a period T_1 within the period T_0 . This means that the blanking signal is, as it were, shortened from the period T_0 to the period T_1 . Audio data is multiplexed into a remaining superimposing period T_2 obtained by subtracting the period T_1 from the period T_0 . In other words, audio data is multiplexed as data similar to pixel data. In order to distinguish audio data from pixel data on the receiving part, however, distinguishing data indicating the superimposing period T_2 is transmitted in the period T_1 on the channel C, as described above.

FIGS. 11A, 11B, and 11C show the arrangement of data around a blanking period of the channel B. FIGS. 12A, 12B, and 12C show the arrangement of data around a blanking period of the channel C.

In the period T_1 , horizontal synchronizing data or vertical synchronizing data is transmitted in the example of FIGS. 10A, 10B, and 10C, whereas a control signal is transmitted in the example of FIGS. 11A, 11B, and 11C, and table distinguishing data is transmitted in the example of FIGS. 12A, 12B, and 12C. That is, as described above, blanking data inserted in the period T_1 is data representing the horizontal or vertical synchronizing data (for the channel A), the control signal (for the channel B), or the table distinguishing data (for the channel C).

The receiving processing of the channel A of the receiver 51 in FIG. 4 will next be described with reference to the flowchart of FIG. 13. At a step S41, the decoder 101A decodes data input thereto.

At a step S42, the decoder 101A determines whether the decoded data is blanking data. When the decoder 101A determines that the decoded data is blanking data, the processing proceeds to a step S43, at which the decoder 101A generates horizontal or vertical synchronizing data (generates 2-bit data corresponding to the 10-bit control code in FIG. 6) on the basis of the blanking data, and then outputs the horizontal or vertical synchronizing data to the H/V sync generating unit 57.

The decoder 101A also outputs data of a period corresponding to the blanking data as data of a set blanking period to the timing generating unit 103. As will be described in detail in the processing at a step S83 in FIG. 15, the timing generating unit 103 corrects (lengthens) the set blanking period to thereby generate a blanking signal of original length.

When the decoder 101A determines at the step S42 that the decoded data is not blanking data, the data is either pixel data or audio data. Therefore, the decoder 101A outputs the data to the decrypting unit 102A. At a step S44, the decrypting unit 102A decrypts the data input thereto. The decrypting unit 102A determines whether the decrypted data is audio data on the basis of a timing signal from the timing generating unit

13

103 at a step **S45**. When the decrypting unit **102A** determines that the decrypted data is audio data, the processing proceeds to a step **S46**, at which the audio data is supplied to the buffer **104** to be stored therein.

Specifically, the timing generating unit **103** reads a superimposing period T_2 corresponding to table distinguishing data for distinguishing the superimposing period, which data is output by the decoder **101C**, from the superimposing period table **105** on the basis of the table distinguishing data. The timing generating unit **103** then outputs a timing signal corresponding to the period T_2 . The decrypting unit **102A** determines that data in the period T_2 is audio data.

The buffer **104** is also supplied with audio data decrypted by the decrypting unit **102B** or **102C** of the channel B or the channel C. The buffer **104** outputs these pieces of audio data as continuous data.

When the decrypting unit **102A** determines at the step **S45** that the decrypted data is not audio data (when the decrypting unit **102A** determines that the decrypted data is pixel data A), on the other hand, the processing proceeds to a step **S47**, at which the decrypting unit **102A** outputs the data to the D/A converter **55**.

FIG. **14** shows the receiving processing of the channel B. The processing at steps **S61** to **S67** is basically the same as shown in the flowchart of FIG. **13**. However, at the step **S63**, the decoder **101B** generates a control signal rather than horizontal synchronizing data or vertical synchronizing data on the basis of blanking data. The control signal is output to the control unit **59**.

The flowchart of FIG. **15** shows the receiving process of the channel C of the receiver **51**. The processing at steps **S81** to **S87** in FIG. **15** is basically the same as the processing at the steps **S41** to **S48** in FIG. **13**. However, the processing at the step **S83** in FIG. **15** is different from the processing at the step **S43** in FIG. **13**. Specifically, at the step **S83** in FIG. **15**, the decoder **101C** generates 2-bit table distinguishing data on the basis of 10-bit blanking data. The table distinguishing data, which allows the superimposing period T_2 to be identified, is supplied to the timing generating unit **103**.

The timing generating unit **103** reads from the superimposing period table **105** the superimposing period T_2 corresponding to the table distinguishing data supplied from the decoder **101C** and then sets the period T_2 in an internal memory. The timing generating unit **103** generates a timing signal for separating audio data from pixel data by using the superimposing period T_2 until new table distinguishing data is received in a next vertical blanking period.

In addition, the timing generating unit **103** lengthens (corrects) the set blanking period T_1 by the period T_2 on the basis of the set blanking data supplied from the decoders **101A** to **101C** and the set superimposing period T_2 . The timing generating unit **103** generates a blanking signal corresponding to the blanking period T_0 of original length, and then outputs the blanking signal to the H/V sync generating unit **57**.

The receiving processing described above will be described further with reference to the timing charts of FIGS. **16A**, **16B**, **16C**, and **16D**. As shown in FIG. **16A**, blanking data is transmitted in a state of being inserted in only the period T_1 of the blanking period T_0 . This means that the blanking period T_0 is transmitted in a state of being shortened to the set blanking period T_1 , as shown in FIG. **16B**. If the blanking period T_0 remains in this state, audio data inserted in the period T_2 is processed as pixel data. Thus, as shown in FIG. **16C**, the timing generating unit **103** lengthens (corrects) the set blanking period T_1 by the period T_2 to thereby generate

14

a correct blanking period, or the period T_0 of original length, and then outputs the blanking period to the H/V sync generating unit **57**.

As shown in FIG. **16D**, the buffer **104** converts divided audio data supplied from the decrypting units **102A** to **102C** into continuous audio data, and then outputs the continuous audio data to the D/A converter **52**.

The processing of inserting table distinguishing data into the period T_1 as shown in FIGS. **12A**, **12B**, and **12C** needs to be performed in every horizontal blanking period when the value of the superimposing period T_2 is changed for each horizontal scanning line. Usually, however, the superimposing period T_2 is not changed frequently. In such a case, table distinguishing data may be multiplexed into only a vertical blanking period.

In the embodiment of FIG. **1**, the transmitter **43** of the digital tuner **31** on the transmitting side and the receiver **51** of the monitor **33** on the receiving side retain the superimposing period table **86** and the superimposing period table **105**, respectively, and table distinguishing data for indicating which of the tables retained in the superimposing period table **86** and the superimposing period table **105** is to be used is inserted in the blanking period T_1 of the channel C. However, the table distinguishing data may be transmitted from the digital tuner **31** side to the monitor **33** side via the DDC **35**, for example, forming a transmission line separate from the TMDS **34**.

The series of processing steps described above may be carried out not only by hardware but also by software. In such a case, the digital tuner **31** is formed as shown in FIG. **17**, for example.

A CPU (Central Processing Unit) **221** in FIG. **17** performs various processing according to programs stored in a ROM (Read Only Memory) **222** or programs loaded from a storage unit **228** into a RAM (Random Access Memory) **223**. The RAM **223** also stores signals and the like necessary for the CPU **221** to perform various processing, as required.

The CPU **221**, the ROM **222**, and the RAM **223** are connected to each other via a bus **224**. The bus **224** is also connected with an input/output interface **225**.

The input/output interface **225** is connected with an input unit **226** formed by a keyboard, a mouse and the like, an output unit **227** formed by a display formed by a CRT, an LCD or the like and a speaker or the like, the storage unit **228** formed by a hard disk or the like, and a communication unit **229** formed by a modem, a terminal adapter or the like. The communication unit **229** performs processing for communication via a network.

When necessary, the input/output interface **225** is also connected with a drive **230** to which a magnetic disk **241**, an optical disk **242**, a magneto-optical disk **243**, a semiconductor memory **244** or the like is inserted as required. Computer programs read from the magnetic disk **241**, the optical disk **242**, the magneto-optical disk **243**, the semiconductor memory **244** and the like are installed in the storage unit **228** as required.

Though not shown in the figure, when the series of processing steps is to be carried out by software, the receiver **51** and the like may also be formed by a computer as with the digital tuner **31**. When the series of processing steps is to be carried out by software, a program forming the software is installed from a network or a recording medium onto a computer that is incorporated in special hardware, or a general-purpose personal computer that can perform various functions by installing various programs thereon, for example.

Examples of the recording medium include not only program-recorded packaged media distributed to users to pro-

vide the program separately from the apparatus proper, which packaged media are formed by magnetic disks **241** (including floppy disks), optical disks **242** (including CD-ROM (Compact Disk-Read Only Memory) and DVD (Digital Versatile Disk)), magneto-optical disks **243** (including MD (Mini-Disk)), or semiconductor memories **244** as shown in FIG. 17, but also the hard disk included in the storage unit **228** and the ROM **222** storing the program, which are supplied to the user in a state of being preincorporated in the apparatus proper.

It is to be noted that in the present specification, the steps describing the program recorded on a recording medium include not only processing steps carried out in time series in the described order, but also processing steps carried out in parallel or individually and not necessarily in time series.

Also, in the present specification, a system denotes the whole apparatus formed by a plurality of apparatus.

As described above, the apparatus and method for information transmission, and the program according to the present invention multiplex a compressed audio signal into a differential period created by setting a blanking period to a predetermined period. It is therefore possible to transmit an audio signal efficiently.

The apparatus and method for information reception, and the program according to the present invention capture the compressed audio signal multiplexed in the multiplexing period of a captured video signal, and correct the blanking period on the basis of the multiplexing period. It is therefore possible to reliably extract the compressed audio signal, recover the length of the original blanking period readily and reliably, and thereby prevent adverse effects on reproduction of the video signal.

According to the system and method for information transmission and reception, and the program according to the present invention, the information transmitting apparatus multiplexes a compressed audio signal into a differential period created by setting a blanking period of a video signal to a predetermined period, and thereby transmits the compressed audio signal, and the information receiving apparatus captures the compressed audio signal multiplexed in the differential period, and corrects the blanking period. Therefore, it is possible to transmit and receive the compressed audio signal other than the video signal readily and reliably in a system capable of transmitting and receiving a video signal, and thus realize a system having no adverse effects on transmission and reception of an original video signal.

Although the invention herein has been described with reference to particular embodiments, it is to be understood that these embodiments are merely illustrative of the principles and applications of the present invention. It is therefore to be understood that numerous modifications may be made to the illustrative embodiments and that other arrangements may be devised without departing from the spirit and scope of the present invention as defined by the appended claims.

The invention claimed is:

1. A data transmission apparatus comprising a processor to implement:
 - a first input unit for inputting video data of a predetermined number of bits;
 - a second input unit for inputting audio data;
 - a setting unit for setting, within a blanking period of the video data, a setup period that is shorter than the blanking period;
 - a multiplexing unit for multiplexing the audio data into a superimposing period, the superimposing period occurring within the blanking period and not including the setup period, and the setup period at least preceding the superimposing period;

a video data transmitting unit for encoding the video data to generate encoded video data having a number of bits greater than the predetermined number of bits and transmitting the encoded video data to a data channel; and

a retaining unit for retaining information on the setup period or the superimposing period, wherein the retaining unit retains a correspondence between a type of the video data and the setup period or superimposing period as the information on the setup period or superimposing period, and wherein the multiplexing unit multiplexes the audio data into the superimposing period on the basis of the information retained by the retaining unit,

the setup period being used to convey predetermined data other than video data or audio data; and

the predetermined data comprising information for identifying the encoded video data and the superimposing period.

2. A data transmission apparatus as claimed in claim 1, wherein the setting unit sets the setup period by disposing a blanking signal representing the blanking period only during the setup period and not during the superimposing period.

3. A data transmission apparatus as claimed in claim 2, wherein the blanking signal forms a control signal.

4. A data transmission apparatus as claimed in claim 1, further comprising a distinguishing information transmitter for transmitting distinguishing information for distinguishing the setup period or the superimposing period.

5. A data transmission apparatus as claimed in claim 4, wherein the distinguishing information transmitter transmits at the distinguishing information in the setup period of the video data as a type of blanking signal representing a blanking period.

6. A data transmission apparatus as claimed in claim 5, wherein the distinguishing information transmitter transmits the distinguishing information its a vertical blanking period.

7. A data transmission apparatus as claimed in claim 4, wherein the distinguishing information transmitter transmits the distinguishing information via a transmission line different from a transmission line of the encoded video data.

8. A data transmission apparatus as claimed in claim 4, wherein the distinguishing information is information allowing determination of a period from a start point to an end point of the setup period or a period from a start point to an end point of the superimposing period.

9. A data transmission apparatus as claimed in claim 1, further comprising a compressing unit for compressing the audio data.

10. A data transmission apparatus as claimed in claim 1, further comprising an encrypting unit for encrypting the audio data by a method common with the video data.

11. An information receiving apparatus comprising

- a processor to implement:
- a receiver for receiving a transmitted signal;
 - a first capturing unit for capturing video data from the received signal;
 - a detecting unit for detecting a blanking period of the captured video data, the blanking period being set to a duration different from the duration of an original blanking period of the video data;
 - a second capturing unit for capturing information on a superimposing period of the received signal in which audio data is multiplexed, the superimposing period occurring within the original blanking period and not including the blanking period of the captured video

17

data, and the blanking period of the captured video data at least preceding the superimposing period;
 a third capturing unit for capturing the audio data from the received signal on the basis of the captured information and superimposing period;
 a correcting unit for correcting the detected blanking period on the basis of the captured information on the superimposing period; and
 a retaining unit for retaining the information on the superimposing period, wherein the retaining unit retains a correspondence between a type of the video data and the superimposing period as the information on the superimposing period, and wherein the second capturing unit captures the information on the superimposing period from the information retained by the retaining unit,
 data indicative of the duration of the superimposing period being received during the blanking period of the captured video data.

12. An information receiving apparatus as claimed in claim 11, further comprising a converting unit for converting the audio data captured by the third capturing unit into a continuous signal.

13. An information receiving apparatus as claimed in claim 11, wherein a blanking signal representing the blanking period of the captured video data forms a control signal.

14. An information receiving apparatus as claimed in claim 11, further comprising a distinguishing information extracting unit for extracting distinguishing information for distinguishing the superimposing period.

15. An information receiving apparatus as claimed in claim 14, wherein the distinguishing information extracting unit extracts the distinguishing information from a blanking signal representing the blanking period of the captured video data, the blanking signal being inserted in the blanking period of the captured video data.

16. An information receiving apparatus as claimed in claim 15, wherein the distinguishing information extracting unit extracts the distinguishing information from the blanking signal in a vertical blanking period.

17. An information receiving apparatus as claimed in claim 14, wherein the distinguishing information extracting unit extracts the distinguishing information from a signal received via a transmission line different from a transmission line of the captured video data.

18. An information receiving apparatus as claimed in claim 14, wherein the distinguishing information is information allowing determination of a period from a start point to an end point of the superimposing period or a period from a start point to an end point of the blanking period of the captured video data.

19. An information receiving apparatus as claimed in claim 11, wherein the audio data is compressed audio data, and further comprising an expanding unit for expanding the compressed audio data.

20. An information receiving apparatus as claimed in claim 11, further comprising a decrypting unit for decrypting the audio data by a method common with the video data, the audio data being encrypted by a method common with the video data.

21. An information processing apparatus, comprising:
 a display that displays images corresponding to a video signal, the video signal being related to an audio signal, and the audio signal defining a compressed audio signal;

18

a setting unit that sets a predetermined period in a blanking period of the video signal, the duration of the predetermined period being shorter than the duration of the blanking period;

a multiplexing unit that multiplexes the compressed audio signal into a differential period corresponding to a difference between the blanking period and the predetermined period; and

a transmitter that transmits an audio/video (AV) signal which includes the video signal, the compressed audio signal, and distinguishing data for distinguishing the differential period,

wherein the transmitter transmits the AV signal via transition minimized differential signaling (TMDS).

22. The information processing apparatus according to claim 21, wherein the setting unit sets the predetermined period by disposing, only in the predetermined period, a blanking signal.

23. An information processing method, comprising:
 displaying images corresponding to a video signal, the video signal being related to an audio signal, and the audio signal defining a compressed audio signal;

setting a predetermined period in a blanking period of the video signal, the duration of the predetermined period being shorter than the duration of the blanking period; multiplexing the compressed audio signal into a differential period corresponding to a difference between the blanking period and the predetermined period; and

transmitting an audio/video (AV) signal which includes the video signal, the compressed audio signal, and distinguishing data for distinguishing the differential period, wherein the step of transmitting comprises transmitting the AV signal via transition minimized differential signaling (TMDS).

24. The information processing method according to claim 23, wherein the step of setting the predetermined period comprises disposing, only in the predetermined period, a blanking signal.

25. A processor for an apparatus comprising a display, wherein, the processor controls the apparatus to:

display images corresponding to a video signal, the video signal being related to an audio signal, and the audio signal defining a compressed audio signal,

wherein when the apparatus transmits the video signal and the compressed audio signal to another apparatus, the processor further controls the apparatus to

set a predetermined period in a blanking period of the video signal, the duration of the predetermined period being shorter than the duration of the blanking period, multiplex the compressed audio signal into a differential period corresponding to a difference between the blanking period and the predetermined period, and

transmit an audio/video (AV) signal which includes the video signal, the compressed audio signal, and distinguishing data for distinguishing the differential period, wherein the AV signal is transmitted via transition minimized differential signaling (TMDS).

26. The processor according to claim 25, wherein the predetermined period is set by disposing, only in the predetermined period, a blanking signal.

27. An information processing apparatus, comprising a processor to implement:

displaying images corresponding to a video signal, the video signal being related to an audio signal, and the audio signal defining a compressed audio signal;

setting a predetermined period in a blanking period of the
video signal, the duration of the predetermined period
being shorter than the duration of the blanking period;
multiplexing the compressed audio signal into a differen- 5
tial period corresponding to a difference between the
blanking period and the predetermined period; and
transmitting an audio/video (AV) signal which includes the
video signal, the compressed audio signal, and distin-
guishing data for distinguishing the differential period,
wherein the A/V signal is transmitted via transition mini- 10
mized differential signaling (TMDS).

28. The information processing apparatus according to
claim 27, wherein setting the predetermined period com-
prises disposing, only in the predetermined, a blanking sig-
nal. 15

* * * * *