

US00RE45428E

(19) **United States**
(12) **Reissued Patent**
Kroll

(10) **Patent Number:** **US RE45,428 E**
(45) **Date of Reissued Patent:** **Mar. 24, 2015**

(54) **CROSS-SHAPED DISPLAY STAND**
(71) Applicant: **William F. Kroll**, Boca Raton, FL (US)
(72) Inventor: **William F. Kroll**, Boca Raton, FL (US)
(21) Appl. No.: **29/463,818**
(22) Filed: **Mar. 12, 2014**

D578,275 S * 10/2008 Shantz et al. D99/17
D618,135 S * 6/2010 Horst D11/157
D619,926 S * 7/2010 Letney D11/157
D649,594 S * 11/2011 Yi et al. D20/15
D654,828 S 2/2012 Piric
D685,675 S 7/2013 Dubow

* cited by examiner

Primary Examiner — Phillip S Hyder
(74) *Attorney, Agent, or Firm* — Mark D. Bowen; Malin Haley DiMaggio & Bowen, P.A.

Related U.S. Patent Documents

Reissue of:

(64) Patent No.: **Des. 659,431**
Issued: **May 15, 2012**
Appl. No.: **29/400,195**
Filed: **Aug. 24, 2011**

(57) **CLAIM**
The ornamental design for a cross-shaped display stand, as shown and described.

(51) **LOC (10) Cl.** **06-04**
(52) **U.S. Cl.**
USPC **D6/674; D6/300**
(58) **Field of Classification Search**
USPC D6/300–314; D20/15; D11/157, 125,
D11/122; D99/5, 23, 27; D26/4, 94;
211/85.6, 441.1, 442.2, 450, 451, 454,
211/455, 456, 133, 121, 152, 174, 176.1
See application file for complete search history.

DESCRIPTION

FIG. 1 is a front perspective view of a cross-shaped display stand in accordance with the present invention; FIG. 2 is a rear perspective view thereof; FIG. 3 is a bottom perspective view thereof; FIG. 4 is a front *elevation* view thereof; FIG. 5 is a rear *elevation* view thereof; FIG. 6 is a side *elevation* view thereof; FIG. 7 is a top *plan* view thereof; [and] FIG. 8 is a bottom *plan* view thereof[.]; FIG. 9 is a front perspective view of a cross-shaped display stand in accordance with the present invention; FIG. 10 is a rear perspective view thereof; FIG. 11 is a bottom perspective view thereof; FIG. 12 is a front *elevation* view thereof; FIG. 13 is a rear *elevation* view thereof; FIG. 14 is a side *elevation* view thereof; FIG. 15 is a top *plan* view thereof; and, FIG. 16 is a bottom *plan* view thereof. The dot-dash broken lines in FIGS. 8 through 16 represent the boundaries between claimed and non-claimed subject matter.

(56) **References Cited**

U.S. PATENT DOCUMENTS

D67,289 S * 5/1925 Ladewich D99/23
D103,027 S * 2/1937 Slattery D99/27
D137,421 S * 3/1944 Rasmussen D99/23
D159,891 S * 8/1950 Chevalier D99/27
D160,900 S * 11/1950 Suhren D6/450
D168,686 S * 1/1953 Hunter D6/450
D256,398 S 8/1980 Mitchell
D338,081 S * 8/1993 Klaffer D26/94
D338,315 S 8/1993 Larson
D370,282 S * 5/1996 Grether D26/4
D408,653 S * 4/1999 Dotson et al. D6/450
D412,461 S * 8/1999 McGrew D11/122
D431,206 S * 9/2000 Byers D11/125
D440,734 S * 4/2001 Berry D99/23
D443,970 S * 6/2001 Stucker D99/27
D481,223 S * 10/2003 Locker et al. D6/470
D518,939 S * 4/2006 Borgerding D99/5

1 Claim, 12 Drawing Sheets

Matter enclosed in heavy brackets [] appears in the original patent but forms no part of this reissue; matter printed in italics indicates the additions made by reissue.

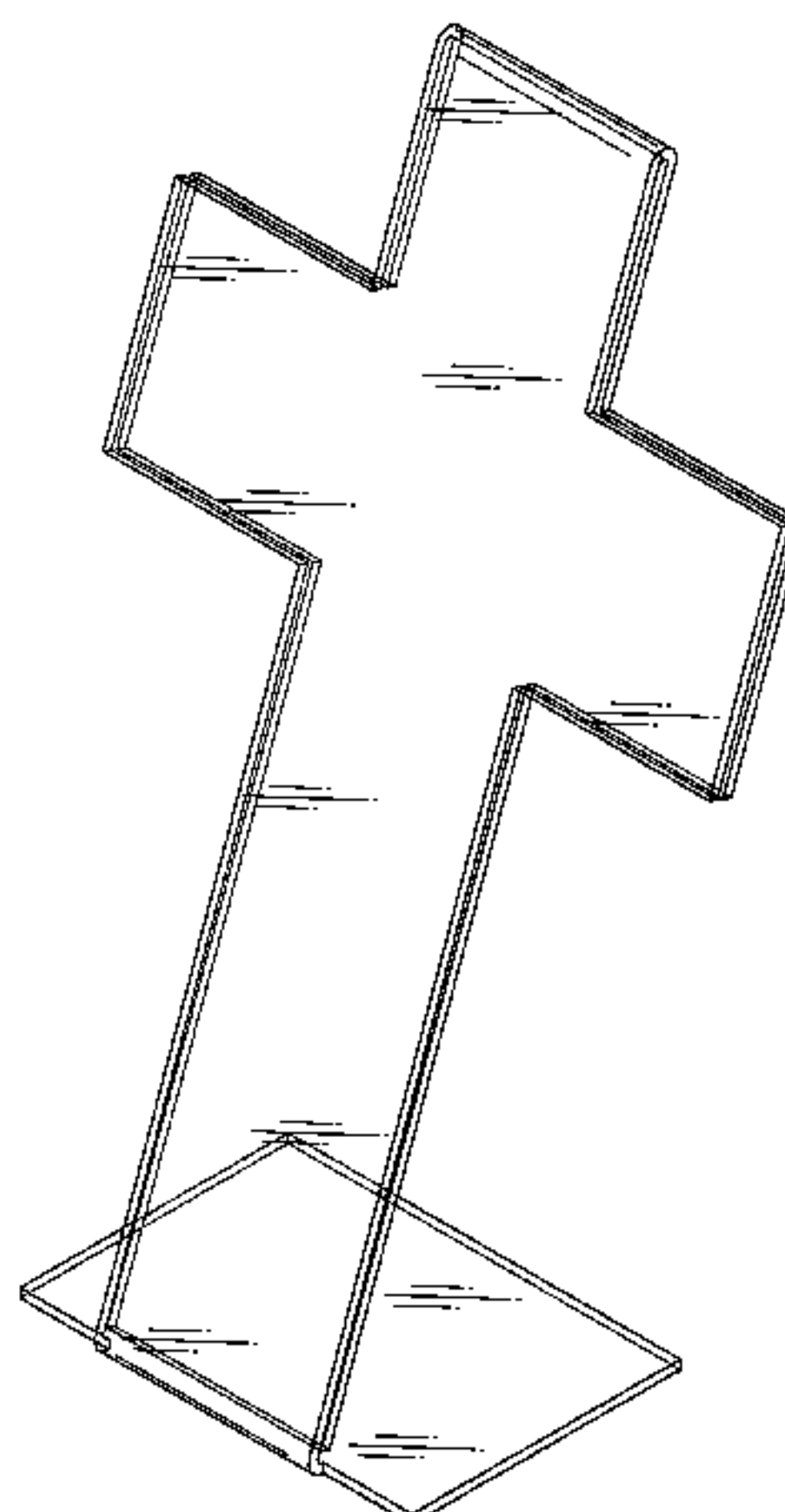

(AMENDED)

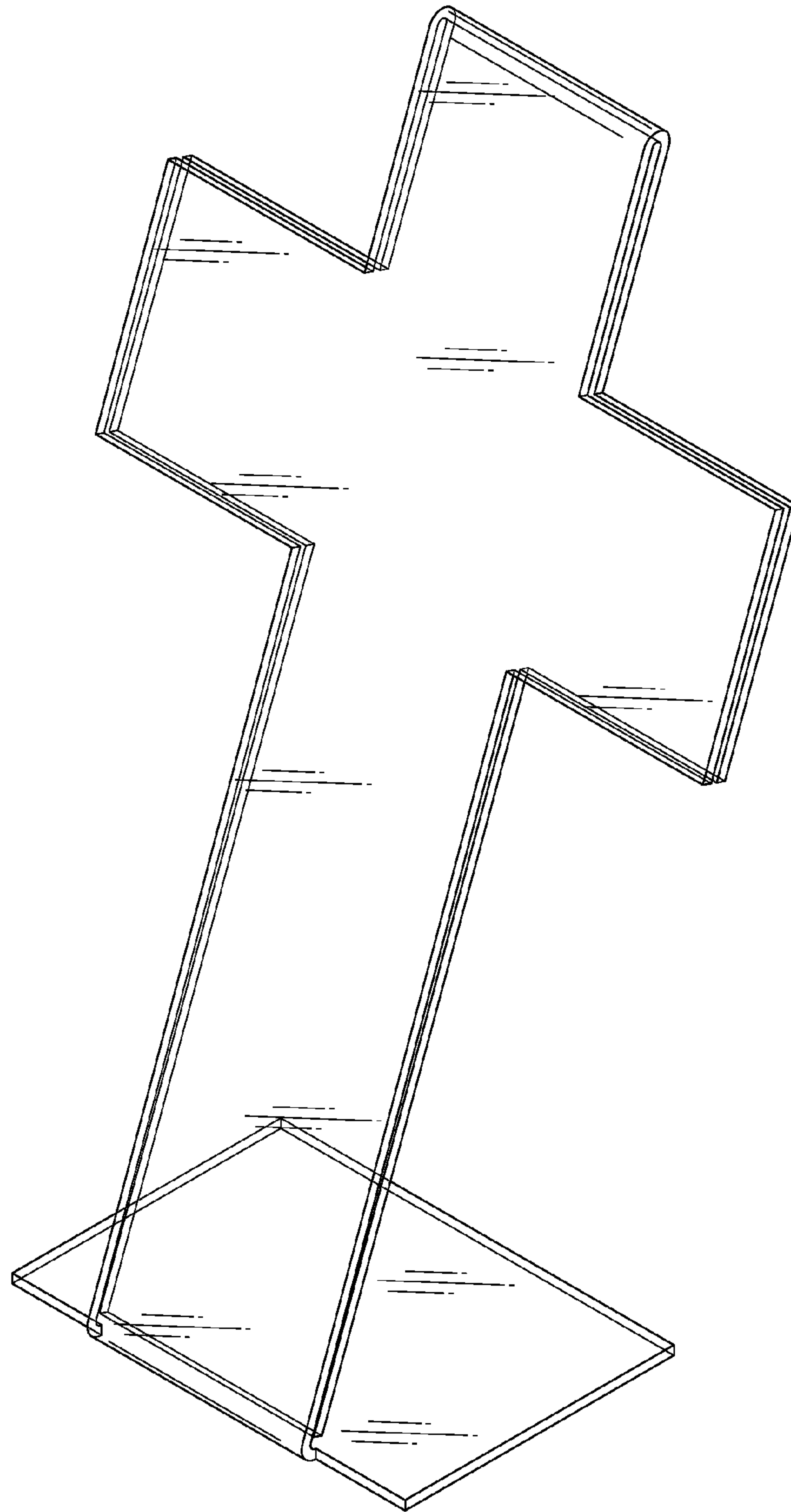

FIG. 1
(AMENDED)

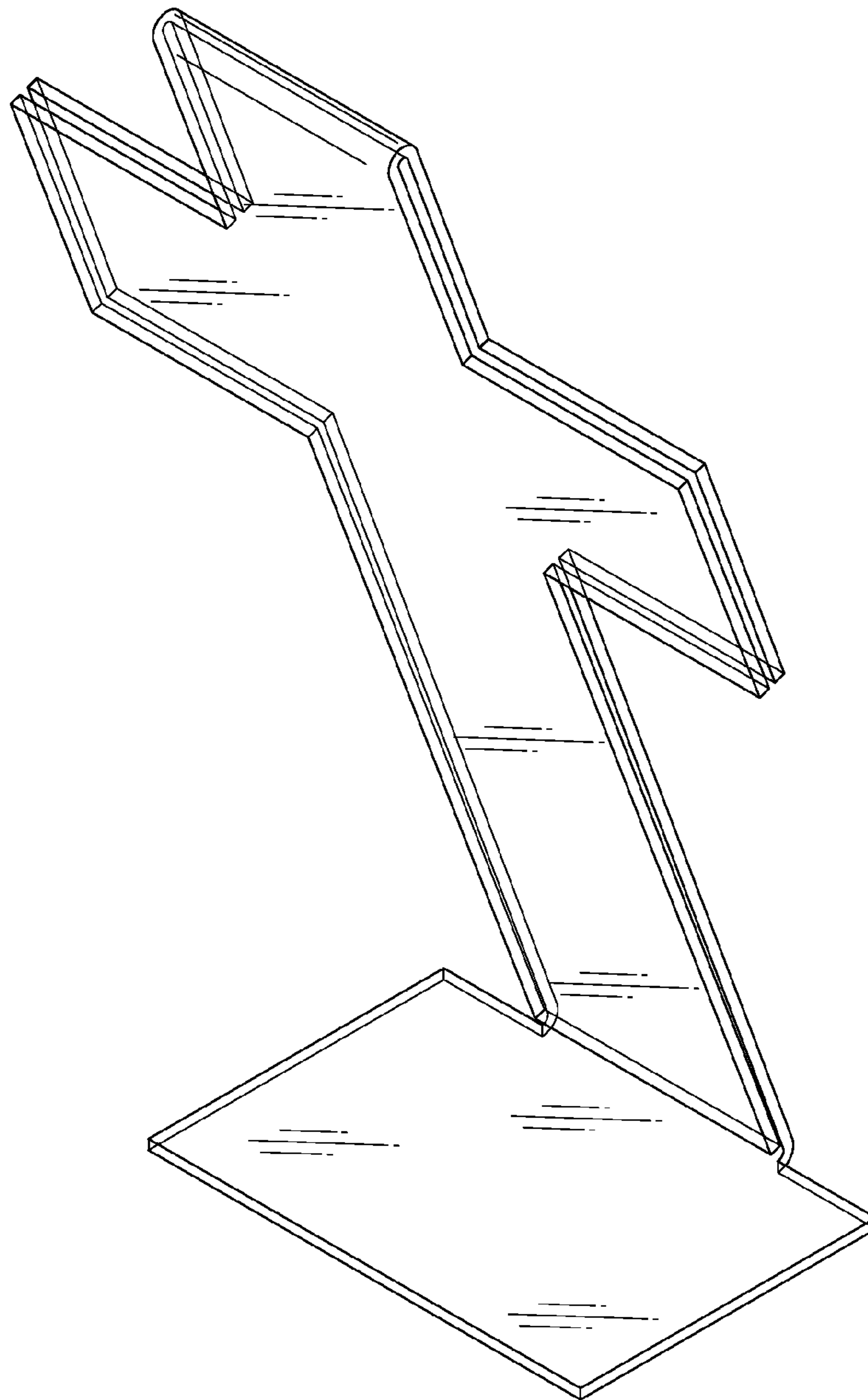

FIG. 2
(AMENDED)

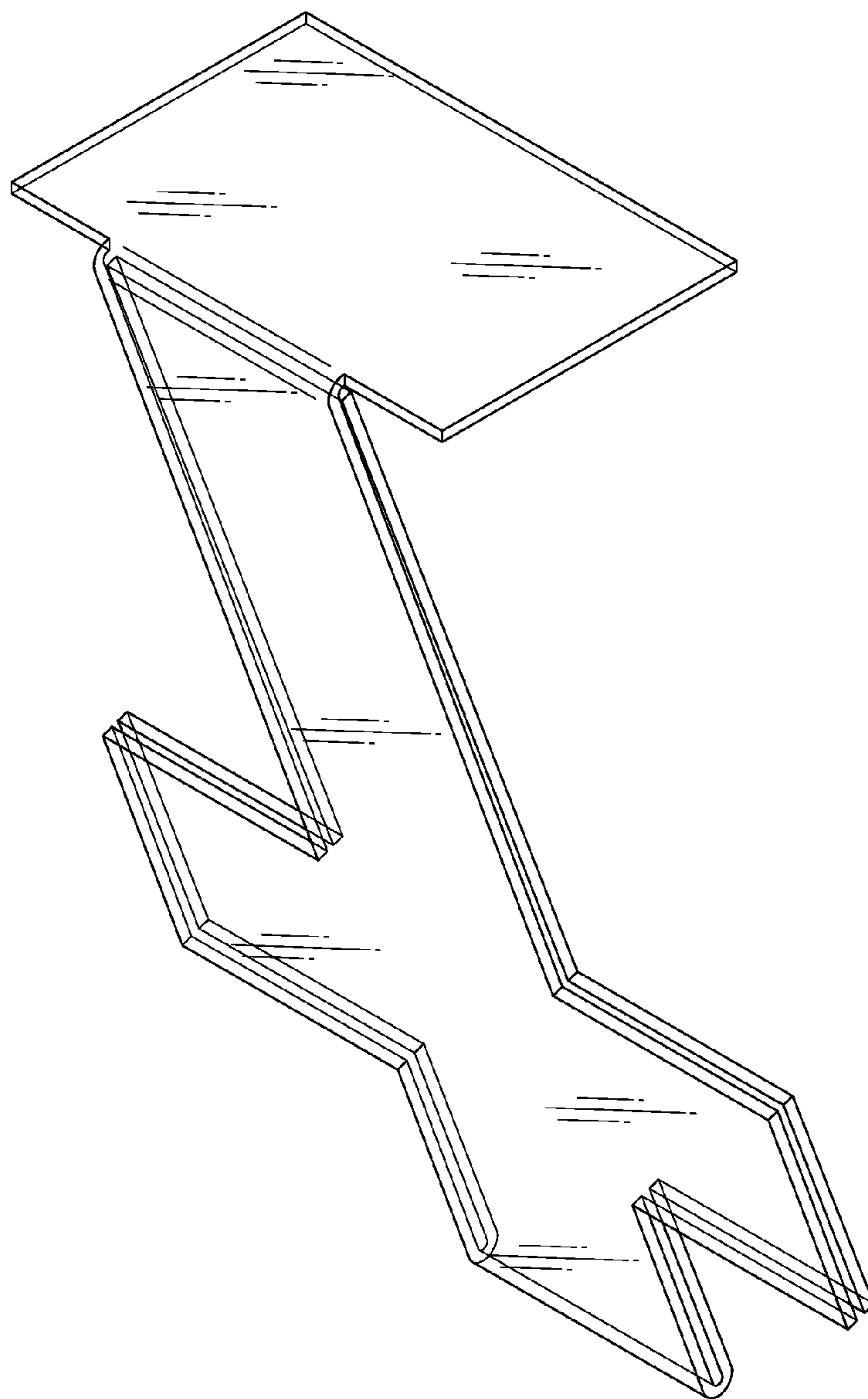

FIG. 3
(AMENDED)

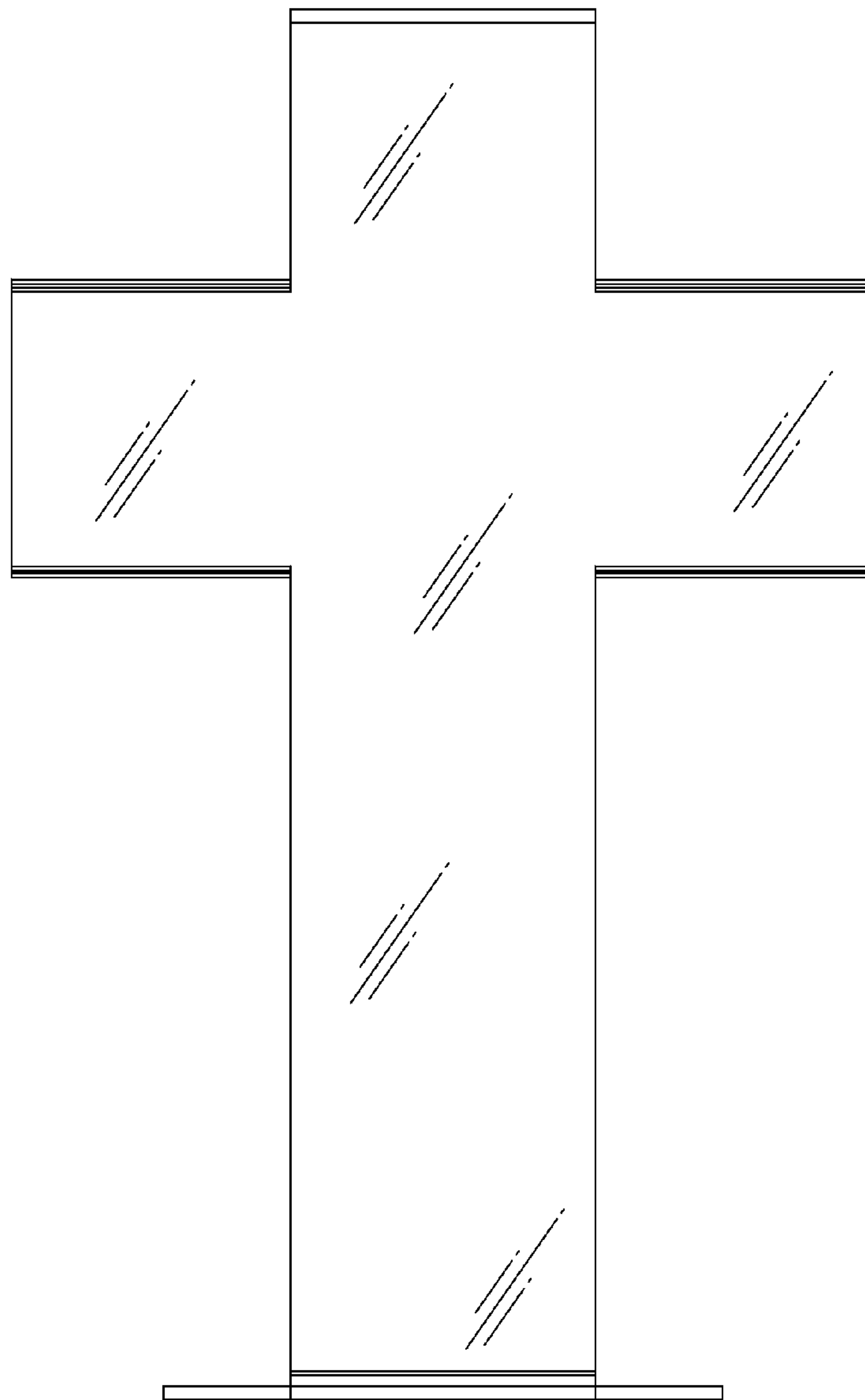

FIG. 4
(AMENDED)

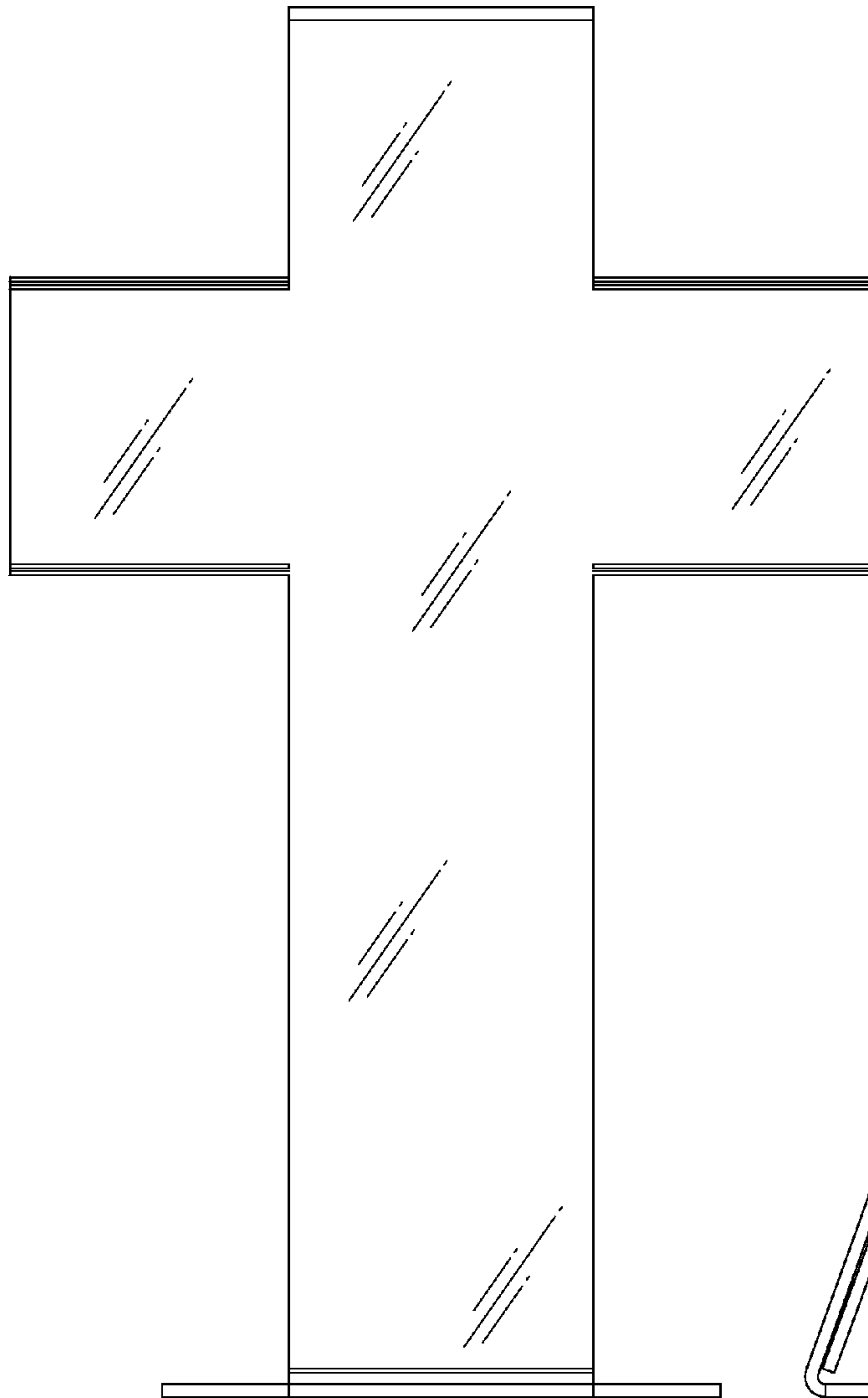

FIG. 5
(AMENDED)

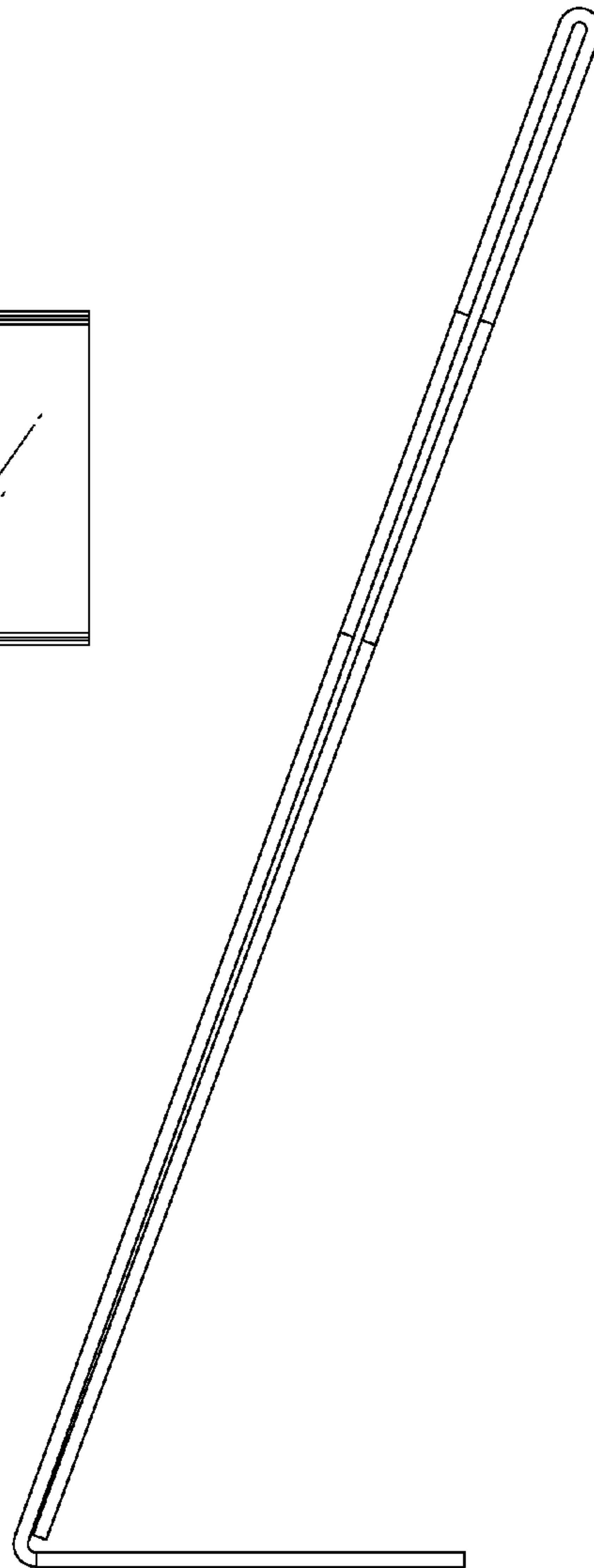

FIG. 6
(AMENDED)

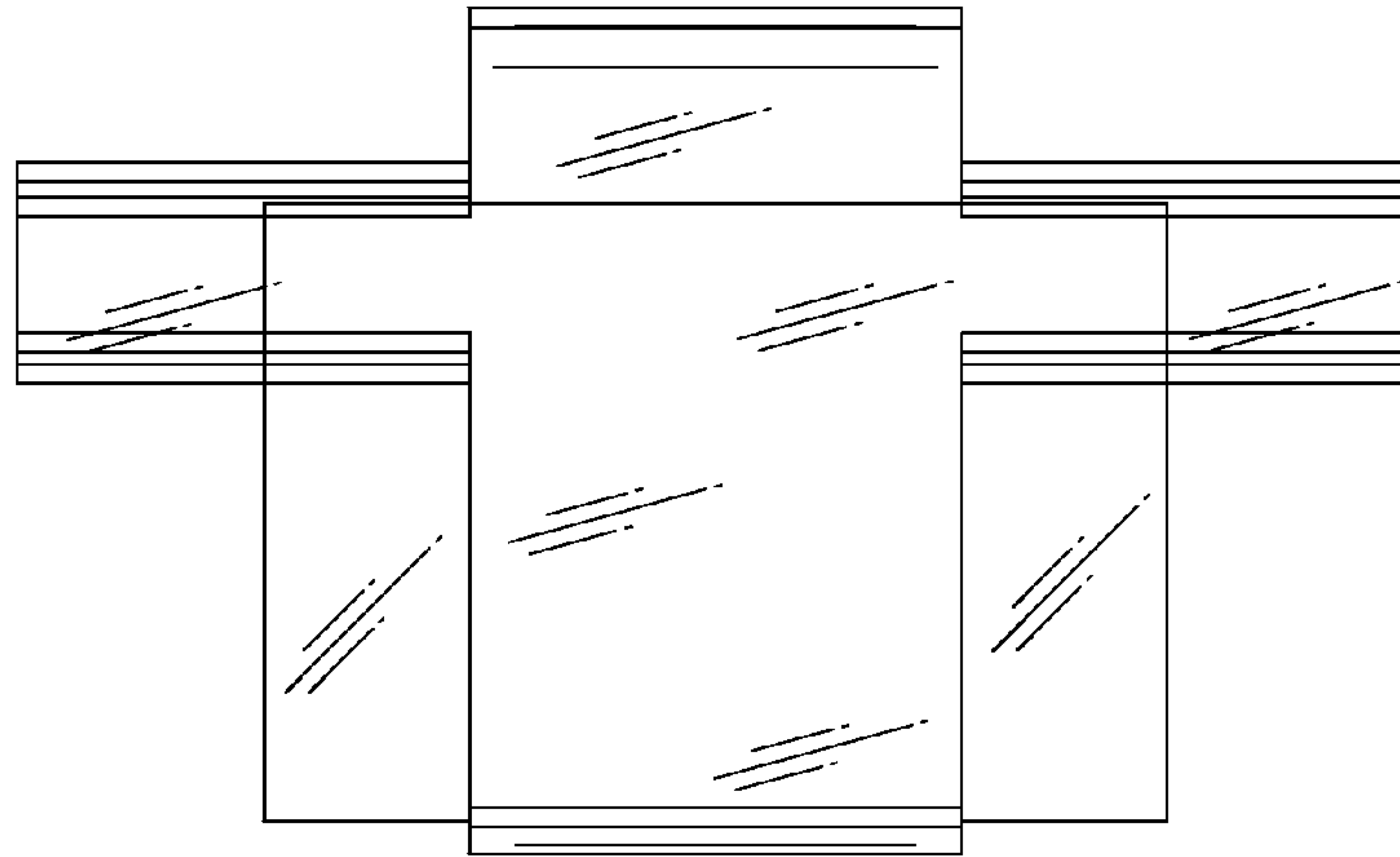

FIG. 7
(AMENDED)

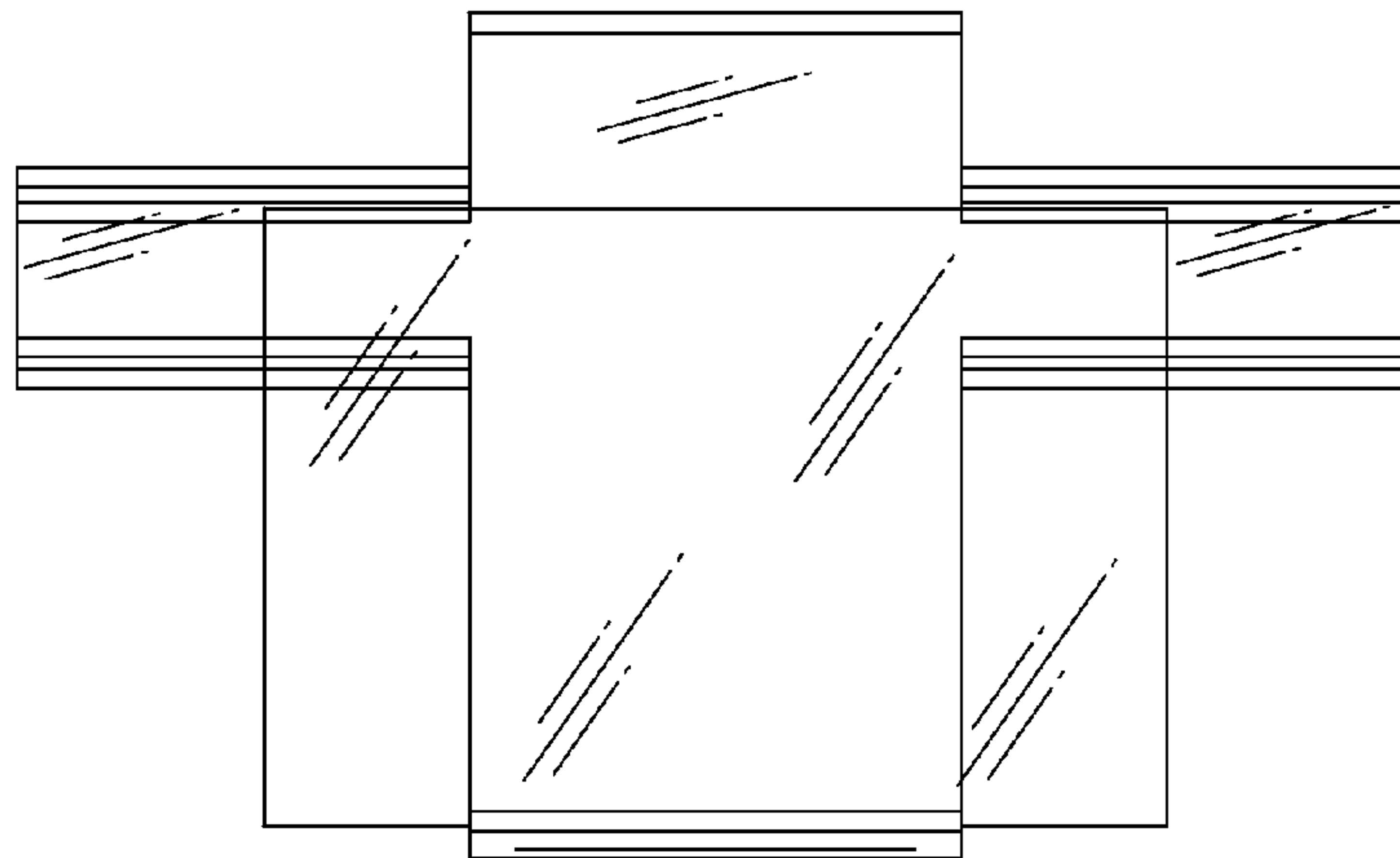

FIG. 8
(AMENDED)

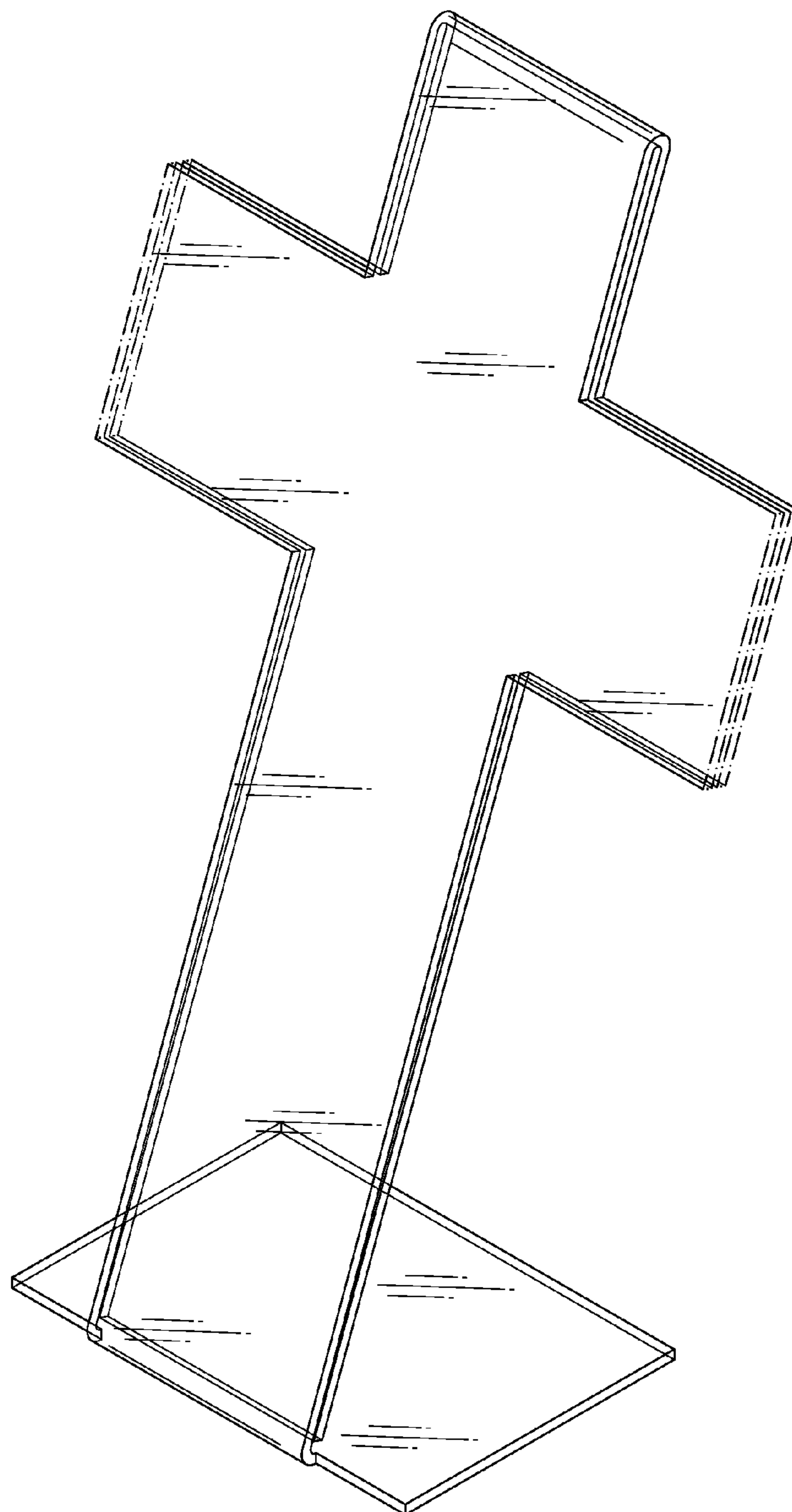

FIG. 9
(NEW)

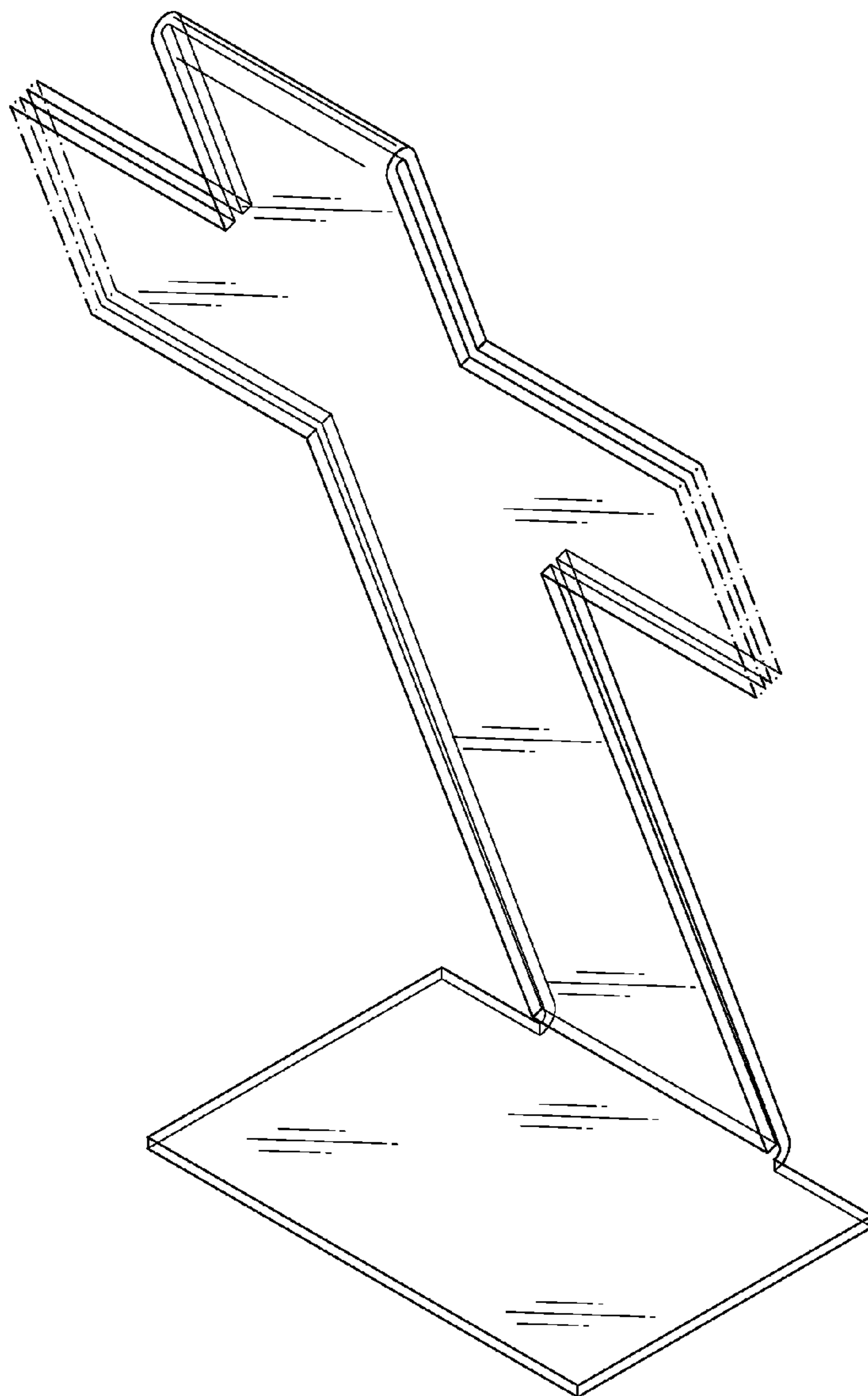

FIG. 10
(NEW)

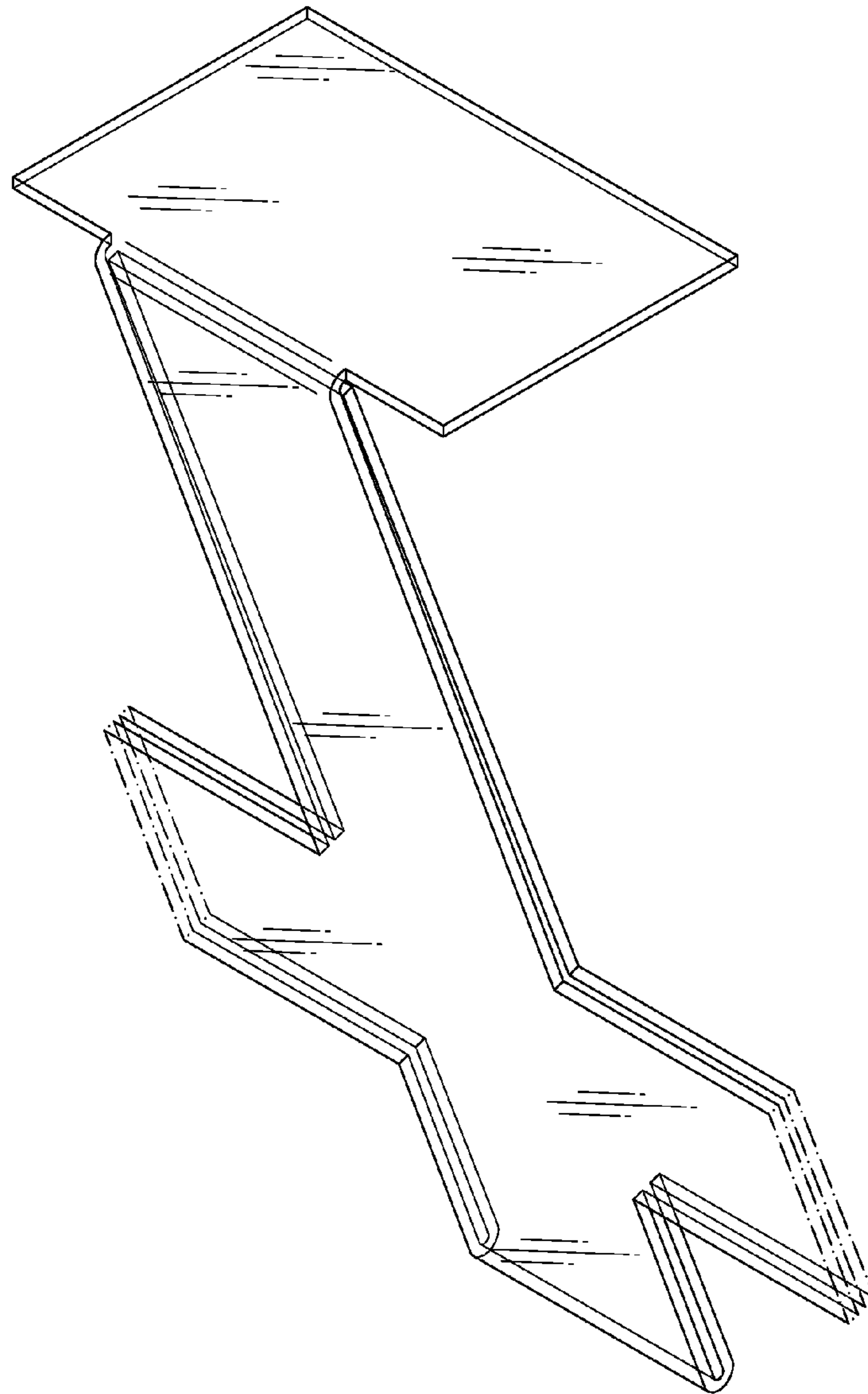

FIG. 11
(NEW)

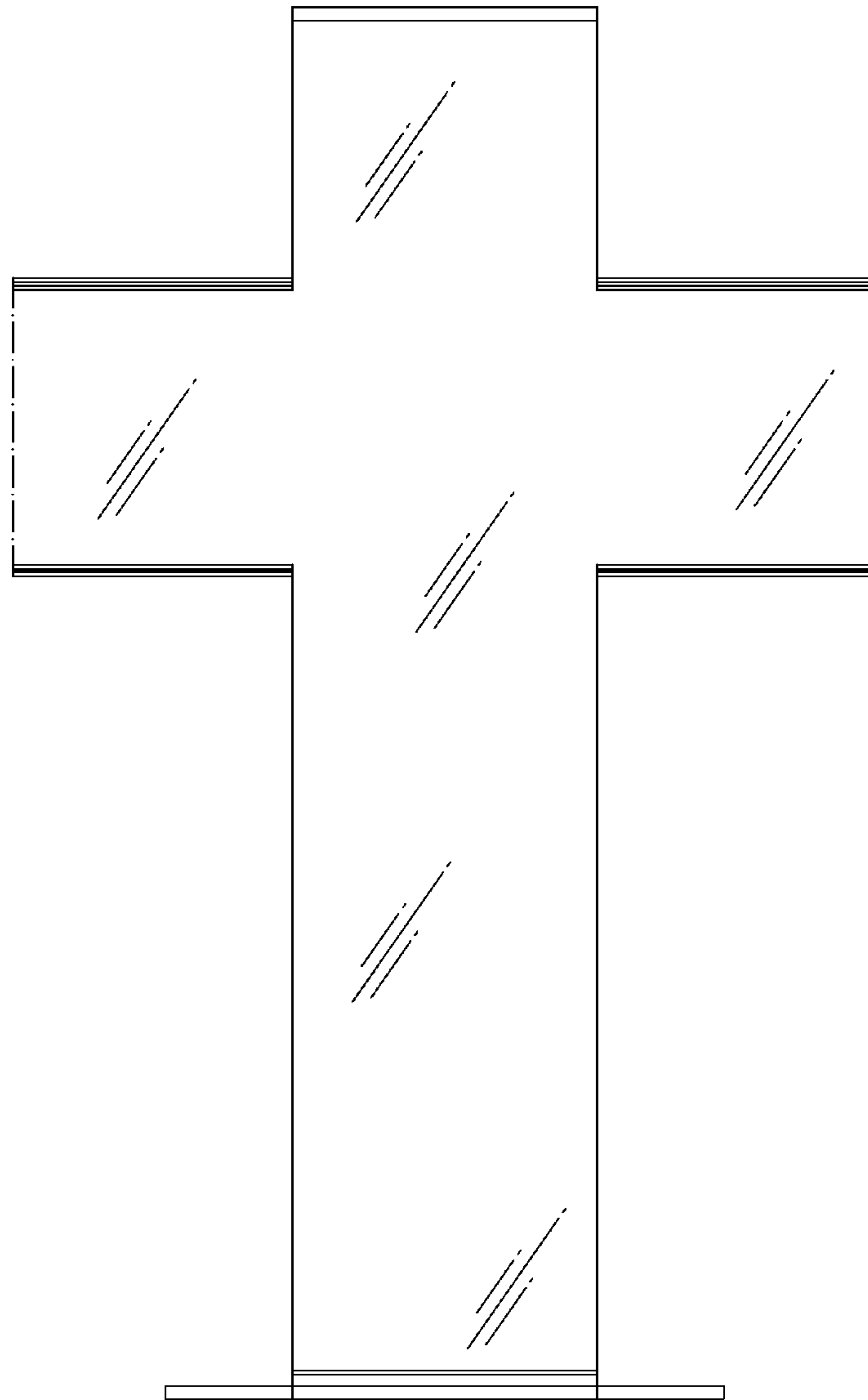

FIG. 12
(NEW)

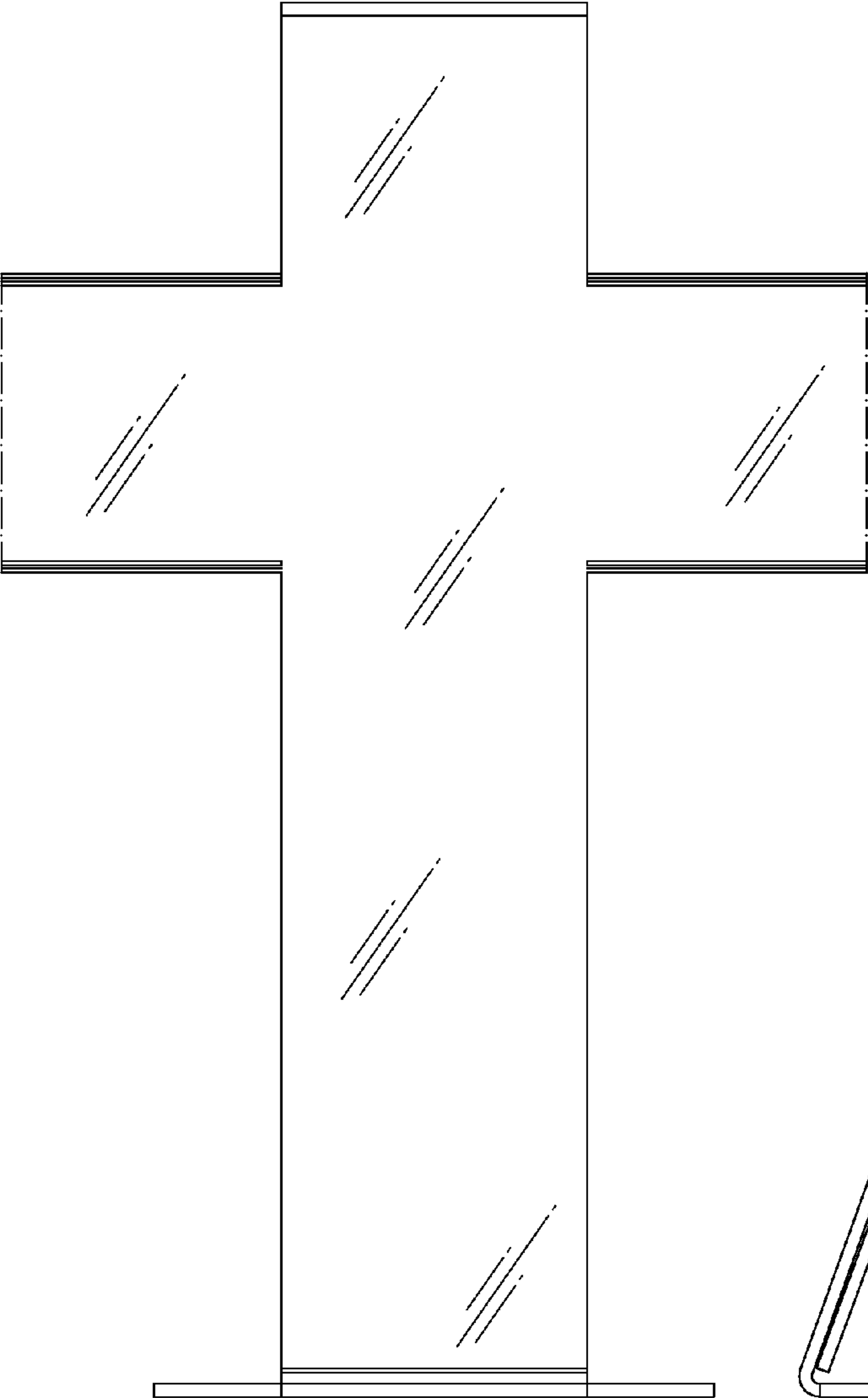

FIG. 13
(NEW)

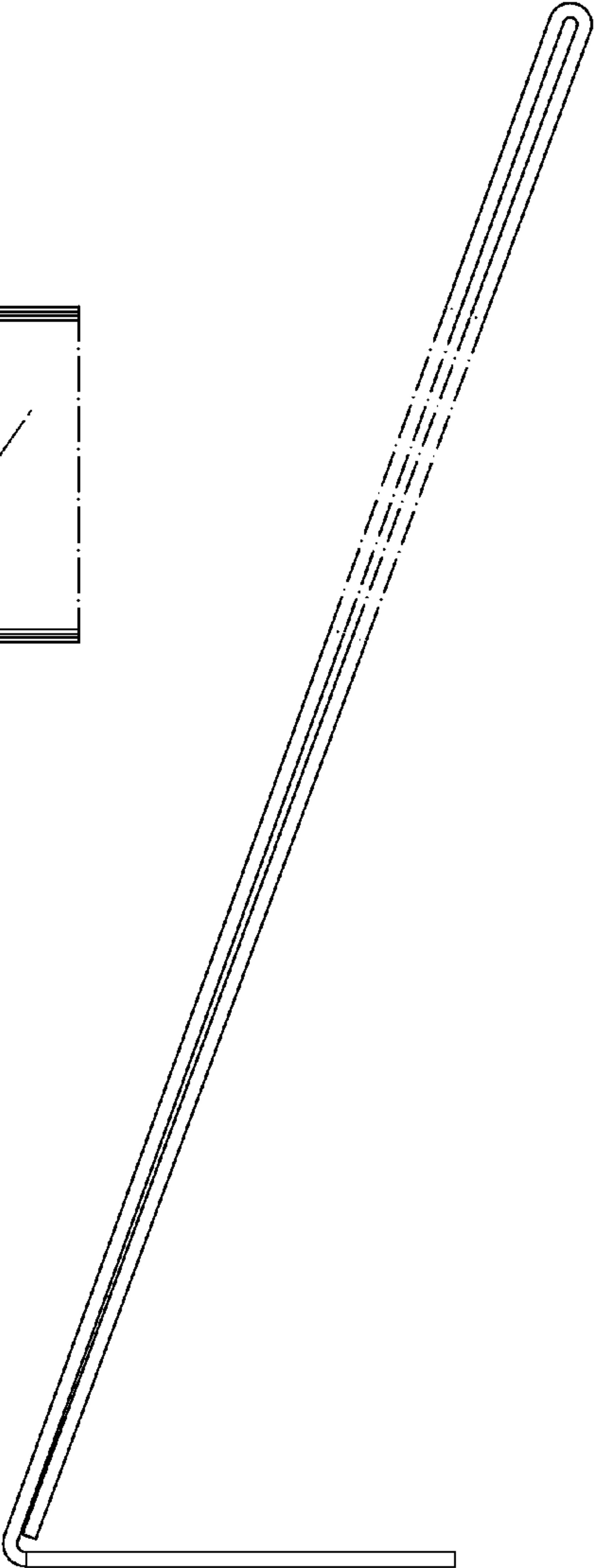

FIG. 14
(NEW)

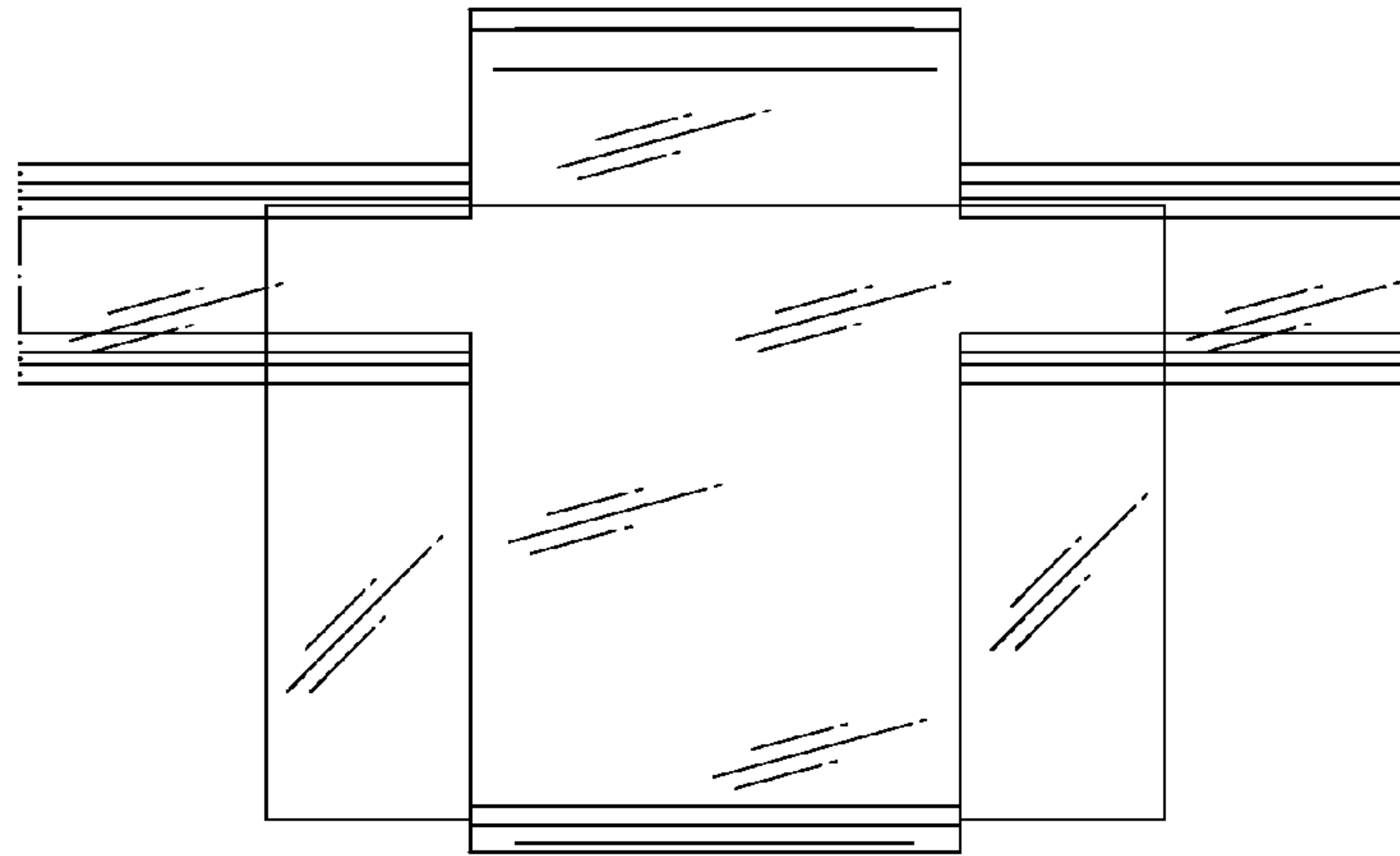

FIG. 15
(NEW)

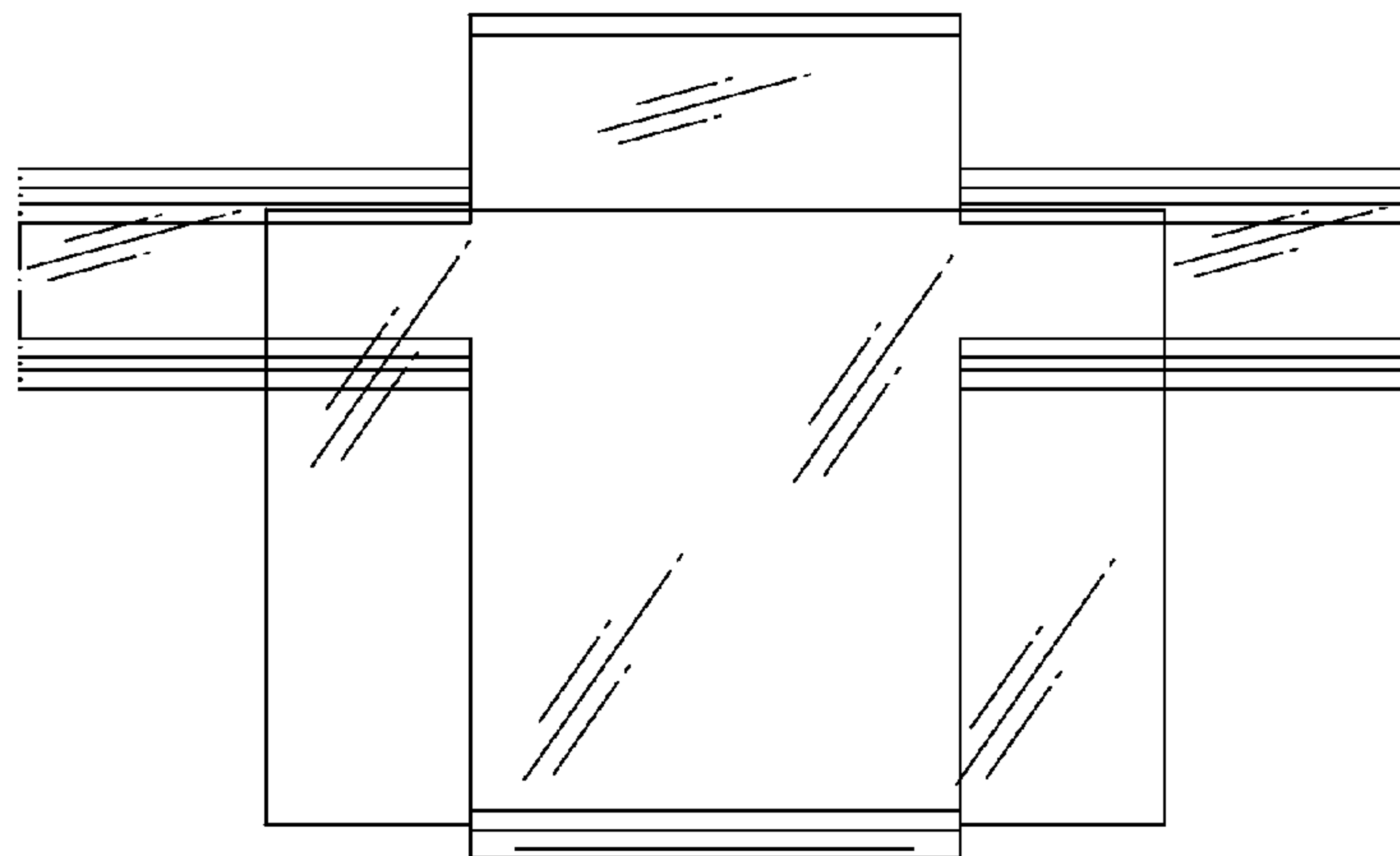

FIG. 16
(NEW)