

US00RE45022E

(19) **United States**
(12) **Reissued Patent**
Graham et al.

(10) **Patent Number:** **US RE45,022 E**
(45) **Date of Reissued Patent:** **Jul. 22, 2014**

(54) **BOTTLE**
(75) Inventors: **Heidi N. Graham**, Cordova, TN (US);
Kimberly Lyn McCormack,
Maplewood, NJ (US); **Laura Ann**
Flanagan-Kent, Decatur, GA (US)

(73) Assignee: **MSD Consumer Care, Inc.**, Memphis,
TN (US)

(21) Appl. No.: **29/415,275**

(22) Filed: **Mar. 8, 2012**

Related U.S. Patent Documents

Reissue of:

(64) Patent No.: **Des. 619,898**
Issued: **Jul. 20, 2010**
Appl. No.: **29/306,928**
Filed: **Apr. 18, 2008**

(51) **LOC (10) Cl.** **09-01**
(52) **U.S. Cl.**
USPC **D9/540; D9/563; D9/566; D9/564;**
D9/575

(58) **Field of Classification Search**
USPC **D9/516, 540, 542, 543, 550, 551, 558,**
D9/563, 564, 565, 566, 571, 572, 573, 574,
D9/575; 220/660, 669
See application file for complete search history.

(56) **References Cited**

U.S. PATENT DOCUMENTS

D97,512 S 11/1935 Smith
D156,219 S 11/1949 Deskey

(Continued)

OTHER PUBLICATIONS

U.S. Trademark Application No. 77/775265 Prosecution History:
Notice of Abandonment.

(Continued)

Primary Examiner — Phillip S Hyder

(74) *Attorney, Agent, or Firm* — Kenyon & Kenyon LLP

(57) **CLAIM**
The ornamental design for a bottle, as shown and described.

DESCRIPTION

FIG. 1 is a perspective view of a bottle showing our new design;
FIG. 2 is a front view thereof;
FIG. 3 is a right side view thereof;
FIG. 4 is a left side view thereof;
FIG. 5 is a back view thereof.;
FIG. 6 is a top view thereof;
FIG. 7 is a bottom view thereof;
FIG. 8 is a perspective view of a *second embodiment of the* bottle showing our new design;
FIG. 9 is a front view thereof;
FIG. 10 is a right side view thereof;
FIG. 11 is a left side view thereof;
FIG. 12 is a back view thereof.;
FIG. 13 is a top view thereof;
FIG. 14 is a bottom view thereof;
FIG. 15 is a perspective view of a *third embodiment of the* bottle showing our new design;
FIG. 16 is a front view thereof;
FIG. 17 is a right side view thereof;
FIG. 18 is a left side view thereof;
FIG. 19 is a back view thereof;
FIG. 20 is a top view thereof; and,
FIG. 21 is a bottom view thereof.

[The broken line showing of a portion of the bottom is included for the purpose of illustrating environmental structure and forms no part of the claimed design.]

The broken lines depict portions of the bottle in which the design is embodied that are not considered part of the claimed design.

1 Claim, 12 Drawing Sheets

Matter enclosed in heavy brackets [] appears in the original patent but forms no part of this reissue; matter printed in italics indicates the additions made by reissue.

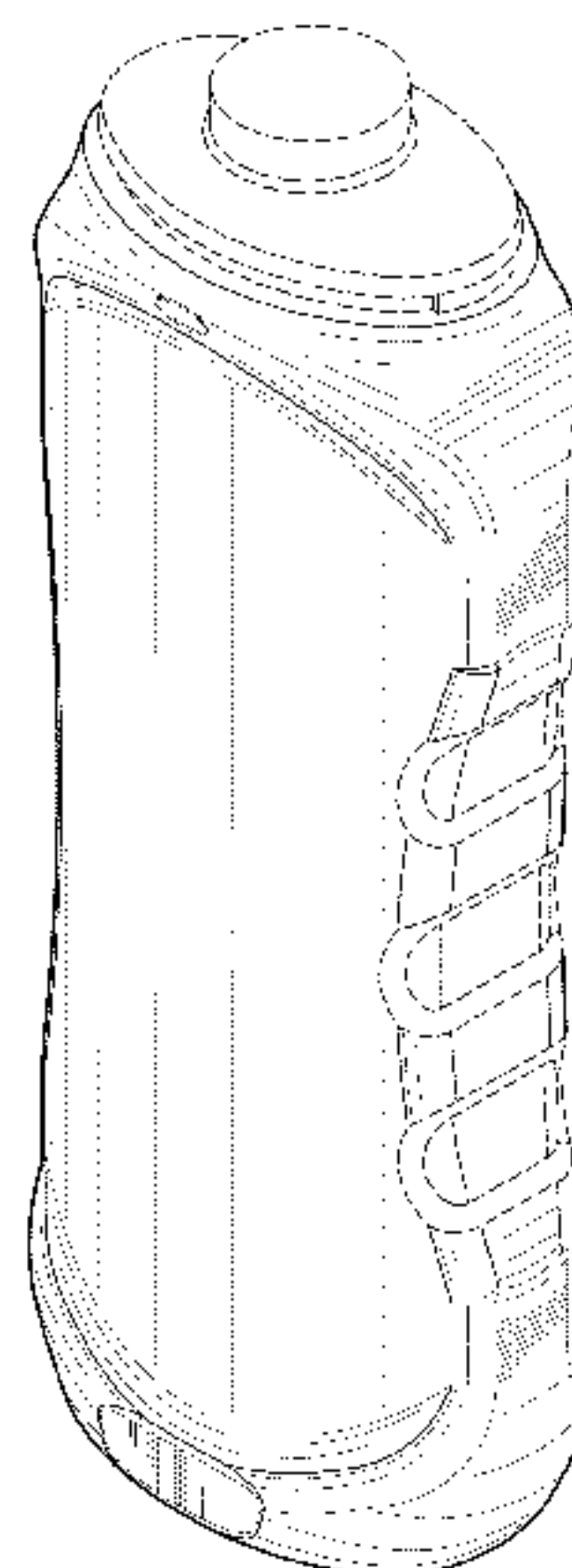

Amended

(56)

References Cited

U.S. PATENT DOCUMENTS

D221,133 S 7/1971 Wikke
 D234,492 S 3/1975 Peterson
 D234,911 S 4/1975 Stevens, Jr.
 D235,245 S 6/1975 McDonald
 D237,463 S 11/1975 Kretz
 D242,225 S 11/1976 Sinclair
 D249,228 S 9/1978 Schacher et al.
 D263,804 S 4/1982 Kondo et al.
 D274,309 S 6/1984 Aldrich, III
 D303,100 S 8/1989 Segati
 4,885,809 A 12/1989 Muchmore
 D309,714 S 8/1990 Blesecker
 D334,538 S 4/1993 Bolen, Jr. et al.
 D335,456 S 5/1993 Brown
 D343,360 S 1/1994 Poo
 D346,744 S 5/1994 Ford et al.
 D346,963 S 5/1994 Crawford
 D355,369 S 2/1995 Lund et al.
 5,417,991 A 5/1995 Green
 D367,010 S 2/1996 Moore et al.
 D367,011 S 2/1996 Lilly et al.
 D372,199 S 7/1996 Lathrop et al.
 D372,873 S 8/1996 Lathrop et al.
 D376,320 S 12/1996 Lathrop et al.
 D376,697 S 12/1996 Green et al.
 D376,980 S 12/1996 LoPreto
 D384,285 S 9/1997 D'Amico et al.
 D394,812 S 6/1998 Crawford
 D398,479 S 9/1998 Vultaggio et al.
 D405,373 S 2/1999 Crawford
 D408,740 S 4/1999 Jones et al.
 D414,118 S 9/1999 Crawford
 D415,688 S 10/1999 Crawford
 D416,805 S 11/1999 Mikla
 D422,220 S 4/2000 Feen
 D425,429 S 5/2000 Weber
 D425,795 S 5/2000 Feen
 D425,797 S 5/2000 Crawford
 D427,914 S 7/2000 Croft et al.
 D429,648 S 8/2000 Goettner
 D443,825 S 6/2001 Goettner
 D447,058 S 8/2001 Weber
 D457,069 S 5/2002 Palaia
 D459,659 S 7/2002 Chung
 D469,698 S 2/2003 Zaksenberg et al.
 D471,462 S 3/2003 May et al.
 D472,153 S 3/2003 Feen
 D486,741 S 2/2004 Houghton
 D486,742 S 2/2004 Houghton
 D489,994 S 5/2004 Crawford
 D491,067 S 6/2004 Crawford
 D491,815 S 6/2004 Crawford
 D492,202 S 6/2004 Crawford
 D495,605 S 9/2004 Crawford
 D495,609 S 9/2004 Wurster
 D496,283 S 9/2004 Busa, Jr.
 D498,680 S 11/2004 Cleary
 D505,079 S 5/2005 Mulder et al.
 D511,969 S 11/2005 Busa et al.
 D514,448 S 2/2006 Kuzma et al.
 D522,372 S 6/2006 Wang et al.
 D528,006 S 9/2006 Walther et al.
 D528,007 S 9/2006 De Niverville et al.
 D529,810 S 10/2006 Davies et al.
 D529,812 S 10/2006 Ratzlaff
 D529,814 S 10/2006 Winkler et al.
 D532,312 S 11/2006 Conway et al.
 D533,069 S * 12/2006 Archeny D9/542
 D533,073 S 12/2006 Brunner et al.
 D535,565 S 1/2007 Pitassi
 D545,210 S 6/2007 Armstrong et al.
 D545,211 S 6/2007 Armstrong et al.
 D546,187 S 7/2007 Ratzlaff
 D546,189 S 7/2007 Costello et al.
 D548,602 S 8/2007 Escobosa et al.

D552,995 S 10/2007 Toh
 D553,502 S 10/2007 Toh
 D567,096 S 4/2008 Toh
 D585,752 S * 2/2009 Shami D9/530
 D590,717 S 4/2009 Weber

OTHER PUBLICATIONS

U.S. Trademark Application No. 77/775265 Prosecution History: Office Action dated Aug. 4, 2010.
 U.S. Trademark Application No. 77/775265 Prosecution History: Banana Boat Sport Performance Sunscreen.
 U.S. Trademark Application No. 77/775265 Prosecution History: Hawaiian Tropic Sheer Touch Lotion Sunscreen.
 U.S. Trademark Application No. 77/775265 Prosecution History: Silgan Plastics HDPE Tapered & Wave-Side Oblongs.
 U.S. Trademark Application No. 77/775265 Prosecution History: Silgan Plastics Bottle & Jar Catalog.
 U.S. Trademark Application No. 77/775265 Prosecution History: Bottle Image.
 U.S. Trademark Application No. 77/775265 Prosecution History: Amendment and Mail Process dated Aug. 3, 2010.
 U.S. Trademark Application No. 77/775265 Prosecution History: Amended Drawing dated Aug. 1, 2010.
 U.S. Trademark Application No. 77/775265 Prosecution History: Drawing dated Aug. 1, 2010.
 U.S. Trademark Application No. 77/775265 Prosecution History: Response to Office Action dated Aug. 1, 2010.
 U.S. Trademark Application No. 77/775265 Prosecution History: Office Action dated Feb. 3, 2010.
 U.S. Trademark Application No. 77/775265 Prosecution History: cpc packaging Applications: The New Face of Coppertone.
 U.S. Trademark Application No. 77/775265 Prosecution History: Seaquist Closures 19.5mm Large Gem Oval Snap Top.
 U.S. Trademark Application No. 77/775265 Prosecution History: Seaquist Closures Large Gemini Snap Top.
 U.S. Trademark Application No. 77/775265 Prosecution History: Safeway Sunscreen Lotion.
 U.S. Trademark Application No. 77/775265 Prosecution History: U.S. Patent No. 6,321,923.
 U.S. Trademark Application No. 77/775265 Prosecution History: Amendment and Mail process dated Jan. 22, 2010.
 U.S. Trademark Application No. 77/775265 Prosecution History: Amended Drawing dated Jan. 21, 2010.
 U.S. Trademark Application No. 77/775265 Prosecution History: Drawing dated Jan. 21, 2010.
 U.S. Trademark Application No. 77/775265 Prosecution History: Response to Office Action dated Jan. 21, 2010.
 U.S. Trademark Application No. 77/775265 Prosecution History: Revocation of Attorney/Domestic Representative and/or Appointment of Attorney/Domestic Representative.
 U.S. Trademark Application No. 77/775265 Prosecution History: Office Action dated Jul. 21, 2009.
 U.S. Trademark Application No. 77/775265 Prosecution History: Bonanzle Moisture Therapy Cucumber Body Lotion.
 U.S. Trademark Application No. 77/775265 Prosecution History: beauty encounter Vaseline Intensive Care Healthy Body Complexion Nourishing Body Lotion.
 U.S. Trademark Application No. 77/775265 Prosecution History: Smallflower Kneipp Evening Primrose Body Lotion.
 U.S. Trademark Application No. 77/775265 Prosecution History: Smallflower Weleda Calendula Baby Body Lotion.
 U.S. Trademark Application No. 77/775265 Prosecution History: Dove Supreme Clean Oil Sleek Satin Body Wash.
 U.S. Trademark Application No. 77/775265 Prosecution History: Dove Energy Glow Beauty Body Lotion.
 U.S. Trademark Application No. 77/775265 Prosecution History: Banana Boat Sport Performance DriBlok Sunscreen.
 U.S. Trademark Application No. 77/775265 Prosecution History: drugstore.com AXE Snake Peel Shower Scrub with Desert Minerals + Cactus Oil.
 U.S. Trademark Application No. 77/775265 Prosecution History: O.Berk Company Plastic Bottles—Grip-Handle Liquid Container.

(56)

References Cited

OTHER PUBLICATIONS

U.S. Trademark Application No. 77/775265 Prosecution History: drugstore.com Irish Spring Body Wash.
U.S. Trademark Application No. 77/775265 Prosecution History: Avon Moisture Therapy Intensive Body Lotion.
U.S. Trademark Application No. 77/775265 Prosecution History: Dial Body Wash.
U.S. Trademark Application No. 77/775265 Prosecution History: Gillette Hydrator + Body Wash.
U.S. Trademark Application No. 77/775265 Prosecution History: Olay Age Defying Body Wash.
U.S. Trademark Application No. 77/775265 Prosecution History: Suncare Glossary.
U.S. Trademark Application No. 77/775265 Prosecution History: viewpoints Non-Greasy Sunscreen Reviews.
U.S. Trademark Application No. 77/775265 Prosecution History: Paula's Choice Essential Non-Greasy Sunscreen.
U.S. Trademark Application No. 77/775265 Prosecution History: SkinAct Epicuren Discovery Organic Cleen 4 Teen—Non-greasy Sunscreen.
U.S. Trademark Application No. 77/775265 Prosecution History: kaboodle DHC White Sunscreen, Non-Greasy.
U.S. Trademark Application No. 77/775265 Prosecution History: Associated Content Sunscreen for Acne-Prone Skin: Non-Greasy, Oil-Free Products.

U.S. Trademark Application No. 77/775265 Prosecution History: Skin911.com Celazome Moisturizing Sunscreen.
U.S. Trademark Application No. 77/775265 Prosecution History: Nordstrom Kiehl's UV Protective Everyday Facial Moisturizing Sunscreen Cream.
U.S. Trademark Application No. 77/775265 Prosecution History: DermatologistRx Celazome Moisturizing Sunscreen.
U.S. Trademark Application No. 77/775265 Prosecution History: California Baby No Fragrance SPF 18 Moisturizing Sunscreen Lotion.
U.S. Trademark Application No. 77/775265 Prosecution History: Dr. Susan Taylor's Protect and Defend Moisturizing Sunscreen.
U.S. Trademark Application No. 77/775265 Prosecution History: XSearch Search Summary dated Jul. 15, 2009.
U.S. Trademark Application No. 77/775265 Prosecution History: XSearch Search Summary dated Jul. 14, 2009.
U.S. Trademark Application No. 77/775265 Prosecution History: Notice of Design Search Code and Pseudo Mark for U.S. Appl. No. 77/775,265.
U.S. Trademark Application No. 77/775265 Prosecution History: Drawing dated Jul. 7, 2009.
U.S. Trademark Application No. 77/775265 Prosecution History: Trademark/Service Mark Application, Principal Register dated Jul. 7, 2009.

* cited by examiner

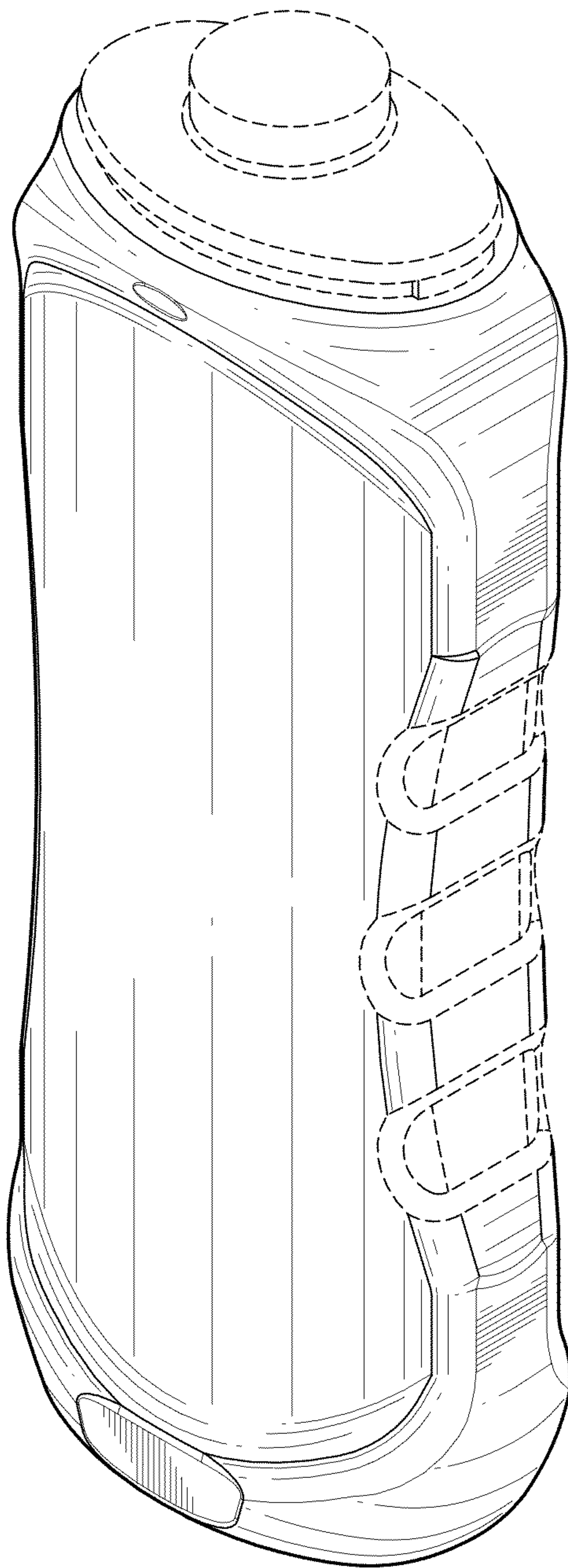

FIG. 1
Amended

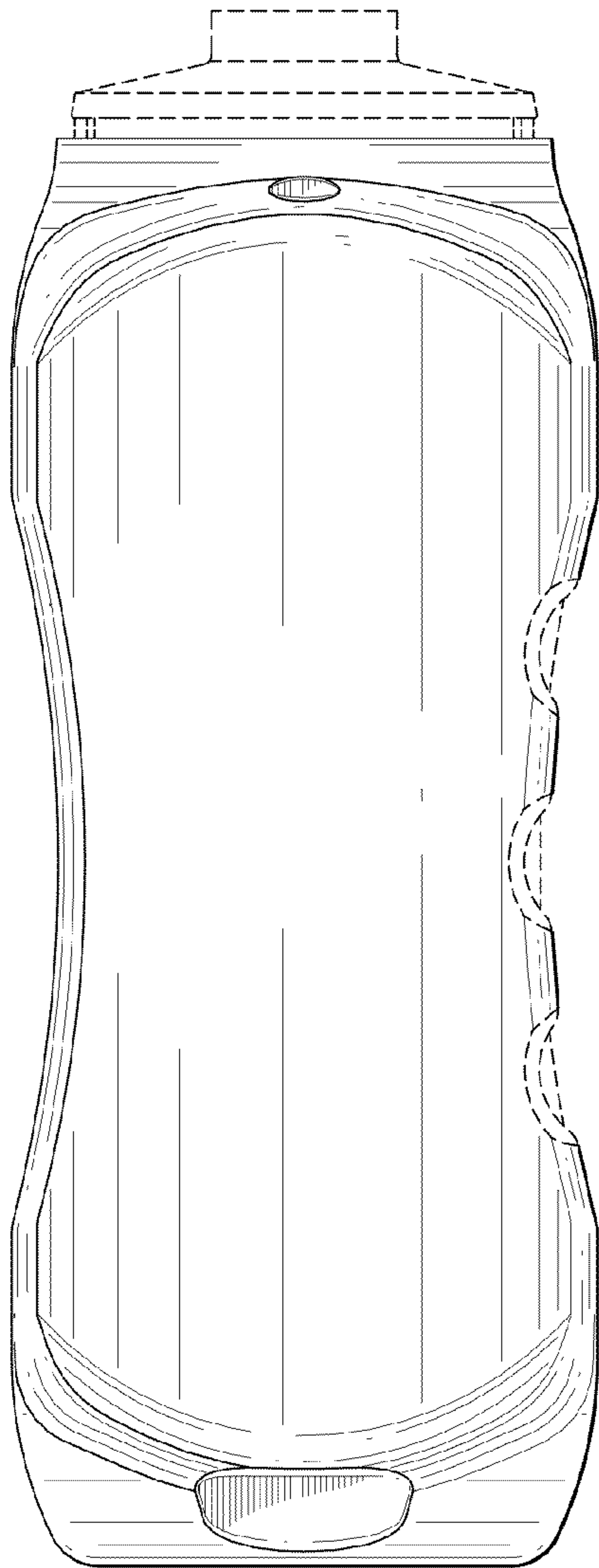

FIG. 2
Amended

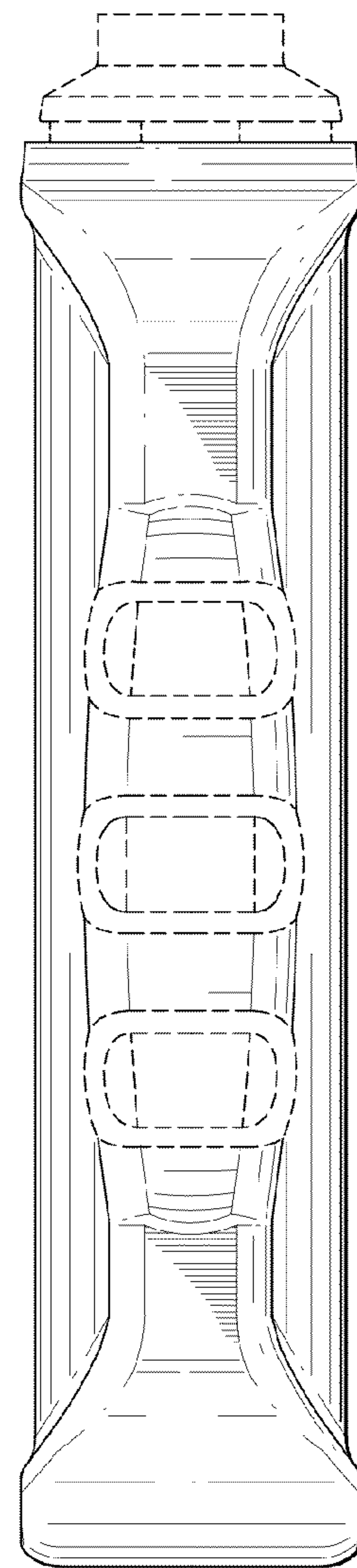

FIG. 3
Amended

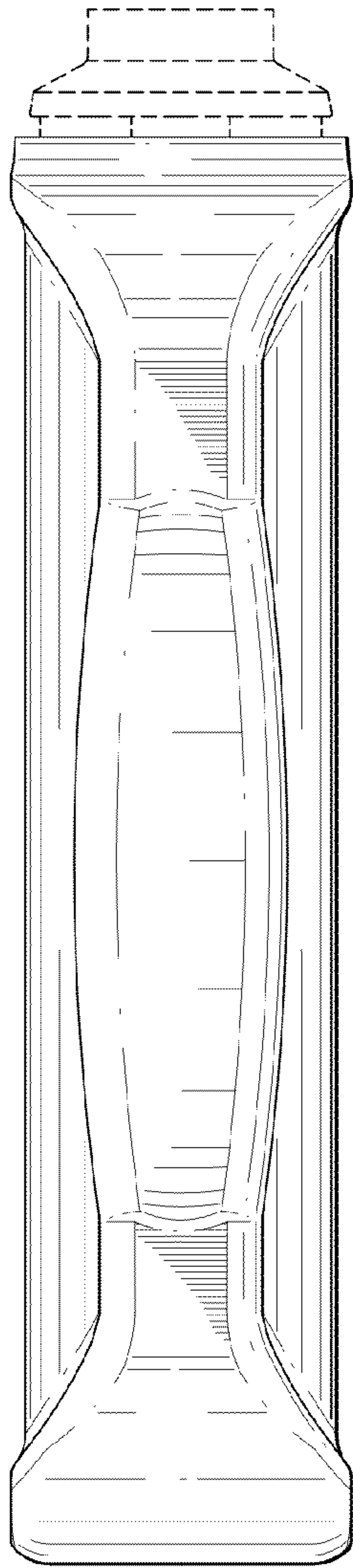

FIG. 4

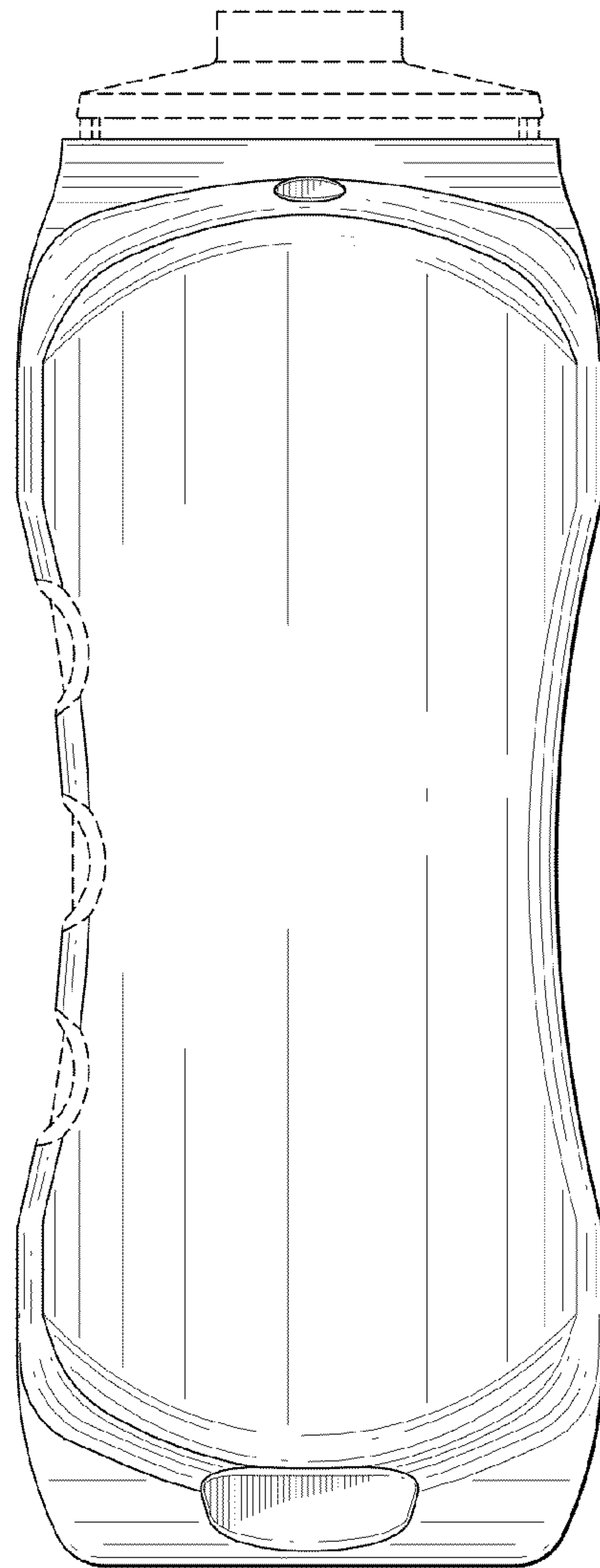

FIG. 5
Amended

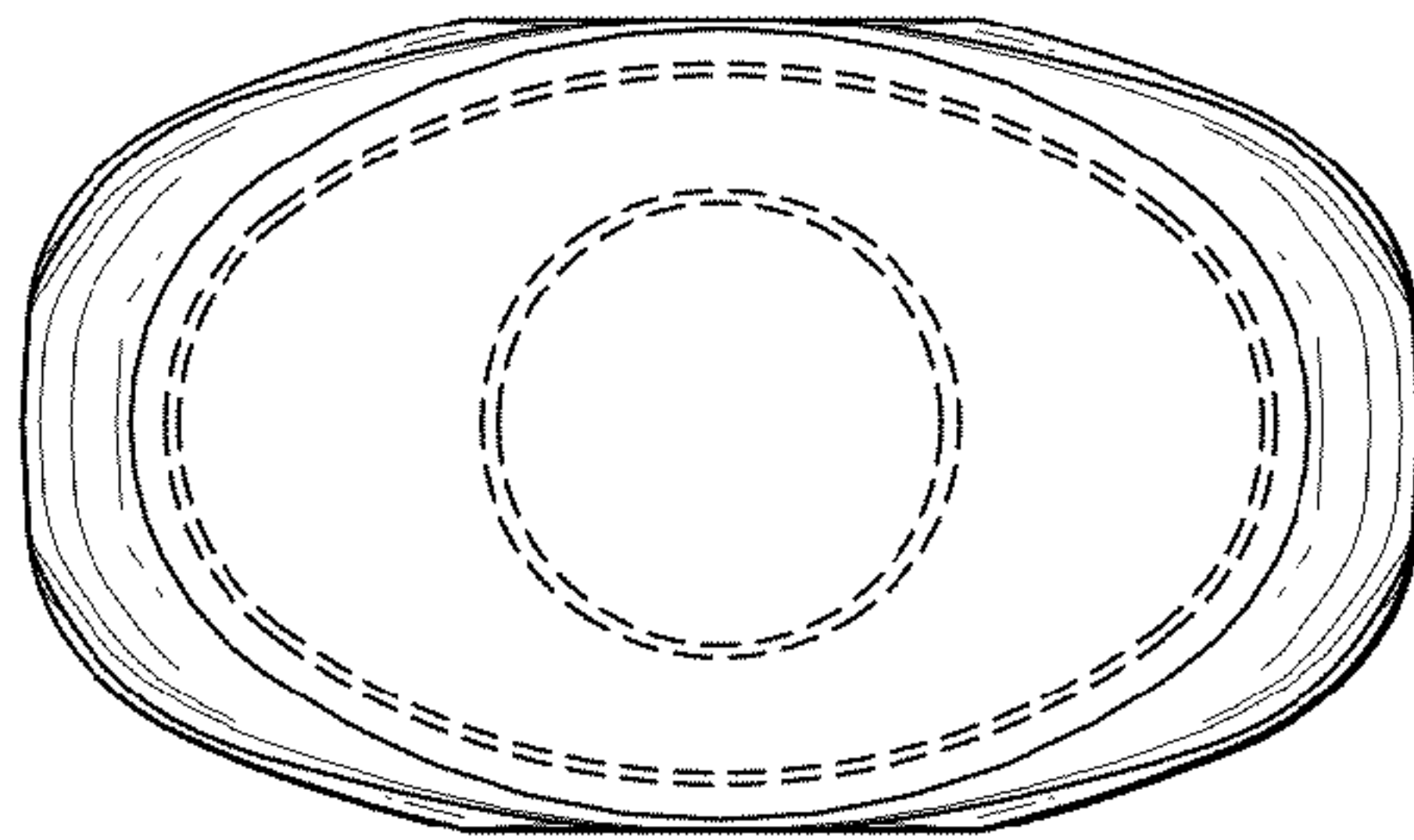

FIG. 6

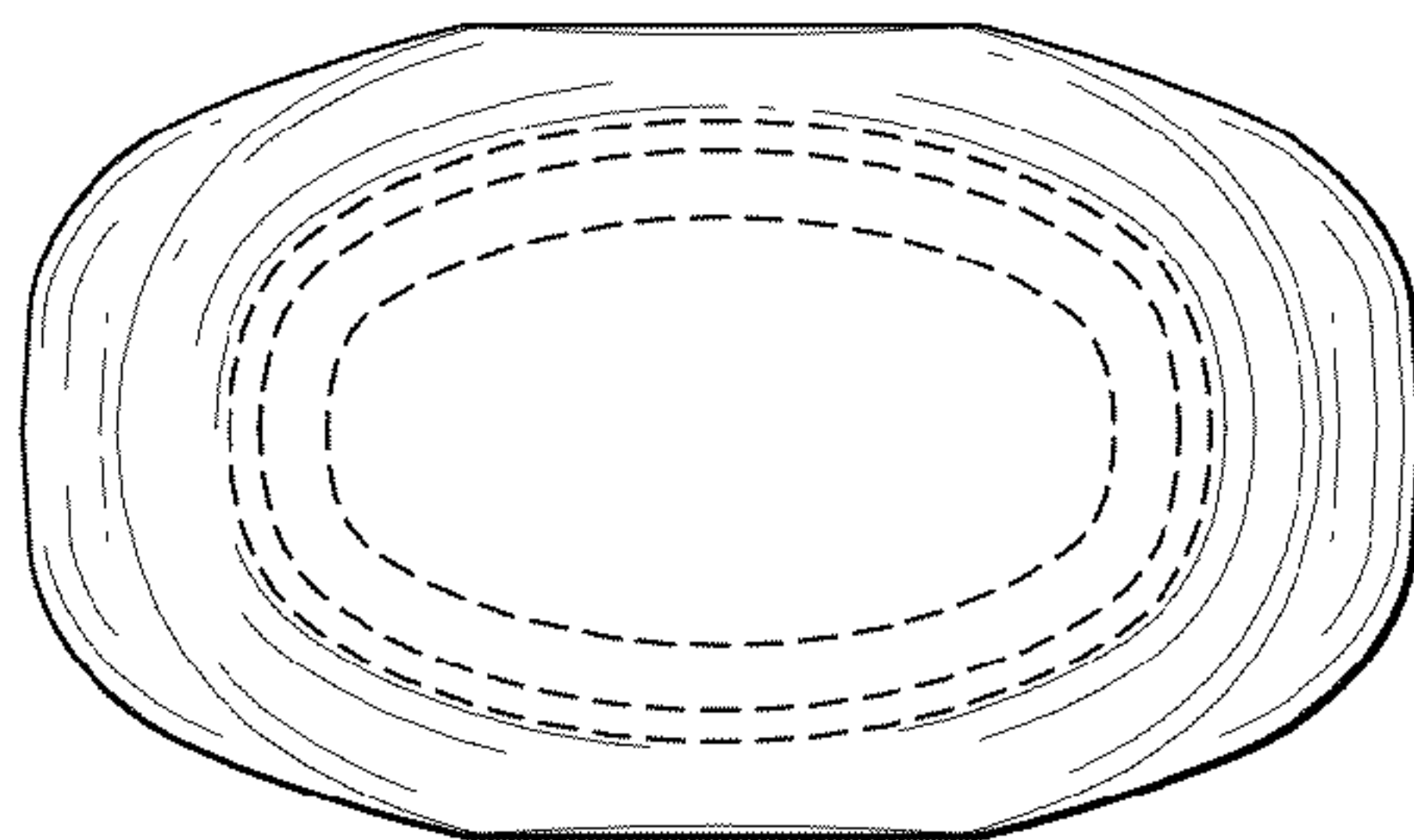

FIG. 7
Amended

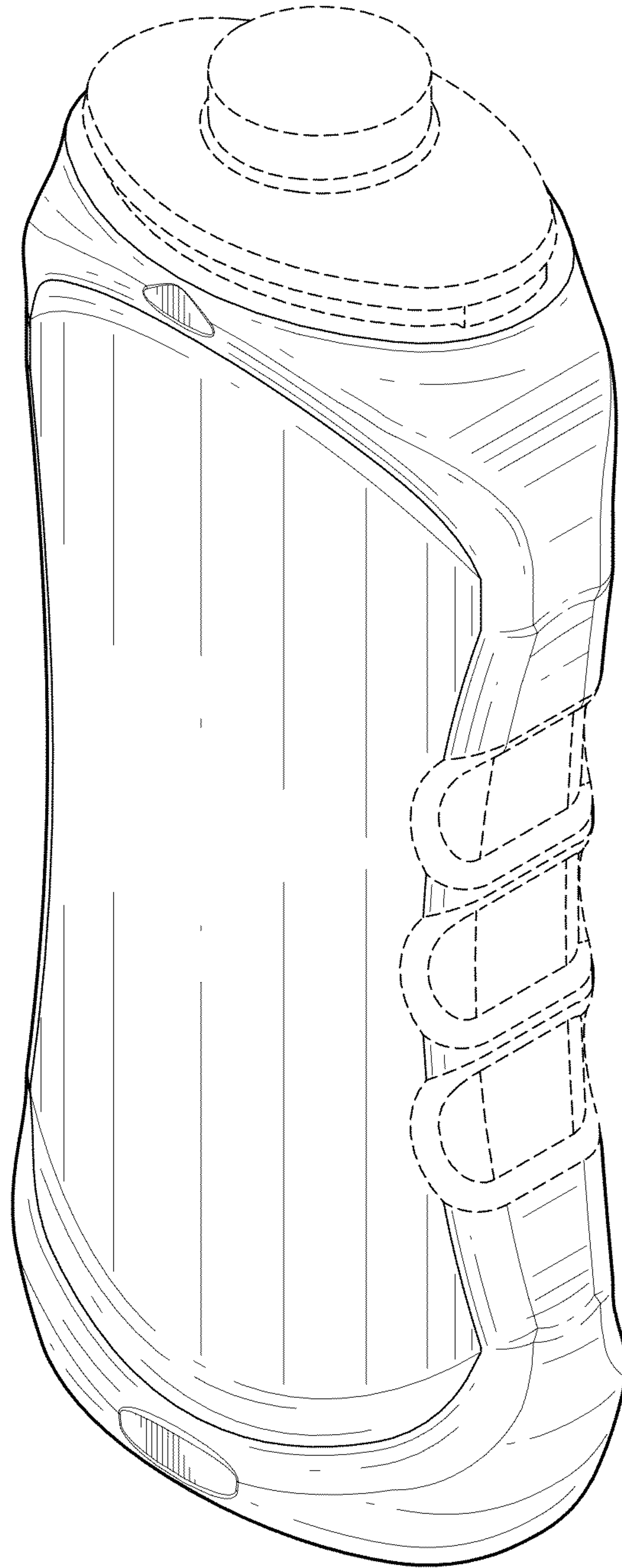

FIG. 8
Amended

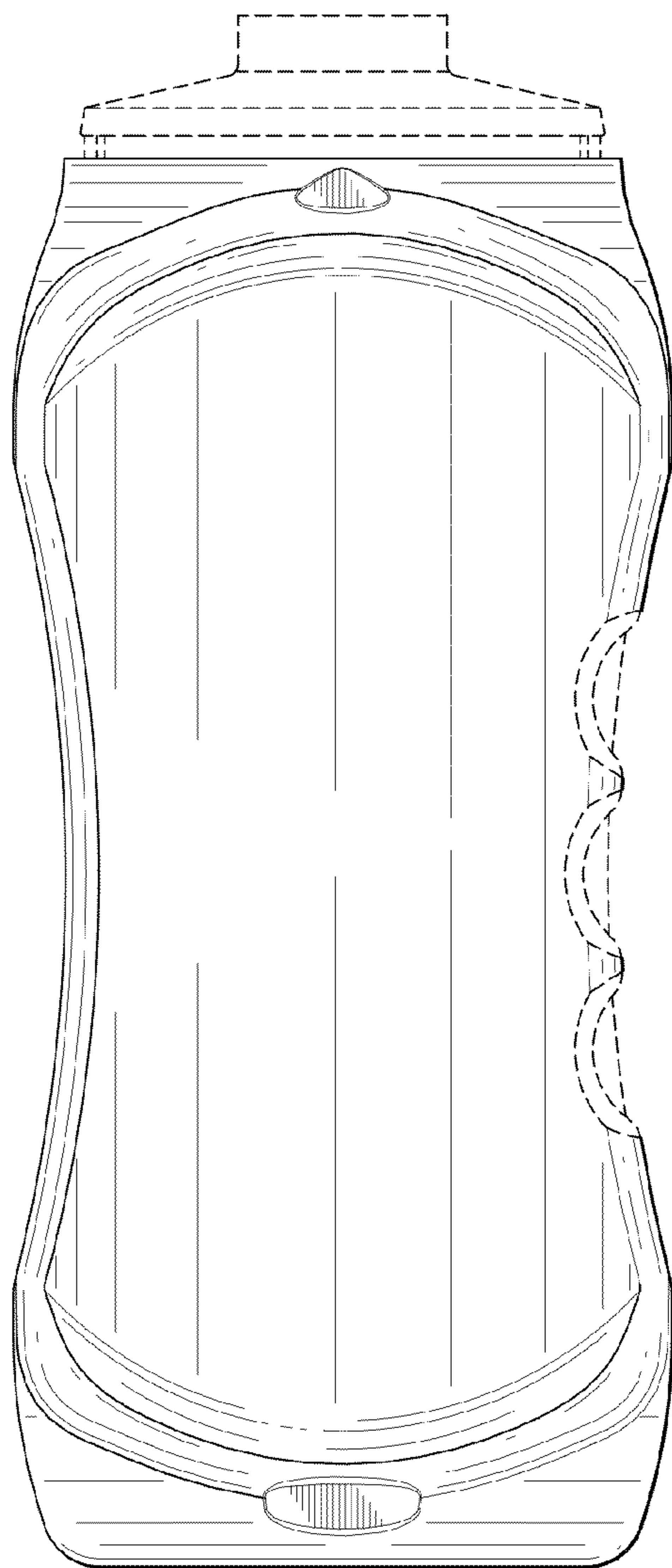

FIG. 9
Amended

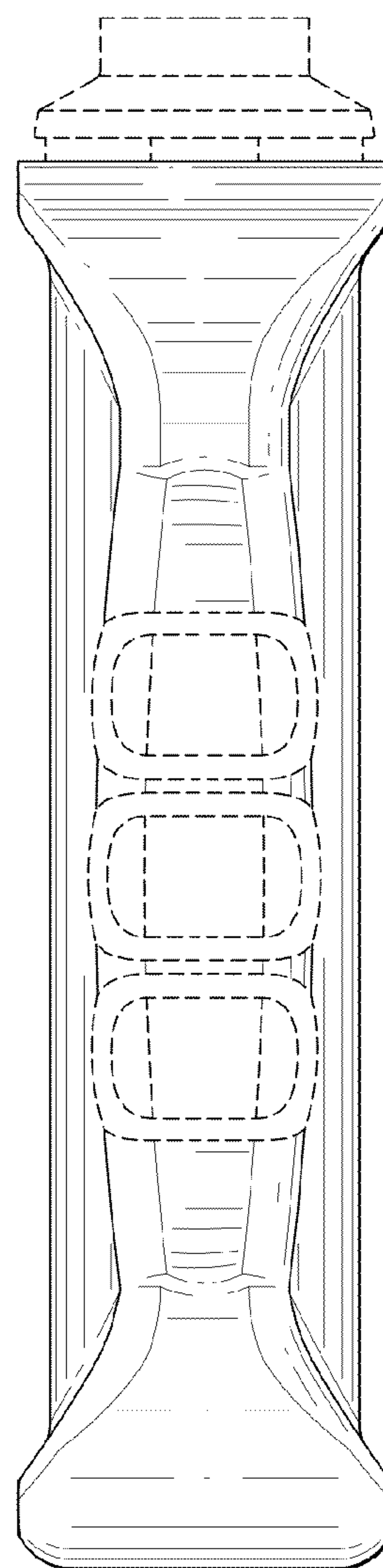

FIG. 10
Amended

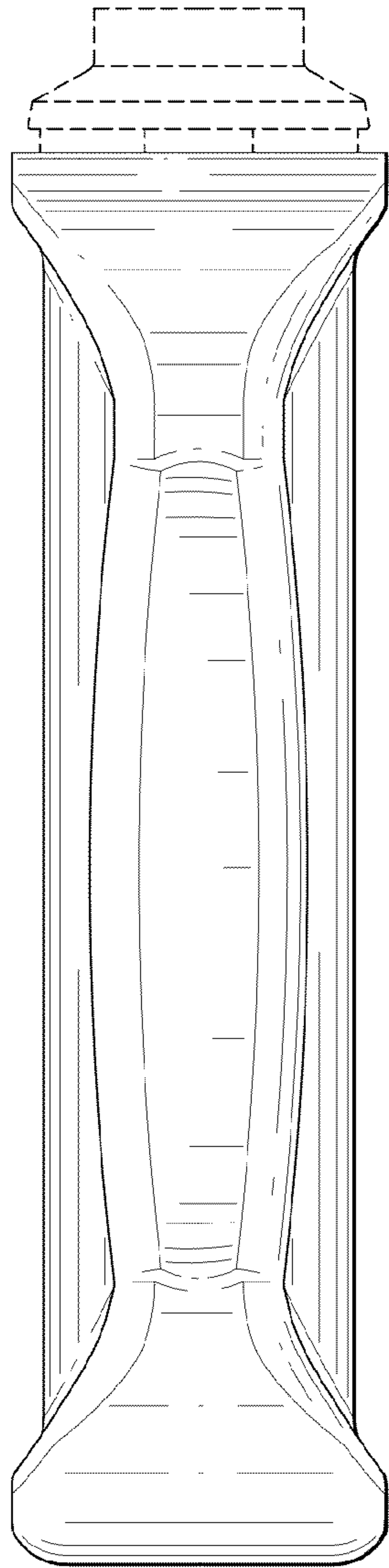

FIG. 11

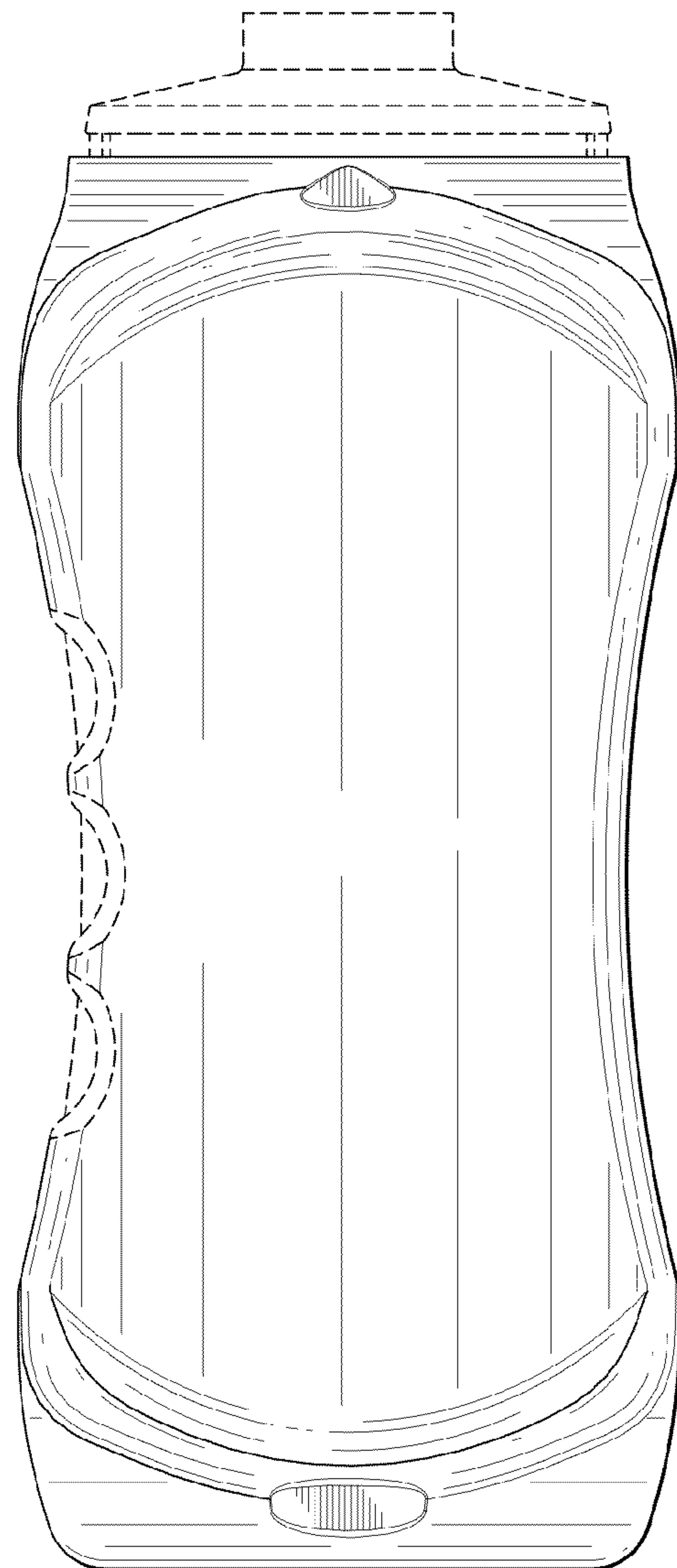

FIG. 12
Amended

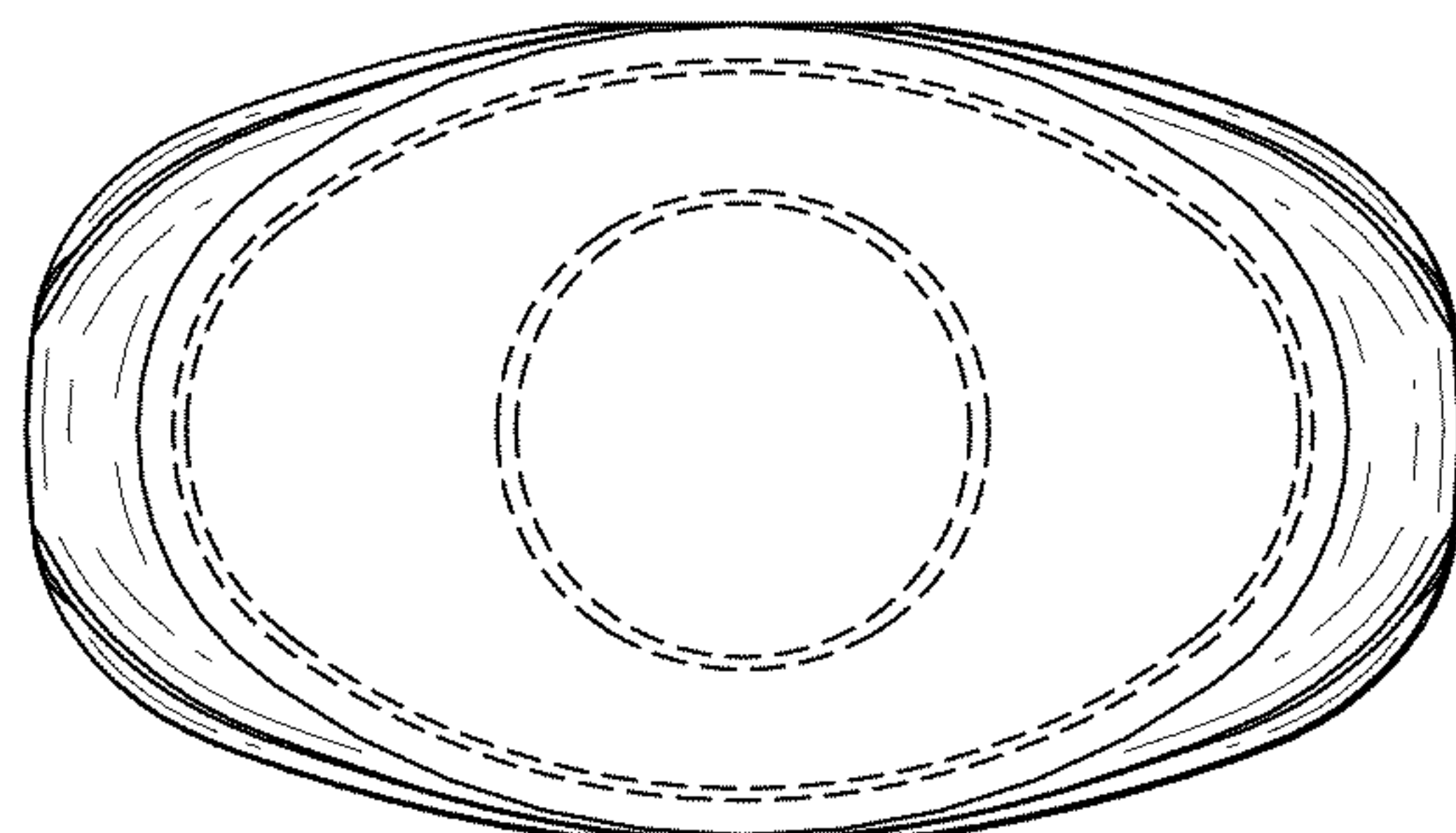

FIG. 13

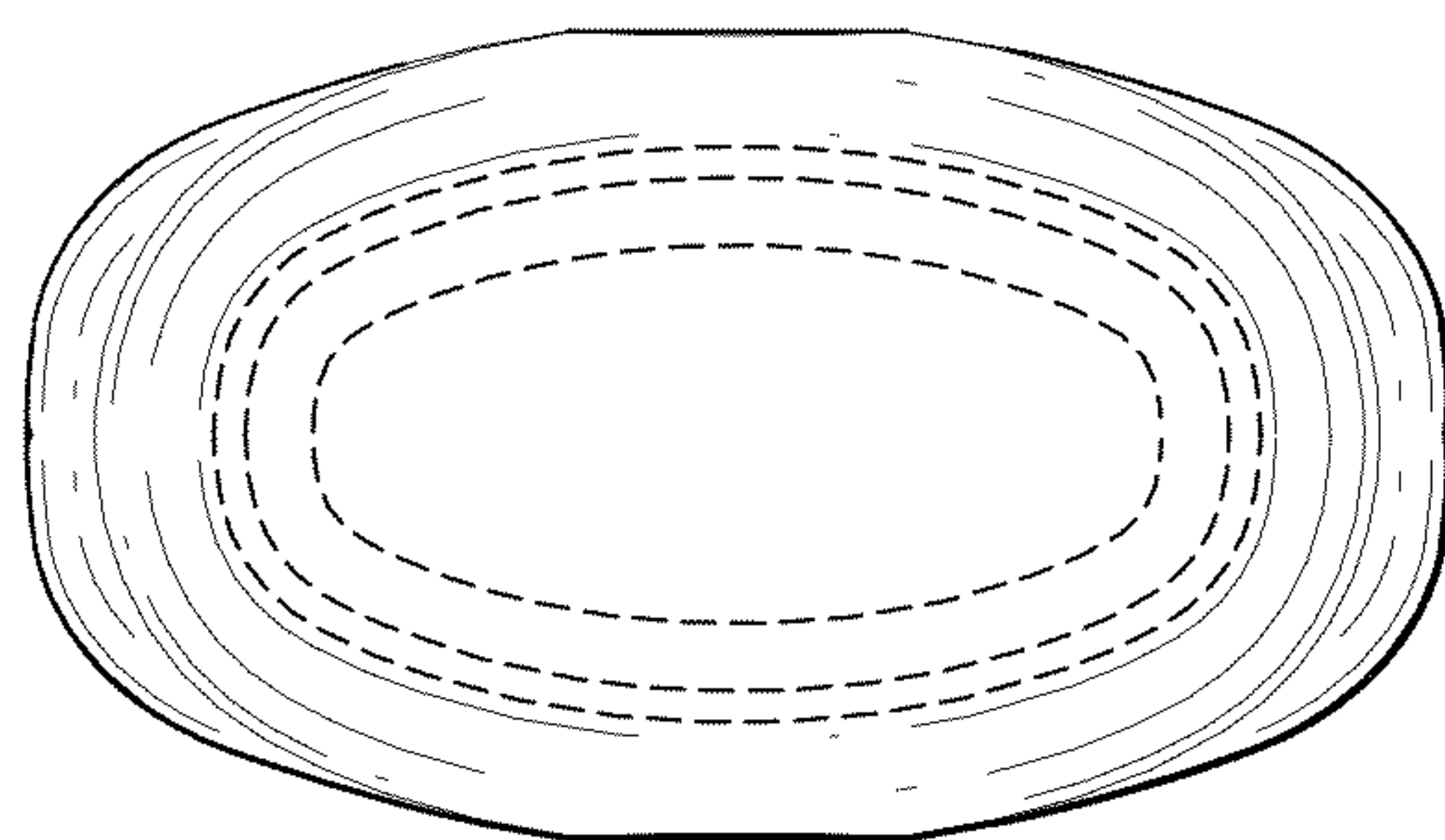

FIG. 14

Amended

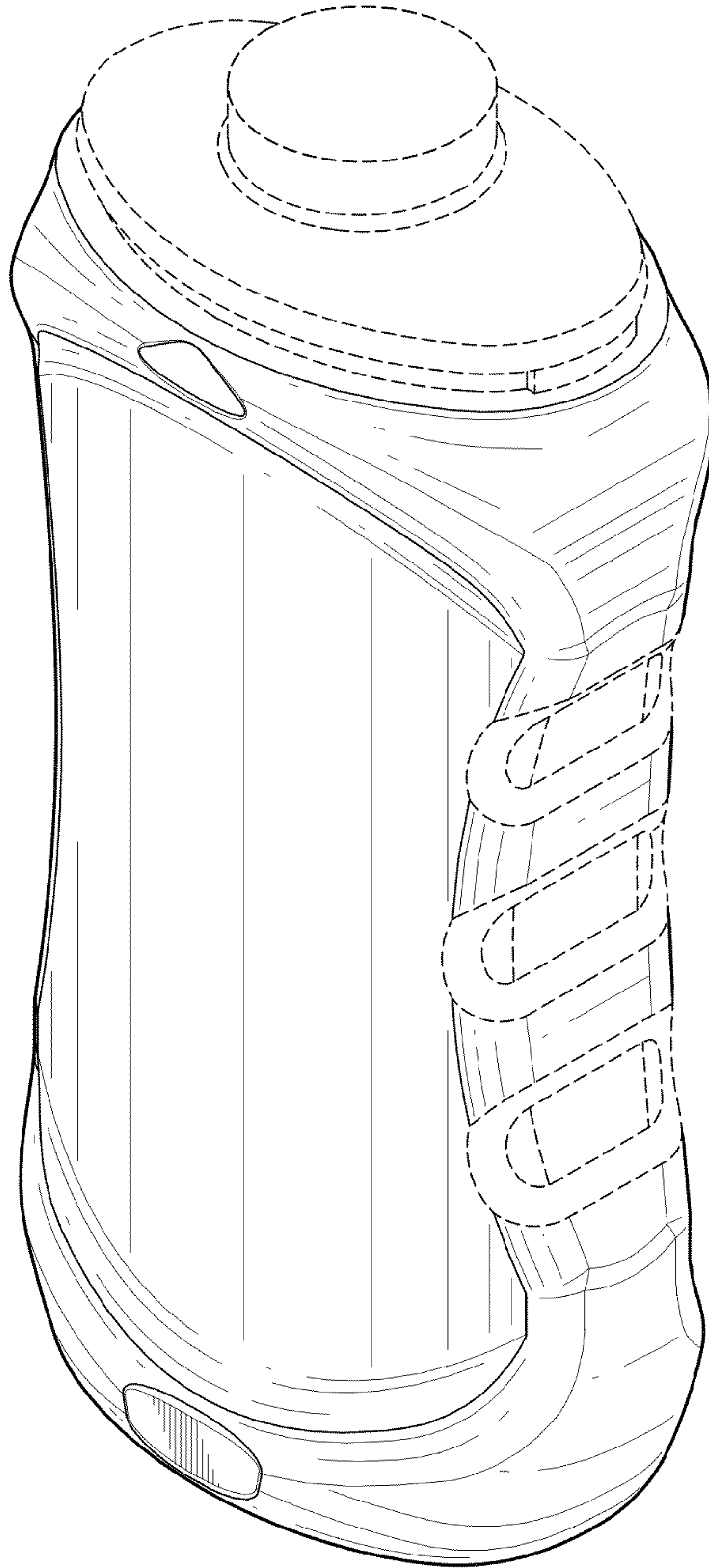

FIG. 15
Amended

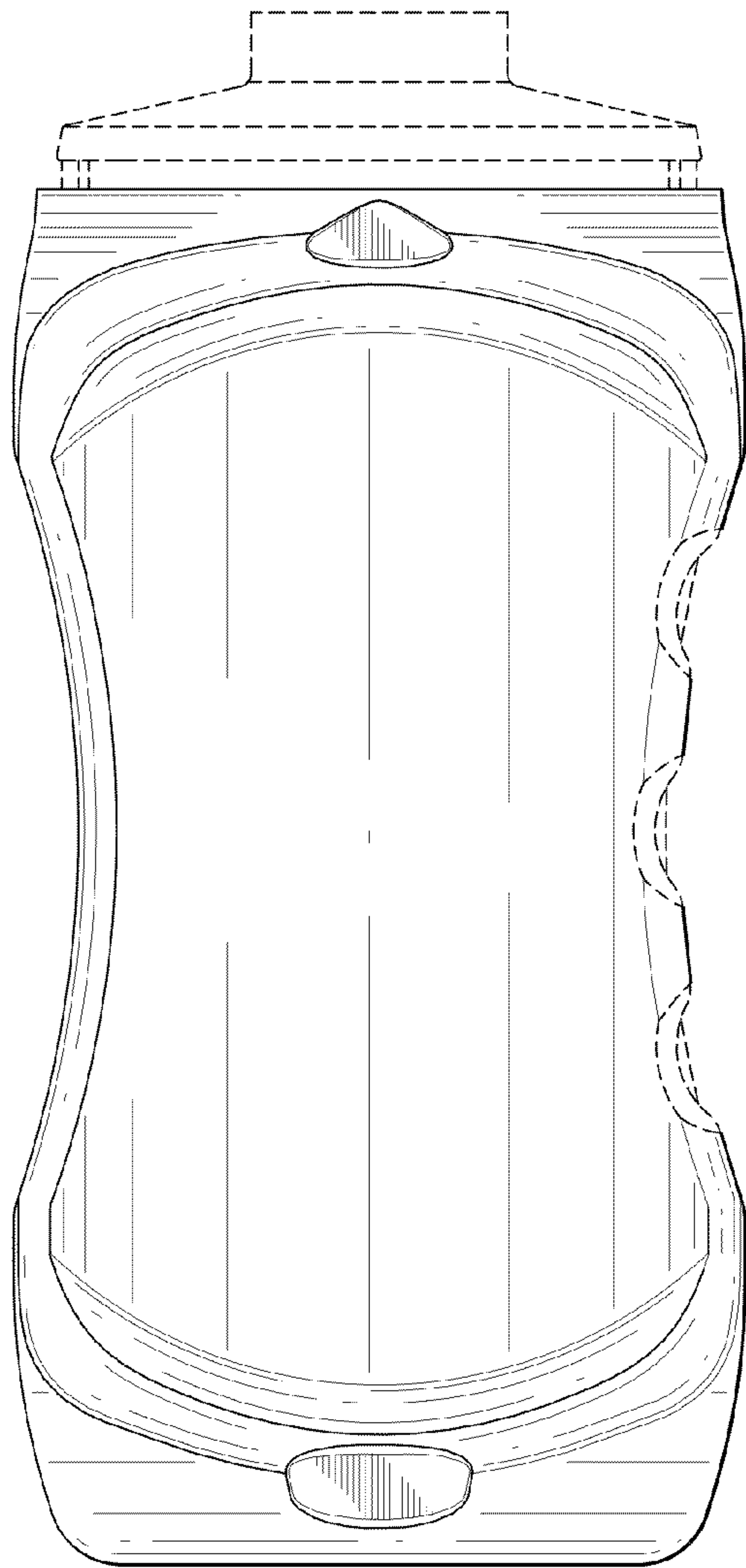

FIG. 16
Amended

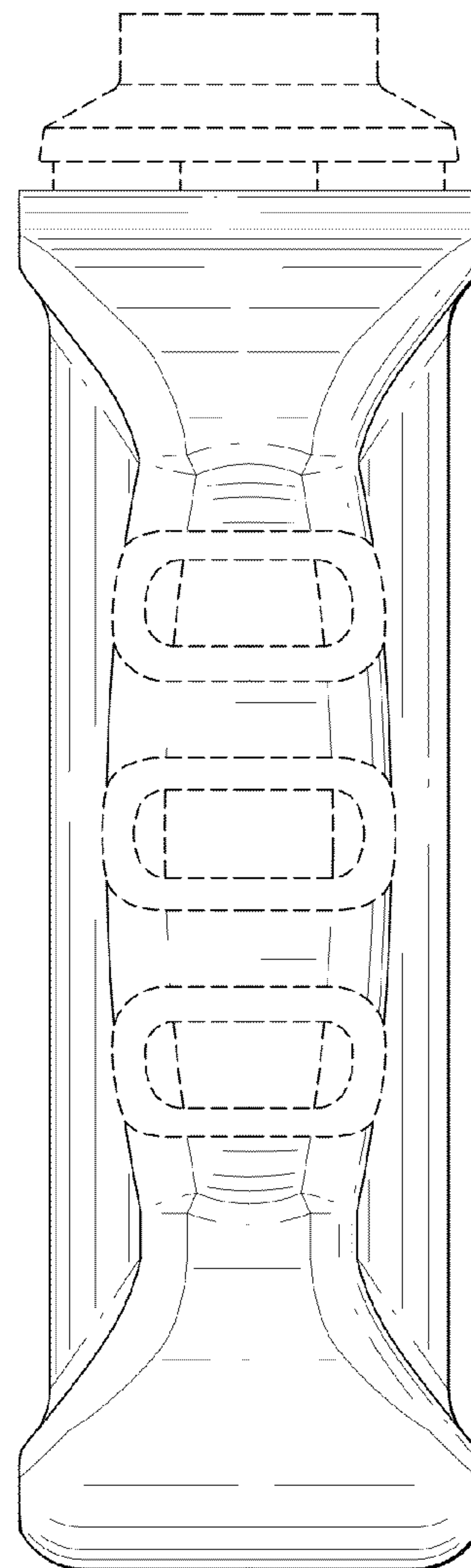

FIG. 17
Amended

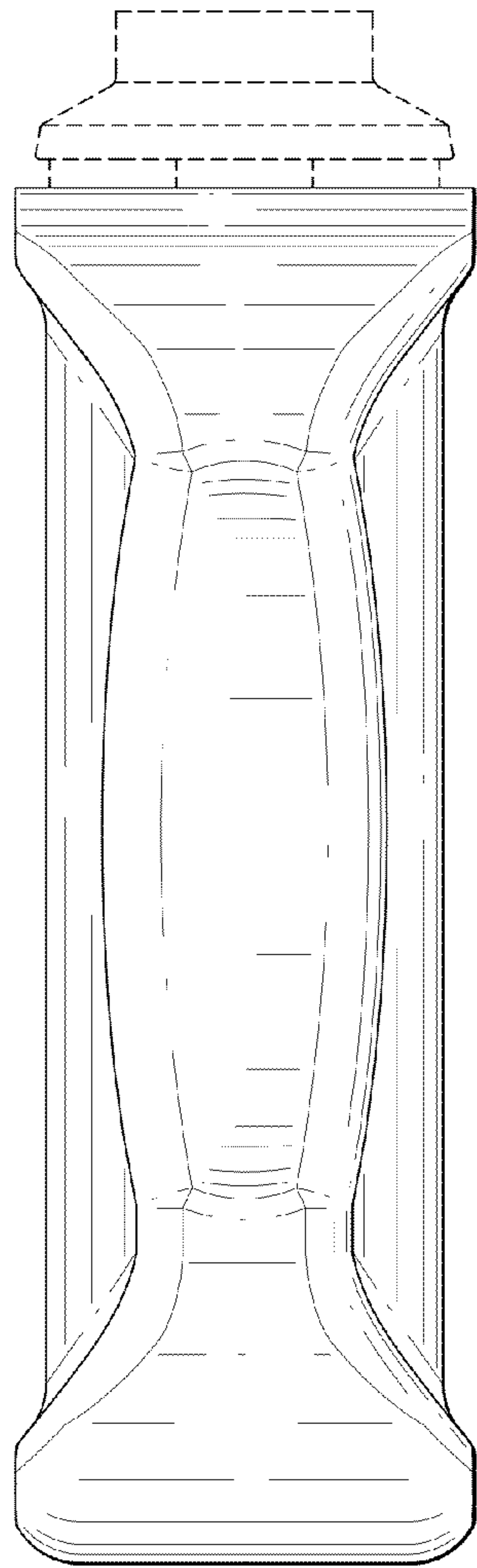

FIG. 18

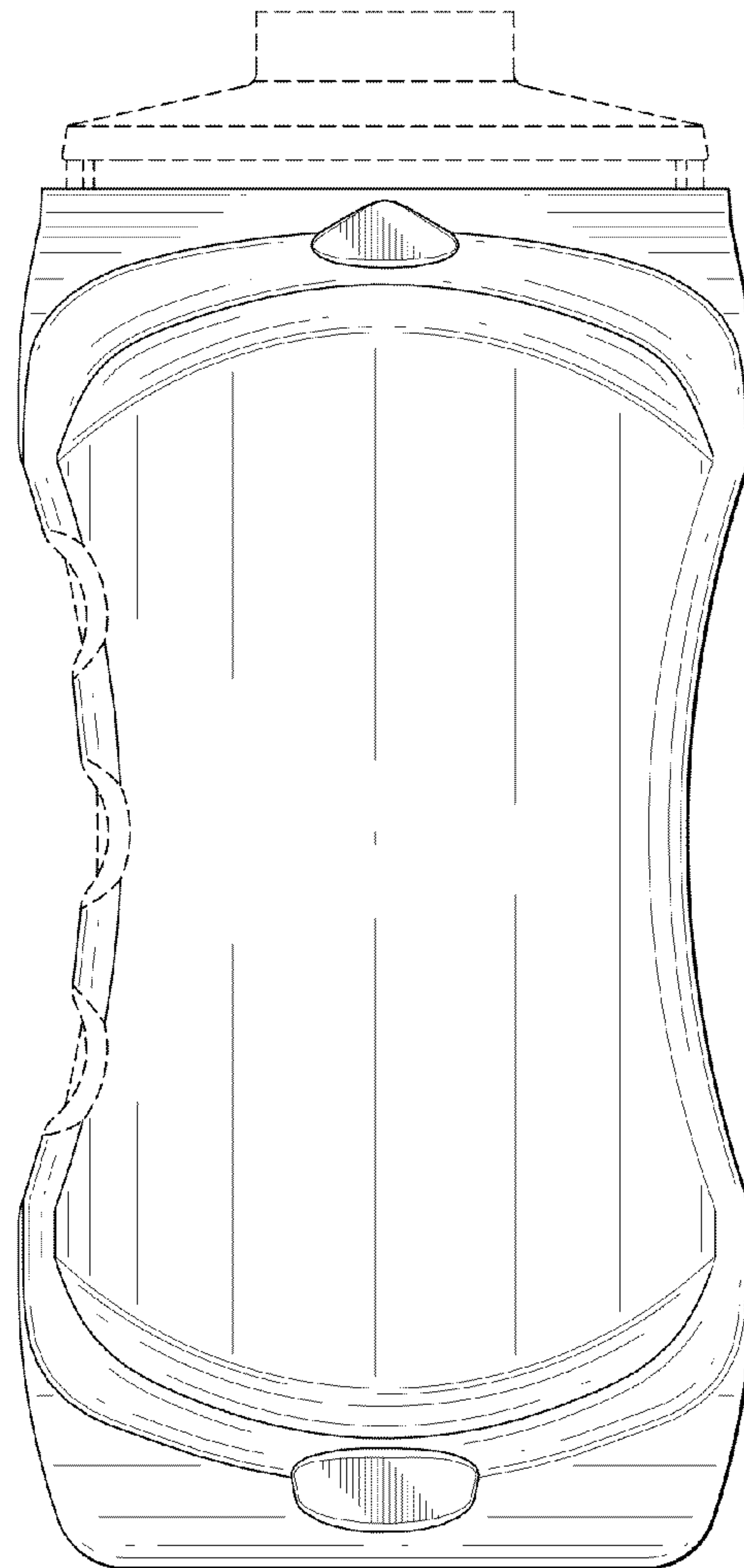

FIG. 19
Amended

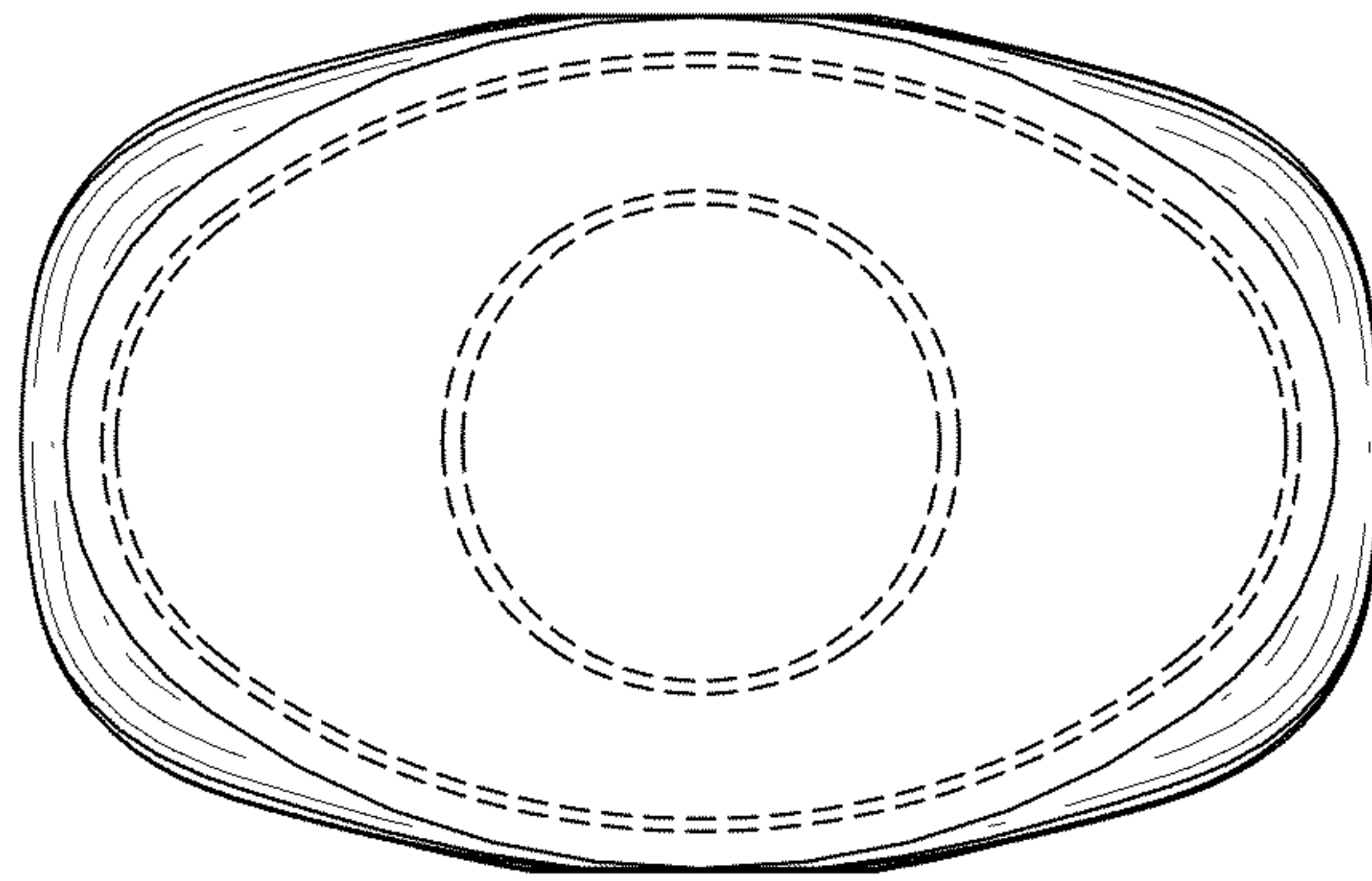

FIG. 20

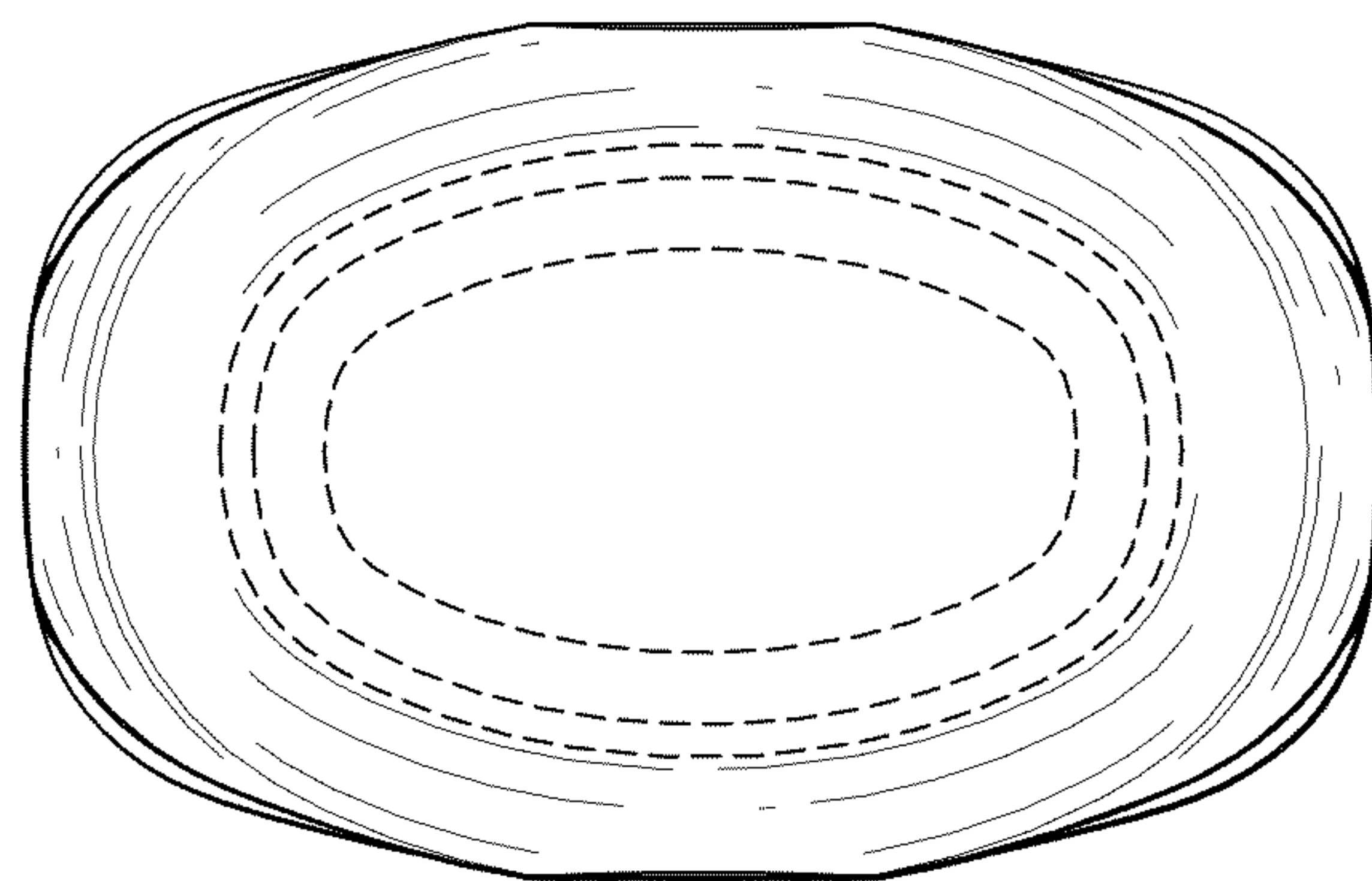

FIG. 21

Amended