

US00RE43529E

(19) **United States**
(12) **Reissued Patent**
Rozman et al.

(10) **Patent Number:** **US RE43,529 E**
(45) **Date of Reissued Patent:** ***Jul. 17, 2012**

(54) **SYSTEM AND METHOD FOR PROTECTING A COMPUTER SYSTEM FROM MALICIOUS SOFTWARE**

(76) Inventors: **Allen F. Rozman**, Garland, TX (US);
Alfonso J. Cioffi, Murphy, TX (US)

(*) Notice: This patent is subject to a terminal disclaimer.

(21) Appl. No.: **12/941,067**

(22) Filed: **Nov. 7, 2010**

5,673,403 A * 9/1997 Brown et al. 715/744
5,751,979 A * 5/1998 McCrory 715/803
5,826,013 A 10/1998 Nachenberg
5,918,039 A 6/1999 Buswell et al.
5,974,549 A * 10/1999 Golan 726/23
5,978,917 A 11/1999 Chi
5,995,103 A 11/1999 Ashe
6,091,412 A 7/2000 Simonoff et al.
6,108,715 A 8/2000 Leach et al.
6,134,661 A 10/2000 Topp
6,167,522 A 12/2000 Lee et al.
6,183,366 B1 2/2001 Goldberg et al.
6,192,477 B1 * 2/2001 Corthell 726/11

(Continued)

Related U.S. Patent Documents

Reissue of:

(64) Patent No.: **7,484,247**
Issued: **Jan. 27, 2009**
Appl. No.: **10/913,609**
Filed: **Aug. 7, 2004**

(51) **Int. Cl.**
G06F 11/00 (2006.01)
G06F 12/14 (2006.01)
G06F 12/16 (2006.01)
G08B 23/00 (2006.01)
G06F 15/173 (2006.01)
H04L 29/06 (2006.01)

(52) **U.S. Cl.** **713/152; 726/23; 726/24; 709/225**

(58) **Field of Classification Search** **713/152; 726/22-25**

See application file for complete search history.

(56) **References Cited**

U.S. PATENT DOCUMENTS

4,890,098 A 12/1989 Dawes et al.
5,280,579 A 1/1994 Nye
5,502,808 A 3/1996 Goddard et al.
5,555,364 A 9/1996 Goldstein
5,564,051 A * 10/1996 Halliwell et al. 1/1
5,666,030 A 9/1997 Parson

OTHER PUBLICATIONS

“Spyware, Adware, and Peer to Peer Networks; The Hidden Threat to Corporate Security” by Kevin Townsend, Pest Patrol, 2003.

(Continued)

Primary Examiner — Christian Laforgia

(74) *Attorney, Agent, or Firm* — Slater & Matsil, L.L.P.

(57) **ABSTRACT**

In a computer system, a first electronic data processor is communicatively coupled to a first memory space and a second memory space. A second electronic data processor is communicatively coupled the second memory space and to a network interface device. The second electronic data processor is capable of exchanging data across a network of one or more computers via the network interface device. A video processor is adapted to combine video data from the first and second electronic data processors and transmit the combined video data to a display terminal for displaying the combined video data in a windowed format. The computer system is configured such that a malware program downloaded from the network and executing on the second electronic data processor is incapable of initiating access to the first memory space.

45 Claims, 11 Drawing Sheets

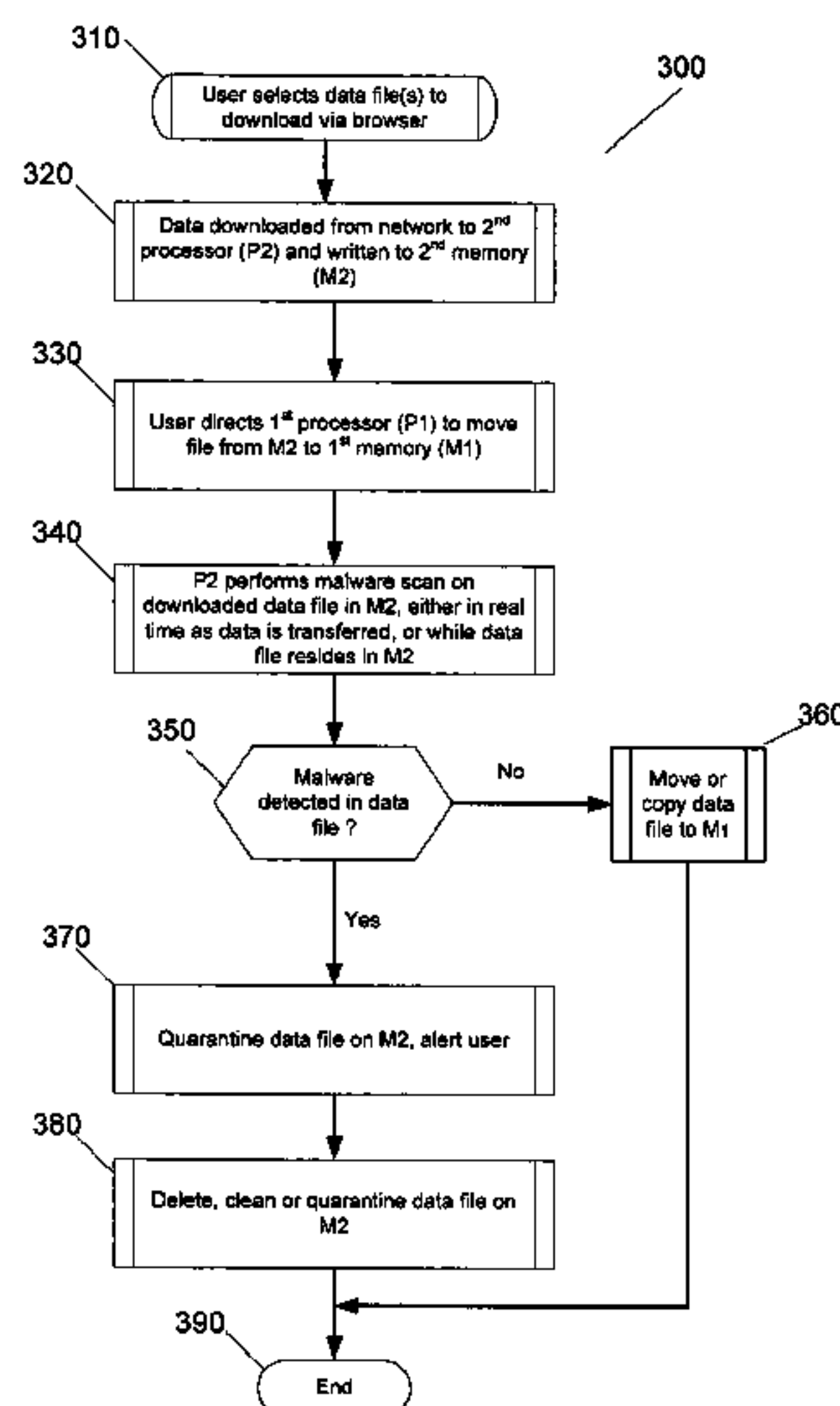

U.S. PATENT DOCUMENTS

6,199,181	B1 *	3/2001	Rechef et al.	714/38.13	2003/0221114	A1 *	11/2003	Hino et al.	713/189
6,216,112	B1	4/2001	Fuller et al.		2004/0006706	A1 *	1/2004	Erlingsson	713/200
6,275,938	B1	8/2001	Bond et al.		2004/0034794	A1	2/2004	Skrepetos	
6,285,987	B1	9/2001	Roth et al.		2004/0039944	A1 *	2/2004	Mayer et al.	
6,321,337	B1	11/2001	Reshef et al.		2004/0054588	A1	3/2004	Karasaki	713/201
6,351,816	B1	2/2002	Mueller et al.		2004/0199763	A1 *	10/2004	Jacobs et al.	
6,385,721	B1 *	5/2002	Puckette	713/2	2004/0230794	A1 *	11/2004	Freund	713/154
6,397,242	B1	5/2002	Devine et al.		2004/0267929	A1 *	12/2004	England et al.	713/164
6,401,134	B1	6/2002	Razavi et al.		2005/0005153	A1 *	1/2005	Xie	709/225
6,433,794	B1	8/2002	Beadle et al.		2005/0091661	A1 *	4/2005	Das et al.	713/200
6,438,600	B1	8/2002	Greenfield et al.		2005/0149726	A1 *	7/2005	Kurien et al.	719/310
6,480,198	B2	11/2002	Kang		2005/0149726	A1 *	7/2005	Joshi et al.	713/164
6,492,995	B1	12/2002	Atkin et al.		2005/0198692	A1 *	9/2005	Zurko et al.	726/24
6,505,300	B2	1/2003	Chan et al.		2005/0240810	A1	10/2005	Safford et al.	
6,507,904	B1	1/2003	Ellison et al.		2006/0004667	A1	1/2006	Neil	
6,507,948	B1	1/2003	Curtis et al.						
6,546,554	B1	4/2003	Schmidt et al.						
6,553,377	B1	4/2003	Eschelbeck et al.						
6,578,140	B1 *	6/2003	Policard	713/1					
6,581,162	B1	6/2003	Angelo et al.						
6,633,963	B1	10/2003	Ellison et al.						
6,658,573	B1	12/2003	Bischof et al.						
6,663,000	B1	12/2003	Muttik et al.						
6,678,712	B1 *	1/2004	McLaren et al.	718/100					
6,678,825	B1	1/2004	Ellison et al.						
6,691,230	B1	2/2004	Bardon						
6,735,700	B1	5/2004	Flint et al.						
6,754,815	B1 *	6/2004	Ellison et al.	713/1					
6,756,236	B2	6/2004	Ford et al.						
6,757,685	B2	6/2004	Raffaele et al.						
6,772,345	B1	8/2004	Shetty						
6,804,780	B1	10/2004	Touboul						
6,836,885	B1	12/2004	Buswell et al.						
6,871,348	B1 *	3/2005	Cooper	719/310					
6,873,988	B2	3/2005	Herrmann et al.						
6,880,110	B2	4/2005	Largman et al.						
6,990,630	B2	1/2006	Landsman et al.						
6,996,828	B1 *	2/2006	Kimura et al.	719/319					
7,013,484	B1 *	3/2006	Ellison et al.	726/26					
7,024,555	B2 *	4/2006	Kozuch et al.	726/22					
7,024,581	B1 *	4/2006	Wang et al.	714/2					
7,039,801	B2 *	5/2006	Narin	713/152					
7,062,672	B2	6/2006	Owhadi et al.						
7,082,615	B1 *	7/2006	Ellison et al.	726/26					
7,085,928	B1	8/2006	Schmid et al.						
7,096,381	B2	8/2006	Largman et al.						
7,139,890	B2	11/2006	Moran et al.						
7,146,305	B2 *	12/2006	van der Made	703/22					
7,146,640	B2 *	12/2006	Goodman et al.	726/16					
7,181,768	B1	2/2007	Ghosh et al.						
7,191,469	B2	3/2007	Erlingsson						
7,246,374	B1	7/2007	Simon et al.						
7,260,839	B2 *	8/2007	Karasaki	726/11					
7,284,274	B1	10/2007	Walls et al.						
7,373,505	B2	5/2008	Seltzer et al.						
7,401,230	B2	7/2008	Campbell et al.						
7,421,689	B2	9/2008	Ross et al.						
7,444,412	B2	10/2008	Owhadi						
7,484,247	B2 *	1/2009	Rozman et al.	726/34					
7,565,522	B2	7/2009	Sastry et al.						
7,577,871	B2	8/2009	Largman et al.						
7,596,694	B1	9/2009	Karp et al.						
7,650,493	B2 *	1/2010	Narin	713/152					
7,657,419	B2 *	2/2010	van der Made	703/22					
7,676,842	B2	3/2010	Carmona et al.						
7,694,328	B2	4/2010	Joshi et al.						
7,730,318	B2	6/2010	Kurien et al.						
7,818,808	B1 *	10/2010	Neiger et al.	726/26					
7,849,310	B2 *	12/2010	Watt et al.	713/164					
7,854,008	B1 *	12/2010	Huang et al.	726/24					
2002/0002673	A1 *	1/2002	Narin	713/152					
2002/0052809	A1 *	5/2002	Toedtli	705/28					
2002/0066016	A1	5/2002	Riordan						
2002/0174349	A1	11/2002	Wolff et al.						
2003/0023857	A1	1/2003	Hinchliffe et al.						
2003/0097591	A1	5/2003	Pham et al.						
2003/0131152	A1	7/2003	Erlingsson						
2003/0177397	A1	9/2003	Samman						

OTHER PUBLICATIONS

“Beyond Viruses: Why Anti-Virus Software is No Longer Enough” by David Stang PhD, Pest Patrol, 2002.

“The Web: Threat or Menace?” from “Firewalls and Internet Security: Repelling the Wily Hacker”, Second Edition, Addison-Wesley, ISBN 0-201-63466-X, 2003.

“Architecture of Virtual Machines” by R. P. Goldberg, Honeywell Information Systems, Inc. and Harvard University Presented at the AFIPS National Computer Conference, New York, New York, Jun. 4-8, 1973.

“The Duality of Memory and Communication in the Implementation of a Multiprocessor Operating System.” by Michael Young, Avadis Tevanian, Richard Rasheed, David Golub, Jeffery Eppinger, Jonathan Crew, William Bolosky, David Black and Robert Baron, Computer Science Department Carnegie-Mellon University Proceedings of the 11th Operating Systems Principles, Nov. 1987.

“Application-Controlled Physical Memory using External Page-Cache Management.” by Keiran Harty and David R. Cheriton, Computer Science Department, Stanford University, 1992.

“Efficient Software-Based Fault Isolation.” by Robert Wahbe, Steven Lucco, Thomas Anderson, Susan Graham, Computer Science Division University of California, Berkeley, SIGOPS 1993.

“TRON: Process-Specific File Protection for the UNIX Operating System.” by Andrew Berman, Virgil Bourassa, Erik Selberg, Department of Computer Science and Engineering, University of Washington, Jan. 23, 1995.

“A Secure Environment for Untrusted Helper Applications (Confining the Wily Hacker).” by Ian Goldberg, David Wagner, Randi Thomas, and Eric Brewer, Computer Science Division, University of California, Berkeley, Sixth USENIX UNIX Security Symposium San Jose, California, Jul. 1996.

“Building Systems that Flexibly Control Downloaded Executable Context.” by Trent Jaeger and Atul Prakash, Software Systems Research Lab, University of Michigan and Aviel D. Rubin, Security Research Group, Bellcore Sixth USENIX UNIX Security Symposium San Jose, California, Jul. 1996.

“Java Security: From HotJava to Netscape and Beyond.” by Drew Dean, Edward W. Felten, Dan S. Wallach Department of Computer Science, Princeton University, Princeton, NJ 08544 1996 IEEE Symposium on Security and Privacy, Oakland, CA, May 6-8, 1996.

“A Sandbox Operating System Environment for Controlled Execution of Alien Code.” by Asit Dan, Ajay Mohindra, Rajiv Ramaswami, and Dinkar Sitaram IBM Research Division T.J. Watson Research Center Yorktown Heights, New York RC 20742 (Feb. 20, 1997) Computer Science IBM Research Report.

“Vulnerability of Secure Web Browsers.” by Flavio De Paoli, Andre Dos Santos, Richard Kemmerer Reliable Software Group Computer Science Department, University of California, Santa Barbara, 1997.

“Security of Web Browser Scripting Languages: Vulnerabilities, Attacks, and Remedies.” by Vinod Anupam and Alain Mayer, Bell Laboratories, Lucent Technologies 7th USENIX Security Symposium San Antonio, Texas, Jan. 26-29, 1998.

“Virtual Memory in Contemporary Microprocessors.” by Bruce Jacob University of Maryland and Trevor Mudge University of Michigan, IEEE MICRO Jul.-Aug. 1998.

“Flexible Control of Downloaded Executable Content.” by Trent Jaeger and Jochen Liedtke and Nayeem Islam, IBM Thomas J.

- Watson Research Center, and Atul Prakash University of Michigan, Ann Arbor ACM Transactions on Information and System Security, vol. 2, No. 2, May 1999, pp. 177-228.
- “J2ME Building Blocks for Mobile Devices: White Paper on KVM and the Connected, Limited Device Configuration.” Sun Microsystems May 19, 2000.
- “User-level Resource-constrained Sandboxing” by Fangzhe Chang, Ayal Itzkovitz, and Vijay Karamcheti Department of Computer Science, Courant Institute of Mathematical Sciences, New York University USENIX Windows System Symposium, Aug. 2000.
- “Verifying the EROS Confinement Mechanism” by Jonathan S. Shapiro and San Weber IBM T.J. Watson Research Center 0-7695-0665-8/00 2000 IEEE.
- “WindowBox: A Simple Security Model for the Connected Desktop” by Dirk Balfanz, Princeton University and Daniel R. Simon, Microsoft Research, 2000.
- “Building a Secure Web Browser” by Sotiris Ioannidis, Steven M. Bellovin, 2001 USENIX Annual Technical Conference Boston, Massachusetts, USA Jun. 25-30, 2001.
- “Virtualizing I/O Devices on VMware Workstation’s Hosted Virtual Machine Monitor” by Jeremy Sugerman, Ganesh Venkitachalam and Beng-Hong Lim, VMware, Inc. 3145 Porter Dr, Palo Alto, CA 94304 2001 USENIX Annual Technical Conference Boston, Massachusetts, USA Jun. 25-30, 2001.
- “When Virtual Is Better Than Real” by Peter M. Chen and Brian D. Noble, Department of Electrical Engineering and Computer Science University of Michigan, 2001.
- “A Flexible Containment Mechanism for Executing Untrusted Code” by David Peterson, Matt Bishop, and Raju Pandey, Department of Computer Science University of California, Davis USENIX Security Symposium San Francisco, California, USA Aug. 5-9, 2002.
- “Software Security and Privacy Risks in Mobile E-Commerce” by Anup K. Ghosh and Tara M. Swaminatha, Communications of the ACM Feb. 2001 vol. 44, No. 2.
- “ReVirt: Enabling Intrusion Analysis through Virtual-Machine Logging and Replay” by George W. Dunlap, Samuel T. King, Sukru Cinar, Murtaza A. Basrai, Peter M. Chen, Department of Electrical Engineering and Computer Science, University of Michigan Proceedings of the 2002 Symposium on Operating Systems Design and Implementation (OSDI).
- “Trusted Paths for Browsers: An Open-Source Solution to Web Spoofing” by Zishuang (Eileen) Ye and Sean Smith Department of Computer Science Dartmouth College Technical Report TR2002-418 Feb. 4, 2002.
- “User Interaction Design for Secure Systems” by Ka-Ping Yee Proceedings of the 4th International Conference on Information and Communications Security table of contents pp. 278-290, 2002, ISBN:3-540-00164-6.
- Marc Stiegler and Mark Miller, Report Name: “A Capability Based Client: The Darpa Browser” Combex/Focused Research Topic 5/BAA-00-06-SNK, Nov. 18, 2002.
- “A Virtual Machine Introspection Based Architecture for Intrusion Detection” by Tal Garfinkel and Mendel Rosenblum, Computer Science Department, Stanford University 2003.
- “Terra: A Virtual Machine-Based Platform for Trusted Computing” by Tal Garfinkel, Ben Pfaff, Jim Chow, Dan Boneh and Mendel Rosenblum, Computer Science Department, Stanford University SOSP’03, Oct. 19-22, 2003, Bolton Landing, New York, USA.
- Microsoft® Virtual PC 2004 Technical Overview by Jerry Honeycutt Published Nov. 2003 http://download.microsoft.com/download/c/f/b/cfb100a7-463d-4b86-ad62-064397178b4f/Virtual_PC_Technical_Overview.doc.
- “Xen and the Art of Virtualization” by Paul Barham, Boris Dragovic, Keir Fraser, Steven Hand, Tim Harris, Alex Ho, Rolf Neugebaurey, Ian Pratt, Andrew Warfield University of Cambridge Computer Laboratory 15 JJ Thomson Avenue, Cambridge, UK, CB3 0FD SOSP’03, Oct. 19-22, 2003, Bolton Landing, New York, USA.
- “Design of the EROS Trusted Window System” by Jonathan S. Shapiro, John Vanderburgh, Eric Northrup, Systems Research Laboratory Johns Hopkins University, and, David Chizmadia, Promia, Inc. 2004.
- “Survey of System Virtualization Techniques.” by Robert Rose Mar. 8, 2004.
- White Paper: “Smart Phone Security Issues” by Luc Delpha and Maliha Rasheed, Cyber Risk Consulting Blackhat Briefings Europe May 2004.
- T. Jaeger, A. D. Rubin, and A. Prakash. “Building systems that flexibly control downloaded executable content.” In Proceedings of the 1996 USENIX Security Symposium, pp. 131-148, San Jose, CA., 1996.
- Nimisha V. Mehta, Karen R. Sollins, “Expanding and Extending the Security Features of Java.” Proceedings of the 7th USENIX Security Symposium, San Antonio, Texas, Jan. 26-29, 1998.
- David A. Wagner, “Janus: an approach for confinement of untrusted applications.” Master’s thesis, University of California, Berkeley, 1999.. Also available, Technical Report CSD-99/1056, UC Berkeley, Computer Science Division. <http://www.cs.berkeley.edu/~daw/papers/janus-masters.ps>.
- Richard West and Jason Gloudon, “User-Level Sandboxing: a Safe and Efficient Mechanism for Extensibility”, Technical Report, 2003-014, Boston University, Jun. 2003.
- Shaya Potter, Jason Nieh, Dinesh Subhraveti, “Secure Isolation and Migration of Untrusted Legacy Applications.” Columbia University Technical Report CUCS-005-04, Jan. 2004.
- M. Schmid, F. Hill, A. Ghosh, “Protecting Data from Malicious Software.” Annual Computer Security Applications Conference (ACSAC’02), Las Vegas, NV, Dec. 2002.
- Valentin Razmov “Security in Untrusted Code Environments: Missing Pieces of the Puzzle.” Dept. of Computer Science and Engineering, University of Washington, Mar. 30, 2002.
- Sotiris Ioannidis and Steven M. Bellovin. “Sub-Operating Systems: A New Approach to Application Security.” Technical Report MS-CIS-01-06, University of Pennsylvania, Feb. 2000.
- Kevin Townsend; “Spyware, Adware, and Peer to Peer Networks; The Hidden Threat to Corporate Security” © Pest Patrol, 2003.
- David Stang, PhD; “Beyond Viruses: Why Anti-Virus Software is No Longer Enough”, © Pest Patrol 2002.
- “The Web: Threat or Menace?” From “Firewalls and Internet Security: Repelling the Wiley Hacker”, Second Edition, Addison-Wesley, ISBN 0-201-63466-X, 2003 ©.

* cited by examiner

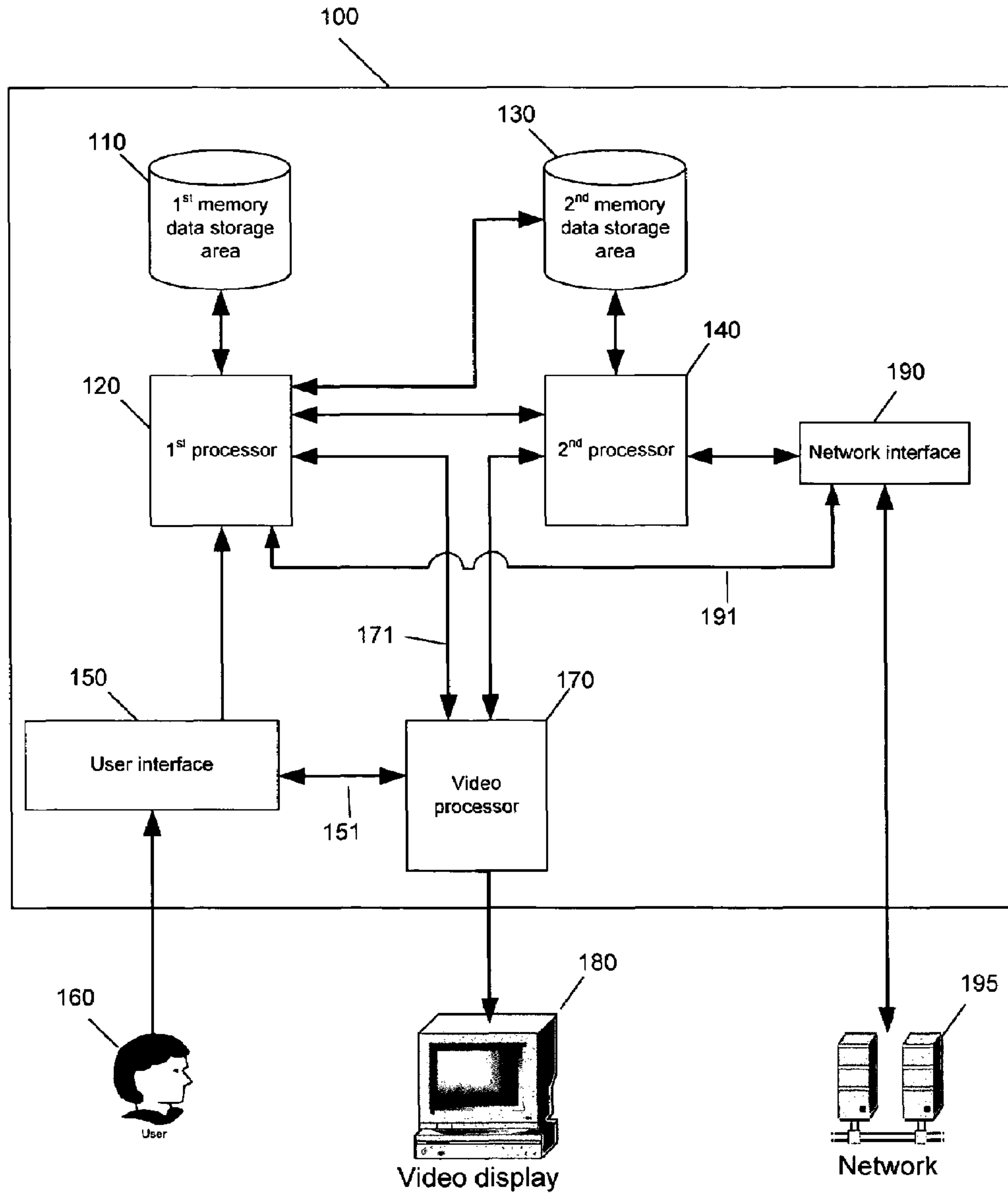

Fig. 1

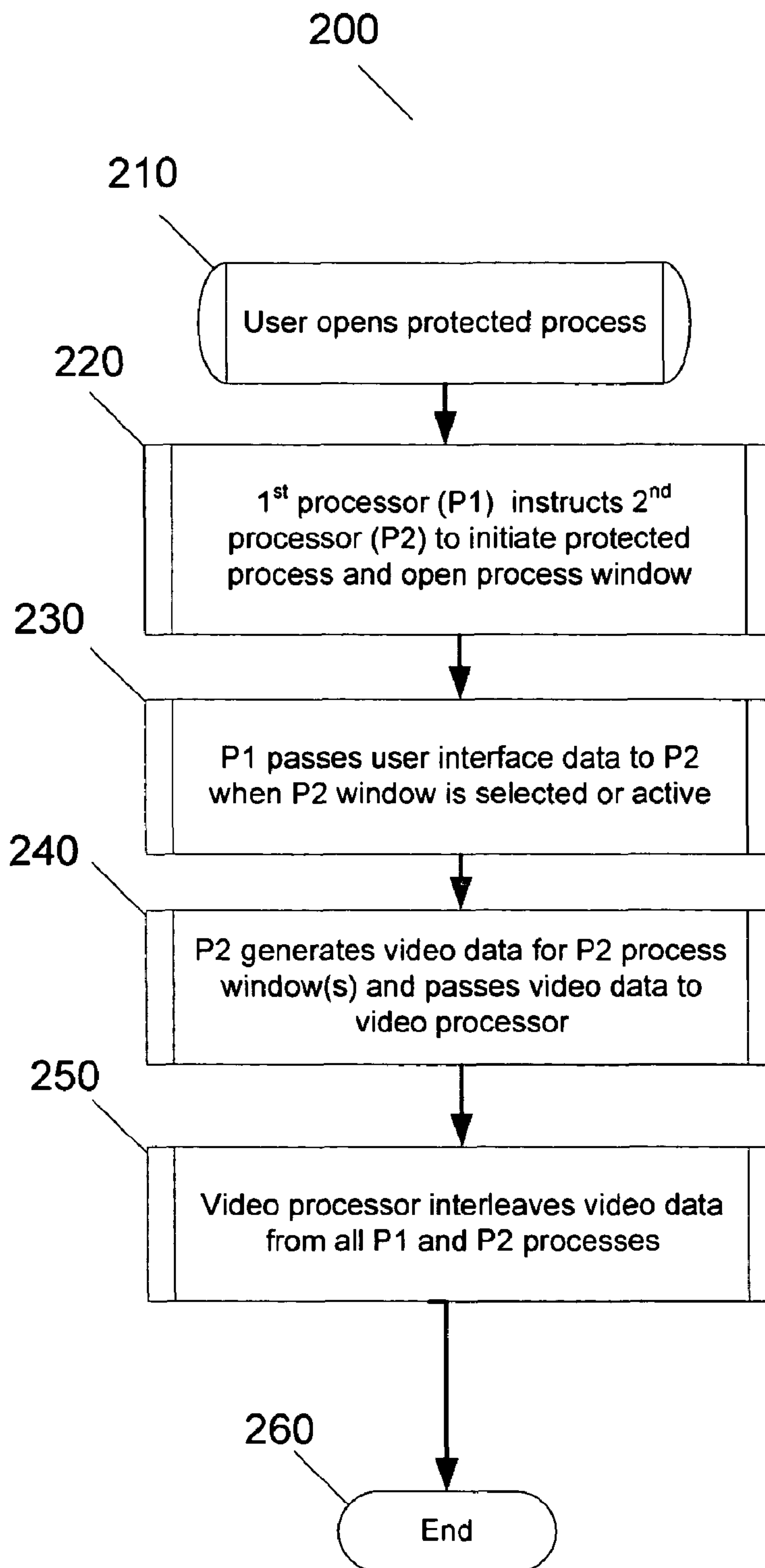

Fig. 2

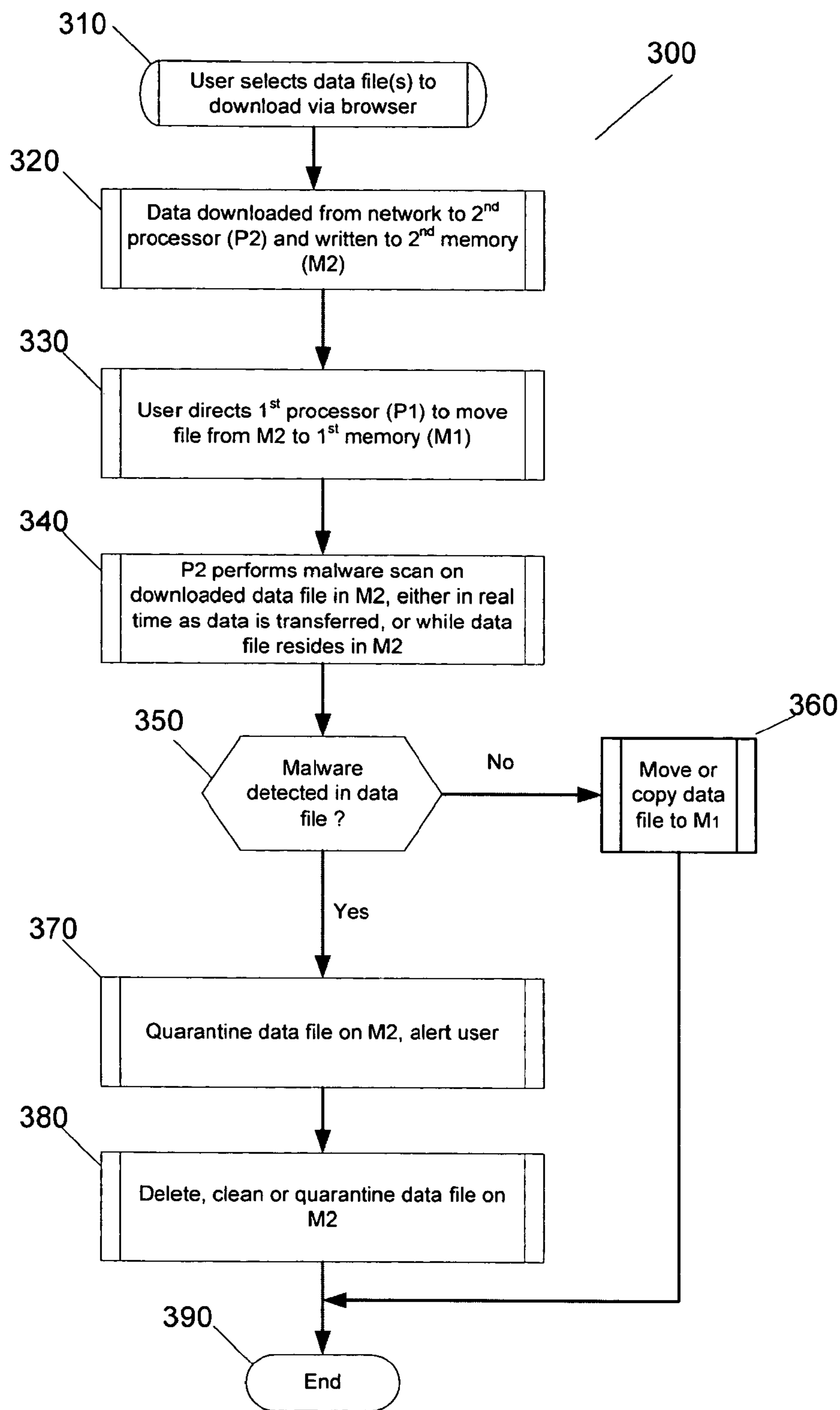

Fig. 3

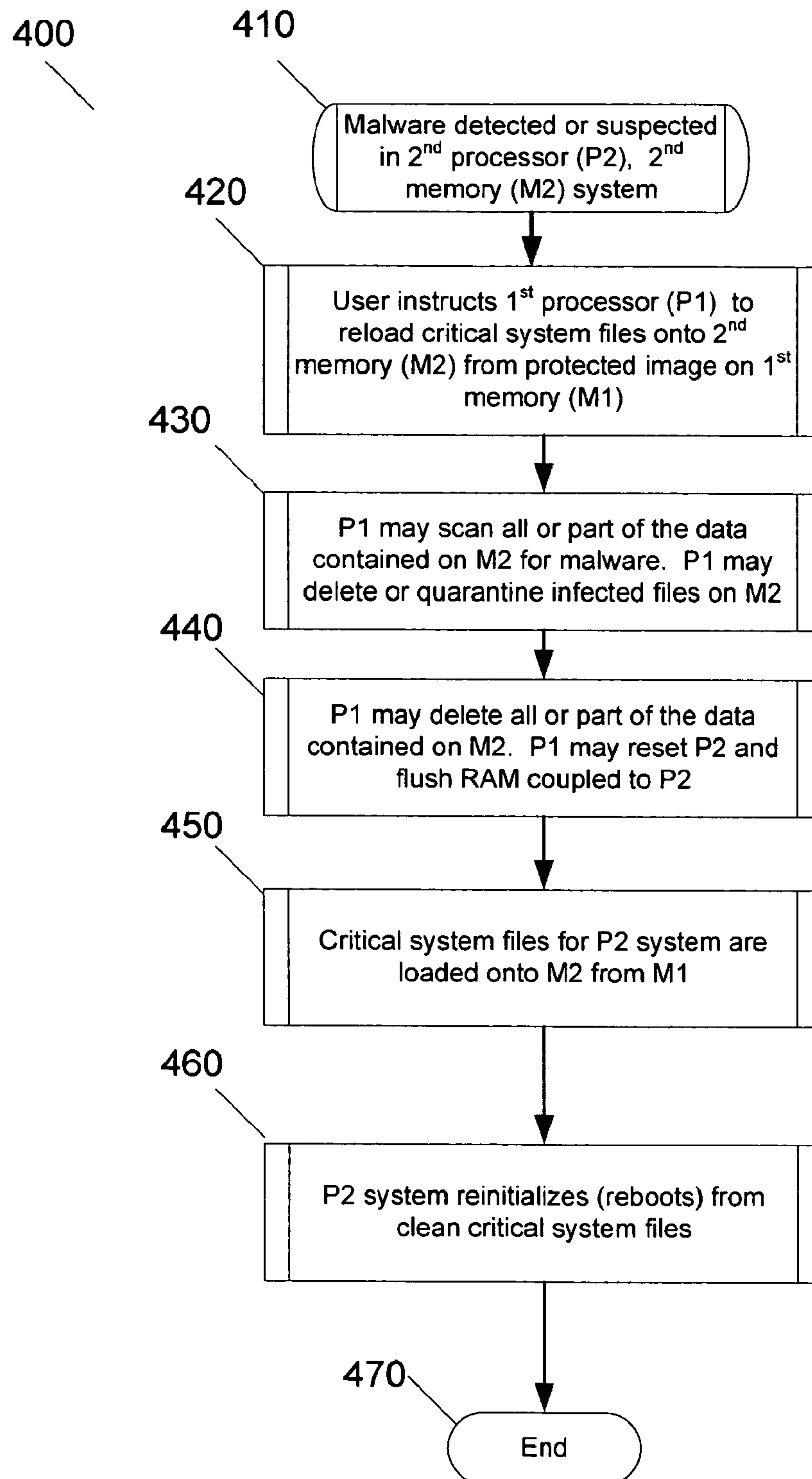

Fig. 4

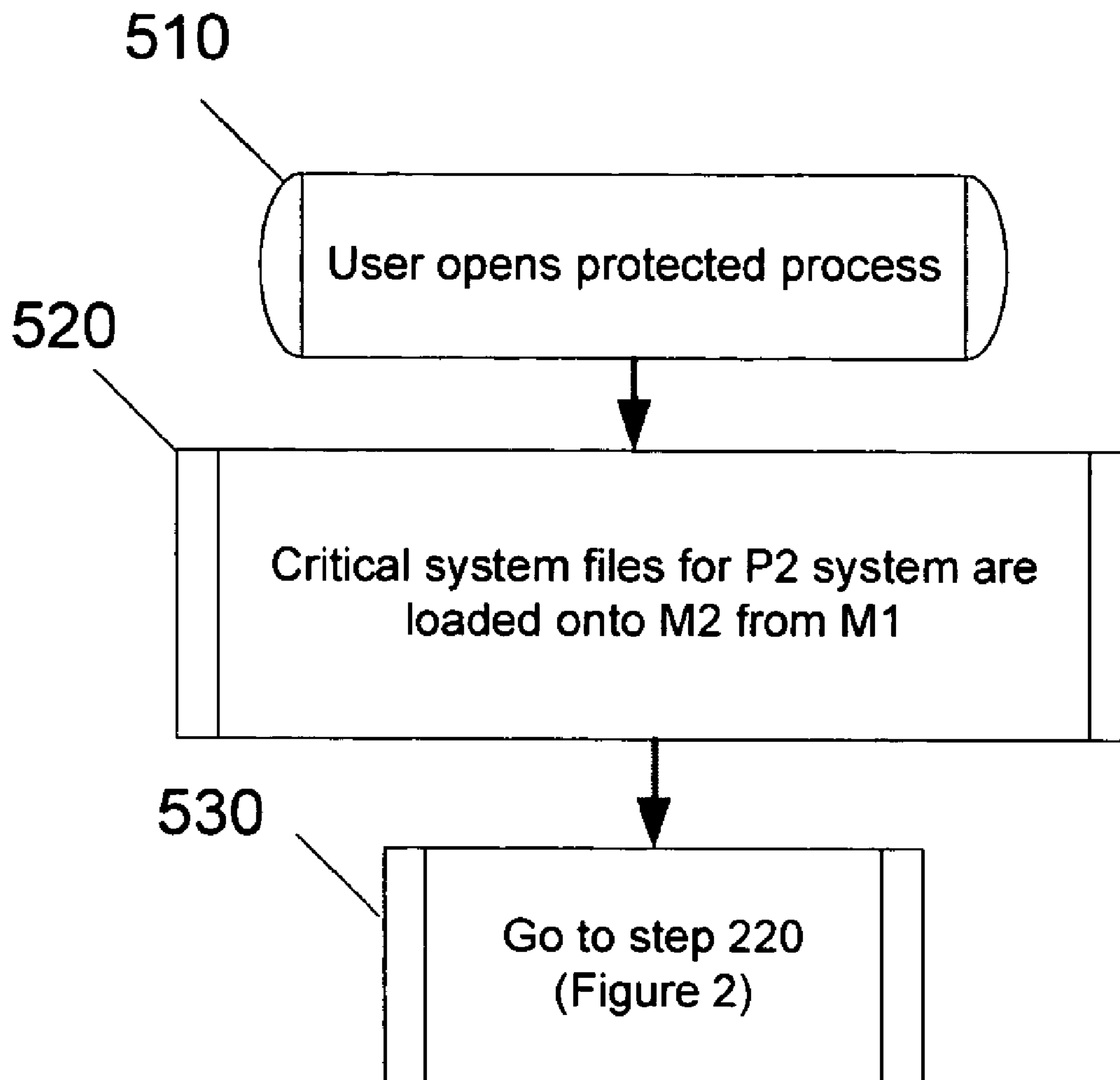

Fig. 5A

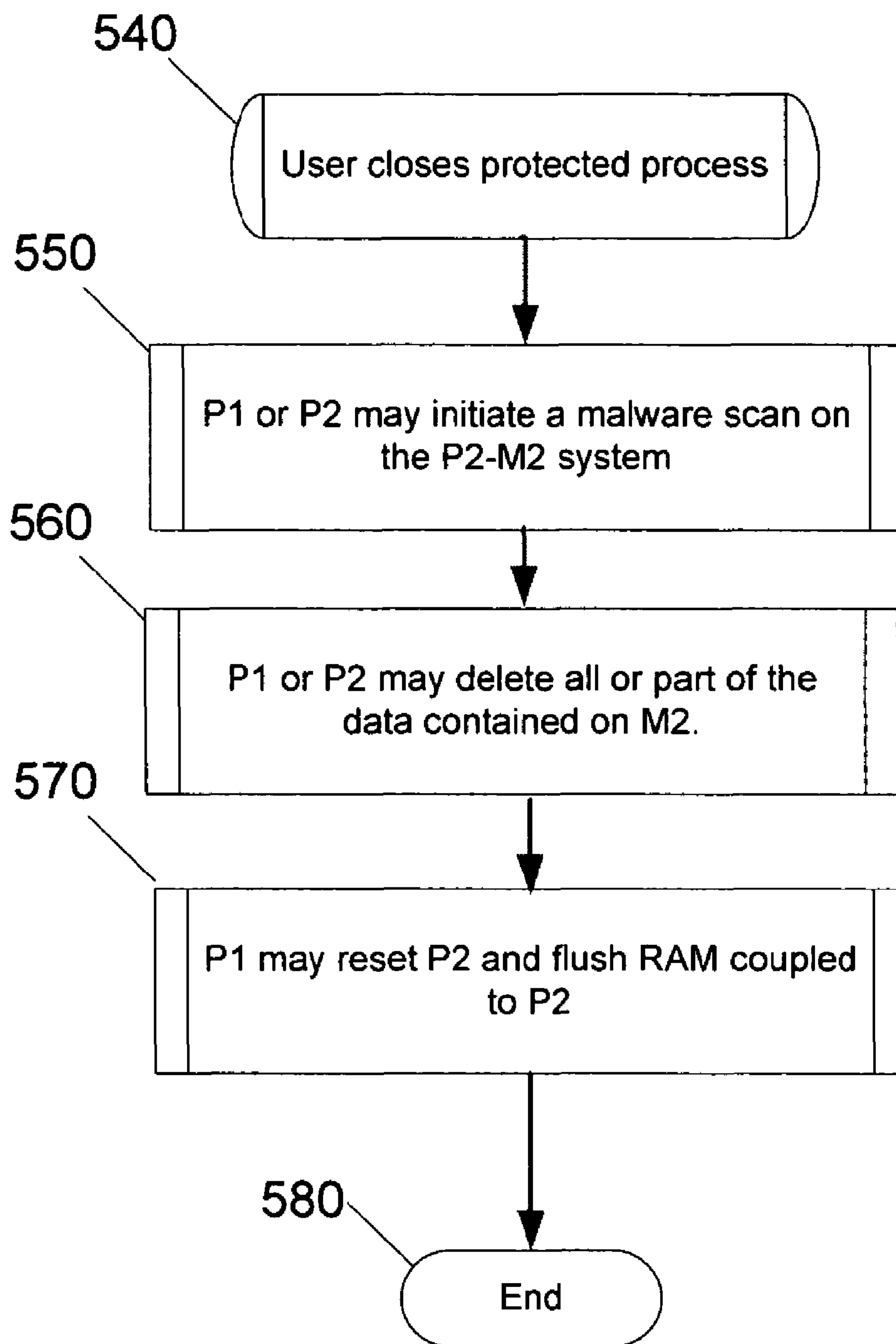

Fig. 5B

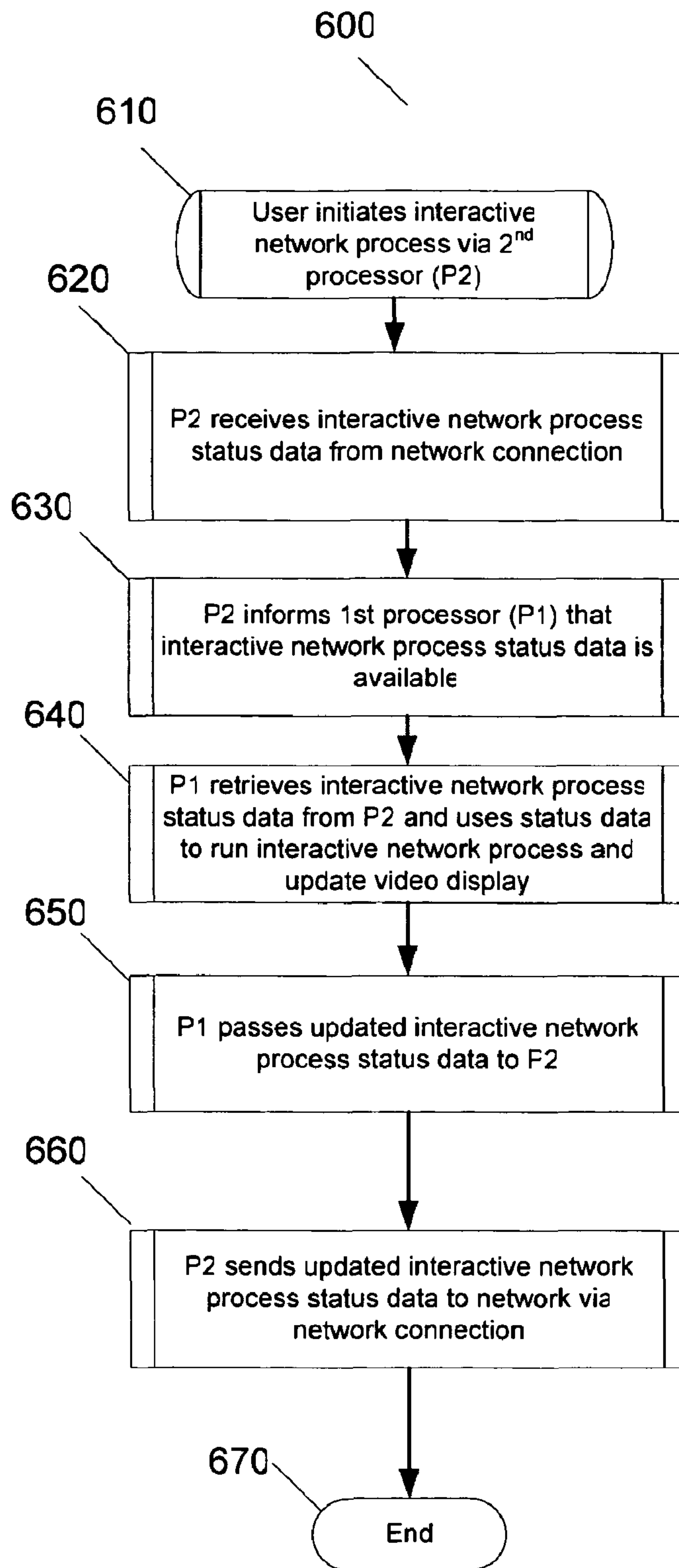

Fig. 6

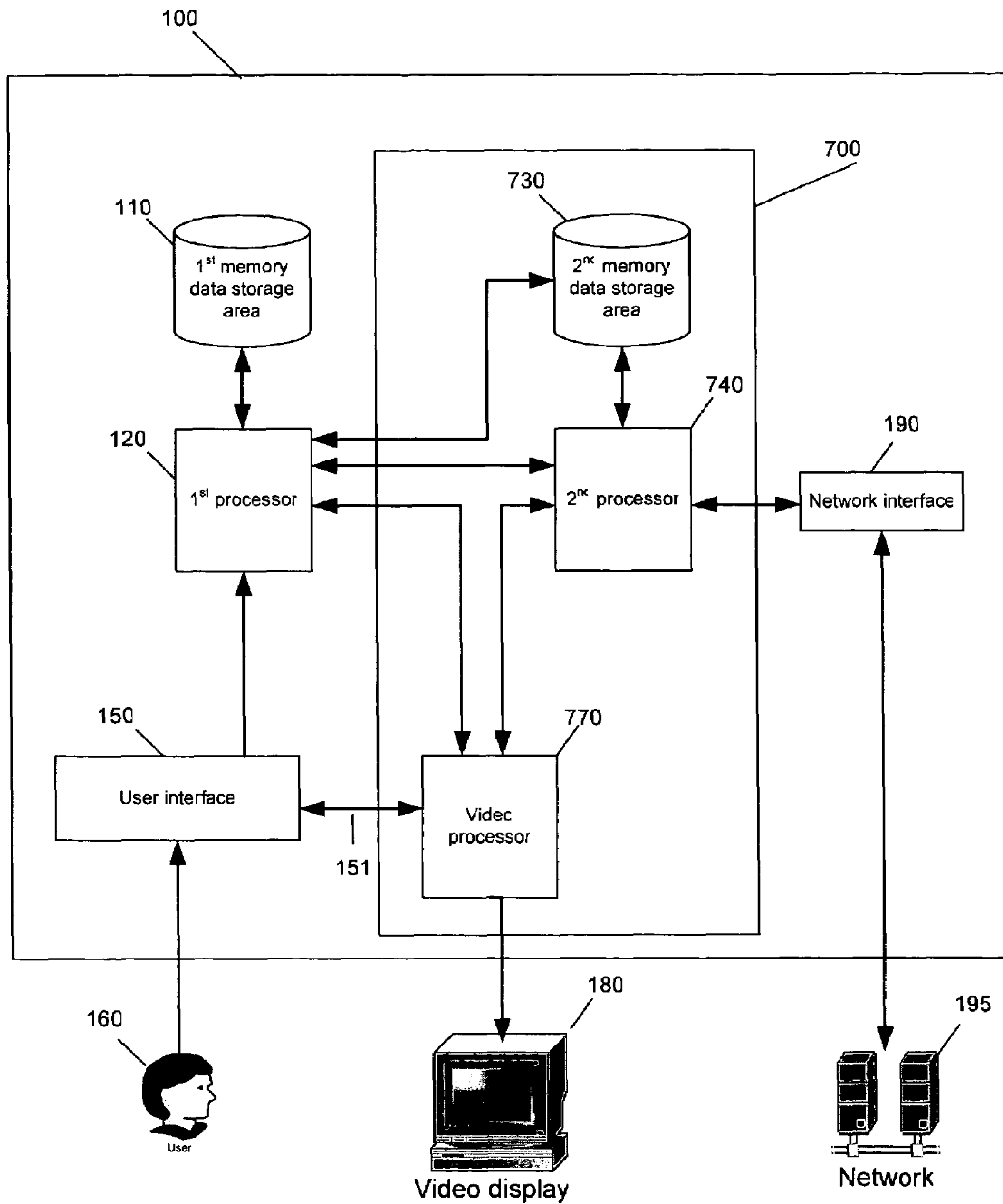

Fig. 7

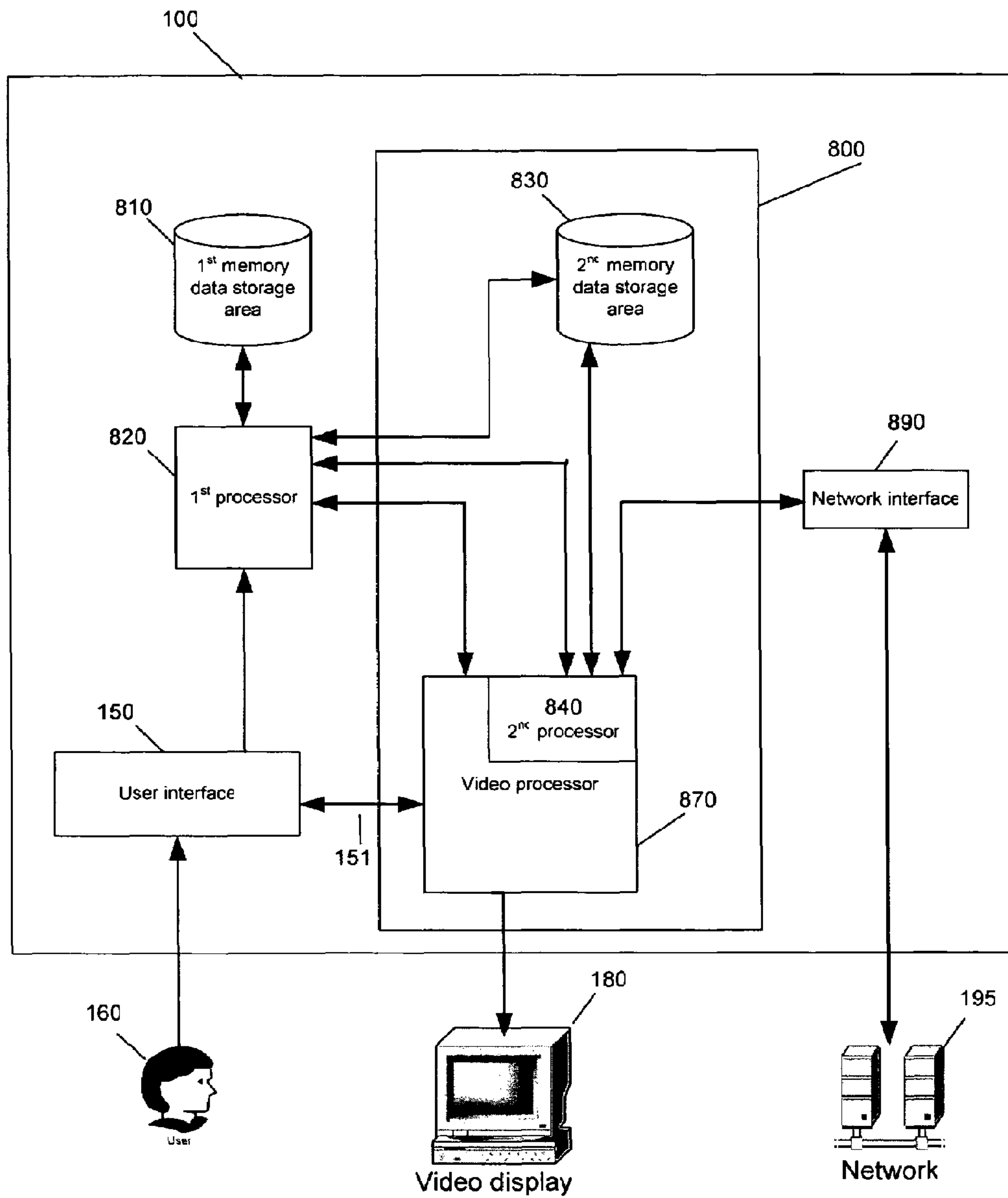

Fig 8

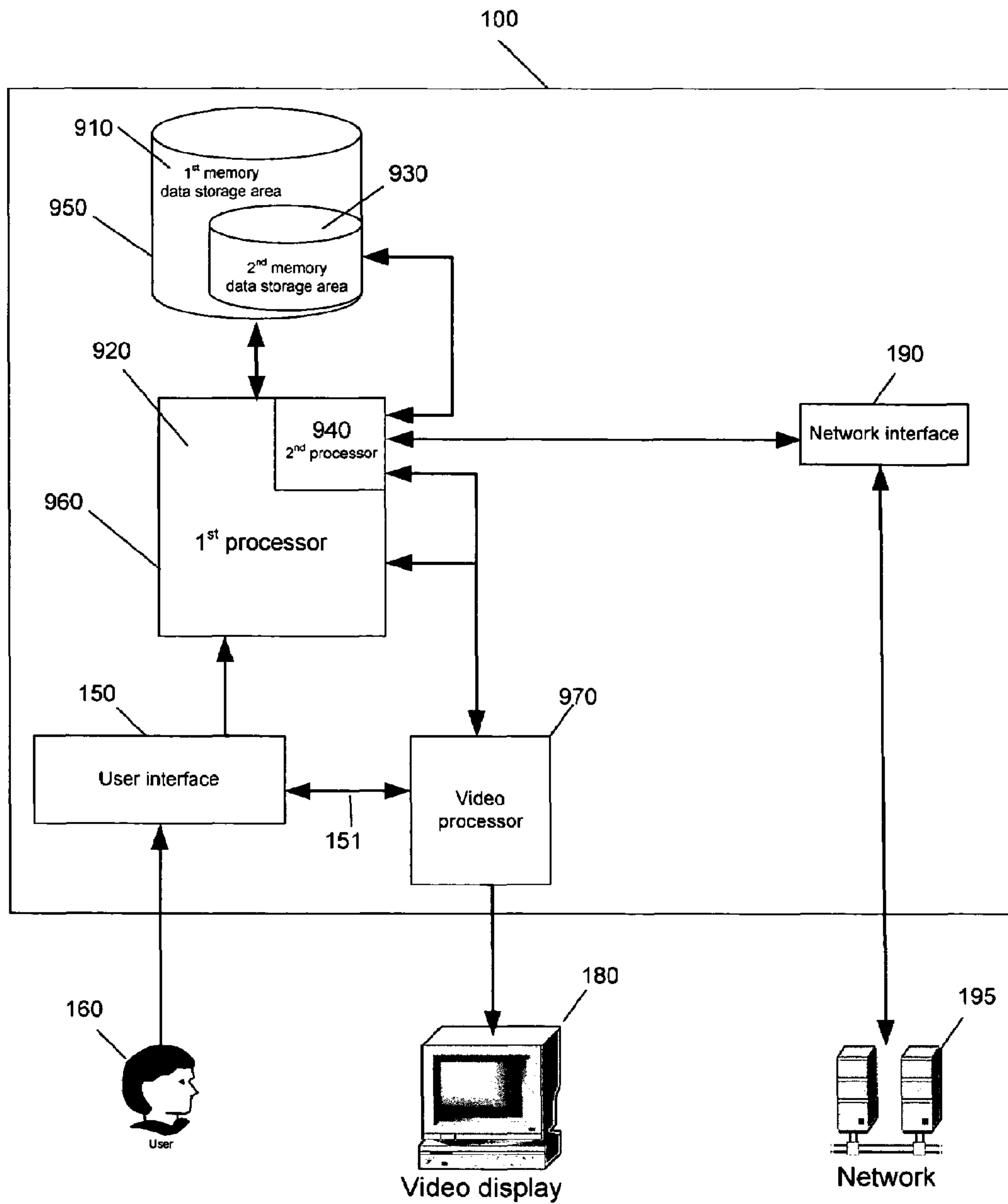

Fig. 9

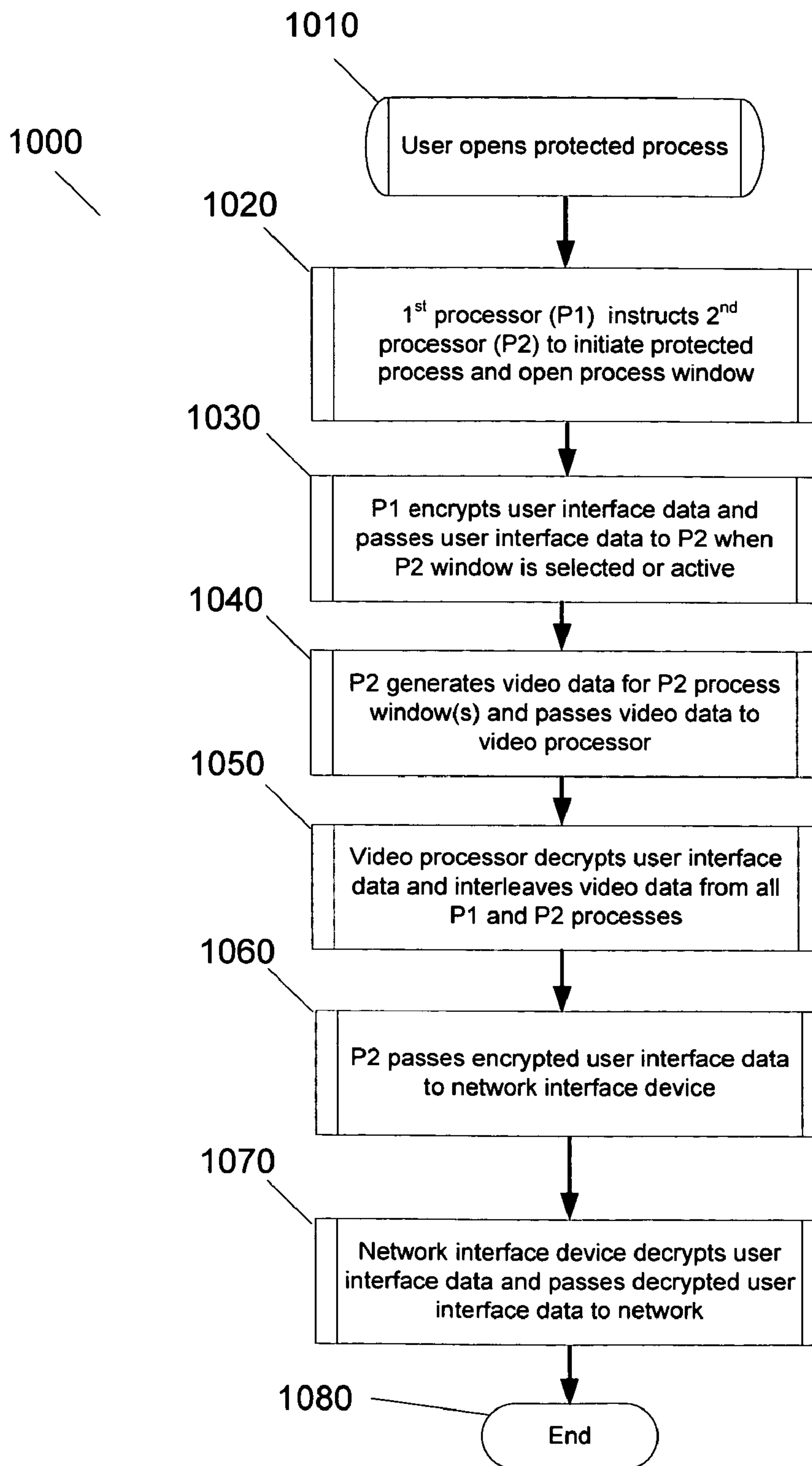

Fig. 10

**SYSTEM AND METHOD FOR PROTECTING
A COMPUTER SYSTEM FROM MALICIOUS
SOFTWARE**

Matter enclosed in heavy brackets [] appears in the original patent but forms no part of this reissue specification; matter printed in italics indicates the additions made by reissue.

*CROSS REFERENCE TO MULTIPLE REISSUE
APPLICATIONS*

This application is a reissue application of U.S. Pat. No. 7,484,247, entitled "System and Method for Protecting a Computer System from Malicious Software," issued on Jan. 27, 2009, and is related to reissue applications designated U.S. patent application Ser. No. 12/720,147 from U.S. Pat. No. 7,484,247, and U.S. patent application Ser. No. 12/720,207 from U.S. Pat. No. 7,484,247, both filed on Mar. 9, 2010, and is also related to reissue application designated U.S. patent application Ser. No. 12/854,149 (now, U.S. Pat. No. Re. 43,103) from U.S. Pat. No. 7,484,247, filed on Aug. 10, 2010 and a continuation application therefrom designated U.S. patent application Ser. No. 13/015,186, filed on Jan. 27, 2011. All of the above reissue applications are incorporated herein by reference.

TECHNICAL FIELD

The present invention relates generally to computer hardware and software, and more particularly to a system and method for protecting a computer system from malicious software.

CROSS REFERENCE TO RELATED PATENTS
AND APPLICATIONS

This application is related to the following U.S. patents and applications:

U.S. patent or PUB Application Number	Title	Inventor(s)
5,826,013	Polymorphic virus detection module.	Nachenberg
5,978,917	Detection and elimination of macro viruses.	Chi
6,735,700	Fast virus scanning using session stamping.	Flint, et al
6,663,000	Validating components of a malware scanner.	Muttik, et al.
6,553,377	System and process for maintaining a plurality of remote security applications using a modular framework in a distributed computing environment.	Eschelbeck, et al.
6,216,112	Method for software distribution and compensation with replenishable advertisements.	Fuller, et al.
4,890,098	Flexible window management on a computer display.	Dawes, et al.
5,555,364	Windowed computer display.	Goldstein
5,666,030	Multiple window generation in computer display.	Parson
5,995,103	Window grouping mechanism for creating, manipulating and displaying windows and window groups on a display screen of a computer system.	Ashe
5,502,808	Video graphics display system with adapter for display management based upon plural memory sources.	Goddard, et al.

-continued

U.S. patent or PUB Application Number	Title	Inventor(s)	
5,280,579	Memory mapped interface between host computer and graphics system.	Nye	
5,918,039	Method and apparatus for display of windowing application programs on a terminal.	Buswell, et al	
6,480,198	Multi-function controller and method for a computer graphics display system.	Kang	
6,167,522	Method and apparatus for providing security for servers executing application programs received via a network	Lee, et al.	
6,199,181	Method and system for maintaining restricted operating environments for application programs or operating systems.	Rechef, et al.	
6,275,938	Security enhancement for untrusted executable code.	Bond, et al.	
6,321,337	Method and system for protecting operations of trusted internal networks.	Reschef, et al.	
6,351,816	System and method for securing a program's execution in a network environment.	Mueller, et al.	
6,546,554	Browser-independent and automatic apparatus and method for receiving, installing and launching applications from a browser on a client computer.	Schmidt, et al.	
6,658,573	Protecting resources in a distributed computer system.	Bischof, et al	
6,507,904	Executing isolated mode instructions in a secure system running in privilege rings.	Ellison, et al.	
6,633,963	Controlling access to multiple memory zones in an isolated execution environment.	Ellison, et al.	
6,678,825	Controlling access to multiple isolated memories in an isolated execution environment.	Ellison, et al.	
5,751,979	Video hardware for protected, multiprocessing systems.	McCrary	
6,581,162	Method for securely creating, storing and using encryption keys in a computer system.	Angelo, et al.	
6,134,661	Computer network security device and method.	Topp	
6,578,140	Personal computer having a master computer system and in internet computer system and monitoring a condition of said master and internet computer systems	Policard	
45	PUB Application # 20040054588	E-mail software and method and system for distributing advertisements to client devices that have such e-mail software installed thereon.	Jacobs, Paul E., et al.
50	PUB Application # 20040034794	System and method for comprehensive general generic protection for computers against malicious programs that may steal information and/or cause damages	Mayer, Yaron; et al.
55	PUB Application # 20040006715	System and method for providing security to a remote computer over a network browser interface.	Skrepetos, Nicholas C.
55	PUB Application # 20030177397	Virus protection in an internet environment.	Samman, Ben
55	PUB Application # 20030097591	System and method for protecting computer users from web sites hosting computer viruses.	Pham, Khai; et al.
60	PUB Application # 20030023857	Malware infection suppression.	Hinchliffe, Alexander James; et al.
60	PUB Application # 20020066016	Access control for computers.	Riordan, James
65	PUB Application # 20020174349	Detecting malicious alteration of stored computer files.	Wolff, Daniel Joseph; et al.

The above-listed U.S. Patents and U.S. patent applications are incorporated by reference as if reproduced herein in their entirety.

BACKGROUND

The very popular and ubiquitous rise of the 'personal' computer system as an essential business tool and home appliance, together with the exponential growth of the Internet as a means of providing information flows across a wide variety of connected computing devices, has changed the way people live and work. Information in the form of data files and executable software programs regularly flows across the planetary wide system of interconnected computers and data storage devices.

Popular and ubiquitous computer hardware and software architectures have typically been designed to allow for open interconnection via, for example, the internet, a VPN, a LAN, or a WAN, with information often capable of being freely shared between the interconnected computers. This open interconnection architecture has contributed to the adoption and mainstream usage of these computers and the subsequent interconnection of vast networks of computers. This easy to use system has given rise to the explosive popularity of applications such as email, internet browsing, search engines, interactive gaming, instant messaging, and many, many more.

Although there are definite benefits to this open interconnection architecture, a lack of security against unwanted incursions into the computers main processing and non-volatile memory space has emerged as a significant problem. An aspect of some current computer architectures that has contributed to the security problem is that by default programs are typically allowed to interact with and/or alter other programs and data files, including critical operating system files, such as the windows registry, for example. Current open interconnection architectures have opened the door to a new class of unwanted malicious software generally known as malware. This malware is capable of infiltrating any computer system which is connected to a network of interconnected computer systems. Malware is comprised of, but not limited to, classes of software files known as viruses, worms, Trojan horses, browser hijackers, adware, spyware, pop-up windows, data miners, etc. Such malware attacks are capable of stealing data by sending user keystrokes or information stored on a user's computer back to a host, changing data or destroying data on personal computers and/or servers and/or other computerized devices, especially through the Internet. In the least, these items represent a nuisance that interferes with the smooth operation of the computer system, and in the extreme, can lead to the unauthorized disclosure of confidential information stored on the computer system, significant degradation of computer system performance, or the complete collapse of computer system function.

Malware has recently become much more sophisticated and much more difficult for users to deal with. Once resident on a computer system, many malware programs are designed to protect themselves from deletion. For example, some malware programs comprise a pair of programs running simultaneously, with each program monitoring the other for deletion. If one of the pair of programs is deleted, the other program installs a replacement within milliseconds. In another example, some malware will run as a Windows program with a .dlls extension, which Windows may not allow a user to delete while it is executing. Malware may also reset a user's browser home page, change browser settings, or hijack search requests and direct such requests to another page or search engine. Further, the malware is often designed to

defeat the user's attempts to reset the browser settings to their original values. In another example, some malware programs secretly record user input commands (such as keystrokes), then send the information back to a host computer. This type of malware is capable of stealing important user information, such as passwords, credit account numbers, etc.

Many existing computers rely on a special set of instructions which define an operating system (O/S) in order to provide an interface for computer programs and computer components such as the computer's memory and central processing unit (CPU). Many current operating systems have a multi-tasking capability which allows multiple computer programs to run simultaneously, with each program not having to wait for termination of another in order to execute instructions. Multi-tasking O/S's allow programs to execute simultaneously by allowing programs to share resources with other programs. For example, an operating system running multiple programs executing at the same time allows the programs to share the computer's CPU time. Programs which run on the same system, even if not simultaneously with other programs, share space on the same nonvolatile memory storage medium. Programs which are executing simultaneously are presently able to place binaries and data in the same physical memory at the same time, limited to a certain degree by the O/S restrictions and policy, to the extent that these are properly implemented. Memory segments are shared by programs being serviced by the O/S, in the same manner. O/S resources, such as threads, process tables and memory segments, are shared by programs executing simultaneously as well.

While allowing programs to share resources has many benefits, there are resulting security related ramifications, particularly regarding malware programs. Security problems include allowing the malware program: to capitalize CPU time, leaving other programs with little or no CPU time; to read, forge, write, delete or otherwise corrupt files created by other programs; to read, forge, write, delete or otherwise corrupt executable files of other programs, including the O/S itself; and to read and write memory locations used by other programs to thus corrupt execution of those programs.

In the case of a computer connected to the Internet, the computer may run an O/S, with several user applications, together comprising a known and trusted set of programs, concurrently with an Internet browser, possibly requiring the execution of downloaded code, such as Java applets, or EXE/COM executables, with the latter programs possibly containing malware. Many security features and products are being built by software manufacturers and by O/S programmers to prevent malware infiltrations from taking place, and to ensure the correct level of isolation between programs. Among these are architectural solutions such as rings-of-protection in which different trust levels are assigned to memory portions and tasks, paging which includes mapping of logical memory into physical portions or pages, allowing different tasks to have different mapping, with the pages having different trust levels, and segmentation which involves mapping logical memory into logical portions or segments, each segment having its own trust level wherein each task may reference a different set of segments. Since the sharing capabilities using traditional operating systems are extensive, so are the security features. However, the more complex the security mechanism is, the more options a malware practitioner has to bypass the security and to hack or corrupt other programs or the O/S itself, sometimes using these very features that allow sharing and communication between programs to do so.

Further, regarding malware programs, for virtually every software security mechanism, a malware practitioner has

found a way to subvert, or hack around, the security system, allowing a malware program to cause harm to other programs in the shared environment. This includes every operating system and even the Java language, which was designed to create a standard interface, or sandbox, for Internet downloadable programs or applets.

Major vulnerabilities of existing computer systems lies in the architectures of the computer system and of the operating system itself. A typical multi-tasking O/S environment includes an O/S kernel loaded in the computer random access memory (RAM) at start-up of the computer. The O/S kernel is a minimal set of instructions which loads and off-loads resources and resource vectors into RAM as called upon by individual programs executing on the computer. Sometimes, when two or more executing programs require the same resource, such as printer output, for example, the O/S kernel leaves the resource loaded in RAM until all programs have finished with that resource. Other resources, such as disk read and write, are left in RAM while the operating system is running because such resources are more often used than others. The inherent problem with existing architectures is that resources, such as RAM, or a hard disk, are shared by programs simultaneously, giving a malware program a conduit to access and corrupt other programs, or the O/S itself through the shared resource. Furthermore, as many application programs are of a general nature, many features are enabled by default or by the O/S, thus in many cases bypassing the O/S security mechanism. Such is the case when a device driver or daemon is run by the O/S in kernel mode, which enables it unrestricted access to many if not all the resources.

The most common state-of-the-art solutions for preventing malware infiltration are software based, such as blockers, sweepers and firewalls, for example, and hardware based solutions such as router/firewalls. Examples of software designed to counter malware are Norton Systems Works, distributed by the Symantec Corporation, Ad-aware, distributed by the Lavasoft Corporation of Sweeden, Spy Sweeper, distributed by the Webroot Software Corporation, Spyware Guard, distributed by Javacool Software LLC, among others. Currently there are a plethora of freeware, shareware and purchased software programs designed to counter malware by a variety of means. Such anti-malware programs are limited because they can only detect known malware that has already been identified (usually after the malware has already attacked one or more computers).

Network firewalls are typically based on packet filtering, which is limited in principle, since the rules determining which packets to accept and which to reject may contain subjective decisions based on trusting known sites or known applications. However, once security is breached for any reason (for example, due to a software or hardware error, a new piece of malware unrecognized by the anti-malware program or firewall, or an intended deception), a malicious application may take over the computer or server or possibly the entire network and create unlimited damages (directly or indirectly by opening the door to additional malicious applications).

The methods in the prior art are typically comprised of embedded software countermeasures that detect and filter unwanted intrusions in real time, or scan the computer system either at the direction of a user or as a scheduled event. Two problems arise from these methods. In the first instance, a comprehensive scan, detect, and elimination of malware from desired incoming data streams could significantly slow or preclude the interactive nature of many applications such as gaming, messaging, and browsing. In the second instance, newly implemented software screens may be quickly circum-

vented by malware practitioners who are determined to pass their files through the screen. Newly discovered malware leads to the development of additional screens, which lead to more malware, etc., thus creating an escalating cycle of measure, countermeasure. The basic flaw is that all incoming executable data files must be resident on the computers main processor to perform their desired function. Once resident on that processor, access may be gained to non-volatile memory and other basic computer system elements. Malware exploits this key architectural flaw to infiltrate and compromise computer systems.

The majority of these applications rely upon a scanning engine which searches suspect files for the presence of predetermined malware signatures. These signatures are held in a database which must be constantly updated to reflect the most recently identified malware. Typically, users regularly download replacement databases, either over the Internet, from a received e-mail, or from a CDROM or floppy disc. Users are also expected to update their software engines every so often in order to take advantage of new virus detection techniques (e.g. which may be required when a new strain of malware is detected).

Many of the aforementioned applications are also not effective against security holes, for example, in browsers or e-mail programs, or in the operating system itself. Security holes in critical applications are discovered quite often, and just keeping up with all the patches is cumbersome. Also, without proper generic protection against, for example, Trojan horses, even VPNs (Virtual Private Networks) and other forms of data encryption, including digital signatures, are not totally safe because information can be stolen before or below the encryption layer. Even personal firewalls are typically limited, because once a program is allowed to access the Internet, there are often few limitations on what files may be accessed and transmitted back to a host.

A major problem faced by computer users connected to a network is that the network interface program (a browser, for example) is resident on the same processor as the O/S and other trusted programs, and shares space on a common memory storage medium. Even with security designed into the O/S, malware practitioners have demonstrated great skill in circumventing software security measures to create malware capable of corrupting critical files on the shared memory storage medium. When this happens, users are often faced with a lengthy process of restoring their computer systems to the correct configuration, and often important files are simply lost because no backup exists.

Therefore, what is needed in the art is a means of isolating the network interface program from the main computer system such that the network interface program does not share a common memory storage area with other trusted programs. The network interface program may be advantageously given access to a separate, protected memory area, while being unable to initiate access to the main computer's memory storage area. With the network interface program constrained in this way, malware programs are rendered unable to automatically corrupt critical system and user files located on the main memory storage area. If a malware infection occurs, a user would be able to completely clean the malware infection from the computer using a variety of methods. A user could simply delete all files contained in the protected memory area, and restore them from an image residing on the main memory area, for example.

Other discussions of malware, its effects on computer systems, techniques used by malware practitioners to install malware, and techniques for detection and removal, may be found in the published literature, and in some of the patents

and applications previously incorporated by reference. Reference to malware may be found in a technical white paper entitled "Spyware, Adware, and Peer-to-Peer Networks: The Hidden Threat to Corporate Security.", by Kevin Townsend, © Pest Patrol Inc. 2003. Pest Patrol is a Carlisle, Pa. based developer of software security tools. Another reference is a technical white paper entitled "Beyond Viruses: Why anti-virus software is no longer enough." by David Stang, PhD, © Pest Patrol Inc. 2002. Yet another reference is "The Web: Threat or Menace?" from "Firewalls and Internet Security: Repelling the Wily Hacker", Second Edition, Addison-Wesley. ISBN 0-201-63466-X, Copyright 2003. The foregoing references are incorporated by reference as if reproduced herein in their entirety.

SUMMARY OF THE INVENTION

Embodiments of the present invention achieve technical advantages as a system and method for protecting a computer system from malicious software attacks via a network connection.

It is an object of the present invention to provide a computer system capable of preventing malware programs from automatically corrupting critical user and system files.

It is another object of the present invention to confine any malware infection that may occur to a separate, protected part of the computer system.

It is another object of the present invention to provide a user with an easy and comprehensive method of removing the malware infection, even if the user's anti-malware software is incapable of detecting and/or removing the malware infection.

It is another object of the present invention to provide a user with an easy and comprehensive method of restoring critical system and user files that may have been corrupted by a malware infection.

It is another object of the present invention to provide a computer system configured such that attempts by malware to record and report data entry by the computer user via input devices such as keyboards, mouse clicks, microphones, or any other data input devices are effectively blocked.

It is another object of the present invention to provide a computer system capable of executing instructions in a first logical process, wherein the first logical process is capable of accessing data contained in a first memory space and a second memory space.

It is another object of the present invention to provide a computer system capable of executing instructions in a second logical process, wherein the second logical process is capable of accessing data contained in the second memory space, the second logical process being further capable of exchanging data across a network of one or more computers.

It is another object of the present invention to provide a computer system capable of displaying, in a windowed format on a display terminal, data from the first logical process and the second logical process, wherein a video processor is adapted to combine data from the first and second logical processes and transmit the combined data to the display terminal.

It is another object of the present invention to provide a computer system configured such that a malware program downloaded from the network and executing as part of the second logical process is incapable of initiating access to the first memory space.

It is another object of the present invention to provide a computer system configured such that corrupted data files

residing on the second memory space may be restored from an image residing on the first memory space.

It is another object of the present invention to provide a computer system configured such that data files residing on the second memory space may be automatically deleted when the second logical process is terminated.

It is another object of the present invention to provide a computer system configured such that the second electronic data processor and the video processor are co-located on a circuit card, the circuit card being communicatively coupled to the first electronic data processor.

These objects and other advantages are provided by a preferred embodiment of the present invention wherein a computer system comprising a first electronic data processor is communicatively coupled to a first memory space and to a second memory space, a second electronic data processor is communicatively coupled to the second memory space and to a network interface device, wherein the second electronic data processor is capable of exchanging data across a network of one or more computers via the network interface device, a video processor is adapted to combine video data from the first and second electronic data processors and transmit the combined video data to a display terminal for displaying the combined video data in a windowed format, wherein the computer system is configured such that a malware program downloaded from the network and executing on the second electronic data processor is incapable of initiating access to the first memory space.

TERM DESCRIPTION

Advertisement(s)—This term is intended to broadly encompass any secondary content that is delivered or distributed to client devices in addition to the primary content, e.g., e-mail messages, which the software product instantiated by the client device is designed to receive, transmit, process, display, and/or utilize. For example, this term is intended to cover, without limitation, paid advertisements, community service messages, public service announcements, system information messages or announcements, cross-promo spots, artwork, and any other graphical, multimedia, audio, video, text, or other secondary digital content.

Client Device—This term is intended to broadly encompass any device that has digital data processing and output, e.g., display, capabilities, including, but not limited to, desktop computers, laptop computers, hand-held computers, notebook computers, Personal Digital Assistants (PDAs), palm-top computing devices, intelligent devices, information appliances, video game consoles, information kiosks, wired and wireless Personal Communications Systems (PCS) devices, smart phones, intelligent cellular telephones with built-in web browsers, intelligent remote controllers for cable, satellite, and/or terrestrial broadcast television, and any other device that has the requisite capabilities.

Information—This term is intended to broadly encompass any intelligible form of information which can be presented by a client device, i.e., an information client device, including, without limitation, text, documents, files, graphical objects, data objects, multimedia content, audio/sound files, video files, MPEG files, JPEG files, GIF files, PNG files, HTML documents, applications, formatted documents (e.g., word processor and/or spreadsheet documents or files), MP3 files, animations, photographs, and any other document, file, digital, or multimedia content that can be transmitted over a communications network such as the Internet.

E-Mail Messages—This term is intended to broadly encompass the e-mail message and any attachments thereto,

including, without limitation, text, documents, files, graphical objects, data objects, multimedia content, audio/sound files, video files, MPEG files, JPEG files, GIF files, PNG files, HTML documents, applications, formatted documents (e.g., word processor and/or spreadsheet documents or files), MP3 files, animations, photographs, and any other document, file, digital, or multimedia content that can be transmitted over a communications network such as the Internet.

Memory—This term is intended to broadly encompass any device capable of storing and/or incorporating computer readable code for instantiating the client device referred to immediately above. Thus, the term encompasses all types of recording medium, e.g., a CD-ROM, a disk drive (hard or soft), magnetic tape, and recording devices, e.g., memory devices including DRAM, SRAM, EEPROM, FRAM, and Flash memory. It should be noted that the term is intended to include any type of device which could be deemed persistent storage. To the extent that an Application Specific Integrated Circuit (ASIC) can be considered to incorporate instructions for instantiating a client device, an ASIC is also considered to be within the scope of the term “memory.”

It is also known that the state of the art for advertising on personal computers (PCs) currently consists of Internet advertising that is displayed using World Wide Web (or Internet) browser software. As users browse the Internet, the various sites they visit display advertisements of a random nature or advertisements that are related to the content of the Web pages being browsed. Although this method of advertisement is growing rapidly it is not ideal in several respects. Web page based advertisements are easy to ignore. They generally occupy a small area of the computer monitor’s display and are inconsistent in appearance with the material that hosts them. Internet users quickly adjust and typically ignore advertisements. To solve this problem, Web based advertisements are becoming more striking in appearance and are making use of animation. However, the advertisement’s animation requires additional time when loading a Web page into a user’s browser and ultimately detracts from the material that hosts the advertisement.

BRIEF DESCRIPTION OF THE DRAWINGS

For a more complete understanding of the present invention, and the advantages thereof, reference is now made to the following descriptions taken in conjunction with the accompanying drawings, in which:

FIG. 1 illustrates a preferred embodiment of an exemplary computer system according to the principles of the present invention;

FIG. 2 illustrates a preferred embodiment of an exemplary protected process flow according to the principles of the present invention;

FIG. 3 illustrates a preferred embodiment of an exemplary file download process according to the principles of the present invention;

FIG. 4 illustrates a preferred embodiment of an exemplary memory restoration process according to the principles of the present invention;

FIG. 5 illustrates a preferred embodiment of an exemplary automatic memory restoration and cleaning process according to the principles of the present invention;

FIG. 6 illustrates a preferred embodiment of an exemplary interactive network process flow according to the principles of the present invention;

FIG. 7 illustrates a preferred embodiment of an exemplary computer system according to the principles of the present invention;

FIG. 8 illustrates a preferred embodiment of an exemplary computer system according to the principles of the present invention;

FIG. 9 illustrates a preferred embodiment of an exemplary computer system according to the principles of the present invention;

FIG. 10 illustrates a preferred embodiment of an exemplary protected process flow according to the principles of the present invention.

DETAILED DESCRIPTION OF THE ILLUSTRATED EMBODIMENTS

The making and using of the presently preferred embodiments are discussed in detail below. It should be appreciated, however, that the present invention provides many applicable inventive concepts that can be embodied in a wide variety of specific contexts. The specific embodiments discussed are merely illustrative of specific ways to make and use the invention, and do not limit the scope of the invention.

A computer system, constructed in accordance with a preferred embodiment of the present invention, is illustrated in FIG. 1. Computer system **100** may represent, for example, a personal computer (PC) system, a server, a portable computer, such as a notebook computer, or any data processing system, a personal digital assistant (PDA), a communication device such as a cell phone, or device that is capable of being connected to a network of one or more computers. System **100** comprises a first processor **120** (P1) communicatively coupled to a first memory and data storage area **110** (M1). P1 **100** may comprise, for example, a microprocessor, such as a Pentium® 4 processor, manufactured by the Intel Corporation, or a Power PC® processor, manufactured by the IBM Corporation. Other electronic data processors manufactured by other companies, including but not limited to electronic data processors realized in Application Specific Integrated Circuits (ASICs) or in Field Programmable Gate Arrays (FPGAs), are within the spirit and scope of the present invention.

The first memory and data storage area **110** may comprise both volatile and nonvolatile memory devices, such as DRAMs and hard drives, respectively. Any memory structure and/or device capable of being communicatively coupled to P1 may be advantageously used in the present invention. M1 may be used to store, for example, critical operating system files, user data and applications, interim results of calculations, etc. The many uses of computer memory are well understood by those skilled in the art, and will not be discussed further here. One may refer to several of the aforementioned patents and applications incorporated by reference, in addition to other references, for a discussion of existing computer architectures and uses of computer memory. Also part of system **100** is user interface **150**, which may comprise, for example, a keyboard, mouse or other pointing device, microphone, pen pad, etc. Any device or method capable of inputting commands and/or data from a user **160** to computer system **100** may be used to advantage. A video processor **170** is used to format information for display and transmit the display information to a video display device **180**, which is viewed by user **160**. Video processor **170** typically includes an associated video memory area, which may be dedicated to the video processor, or shared with other resources. It is understood in the art that the video processor **170** may be part of processor P1 **120**, in that it may be integrated onto the microprocessor chip. Video processor **170** may also comprise a processor IC located on a video graphics card, which is communicatively coupled to a computer motherboard. Additionally, video processor **170** may

11

comprise circuitry located on the computer motherboard. Further still, functions of video processor 170 may be split between the processor, motherboard, or separate video graphics card.

It is often desirable to connect computer system 100 to a network of one or more computer devices 195, such as the Internet, a LAN, WAN, VPN, etc. This connection may be accomplished via network interface device 190, which may comprise, for example, a telephone modem, a cable modem, a DSL line, a router, gateway, hub, etc. Any device capable of interfacing with the network 195 may be used, via a wired connection, a wireless connection, or an optical connection, for example. Network interface device 190 may connect to network 195 through one or more additional network interface devices (not shown). For example, network interface device 190 may comprise a gateway or router, connected to a cable modem, with the cable modem connected to network 195. Of course, other configurations are within the spirit and scope of the present teachings.

In accordance with a preferred embodiment of the present invention, network 195 is isolated from the first processor 120 and memory 110 by a second processor 140 (P2). Second processor 140 may comprise any electronic data processor, such as the devices previously described as applicable to first processor 120. Communicatively coupled to P2 140 is second memory and data storage area 130 (M2), which may comprise any memory device or devices, such as the devices previously described as applicable to first memory 110.

The architecture of computer system 100 is designed to be capable of protecting memory 110 from malware initiated intrusions, and preventing malware from initiating unwanted processes on first processor 120. This is accomplished by using second processor 140 to isolate 110 and 120 from network 195. In a preferred embodiment, P2 140 is communicatively coupled to memory storage area M2 130, and may be configured such that P2 140 is incapable of initiating access to memory storage area M1 110. For example, P2 140 may be capable of accessing memory storage area M1 110 with the strict permission of user 160, either through a real time interaction or via stored configuration or commands. Such a configuration may be desirable in a multi-core or multi processor system, where user 160 may wish to use P2 140 in either a protected mode or an unprotected mode, depending on the application. However, user 160 is capable of denying P2 140 the capability of initiating access to memory storage area M1 110 without the user's permission. P1 120 is communicatively coupled to both memory areas M1 110 and M2 130, thereby enabling P1 120 to access data downloaded from the network 195. In the presently described embodiment, any malware that has intruded the 130-140 system is thus confined to the 130-140 system, and may be configured to be incapable of automatically corrupting data contained on M1 110, or of automatically initiating an unwanted process on P1 120.

This and other features of the present teachings may be illustrated with reference to the example process flow 200 of FIG. 2. Computer user 160 wishes to connect to network 195 via for example, a browser program such as Internet Explorer or Netscape Navigator. Of course, other methods of connecting to network 195 may be used. User 160 inputs commands to open a protected process (e.g. a browser program in this example) at step 210. At step 220, 1st processor 120 instructs 2nd processor 140 to initiate the protected process and open one or more process windows. Second processor 140, in conjunction with memory 130, then interacts with the network 195 via network interface device 190, receiving and transmitting the data necessary to execute the desired pro-

12

cess, such as browsing the internet or communication via e-mail. Second processor 140 and memory 130 act as a separate computer system, interacting with network 195 while isolating network 195 from the first processor 120 and memory 110. Memory 130 may store critical application and system files required by second processor 140 to execute the desired tasks. Memory 130 also stores data necessary to carry out the desired protected process. In the example of FIG. 2, first processor 120 receives user interface data from user 160, and passes user interface data to second processor 140 when the protected process window is selected or active, illustrated at step 230. User interface data, such as keystrokes for example, may be advantageously encrypted by P1 120 before passing the data to P2 140, with network interface device 190 possibly decrypting the data prior to transmitting the data to network 195. Encrypting, for example keystroke data, may disrupt the efforts of spyware programs designed to store user keystrokes for later transmission to a host computer. Second processor 140 generates video data for the protected process window(s) and passes the video data to video processor 170, for eventual display on video display 180, shown at step 240. Video processor 170 then interleaves the video data from all processes being executed by first processor 120 and second processor 140, at step 250. While there are many applicable methods for displaying video data from multiple sources, one such method was described in U.S. Pat. No. 5,751,979, entitled "Video hardware for protected, multiprocessing systems", previously incorporated by reference.

In accordance with a preferred embodiment of the present invention, if any malware is downloaded from network 195, it is stored in memory 130, and/or run as a process on second processor 140. In the configuration of computer system 100, any downloaded malware is rendered incapable of self initiating access to memory 110 or first processor 120, because second processor 140 is rendered incapable of initiating access to 110 and 120 without a direct or stored command from user 160. Any malware infection is thus confined. If a malware attack corrupts files and/or disrupts the operation of the 130-140 system, the user may easily shut down the corrupted process and restore the corrupted files from a protected image stored on memory 110, for example.

In accordance with a preferred embodiment of the present invention, the operating system controlling the 110-120 system may be different from an operating system controlling the protected 130-140 system. Conversely, a common operating system may control both the 110-120 system and the protected 130-140 system.

A user 160 may find it desirable to transfer files from the protected 130-140 system to the 110-120 system. User 160 may find it necessary, for example, to transfer an attachment from an e-mail message stored on memory 130 to the 110-120 system for further processing, modification, etc. In this case, the computer system 100 may go through a process whereby a file or other data is transferred from the 130-140 system to the 110-120 system, exemplified by the process 300 illustrated in FIG. 3.

In accordance with a preferred embodiment of the present invention, at step 310, user 160 selects one or more data files to download from network 195. The desired data is downloaded to the 130-140 system at step 320. The user 160 then directs computer system 100 to move the desired file(s) from the 130-140 system to the 110-120 system at step 330. P1 120 may then perform a malware scan on the desired files, either in real time as the data is being transferred, or while the data still resides in M2 130 (step 340). Alternatively, P2 140 may perform the malware scan. At step 350, processor P2 140 (or P1 120) determines if malware has been detected in the

desired file(s), and thus P1 120 makes a decision. If no malware is detected, the file(s) are moved or copied onto M2 110 at step 360. If malware is detected, the data file(s) are quarantined on M2 130, and the data file(s), if transferred to M1 100, are erased or quarantined. Once malware is detected, the user 160 may be alerted of the detection (step 370). Either as a result of user input or stored configuration commands, the infected file(s) are deleted, cleaned, or quarantined on M2 130, at step 380.

The user 160 would of course understand the dangers inherent in transferring downloaded files from the 130-140 system to the 110-120 system. For example, the user's anti-malware software may not be up to date, or may simply be unable to detect certain types of malware. Also, the malware itself may be so new that the user's anti-malware definitions have not been updated as yet. Therefore the user may wish to keep the files on the 130-140 system for some period of time. Consequently, it may be desirable to have resident on the 130-140 system a variety of application software such as readers, thereby allowing the user to examine the files without risking transferring the files to the 110-120 system. These reader programs, such as Adobe Acrobat Reader, by the Adobe Systems Corporation, or Visio reader, by the Microsoft Corporation, are typically subset application programs of the full featured application programs, and may thus require far less memory space than the full application. Additionally, software companies often distribute the reader programs for free (or a nominal fee), thereby providing advertising for the full featured application in the hopes that it will be eventually purchased by the user. This reader application may be opened and executed on the 130-140 system in a manner similar to the process described in FIG. 2. Of course, a user 160 may also load a full application into the 130-140 system, enabling processing and modification of a downloaded file fully in the protected space, without risking a transfer of the file to the 110-120 system.

In the event the 130-140 system becomes infected with malware, the user 160 may wish to clean the 130-140 system. This cleaning may be accomplished by running an anti-malware application on the 130-140 system. However, if the infection is too severe for the anti-malware software to clean, or if the malware is undetectable by the user's anti-malware software, the user may wish to restore critical system files (or other user data files) for the 130-140 system from a protected image stored on M1 100, for example. It is of course understood that the critical system file image may be restored from another device, such as a removable drive or a CD, for example. The user may however consider it more convenient to restore the critical system files from an image on M1 100.

In accordance with a preferred embodiment of the present invention, an exemplary process for restoring M2 130 from M1 110 is illustrated by process 400 in FIG. 4. At step 410, malware is detected or suspected to be infecting the 130-140 system. The user instructs P1 120 to reload critical system files onto M2 130 from a protected image on M1 110, at step 420. Depending on the severity of the infection, P1 120 may scan all or part of the data contained on M2 130 for malware, and may scan all processes currently running on P2 140. The scan may be initiated by direct instructions from the user, or by stored configuration commands, for example (step 430). P1 120 may delete all or part of the data contained on M2. P1 120 may also reset P2 140 and/or delete the contents of any RAM communicatively coupled to P2 140 (step 440). Once the 130-140 system has been adequately cleaned, clean critical system files are loaded onto M2 130 from any of the sources previously mentioned, preferably an image stored on M1 110 (step 450). The 130-140 may now be rebooted and/or

reinitialized from the clean critical system files. In an extreme case where the malware resists deletion by the operating system, the user may elect to do a low level format on the M1 110 memory in order to ensure that the malware infection has been cleaned.

In accordance with a preferred embodiment of the present invention, a user 160 may consider it advantageous for the 130-140 system to be automatically reinitialized from clean critical system files when a protected process window is opened. In this way, the new protected process is much less likely to be affected by an infection from a previous protected process session. Of course, a user may have a plurality of protected processes open and running during a protected process session. It may only be necessary to automatically reinitialize from clean critical system files when the first protected process is opened during a session. Subsequent protected processes may not require automatic re-initialization from clean critical system files. An exemplary automatic re-initialization from clean critical system files is illustrated by steps 510, 520 and 530 in FIG. 5a. Additionally, processes running on P2 140 may be automatically scanned and compared with an allowed process list, particularly as a protected process is started up. If any process is detected which is not on the allowed list, the user may be alerted that a possible malware infection has occurred. A user may then choose to scan or clean the system, or inspect the unknown process to determine if the process will be allowed to continue to execute. A user may also update the list of allowed processes from time to time as new, legitimate processes are added, for example, by a browser software update.

In accordance with a preferred embodiment of the present invention, a user 160 may consider it advantageous for the 130-140 system to be automatically cleaned when a protected process window is closed. In this way, any detected or undetected malware infections are much less likely to affect a future protected process session. It may only be necessary to automatically clean the 130-140 system when the last protected process is closed during a session. An exemplary automatic cleaning process is illustrated by steps 540, 550, 560, 570 and 580 in FIG. 5b. The memory M2 130 and processor P2 140 may be automatically scanned for malware infections as the protected process session closes. Infected files may be deleted or quarantined automatically. Additionally, there may be a variety of files that a user may wish to have automatically cleaned or deleted upon closing a protected process session. For example, temporary internet files, cookies, browser plugins, etc., may be deleted or scanned for malware automatically. A user may also wish to have websites that contributed to a malware infection noted, and may wish to place the offending websites in a block list, such that the offending websites cannot be accessed in the future without the user specifically authorizing access. As part of the malware scan, the malware scanner may automatically log the offending website(s), and block future access. Also, the P2 140 processor and any associated non-volatile memory may be reset and/or erased as the protected process session is closed. The exemplary automatic cleaning process illustrated in FIG. 5b may therefore reduce the risk of a malware infection being carried over to a future protected process session.

Interactive network processes such as interactive gaming have become very popular in recent years. In current interactive gaming processes, a user may log onto a game host located on network 195, or connect to other computers whose users wish to participate in the game. Computer games, such as Quake 3. Arena, by Id Software Incorporated, or Call of Duty, by Activision Incorporated, are just two examples of the plethora of games available that may be played interactively

over a network. The user's computer system typically provides the bulk of the processing power and video graphics generation required to display the often fast moving and richly detailed three dimensional game environments. Information about the current and new state of the game is exchanged between various users' computer systems, often in real time. With this type of process, a relatively modest amount of data is required to be exchanged between users, or a user and the host, with the bulk of the processing, data manipulation, and graphics generation being handled by the user's local machine. However, this open network connection may become a conduit for malware practitioners to exploit, allowing malware to be downloaded onto a user's computer during a gaming session, often without the user being aware of the malware transfer. It would be advantageous, therefore, for a computer system to be much less susceptible to malware attacks during gaming sessions.

In accordance with a preferred embodiment of the present invention, an exemplary process flow 600, illustrated in FIG. 6, allows an interactive network process, such as online gaming, to be carried out on computer system 100. A user initiates an interactive network process via 2nd processor P2 140 (step 610). P2 140 receives interactive network process status data from network connection (step 620). P2 140 informs 1st processor P1 120 that interactive network process status data is available (step 630). P1 120 retrieves interactive network process status data from P2 140 and uses the status data to update the interactive network process and update video display (step 640). P1 120 then passes the updated interactive network process status data to P2 140 (step 650). P2 140 then sends the updated interactive network process status data to the network via network connection 195 (step 660). The exemplary process 600, or a process functionally equivalent, is carried out continuously as long as the interactive process is running.

By using exemplary process 600 (or an equivalent), computer system 100 is capable of actively deciding what data to download and use, and what data to discard or scan for malware. The game status data is buffered prior to loading it onto the 110-120 system. The 110-120 system may be advantageously configured to only accept game status information in the proper format, thereby minimizing the chance that a malware practitioner could deceptively load malware onto the 110-120 system.

Additionally, computer system 100 could be configured such that system 130-140 is powerful enough to process the interactive network process without exchanging information with the 110-120 system. Such a configuration may be more secure, as a conduit between the 110-120 system and the 130-140 system may not be necessarily opened. The 130-140 system may contain all the necessary files to facilitate the interactive network process. Higher end computers, workstations, and servers often contain dual (or more) processors, such as the Mac G5, manufactured by the Apple Computer Corporation, or a single physical processor with a multiple processor core. Often, the processors in these multi-processor machines are of equal or comparable processing power. In such a configuration, one processor may be dedicated to performing functions equivalent to those described for P1 120, with a second processor performing the functions equivalent to those described for P2 140. A computer system 100 employing multiple processors may be advantageously configured such that one of the processors is dedicated to protected processes only when a network process is active. When a user is not accessing a network, the multiple processors in a computer system may be dedicated to other processes, such as performing complex calculations or simula-

tions, or running complex non-network interactive gaming processes, for example. Alternatively, the computer system 100 may be configured such that the 110-120 system simply transfers required files to the video processor 170 or the 130-140 system at the appropriate time to facilitate the interactive network process. The 110-120 system could be commanded to retrieve and transfer the files at the command of the video processor, or at the command of the 130-140 system, or a combination of both.

In accordance with embodiments of the present invention, computer system 100 may be configured in a variety of ways, while still remaining within the spirit and scope of the present teachings. One such exemplary embodiment is illustrated in FIG. 7. Subsystem 700 of computer system 100 comprises a video processor 770, a second processor 740, and a second memory data storage area 730. The demarcation line illustrated by subsystem 700 may be either physical or logical. For example, subsystem 700 may comprise an add-on card, such as a high end video card, or a video/network card. If configured in this exemplary manner, a user could upgrade an existing computer system to take advantage of the teachings of the present invention. Subsystem 700 may be plugged into the main motherboard of an existing computer, for example. The motherboard connector may be already communicatively coupled to the 110-120 system, thereby facilitating the system upgrade. The network interface device 190 may be connected directly to subsystem 700, or network interface device 190 could be integrated as part of subsystem 700. Memory data storage area 730 may comprise any of the volatile and/or non-volatile memory types previously described, or any combination thereof, or any suitable memory storage medium, for example. Alternatively, subsystem 700 may be located on the motherboard, as opposed to an add-on card. Further still, portions of subsystem 700, such as video processor 770, and/or second processor 740, for example, may be integrated together with P1 120. It is understood that functions described herein may be configured in a wide variety of ways, without departing from the spirit and scope of the present teachings.

In accordance with a preferred embodiment of the present invention, an alternate configuration for computer system 100 is illustrated in FIG. 8. Subsystem 800 of computer system 100 comprises a video processor 870, a second processor 840, and a second memory data storage area 830. The demarcation line illustrated by subsystem 800 may be either physical or logical. For example, subsystem 800 may comprise an add-on card, such as a high end video card, or a video/network card. If configured in this exemplary manner, a user could upgrade an existing computer system to take advantage of features of the present invention. In the exemplary embodiment of FIG. 8, second processor 840 and video processor 870 are integrated together, perhaps on a common integrated circuit. Such a configuration may help to reduce the cost of subsystem 800, and/or improve the performance. Additionally, a circuit designer may find it advantageous to integrate 840 and 870 together to facilitate communication between the functions. It is understood that such an integration of functions may create a device in which an external user may find it difficult to distinguish where the function of 870 ends and the function of 840 begins, and vice versa. Such a device, however, would remain within the spirit and scope of the present teachings.

In accordance with a preferred embodiment of the present invention, an alternate configuration for computer system 100 is illustrated in FIG. 9. Computer system 100 comprises a video processor 970, processor 960, and a memory data storage area 950. Processor 960 may further comprise multiple processor cores, illustrated by 1st processor 920 and 2nd processor 940. It is understood that processor 960 may contain

more than 2 processor cores. Microprocessors manufactured with multiple processor cores are becoming common in the industry, and such multi-core processors may be particularly advantageous when used in accordance with the present teachings. Memory data storage area **950** may further comprise 1st memory data storage area **910** and 2nd memory data storage area **930**. Memory areas **910** and **930** may comprise, for example, different partitions on a single hard drive, and/or different address ranges in a RAM bank.

Referring again to FIG. **9**, the functions carried out by processors **920** and **940** may comprise separate, secure logical processes executing on the same physical processor. For example, a first logical process may comprise executing instructions necessary to carry out the functions of an operating system, or the first logical process may comprise executing instructions necessary to carry out the functions of a first computer program, including but not limited to a word processor. A second logical process may comprise executing instructions necessary to carry out the functions of a web browser program, or may comprise executing instructions necessary to carry out the functions of an instant messenger program, for example. A computer system **100** constructed in accordance with the principles of the present invention would be capable of disallowing a secure logical process, such as the second logical process described above, access to certain memory spaces, and/or disallowing a secure logical process from initiating access to another logical process. For example, the functions carried out by **P2 140** (FIG. **1**) may comprise a secure logical process, which may be configured to be unable to automatically initiate access to either **M1 110** or another logical process performing the functions of **P1 120**. Additionally, memory areas **910** and **930** may comprise separate, isolated memory zones within a common physical memory space, such as separate partitions within the same hard drive, for example.

Some malware programs are designed to secretly record user input commands (such as keystrokes, for example), then send the information back to a host computer. This type of malware is capable of stealing important user information, such as passwords, bank account numbers, social security numbers, driver's license numbers, credit account numbers, etc. Theft of such personal information could result in the theft of actual assets (money or securities, etc.) or perhaps used for identity theft, among other malicious intents. Clearly, a computer system capable of ensuring the protection of such sensitive information would be desirable.

In accordance with an embodiment of the present invention, a computer system is configured such that attempts by malware to record and report data entry by the computer user via input devices such as keyboards, mouse clicks, microphones, or any other data input devices are effectively blocked. Encryption of user input data, such as keystrokes, is an effective means of protecting such data from theft by malware. Specific techniques used for data encryption and decryption are well known in the art, and need not be discussed further here. There are many examples in the art that may be examined to better understand various encryption/decryption techniques and the use of encryption/decryption in computer systems. Among these are U.S. Pat. No. 6,581,162 entitled "Method for securely creating, storing and using encryption keys in a computer system." issued to Angelo, et al., and U.S. Pat. No. 6,134,661 entitled "Computer network security device and method." Issued to Topp. The aforementioned patents have been previously incorporated by reference.

In accordance with the present teachings, a method of operating a computer system involving data encryption is

described. In step **1010**, a user opens a protected process where some level of data encryption is desired, for example, the encryption of sensitive user interface data or user files. Other data may be encrypted as desired. At step **1020**, processor **P1 120** instructs processor **P2 140** to initiate a protected process and open a process window. **P1 120** encrypts the sensitive data and passes the user interface data to **P2 140** when a **P2 140** window is selected or active (step **1030**). **P2 140** generates video data for the **P2 140** process window(s) and passes the video data to video processor **170** (step **1040**). Video processor **170** decrypts the sensitive data and interleaves the video data from all **P1** and **P2** processes (step **1050**). **P2 140** passes the encrypted sensitive data to network interface device **190** (step **1060**). Network interface device **190** decrypts the sensitive data and passes the decrypted sensitive data to network **195**. Of course, other methods of operating a computer system in which data is encrypted prior to being passed to **P2 140**, and decrypted after leaving the control of **P2 140**, are within the spirit and scope of the present teachings.

In accordance with a preferred embodiment of the present invention, data desired to be protected is encrypted prior to sending the data to processor **P2 140**, which may be running one or more malware processes. Processor **P2 140** does not have visibility to the decryption keys, and is therefore unable to decrypt the data. Data may be decrypted by network interface device **190** prior to forwarding the data on to network **195**. Conversely, encrypted data may be sent directly over the network for decryption by another computer system, including, for example, an internet banking host computer. Decryption keys may be passed between **P1 120** and network interface device **190** via a communication link **191**. Video processor **170** may decrypt the data prior to displaying the data on video display **180**, with decryption keys possibly passed between **P1 120** and video processor **170** via a communication link **171**. Conversely, data may be passed directly to video processor **170** via a communication link **151**.

A user **160** may wish to encrypt just a portion of the data destined for the network, such as passwords, credit card numbers, etc. Conversely, a user may wish to encrypt large blocks of data, such as e-mails or large application files containing sensitive text and/or graphics. Instructions may be passed to network interface device **190** directing **190** to decrypt one or more specific data blocks prior to sending the data blocks to network **195**. Conversely, instructions may be passed to network interface device **190** directing **190** to pass one or more specific data blocks to network **195** without decryption.

While this invention has been described with reference to illustrative embodiments, this description is not intended to be construed in a limiting sense. Various modifications and combinations of the illustrative embodiments, as well as other embodiments of the invention, will be apparent to persons skilled in the art upon reference to the description. It is therefore intended that the appended claims encompass any such modifications or embodiments.

What is claimed is:

[1. A method of operating a computer system having at least a first and second electronic data processor capable of executing instructions using a common operating system, comprising the steps of:

executing instructions in a first logical process within the common operating system using the first electronic data processor, wherein the first logical process is capable of accessing data contained in a first memory space and a second memory space;

executing instructions in a second logical process within the common operating system using the second elec-

19

tronic data processor, wherein the second logical process is capable of accessing data contained in the second memory space, the second logical process being further capable of exchanging data across a network of one or more computers;

displaying, in a windowed format on a display terminal, data from the first logical process and the second logical process, wherein a video processor is adapted to combine data from the first and second logical processes and transmit the combined data to the display terminal; wherein the computer system is configured such that the second electronic data processor is operating in a protected mode and data residing on the first memory space is protected from corruption by a malware process downloaded from the network and executing as part of the second logical process.]

[2. The method of claim 1 wherein the first memory space and the second memory space comprise separate regions of a common memory space.]

[3. The method of claim 1 wherein the second logical process is selected from the group consisting of; an electronic mail process, an instant messaging process, an internet browser process, an interactive gaming process, a virtual private network (VPN) process, and a reader application process.]

[4. The method of claim 1 wherein the first logical process receives user interface data, and passes the user interface data to the second logical process.]

[5. The method of claim 1 wherein the first and second electronic data processors are part of a multi-core electronic data processor.]

[6. The method of claim 1 and further comprising the step of restoring at least one corrupted data file residing on the second memory space from an image residing on the first memory space.]

[7. The method of claim 1 and further comprising the step of automatically deleting at least one data file residing on the second memory space when the second logical process is terminated.]

[8. The method of claim 1 and further comprising the steps of:

encrypting data with the first logical process;
transferring the encrypted data from the first logical process to the second logical process;
transferring the encrypted data from the second logical process to the network interface device.]

[9. The method of claim 8 and further comprising the steps of:

decrypting the data with the network interface device;
transferring the decrypted data from the network interface device to the network.]

[10. A multi-processor computer system using a common operating system, comprising:

a first electronic data processor capable of executing instructions using the common operating system and communicatively coupled to a first memory space and a second memory space;

a second electronic data processor capable of executing instructions using the common operating system and communicatively coupled to the second memory space and to a network interface device, wherein the second electronic data processor is capable of exchanging data across a network of one or more computers via the network interface device;

a video processor adapted to combine video data from the first and second electronic data processors and transmit

20

the combined video data to a display terminal for displaying the combined video data in a windowed format; wherein the computer system is configured such that the second electronic data processor is operating in a protected mode and data residing on the first memory space is protected from corruption by a malware process downloaded from the network and executing on the second electronic data processor.]

[11. The computer system of claim 10 wherein the first memory space and the second memory space comprise separate regions of a common memory space.]

[12. The computer system of claim 10 wherein the first and second electronic data processors are part of a dual processor computer system.]

[13. The computer system of claim 10 wherein the second electronic data processor and the video processor are collocated on a circuit card, the circuit card being communicatively coupled to the first electronic data processor.]

[14. The computer system of claim 10 wherein the computer system is configured such that the first electronic data processor is protected from executing instructions initiated by a malware process downloaded from the network and executing on the second electronic data processor.]

[15. A multi-processor computer system using a common operating system, comprising:

at least a first and second electronic data processor capable of executing instructions using the common operating system;

at least a first and second memory space;

a video processor;

wherein the first and second electronic data processors, first and second memory space, and video processor are configured for performing the steps of:

executing instructions in a first logical process with the first electronic data processor, wherein the first logical process is executing within the common operating system and is capable of accessing data contained in the first memory space and the second memory space;

executing instructions in a second logical process with the second electronic data processor, wherein the second logical process is executing within the common operating system and is capable of accessing data contained in the second memory space, the second logical process being further capable of exchanging data across a network of one or more computers;

displaying, in a windowed format on a display terminal, data from the first logical process and the second logical process, wherein the video processor is adapted to combine data from the first and second logical processes and transmit the combined data to the display terminal;

wherein the computer system is configured such that the second electronic data processor is operating in a protected mode and data residing on the first memory space is protected from corruption by a malware process downloaded from the network and executing as part of the second logical process.]

[16. The computer system of claim 15 wherein the computer system is further configured such that the first logical process is protected from executing instructions initiated by a malware process downloaded from the network and executing as part of the second logical process.]

[17. The computer system of claim 15 and further comprising: at least one network interface device capable of exchanging data with both the second logical process and with the network.]

[18. The computer system of claim 17 wherein the network interface device is capable of decrypting data received from

21

the second logical process and transmitting the decrypted data to the network while preventing the second logical process from accessing the decrypted data.]

[19. The computer system of claim 15 wherein the at least one electronic data processor is selected from the group consisting of: a multi-core electronic data processor; dual electronic data processors; and multiple electronic data processors.]

[20. The computer system of claim 15 and further configured for performing the step of: restoring at least one corrupted data file residing on the second memory space from an image residing on the first memory space.]

21. A method of generating data for display of website content on a portable computer employing a common operating system in a secure manner, comprising:

distributing website content, via a network of one or more computers, to the portable computer capable of executing a secure web browser process, wherein the website content potentially contains malware;

wherein the secure web browser process is capable of executing on at least one electronic data processor and comprises a first web browser process and at least one second protected web browser process, the first web browser process and the at least one second protected web browser process being configured to access the website content via the network of one or more computers, the at least one electronic data processor capable of being communicatively coupled to a first memory space and to a second protected memory space, the first memory space having at least one system file, the secure web browser process configured for:

executing instructions in the first web browser process, wherein the first web browser process is configured to access data contained in the first memory space and to initialize the at least one second protected web browser process;

passing data from the first web browser process to the at least one second protected web browser process;

executing instructions in the at least one second protected web browser process, wherein the at least one second protected web browser process is configured to access data contained in the second protected memory space but is denied access to the first memory space;

generating data for display of the distributed website content potentially containing malware;

wherein the secure web browser process is configured such that the at least one system file residing on the first memory space is protected from corruption by the website content potentially containing malware executing in the at least one second protected web browser process.

22. The method of claim 21 wherein the first web browser process is configured to directly exchange data with a network interface device and with the at least one second protected web browser process.

23. The method of claim 22 wherein the first web browser process is configured to pass website content downloaded from the network to the at least one second protected web browser process.

24. The method of claim 21 wherein the at least one second protected web browser process is configured to directly exchange data with a network interface device and with the first web browser process.

25. The method of claim 21 wherein the website content potentially containing malware comprises internet advertising.

22

26. The method of claim 25 wherein the internet advertising contains digital content selected from the group consisting of:

graphical content;
multimedia content; and
video content.

27. The method of claim 21 further comprising:
closing the at least one second protected web browser process; and

upon closing the at least one second protected web browser process, automatically deleting at least one file selected from the group consisting of:

a temporary internet file;
a cookie; and
a file corrupted by malware.

28. The method of claim 21 further comprising the first web browser process initializing a plurality of second protected web browser processes, wherein each of the plurality of second protected web browser processes comprises a separate second protected memory space, and each of the plurality of second protected web browser processes are disallowed from initiating access to another one of the plurality of second protected web browser processes.

29. The method of claim 21 wherein the at least one second protected web browser process is initialized from clean system files.

30. The method of claim 21 further comprising:
executing instructions from the first web browser process on a first core of a multi-core processor; and

executing instructions from the at least one second protected web browser process on a second core of the multi-core processor.

31. The method of claim 21 wherein the data for display of the distributed website content potentially containing malware is rendered using a video processor.

32. The method of claim 21 wherein at least one file corrupted by a malware process is capable of being restored from a protected image.

33. The method of claim 32 wherein the protected image is stored at a location selected from the group consisting of:
a removable drive;
the first memory space; and
a partition on a memory device.

34. The method of claim 21 wherein the at least one second protected web browser process is capable of running a process selected from the group consisting of:

an electronic mail process;
an instant messaging process;
a gaming process; and
a reader application process.

35. The method of claim 21 wherein the portable computer comprises an intelligent cellular telephone with a built-in secure web browser.

36. A method of operating a portable computer based system employing a common operating system and configured with a first memory space and a second protected memory space and at least one electronic data processor, comprising:

storing at least one system file within the first memory space;

downloading website content potentially containing malware from a network of one or more computers using a secure web browser process, wherein the secure web browser process is configured to execute on the at least one electronic data processor, and comprises a first web browser process and at least one second protected web browser process, the first web browser process and the at

least one second protected web browser process being configured to access the website content via the network of one or more computers;
 executing instructions in the first web browser process, wherein the first web browser process is configured to access data contained in the first memory space and to initialize the at least one second protected web browser process;
 passing data from the first web browser process to the at least one second protected web browser process;
 executing instructions in the at least one second protected web browser process, wherein the at least one second protected web browser process is configured to access data contained in the second protected memory space and to execute instructions from the downloaded website content, wherein the downloaded website content is capable of accessing the second protected memory space but is denied access to the first memory space;
 displaying digital content generated by the secure web browser process;
 wherein the secure web browser process is configured such that the at least one system file residing on the first memory space is protected from corruption by website content potentially containing malware downloaded from the network and executing as part of the at least one second protected web browser process.

37. The method of claim 36 wherein the first web browser process is configured to directly exchange data with a network interface device and with the at least one second protected web browser process.

38. The method of claim 37 wherein the first web browser process is configured to pass website content downloaded from the network to the at least one second protected web browser process.

39. The method of claim 36 wherein the at least one second protected web browser process is configured to directly exchange data with a network interface device and with the first web browser process.

40. The method of claim 36 wherein the website content potentially containing malware comprises internet advertising.

41. The method of claim 40 wherein the internet advertising contains digital content selected from the group consisting of:

- graphical content;
- multimedia content; and
- video content.

42. The method of claim 40 wherein the internet advertising is downloaded from a search engine website.

43. The method of claim 36 further comprising:
 closing the at least one second protected web browser process;
 upon closing the at least one second protected web browser process, automatically deleting at least one file selected from the group consisting of:

- a temporary internet file;
- a cookie; and
- a file corrupted by malware.

44. The method of claim 36 further comprising blocking attempts by malware to record data entry by a computer user.

45. The method of claim 36 further comprising the first web browser process opening a plurality of second protected web browser processes, wherein each of the plurality of second protected web browser processes comprises a separate second protected memory space, and each of the plurality of second protected web browser processes are disallowed from

initiating access to another one of the plurality of second protected web browser processes.

46. The method of claim 36 wherein the at least one second protected web browser process is initialized from clean system files.

47. The method of claim 36 wherein the at least one second protected web browser process is capable of accessing the first memory space only with the permission of a computer user.

48. The method of claim 36 wherein at least one user file residing on the first memory space is protected from being read by a malware process downloaded from the network and executing as part of the at least one second protected web browser process.

49. The method of claim 36 further comprising:
 executing instructions from the first web browser process on a first core of a multi-core processor; and
 executing instructions from the at least one second protected web browser process on a second core of the multi-core processor.

50. The method of claim 36 wherein the digital content is rendered using a video processor.

51. The method of claim 36 wherein the at least one second protected web browser process is capable of running a process selected from the group consisting of:
 an electronic mail process;
 an instant messaging process;
 a gaming process; and
 a reader application process.

52. The method of claim 36 wherein the portable computer based system comprises an intelligent cellular telephone with a built-in secure web browser.

53. A portable computer based system employing a common operating system for protecting critical files from malicious software attacks via a network of one or more computers, comprising:
 a first web browser process capable of executing instructions using at least one electronic data processor and further capable of accessing a first memory space, wherein the first memory space contains at least one critical file; and
 at least one second protected web browser process capable of executing instructions using the at least one electronic data processor and further capable of accessing a second protected memory space;
 the first web browser process configured to:
 accept data entry from a computer user;
 execute instructions to access website content from the network of one or more computers;
 initialize the at least one second protected web browser process; and
 pass data to the at least one second protected web browser process;
 the at least one second protected web browser process configured to:
 execute instructions for the display of the website content downloaded from the network of one or more computers, wherein the instructions for the display of the website content potentially contain malware;
 access data contained in the second protected memory space, wherein the instructions potentially containing malware are capable of accessing the second protected memory space but are denied access to the first memory space; and
 generate data for display of website content downloaded from the network of one or more computers;

wherein the portable computer based system is configured such that the at least one critical file residing on the first memory space is protected from corruption by the instructions for the display of website content potentially containing malware downloaded from the network and executing as part of the at least one second protected web browser process;

wherein the portable computer based system is configured such that the at least one second protected web browser process is initialized from clean system files.

54. The portable computer based system of claim 53 wherein the first web browser process is configured to directly exchange data with a network interface device and with the at least one second protected web browser process.

55. The portable computer based system of claim 54 wherein the first web browser process is configured to pass website content downloaded from the network to the at least one second protected web browser process.

56. The portable computer based system of claim 53 wherein the at least one second protected web browser process is configured to directly exchange data with a network interface device and with the first web browser process.

57. The portable computer based system of claim 53 wherein the instructions for the display of website content potentially containing malware comprise internet advertising.

58. The portable computer based system of claim 57 wherein the internet advertising contains digital content selected from the group consisting of:

graphical content;
multimedia content; and
video content.

59. The portable computer of claim 57 wherein the internet advertising is downloaded from a search engine website.

60. The portable computer based system of claim 53 wherein the data for display of website content is rendered using a video processor.

61. The portable computer based system of claim 53 further comprising:

closing the at least one second protected web browser process;

upon closing the at least one second protected web browser process, automatically deleting at least one file selected from the group consisting of:

a temporary internet file;

a cookie; and

a file corrupted by malware.

62. The portable computer based system of claim 53 further comprising the first web browser process opening a plurality of second protected web browser processes, wherein each of the plurality of second protected web browser processes comprises a separate protected memory space, and each of the plurality of second protected web browser processes are disallowed from initiating access to another one of the plurality of second protected web browser processes.

63. The portable computer based system of claim 53 further comprising:

executing instructions from the first web browser process on a first core of a multi-core processor; and

executing instructions from the at least one second protected web browser process on a second core of the multi-core processor.

64. The portable computer based system of claim 53 wherein the at least one second protected web browser process is automatically reinitialized from clean system files following a malware infection.

65. The portable computer based system of claim 53 further comprising an intelligent cellular telephone with a built-in secure web browser.

* * * * *

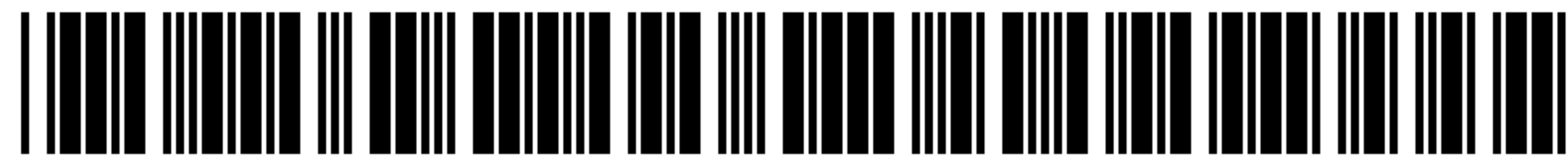

US00RE43529C1

(12) **EX PARTE REEXAMINATION CERTIFICATE** (12474th)
United States Patent
Rozman et al.

(10) **Number:** **US RE43,529 C1**
(45) **Certificate Issued:** ***Dec. 21, 2023**

(54) **SYSTEM AND METHOD FOR PROTECTING A COMPUTER SYSTEM FROM MALICIOUS SOFTWARE**

(71) Applicants: **Allen F. Rozman**, Garland, TX (US);
Alfonso J. Cioffi, Murphy, TX (US)

(72) Inventors: **Allen F. Rozman**, Garland, TX (US);
Alfonso J. Cioffi, Murphy, TX (US)

(73) Assignees: **Megan Elizabeth Rozman**, Murphy, TX (US); **Melanie Ann Rozman**, Murphy, TX (US); **Morgan Lee Rozman**, Murphy, TX (US)

Reexamination Request:

No. 90/013,969, Jun. 7, 2017

Reexamination Certificate for:

Patent No.: **Re. 43,529**
Issued: **Jul. 17, 2012**
Appl. No.: **12/941,067**
Filed: **Nov. 7, 2010**

(*) Notice: This patent is subject to a terminal disclaimer.

Related U.S. Patent Documents

Reissue of:

(64) Patent No.: **7,484,247**
Issued: **Jan. 27, 2009**
Appl. No.: **10/913,609**
Filed: **Aug. 7, 2004**

(51) **Int. Cl.**
H04L 9/40 (2022.01)
G06F 21/53 (2013.01)
G06F 21/56 (2013.01)
G06F 21/57 (2013.01)

(52) **U.S. Cl.**
CPC **H04L 63/02** (2013.01); **G06F 21/53** (2013.01); **G06F 21/568** (2013.01); **G06F 21/57** (2013.01); **H04L 63/1408** (2013.01)

(58) **Field of Classification Search**
None
See application file for complete search history.

(56) **References Cited**

To view the complete listing of prior art documents cited during the proceeding for Reexamination Control Number 90/013,969, please refer to the USPTO's Patent Electronic System.

Primary Examiner — Roland G Foster

(57) **ABSTRACT**

In a computer system, a first electronic data processor is communicatively coupled to a first memory space and a second memory space. A second electronic data processor is communicatively coupled the second memory space and to a network interface device. The second electronic data processor is capable of exchanging data across a network of one or more computers via the network interface device. A video processor is adapted to combine video data from the first and second electronic data processors and transmit the combined video data to a display terminal for displaying the combined video data in a windowed format. The computer system is configured such that a malware program downloaded from the network and executing on the second electronic data processor is incapable of initiating access to the first memory space.

Attention is directed to the decision of *Cioffi, et al. v. Google, LLC*, Case No. 2018-1049 (Fed. Cir. 2022), cert. denied Nov. 13, 2023 (23-421). This reexamination may not have resolved all questions raised by this decision. See 37 CFR 1.552(c) for *ex parte* reexamination and 37 CFR 1.906(c) for *inter partes* reexamination.

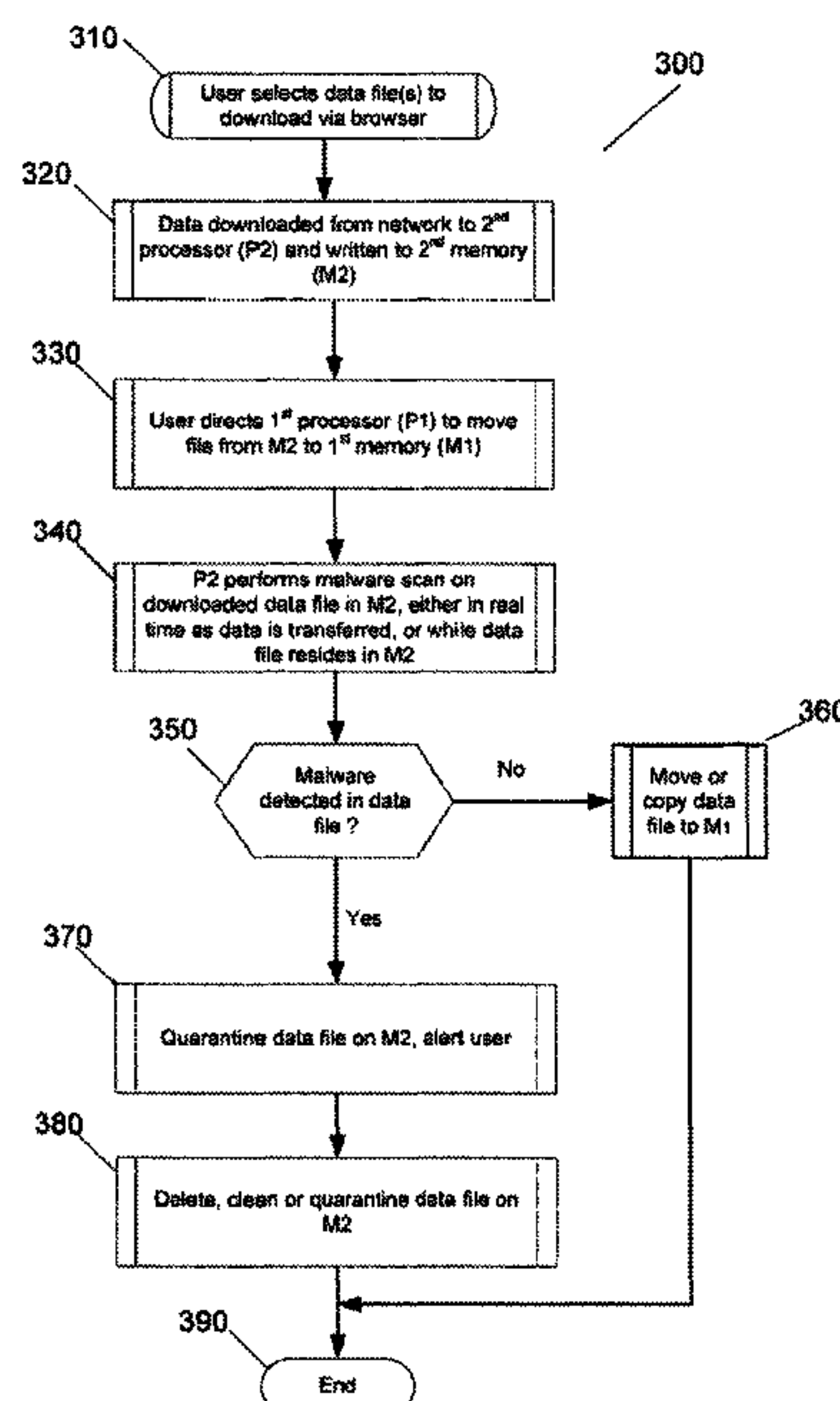

1
EX PARTE
REEXAMINATION CERTIFICATE

THE PATENT IS HEREBY AMENDED AS 5
INDICATED BELOW.

AS A RESULT OF REEXAMINATION, IT HAS BEEN
DETERMINED THAT:

The patentability of claims **21-48**, **50-52**, **54-56** and **62** is 10
confirmed.

Claims **1-20** were previously cancelled.

Claims **53**, **57-61** and **63-65** are cancelled.

Claim **49** was not reexamined. 15

* * * * *