

US00RE43007E

(19) **United States**
(12) **Reissued Patent**
Lalonde et al.

(10) **Patent Number:** **US RE43,007 E**
(45) **Date of Reissued Patent:** **Dec. 6, 2011**

(54) **COOLING SYSTEM**

(75) Inventors: **Jean-Pierre Lalonde**, Candiac (CA);
Marwan Abboud, Pierrefonds (CA);
Rachid Mahrouche, Lasalle (CA); **Dan Wittenberger**, L'ile Bizard (CA)

(73) Assignee: **Medtronic Cryocath LP**, Toronto, Ontario (CA)

(21) Appl. No.: **12/173,536**

(22) Filed: **Jul. 15, 2008**

Related U.S. Patent Documents

Reissue of:

(64) Patent No.: **6,635,053**
Issued: **Oct. 21, 2003**
Appl. No.: **09/638,208**
Filed: **Aug. 11, 2000**

U.S. Applications:

(63) Continuation-in-part of application No. 09/489,646, filed on Jan. 24, 2000, now Pat. No. 6,383,180.
(60) Provisional application No. 60/117,175, filed on Jan. 25, 1999.

(51) **Int. Cl.**
A61B 18/02 (2006.01)

(52) **U.S. Cl.** **606/22; 606/23; 606/25**

(58) **Field of Classification Search** 606/22-26;
128/DIG. 27

See application file for complete search history.

(56) **References Cited**

U.S. PATENT DOCUMENTS

6,235,048 B1 * 5/2001 Dobak, III 606/23
6,241,722 B1 * 6/2001 Dobak et al. 606/23
6,306,129 B1 * 10/2001 Little et al. 606/23

* cited by examiner

Primary Examiner — Lee S Cohen

(74) *Attorney, Agent, or Firm* — Christopher & Weisberg, P.A.

(57) **ABSTRACT**

A cryogenic medical system includes a medical device and a console connectable to the medical device at a connection point. The console controls the temperature of the medical device. The console includes a first cooling system directing coolant to the medical device at a first temperature along a coolant supply line and a second cooling system chilling the coolant within the coolant supply line to a temperature below the first temperature before the coolant reaches the connection point.

12 Claims, 10 Drawing Sheets

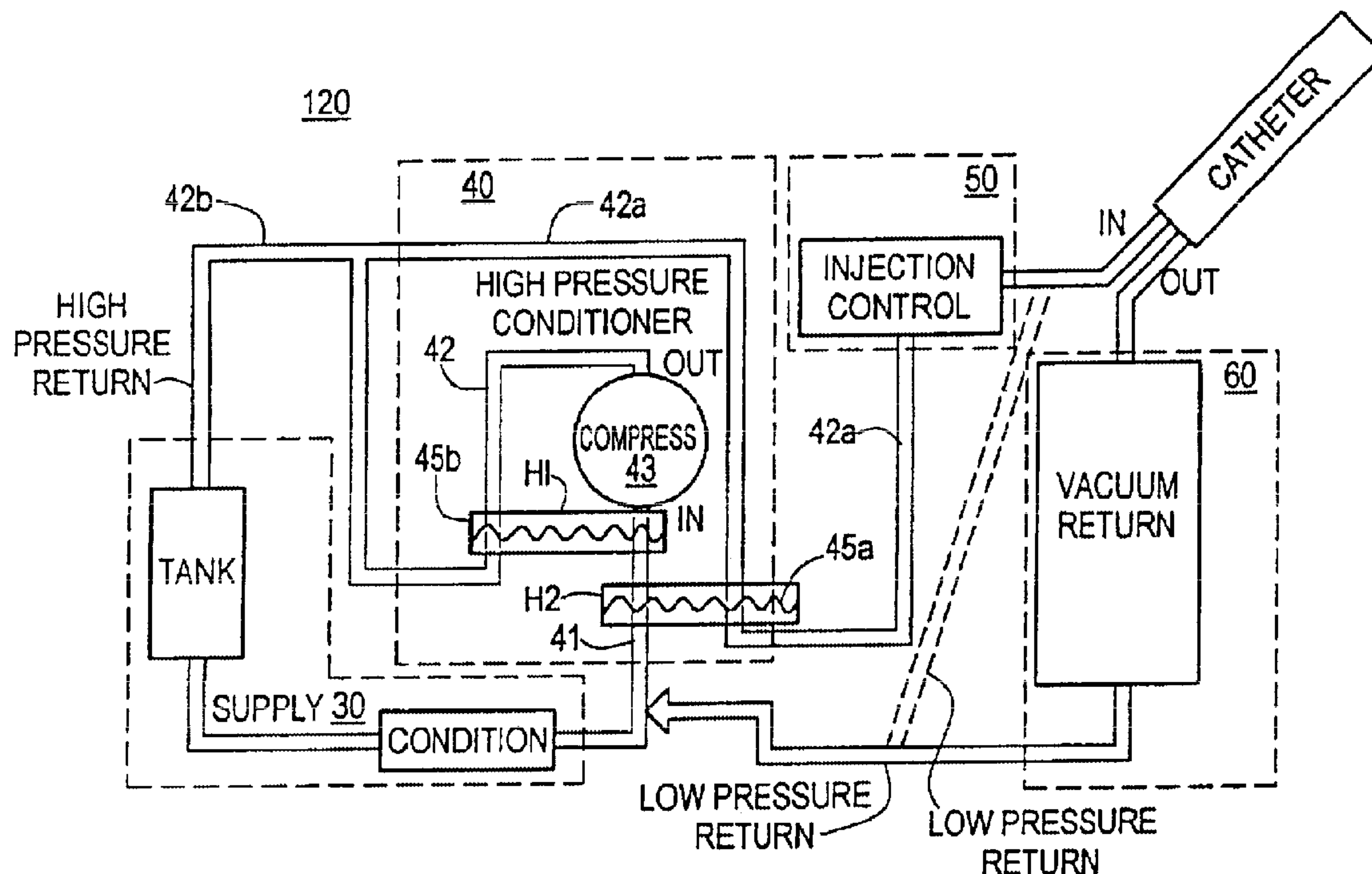

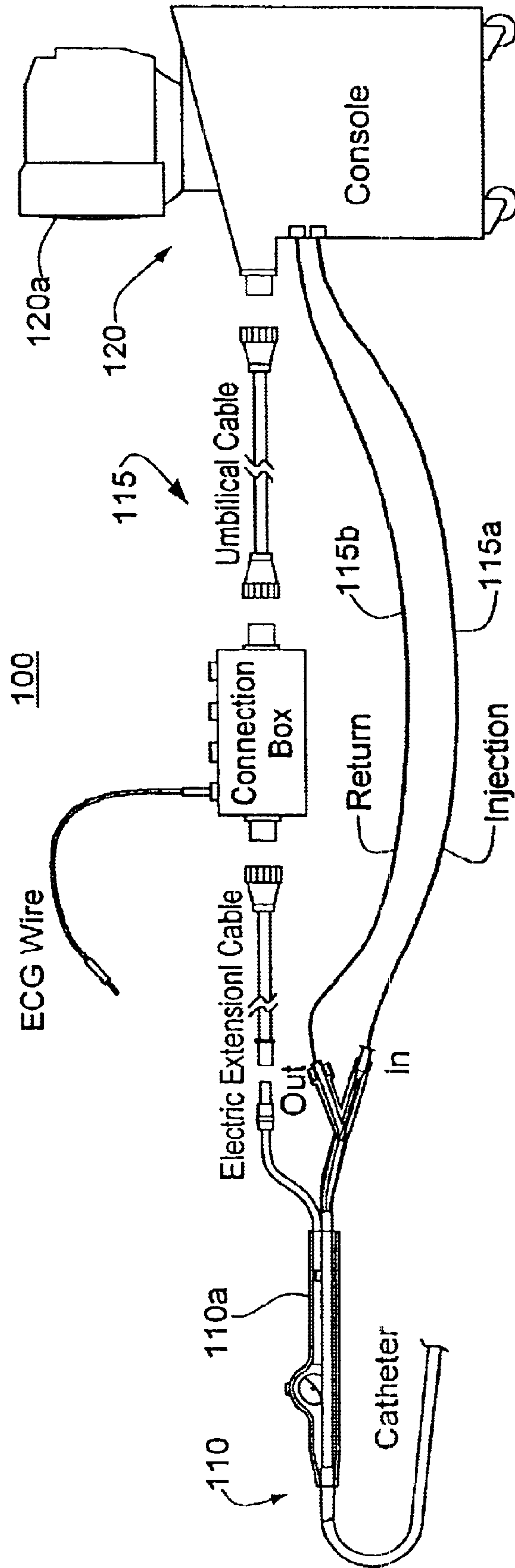

FIG. 1

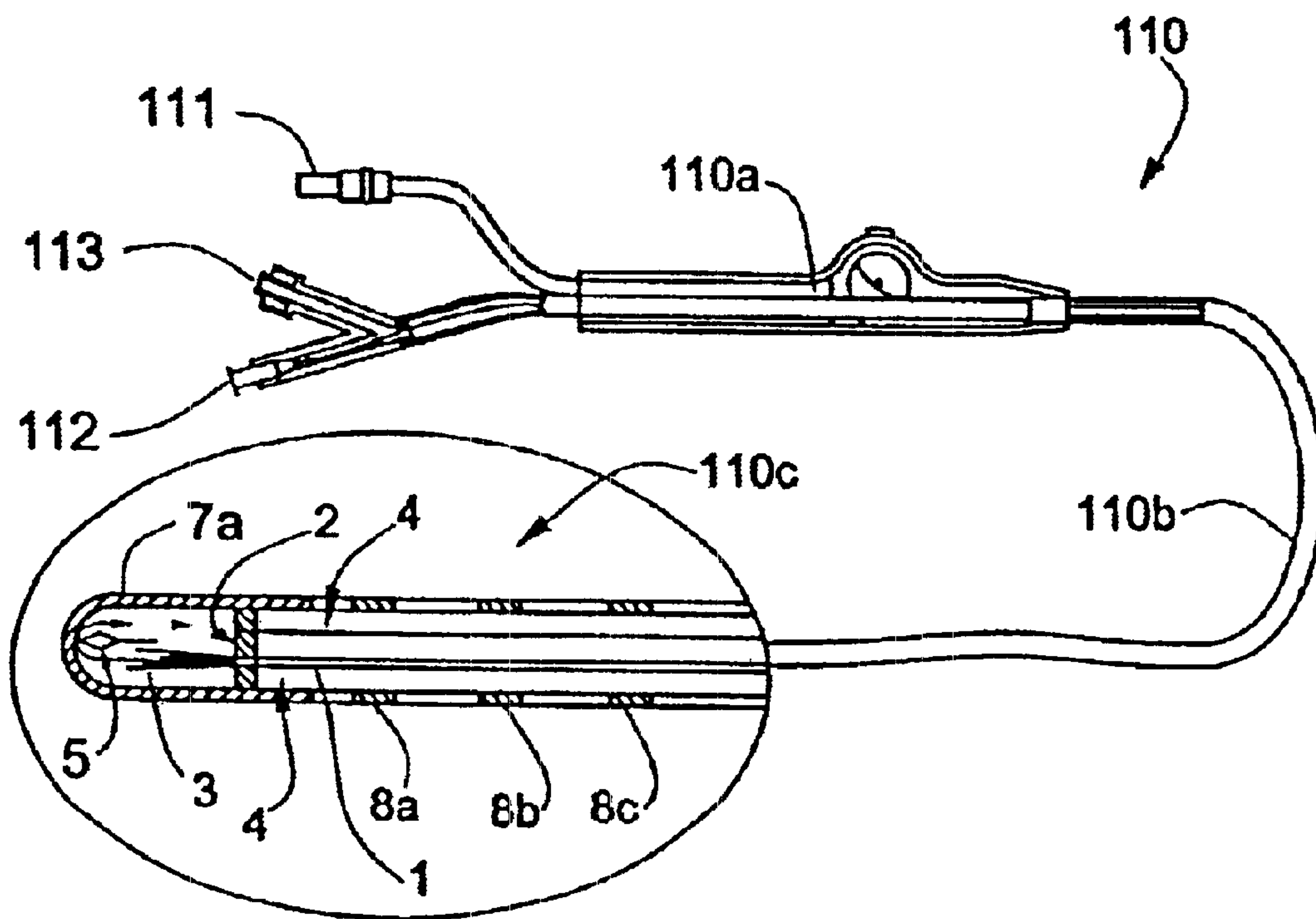

FIG. 1A

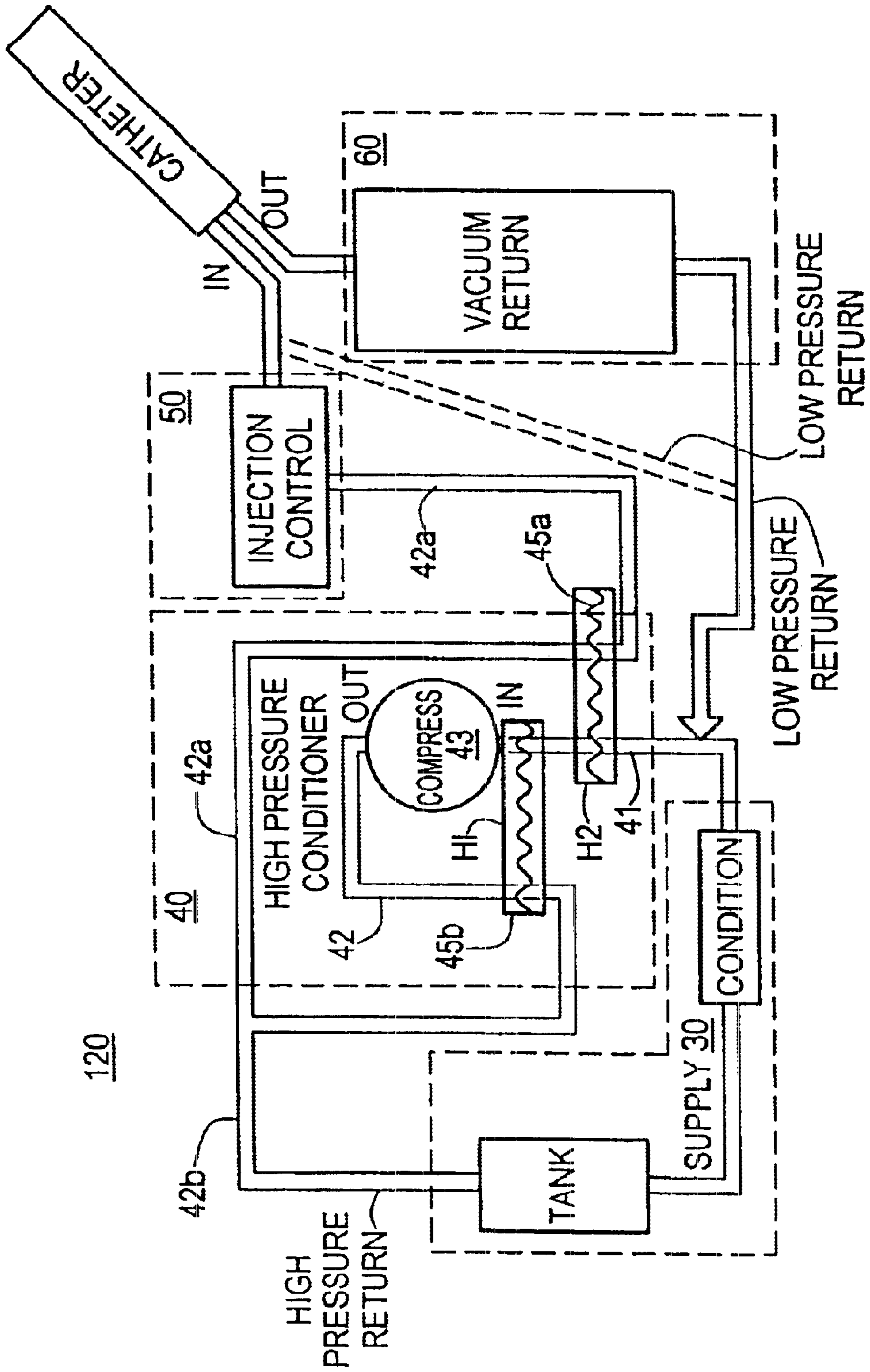

FIG. 2

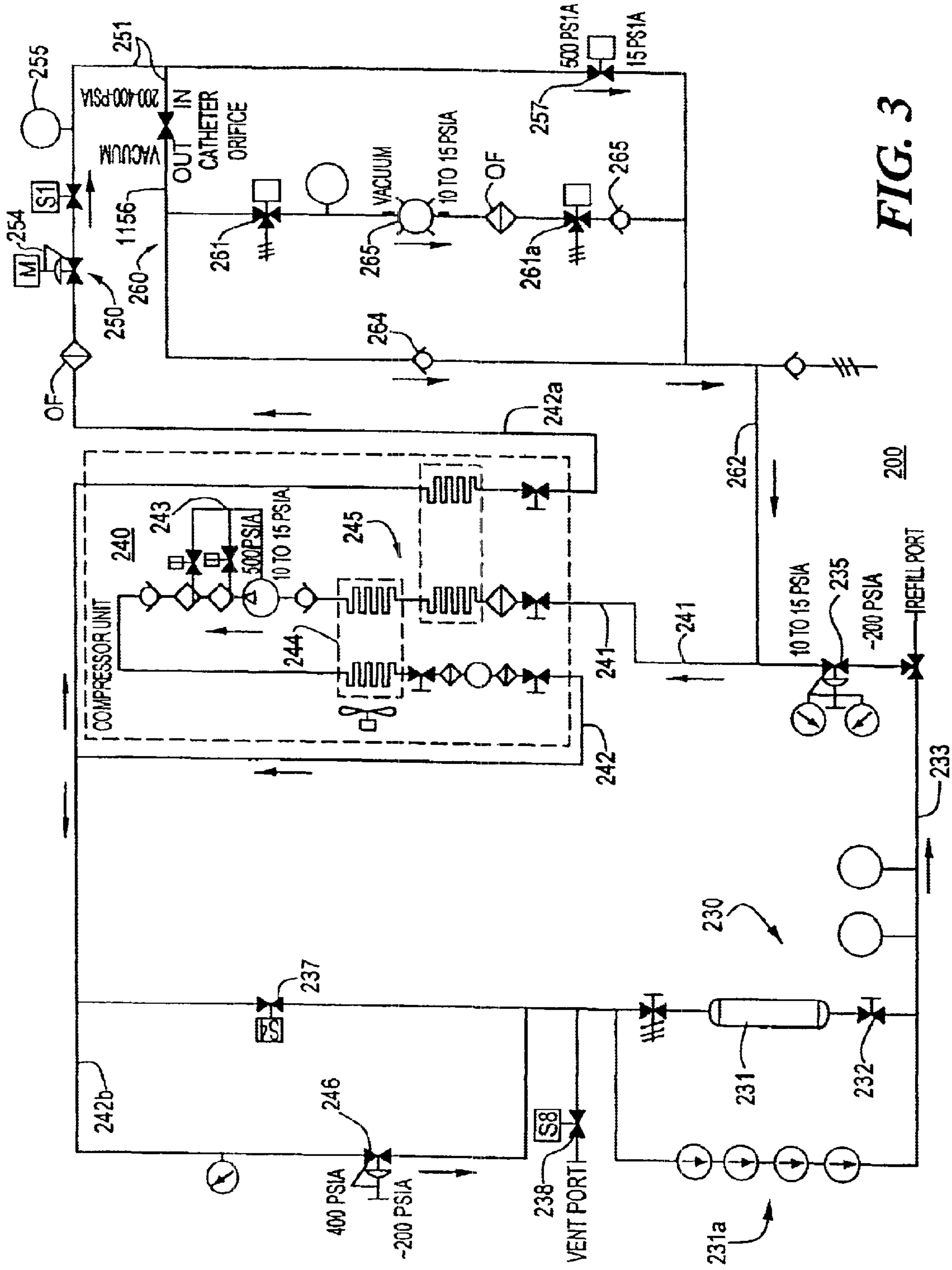
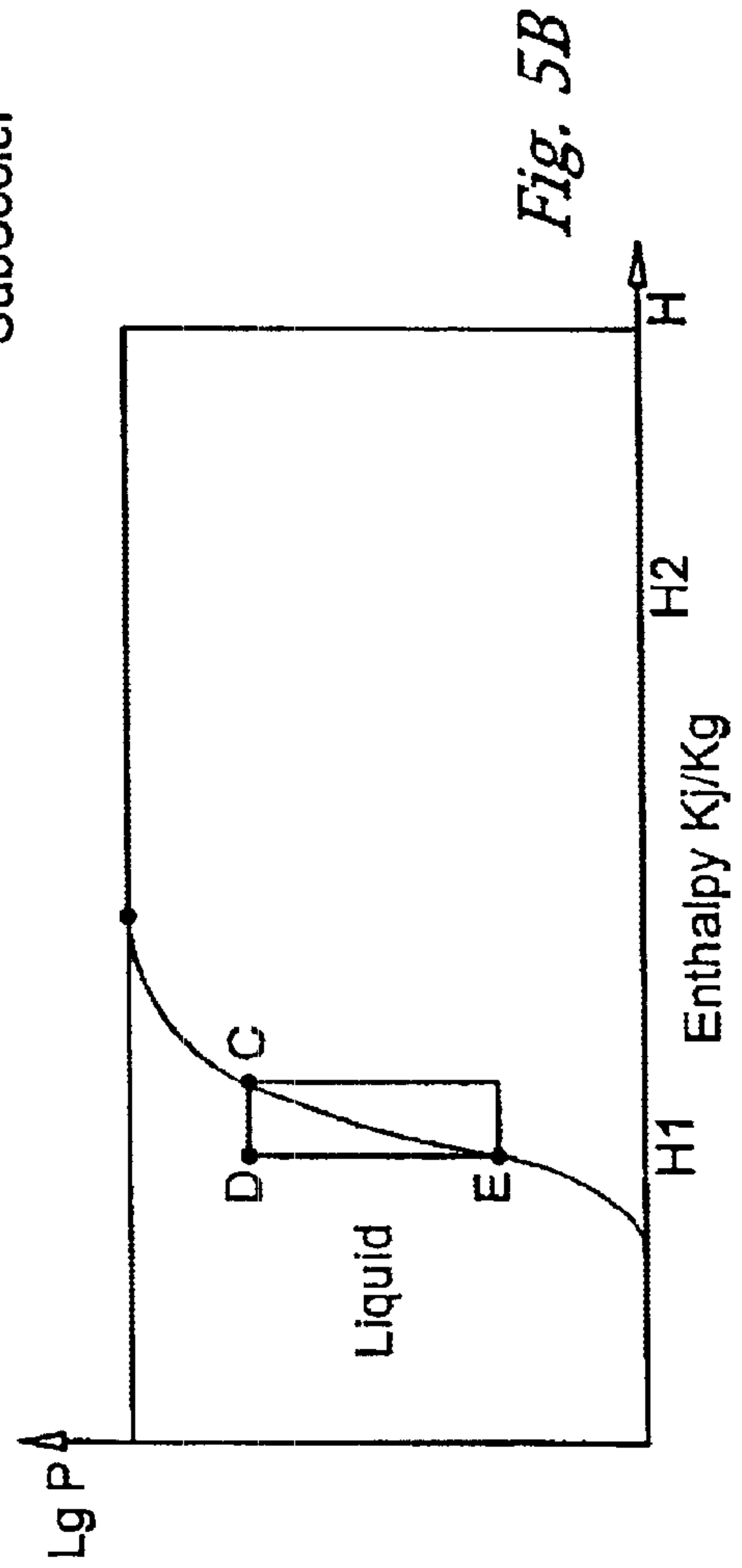
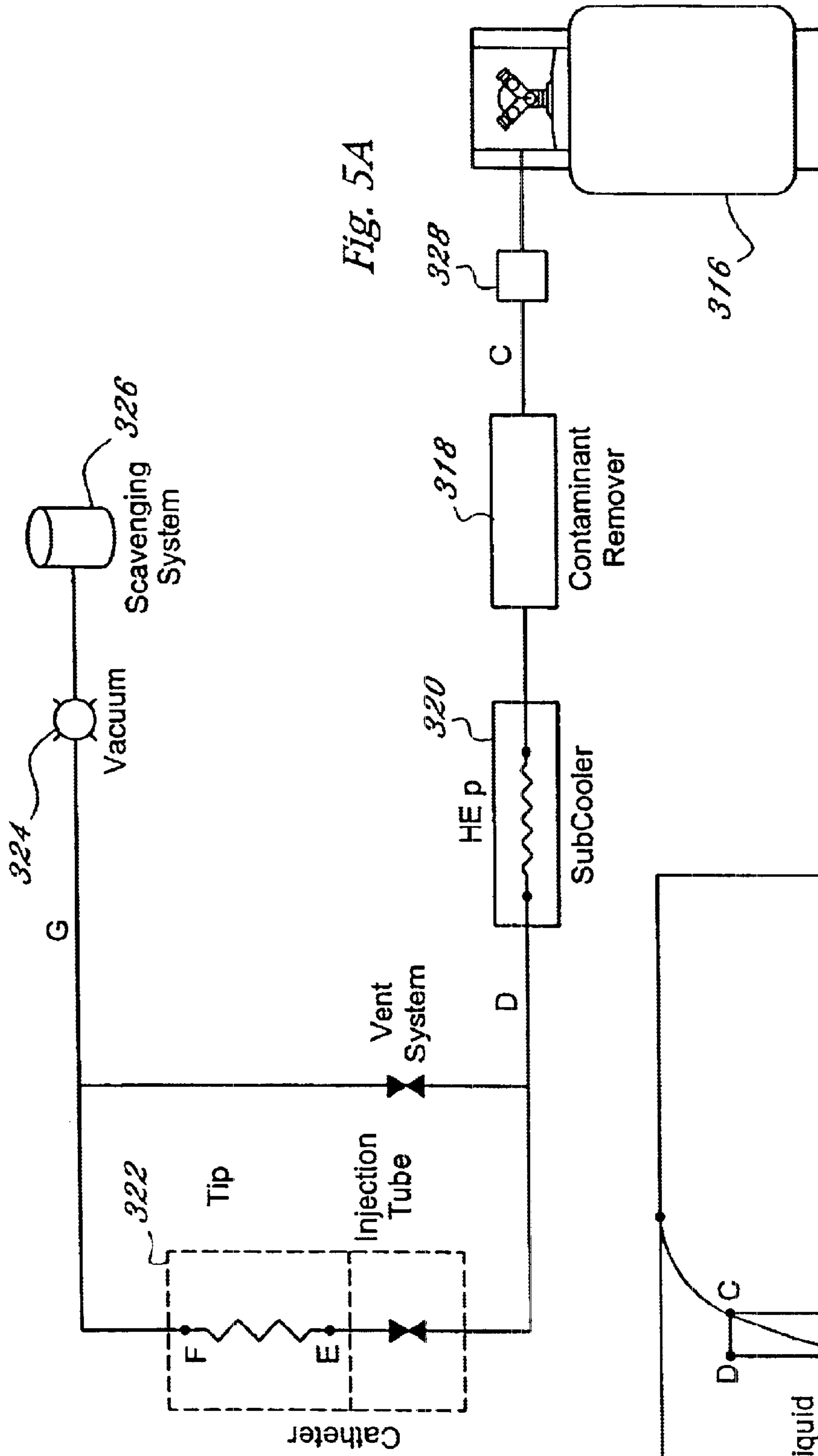
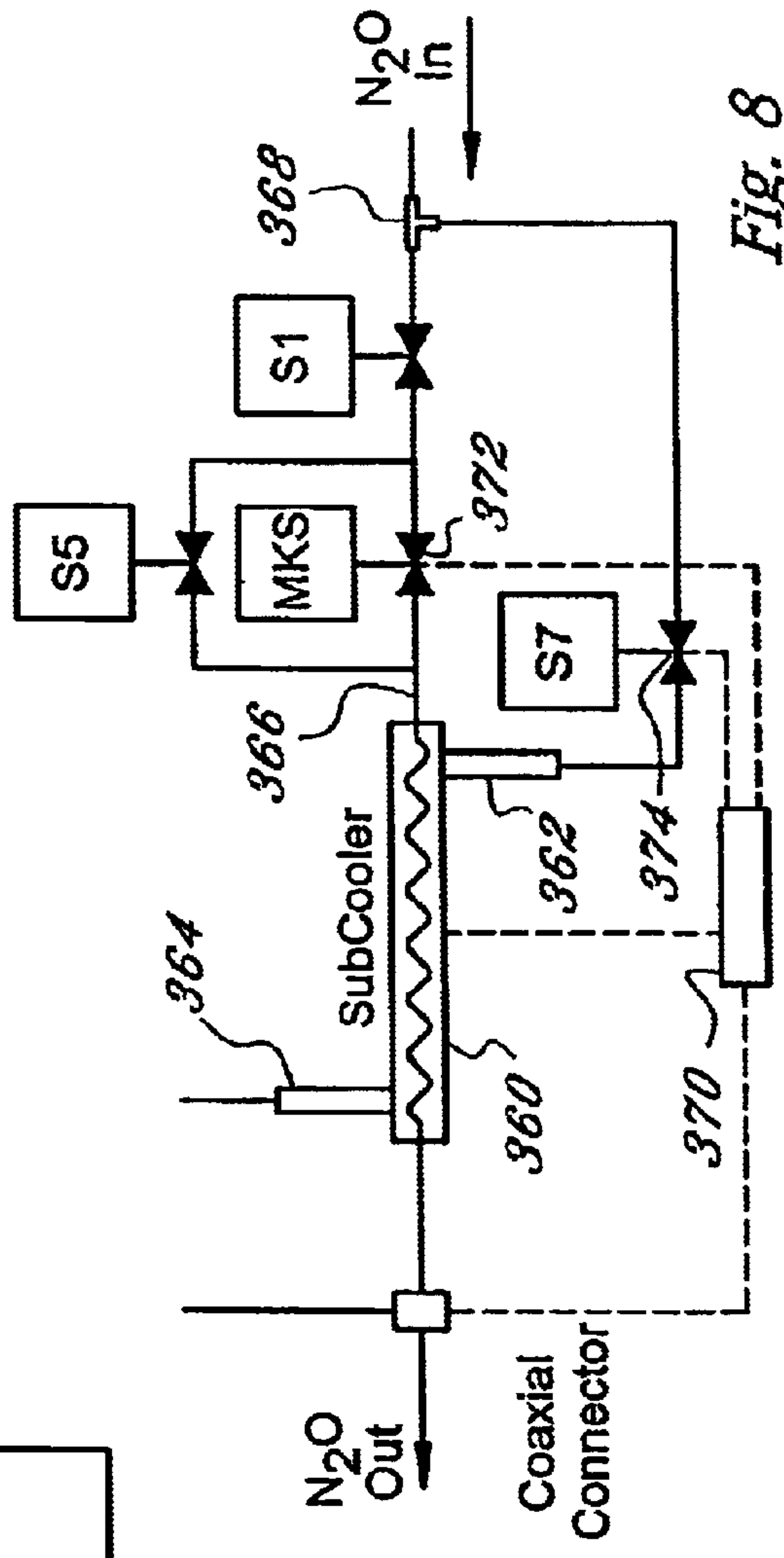
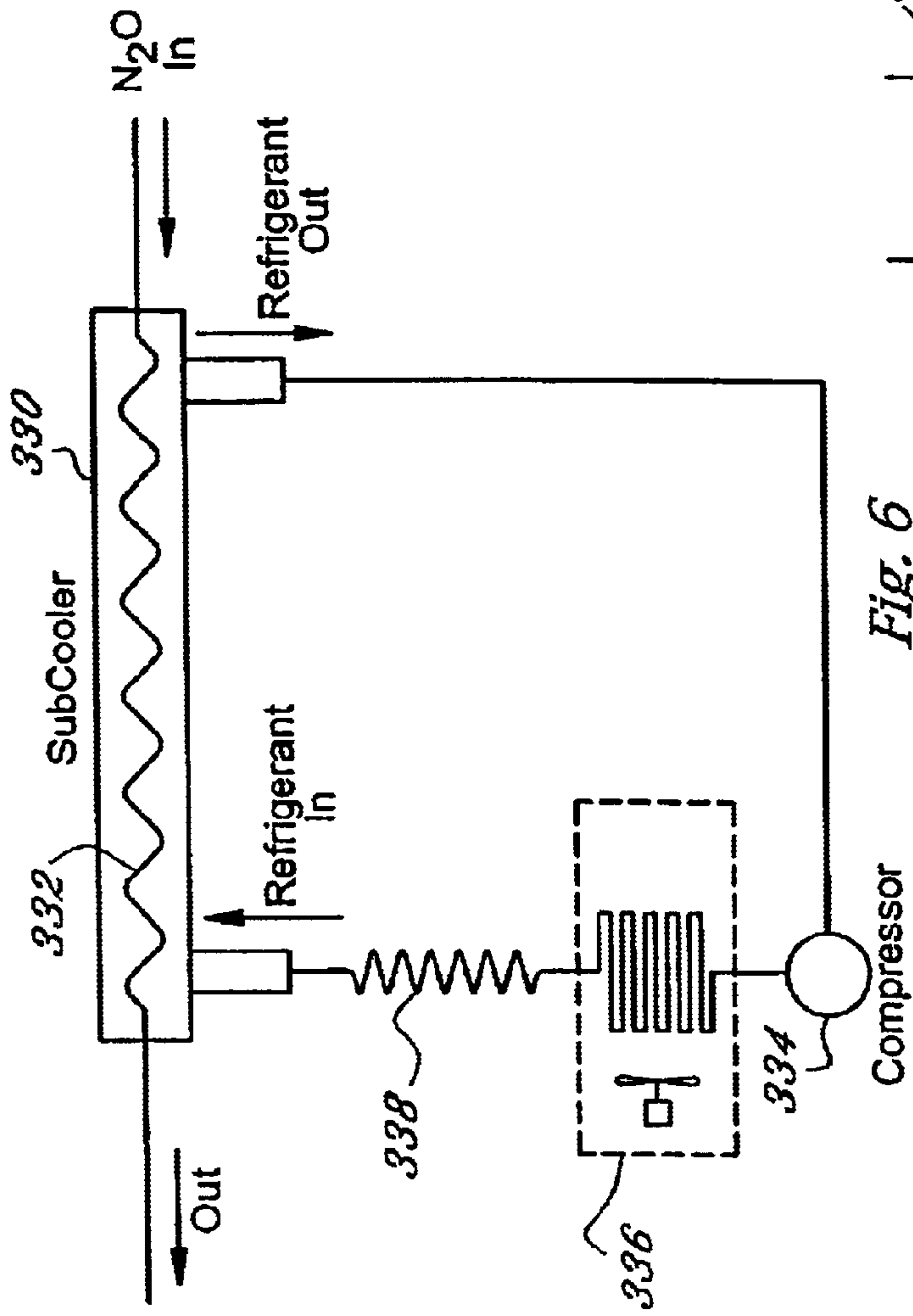

FIG. 3





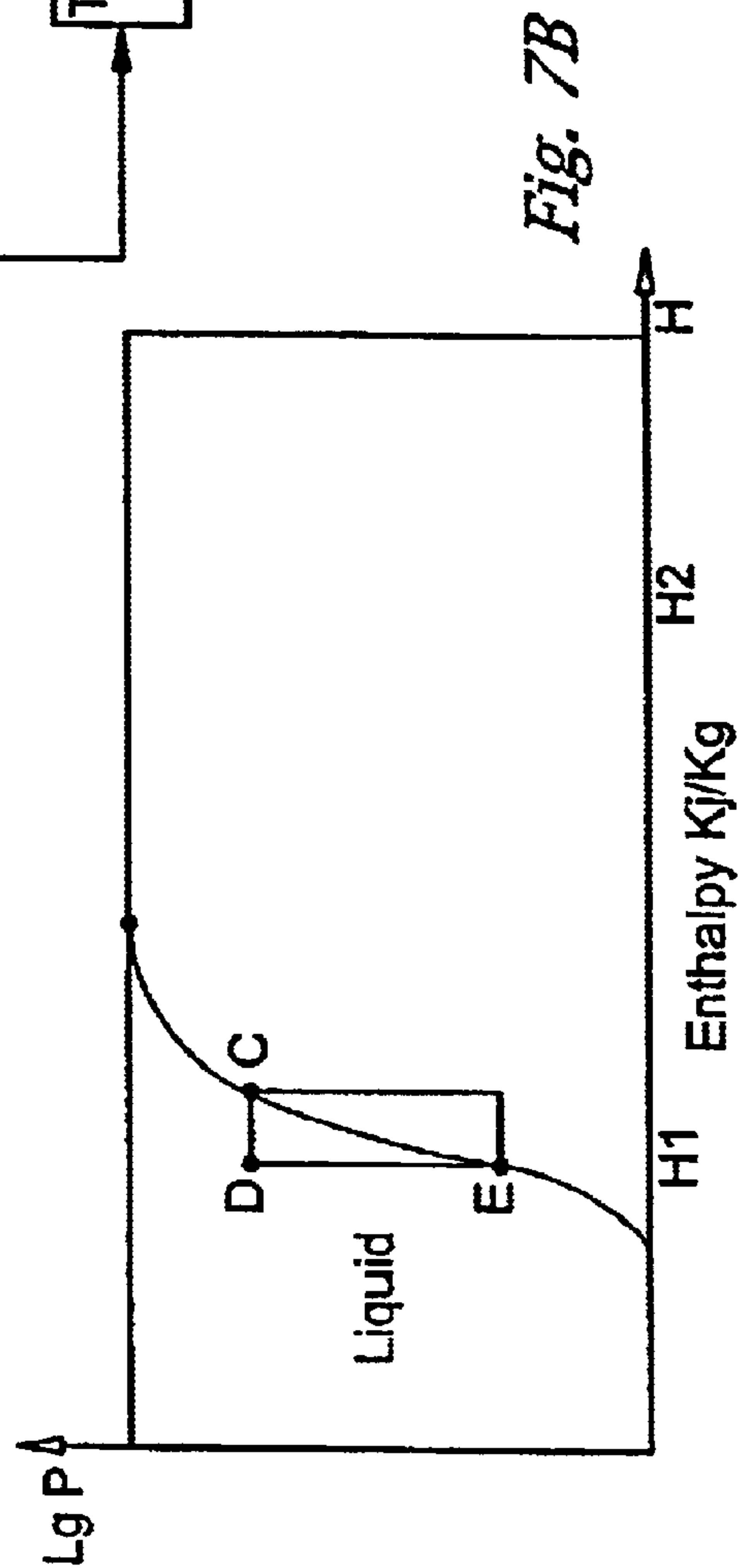
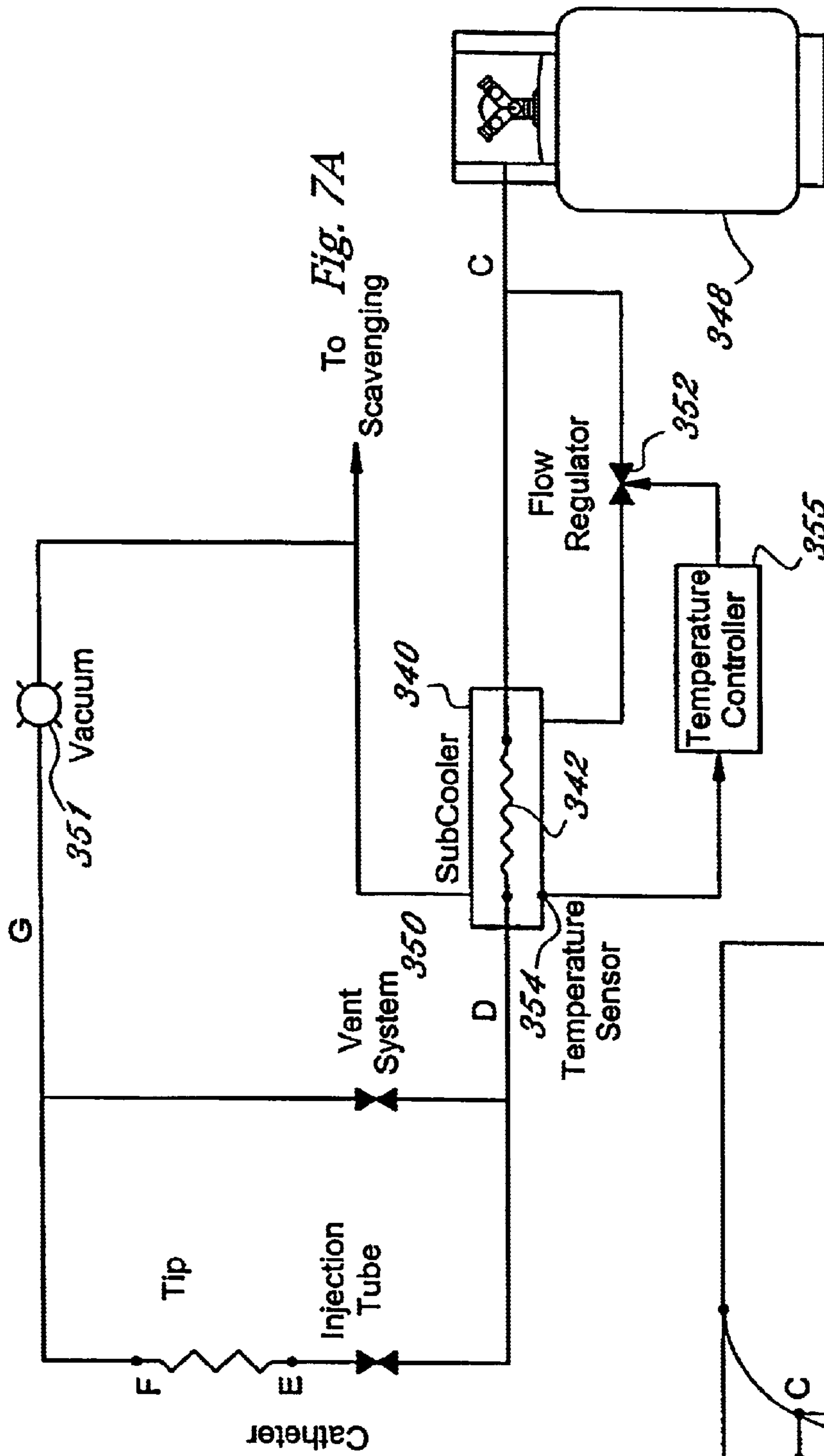

Fig. 7B

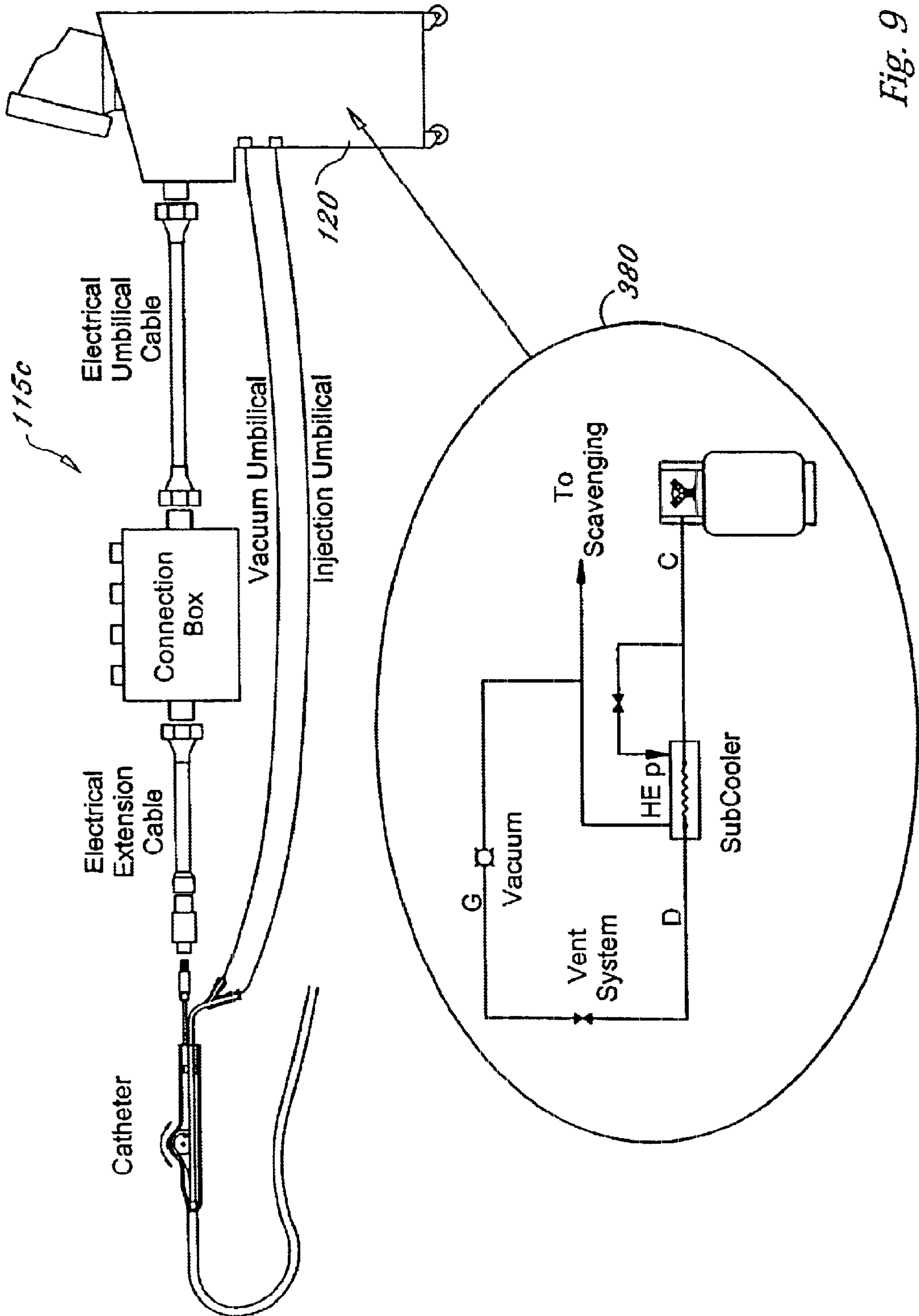

Fig. 9

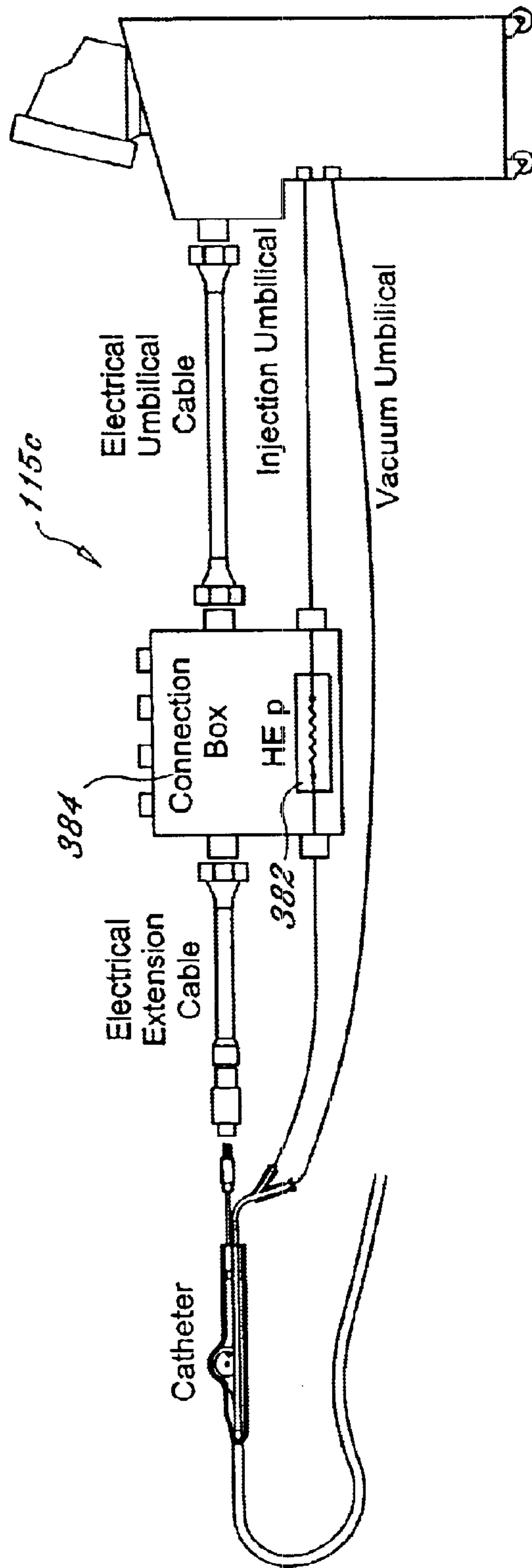

Fig. 10

COOLING SYSTEM

Matter enclosed in heavy brackets [] appears in the original patent but forms no part of this reissue specification; matter printed in italics indicates the additions made by reissue.

CROSS-REFERENCE TO RELATED APPLICATIONS

This application is a continuation-in-part of U.S. patent application Ser. No. 09/489,646, filed Jan. 24, 2000, now U.S. Pat. No. 6,383,180 which claims priority from U.S. Provisional Patent Application No. 60/117,175, filed on Jan. 25, 1999.

STATEMENT REGARDING FEDERALLY SPONSORED RESEARCH

Not Applicable.

FIELD OF THE INVENTION

The present invention relates to a coolant system for a catheter or treatment wand used for cryotreatment of tissue. In particular, the coolant system is of the type which connects to a catheter and pumps coolant through the catheter to chill a region of the catheter, such as the distal tip, for treating tissue.

BACKGROUND OF THE INVENTION

A number of cooled catheter systems have been developed for treating tissue in a cardiac setting, either to cool the tissue sufficiently to stun it and allow cold mapping of the heart and/or confirmation of catheter position with respect to localized tissue lesions, or to apply a more severe level of cold to ablate tissue at the site of the catheter ending. In general, the range of treatments which may be effected by a cryocatheter is comparable to the range of applications for radio frequency or thermal ablation catheters, and in particular, these instruments may be configured to achieve either small localized ball shape lesions at the tip of the catheter, or one or more elongated linear lesions extending a length of several centimeters or more along the tip. The latter form of lesion is commonly used to achieve conduction block across a region of the cardiac wall so as to sever an aberrant pathway over a length preventing conduction across the region, in order to change the cardiac signal path topology, for example, to eliminate a faulty pathway responsible for atrial fibrillation or a tachycardia.

In general, when used for endovascular access to treat the cardiac wall, catheters of this type, in common with the corresponding earlier-developed radio frequency or electrothermal ablation catheter, must meet fairly demanding limitations regarding their size, flexibility, and the factors of strength, electrical conductivity and the like which affect their safety and may give rise to failure modes in use. These constraints generally require that the catheter be no larger than several millimeters in diameter so as to pass through the vascular system of the patient to the heart. Thus, any electrodes (in the case of mapping or RF/electrothermal ablation catheters), and any coolant passages (in the case of cryocatheters) must fit within a catheter body of small size.

A number of different fluids have been used for the coolant component of prior art cryotreatment catheters, such as a concentrated saline solution or other liquid of suitably low

freezing point and viscosity, and of suitably high thermal conductivity and heat capacity, or a liquified gas such as liquid nitrogen. In all such constructions, the coolant must circulate through the catheter, thus necessitating multiple passages leading to the cooling area of the tip from the catheter handle.

Furthermore, conditions of patient safety must be considered, raising numerous problems or design constraints for each particular system. Thus for example, a high pressure may be required to circulate sufficient coolant through the catheter body to its tip and back, and the overall design of a catheter must be such that fracture of the catheter wall or leakage of the coolant either does not occur, or if it occurs, is harmless. Further, for an endovascular catheter construction, the presence of the coolant and circulation system should not substantially impair the flexibility or maneuverability of the catheter tip and body.

To some extent these considerations have been addressed by using a phase change material as the cryogenic fluid, and arranging the catheter such that the phase change, e.g., from a liquid to a gas, occurs in the treatment portion of the catheter tip. Another possible approach is to employ a pressurized gas, and configure the catheter for cooling by expansion of the gas in the tip structure. However, owing to the small size that such a catheter is required to assume for vascular insertion, or the awkwardness of handling a cryogenic treatment probe generally, the design of a safe and effective coolant circulation system which nonetheless dependably provides sufficient cooling capacity at a remote tip remains a difficult goal.

Among other common problems to be addressed while providing adequate thermal capacity, may be noted the leakage problem mentioned above, the problem of effectively preventing the catheter as a whole from being excessively cold or damaging tissue away from the intended site, and the problem of conduit or valve blockage owing for example to ice particles and the like.

Accordingly, it would be desirable to provide a coolant system which conveniently attaches to a cryocatheter.

It would also be desirable to provide a coolant system which injects and retrieves the coolant from the catheter to allow continuous operation without leakage into the environment or other loss of coolant.

It would further be desirable to provide a treatment system which precisely controls ablation and treatment regimens by conditioning the coolant supply at various point along the fluid path.

SUMMARY OF THE INVENTION

These and other desirable features are obtained in a coolant system that includes a medical device and a console connectable to the medical device at a connection point. The console controls the temperature of the medical device. The console includes a first cooling system directing coolant to the medical device at a first temperature along a coolant supply line and a second cooling system chilling the coolant within the coolant supply line to a temperature below the first temperature before the coolant reaches the connection point.

BRIEF DESCRIPTION OF DRAWINGS

These and other features of the invention will be understood by reference to the description below, read in light of the prior art together with illustrative figures, wherein:

FIGS. 1 and 1A illustrate a cryocatheter treatment system and cryocatheter;

3

FIG. 2 is a schematic representation of a coolant system in accordance with one embodiment of the present invention for use with the catheter of FIG. 1;

FIG. 3 is a detailed schematic of another implementation of the coolant system of the present invention;

FIG. 4A is a schematic illustration of still another coolant system configuration;

FIG. 4B is an enthalpy graph with respect to the system of FIG. 4A;

FIG. 5A is a schematic illustration of yet another coolant system configuration;

FIG. 5B is an enthalpy graph with respect to the system of FIG. 5A;

FIG. 6 schematically represents a refrigerant subcooler that can be included in the coolant system configurations of the invention;

FIG. 7 illustrates another configuration for a subcooler;

FIG. 8 illustrates still another configuration for a subcooler;

FIG. 9 illustrates an exemplary system in accordance with the invention; and

FIG. 10 illustrates yet another system in accordance with the invention.

DETAILED DESCRIPTION OF INVENTION

FIG. 1 shows a cryogenic treatment system **100** illustrating the general elements thereof. System **100** includes a treatment catheter **110** having a handle **110a**, a treatment console **120** and number of connecting lines **115** which include signal lines for any monitoring or mapping functions as well as a coolant injection line **115a** and a coolant return line **115b**. As illustrated, the console includes a display screen **120a** which may, for example, show both cardiac electrical signals and various status and control screens related to setting or reporting the cooling functions of the catheter or the ablation regimens being administered therewith.

FIG. 1A shows in slightly greater detail a catheter **110** used in a system in accordance with the present invention. As shown, the handle **110a** is equipped with input ports for an electrical connector **111**, a coolant injection tube connector **112**, and a return tube connector **113**. These connect via various internal junctions or tubes passing through the handle to provide these three functions to the distal tip of the catheter. The handle may also include various control assemblies, e.g., switches or valves, as well as safety detection or shut down elements (not illustrated).

Leading from the handle **110a** is an elongated catheter body **110b** which extends to the catheter tip **110c**, illustrated in enlarged detail to show a representative structure thereof. As shown, in catheter tip **110c** the coolant enters through a central tube **1** and exits via a nozzle **2** at the end of the tube to expand in a small contained region forming a chamber **3** at the tip of the catheter. In the illustrated construction, the tube **1** runs concentrically within an outer tube (not numbered) thereby forming an annular return space **4** surrounding the supply tube **1** and extending back to the fluid return connector **113** of the handle. As discussed further below, the return passage for expended coolant is a vacuum passage, thus assuring that leakage into the blood stream cannot occur.

The location of chamber **3** defines the cooling region of the catheter tip. In the illustrated embodiment this is a short chamber less than a centimeter long located at the very tip of the catheter. Also shown are a thermocouple **5** positioned within the tip to sense tip temperature, and a plurality of electrodes including a tip electrode **7a** and one or more ring electrodes **8a**, **8b** . . . which are positioned near the tip for use

4

in mapping and/or detecting cardiac signals. In other embodiments, the chamber **3** defined at the tip of the catheter may be an elongated chamber several centimeters in length for defining a coolant chamber effective to form linear lesions when placed in contact with tissue such as the cardiac wall. For the linear embodiment, multiple expansion nozzles, a perforated inlet tube end segment, or other variation in the construction of the coolant supply line may be used to assure a high rate of cooling along the full length of the expansion chamber. Furthermore, the chamber wall may be very thin, or formed with a metal sleeve or cap to achieve high heat transfer rates. Other structures within the catheter may include torque or steering wires, or other elements conventional in the art for navigation of the catheter past branch points in vessels, and for urging the catheter tip into contact with a wall once its position is confirmed.

As will be understood from the above, the task of the console is to provide coolant at the tip region in sufficient quantity and for times effective to create the desired lesions. The nature and depth of the lesions created will depend on a number of factors, including the temperature attained in the adjacent tissue, as well as the nature of the cooling cycle by which that temperature is attained. In general when the tissue attains an extremely low temperature, or a temperature effective to create ice crystals within tissue cells, the tissue damage will be irreversible, resulting in effective ablation at the contacted site. The actual cooling rates achieved at the tip will depend to a large extent on the area of contact with the tissue as well as the conductive properties of the adjacent tissue and the structure and geometry of the catheter in addition to the nature of coolant flow passing through the catheter tip. In the present system the latter quantity is controlled, as discussed more fully below, by providing a controller in which the flow of a phase change coolant supplied to the tip is varied to directly control the amount of cooling power available during an ablation cycle. In addition, the primary cooling effect is achieved by expansion of coolant at the inlet nozzle **2** as it enters chamber **3**.

While not illustrated, one or more electrical sensing elements in addition to the thermocouple may be provided at various places within the catheter to provide useful feedback or emergency control functions. For purposes of the present patent application, such functions will not be further discussed. However, if provided they may be positioned in a discrete cooling system, which for purposes of illustration may be considered to lie entirely within the console **120**, or be external thereto, but in any case to function in relation to the coolant supply elements which will now be described below.

FIG. 2 illustrates one embodiment of a cooling system in accordance with the present invention configured to connect to the inlet and return ports **112**, **113** of the catheter **110** (FIG. 1A). As shown, the coolant system **120** includes a coolant supply **30**, a coolant conditioner **40**, a coolant control **50** and a coolant return section **60**. The control section **50** connects to the inlet **112** of the injection catheter, for example by a supply tube, while the return system **60** connects to coolant return port **113**. These are illustrated as separate connections, but as discussed more fully below, they may be implemented with a single vacuum-jacketed line with a quick connect coupler, or other specialized connection which allows a single coupling to the catheter handle for all coolant functions. Similarly, electrical connections may be incorporated in such a single conduit, or may be provided as separate signal cabling. Operation of the coolant system **120** will be most fully understood from a detailed discussion of each of the subassemblies **30**, **40**, **50**, **60**.

In general terms, the coolant system has a coolant conditioning section **40** with a compressor that provides a conditioned phase change coolant at elevated pressure to the control section **50**, which, in turn, regulates the supply of coolant provided to the inlet of the catheter. The return section **60** includes a vacuum pump which continuously draws expended coolant from the catheter at lower pressure and returns it at higher pressure to the coolant conditioner **40**, thereby providing a closed circulation loop through the catheter to meet the required ablation or mapping regimens. In the preferred embodiment, the conditioner provides coolant substantially at ambient temperature or colder, and the controller includes an electronically controlled pressure regulator which sets the flow rate of the coolant injected into the catheter, thus regulating the cooling action of the catheter tip. Conditioned coolant is provided to the control section by the conditioner **40**, which receives coolant at lower pressure either from the return section **60** or from the supply **30**, compresses the coolant to a high pressure, liquefies the coolant, and brings it to approximately ambient temperature at its outlet line **42a** leading to the controller. As further shown in FIG. 2, the output from the compressor has a second branch **42b** in which excess coolant is not further cooled, but is simply returned to the supply **30**.

As noted above, conditioner section **40** in addition to the raising the pressure of the coolant supplied to the regulator for controlled injection into the catheter, also conditions the temperature of the high pressure coolant. This is preferably done as shown in FIG. 2, by heat exchange between the inlet supply line **41** and the compressor outlet line **42**. As shown in the figure, the compressor outlet line **42** is placed in heat exchange communication, for example via a condenser or heat exchanger **45b**, with the inlet line **41**. In addition one output branch **42a** of the outlet line **42** is placed in heat exchange communication, for example via exchanger **45a**, with an upstream portion of the inlet line **41**. The compressor **43** operates to compress the coolant from a relatively low pressure, preferably below atmospheric, to a considerably higher pressure, e.g., 20 to 30 atmospheres as measured in its outlet line **42**. The material in line **42** is therefore heated by compression, and the heat exchange with inlet line **41** serves to reduce the temperature rise generated by compression. Furthermore, by providing only a portion of compressor output, namely the catheter-directed branch **42a** to the upstream, colder portion of the compressor inlet line **41**, the catheter injection supply of coolant is effectively brought to or near ambient temperature or colder, while the downstream heat exchange effected in heat exchanger **45b** with the entire output of the compressor is cooled to a lesser extent, serving a more traditional function of liquefying the coolant output and enhancing the overall cooling capacity of the compressed fluid. This ordered heat exchange arrangement provides preferentially greater cooling to the catheter-directed supply line, resulting in a stabilized catheter input over a broader range of operating cycles.

In FIG. 2 the high pressure return **42b** to the tank may be implemented with a pressure regulator located in-line ahead of the tank inlet to assure that coolant is returned to the tank only when its use elsewhere in the circulation loop is not required, and that the pressure in the line first builds up to a level higher than the current tank pressure.

Thus, the system of the present invention provides a closed-loop coolant circulation system wherein coolant is conditioned for provision to the inlet of a control module which injects the coolant into a catheter, and the coolant returns in a closed-loop to provide a continuous circulation of fluid at ambient temperature or colder into the catheter.

FIG. 3 shows a prototype embodiment in greater detail, illustrating representative valves and regulators for implementing a preferred closed-loop coolant supply **200**. The coolant supply, compressor, control and return portions of system **200** are numbered with numerals **230**, **240**, **250**, and **260** corresponding to the related subassemblies **30**, **40**, **50** and **60** of system **20**. As shown in this embodiment, a refrigerant tank **231** equipped with a magnetic sight glass **231a** to indicate fill level, supplies refrigerant through a needle valve **232** along line **233** to a downstream pressure regulator **235**. The pressure regulator **235** converts the nominal tank pressure of several hundred pounds per square inch to a fixed level of 14 psia to provide a constant supply pressure to the inlet line **241** of the compressor. At this stage the refrigerant is boiling at a temperature of about -60° Fahrenheit. The vacuum recovery return line **262** joins the refrigerant inlet **241** at this point.

The compressor inlet line **241** passes through heat exchanger **245** en route to the compressor **243**, and also passes through a condenser **244**, so the low pressure liquid in the inlet line **241** is heated by the hot vapor coming out of the compressor, causing it to become a vapor. The compressor **243** takes the vapor and pressurizes it to about 400 psi. The pressurized output passes along line **242** through dryers **D** and sight glass **SG**, after which the high pressure outlet line bifurcates into two branches **242b** and **242a**. An upstream pressure regulator **246** in line **242b** builds and maintains pressure in the high pressure output line allowing the regulator to open and return excess refrigerant to the tank **231** when the pressure reaches a preset level, of about 400 psi, which is higher than the nominal tank pressure, e.g., 200 psi.

The second branch **242a** of the output line **242** passes through the heat exchanger **245** located in the upstream portion of the input line **241**, where it is further cooled to provide a conditioned output to the controller **250**, which as shown includes a motorized pressure regulator **254**. Pressure regulator **254** controls the flow rate of coolant provided along line **251** to the inlet port of the catheter (illustrated schematically). By way of example, the pressure regulator **254** may be controlled by a control microprocessor in the console to provide coolant at a pressure of 250 psi for a time interval of 2.5 minutes. Control is generally done by actuating the motor of regulator **254** to achieve a desired set point and leaving the regulator at that setting for the indicated time period. A zero to 500 psi pressure transducer **255** is placed in line **251** to provide feedback signals for implementing the control of the regulator **254**, which may further employ feedback from the thermocouple in the catheter.

The foregoing values of pressure and duration are given by way of example only, and it will be understood that typical cooling regimens implemented by the control console **120** (FIG. 1) may run from several seconds to five minutes or more, and that the coolant pressures which are varied to achieve a desired rate of heat transfer or effective lesion depth may vary from the coolant pressure in the tank to approximately the pressure of the compressor output line **242a**. Advantageously, the pressure in line **251** remains greater than the saturation pressure of the refrigerant being used such that it does not start to boil before it reaches the tip.

As further shown in FIG. 3, the return line **115b** from the catheter attaches to vacuum section **260**, while a solenoid operated purge valve **257** extends between the catheter inlet line **251** and the low pressure return line **262** from the vacuum scavenging system **260**. It will be understood that purge valve **257** will typically be operated to bleed the inlet line when the catheter is first attached and the supply compressor or return pump, respectively, are operated.

The return line **115b** from the catheter passes via vacuum protection solenoid operated valve **261** to a vacuum pump **265**, which maintains a vacuum in the range of 2 to 40 millibars in the return line, and which increases the pressure of the expanded coolant vapor to approximately 15 psi. At the outlet side of the vacuum pump a similar solenoid operated protection valve **261a** is provided together with a check ball, and an oil filter OF which prevents pump oil from contaminating the circulating coolant or depositing in the coolant valves, catheter passages or other components. A filter, e.g., 0.5 μm , appears in the catheter inlet line **251**. The entire vacuum system may be isolated by the solenoid operated protection valves **261**, **261a**, during start-up or during a sensed overpressure or blood leakage condition, and a check valve **265** prevents any pressure build-up on the vacuum pressure side of the catheter in the event of pump or compressor failure, allowing coolant return directly into the return line **262** and compressor inlet **241**. For this purpose, the compressor output or various bypass or check valves **257**, **264** are set a pressure slightly higher than the output setting of the tank conditioner regulator **235**, so that the coolant normally circulates into the catheter and through the vacuum system back into the compressor as a closed-loop.

In the illustrated embodiment, a coolant refill port **275** is provided at a solenoid operated valve **277** in the compressor inlet line **241**, allowing a refrigerant bottle attached at that point to employ the same compressor **243** of the system to refill the supply tank **231**. For this purpose, a solenoid operated by-pass valve **237** is also supplied to bypass the upstream high pressure return regulator **246** between the compressor output line **242b** and the tank, and speed up refill of the tank **231**. Preferably, above the tank, a solenoid operated valve **238** connects to a vent port to allow venting of any air which may have accumulated in the refrigerant tank due to leakage through the catheter or tubing. This vent is preferably controlled automatically by a suitable control program in the console **120**. Venting may be implemented, for example, by providing a temperature sensor in the refrigerant tank and a pressure sensor at its top. Knowing the temperature of the liquid refrigerant in the tank, the vent may be operated until the saturated pressure is reached for the given refrigerant at the indicated tank temperature. Such a venting step is to be performed each time the console is turned on. In addition to the foregoing elements, various pressure indicators or temperature sensors may be situated along the different lines to indicate operating parameters of the fluid therein. These are preferably sensors or indicators of the process control type wherein, rather than a dial display output, they provide an electrical output which connects to a microprocessor programmed to monitor the various conditions continuously to detect relevant safety, control or maintenance conditions.

Referring now to FIG. 4A another embodiment of a closed-loop system is shown schematically, wherein letters A through F correspond to points on a system enthalpy graph depicted at FIG. 4B. Of particular interest in the graph of FIG. 4B are the areas representing a refrigerant in liquid state, gas state, and a mixed state that includes variable percentages of liquid and gas.

The system of FIG. 4A includes a compressor **300** that pressurizes refrigerant in a gas state and passes it through a first cooler or condenser **302**. In the condenser **302**, the refrigerant transitions from a gas state to a transition or combination liquid and gas state, wherein almost all of the refrigerant is liquid, or if liquid, very close to the point where the refrigerant changes state to a gas. The refrigerant passes through a filter or contaminant remover **304** and thence to a secondary cooler, referred to herein as a subcooler **306**. The subcooler

306 chills the refrigerant to a lower temperature than that achieved by the compressor to cause the refrigerant to be completely in the liquid state prior to transfer to a catheter **310**. In an exemplary system, the subcooler **306** chills the refrigerant to a temperature colder than 10°C . to enable the catheter tip to be chilled to temperatures as low as -90°C .

Ensuring that the refrigerant is in a liquid state before its introduction into the catheter provides significant performance advantages over known systems. For example, in order to achieved maximum cooling power and maintain a predictable and controlled tip temperature for a coolant injection system as described hereinabove, the refrigerant or coolant should exit the injection tube **1** (see FIG. 1A) as a liquid. However, without a subcooler, the coolant is at or near point "C" as shown in FIG. 4B (at the liquid/gas border). Thus, as it enters the catheter and begins to warm, bubbles form in the coolant and the coolant exits the injection tube **1** in spurts instead of as a stream. In some instances, without a subcooler, only 40% or so of the coolant exits the injection tube **1** as a liquid, as about 60% or so of the coolant has already changed state to a gas. Because, there is less fluid to change state to gas, the cooling power of the device is reduced. Further, the liquid/gas spurts cause significant temperature fluctuations that can adversely affect a selected cryotreatment. Both the reduced cooling power and the temperature fluctuation phenomena are increasingly pronounced and problematic the more the diameter of the catheter and injection tube are reduced.

As shown, the subcooler **306** is located within the console **120** or one of its accessories **115c**. This helps to minimize weight and cost of a disposable handle and or catheter components, and it allows the catheter to be much smaller in diameter than a catheter having a secondary or subcooler in the handle or in the catheter. Additionally, locating the subcooler **306** in the console and/or its accessories minimizes the space occupied or required by cooling equipment within the catheter, thereby facilitating use of very small diameter catheters (e.g., 3Fr to 7Fr) for cryotreatments.

Continuing to refer to FIGS. 4A and 4B, as the refrigerant is ejected from the line leading from the subcooler **306**, it is allowed to change phase from a liquid to a gas and to expand in a low pressure or near vacuum environment created by a vacuum pump **312** at the catheter tip **314**. FIG. 4B illustrates the sudden transition from liquid to gas as represented by points "D" to "E" to "F" and to "A" on the enthalpy graph. The vacuum pump **312** causes the expanded gas to be returned to the compressor **300** so the cycle can be repeated.

FIGS. 5A and 5B illustrate another cooling system configuration that is similar to the closed-loop system shown in FIG. 4A. In this embodiment, there is no compressor **300** or condenser **304**. Refrigerant is supplied to the system from a tank or cartridge **316** in substantially liquid state or very close to the point where the refrigerant changes state from liquid to gas (point, "C" on the graph of FIG. 5B). The refrigerant passes through a filter or contaminant remover **318** and then to a subcooler **320**. The subcooler **320** chills the refrigerant to a temperature that causes the refrigerant to be completely in the liquid state (point "D" on the graph of FIG. 5B) prior to transfer to a catheter **322**.

As the refrigerant is ejected from the line leading from the subcooler **320**, it changes phase from a liquid to a gas and expands at the catheter tip **322** in a low pressure or near vacuum environment created by a vacuum pump **324**. FIG. 5B illustrates the sudden transition from liquid to gas as represented by points "D" to "E" to "F" and to "G" on the enthalpy graph. The vacuum pump causes the expanded gas to be conveyed to a collection tank or other scavenging system **326**. Cryotreatment can continue until the refrigerant supply

bottle 316 is no longer capable of providing liquid refrigerant. Down-time, however, can be minimized if a quick-connect/disconnect mechanism 328 is associated with the supply bottle 316.

Although a subcooler is shown with respect to the systems of FIGS. 4A and 5A, such a device can also be included in the systems depicted in FIGS. 2 and 3. A subcooler or subcooling system compatible with these systems can include a Peltier cooler, a Joule-Thompson, a Stirling engine or an independent closed-loop refrigeration system. Additionally, although control of the ratio of gas and liquid in a coolant can be performed with temperature control, the invention also contemplates use of pressure control in the console and subcooler to control the ratio.

FIG. 6 discloses an exemplary, independent, closed-loop subcooler in schematic form. As shown, the subcooler includes a chamber 330 through which passes a coiled refrigerant transfer line 332. A compressor 334 and condenser 336 provide liquid refrigerant that is transferred into the chamber 330 as shown by the arrow marked "Ref. in." The coolant, if compressed gas expands, or if liquid changes state to gas, thereby chilling the transfer line 332 and its contents. The expanded, gas-state coolant is exhausted from the chamber 330 as shown by the arrow marked "Ref. out" and returned to the compressor 334. A capillary tube 338 can be interposed between the condenser 336 and the chamber 330 in order to reduce the flow injected in the heat exchanger 330.

Although the subcooler system of FIG. 6, can provide effective cooling performance, it can also be bulky, noisy, and heat emitting when compared to the subcooling system of FIG. 7. Referring now to FIG. 7A, an insulated enclosure 340 (like chamber 330) encloses a coiled portion of a coolant supply line 342 leading to a medical implement (not shown) as described above. The coolant supply line 342 is in communication with a coolant reservoir 348 (such as bottled, liquid N₂O) to allow coolant to be directed into the enclosure 340. An outlet 350 in communication with a vacuum source 351 is provided to exhaust coolant from the enclosure 340 whereupon it is directed to a scavenging system. Cooling performance can be controlled with a coolant flow regulator 352 that can be made responsive to a temperature sensor 354 within the enclosure 340 that outputs a signal to a temperature controller 355 that controls the flow regulator 352. FIG. 7B is an enthalpy graph for the system illustrated in FIG. 7B.

Referring now to FIG. 8, yet another configuration for a subcooler is illustrated in conjunction with a control system for the subcooler. As with configurations described above, this illustration depicts a chamber 360, having an inlet 362 and an outlet 364, provides a flow path for refrigerant such as nitrous oxide or another fluid. A conduit 366 that defines a second fluid flow path for the same refrigerant passes through the chamber 360 and is in fluid communication with a refrigerant supply upstream of the chamber and a medical device downstream from the chamber. As shown, a fluid flow splitter 368 can allow a common refrigerant source to be used for supplying the chamber 360 and the conduit 366.

A programmable controller 370 is in communication with and controls one or more valves, such as a first valve 372, to regulate flow of coolant through the conduit 366 and into the medical device in response to a programmed cooling profile and in response to sensor outputs from the catheter. Additionally, the controller 370 can be used to control a second valve 374 to regulate flow of coolant through the chamber 360 in response to sensed temperature within the chamber. For example, the controller 370 can establish a duty cycle that opens and closes the second valve 374 repeatedly over time. If the temperature rises in the chamber 360 the second valve

374 can be opened and closed more frequently. By contrast, if the temperature in the chamber falls too far, the second valve 374 can be cycled less frequently.

As discussed above, one significant advantage provided by the present invention is that subcooling systems can be located within the console 120 or its accessories 115c instead of in the catheter or in the catheter handle (the part held by the surgeon to manipulate the catheter). Thus, as used by applicant, "console" is intended to mean any component that is not a part of the operative implement. For example, in the systems shown, the "console" can be considered to be everything but the catheter and the handle. Illustrations of this feature are shown in FIGS. 9 and 10, wherein FIG. 9 illustrates exemplary subcooling system components 380 being located entirely within the console 120. FIG. 10 illustrates a system wherein a subcooler 382 is positioned within an ECG connection box 384. Although the subcooler 382 can be configured for cooling as described above, it can include any other known cooling device that can be located within an accessory such as an ECG connection box.

The invention being thus disclosed and described in illustrative embodiments herein, variations and modifications as well as adaptations of the invention to other systems will occur to those skilled in the art, and all such variations, modifications and adaptations are considered to lie within the scope of the invention as described herein and defined in the claims appended hereto and equivalents thereof.

What is claimed is:

1. A cryogenic medical system comprising:
 - a medical probe; and
 - a console external to the medical probe, being connectable to the medical [device] probe at a connection point, the console controlling temperature of the medical [device] probe, and the console including
 - a first cooling system comprising a substantially closed loop having a coolant supply line leading to the medical probe and a coolant return line leading from the medical probe, the first cooling system directing coolant to the medical probe at a first temperature along the coolant supply line;
 - a first compressor in fluid communication with a first condenser outputting coolant into the coolant supply line; and
 - a vacuum pump in fluid communication with the first compressor and the medical probe; and
 - a second cooling system chilling the coolant within the coolant supply line to a temperature below the first temperature before the coolant reaches the connection point.
2. The system of claim 1, wherein the medical probe includes a catheter.
3. The system of claim 1, wherein the vacuum pump establishes a pressure within the coolant return line and the medical probe that is below ambient atmospheric pressure.
4. The system of claim 1, wherein the second cooling system includes an enclosure having an inlet and an outlet; the enclosure defining a fluid path from the inlet to the outlet, the fluid path of the enclosure defining a chamber enveloping a portion of the coolant supply line.
5. The system of claim 4, further comprising a second compressor in fluid communication with a second condenser outputting coolant to the inlet of the enclosure and receiving coolant from the outlet of the enclosure and second compressor.
6. A cryogenic medical system comprising:
 - a medical device;

11

a console, the console being connectable to the medical device at a connection point, the console controlling temperature of the medical device, and the console including

a first cooling system directing coolant to the medical device at a first temperature along a coolant supply line; and

a second cooling system chilling the coolant within the coolant supply line to a temperature below the first temperature before the coolant reaches the connection point,

wherein the first cooling system includes a coolant return line leading from the catheter to a coolant scavenging system, and wherein the first cooling system and the catheter comprise a substantially open-loop.]

[7. The system of claim 6, wherein the first cooling system includes:

a coolant reservoir in fluid communication with the fluid supply line; and

a vacuum pump interposed between the catheter and the coolant collection tank.]

[8. The system of claim 7, wherein the vacuum pump creates a pressure within the catheter that is below ambient atmospheric pressure.]

[9. The system of claim 6, wherein the second cooling system includes an enclosure having an inlet and an outlet; the enclosure defining a fluid path from the inlet to the outlet, and the enclosure enveloping a portion of the coolant supply line.]

[10. The system of claim 9, further comprising a compressor in fluid communication with a condenser outputting coolant to the inlet of the enclosure and receiving coolant from the outlet of the enclosure.]

11. [The system of claim 9, further] *A cryogenic medical system comprising:*

a medical device, wherein the medical device is a catheter; a console, the console being connectable to the medical device at a connection point,

the console controlling temperature of the medical device, and

the console including a first cooling system directing coolant to the medical device at a first temperature along a coolant supply line;

a second cooling system chilling the coolant within the coolant supply line to a temperature below the first temperature before the coolant reaches the connection point,

wherein the first cooling system includes a coolant return line leading from the catheter to a coolant scavenging system, and wherein the second cooling system includes an enclosure having an inlet and an outlet;

the enclosure defining a fluid path from the inlet to the outlet;

the enclosure enveloping a portion of the coolant supply line;

wherein the first cooling system and the catheter comprise a substantially open-loop;

a coolant reservoir in fluid communication with the [fluid] coolant supply line; and

a second [fluid] coolant supply line in fluid communication with the coolant reservoir and the inlet of the enclosure.

12. The system of claim 11, further comprising:

a temperature sensor for measuring the temperature within the enclosure; and

a coolant flow regulator responsive to the temperature sensor for controlling fluid flow from the second [fluid] coolant supply line into the enclosure.

12

13. The system of claim 11, further comprising a temperature sensor for measuring the temperature within the [fluid] coolant supply line; and

a coolant flow regulator responsive to the temperature sensor for controlling fluid flow from the second [fluid] coolant supply line into the enclosure.

14. A cryogenic medical system comprising:

a catheter;

a console, the console being connectable to the catheter at a connection point, the console controlling temperature of the catheter, and the console including

a first cooling system including

a coolant supply line leading to the catheter,

a coolant return line leading from the catheter,

a first compressor in fluid communication with a first condenser outputting coolant into the coolant supply line, and

a vacuum pump in fluid communication with the first compressor that establishes a pressure within the coolant return line that is below ambient atmospheric pressure; and

a second cooling system including

an enclosure having an inlet and an outlet, wherein the enclosure defines a fluid path from the inlet to the outlet, the fluid path of the enclosure defining a chamber that completely envelops a portion of the coolant supply line of the first cooling system; and

a second compressor in fluid communication with a second condenser outputting coolant to the inlet of the enclosure and receiving coolant from the outlet of the enclosure.

15. A cryogenic medical system comprising:

a catheter;

a console, the console being connectable to the catheter at a connection point, the console controlling temperature of the catheter, and the console including

a first cooling system including

a coolant supply line leading to the catheter,

a coolant return line leading from the catheter,

a coolant reservoir in fluid communication with the [fluid] coolant supply line,

a coolant collection tank in fluid communication with the coolant return line, and

a vacuum pump interposed between the catheter and the coolant collection tank that establishes a pressure within the coolant return line below ambient atmospheric pressure; and

a second cooling system including

an enclosure having an inlet and an outlet, wherein the enclosure defines a fluid path from the inlet to the outlet, the fluid path of the enclosure defining a chamber that completely envelops a portion of the coolant supply line of the first cooling system; and

a second [fluid] coolant supply line in fluid communication with the coolant reservoir and the inlet of the enclosure.

16. A cryogenic medical system comprising:

a medical device;

a console connectable to the medical device at a connection point, the console controlling temperature of the medical device, and the console including

a first system directing coolant in a mixed gas and liquid state to the medical device along a coolant supply line; and

a second system decreasing the percentage of gas in the coolant before the coolant reaches the connection point

13

wherein the second system decreases the percentage of gas in the coolant by reducing the temperature of the coolant, and wherein the system further comprises a chamber having an inlet and an outlet, wherein the enclosure defines a fluid path from the inlet to the outlet, and the enclosure envelops a portion of the coolant supply line; and
a controller for controlling coolant flow into the chamber; wherein the controller establishes a duty cycle for cyclically allowing and denying entry of coolant into the chamber at a rate responsive to sensed temperature

5

14

within the chamber to selectively raise, lower, and maintain temperature of coolant within the coolant supply line.

17. The system of claim 1, further comprising:
one or more accessories coupled between the medical probe and console, the accessories being selected from a group consisting of a connection box, an electrical extension cable, and an electrical umbilical cable.

* * * * *

UNITED STATES PATENT AND TRADEMARK OFFICE
CERTIFICATE OF CORRECTION

PATENT NO. : RE43,007 E
APPLICATION NO. : 12/173536
DATED : December 6, 2011
INVENTOR(S) : Jean-Pierre Lalonde et al.

Page 1 of 1

It is certified that error appears in the above-identified patent and that said Letters Patent is hereby corrected as shown below:

In Column 3, line 17, replace “7” with --7a--.

In Column 3, after line 17, please add after subcooler; --FIG. 7b illustrates an enthalpy graph for the system in FIG. 7A--.

In Column 9, line 44, replace “7B” with --7A--.

Signed and Sealed this
Twelfth Day of June, 2012

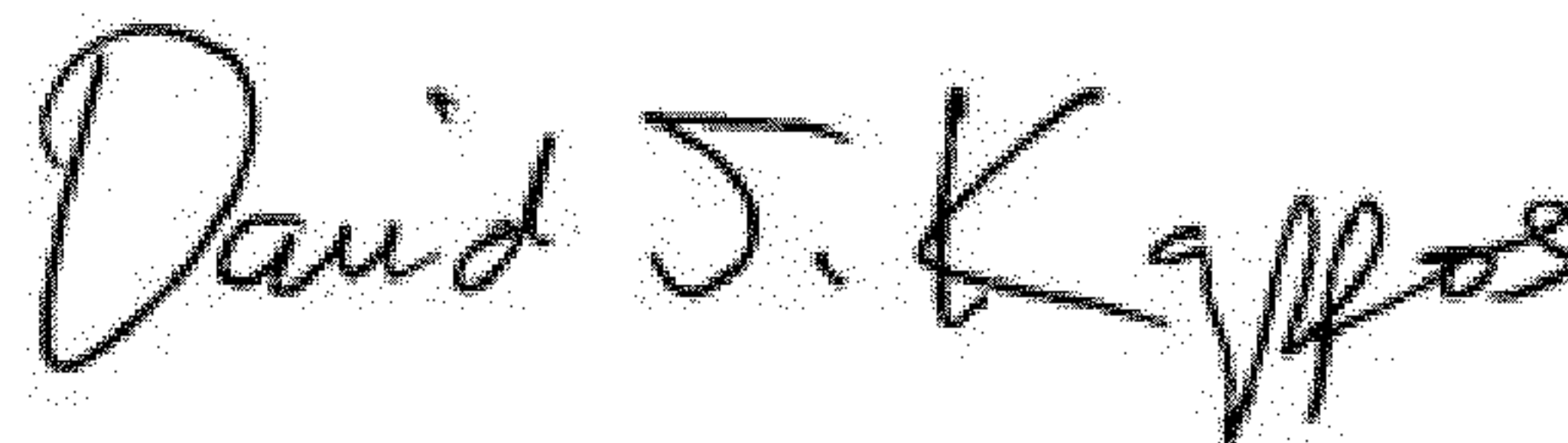

David J. Kappos
Director of the United States Patent and Trademark Office