

US00RE41606E

(19) **United States**  
(12) **Reissued Patent**  
**Böhnke et al.**

(10) **Patent Number:** **US RE41,606 E**  
(45) **Date of Reissued Patent:** **\*Aug. 31, 2010**

(54) **SYNCHRONIZATION SYMBOL STRUCTURE USING OFDM BASED TRANSMISSION METHOD**

EP 0 836 303 4/1998  
EP 0 869 646 10/1998

(Continued)

(75) Inventors: **Ralf Böhnke**, Esslingen (DE); **Thomas Dölle**, München (DE); **Tino Puch**, Bonn (DE)

(73) Assignee: **Sony Corporation**, Tokyo (JP)

(\*) Notice: This patent is subject to a terminal disclaimer.

(21) Appl. No.: **12/259,045**

(22) Filed: **Oct. 27, 2008**

**Related U.S. Patent Documents**

Reissue of:

(64) Patent No.: **6,654,339**  
Issued: **Nov. 25, 2003**  
Appl. No.: **09/479,281**  
Filed: **Jan. 6, 2000**

(30) **Foreign Application Priority Data**

Jan. 8, 1999 (EP) ..... 99100263  
Feb. 22, 1999 (EP) ..... 99103379

(51) **Int. Cl.**  
**H04J 11/00** (2006.01)

(52) **U.S. Cl.** ..... **370/203; 370/208; 370/350; 375/355**

(58) **Field of Classification Search** ..... None  
See application file for complete search history.

(56) **References Cited**

**U.S. PATENT DOCUMENTS**

5,450,456 A 9/1995 Mueller  
5,732,113 A 3/1998 Schmidl et al.  
6,160,791 A 12/2000 Böhnke

(Continued)

**FOREIGN PATENT DOCUMENTS**

CA 2 291 847 9/2005

**OTHER PUBLICATIONS**

Moose, A Technique for Orthogonal Frequency Division Multiplexing Frequency Offset Correction, IEEE, 7 pages, Oct. 1994.\*

IEEE P802.11a/D5.0, LAN/MAN Specific Requirement—Part 11: Wireless Medium Access Control (MAC) and physical layer (PHY) specifications: High Speed Physical Layer in the 5 GHz band, IEEE, 61 pages, 1999.\*

Laurenti, Implementation Issues in OFDM Systems, Dissertation, 98 pages, 1998.\*

(Continued)

*Primary Examiner*—Frank Duong  
(74) *Attorney, Agent, or Firm*—Frommer Lawrence & Haug LLP; William S. Frommer

(57) **ABSTRACT**

The present invention proposes a method for generating synchronization bursts for OFDM transmission systems. The symbols of a predefined symbol sequence are mapped according to a predefined mapping scheme on subcarriers of the OFDM systems by a mapping unit (2), wherein the symbols of the predefined symbol sequence represent subcarriers of the OFDM system with nonzero amplitudes. A synchronization burst is generated by a inverse fast Fourier transforming unit (3) transforming the subcarriers of the OFDM system mapped to said predefined symbol sequence. The mapping (2) of the symbols of the predefined symbol sequence is set such that the resulting time domain signal of the synchronization burst represents a periodic nature. According to the invention the predefined symbol sequence is set such that the envelope fluctuation of the time domain signal of the synchronization burst is minimized. Therefore advantageous symbol sequences reducing said the envelope fluctuation of the time domain signal are proposed.

**15 Claims, 9 Drawing Sheets**

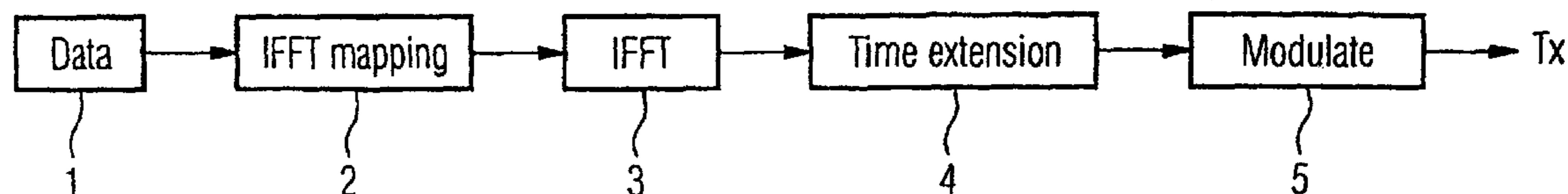

U.S. PATENT DOCUMENTS

6,160,821	A	12/2000	Dölle et al.
6,407,846	B1	6/2002	Myers et al.
6,438,173	B1	8/2002	Stantchev
6,452,987	B1	9/2002	Larson et al.
6,470,055	B1	10/2002	Feher
6,507,733	B1	1/2003	Krupezevic et al.
6,535,501	B1	3/2003	Böhnke
6,539,215	B1	3/2003	Brankovic et al.
6,545,997	B1	4/2003	Böhnke et al.
6,557,139	B2	4/2003	Böhnke
6,567,374	B1	5/2003	Böhnke et al.
6,567,383	B1	5/2003	Böhnke
6,609,010	B1	8/2003	Dolle et al.
6,650,178	B1	11/2003	Brankovic et al.
6,654,339	B1	11/2003	Böhnke et al.
6,674,732	B1	1/2004	Boehnke et al.
6,674,817	B1	1/2004	Dölle et al.
6,704,562	B1	3/2004	Oberschmidt et al.
6,724,246	B2	4/2004	Oberschmidt et al.
6,728,550	B1	4/2004	Böhnke et al.
6,731,594	B1	5/2004	Böhnke
6,735,261	B1	5/2004	Oberschmidt et al.
6,738,443	B1	5/2004	Böhnke et al.
6,748,203	B1	6/2004	Brankovic et al.
6,803,814	B1	10/2004	Krupezevic et al.
6,917,580	B2	7/2005	Wang et al.
7,012,882	B2	3/2006	Wang et al.
7,106,821	B2	9/2006	Usui et al.
7,145,955	B1	12/2006	Böhnke et al.
7,154,975	B1	12/2006	Böhnke et al.
7,184,725	B2	2/2007	Ruhm et al.
2004/0196916	A1	10/2004	Böhnke et al.
2006/0045219	A1	3/2006	Wang et al.
2006/0133408	A1	6/2006	Nogueira-Nine et al.
2006/0148906	A1	7/2006	Bieniarz et al.
2006/0269008	A1	11/2006	Böhnke et al.
2007/0036235	A1	2/2007	Böhnke et al.
2007/0115827	A1	5/2007	Boehnke et al.

FOREIGN PATENT DOCUMENTS

EP	0 982 905	3/2000
EP	0 984 595	3/2000
EP	0 984 596	3/2000

EP	0 987 863	3/2000
EP	1 014 562	6/2000
EP	1 018 827	7/2000
EP	1 037 481	9/2000
EP	1 039 661	9/2000
EP	1 065 855	1/2001
EP	1 162 764	12/2001
EP	1 170 916	1/2002
EP	1 170 917	1/2002
EP	1 207 661	5/2002
EP	1 207 662	5/2002
EP	1 276 251	1/2003
EP	1 276 288	1/2003
EP	1 379 026	1/2004
EP	1 439 677	7/2004
EP	1 530 336	5/2005
EP	1 667 341	6/2006
EP	1 705 852	9/2006
EP	1 722 527	11/2006
GB	2 320 868	7/1998
JP	2000 209183	7/2000
KR	10 0712865	4/2007
WO	WO 98 00946	1/1998

OTHER PUBLICATIONS

Dinis R et al: "Carrier Synchronization With CEPB-OFDM" 1997 IEEE 47<sup>TH</sup>. Vehicular Technology Conference, Phoenix, May 4-7, 1997, vol. 3, No. Conf. 47, May 4, 1997, pp. 1370-1374, XP000738586 Institute of Electrical and Electronics Engineers.

Bauml R W et al: "Reducing the Peak-To-Average Power Ratio of Multicarrier Modulation by Selected Mapping" Electronics Letters, vol. 32, No. 22, Oct. 24, 1996, p. 2056-2057, XP000643915.

Schmidl T M et al: "Low-Overhead, Low-Complexity Burst Synchronization for OFDM" 1996 IEEE International Conference on Communications ICC), Converging Technologies for Tomorrow's Applications Dallas, Jun. 23-27, 1996, vol. 3, Jun. 23, 1996, pp. 1301-1306, XP000625022 Institute of Electrical & Electronics Engineers ISBN: 0-7803-3251-2.

Mizoguchi et al: "A Fast Burst Synchronization Scheme for OFDM", IEEE, pp. 125-129, 1998.

\* cited by examiner

FIG 1

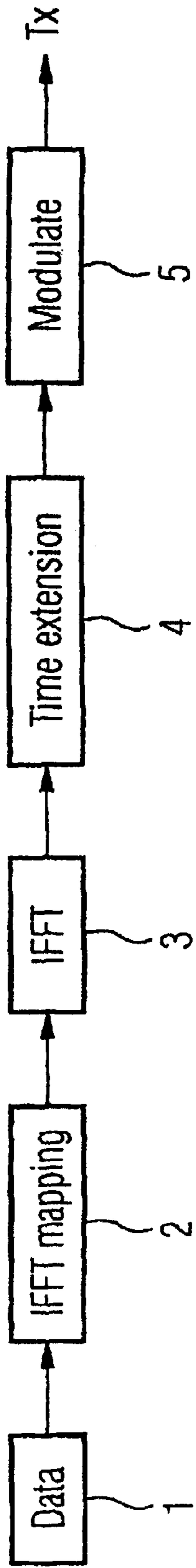
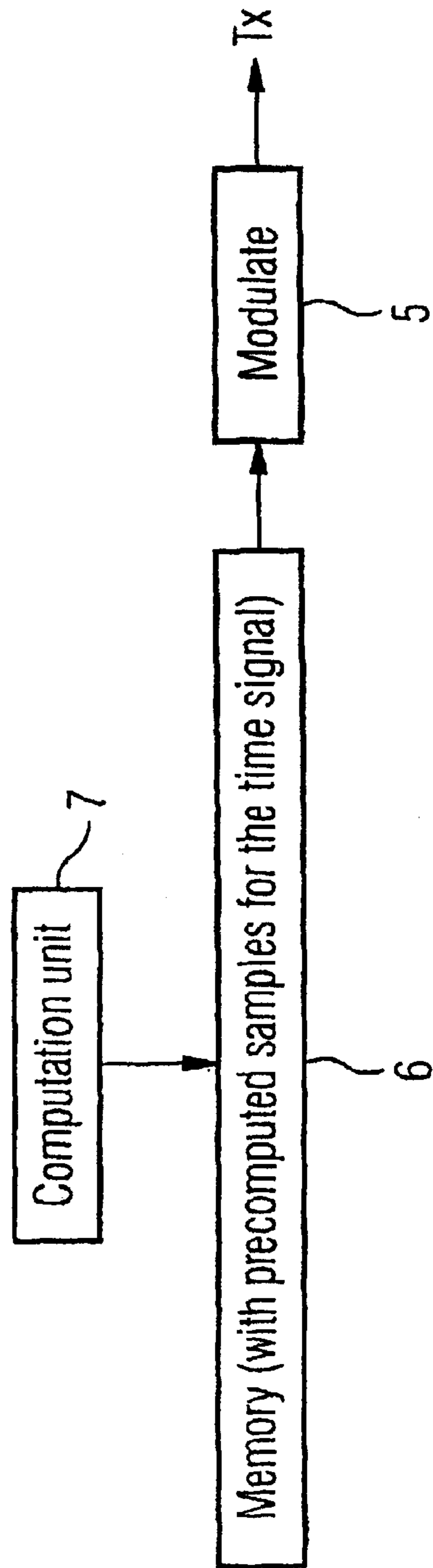

FIG 2



# FIG 3

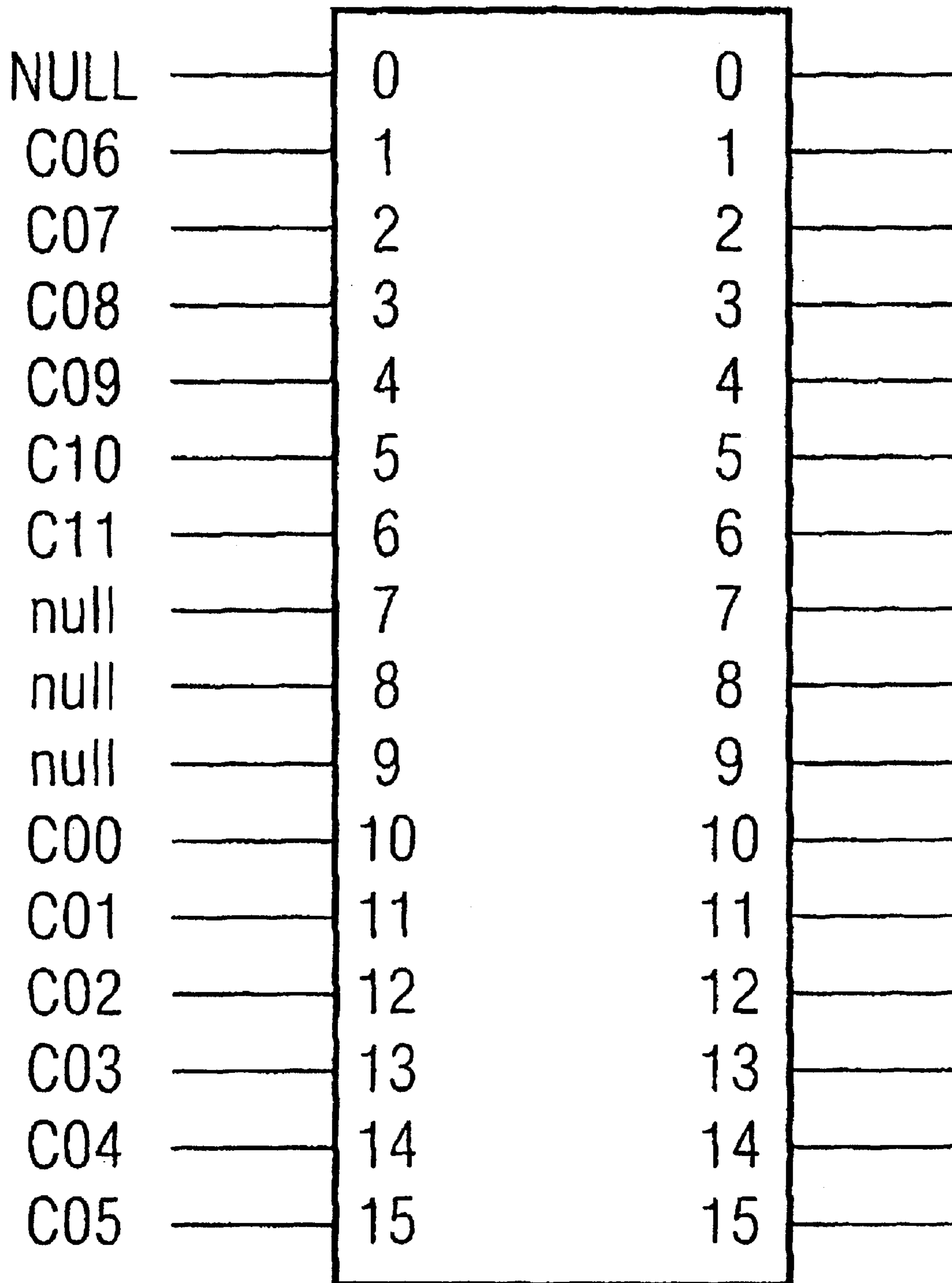

FIG 4a

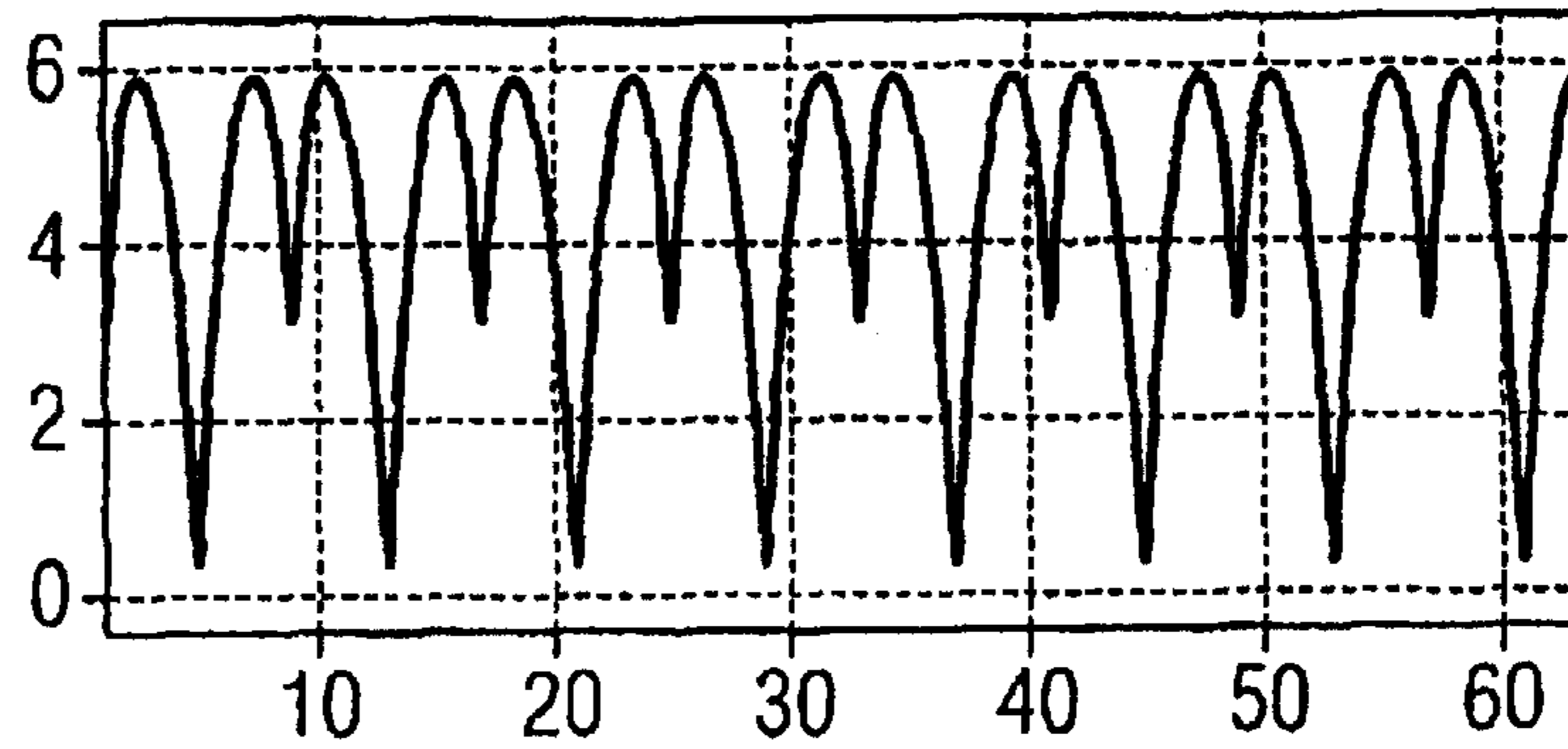

FIG 4b

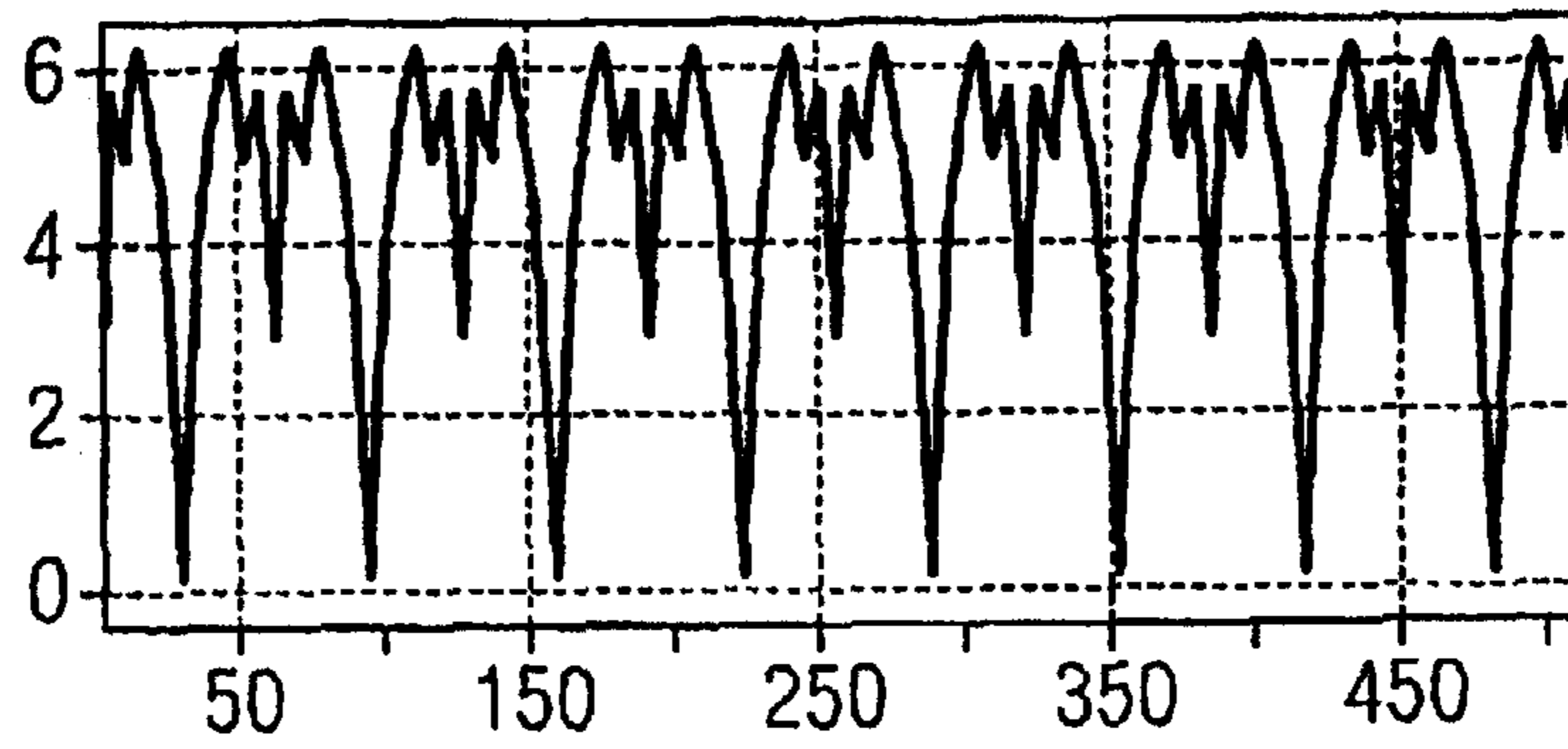

FIG 4c

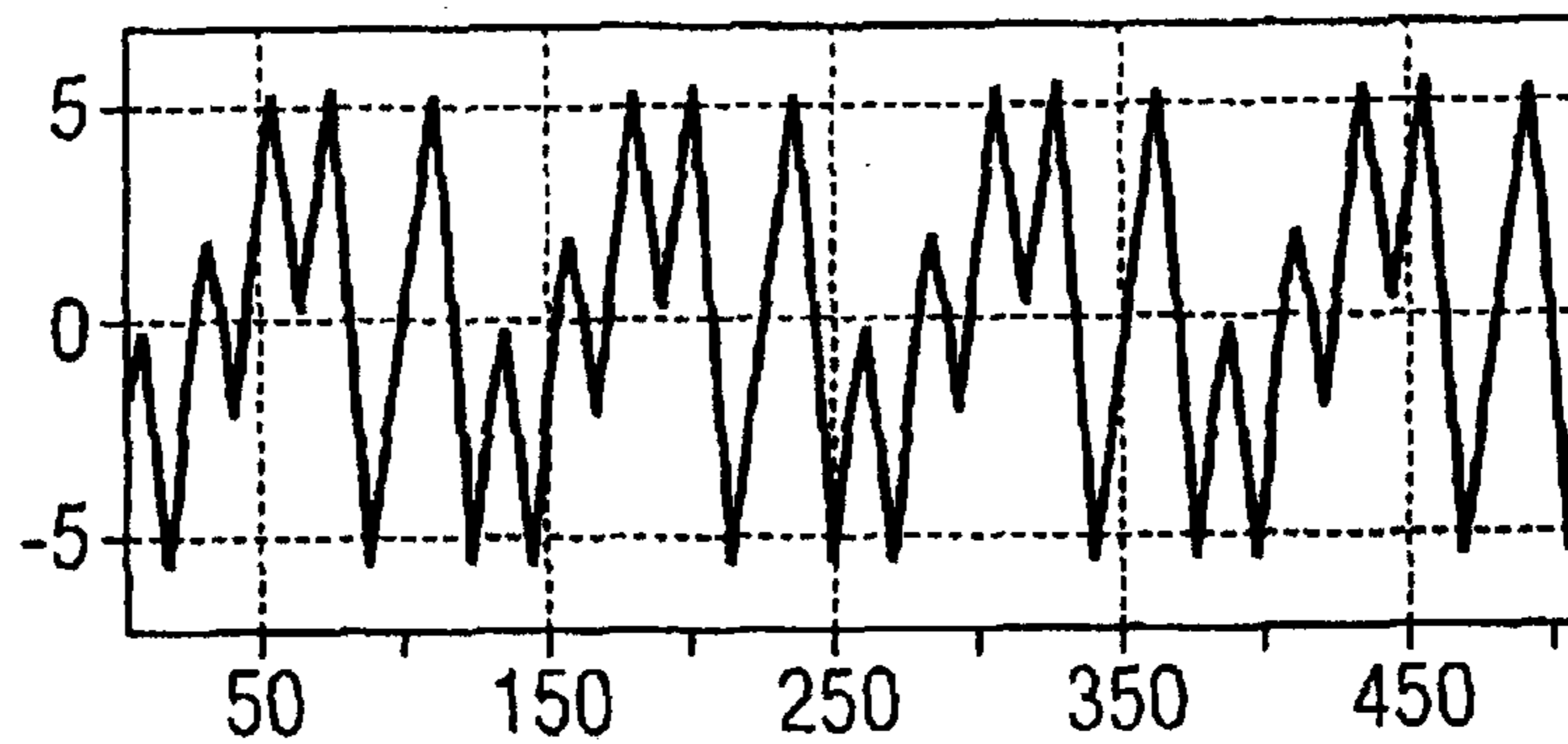
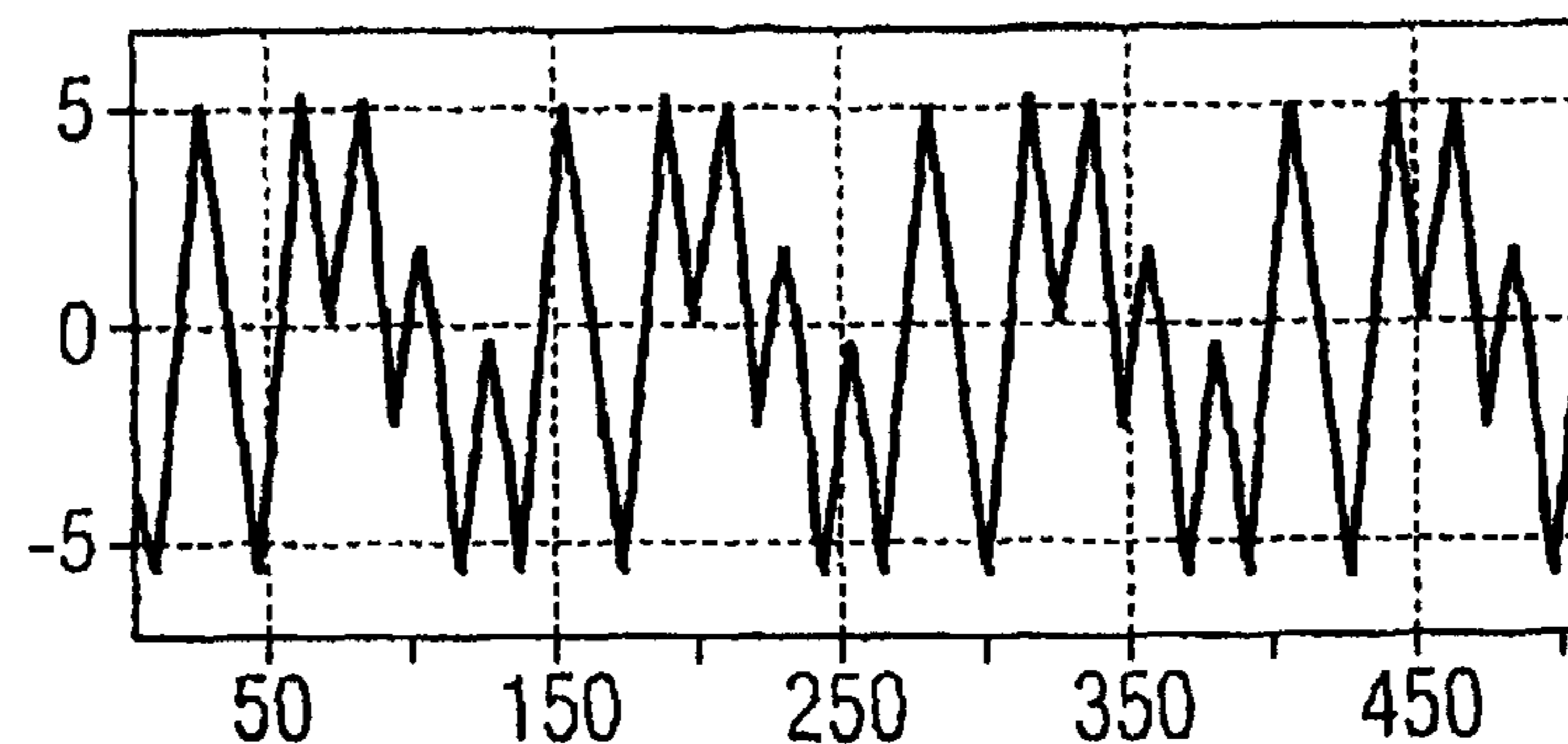

FIG 4d



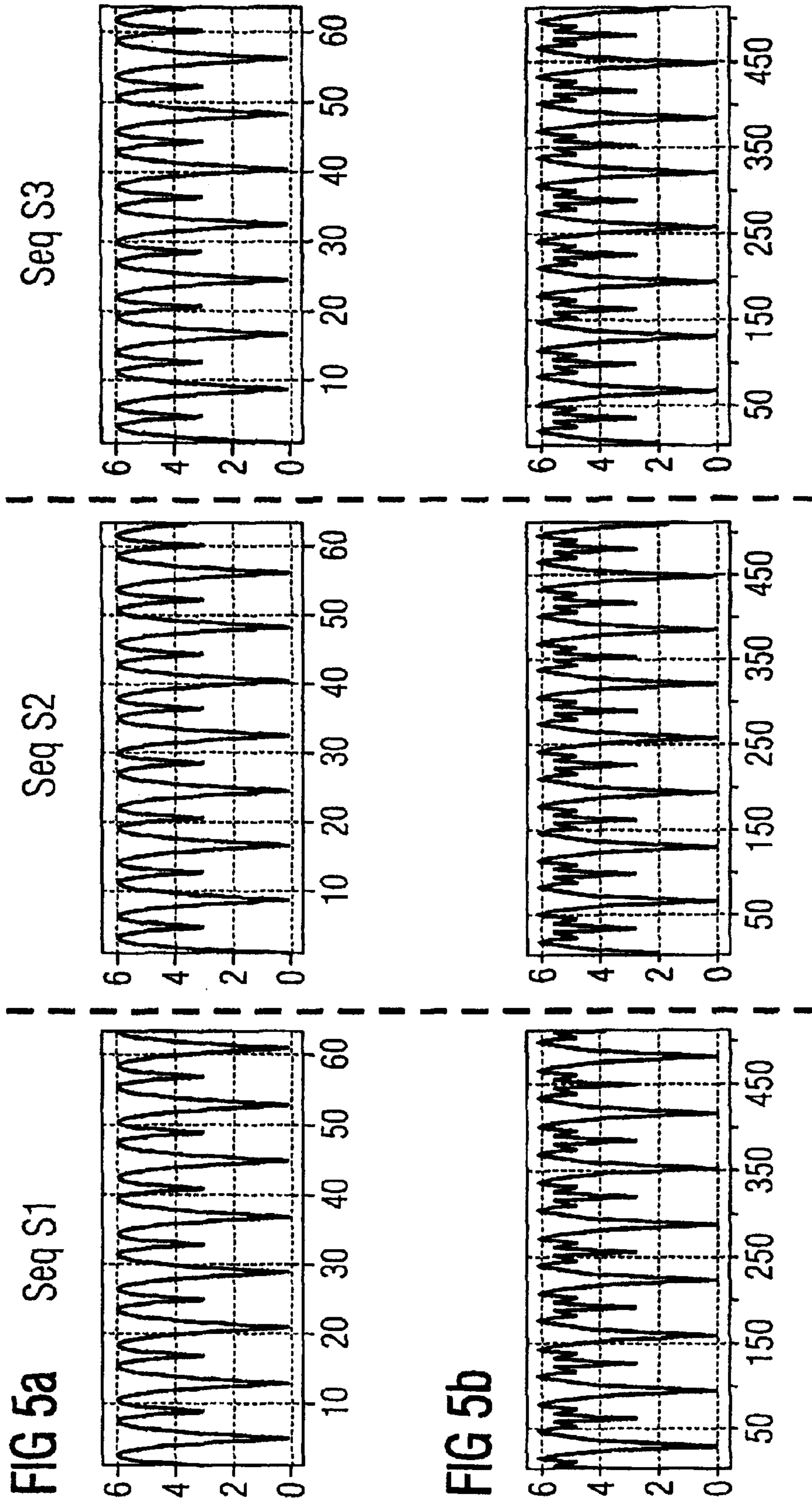
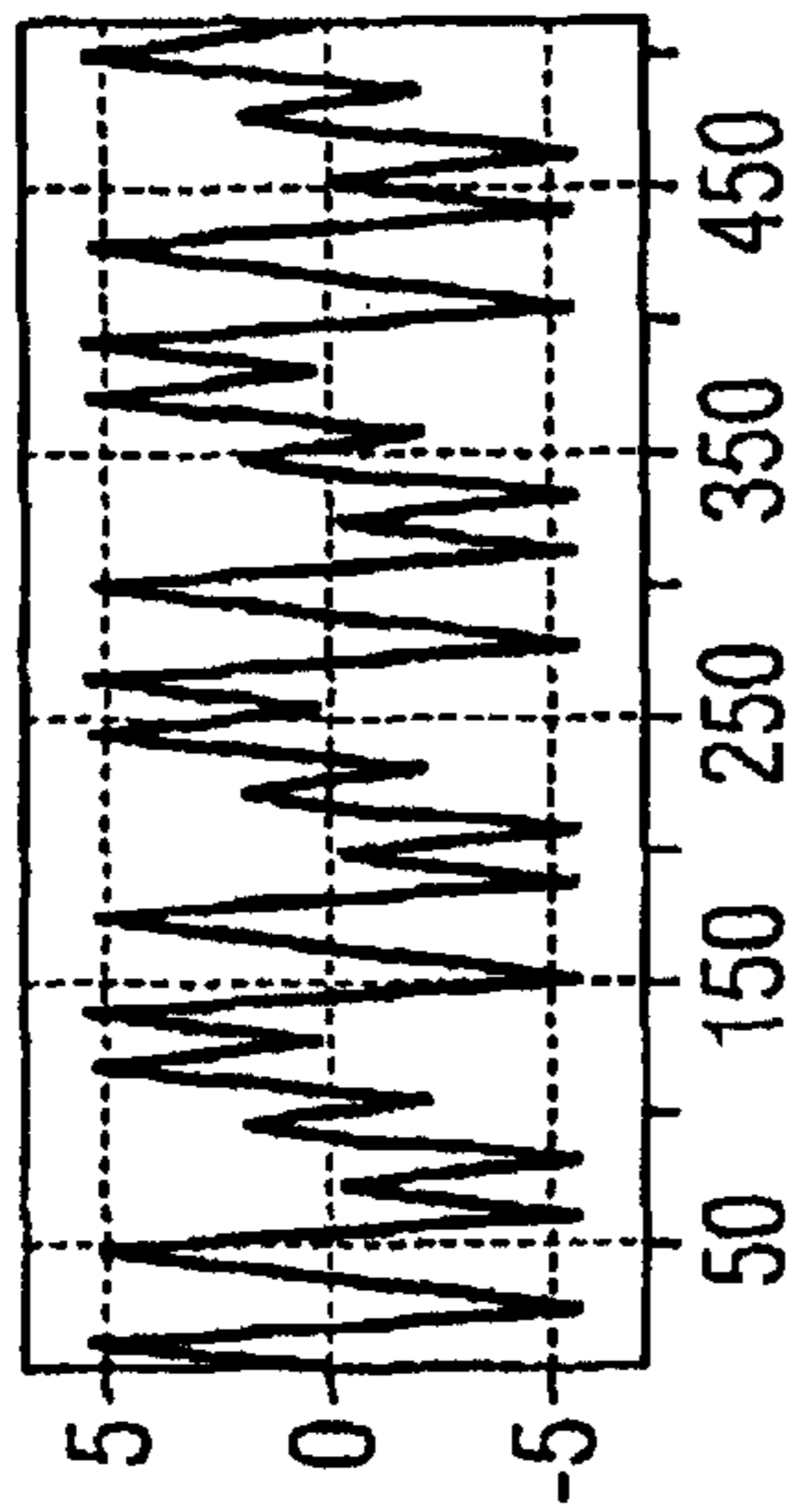
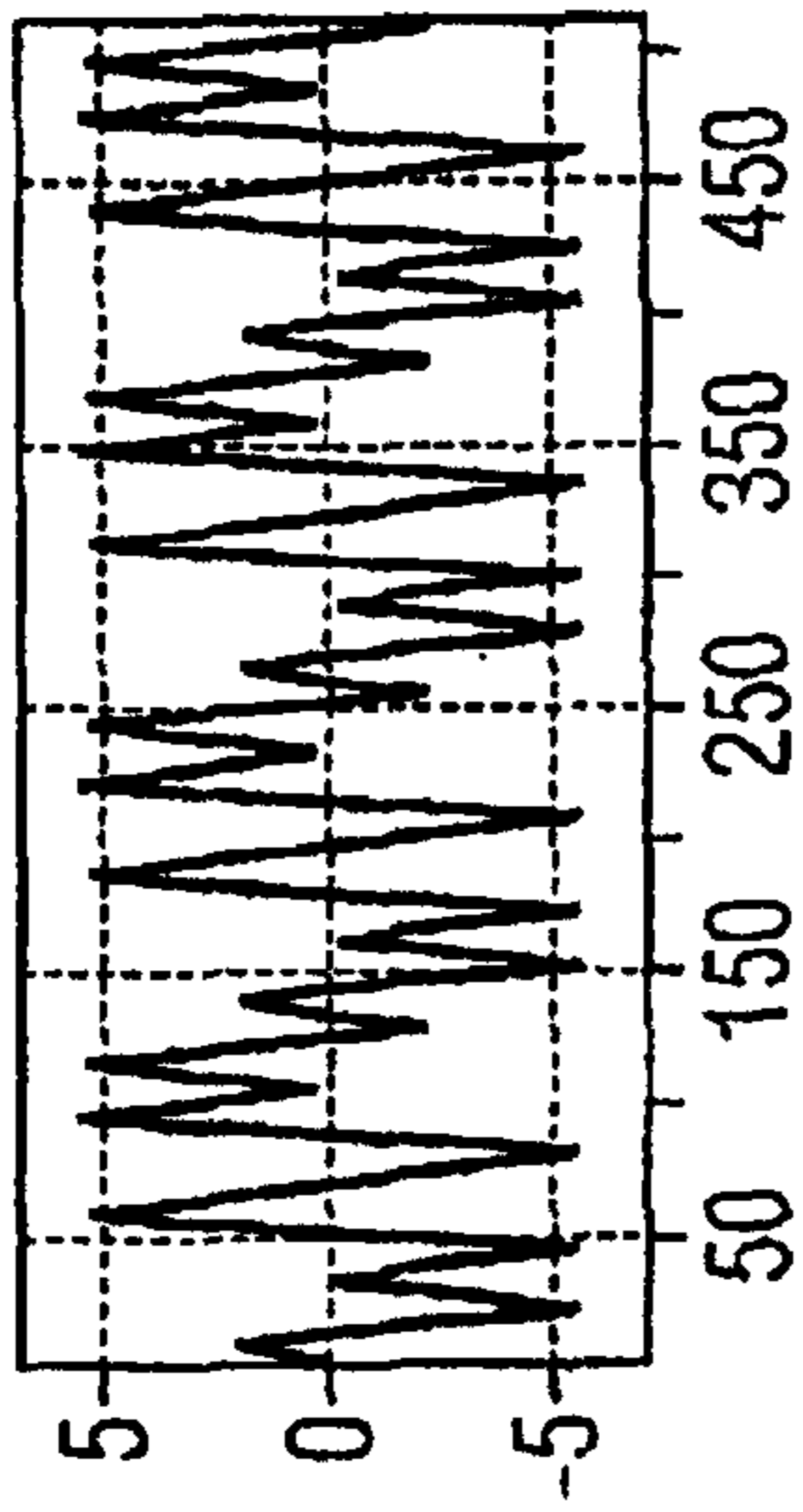

FIG 5c Seq S1



Seq S2



Seq S3

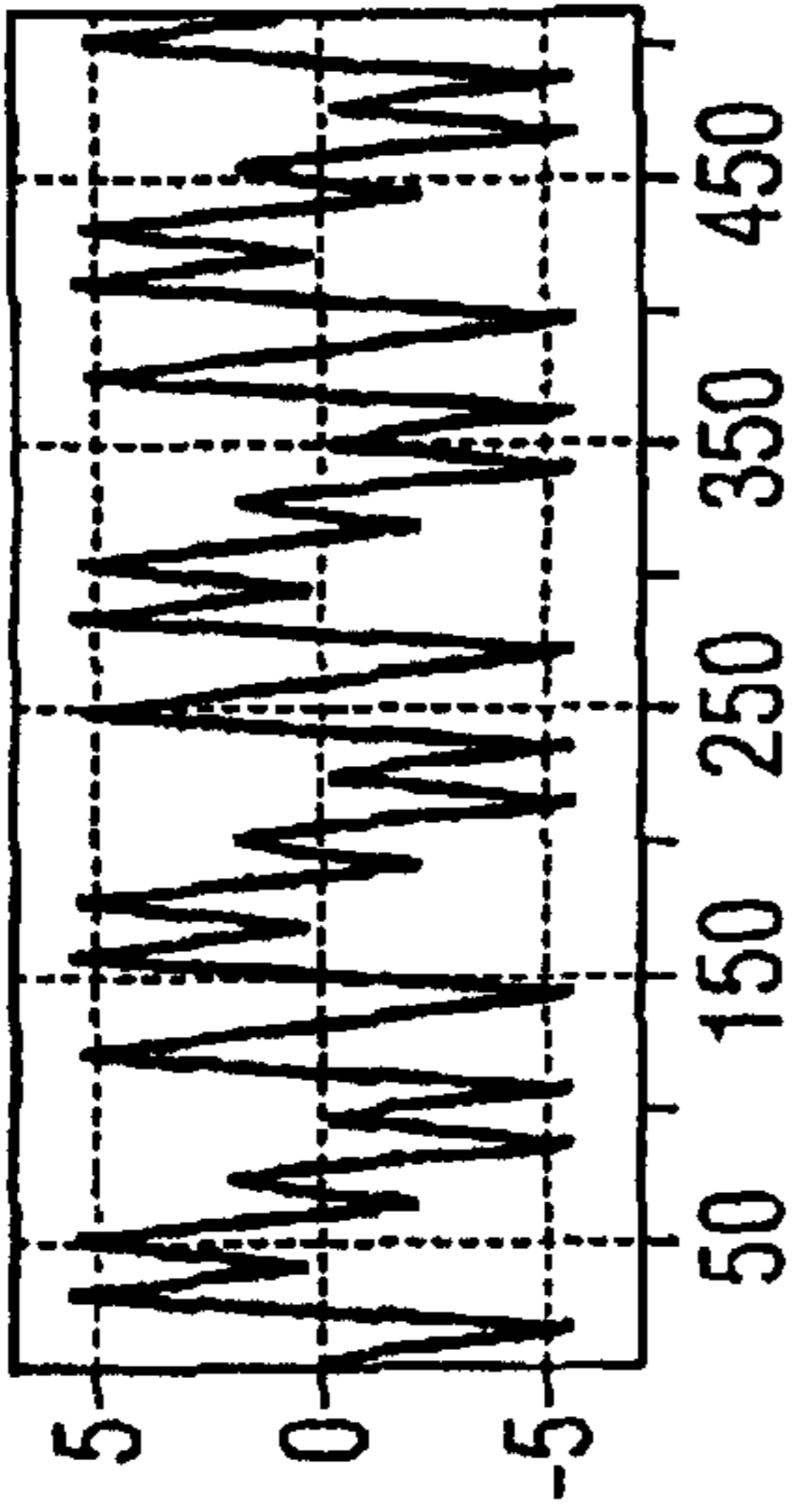

FIG 5d

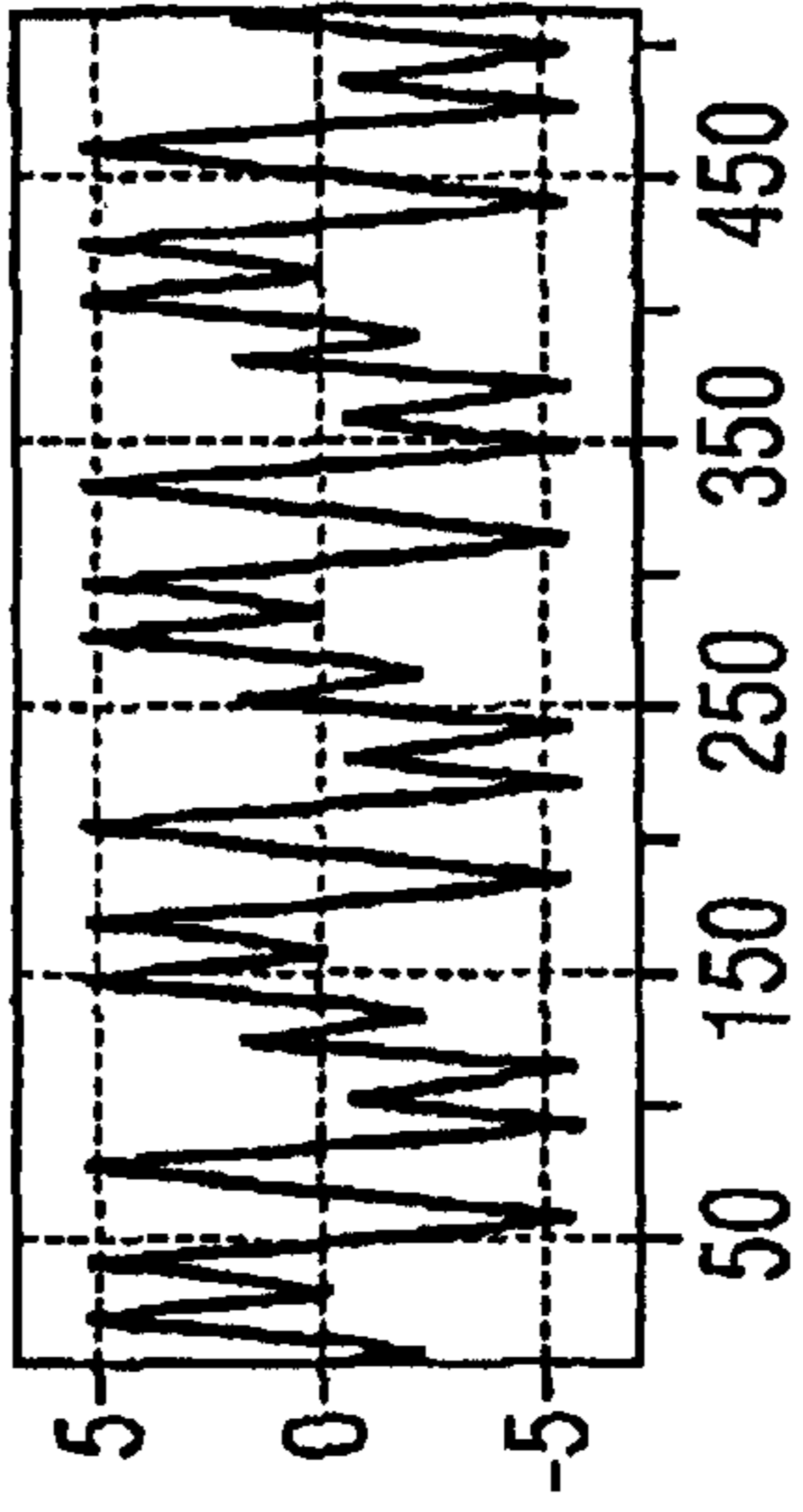
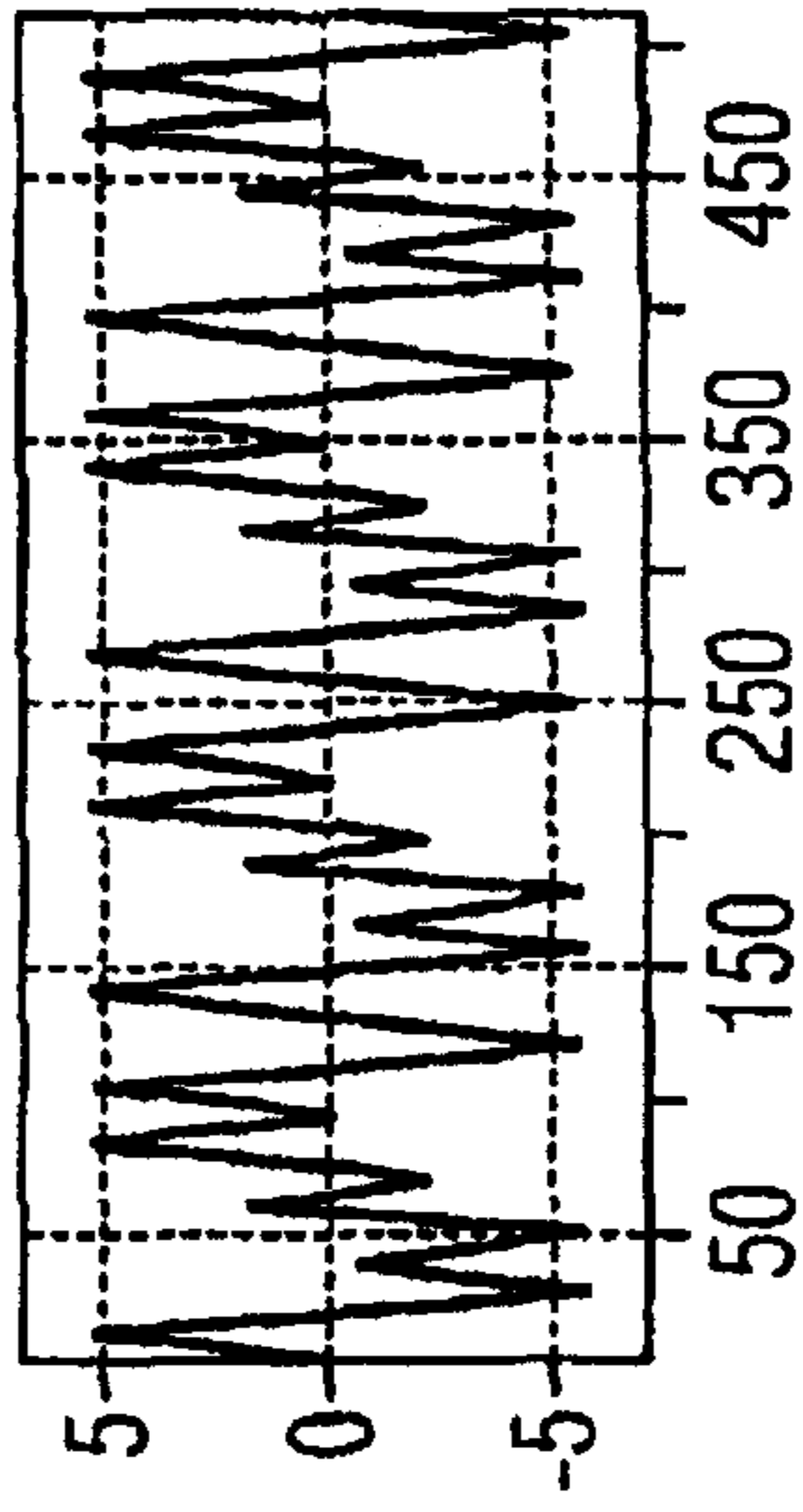
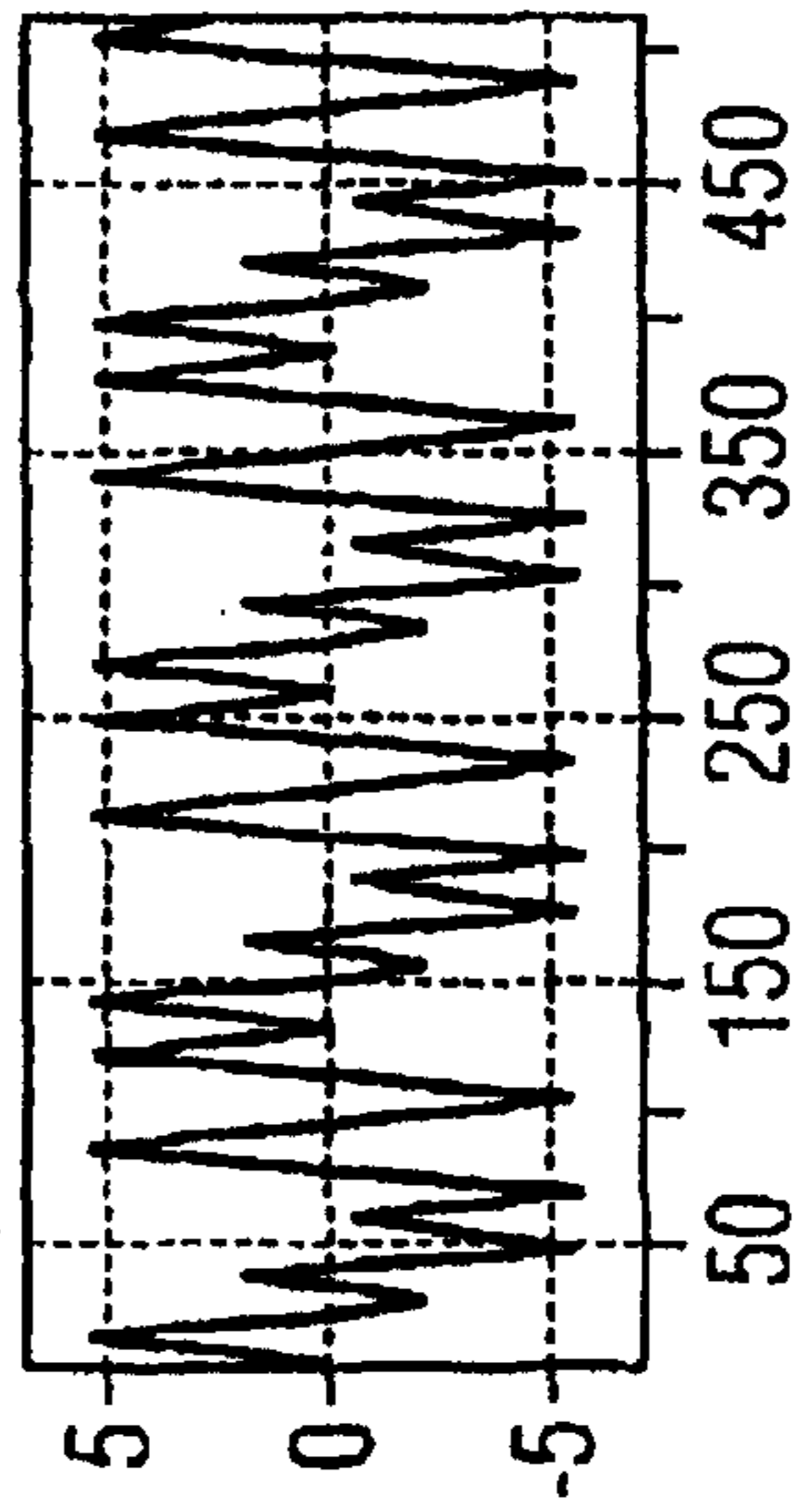

FIG 6

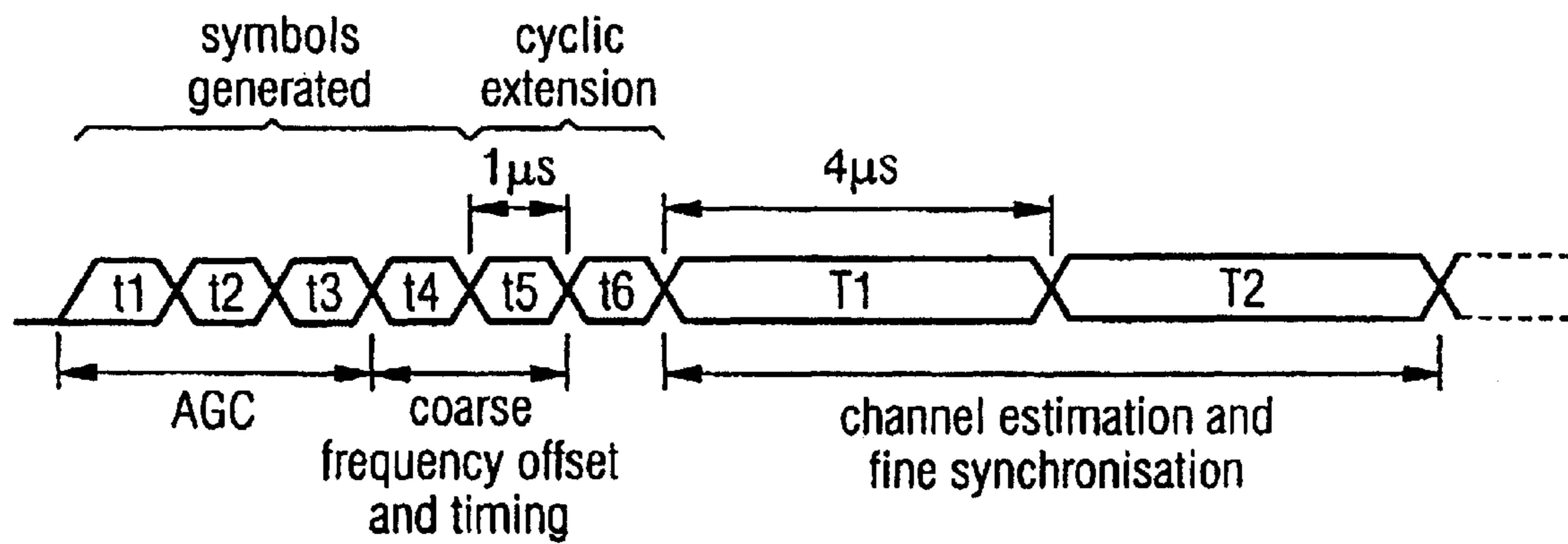

FIG 7

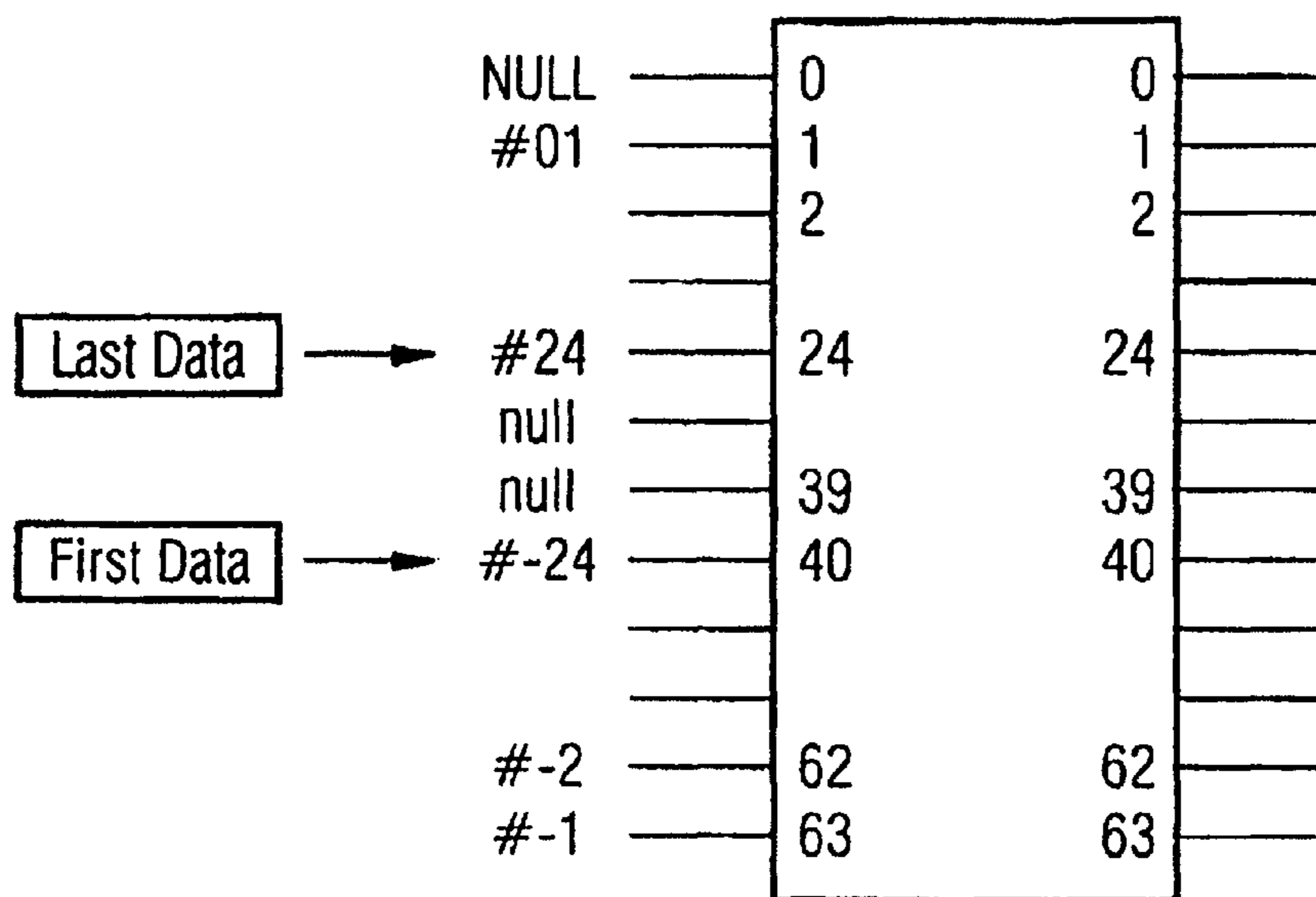



FIG 8a

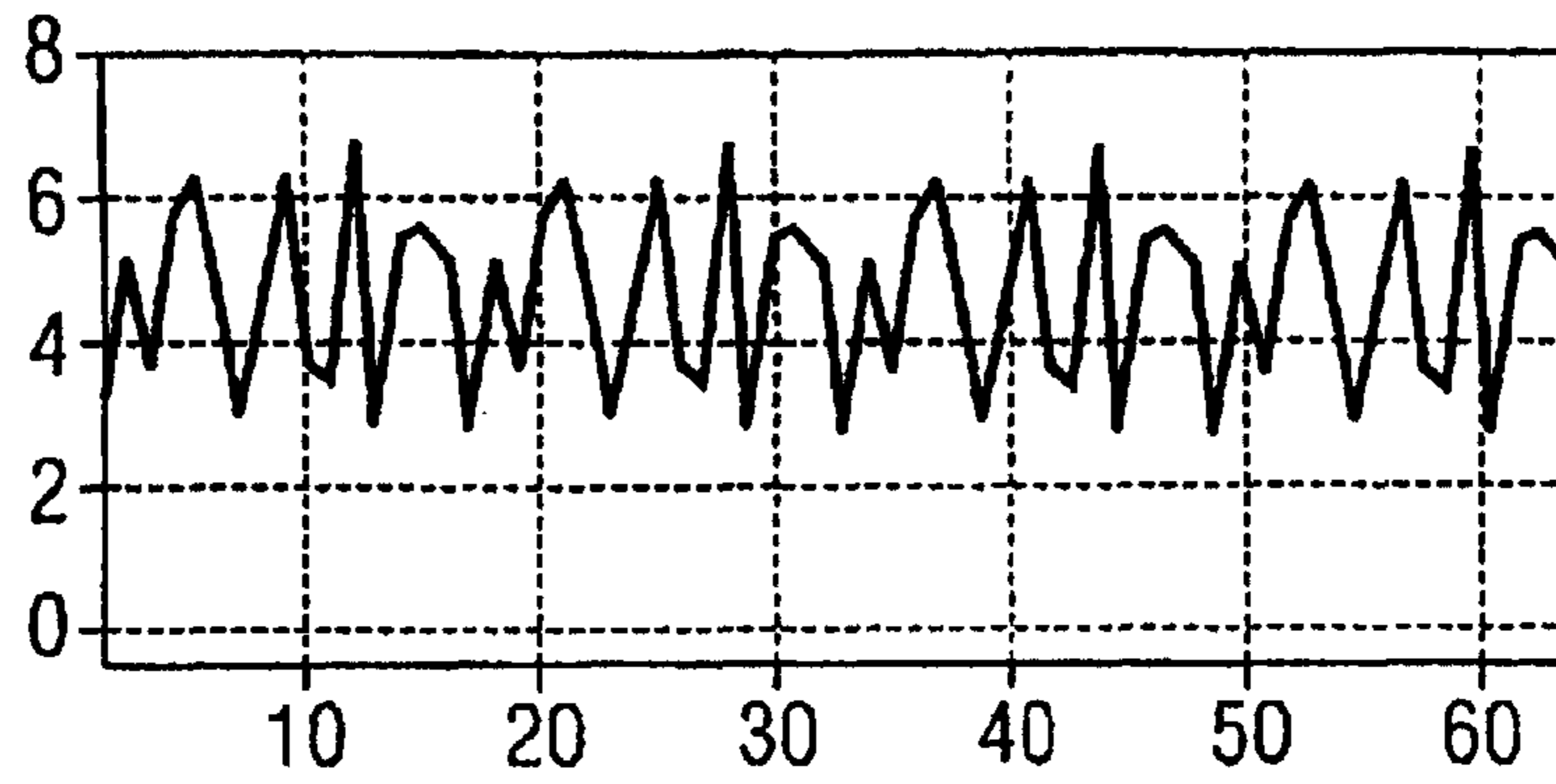

FIG 8b

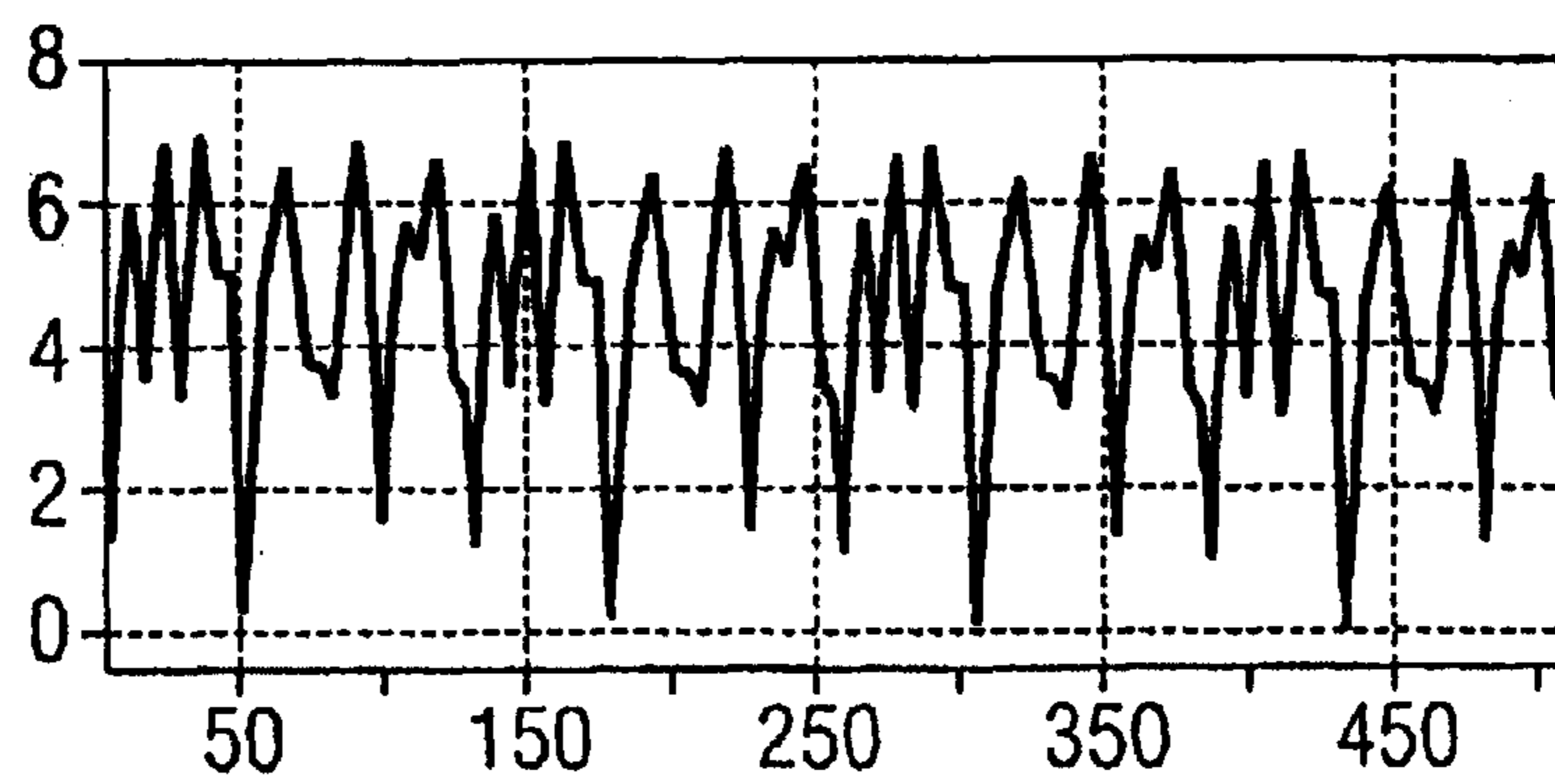

FIG 8c

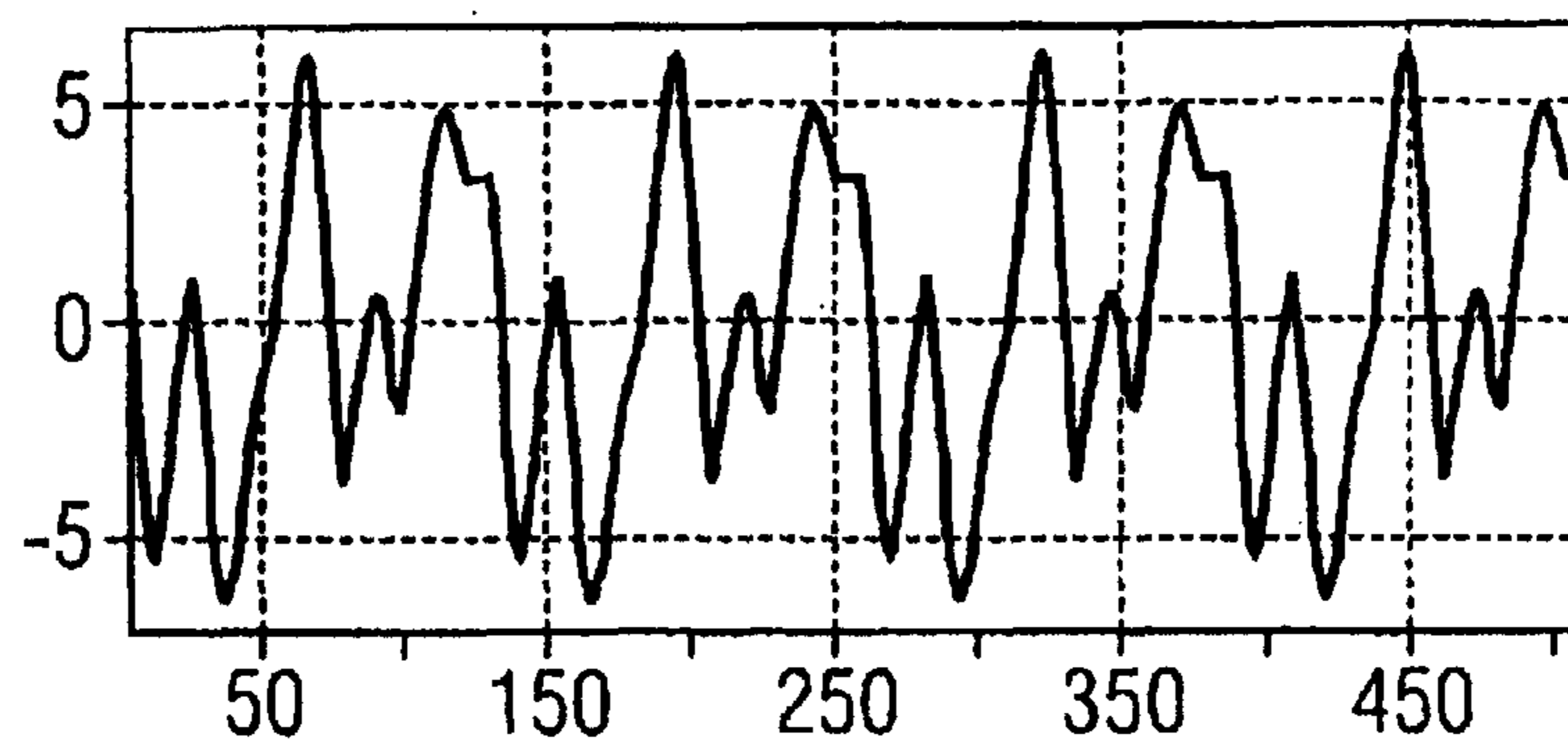
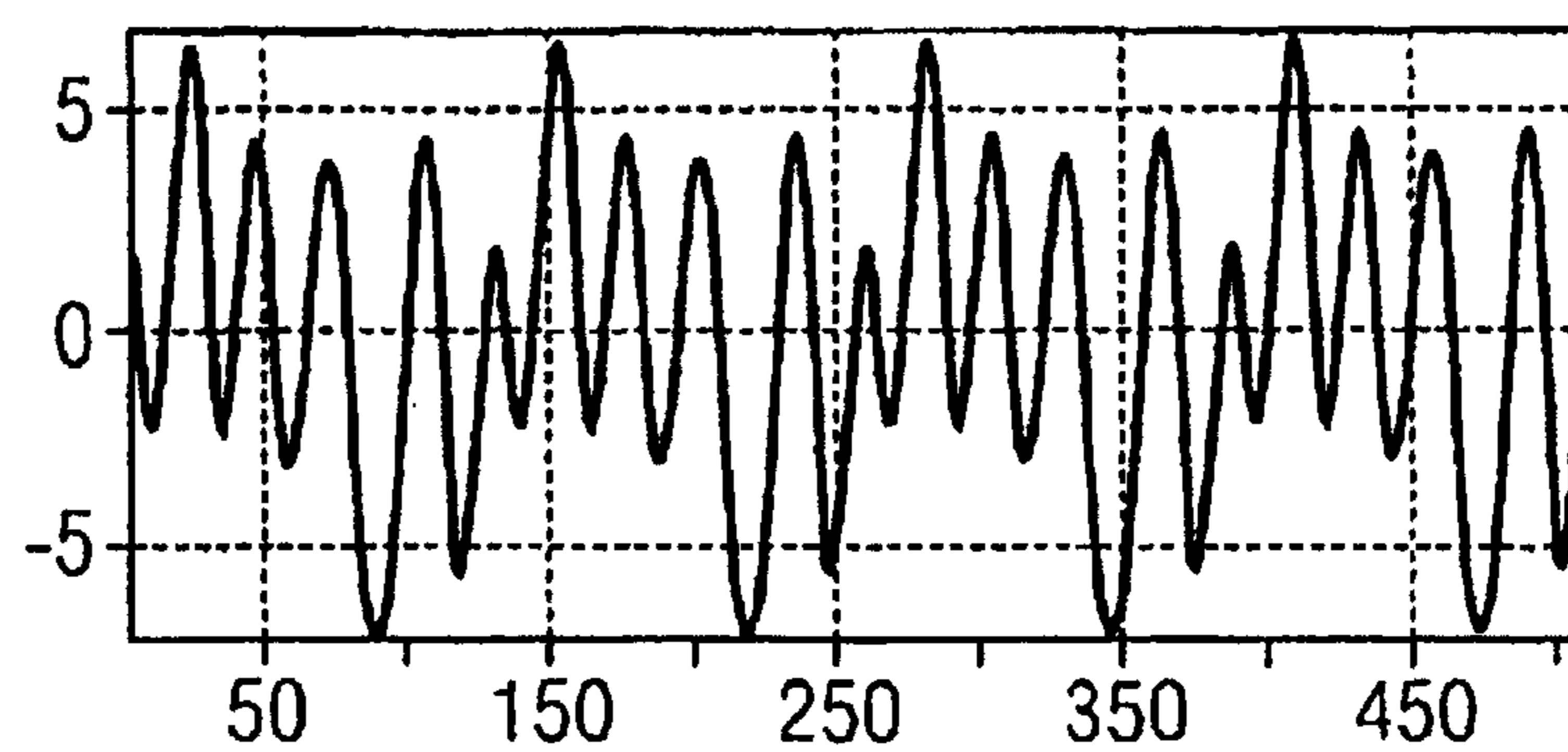

FIG 8d



Time domain signal (magnitude) using the state of the art  
(8-times oversampling)

FIG 9a

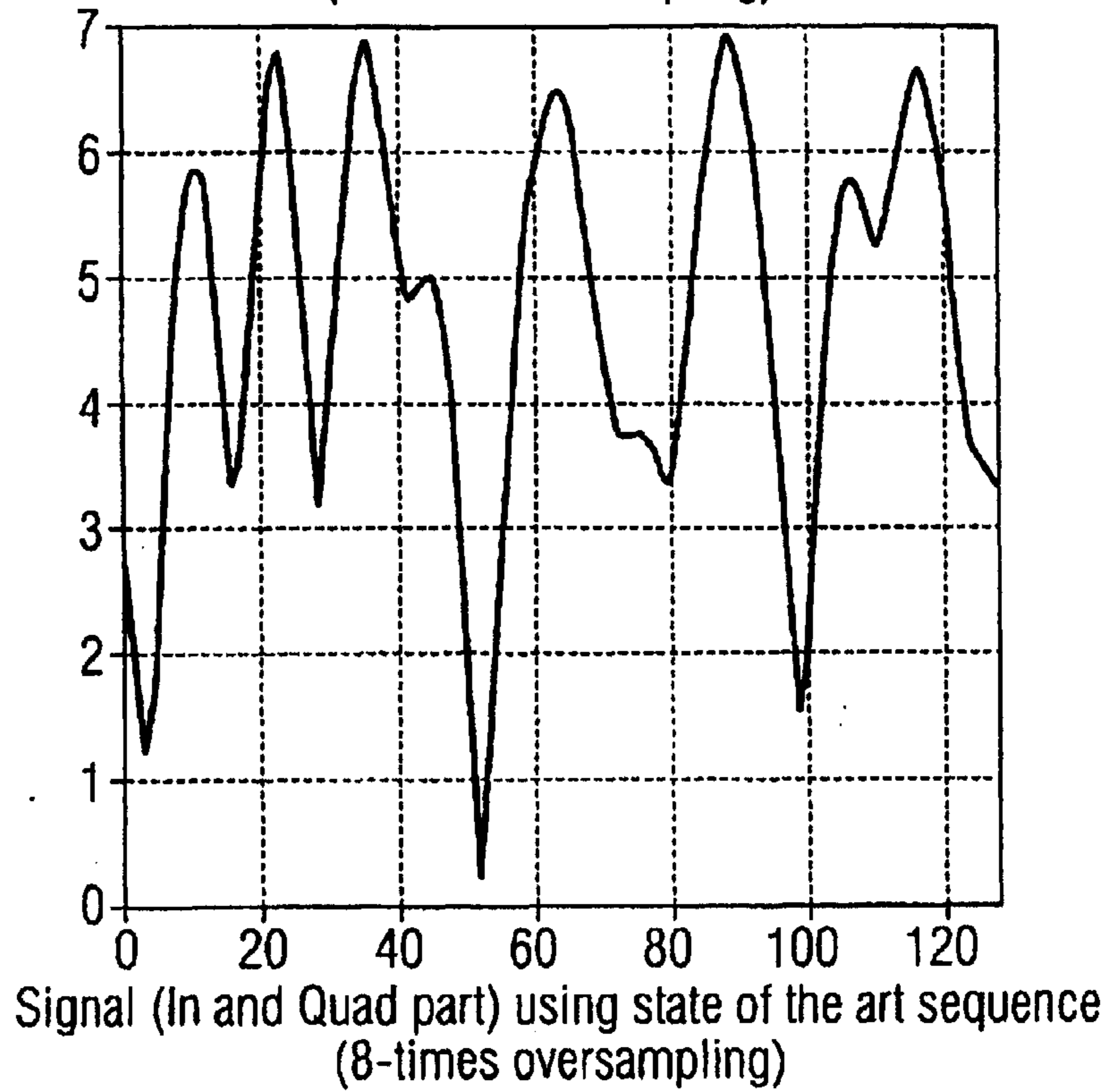
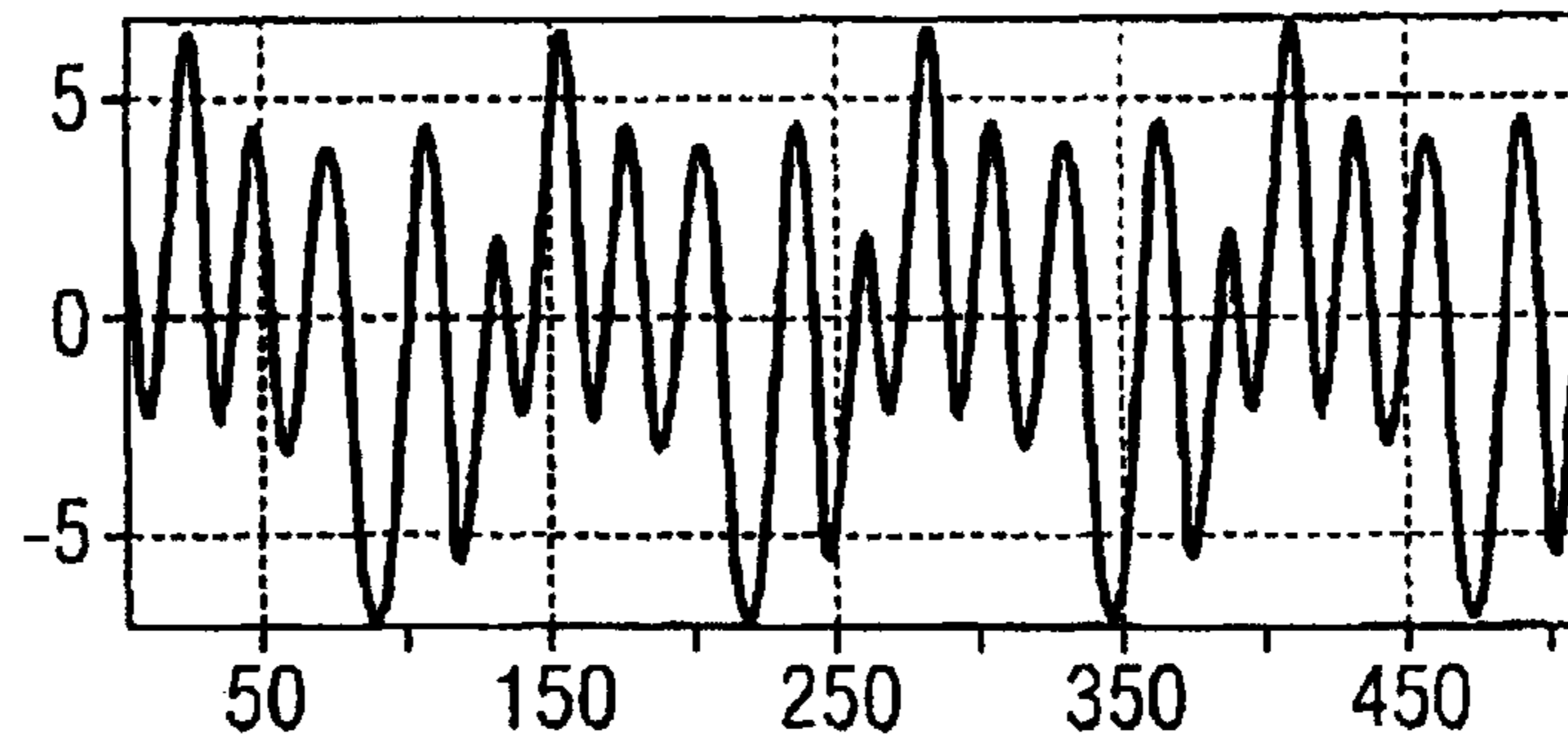
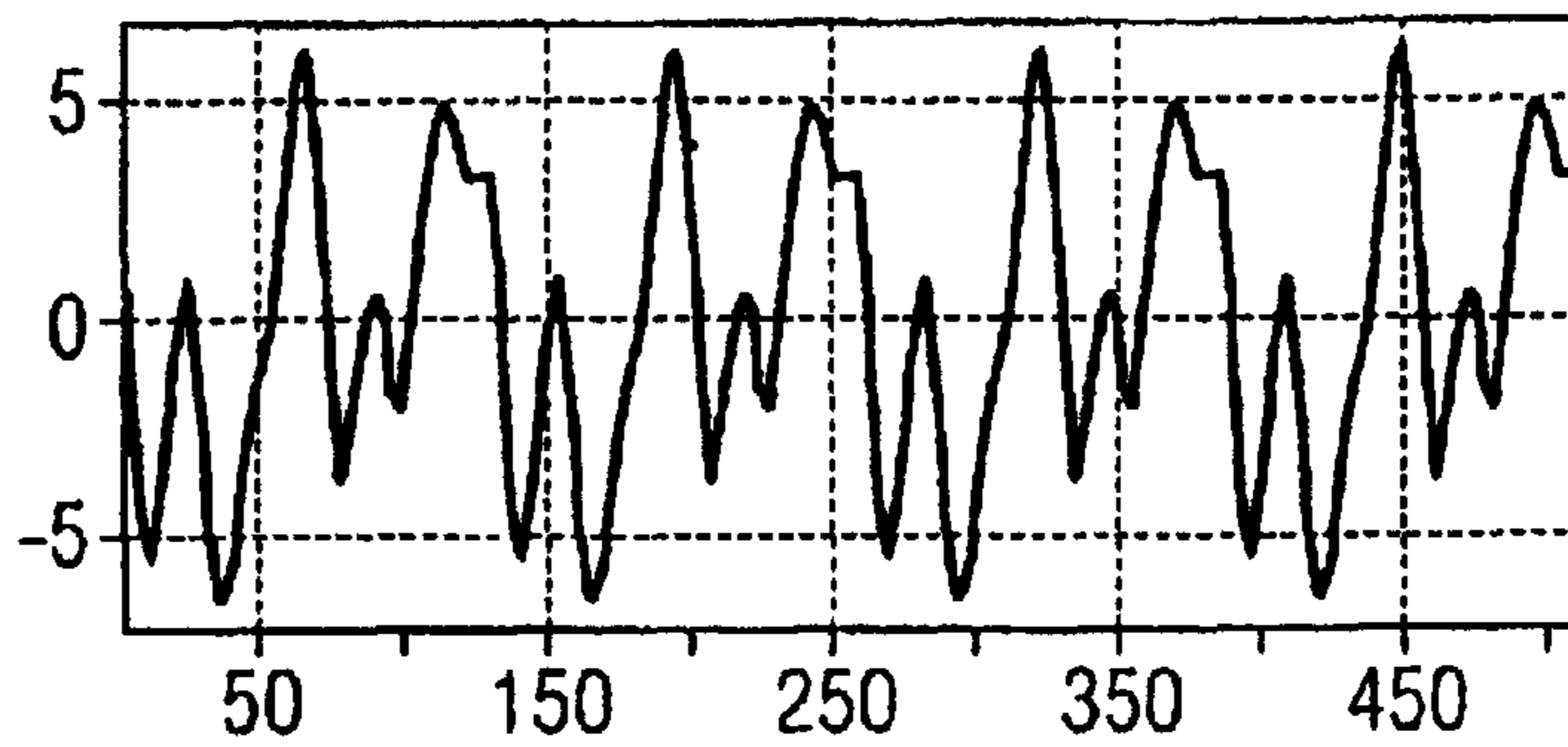

FIG 9b



PAPR: 3.01 dB  
Dynamic Range: 30.82 dB

FIG 10a

Time domain signal (magnitude) using 'Seq-Alt1'  
(8-times oversampling)

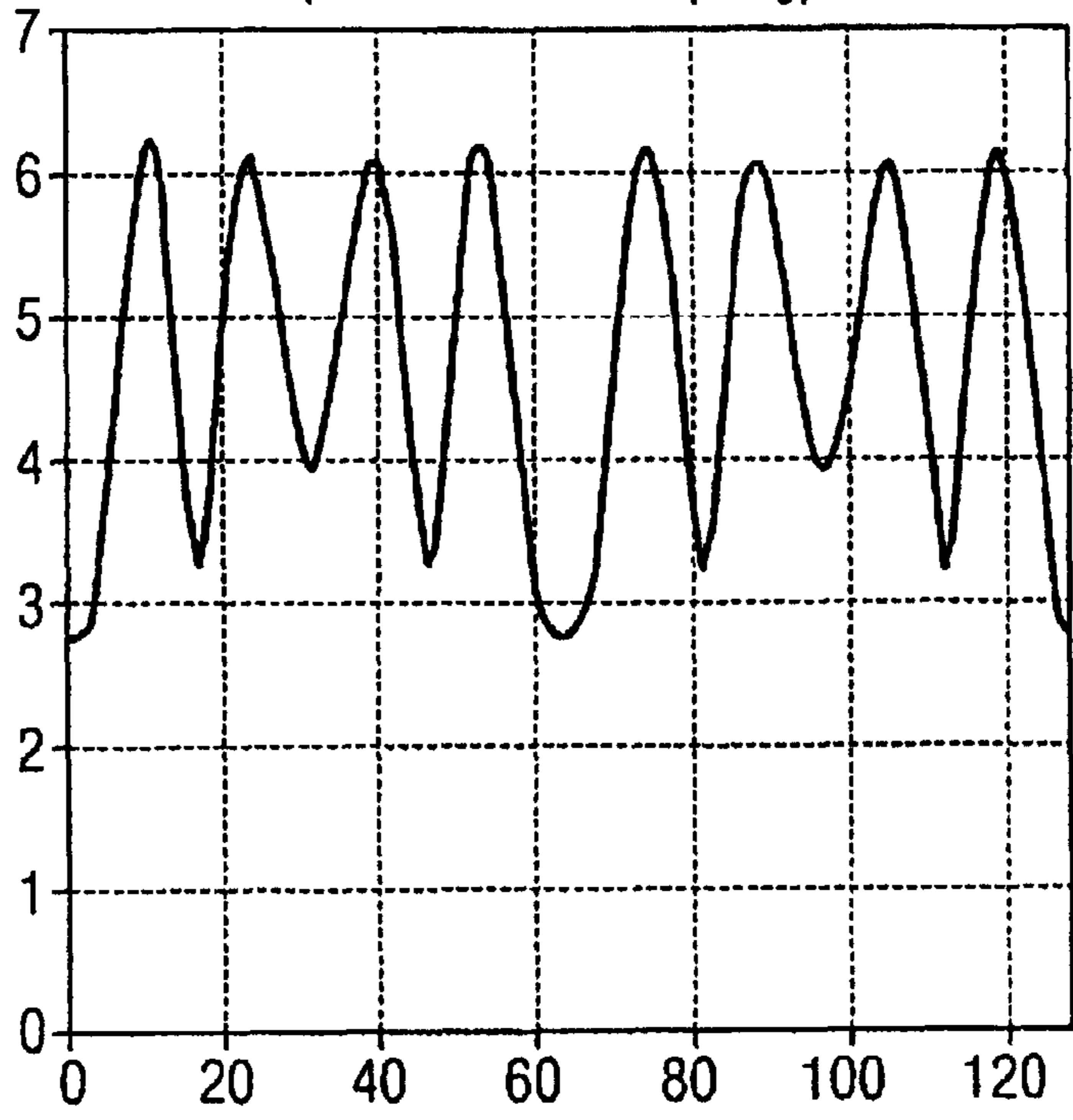

Signal (In and Quad part) using 'Seq-Alt1'  
(8-times oversampling)

FIG 10b

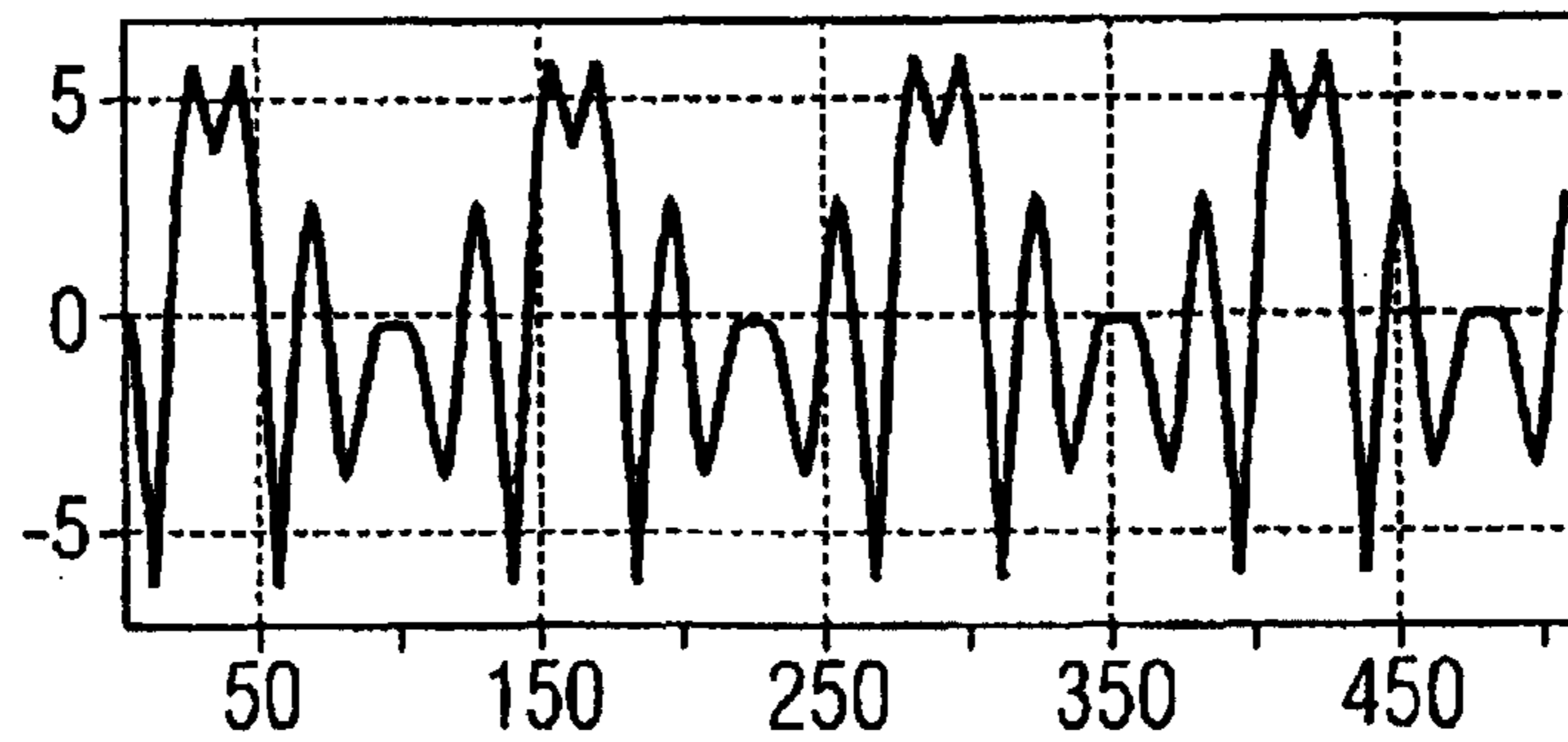
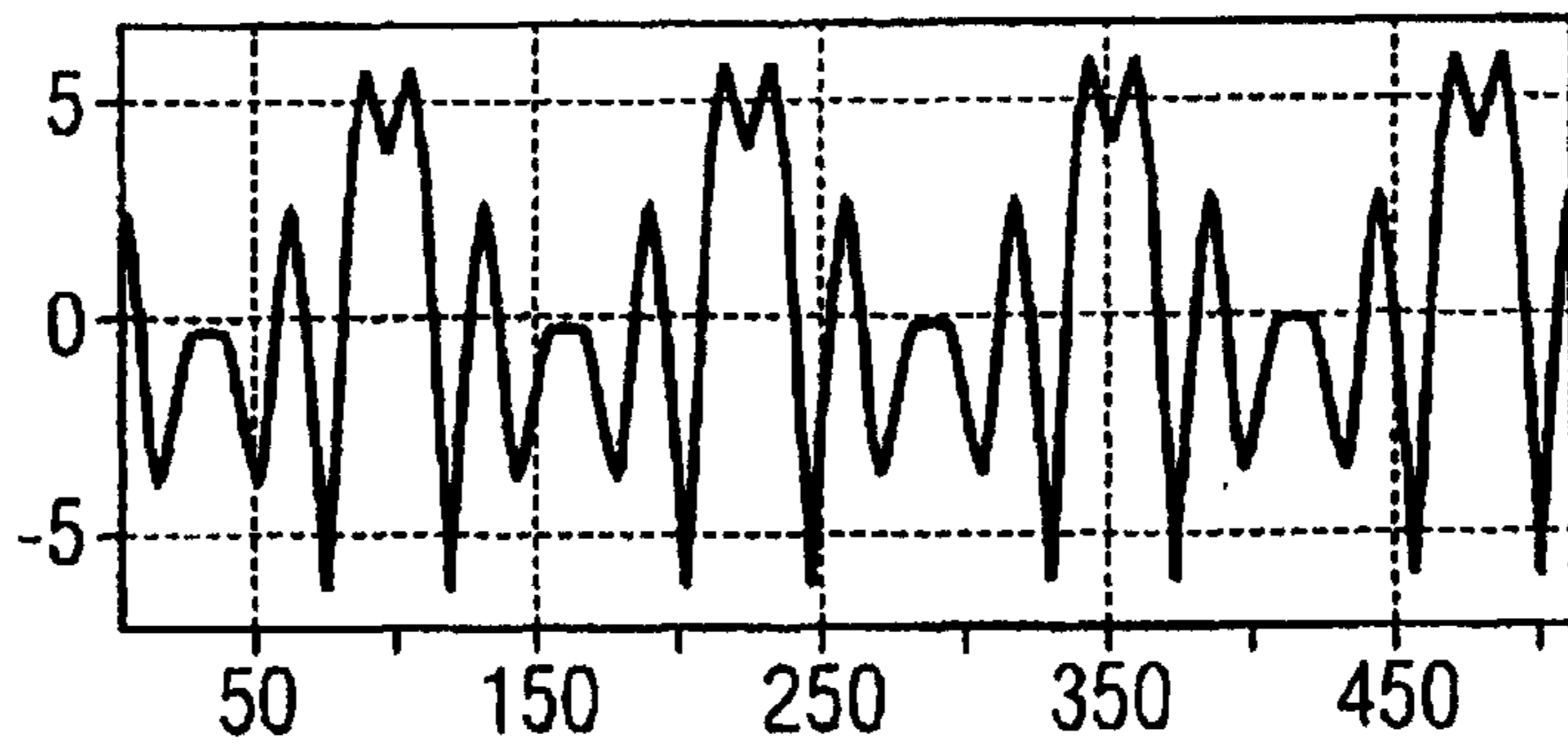

PAPR: 2.24 dB  
Dynamic Range: 7.01 dB

**SYNCHRONIZATION SYMBOL STRUCTURE  
USING OFDM BASED TRANSMISSION  
METHOD**

**Matter enclosed in heavy brackets [ ] appears in the original patent but forms no part of this reissue specification; matter printed in italics indicates the additions made by reissue.**

*Notice: More than one application has been filed for the reissue of U.S. Pat. No. 6,654,339. The reissue applications are 11/286,440, the instant application and applications 12/258,939, 12/258,984, 12/259,018, 12/258,799 and 12/259,063, all filed Oct. 27, 2008.*

The present invention relates to a method for generating synchronization bursts for OFDM transmission systems, a method for synchronizing wireless OFDM systems, an OFDM transmitter as well as to a mobile communications device comprising such a transmitter.

The present invention relates generally to the technical field of synchronizing wireless OFDM (orthogonal frequency division multiplexing) systems. Thereby it is known to use a synchronization burst constructed using especially designed OFDM symbols and time domain repetitions.

Particularly from the document IEEE P802.11a/d2.0 "Draft supplement to a standard for telecommunications and information exchange between systems—LAN/MAN specific requirements—part 1: wireless medium access control (MAC) and physical layer (PHY) specifications: high-speed physical layer in the 5 GHz band" a synchronization scheme for OFDM systems is proposed. This document is herewith included by reference as far as it concerns the synchronization including the proposed implementation. Said known scheme will now be explained with reference to FIG. 6 to 8 of the enclosed drawings.

FIG. 6 shows the structure of the known synchronization field. As shown in FIG. 6 the synchronization field consists of so-called short symbols  $t_1, t_2, \dots, t_6$  and two long symbols  $T_1, T_2$ . In view of the present invention particularly the short symbols  $t_1, t_2, \dots, t_6$  are of interest. Among the short symbols  $t_1, t_2, \dots, t_6$  used for the amplifier gain control ( $t_1, t_2, t_3$ ) and the course frequency offset and timing control only the symbols  $t_1, t_2, t_3$  and  $t_4$  are actually generated, whereas the symbols  $t_5, t_6$  are cyclic extensions (copies of the symbols  $t_1$  and  $t_2$ , respectively). It is to be noted that FIG. 5 shows only the synchronization preamble structure as the structure of the following signal field indicating the type of baseband modulation and the coding rate as well as the structure of further following data fields are not of interest in view of the present invention. For further details reference is made to said prior art document.

The symbols  $t_1, t_2, t_3, t_4$  are generated by means of an OFDM modulation using selected subcarriers from the entire available subcarriers. The symbols used for the OFDM modulation as well as the mapping to the selected subcarriers will now be explained with reference to FIG. 6.

Each of the short OFDM symbols  $t_1, \dots, t_6$  is generated by using 12 modulated subcarriers phase-modulated by the elements of the symbol alphabet:

$$S = \sqrt{2}(\pm 1 \pm j)$$

The full sequence used for the OFDM modulation can be written as follows:

$$S_{-24,24} = \sqrt{2} * \{1 + j, 0, 0, 0, 1 + j, 0, 0, 0, -1 - j, 0, 0, 0, -1 - j, 0, 0, 0, 1 - j, 0, 0, 0, -1 - j, 0, 0, 0, 0, 0, 0, 1 + j, 0, 0, 0, 1 + j, 0, 0, 0, -1 - j, 0, 0, 0, 0, 1 + j, 0, 0, 0, -1 - j, 0, 0, 0, 1 + j\}$$

The multiplication by a factor of  $\sqrt{2}$  is in order to normalize the average power of the resulting OFDM symbol.

The signal can be written as:

$$r_{\text{SHORT}}(t) = w_{\text{SHORT}}(t) \sum_{k=-N_2/2}^{N_2/2} S_k \exp(j2\pi k \Delta_F t)$$

The fact that only spectral lines of  $S_{-24, 24}$  with indices which are a multiple of 4 have nonzero amplitude results in a periodicity of  $T_{\text{FFT}}/4 = 0.8 \mu\text{sec}$ . The interval  $T_{\text{SHORT}}$  is equal to nine  $0.8 \mu\text{sec}$  periods, i.e.  $7.2 \mu\text{sec}$ .

Applying a 64-point IFFT to the vector  $S$ , where the remaining 15 values are set to zero, four short training symbols  $t_1, t_2, t_3, t_4$  (in the time domain) can be generated. The IFFT output is cyclically extended to result in 6 short symbols  $t_1, t_2, t_3, \dots, t_6$ . The mapping scheme is depicted in FIG. 7. The so called virtual subcarriers are left unmodulated.

The way of implement the inverse Fourier transform is by an IFFT (Inverse Fast Fourier Transform) algorithm. If, for example, a 64 point IFFT is used, the coefficients 1 to 24 are mapped to same numbered IFFT inputs, while the coefficients  $-24$  to  $-1$  are copied into IFFT inputs **40** to **63**. The rest of the inputs, 25 to 39 and the 0 (DC) input, are set to zero. This mapping is illustrated in FIG. 7. After performing an IFFT the output is cyclically extended to the desired length.

With the proposed inverse fast Fourier transform (IFFT) mapping as shown in FIG. 7 the resulting time domain signal consists of 4 periodically repeated short symbols  $t_1, t_2, t_3, t_4$ , and cyclically extended by a copy of  $t_1, t_2$ , which copy is depicted in FIG. 5 as  $t_5, t_6$ . Note that in the present case only spectral lines with indices which are a multiple of 4 have nonzero amplitude. Other periodic natures can be generated by setting other multiples of the spectral lines to nonzero amplitudes.

Though the known synchronization scheme is very effective, it provides for disadvantage regarding the time domain signal properties.

For OFDM (or in general multicarrier signals) the signal envelope fluctuation (named Peak-to-Average-Power-Ratio=PAPR) is of great concern. A large PAPR results in poor transmission (due to nonlinear distortion effects of the power amplifier) and other signal limiting components in the transmission system (e.g. limited dynamic range of the AD converter).

For synchronization sequences it is even more desirable to have signals with a low PAPR in order to accelerate the receiver AGC (automatic gain control) locking and adjusting the reference signal value for the A/D converter (the whole dynamic range of the incoming signal should be covered by the A/D converter resolution without any overflow/underflow).

FIGS. 8a, 8b show the "absolute" ( $\sqrt{\text{In}^2 + \text{Quad}^2}$ ) value of the resulting time domain signal waveform with the sequences proposed by Lucent Technologies. Oversampling ( $8^*$ ) was considered in order to ensure the peak was captured correctly using the limited 64-point IFFT.

FIGS. 8c, 8d show the real and imaginary part of the resulting transmitted time domain waveform. The resulting PAPR is 2.9991 dB (no oversampling) and 3.0093 dB (with 8 times oversampling).

Therefore it is the object of the present invention to provide for a synchronization technique which bases on the known synchronization technique but which presents improved time domain signal properties to reduce the requirements for the hardware.

The above object is achieved by means of the features of the independent claims. The dependent claims develop further the central idea of the present invention.

According to the present invention therefore a method for generating synchronization bursts for OFDM transmission systems is provided. Symbols of a predefined symbol sequence are mapped according to a predefined mapping scheme on subcarriers of the OFDM system wherein the symbols of the predefined symbol sequence represent subcarriers with nonzero amplitudes. A synchronization burst is generated by inverse fast Fourier transforming the subcarriers mapped with a predefined symbol sequence. According to the present invention the predefined symbol sequence is optimized such that the envelope fluctuation of the time domain signal (Peak-to-average-power-ratio) is minimized.

The predefined symbol sequence can be chosen such that the following equations are satisfied for all symbols of the predefined symbol sequence:

$$n=2m,$$

$$C_{i-1} \pm C_{1-n}$$

n being the number of symbols of the predefined symbol sequence,

m being an integer larger than one,

C being the symbol value, and

i being an integer running from 1 to m.

The mapping of the symbols of the predefined symbol sequence and the Inverse Fast Fourier Transform can be set such that the resulting time domain signal of the synchronization burst represents a periodic nature.

Alternatively the mapping of the symbols of the predefined symbol sequence and the Inverse Fast Fourier Transform is set such that one burst part of the synchronization burst in the time domain is generated and the periodic nature of the synchronization burst in the time domain is achieved by copying the one burst part.

The number of symbols of a symbol sequence (n) can for example be 12.

The above equations define generally the symbol sequences according to the present invention. The predefined symbol sequence can therefore be for example:

$$A A A -A -A -A -A A -A -A A -A,$$

wherein A is a complex value.

Alternatively the predefined symbol sequence can be:

$$A -A A A -A A A A -A -A -A,$$

wherein A is a complex value.

Alternatively the following predefined symbol sequence can be used:

$$A B -A B -A -B B A -B A -B -A$$

wherein A, B are complex values.

As a further alternative the following sequence can be used:

$$A -B -A -B -A B -B A B A B -A,$$

wherein A, B are complex values.

According to the present invention furthermore a method for synchronizing wireless OFDM systems is provided, wherein a synchronization burst is generated according to a method as set forth above and the synchronization burst is transmitted respectively before the transmission of data fields.

Thereby the time domain signals of the synchronization burst can be precomputed and stored in a memory, such that the computation of the time domain signal of the burst is only effected once.

According to the present invention furthermore a OFDM transmitter is provided comprising a mapping unit for mapping the symbols of a predefined symbols sequence accord-

ing to a predefined mapping scheme on subcarriers of the OFDM system, wherein the symbols of a predefined symbols sequence represent the subcarriers of the OFDM system with nonzero amplitudes. Furthermore an inverse fast Fourier transforming unit is provided for generating a synchronization burst by inverse fast Fourier transforming the subcarriers of the OFDM mapped with said predefined symbols sequence. The mapping unit thereby is designed such that the resulting time domain signal of the synchronization burst represents a periodic nature. The mapping unit according to the present invention uses a predefined symbol sequence which is such that the envelope fluctuation of the time domain signal of the synchronization burst is minimized.

According to the present invention furthermore a mobile communications device such as set forth above is used.

With reference to the figures of the enclosed drawings referred embodiments of the present invention will now be explained.

FIG. 1 shows schematically a transmitter according to the present invention,

FIG. 2 shows an alternative embodiment for a transmitter according to the present invention,

FIG. 3 shows an alternative mapping scheme according to the present invention,

FIGS. 4a to 4d show the time domain signal properties achieved with the synchronization symbol structure using OFDM based transmission according to the present invention,

FIGS. 5a to 5d show the time domain signal properties of synchronization symbol structures according to alternative embodiments of the present invention,

FIG. 6 shows a synchronization preamble structure known from the prior art,

FIG. 7 shows an IFFT mapping according to the prior art, and

FIGS. 8a to 8d show the time domain properties of the synchronization symbol structure according to the prior art,

FIGS. 9a and 9b show the time domain properties, particularly the dynamic range of the synchronization symbol structure according to the prior art, and

FIGS. 10a and 10b show the time domain properties of the synchronization symbol structure according to further alternative embodiments of the present invention,

According to the present invention the time domain synchronization burst structure as shown in FIG. 6 is maintained. The IFFT mapping as shown in FIG. 7 can be maintained or alternatively the IFFT mapping according to FIG. 3 can be used. The symbol sequences mapped to the subcarriers are optimized to sequences which result in a lower PAPR.

According to the present invention a short OFDM symbol (t1, . . . t6) consists of 12 phase-modulated subcarriers.

	C00	C01	C02	C03	C04	C05	C06	C07	C08	C09	C10	C11
Seq0	A	A	A	-A	-A	-A	-A	A	-A	-A	A	-A
Seq1	A	-A	A	A	-A	A	A	A	A	-A	-A	-A
Seq2	A	B	-A	B	-A	-B	B	A	-B	A	-B	-A
Seq3	A	-B	-A	-B	-A	B	-B	A	B	A	B	-A

with

$$A = \exp(j*2 + \pi * \varphi_A) \text{ and}$$

$$B = A * \exp(j\frac{\pi}{2}) = \exp(j2\pi * \varphi_A + j\frac{\pi}{2}) \text{ and } 0.0 \leq \varphi_A < 1.0.$$

Generally the predefined symbol sequence therefore is chosen such that the envelope fluctuation of the time domain signal of the synchronization burst is minimized.

Therefore generally the predefined symbol sequence is set such that the following equations are satisfied for all symbols for the predefined symbol sequence:

$$n=2m,$$

$$C_{i-1} = \pm C_{n-i}$$

wherein n is a number of symbols of the predefined symbol sequence,

m is an integer larger than 1,

c is the symbol value, and

i is an integer value running from 1 to m.

In the following the time domain signal properties of the new sequences according to the present invention will be shown with reference to FIGS. 4a to 4d and FIGS. 5a to 5d.

For simplicity we use in our demonstration the classical quadriphase symbol alphabet,

$$S = \sqrt{\frac{1}{2}} (\pm 1 \pm j),$$

(this corresponds to  $\phi_A=0.125$ )

Symbol		
A	$\exp(j\frac{\pi}{4})$	$\sqrt{\frac{1}{2}} (+1 + j)$
-A	$-\exp(j\frac{\pi}{4}) = \exp(j\frac{5\pi}{4})$	$\sqrt{\frac{1}{2}} (-1 - j)$

10

-continued

Symbol		
B	$\exp(j\frac{\pi}{4} + j\frac{\pi}{2}) = \exp(j\frac{3\pi}{4})$	$\sqrt{\frac{1}{2}} (-1 + j)$
-B	$-\exp(j\frac{3\pi}{4}) = \exp(j\frac{7\pi}{4})$	$\sqrt{\frac{1}{2}} (+1 - j)$

Table 1: Complex symbol mapping

FIGS. 5a and 5b thereby show the time domain signal (magnitude) when using the optimized sequence according to the present invention in the case of no oversampling/8-times oversampling is effected.

PAPR (in decibel) is limited to 2.059 (even when using a time domain oversampling to capture the actual peak).

FIGS. 5c and 5d show the in-phase and quadrature-phase component, respectively, of the resulting wave form. It is clearly visible that the full symbol consists of four repetitions of a short sequence.

FIGS. 5a to 5d show graphics corresponding to FIGS. 4a to 4d for the other proposed sequences S1, S2 and S3.

Further simulations have shown that not only the PAPR can be optimized but also the dynamic range of the signal should be minimized. Therefore another four sequences, with achieve a small PAPR and at the same time a small overall dynamic range are proposed further below.

Using the sequence as proposed in the state of the art the PAPR is 3.01 dB and the dynamic range (defined as the ratio of the peak power to the minimum power) is 30.82 dB (see FIGS. 9a and 9b).

Using the sequences according to the present invention and as described above the PAPR is reduced to 2.06 dB, however, the dynamic range is increased as the signal power is '0' at some points.

Therefore the following four sequences are proposed as a further embodiment of the present invention:

The symbol sequence is C0, C1, . . . C11 and the mapping is:

$$S = 2 * \{C00, 0, 0, 0, C01, 0, 0, 0, C02, 0, 0, 0, C03, 0, 0, 0, C04, 0, 0, 0, C05, 0, 0, 0, 0, 0, 0, C06, 0, 0, 0, C07, 0, 0, 0, C08, 0, 0, 0, C09, 0, 0, 0, C10, 0, 0, 0, C11\}$$

	C00	C01	C02	C03	C04	C05	C06	C07	C08	C09	C10	C11
Seq-Alt0	A	A	A	A	-A	-A	A	-A	-A	A	-A	A
Seq-Alt1	A	-A	A	-A	-A	A	-A	-A	A	A	A	A
Seq-Alt2	A	B	-A	-B	-A	-B	-B	-A	-B	-A	B	A
Seq-Alt3	A	-B	-A	B	-A	B	B	-A	B	-A	-B	A

7

with  $A = \exp(i \cdot 2 \cdot \pi \cdot \phi_A)$  and

$$B = A \cdot \exp\left(j \frac{\pi}{2}\right) = \exp(j2\pi \cdot \phi_A + j \frac{\pi}{2})$$

and  $0.0 \leq \phi_A < 1.0$ .

Using these sequences the PAPR is reduced to 2.24 dB and the dynamic range is limited to 7.01 dB as it is shown in FIGS. 10a and 10b.

The advantages are the same as described before, however, the clipping problem is further reduced due to the very limited dynamic range of the signal.

With reference to FIG. 1 and 2 possible implementations of a transmitter according to the present invention will now be explained.

In the transmitter the sync symbol data 1 are prepared and mapped in a IFFT mapping unit 2 to the appropriate IFFT points. The subcarriers of the OFDM system are transformed by a IFFT unit 3 and then the time domain signal is extended in a time extension unit 4 by copying parts of the signals (for example, t1, t2 are copied to t5, t6). The time extended signal is then sent to the I/Q modulator 5.

As shown in FIG. 2 alternatively the time domain signal can be precomputed once in a computation unit 7 and then be stored in a memory 6 for the precomputed sample for the time signal. Then the time domain signal of the synchronization burst can be sent to the modulator 5 directly from the memory 6.

With reference to FIG. 3 a modified IFFT mapping scheme will now be explained.

According to this scheme, the principle of setting only every fourth subcarrier of the OFDM system to a non-zero amplitude (see FIG. 7) is abandoned. Therefore the time domain signal achieved according to the mapping scheme of FIG. 3 will not present a periodic nature.

The IFFT size is now only 16 (instead of 64 as it is the case in FIG. 7). Only one of the bursts t1, t2, . . . t6 will be generated. The other bursts can be generated by copying to retain the periodic nature of the synchronization time domain signal necessary for the correlation and synchronization on the receiving side. Therefore for example the time extension unit 4 can perform the copying of the 16-sample burst t1 generated by the IFFT 16 according to FIG. 7 to the other burst t2, t3, . . . t6. Obviously the mapping scheme according to FIG. 3 reduces the computing effort necessary for the IFFT. The periodic nature of the time domain signal of the SYNCH bursts is therefore no longer achieved by the IFFT step, but by copying the burst t1 generated with the simplified IFFT mapping scheme.

The mapping scheme shown in FIG. 3 is also advantageous in combination with the precomputing technique shown in FIG. 2.

According to the present invention therefore a synchronization burst structure to be used in high speed wireless transmission systems is proposed. The synchronization burst is constructed using especially designed OFDM symbols and time domain repetitions. The resulting synchronization burst achieves a high timing detection and frequency offset estimation accuracy. Furthermore the burst is optimized to achieve a very low envelope fluctuation (Low peak-to-average-power-ratio) to reduce the complexity on the receiver and to reduce time and frequency acquisition time at the receiver.

Therefore the synchronization performance can further be improved. As with the scheme according to the present invention the envelope of the OFDM based synchronization burst in the time domain is reduced, the AGC pull-in speed

8

at the receiver can be improved and an accurate time and frequency synchronization can be achieved. Furthermore the synchronization complexity on the receiver side can be reduced due to the reduced resolution requirements necessary due to reduced envelope fluctuation.

The advantages of the present invention can be set forth as following:

An OFDM based SYNCH symbol with a reduced Peak-to-Average-Power-Ratio (PARP) is proposed,

Improved synchronization performance (compared to the state of the art proposal),

Reduced AGC (automatic gain control) pull-in time due to reduced dynamic range of the SYNCH burst,

Improved AGC settlement (AGC has to adjust to an incoming signal level that later on now overflow/underflow in the AGC happens. The reduced dynamic range of the SYNCH burst help to find this reference level more accurate),

Reduced synchronization detection complexity on the receiver (reduced resolution necessary due to reduced envelope fluctuation).

What is claimed is:

**[1.** A method for generating synchronization bursts for OFDM transmission systems, comprising the following steps:

mapping the symbols of a predefined symbol sequence according to a predefined mapping scheme on subcarriers S of the OFDM system, wherein the symbols of the predefined symbol sequence represent subcarriers of the OFDM system with non-zero-amplitude, and

generating a synchronization burst by Inverse Fourier Transforming the subcarriers S of the OFDM system mapped with the symbols of said predefined symbol sequence,

characterized in that

the predefined symbol sequence is set such that the envelope fluctuation of the time domain signal of the synchronization burst is minimized and the symbols of the predefined symbols sequence can be expressed as

$A -A A -A -A A -A -A A A A A$

A being a complex value.]

**[2.** A method for synchronizing wireless OFDM systems, characterized by the steps of

generating a synchronization burst according to a method according to claim 1, and

transmitting the synchronization burst.]

**[3.** A method according to claim 2, characterized in that the time domain signal of the synchronization burst is precomputed and stored in a memory.]

**[4.** An OFDM transmitter, comprising:

a unit for mapping the symbols of a predefined symbol sequence according to a predefined mapping scheme on subcarriers of the OFDM system, wherein the symbols of the predefined symbol sequence represent subcarriers of the OFDM system with non-zero-amplitude, and

a unit for generating a synchronization burst by Inverse Fourier Transforming the subcarriers of the OFDM system mapped with the symbols of said predefined symbol sequence,

characterized in that

the mapping unit is designed to modulate the subcarriers such that the envelope fluctuation of the time

9

domain signal of the synchronization burst is minimized by using the following predefined symbol sequence:

A -A A -A -A A -A -A A A A A  
A being a complex value.]

[5. An OFDM transmitter according to claim 4, characterized by

a time extension unit copying the burst part to achieve a periodic nature of the time domain signal.]

[6. An OFDM transmitter according to claim 4, characterized by

a processing unit for precomputing the time domain signal of the synchronization burst

and a memory for storing the precomputed time domain signal of the synchronization burst.]

[7. A mobile communications device, comprising a transmitter according to claim 4.]

[8. A synchronization burst signal for synchronizing OFDM systems generated by a method according to claim 1.]

9. A method for generating a signal for frequency synchronization of OFDM systems, the method comprising the steps of:

mapping symbols of a predefined symbol sequence in the frequency domain according to a defined mapping scheme on a plurality of subcarriers of the OFDM system, wherein the symbols of the symbol sequence define the subcarriers of the OFDM system with non-zero amplitude, where  $n$  is an integer, and

generating a time-domain synchronization signal in a time extension unit by Inverse Fourier Transforming the subcarriers of the OFDM system mapped with the symbols of the symbol sequence,

wherein the symbol sequence comprises 12 symbols  $C_0, \dots, C_{11}$  wherein  $C_0, C_1, C_2, \dots, C_{11}$  has the value

$$\sqrt{\left(\frac{1}{2}\right)} (\pm l \pm j).$$

10. The method of claim 9,

wherein the following equation is met for all symbols  $C_0, \dots, C_{11}$ :

$$C_{i-1} = \pm C_{n-i}$$

where  $i$  is an integer from 1 to 6 and  $n$  is the number of symbols of the predefined symbol sequence.

11. The method of claim 9, wherein the symbols of the sequence are evenly spaced in the frequency domain.

12. A method for generating a synchronization signal for frequency synchronization of OFDM systems, comprising the steps of:

generating a predefined symbol sequence having twelve symbols  $C_0, \dots, C_{11}$  corresponding to respective pre-selected ones of a plurality of subcarriers of the OFDM system, and

generating a time domain synchronization signal by a time extension unit performing Inverse Fourier Transformation on said pre-selected ones of said plurality of subcarriers,

wherein said twelve symbols are set to non-zero having complex values and others of said symbols are set to zero, such that said twelve symbols are arranged peri-

10

odically in said predefined symbol sequence in the frequency domain and

wherein  $C_0, C_1, C_2, \dots, C_{11}$  of the symbol sequence has the value,

$$\sqrt{\left(\frac{1}{2}\right)} (\pm l \pm j).$$

13. The method of claim 12, further comprising the steps of transmitting, receiving and auto-correlating said synchronization signal.

14. A wireless communication transmitting device for use in an OFDM system, comprising:

a mapping unit for mapping symbols of a predefined symbol sequence, in the frequency domain, according to a defined mapping scheme on a plurality of subcarriers of the OFDM system, wherein symbols  $C_0, C_1, C_2, \dots, C_{11}$  of the symbol sequence define subcarriers of the OFDM system with non-zero amplitude, and

an Inverse Fourier Transformer (IFFT) for generating a time-domain synchronization signal by Inverse Fourier Transforming the subcarriers of the OFDM system mapped with the symbols of the symbol sequence,

wherein the symbol sequence comprises twelve symbols  $C_0, \dots, C_{11}$  wherein  $C_0, \dots, C_{11}$  of said twelve symbols has the value

$$\sqrt{\left(\frac{1}{2}\right)} (\pm l \pm j).$$

15. The device of claim 14,

wherein the following equation is met for all symbols  $C_0, \dots, C_{11}$ :

$$C_{i-1} = \pm C_{n-i}$$

where  $i$  is an integer from 1 to 6 and  $n$  is the number of symbols of the predefined symbol sequence.

16. The device of claim 14, wherein the symbols of the predefined symbol sequence are evenly spaced in the frequency domain.

17. Apparatus for generating a synchronization signal for frequency synchronization of OFDM systems, comprising:

a unit for generating a predefined symbol sequence having twelve symbols  $C_0, C_1, C_2, \dots, C_{11}$  corresponding to respective pre-selected ones of a plurality of subcarriers of the OFDM system, and

a unit for generating a time domain synchronization signal by performing Inverse Fourier Transformation on said pre-selected ones of said plurality of subcarriers,

wherein said twelve symbols are set to non-zero having complex values and others of said symbols are set to zero, such that said twelve symbols are arranged periodically in said predefined symbol sequence in the frequency domain and

wherein  $C_0, C_1, C_2, \dots, C_{11}$  of said twelve symbols has the value



11

$$\sqrt{\left(\frac{1}{2}\right)}_{(\pm l \pm j)}.$$

18. A method for transmitting data signals in an OFDM transmission system, comprising the steps of:

receiving a plurality of subcarriers on which a predefined symbol sequence is mapped, said predefined symbol sequence having twelve symbols  $C_0, \dots, C_{11}$  set to non-zero values and other symbols set to zero values, wherein  $C_0, \dots, C_{11}$  of said twelve symbols has the value

$$\sqrt{\left(\frac{1}{2}\right)}_{(\pm l \pm j)},$$

generating a time domain synchronization signal by a time extension unit performing Inverse Fourier Transformation on said plurality of subcarriers, and transmitting said synchronization and data signals.

19. A method for transmitting data signals in an OFDM transmission system, comprising the steps of:

receiving a plurality of subcarriers on which a predefined symbol sequence is mapped,

generating a time domain synchronization signal by a time extension unit performing Inverse Fourier Transformation on said plurality of subcarriers, and transmitting said synchronization and data signals,

wherein the symbol sequence comprises twelve symbols  $C_0, \dots, C_{11}$  and wherein  $C_0, \dots, C_{11}$  of said twelve symbols has the value

$$\sqrt{\left(\frac{1}{2}\right)}_{(\pm l \pm j)},$$

and

wherein said twelve symbols are arranged periodically in said predefined symbol sequence in the frequency domain.

20. A method for transmitting data signals in an OFDM transmission system, comprising the steps of:

generating time domain synchronization signals by a time extension unit performing Inverse Fourier Transformation on a plurality of subcarriers in which a predefined symbol sequence is mapped in accordance with a predefined mapping scheme, and

transmitting said synchronization signals and said data signals,

wherein the symbol sequence includes twelve symbols  $C_0, \dots, C_{11}$  and wherein  $C_0, \dots, C_{11}$  of said twelve symbols has the value

$$\sqrt{\left(\frac{1}{2}\right)}_{(\pm l \pm j)},$$

and

wherein said twelve symbols are mapped on every fourth subcarrier of said plurality of subcarriers.

12

21. Apparatus for transmitting data signals in an OFDM transmission system, comprising:

a unit for receiving a plurality of subcarriers on which a predefined symbol sequence is mapped, said predefined symbol sequence having twelve symbols  $C_0, \dots, C_{11}$  set to non-zero values and other symbols set to zero values, wherein  $C_0, \dots, C_{11}$  of said twelve has the value

$$\sqrt{\left(\frac{1}{2}\right)}_{(\pm l \pm j)},$$

a unit for generating a time domain synchronization signal by performing Inverse Fourier Transformation on said plurality of subcarriers, and

a transmitter for transmitting said synchronization and data signals.

22. Apparatus for transmitting data signals in an OFDM transmission system, comprising:

a unit for receiving a plurality of subcarriers on which a predefined symbol sequence is mapped,

a unit for generating a time domain synchronization signal by performing Inverse Fourier Transformation on said plurality of subcarriers, and

a transmitter for transmitting said synchronization and data signals,

wherein the symbol sequence includes twelve symbols  $C_0, \dots, C_{11}$  and wherein  $C_0, \dots, C_{11}$  of said twelve symbols has the value

$$\sqrt{\left(\frac{1}{2}\right)}_{(\pm l \pm j)},$$

and

wherein said twelve symbols are arranged periodically in said predefined symbol sequence in the frequency domain.

23. Apparatus for transmitting data signals in an OFDM transmission system, comprising:

a unit for generating time domain synchronization signals by performing Inverse Fourier Transformation on a plurality of subcarriers on which a predefined symbol sequence is mapped in accordance with a predefined mapping scheme, and

a transmitter for transmitting said synchronization and data signals,

wherein the symbols of the symbol sequence comprise twelve symbols  $C_0, \dots, C_{11}$  and wherein  $C_0, \dots, C_{11}$  of said twelve symbols has the value

$$\sqrt{\left(\frac{1}{2}\right)}_{(\pm l \pm j)},$$

and

wherein said twelve symbols are mapped on every fourth subcarrier of said plurality of subcarriers.

\* \* \* \* \*