



US00RE41431E

(19) **United States**
(12) **Reissued Patent**
Böhnke et al.

(10) **Patent Number:** **US RE41,431 E**
(45) **Date of Reissued Patent:** **Jul. 13, 2010**

(54) **SYNCHRONIZATION SYMBOL STRUCTURE USING OFDM BASED TRANSMISSION METHOD**

6,539,215 B1 3/2003 Brankovic et al.
6,545,997 B1 4/2003 Böhnke et al.
6,557,139 B2 4/2003 Böhnke

(75) Inventors: **Ralf Böhnke**, Esslingen (DE); **Thomas Dölle**, Chemnitz (DE); **Tino Puch**, Bonn (DE)

(Continued)

(73) Assignee: **Sony Corporation**, Tokyo (JP)

FOREIGN PATENT DOCUMENTS

CA 2 291 847 9/2005
EP 0 836 303 4/1998
EP 0 869 646 10/1998

(21) Appl. No.: **12/259,018**

(Continued)

(22) Filed: **Oct. 27, 2008**

OTHER PUBLICATIONS

Related U.S. Patent Documents

Cimini et al, Peak-to-Average Power Ratio Reduction of an OFDM Signal Using Partial Transmit Sequences, IEEE, 5 pages, 1999.*

Reissue of:

(64) Patent No.: **6,654,339**
Issued: **Nov. 25, 2003**
Appl. No.: **09/479,281**
Filed: **Jan. 6, 2000**

(Continued)

(30) **Foreign Application Priority Data**

Primary Examiner—Frank Duong
(74) *Attorney, Agent, or Firm*—Frommer Lawrence & Haug LLP; William S. Frommer; Thomas F. Presson

Jan. 28, 1999 (EP) 99100263
Feb. 22, 1999 (EP) 99103379

(57) **ABSTRACT**

(51) **Int. Cl.**
H04J 11/00 (2006.01)

The present invention proposes a method for generating synchronization bursts for OFDM transmission systems. The symbols of a predefined symbol sequence are mapped according to a predefined mapping scheme on subcarriers of the OFDM systems by a mapping unit (2), wherein the symbols of the predefined symbol sequence represent subcarriers of the OFDM system with nonzero amplitudes. A synchronization burst is generated by a inverse fast Fourier transforming unit (3) transforming the subcarriers of the OFDM system mapped to said predefined symbol sequence. The mapping (2) of the symbols of the predefined symbol sequence is set such that the resulting time domain signal of the synchronization burst represents a periodic nature. According to the invention the predefined symbol sequence is set such that the envelope fluctuation of the time domain signal of the synchronization burst is minimized. Therefore advantageous symbol sequences reducing said the envelope fluctuation of the time domain signal are proposed.

(52) **U.S. Cl.** **370/203; 370/208; 370/350; 375/355**

(58) **Field of Classification Search** None
See application file for complete search history.

(56) **References Cited**

U.S. PATENT DOCUMENTS

5,450,456 A 9/1995 Mueller
5,732,113 A 3/1998 Schmidl et al.
6,160,791 A 12/2000 Böhnke
6,160,821 A 12/2000 Dölle et al.
6,407,846 B1 6/2002 Myers et al.
6,438,173 B1 8/2002 Stantchev
6,452,987 B1 9/2002 Larson et al.
6,470,055 B1 10/2002 Feher
6,507,733 B1 1/2003 Krupezevic et al.
6,535,501 B1 3/2003 Böhnke

9 Claims, 9 Drawing Sheets

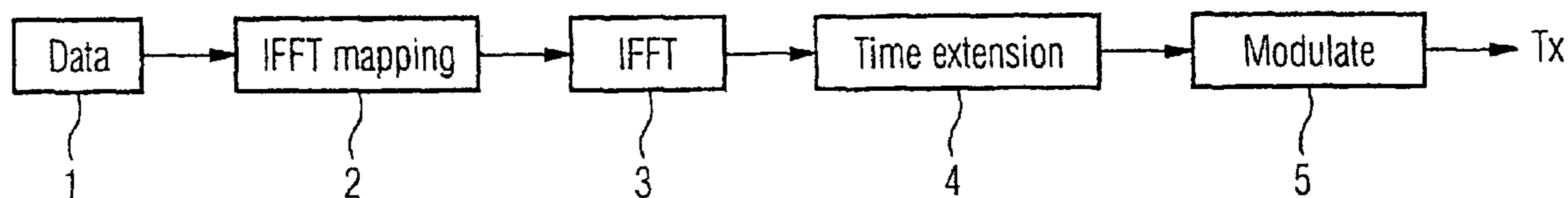

U.S. PATENT DOCUMENTS

6,567,374	B1	5/2003	Böhnke et al.
6,567,383	B1	5/2003	Böhnke
6,609,010	B1	8/2003	Dolle et al.
6,650,178	B1	11/2003	Brankovic et al.
6,654,339	B1	11/2003	Böhnke et al.
6,674,732	B1	1/2004	Boehnke et al.
6,674,817	B1	1/2004	Dölle et al.
6,704,562	B1	3/2004	Oberschmidt et al.
6,724,246	B2	4/2004	Oberschmidt et al.
6,728,550	B1	4/2004	Böhnke et al.
6,731,594	B1	5/2004	Böhnke
6,735,261	B1	5/2004	Oberschmidt et al.
6,738,443	B1	5/2004	Böhnke et al.
6,748,203	B1	6/2004	Brankovic et al.
6,803,814	B1	10/2004	Krupezevic et al.
6,917,580	B2	7/2005	Wang et al.
7,012,882	B2	3/2006	Wang et al.
7,106,821	B2	9/2006	Usui et al.
7,145,955	B1	12/2006	Böhnke et al.
7,154,975	B1	12/2006	Böhnke et al.
7,184,725	B2	2/2007	Ruhm et al.
2004/0196916	A1	10/2004	Böhnke et al.
2006/0045219	A1	3/2006	Wang et al.
2006/0133408	A1	6/2006	Nogueira-Nine et al.
2006/0148906	A1	7/2006	Bieniarz et al.
2006/0269008	A1	11/2006	Böhnke et al.
2007/0036235	A1	2/2007	Böhnke et al.
2007/0115827	A1	5/2007	Boehnke et al.

FOREIGN PATENT DOCUMENTS

EP	0 982 905	3/2000
EP	0 984 595	3/2000
EP	0 984 596	3/2000
EP	0 987 863	3/2000
EP	1 014 562	6/2000
EP	1 018 827	7/2000
EP	1 037 481	9/2000
EP	1 039 661	9/2000
EP	1 065 855	1/2001

EP	1 162 764	12/2001
EP	1 170 916	1/2002
EP	1 170 917	1/2002
EP	1 207 661	5/2002
EP	1 207 662	5/2002
EP	1 276 251	1/2003
EP	1 276 288	1/2003
EP	1 379 026	1/2004
EP	1 439 677	7/2004
EP	1 530 336	5/2005
EP	1 667 341	6/2006
EP	1 705 852	9/2006
EP	1 722 527	11/2006
GB	2 320 868	7/1998
JP	2000 209183	7/2000
KR	10 0712865	4/2007
WO	WO 98 00946	1/1998

OTHER PUBLICATIONS

Dinis R et al: "Carrier Synchronization With CEPB-OFDM" 1997 IEEE 47th. Vehicular Technology Conference, Phoenix, May 4-7, 1997, vol. 3, No. Conf. 47, May 4, 1997 (May 4, 1997), pp. 1370-1374, XP000738586 Institute of Electrical and Electronics Engineers.

Bauml R W et al: "Reducing the Peak-to-Average Power Ratio of Multicarrier Modulation by Selected Mapping" Electronics Letters, vol. 32, No. 22, Oct. 24, 1996 (Oct. 24, 1996), p. 2056-2057, XP000643915.

Schmidl T M et al: "Low-Overheated, Low-Complexity Burst Synchronization for OFDM" 1996 IEEE International Conference on Communications (ICC), Converging Technologies for Tomorrow's Applications Dallas, Jun. 23-27, 1996, vol. 3, Jun 23, 1996 (Jun. 23, 1996), pp. 1301-1306, XP000625022 Institute of Electrical & Electronics Engineers ISBN: 0-7803-3251-2.

Mizoguchi et al: "A Fast Burst Synchronization Scheme for OFDM", IEEE, pp. 125-129, 1998.

* cited by examiner

FIG 1

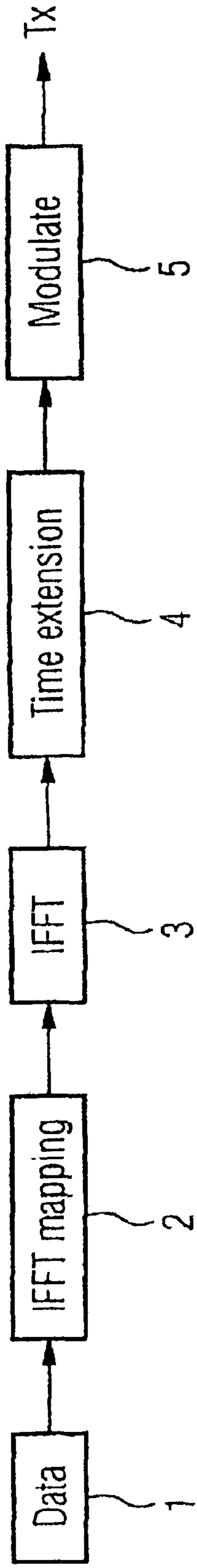

FIG 2

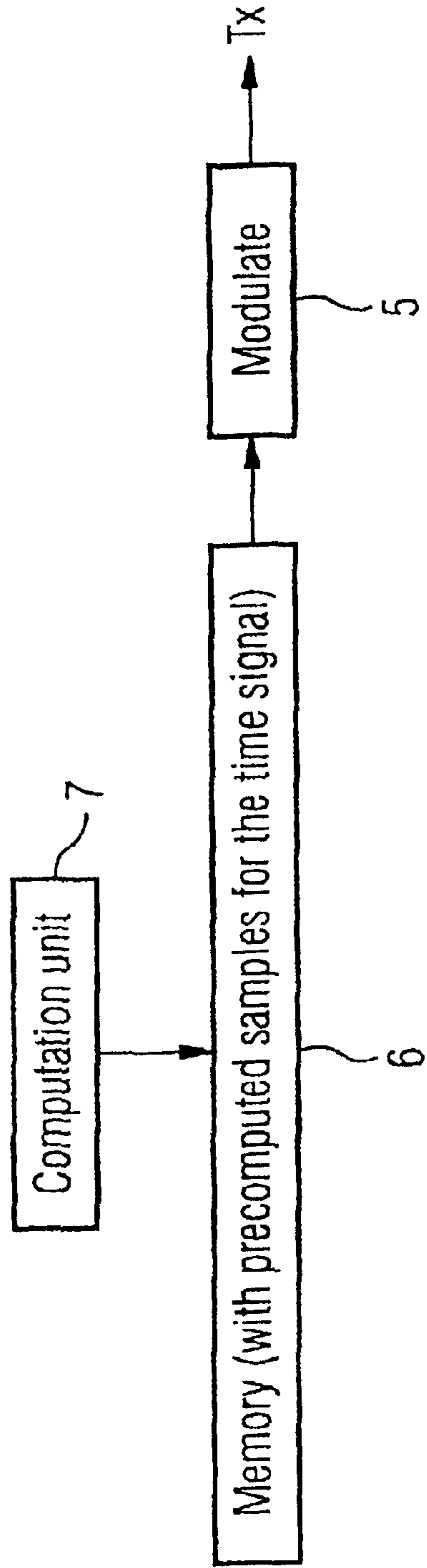

FIG 3

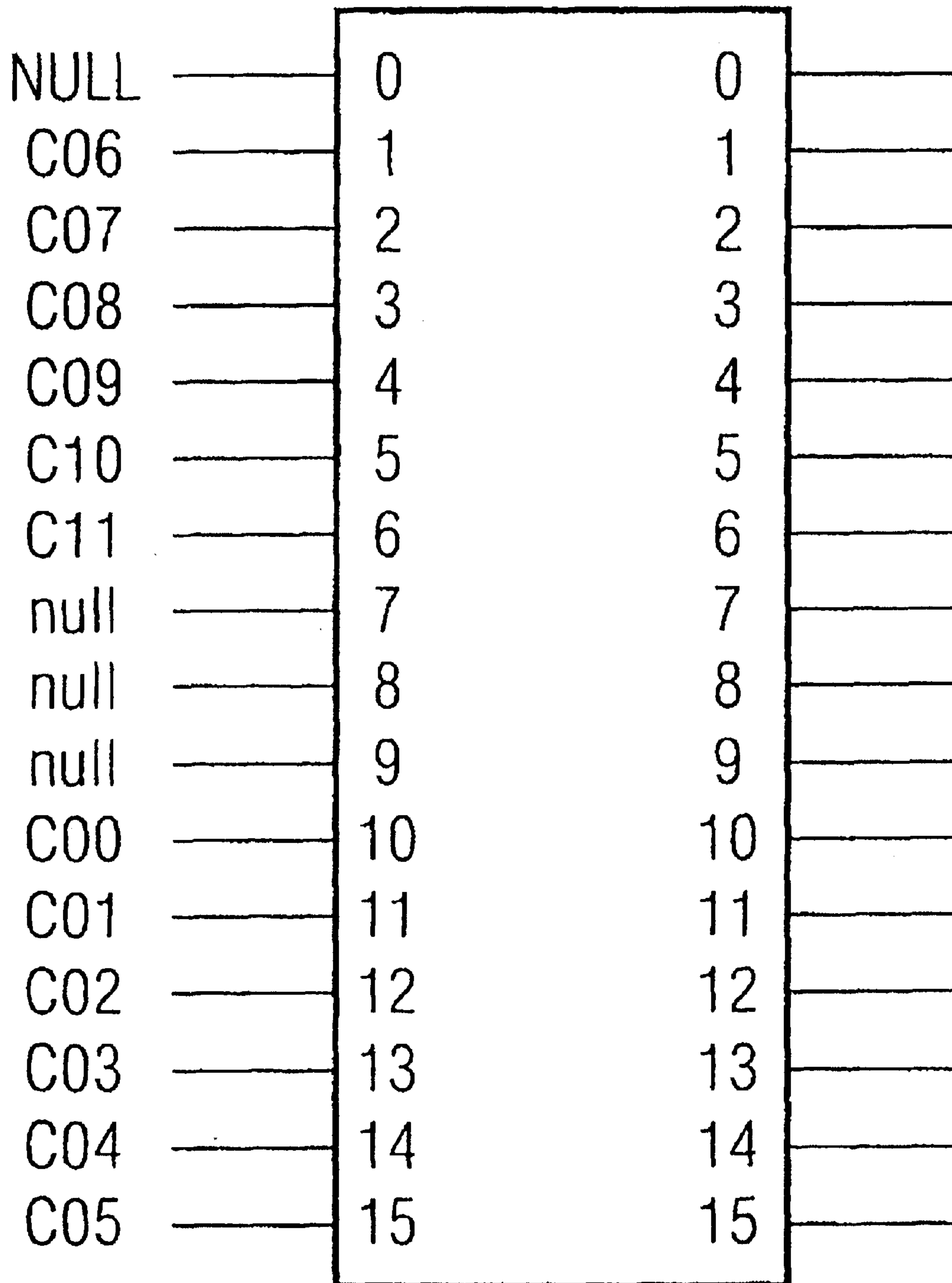

FIG 4a

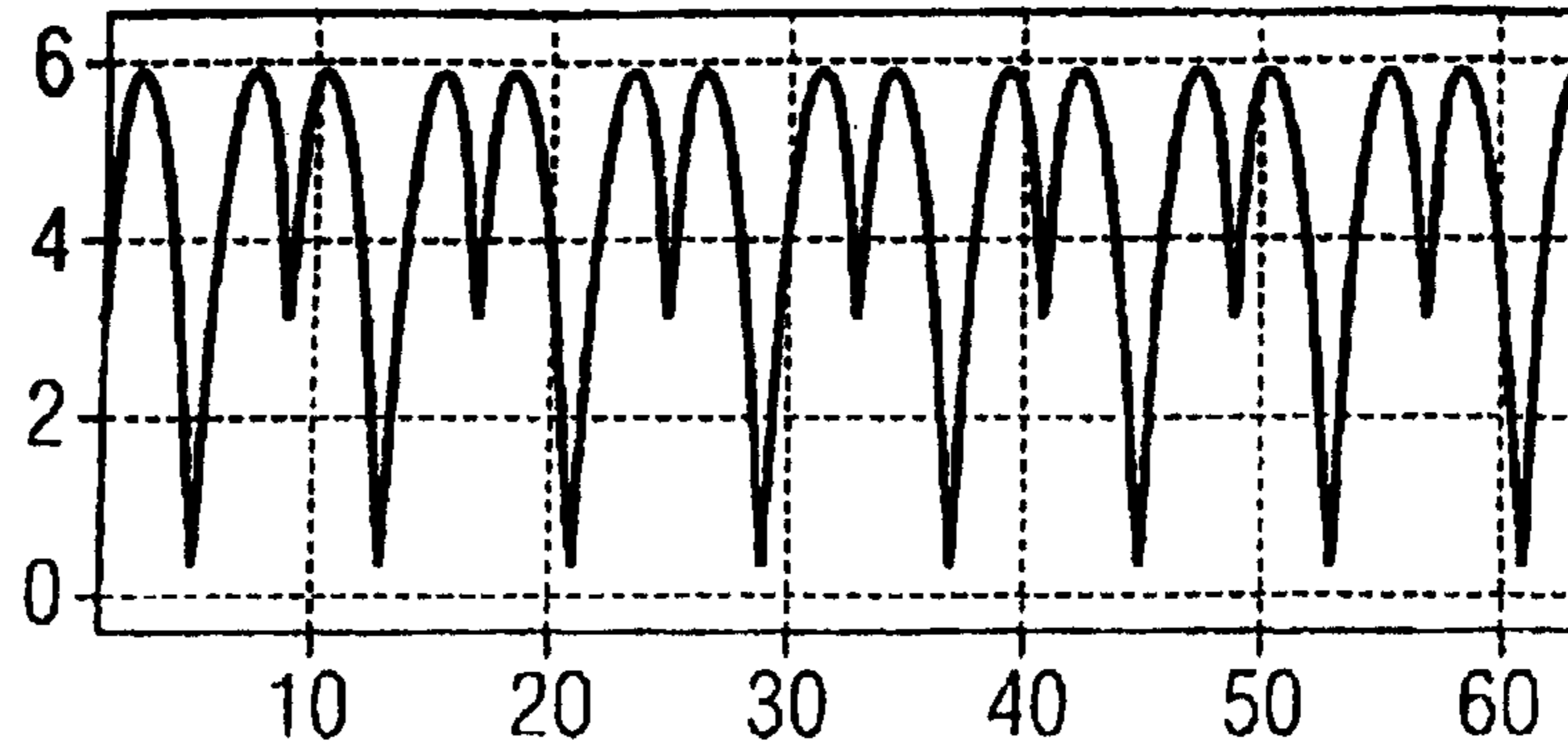

FIG 4b

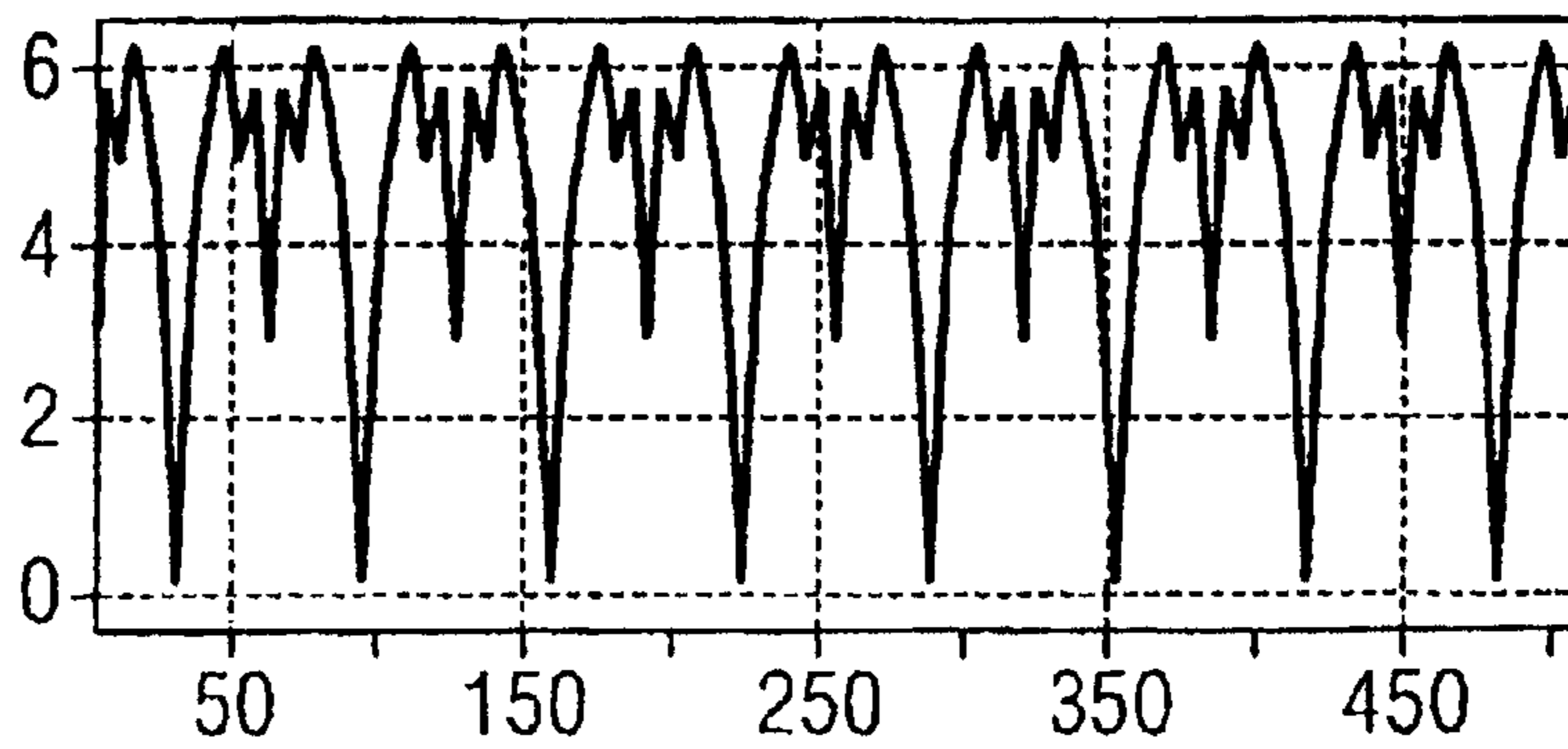

FIG 4c

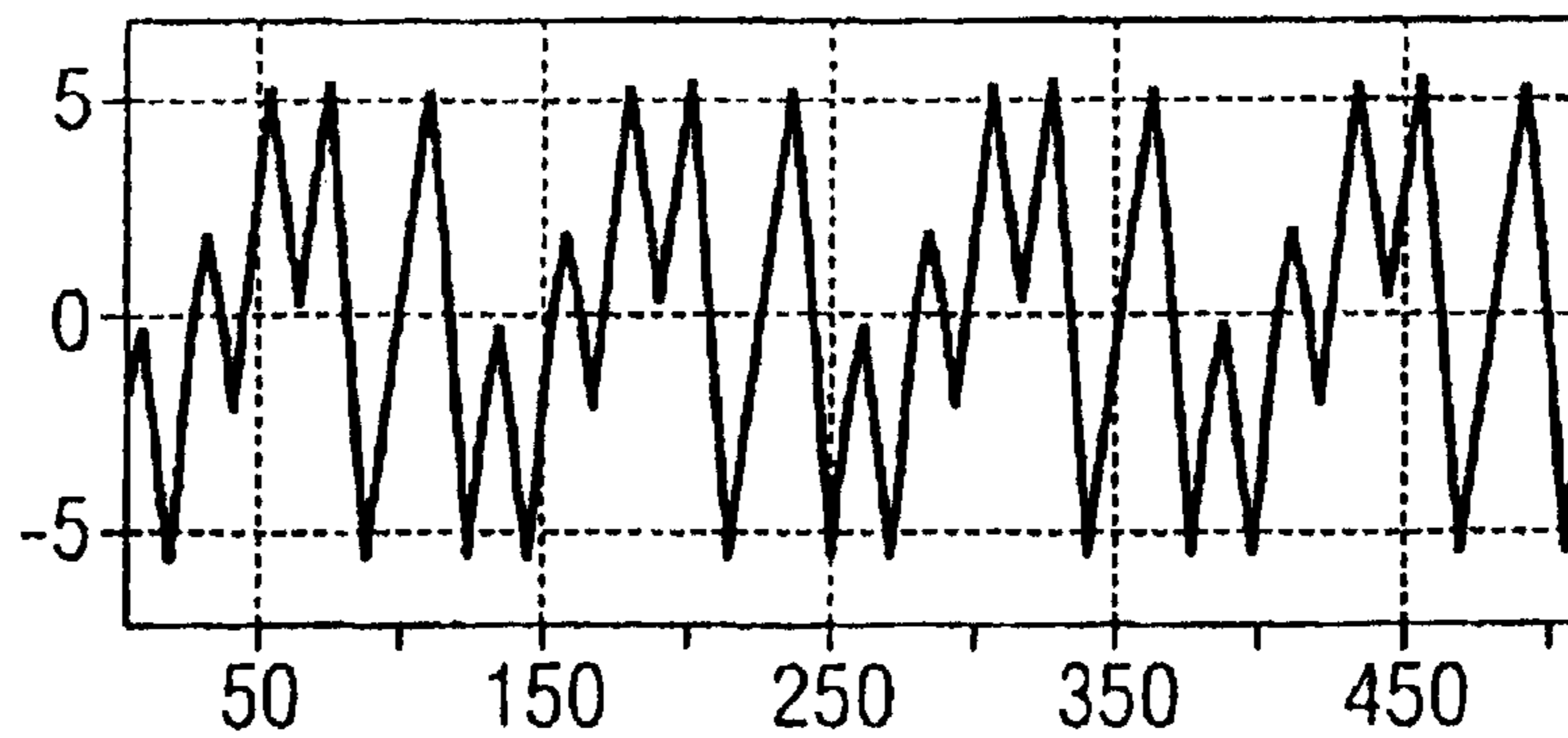
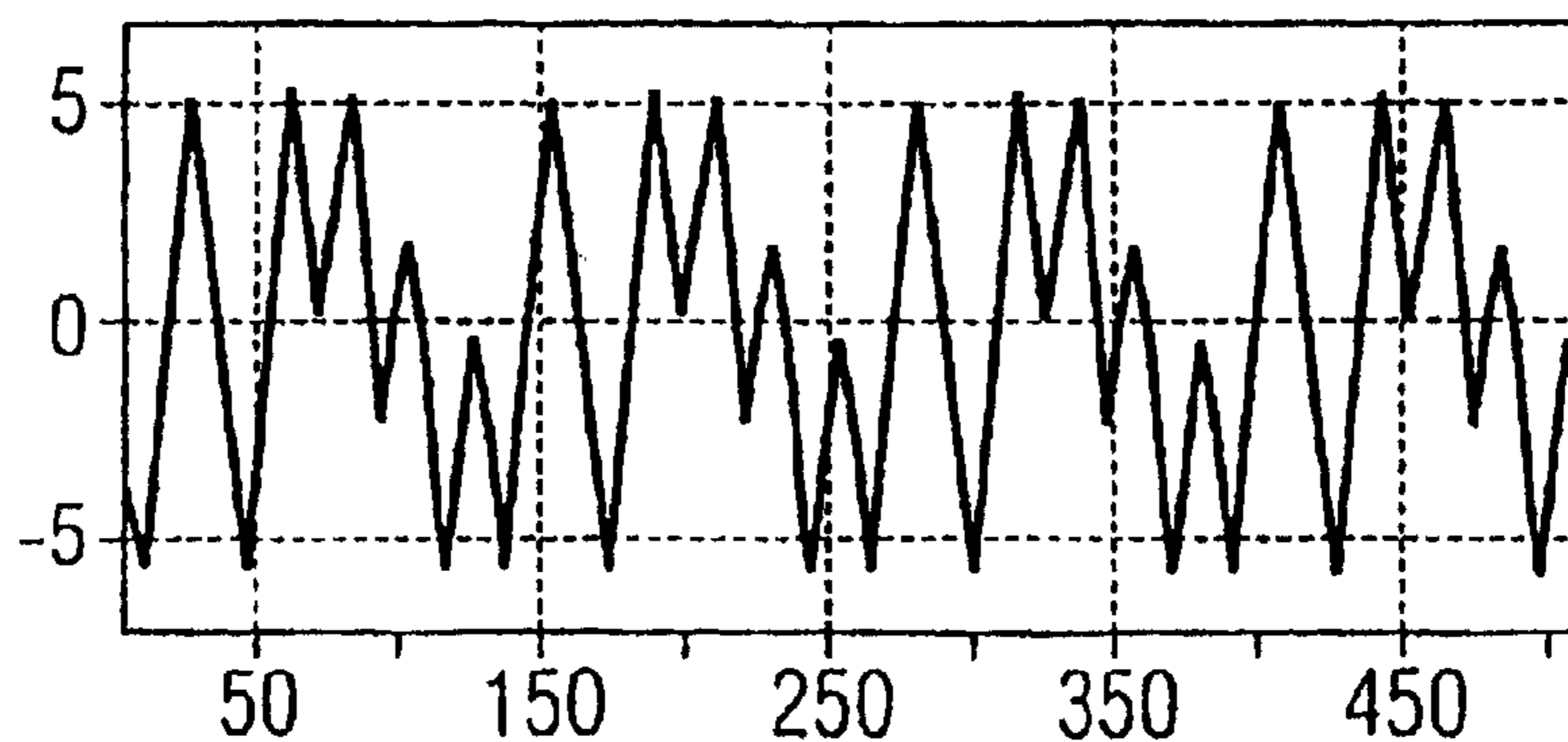

FIG 4d



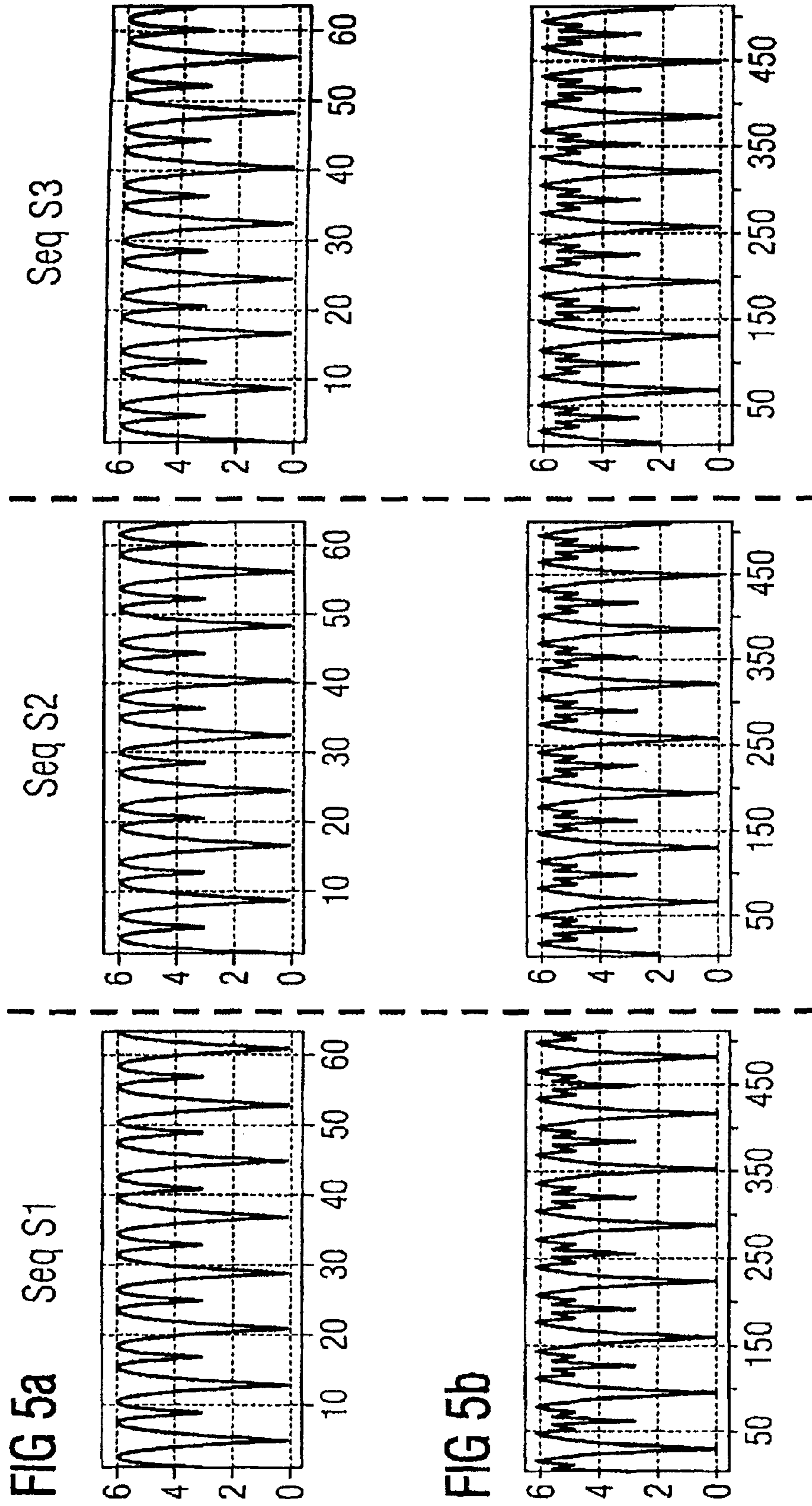
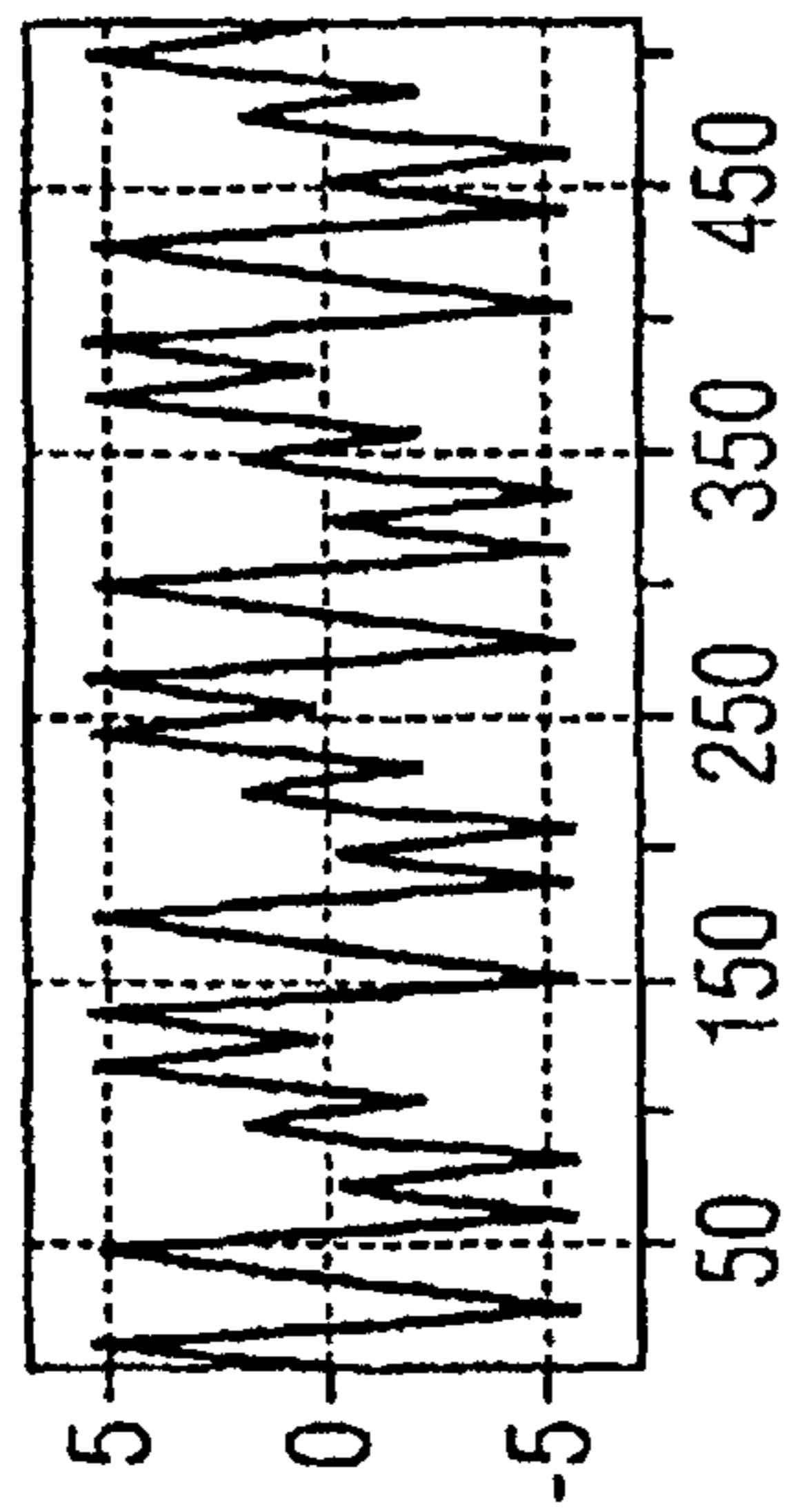
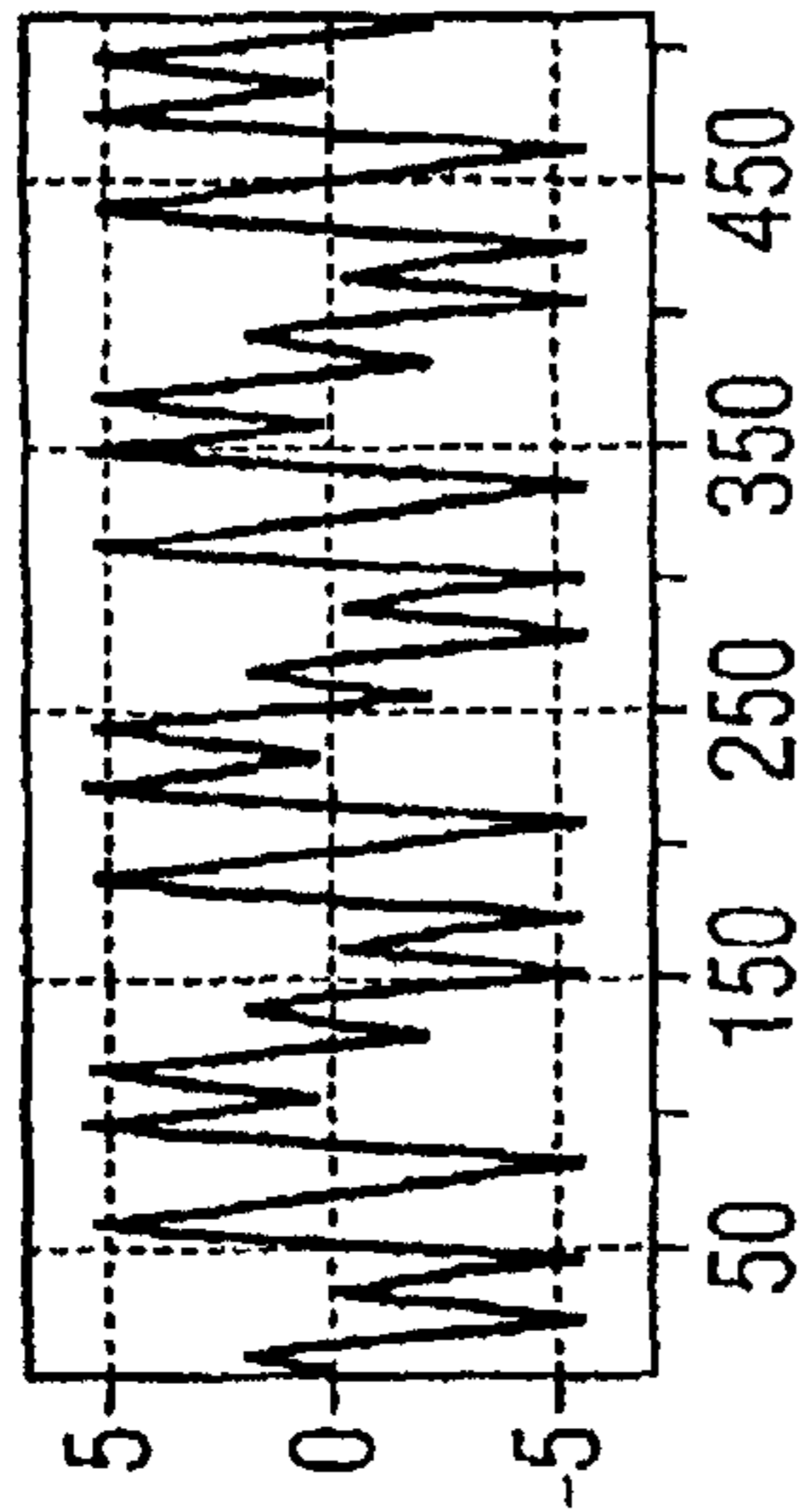

FIG 5c Seq S1



Seq S2



Seq S3

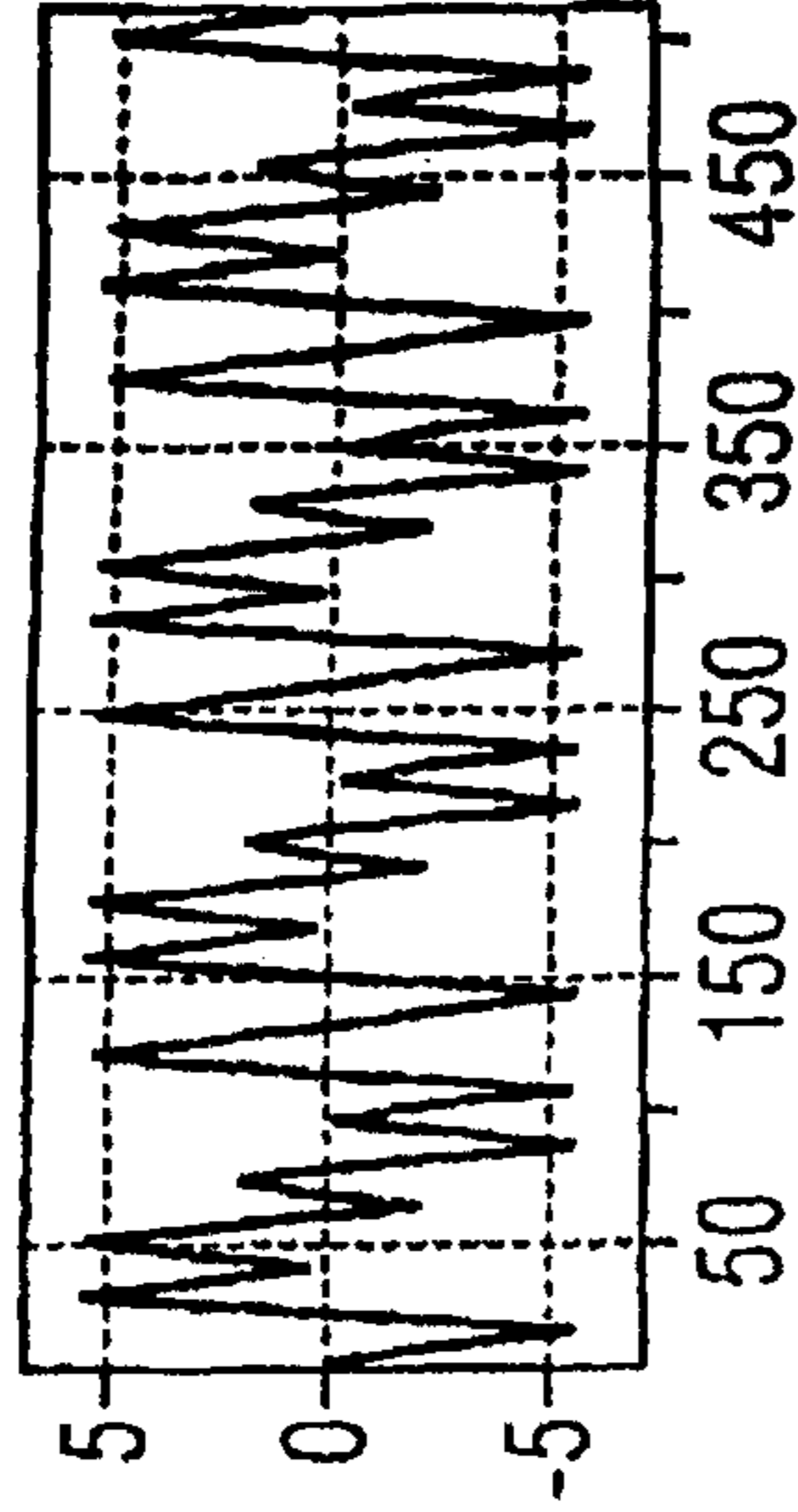

FIG 5d

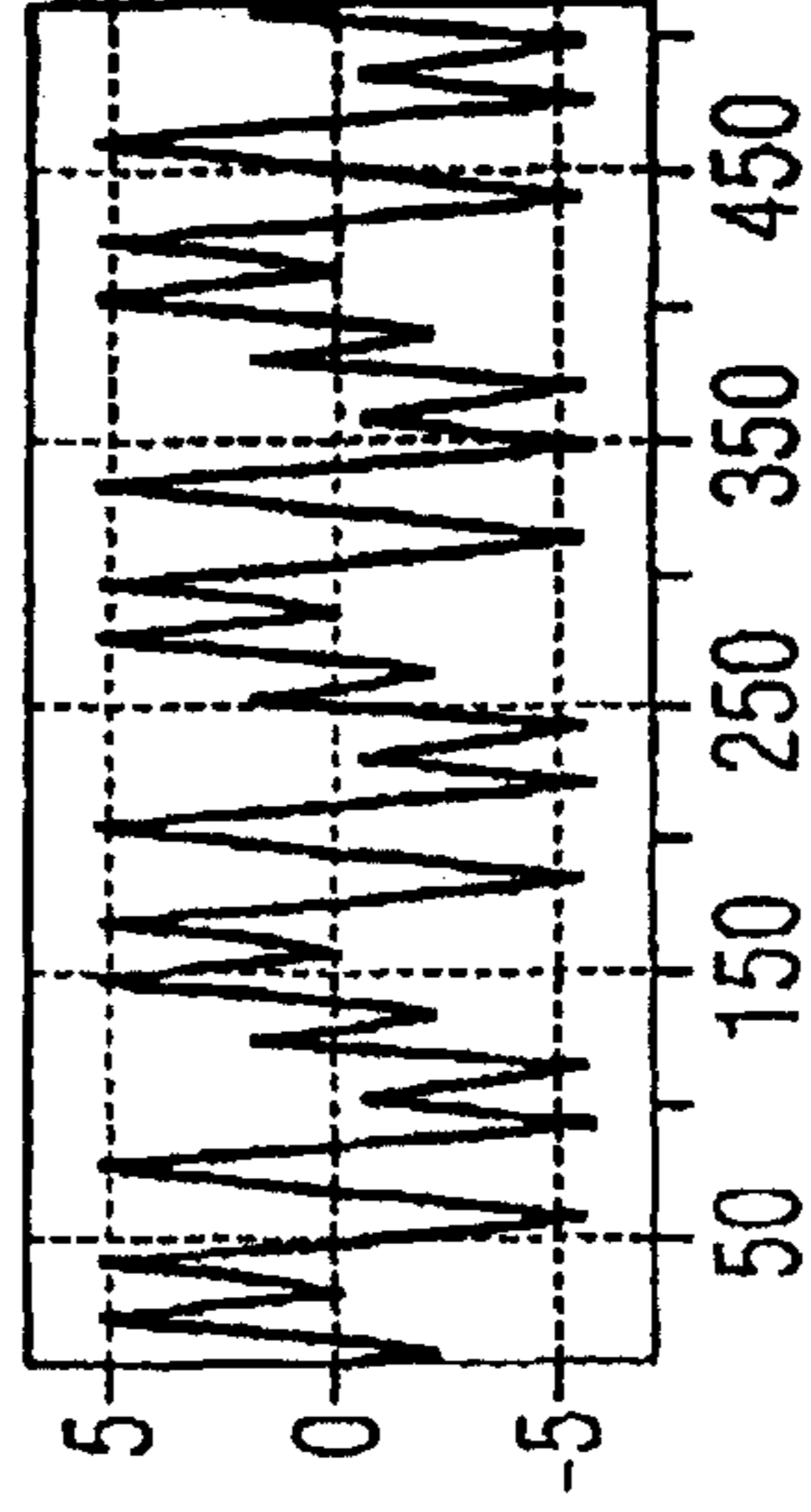
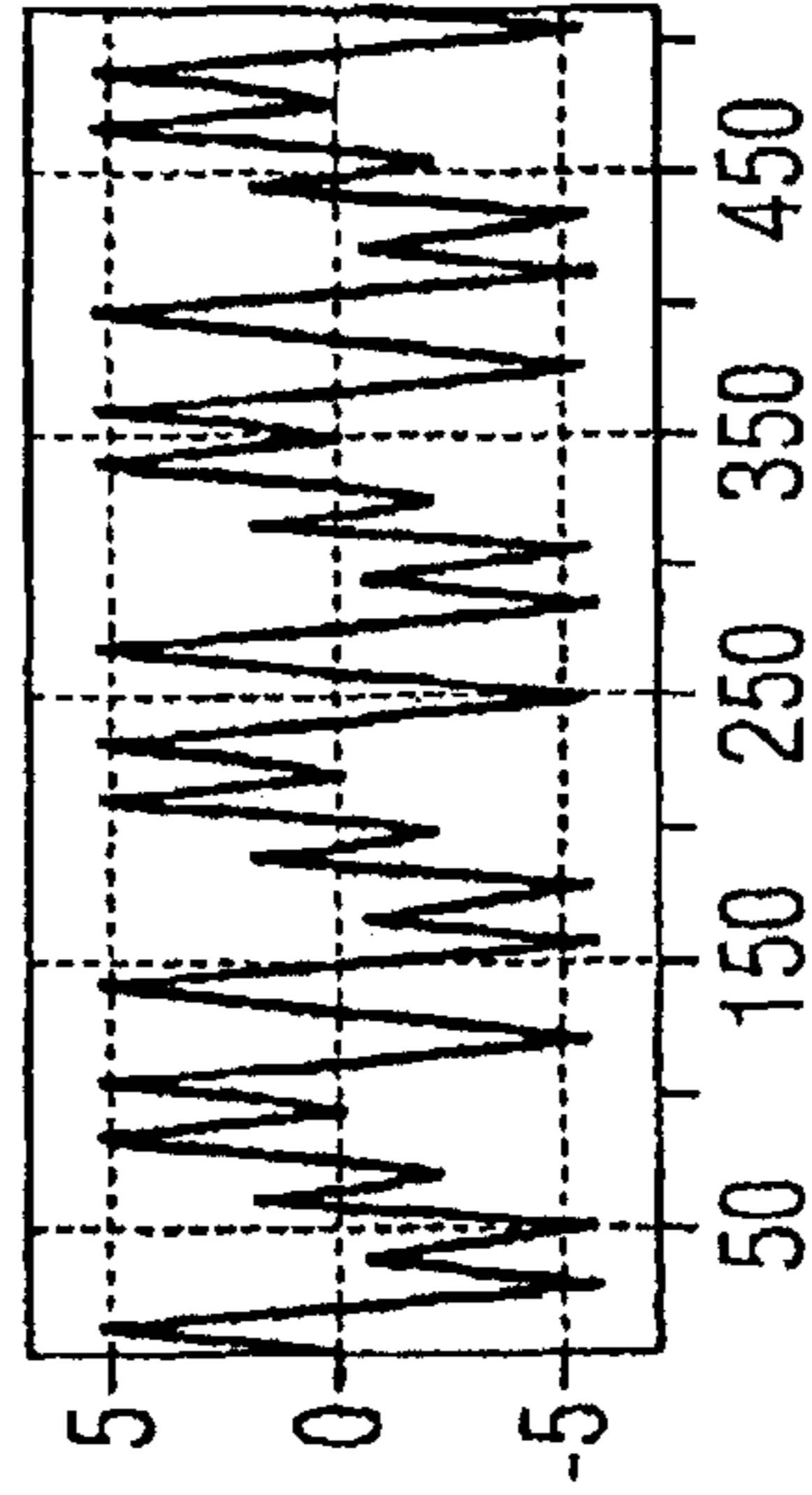
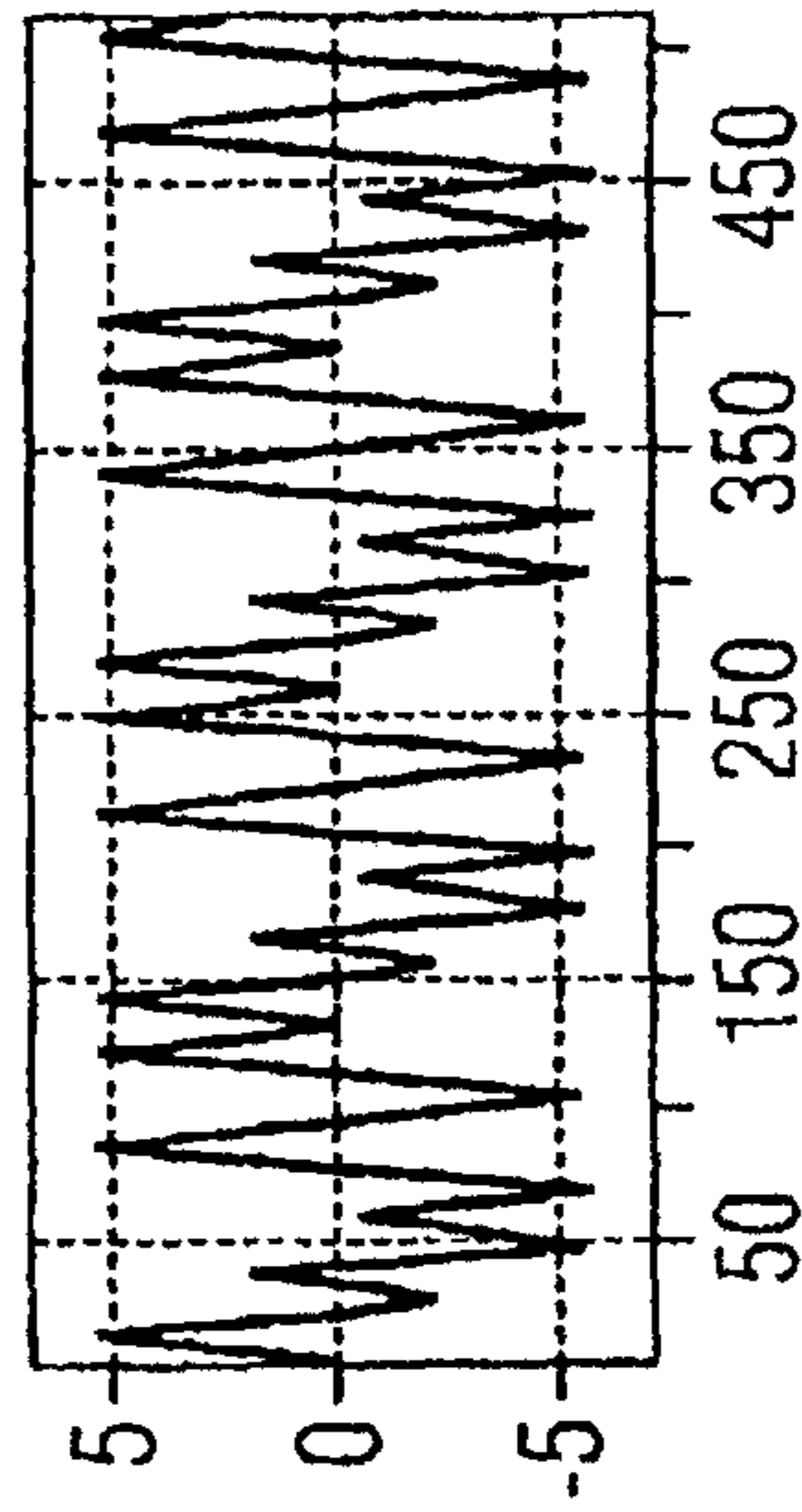

FIG 6

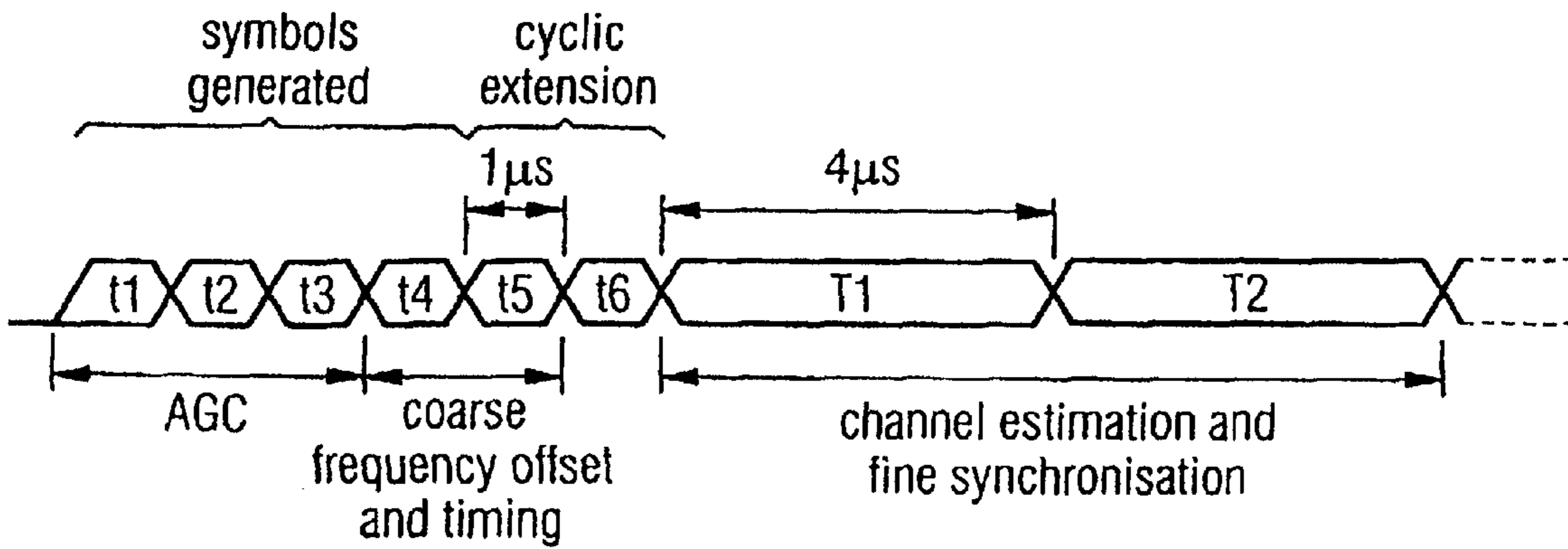

FIG 7

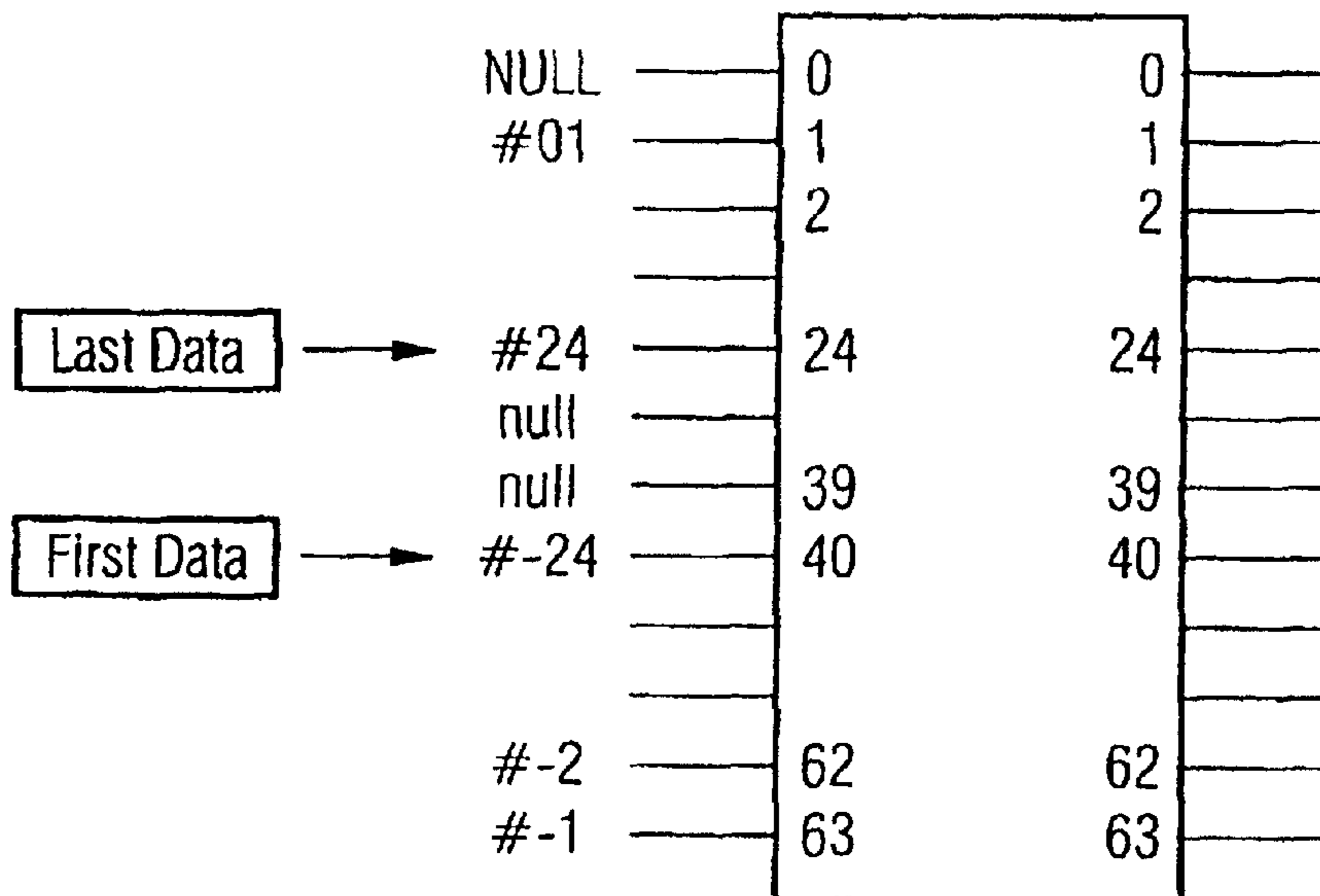

FIG 8a

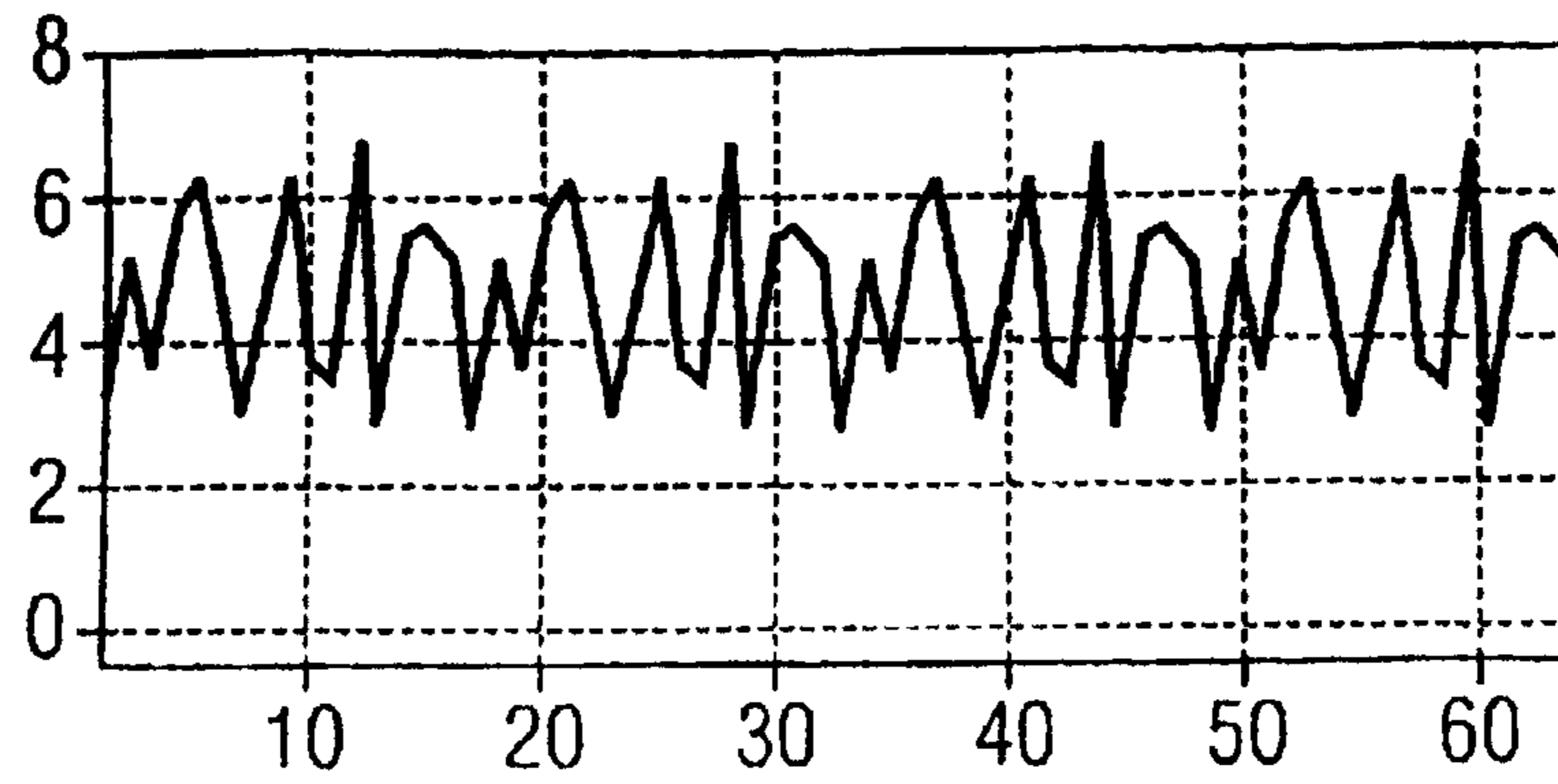

FIG 8b

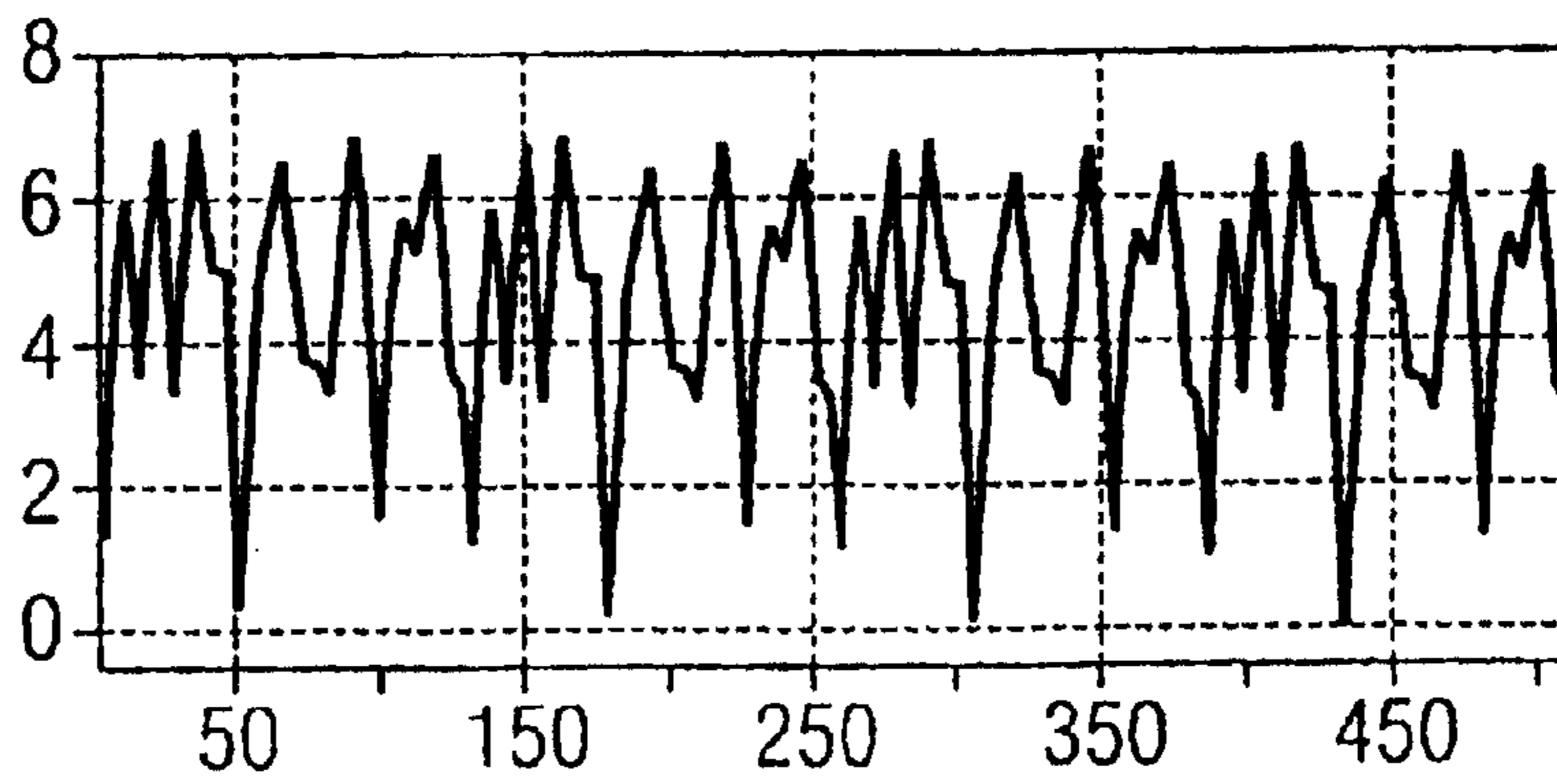

FIG 8c

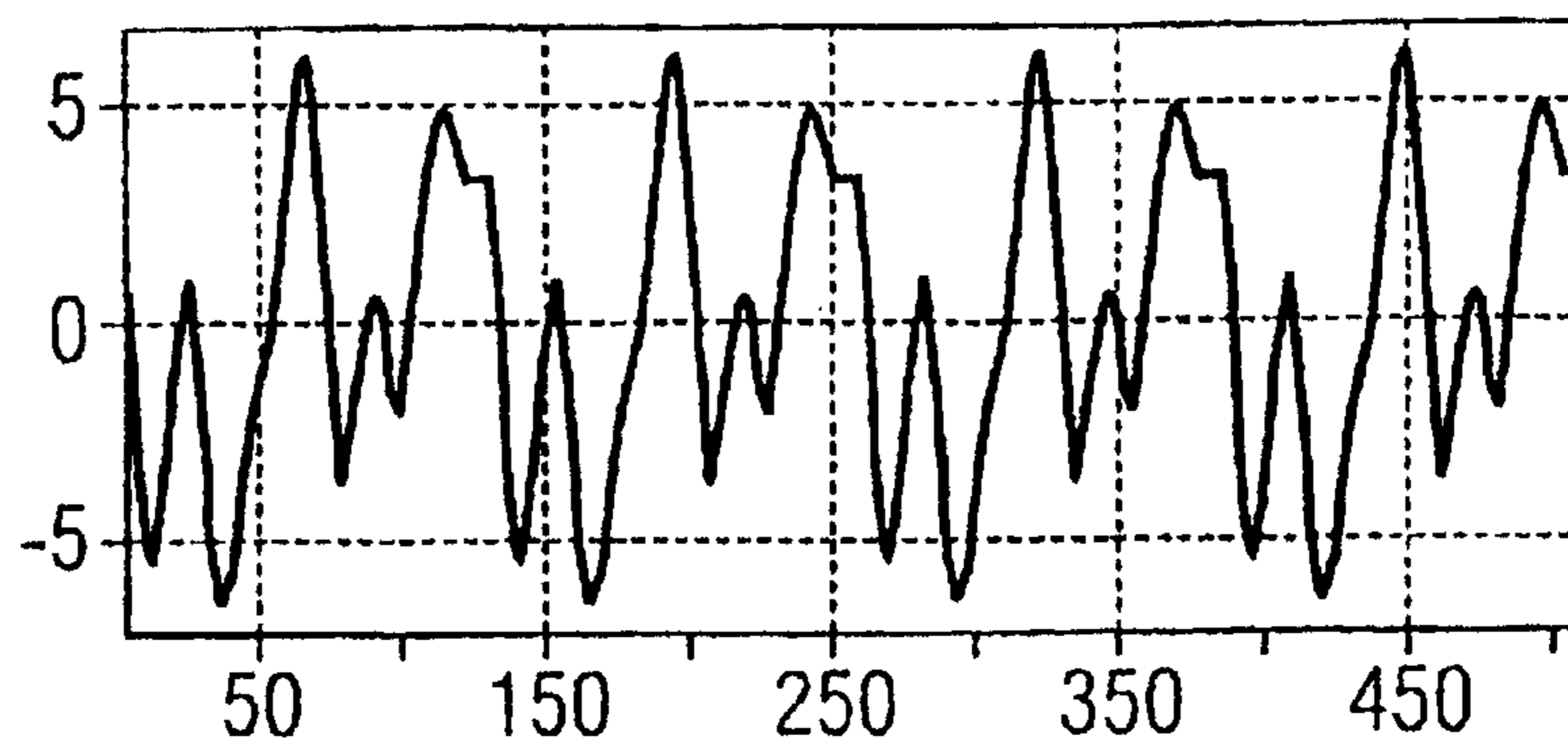

FIG 8d

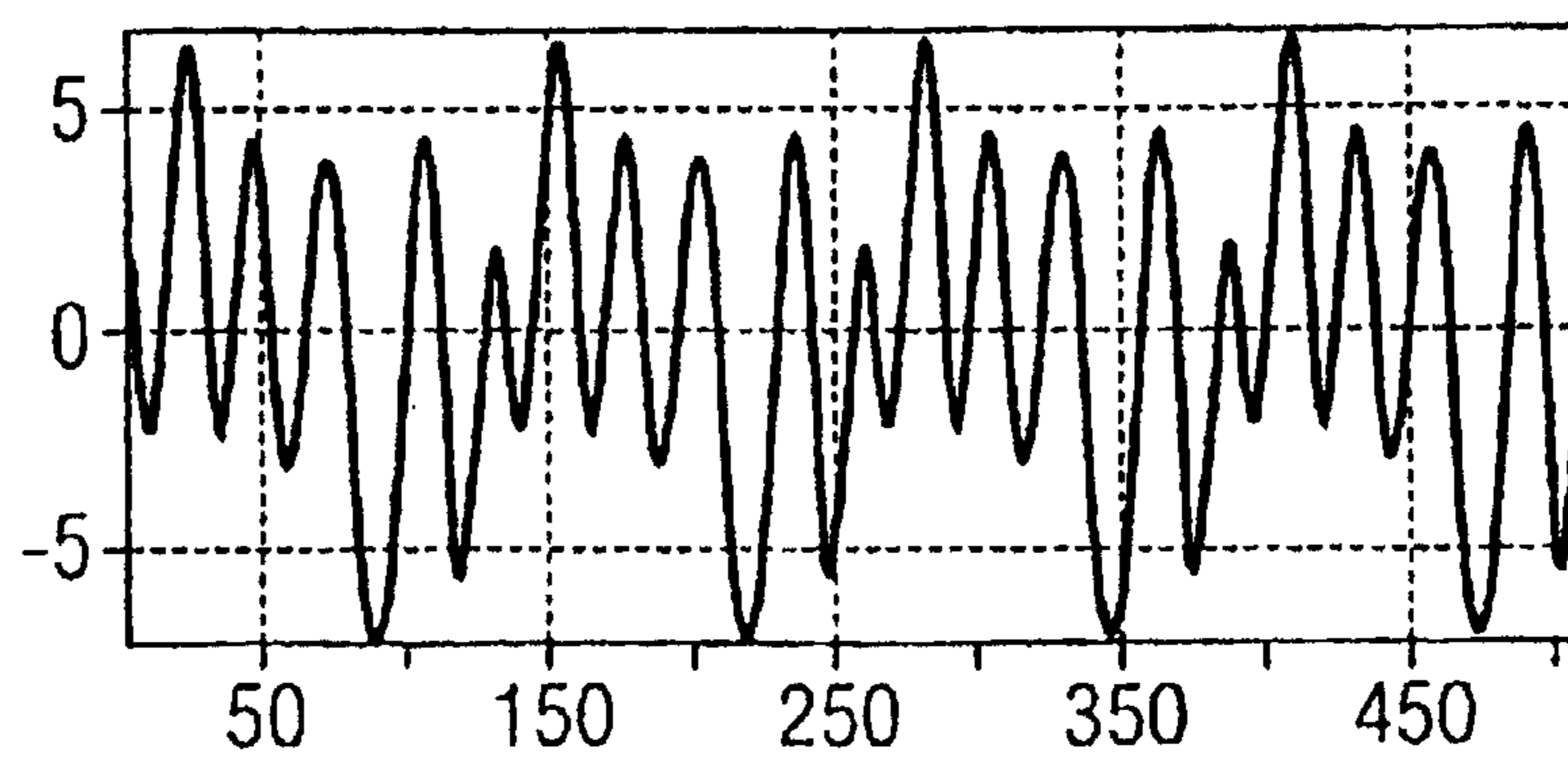

FIG 9a

Time domain signal (magnitude) using the state of the art
(8-times oversampling)

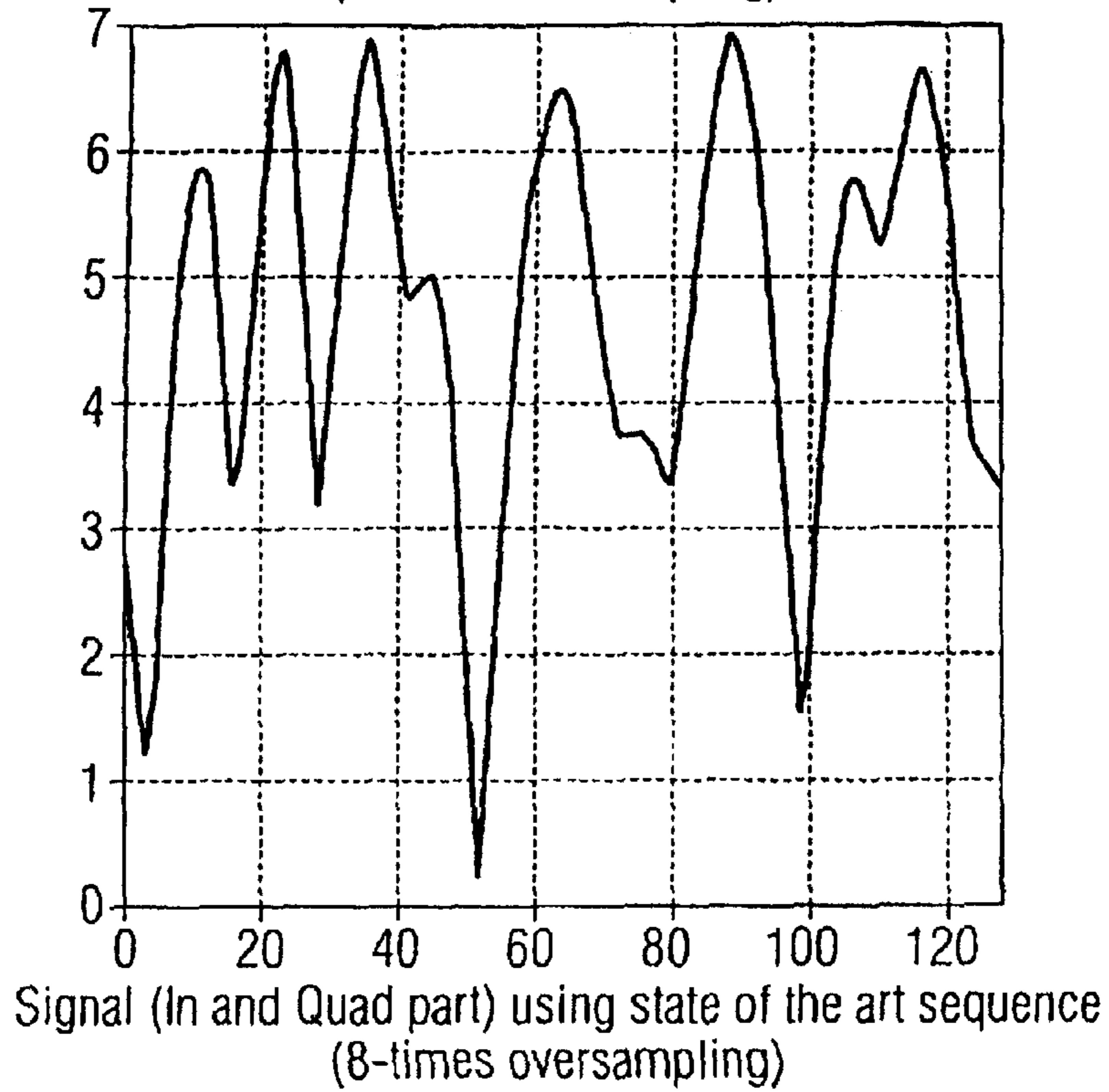
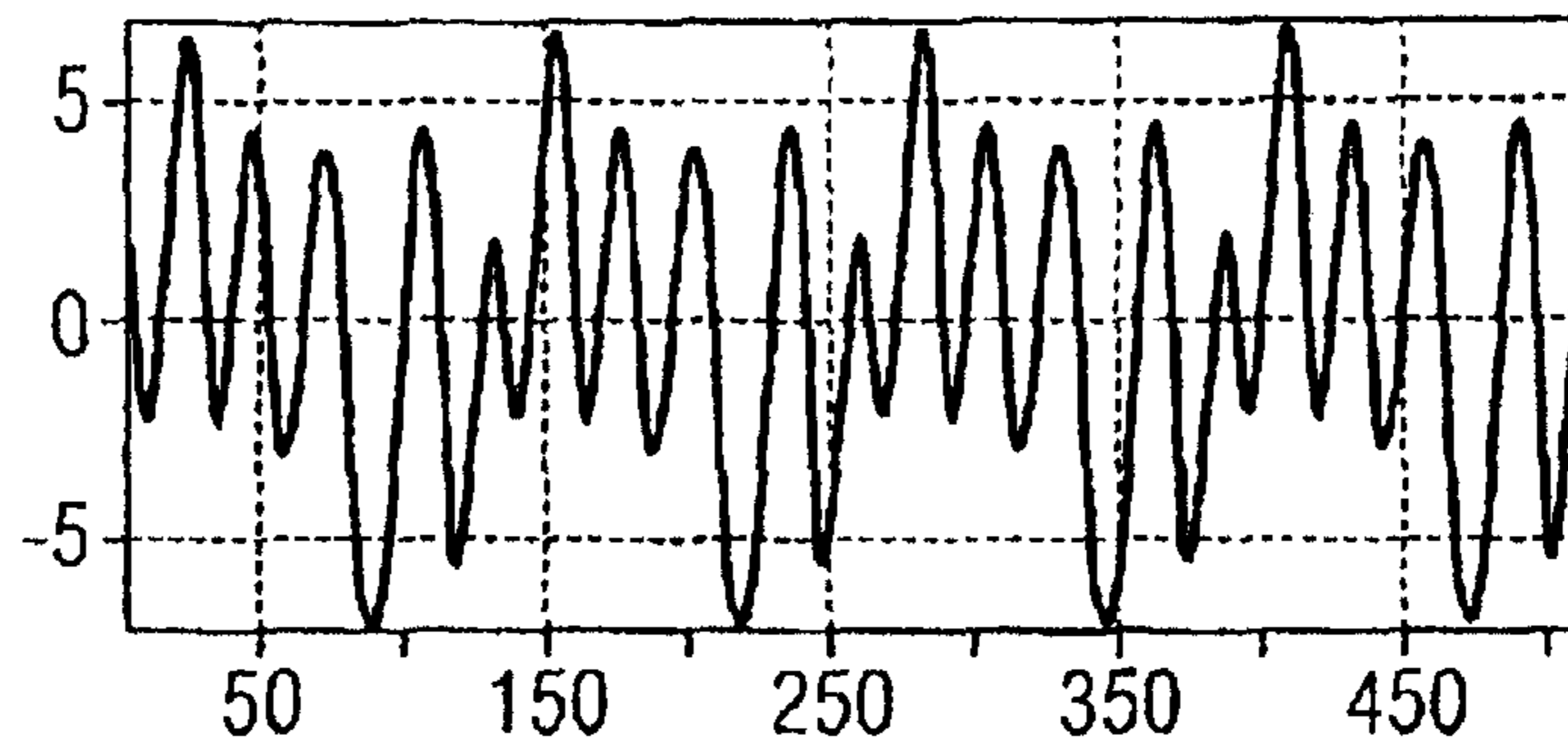
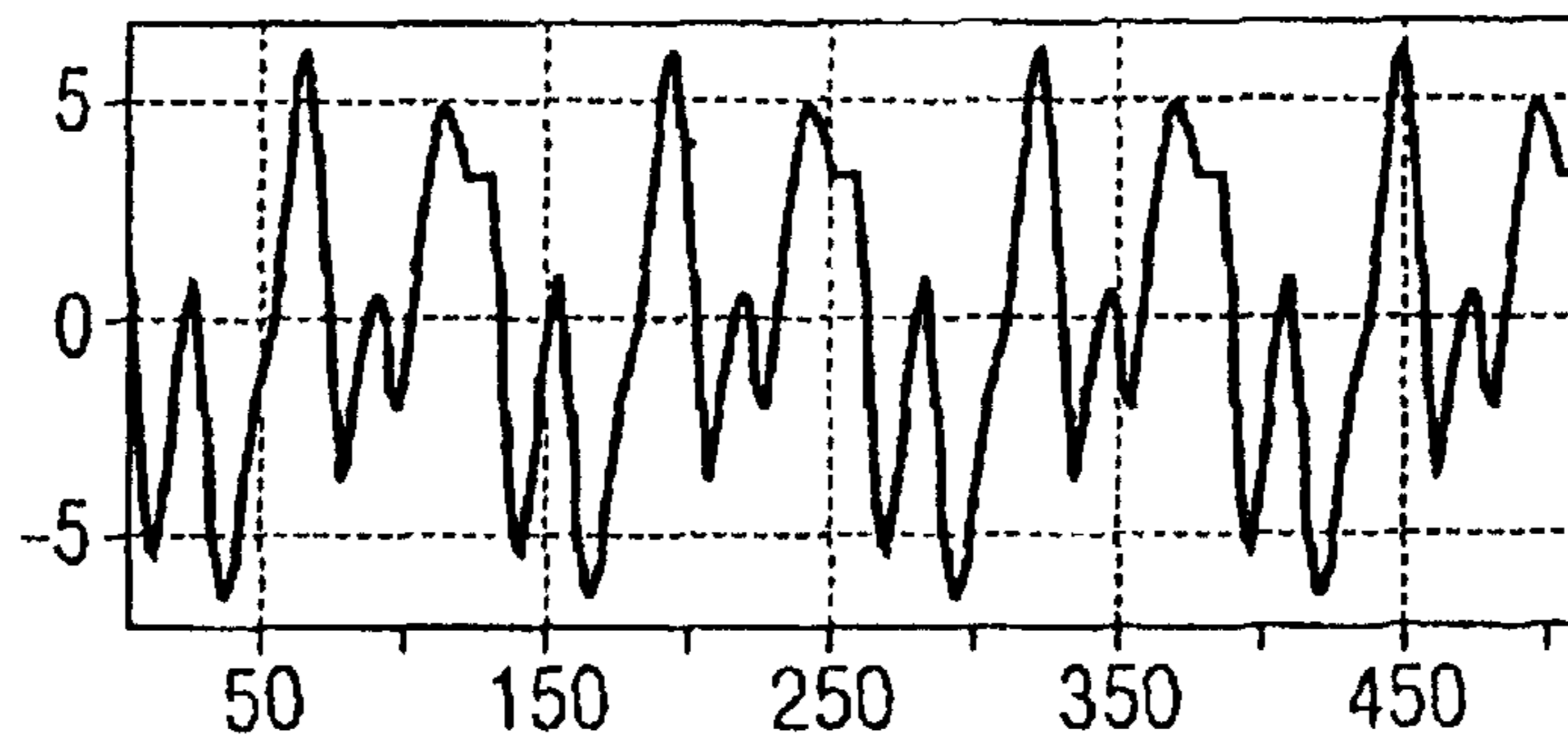

FIG 9b



PAPR: 3.01 dB
Dynamic Range: 30.82 dB

FIG 10a

Time domain signal (magnitude) using 'Seq-Alt1'
(8-times oversampling)

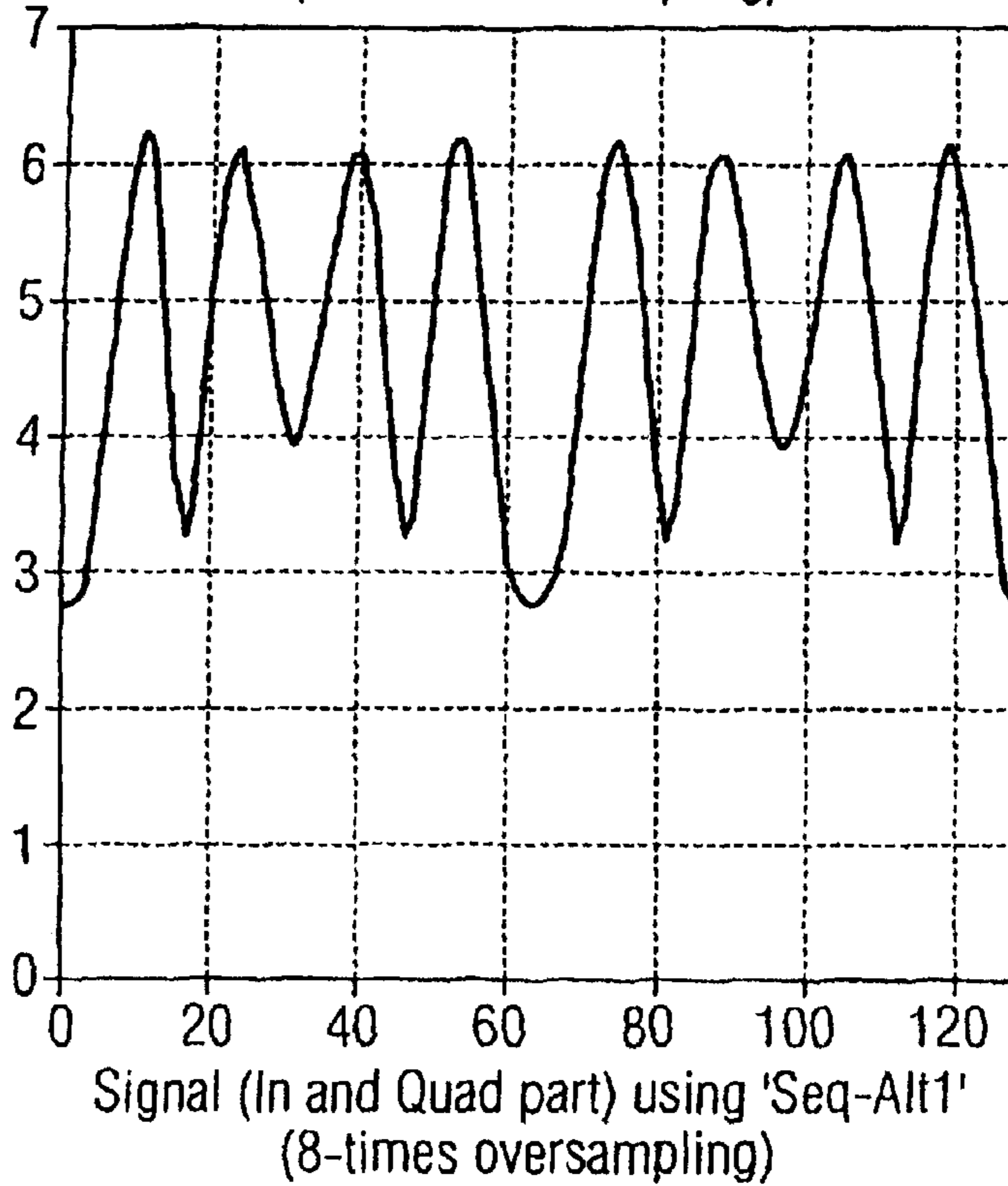
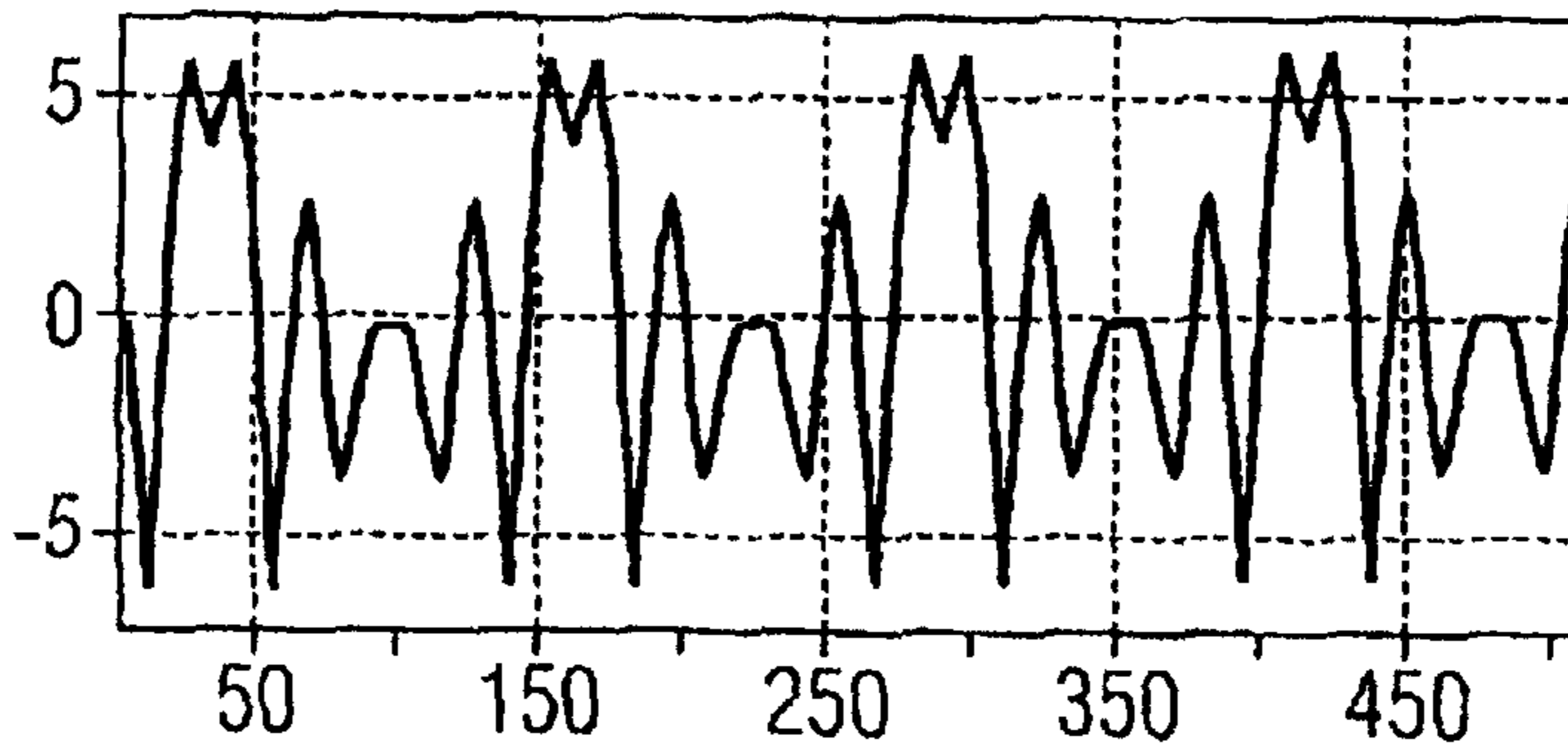
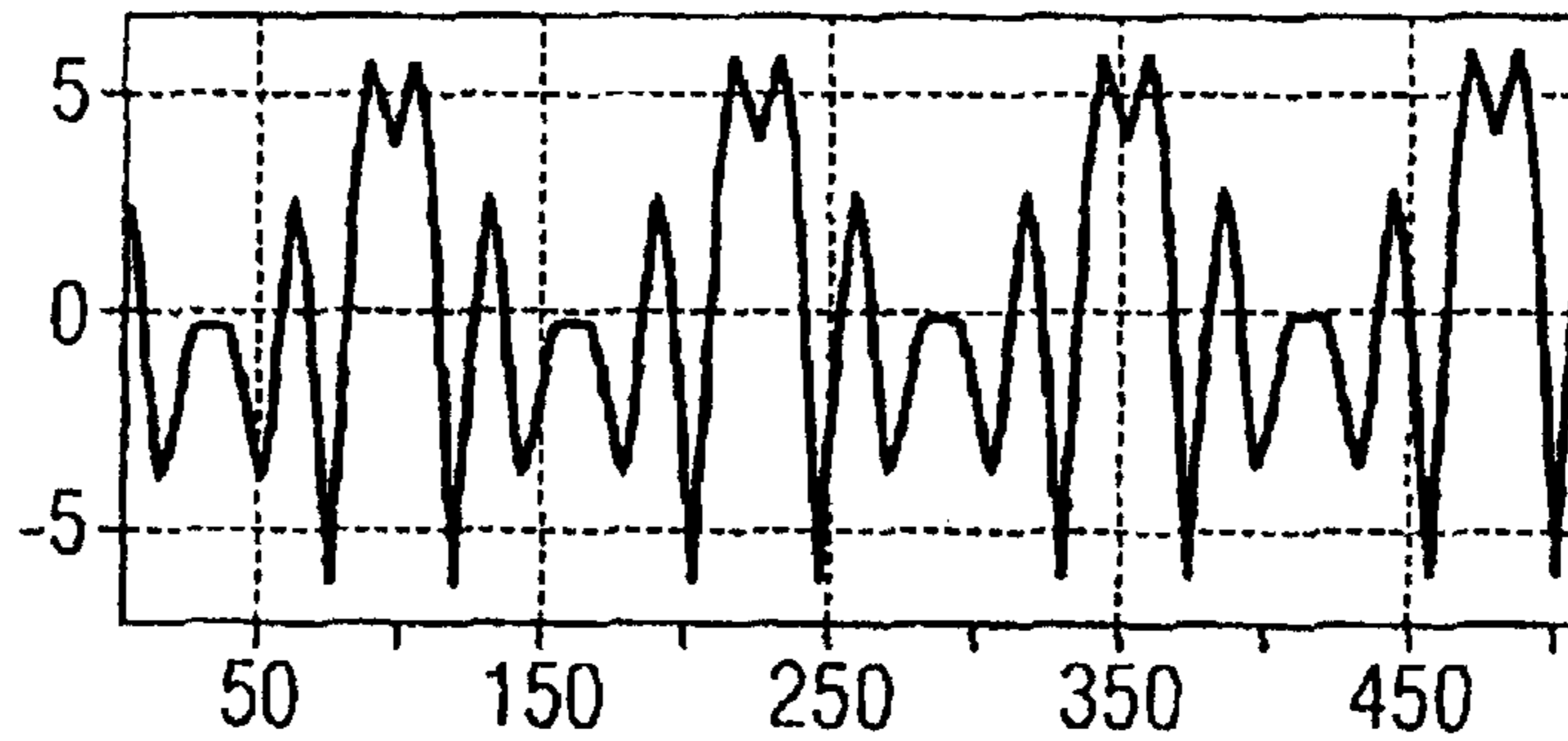

FIG 10b



PAPR: 2.24 dB
Dynamic Range: 7.01 dB

**SYNCHRONIZATION SYMBOL STRUCTURE
USING OFDM BASED TRANSMISSION
METHOD**

Matter enclosed in heavy brackets [] appears in the original patent but forms no part of this reissue specification; matter printed in italics indicates the additions made by reissue.

Notice: More than one application has been filed for the reissue of U.S. Pat. No. 6,654,339. The reissue applications are 11/286,440, the instant application, and applications 12/258,799, 12/258,984, 12/258,939, 12/259,045 and 12/259,063, all filed Oct. 27, 2008.

The present invention relates to a method for generating synchronization bursts for OFDM transmission systems, a method for synchronizing wireless OFDM systems, an OFDM transmitter as well as to a mobile communications device comprising such a transmitter.

The present invention relates generally to the technical field of synchronizing wireless OFDM (orthogonal frequency division multiplexing) systems. Thereby it is known to use a synchronization burst constructed using especially designed OFDM symbols and time domain repetitions.

Particularly from the document IEEE P802.11a/d2.0 "Draft supplement to a standard for telecommunications and information exchange between systems—LAN/MAN specific requirements—part 1: wireless medium access control (MAC) and physical layer (PHY) specifications: high-speed physical layer in the 5 GHz band" a synchronization scheme for OFDM systems is proposed. This document is herewith included by reference as far as it concerns the synchronization including the proposed implementation. Said known scheme will now be explained with reference to FIG. 6 to 8 of the enclosed drawings.

FIG. 6 shows the structure of the known synchronization field. As shown in FIG. 6 the synchronization field consists of so-called short symbols t_1, t_2, \dots, t_6 and two long symbols T_1, T_2 . In view of the present invention particularly the short symbols t_1, t_2, \dots, t_6 are of interest. Among the short symbols t_1, t_2, \dots, t_6 used for the amplifier gain control (t_1, t_2, t_3) and the course frequency offset and timing control only the symbols t_1, t_2, t_3 and t_4 are actually generated, whereas the symbols t_5, t_6 are cyclic extensions (copies of the symbols t_1 and t_2 , respectively). It is to be noted that FIG. 5 shows only the synchronization preamble structure as the structure of the following signal field indicating the type of baseband modulation and the coding rate as well as the structure of further following data fields are not of interest in view of the present invention. For further details reference is made to said prior art document.

The symbols t_1, t_2, t_3, t_4 are generated by means of an OFDM modulation using selected subcarriers from the entire available subcarriers. The symbols used for the OFDM modulation as well as the mapping to the selected subcarriers will now be explained with reference to FIG. 6.

Each of the short OFDM symbols t_1, \dots, t_6 is generated by using 12 modulated subcarriers phase-modulated by the elements of the symbol alphabet:

$$S = \sqrt{2}(\pm 1 \pm j)$$

The full sequence used for the OFDM modulation can be written as follows:

$$S_{-24,24} = \sqrt{2} * \{1+j, 0, 0, 0, 1+j, 0, 0, 0, -1-j, 0, 0, 0, -1-j, 0, 0, 0, 1-j, 0, 0, 0, -1-j, 0, 0, 0, 0, 0, 0, 1+j, 0, 0, 0, 1+j, 0, 0, 0, -1-j, 0, 0, 0, 1+j, 0, 0, 0, -1+j, 0, 0, 0, 1+j\}$$

The multiplication by a factor of $\sqrt{2}$ is in order to normalize the average power of the resulting OFDM symbol.

The signal can be written as:

$$r_{\text{SHORT}}(t) = w_{\text{SHORT}}(t) \sum_{k=-N_2/2}^{N_2/2} S_k \exp(j2\pi k \Delta f t)$$

The fact that only spectral lines of $S_{-24, 24}$ with indices which are a multiple of 4 have nonzero amplitude results in a periodicity of $T_{\text{FFT}}/4 = 0.8 \mu\text{sec}$. The interval T_{SHORT} is equal to nine $0.8 \mu\text{sec}$ periods, i.e. $7.2 \mu\text{sec}$.

Applying a 64-point IFFT to the vector S , where the remaining 15 values are set to zero, four short training symbols t_1, t_2, t_3, t_4 (in the time domain) can be generated. The IFFT output is cyclically extended to result in 6 short symbols $t_1, t_2, t_3, \dots, t_6$. The mapping scheme is depicted in FIG. 7. The so called virtual subcarriers are left unmodulated.

The way to implement the inverse Fourier transform is by an IFFT (Inverse Fast Fourier Transform) algorithm. If, for example, a 64 point IFFT is used, the coefficients 1 to 24 are mapped to same numbered IFFT inputs, while the coefficients -24 to -1 are copied into IFFT inputs **40** to **63**. The rest of the inputs, 25 to 39 and the 0 (DC) input, are set to zero. This mapping is illustrated in FIG. 7. After performing an IFFT the output is cyclically extended to the desired length.

With the proposed inverse fast Fourier transform (IFFT) mapping as shown in FIG. 7 the resulting time domain signal consists of 4 periodically repeated short symbols t_1, t_2, t_3, t_4 , and cyclically extended by a copy of t_1, t_2 , which copy is depicted in FIG. 5 as t_5, t_6 . Note that in the present case only spectral lines with indices which are a multiple of 4 have nonzero amplitude. Other periodic natures can be generated by setting other multiples of the spectral lines to nonzero amplitudes.

Though the known synchronization scheme is very effective, it provides for disadvantage regarding the time domain signal properties.

For OFDM (or in general multicarrier signals) the signal envelope fluctuation (named Peak-to-Average-Power-Ratio=PAPR) is of great concern. A large PAPR results in poor transmission (due to nonlinear distortion effects of the power amplifier) and other signal limiting components in the transmission system (e.g. limited dynamic range of the AD converter).

For synchronization sequences it is even more desirable to have signals with a low PAPR in order to accelerate the receiver AGC (automatic gain control) locking and adjusting the reference signal value for the A/D converter (the whole dynamic range of the incoming signal should be covered by the A/D converter resolution without any overflow/underflow).

FIGS. 8a, 8b show the "absolute" ($\sqrt{\text{In}^* + \text{Quad} * \text{Quad}}$) value of the resulting time domain signal waveform with the sequences proposed by Lucent Technologies. Oversampling (8^*) was considered in order to ensure the peak was captured correctly using the limited 64-point IFFT.

FIGS. 8c, 8d show the real and imaginary part of the resulting transmitted time domain waveform. The resulting PAPR is 2.9991 dB (no oversampling) and 3.0093 dB (with 8 times oversampling).

Therefore it is the object of the present invention to provide for a synchronization technique which bases on the known synchronization technique but which presents improved time domain signal properties to reduce the requirements for the hardware.

The above object is achieved by means of the feature of the independent claims. The dependent claims develop further the central idea of the present invention.

3

According to the present invention therefore a method for generating synchronization bursts for OFDM transmission systems is provided. Symbols of a predefined symbol sequence are mapped according to a predefined mapping scheme on subcarriers of the OFDM system wherein the symbols of the predefined symbol sequence represent subcarriers with nonzero amplitudes. A synchronization burst is generated by inverse fast Fourier transforming the subcarriers mapped with a predefined symbol sequence. According to the present invention the predefined symbol sequence is optimized such that the envelope fluctuation of the time domain signal (Peak-to-average-power-ratio) is minimized.

The predefined symbol sequence can be chosen such that the following equations are satisfied for all symbols of the predefined symbol sequence:

$$n=2m,$$

$$C_{i-1}=\pm C_{1-i},$$

n being the number of symbols of the predefined symbol sequence,

m being an integer larger than one,

C being the symbol value, and

i being an integer running from 1 to m.

The mapping of the symbols of the predefined symbol sequence and the Inverse Fast Fourier Transform can be set such that the resulting time domain signal of the synchronization burst represents a periodic nature.

Alternatively the mapping of the symbols of the predefined symbol sequence and the Inverse Fast Fourier Transform is set such that one burst part of the synchronization burst in the time domain is generated and the periodic nature of the synchronization burst in the time domain is achieved by copying the one burst part.

The number of symbols of a symbol sequence (n) can for example be 12.

The above equations define generally the symbol sequences according to the present invention. The predefined symbol sequence can therefore be for example:

$$AAA -A -A -A -AA -A -AA -A,$$

wherein A is a complex value.

Alternatively the predefined symbol sequence can be:

$$A -AAA -AAAAA -A -A -A,$$

wherein A is a complex value.

Alternatively the following predefined symbol sequence can be used:

$$A B -A B -A -B B A -B A -B -A,$$

wherein A, B are complex values.

As a further alternative the following sequence can be used:

$$A -B -A -B -A B -B A B A B -A,$$

wherein A, B are complex values.

According to the present invention furthermore a method for synchronizing wireless OFDM systems is provided, wherein a synchronization burst is generated according to a method as set forth above and the synchronization burst is transmitted respectively before the transmission of data fields.

Thereby the time domain signals of the synchronization burst can be precomputed and stored in a memory, such that the computation of the time domain signal of the burst is only effected once.

According to the present invention furthermore a OFDM transmitter is provided comprising a mapping unit for mapping the symbols of a predefined symbols sequence accord-

4

ing to a predefined mapping scheme on subcarriers of the OFDM system, wherein the symbols of a predefined symbols sequence represent the subcarriers of the OFDM system with nonzero amplitudes. Furthermore an inverse fast Fourier transforming unit is provided for generating a synchronization burst by inverse fast Fourier transforming the subcarriers of the OFDM mapped with said predefined symbols sequence. The mapping unit thereby is designed such that the resulting time domain signal of the synchronization burst represents a periodic nature. The mapping unit according to the present invention uses a predefined symbol sequence which is such that the envelope fluctuation of the time domain signal of the synchronization burst is minimized.

According to the present invention furthermore a mobile communications device such as set forth above is used.

With reference to the figures of the enclosed drawings referred embodiments of the present invention will now be explained.

FIG. 1 shows schematically a transmitter according to the present invention,

FIG. 2 shows an alternative embodiment for a transmitter according to the present invention,

FIG. 3 shows an alternative mapping scheme according to the present invention,

FIGS. 4a to 4d show the time domain signal properties achieved with the synchronization symbol structure using OFDM based transmission according to the present invention,

FIGS. 5a to 5d show the time domain signal properties of synchronization symbol structures according to alternative embodiments of the present invention,

FIG. 6 shows a synchronization preamble structure known from the prior art,

FIG. 7 shows an IFFT mapping according to the prior art, and

FIGS. 8a to 8d show the time domain properties of the synchronization symbol structure according to the prior art,

FIGS. 9a and 9b show the time domain properties, particularly the dynamic range of the synchronization symbol structure according to the prior art, and

FIGS. 10a and 10b show the time domain properties of the synchronization symbol structure according to further alternative embodiments of the present invention,

According to the present invention the time domain synchronization burst structure as shown in FIG. 6 is maintained. The IFFT mapping as shown in FIG. 7 can be maintained or alternatively the IFFT mapping according to FIG. 3 can be used. The symbol sequences mapped to the subcarriers are optimized to sequences which result in a lower PAPR.

According to the present invention a short OFDM symbol (t1, . . . t6) consists of 12 phase-modulated subcarriers.

	C00	C01	C02	C03	C04	C05	C06	C07	C08	C09	C10	C11
Seq0	A	A	A	-A	-A	-A	-A	A	-A	-A	A	-A
Seq1	A	-A	A	A	-A	A	A	A	A	-A	-A	-A
Seq2	A	B	-A	B	-A	-B	B	A	-B	A	-B	-A
Seq3	A	-B	-A	-B	-A	B	-B	A	B	A	B	-A

with

$$A = \exp(j*2 + \pi*\varphi_A) \text{ and } B =$$

$$A * \exp(j\frac{\pi}{2}) = \exp(j2\pi*\varphi_A + j\frac{\pi}{2}) \text{ and } 0.0 \leq \varphi_A < 1.0.$$

Generally the predefined symbol sequence therefore is chosen such that the envelope fluctuation of the time domain signal of the synchronization burst is minimized.

Therefore generally the predefined symbol sequence is set such that the following equations are satisfied for all symbols for the predefined symbol sequence:

$$n=2m,$$

$$C_{i-1} = \pm C_{n-i}$$

wherein n is a number of symbols of the predefined symbol sequence,

m is an integer larger than 1,

c is the symbol value, and

i is an integer value running from 1 to m.

In the following the time domain signal properties of the new sequences according to the present invention will be shown with reference to FIGS. 4a to 4d and FIGS. 5a to 5d.

For simplicity we use in our demonstration the classical quadriphase symbol alphabet,

$$S = \sqrt{\frac{1}{2}} (\pm 1 \pm j),$$

(this corresponds to $\phi_A=0.125$)

Symbol		
A	$\exp(j\frac{\pi}{4})$	$\sqrt{\frac{1}{2}} (+1 + j)$
-A	$-\exp(j\frac{\pi}{4}) = \exp(j\frac{5\pi}{4})$	$\sqrt{\frac{1}{2}} (-1 - j)$
B	$\exp(j\frac{\pi}{4} + j\frac{\pi}{2}) = \exp(j\frac{3\pi}{4})$	$\sqrt{\frac{1}{2}} (-1 + j)$

10

-continued

Symbol		
-B	$-\exp(j\frac{3\pi}{4}) = \exp(j\frac{7\pi}{4})$	$\sqrt{\frac{1}{2}} (+1 - j)$

Table 1: Complex symbol mapping

FIGS. 5a and 5b thereby show the time domain signal (magnitude) when using the optimized sequence according to the present invention in the case of no oversampling/8-times oversampling is effected.

PAPR (is decibel) is limited to 2.059 (even when using a time domain oversampling to capture the actual peak).

FIGS. 5c and 5d show the in-phase and quadrature-phase component, respectively, of the resulting wave form. It is clearly visible that the full symbol consists of four repetitions of a short sequence.

FIGS. 5a to 5d show graphics corresponding to FIGS. 4a to 4d for the other proposed sequences S1, S2 and S3.

Further simulations have shown that not only the PAPR can be optimized but also the dynamic range of the signal should be minimized. Therefore another four sequences, with achieve a small PAPR and at the same time a small overall dynamic range are proposed further below.

Using the sequence as proposed in the state of the art the PAPR is 3.01 dB and the dynamic range (defined as the ratio of the peak power to the minimum power) is 30.82 dB (see FIGS. 9a and 9b).

Using the sequences according to the present invention and as described above the PAPR is reduced to 2.06 dB, however, the dynamic range is increased as the signal power is '0' at some points.

Therefore the following four sequences are proposed as a further embodiment of the present invention:

The symbol sequence is C0, C1, . . . C11 and the mapping is:

$$S=2*\{C00, 0, 0, 0, C01, 0, 0, 0, C02, 0, 0, 0, C03, 0, 0, 0, C04, 0, 0, 0, C05, 0, 0, 0, 0, 0, 0, C06, 0, 0, 0, C07, 0, 0, 0, C08, 0, 0, 0, C09, 0, 0, 0, C10, 0, 0, 0, C11\}$$

	C00	C01	C02	C03	C04	C05	C06	C07	C08	C09	C10	C11
Seq-Alt0	A	A	A	A	-A	-A	A	-A	-A	A	-A	A
Seq-Alt1	A	-A	A	-A	-A	A	-A	-A	A	A	A	A
Seq-Alt2	A	B	-A	-B	-A	-B	-B	-A	-B	-A	B	A
Seq-Alt3	A	-B	-A	B	-A	B	B	-A	B	-A	-B	A

with $A = \exp(j * 2 * \pi * \phi_A)$ and

$$B = A * \exp(j \frac{\pi}{2}) = \exp(j 2\pi * \phi_A + j \frac{\pi}{2})$$

and $0.0 \leq \Phi_A < 1.0$.

Using these sequences the PAPR is reduced to 2.24 dB and the dynamic range is limited to 7.01 dB as it is shown in FIGS. 10a and 10b.

The advantages are the same as described before, however, the clipping problem is further reduced due to the very limited dynamic range of the signal.

With reference to FIG. 1 and 2 possible implementations of a transmitter according to the present invention will now be explained.

In the transmitter the sync symbol data 1 are prepared and mapped in a IFFT mapping unit 2 to the appropriate IFFT points. The subcarriers of the OFDM system are transformed by a IFFT unit 3 and then the time domain signal is extended in a time extension unit 4 by copying parts of the signals (for example t1, t2 are copied to t5, t6). The time extended signal is then sent to the I/Q modulator 5.

As shown in FIG. 2 alternatively the time domain signal can be precomputed once in a computation unit 7 and then be stored in a memory 6 for the precomputed sample for the time signal. Then the time domain signal of the synchronization burst can be sent to the modulator 5 directly from the memory 6.

With reference to FIG. 3 a modified IFFT mapping scheme will now be explained.

According to this scheme, the principle of setting only every fourth subcarrier of the OFDM system to a non-zero amplitude (see FIG. 7) is abandoned. Therefore the time domain signal achieved according to the mapping scheme of FIG. 3 will not present a periodic nature.

The IFFT size is now only 16 (instead of 64 as it is the case in FIG. 7). Only one of the bursts t1, t2, . . . t6 will be generated. The other bursts can be generated by copying to retain the periodic nature of the synchronization time domain signal necessary for the correlation and synchronization on the receiving side. Therefore for example the time extension unit 4 can perform the copying of the 16-sample burst t1 generated by the IFFT 16 according to FIG. 7 to the other burst t2, t3, . . . t6. Obviously the mapping scheme according to FIG. 3 reduces the computing effort necessary for the IFFT. The periodic nature of the time domain signal of the SYNCH bursts is therefore no longer achieved by the IFFT step, but by copying the burst t1 generated with the simplified IFFT mapping scheme.

The mapping scheme shown in FIG. 3 is also advantageous in combination with the precomputing technique shown in FIG. 2.

According to the present invention therefore a synchronization burst structure to be used in high speed wireless transmission systems is proposed. The synchronization burst is constructed using especially designed OFDM symbols and time domain repetitions. The resulting synchronization burst

10

achieves a high timing detection and frequency offset estimation accuracy. Furthermore the burst is optimized to achieve a very low envelope fluctuation (Low peak-to-average-power-ratio) to reduce the complexity on the receiver and to reduce time and frequency acquisition time at the receiver.

15

Therefore the synchronization performance can further be improved. As with the scheme according to the present invention the envelope of the OFDM based synchronization burst in the time domain is reduced, the AGC pool-in speed at the receiver can be improved and an accurate time and frequency synchronization can be achieved. Furthermore the synchronization complexity on the receiver side can be reduced due to the reduced resolution requirements necessary due to reduced envelope fluctuation.

20

The advantages of the present invention can be set forth as following:

25

- An OFDM based SYNCH symbol with a reduced Peak-to-Average-Power-Ratio (PARP) is proposed,
- Improved synchronization performance (compared to the state of the art proposal),
- Reduced AGC (automatic gain control) pull-in time due to reduced dynamic range of the SYNCH burst,
- Improved AGC settlement (AGC has to adjust to an incoming signal level that later on now overflow/underflow in the AD happens. The reduced dynamic range of the SYNCH burst help to find this reference level more accurate),
- Reduced synchronization detection complexity on the receiver (reduced resolution necessary due to reduced envelope fluctuation).

30

What is claimed is:

35

[1. A method for generating synchronization bursts for OFDM transmission systems, comprising the following steps:

40

mapping the symbols of a predefined symbol sequence according to a predefined mapping scheme on subcarriers S of the OFDM system, wherein the symbols of the predefined symbol sequence represent subcarriers of the OFDM system with non-zero-amplitude, and

45

generating a synchronization burst by Inverse Fourier Transforming the subcarriers S of the OFDM system mapped with the symbols of said predefined symbol sequence,

50

characterized in that

the predefined symbol sequence is set such that the envelope fluctuation of the time domain signal of the synchronization burst is minimized and the symbols of the predefined symbols sequence can be expressed as

A -AA -A -AA -A -AAAAA

55

A being a complex value.]

60

[2. A method for synchronizing wireless OFDM systems, characterized by the steps of

generating a synchronization burst according to a method according to claim 1, and

transmitting the synchronization burst.]

[3. A method according to claim 2, characterized in that the time domain signal of the synchronization burst is precomputed and stored in a memory.]

[4. An OFDM transmitter, comprising:

a unit for mapping the symbols of a predefined symbol sequence according to a predefined mapping scheme on subcarriers of the OFDM system, wherein the symbols of the predefined symbol sequence represent subcarriers of the OFDM system with non-zero-amplitude, and

a unit for generating a synchronization burst by Inverse Fourier Transforming the subcarriers of the OFDM system mapped with the symbols of said predefined symbol sequence,

characterized in that

the mapping unit is designed to modulate the subcarriers such that the envelope fluctuation of the time domain signal of the synchronization burst is minimized by using the following predefined symbol sequence:

A -AA -A -AA -A -AAAAA

A being a complex value.]

[5. An OFDM transmitter according to claim 4, characterized by

a time extension unit copying the burst part to achieve a periodic nature of the time domain signal.]

[6. An OFDM transmitter according to claim 4, characterized by

a processing unit for precomputing the time domain signal of the synchronization burst

and a memory for storing the precomputed time domain signal of the synchronization burst.]

[7. A mobile communications device, comprising a transmitter according to claim 4.]

[8. A synchronization burst signal for synchronizing OFDM systems generated by a method according to claim 1.]

9. A method for synchronizing an OFDM receiver comprising the steps of:

generating a synchronization signal by:

mapping the symbols of a predefined symbol sequence according to a predefined mapping schemes on subcarriers of the OFDM system, wherein the symbols C_0, \dots, C_{11} of the predefined symbols sequence represent subcarriers of the OFDM system with non-zero amplitude,

generating a synchronization signal by Inverse Fourier Transformation of the subcarriers of the OFDM system mapped with the symbols of said predefined symbol sequence, wherein the symbols C_0, \dots, C_{11} comprise twelve symbols wherein C_n has the value

$$\sqrt{\left(\frac{1}{2}\right)^{(\pm 1 \pm j)}},$$

where n is an integer,

transmitting the synchronization signal, and

receiving said synchronization signal and synchronizing a receiver.

10. The method of claim 9, wherein automatic gain control in the receiver is locked in using the received synchronization signal.

11. The method of claim 9, wherein a reference value of an A/D converter in the receiver is adjusted using the received synchronization signal.

12. A method for synchronizing a receiver in an OFDM communication system, comprising the steps of:

receiving data signals and a synchronization signal exhibiting periodicity, the data signals and synchronization signal being transmitted from a transmitter using a plurality of subcarriers, said synchronization signal being based on a predefined symbol sequence having twelve symbols C_0, \dots, C_{11} wherein C_n has the value

$$\sqrt{\left(\frac{1}{2}\right)^{(\pm 1 \pm j)}},$$

where n is an integer, and wherein said twelve symbols are periodically mapped on every fourth subcarrier of said plurality of subcarriers so that said periodicity of the synchronization signal contains a predefined number of repetitions of one synchronization signal in the time domain, and

performing time and frequency synchronization in accordance with said periodicity of synchronization signal.

13. A method for synchronizing a receiver in an OFDM communication system, comprising the steps of:

receiving data and synchronization signals transmitted from a transmitter using a plurality of subcarriers, and performing time and frequency synchronization in accordance with said synchronization signal,

wherein said synchronization signal is generated based on a predefined symbol sequence comprising twelve symbols C_0, \dots, C_{11} wherein C_n has the value

$$\sqrt{\left(\frac{1}{2}\right)^{(\pm 1 \pm j)}},$$

where n is an integer.

14. A method for synchronizing a receiver in an OFDM communication system, comprising the steps of:

receiving data and synchronization signals transmitted from a transmitter using a plurality of subcarriers, and performing time and frequency synchronization in accordance with said synchronization signal,

wherein said synchronization signal is generated based on a predefined symbol sequence comprising twelve non-zero symbols C_0, \dots, C_{11} wherein C_n has the value

$$\sqrt{\left(\frac{1}{2}\right)^{(\pm 1 \pm j)}},$$

where n is an integer, and other symbols set to zero, so that said twelve symbols are arranged with periodicity in said predefined symbol sequence in the frequency domain.

15. A method for synchronizing a receiver in an OFDM communication system, comprising the steps of:

receiving data and synchronization signals transmitted from a transmitter using a plurality of subcarriers, and performing time and frequency synchronization in accordance with said synchronization signal,

wherein said synchronization signal is generated based on a predefined symbol sequence comprised of twelve symbols C_0, \dots, C_{11} wherein C_n has the value

11

$$\sqrt{\left(\frac{1}{2}\right)^{(\pm 1 \pm j)}},$$

where n is an integer,

wherein the twelve symbols are arranged such that every fourth subcarrier among said plurality of subcarriers has non-zero amplitude.

16. An OFDM communication system comprising a transmitter and a receiver, the transmitter being of the type that transmits a synchronization signal generated according to the steps of:

mapping, in the frequency domain, symbols of a predefined symbol sequence, in accordance with a predefined mapping scheme, on a plurality of subcarriers of the OFDM system, wherein the symbols C_0, \dots, C_{11} of the symbol sequence define subcarriers with non-zero amplitude, and

generating a time domain synchronization signal by Inverse Fourier Transforming the subcarriers of the OFDM system mapped with the symbols of the symbol sequence,

wherein the symbols of the symbol sequence comprise twelve symbols C_0, \dots, C_{11} wherein C_n has the value

$$\sqrt{\left(\frac{1}{2}\right)^{(\pm 1 \pm j)}},$$

where n is an integer; and

the receiver being of the type that receives said synchronization signal to perform time and frequency synchronization in accordance with said synchronization signal.

12

17. An OFDM communication system comprising a transmitter and a receiver, the transmitter being of the type that transmits a synchronization signal generated according to the steps of;

generating a predefined symbol sequence having twelve symbols C_0, \dots, C_{11} corresponding to respective pre-selected ones of plurality of subcarriers of the OFDM system, and

generating said synchronization signal in the time domain by performing Inverse Fourier Transformation on said pre-selected ones of said plurality of subcarriers,

wherein said twelve symbols are set to non-zero having complex values and others of said symbols are set to zero, such that said twelve symbols are arranged periodically in said predefined symbol sequence in the frequency domain and

wherein C_n of said twelve symbols has the value

$$\sqrt{\left(\frac{1}{2}\right)^{(\pm 1 \pm j)}},$$

where n is an integer; and

the receiver being of the type that receives said synchronization signal and performs time and frequency synchronization in accordance with said synchronization signal.

* * * * *