

US00RE40520E

(19) **United States**
(12) **Reissued Patent**
Doktor

(10) **Patent Number:** **US RE40,520 E**
(45) **Date of Reissued Patent:** **Sep. 23, 2008**

(54) **EASILY EXPANDABLE DATA PROCESSING SYSTEM AND METHOD**

FOREIGN PATENT DOCUMENTS

(75) Inventor: **Karol Doktor**, Wheelers Hill (AU)

WO WO 00/07354 2/2000
WO WO 01/15811 8/2001

(73) Assignee: **Financial Systems Technology (Intellectual Property) Pty Ltd**, Malvern, Victoria (AU)

OTHER PUBLICATIONS

(21) Appl. No.: **11/152,835**

Rudolf Munz, "Design of The Well System", 1980, North-Holland Publishing Company, pp. 505-522.*

(22) Filed: **Jun. 14, 2005**

Tsichritzis, D. "LSL: A Link and Selector Language", Proceedings of the ACM-SIGMOD International Conference on Management of Data, Jun. 2-4, 1976, pp. 123-133.*

Munz, R. "The Well System: A Multi-User Database System Based on Binary Relationships and Graph-Pattern-Matching", Information Systems, vol. 3, 1978, pp. 99-115.*

Related U.S. Patent Documents

Reissue of:

(64) Patent No.: **5,826,259**
Issued: **Oct. 20, 1998**
Appl. No.: **08/862,176**
Filed: **May 22, 1997**

(Continued)

Primary Examiner—Luke S Wassum

(74) *Attorney, Agent, or Firm*—Allen, Dyer, Doppelt, Milbrath & Gilchrist, P.A.

U.S. Applications:

(63) Continuation of application No. 08/439,207, filed on May 11, 1995, now Pat. No. 5,675,779, which is a division of application No. 08/083,861, filed on Jun. 28, 1993, now Pat. No. 5,604,899, which is a continuation of application No. 07/526,424, filed on May 21, 1990, now abandoned.

(57) **ABSTRACT**

(51) **Int. Cl.**
G06F 17/30 (2006.01)

Machine automated techniques are described for a method of data processing called Relationships Processing. A computing system is disclosed which provides for the high speed recording and extraction of data objects (entities) and for the development data representing a queried relationship between the entities. The system is expandable to handle the relatively voluminous data bases of large, commercial data repositories. A user defines set of entities and allowed relationships between the entities. The user can expand this set of allowed entities and relationships at any time during the life of the system without reprogramming or compiling of computer program code or disrupting concurrent operational use of the system. Large systems can now be built that are no longer limited to a scope of design requirements known during initial systems development. For a given set of defined relationships the system allows the user to perform complex inquiries (again without programming at the code level) that would normally require multiple nested inquiries to be coded programmatically and would not achieve the performance levels of the Relationships Processor.

(52) **U.S. Cl.** **707/4; 707/2**

(58) **Field of Classification Search** **707/2, 707/3, 101, 103 Y**

See application file for complete search history.

(56) **References Cited**

U.S. PATENT DOCUMENTS

3,618,027 A 11/1971 Feng 364/900
3,670,310 A 6/1972 Bharwani et al. 395/603
4,068,300 A 1/1978 Bachman 364/200
4,128,891 A 12/1978 Lin et al. 364/900

(Continued)

18 Claims, 19 Drawing Sheets

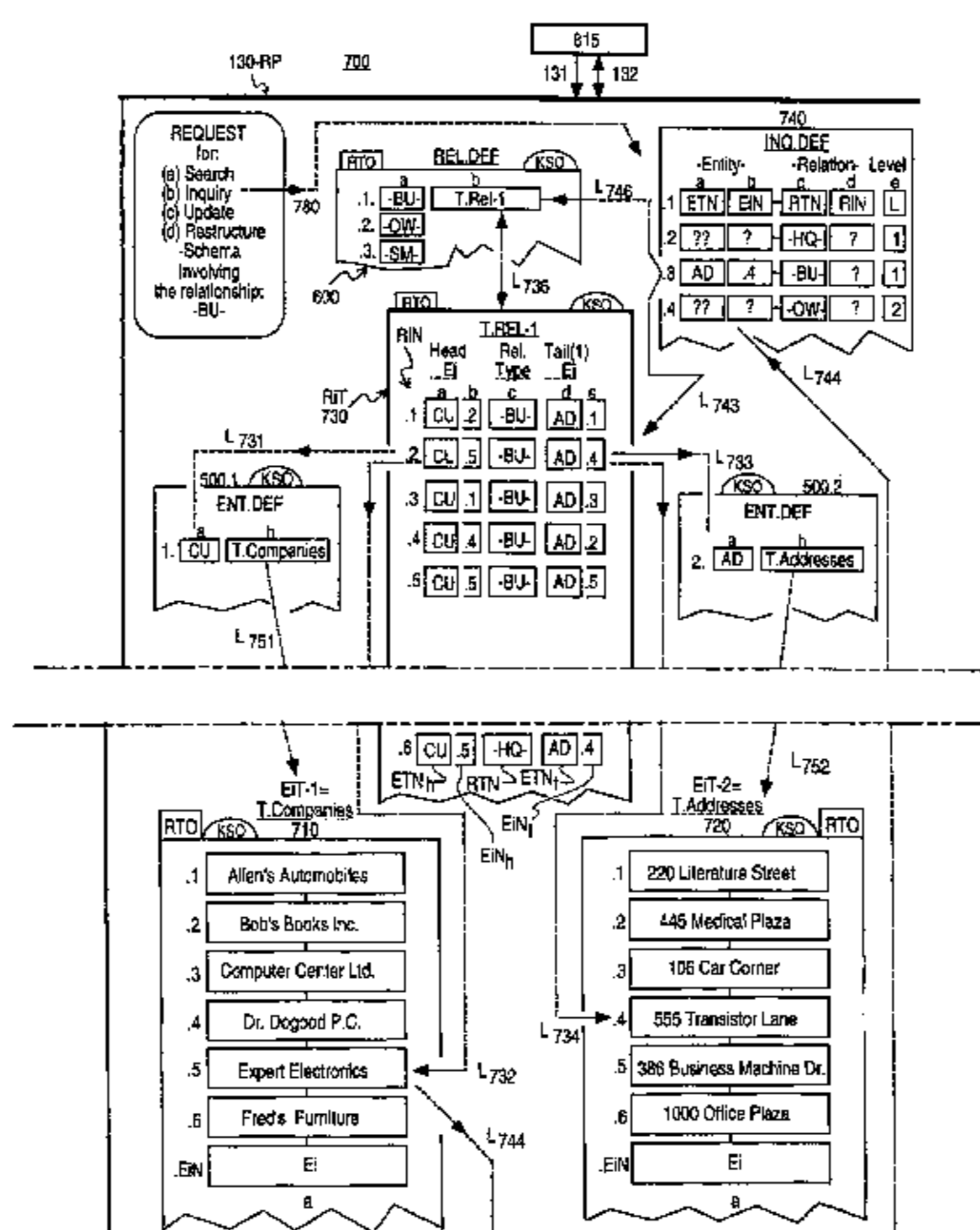

U.S. PATENT DOCUMENTS

4,497,039	A	1/1985	Kitakami et al.	364/900
4,498,145	A	2/1985	Baker et al.	364/900
4,506,326	A	3/1985	Shaw et al.	707/4
4,575,798	A	3/1986	Lindstrom et al.	364/300
4,631,664	A	12/1986	Bachman	364/200
4,670,848	A	6/1987	Schramm	364/513
4,774,661	A	9/1988	Kumpati	707/3
4,791,561	A	12/1988	Huber	364/300
4,807,122	A	2/1989	Baba	364/200
4,829,427	A	5/1989	Green	364/300
4,855,908	A	8/1989	Shimoda et al.	364/405
4,893,232	A	1/1990	Saimaoka et al.	364/200
4,901,229	A	2/1990	Tashiro et al.	364/200
4,918,593	A	4/1990	Huber	364/200
4,930,071	A	5/1990	Tou et al.	364/300
4,930,072	A	5/1990	Agrawal et al.	364/300
4,933,848	A	* 6/1990	Haderle et al.	364/300
4,947,320	A	* 8/1990	Crus et al.	364/200
4,967,341	A	10/1990	Yamamoto et al.	364/200
5,133,068	A	7/1992	Crus et al.	365/600
5,168,565	A	12/1992	Morita	365/600
5,193,183	A	3/1993	Bachman	395/600
5,197,005	A	3/1993	Shwartz et al.	364/419
5,226,158	A	* 7/1993	Horn et al.	395/600
5,239,663	A	8/1993	Faudemay	365/800
5,247,575	A	9/1993	Sprague et al.	380/9
5,262,942	A	11/1993	Earle	364/408
5,297,279	A	3/1994	Bannon et al.	395/600
5,369,761	A	* 11/1994	Conley et al.	707/2
5,379,419	A	* 1/1995	Heffernan et al.	395/600
5,386,557	A	* 1/1995	Boykin et al.	395/600
5,386,559	A	* 1/1995	Eisenberg et al.	395/600
5,408,657	A	* 4/1995	Bigelow et al.	395/600
5,459,860	A	* 10/1995	Burnett et al.	707/101
5,488,722	A	* 1/1996	Potok	395/600
5,504,885	A	* 4/1996	Alashqur	395/600
5,539,870	A	* 7/1996	Conrad et al.	345/352
5,542,073	A	* 7/1996	Schiefer et al.	395/600
5,548,749	A	* 8/1996	Kroenke et al.	395/600
5,581,785	A	* 12/1996	Nakamura et al.	707/103
5,664,177	A	* 9/1997	Lowry	707/100
5,826,259	A	10/1998	Doktor	707/4
5,893,108	A	4/1999	Srinivasan et al.	707/103
6,105,035	A	8/2000	Monge et al.	707/103

OTHER PUBLICATIONS

Munz, R. "Design of the Well System", in Entity-Relationship Approach to Systems Analysis and Design, Proceedings of the 1st International Conference on the Entity-Relationship Approach, Chen, P. ed., 1979, pp. 502-522.*

Malhotra, A. et al. "Implementing an Entity-Relationship Language on a Relational Data Base", IBM Research Report 12134 (#54499), Aug. 27, 1986.*

Rybinski, H. "On First-Order-Logic Databases", ACM Transactions on Database Systems (TODS), vol. 12, No. 3, Sep. 1987, pp. 325-349.*

University of Texas "Data Modeling: the Entity-Relationship Model", downloaded from www.utexas.edu/its/archive/windows/database/datamodeling/dm/erintro.html, Feb. 29, 2004.*

University of Texas "Data Modeling: Primary and Foreign Keys", downloaded from www.utexas.edu/its/archive/windows/database/datamodeling/dm/keys.html, Feb. 29, 2004.*

Curran, T. "EE221—Database Systems & Software Analysis and Design", course notes, Dublin City University, School of Electronic Engineering, downloaded from www.eeng.dcu.ie/~ee221-DB-2.pdf, 2007.*

Microsoft Corporation, "Relational Database Components", tutorial, downloaded from [msdn.microsoft.com/en-us/library/aa174501\(SQL.80\).aspx](http://msdn.microsoft.com/en-us/library/aa174501(SQL.80).aspx), 2007.*

Korth and Silberschatz, Database System Concepts, McGraw-Hill Book Company (New York, 1986), pp. 45-105; pp. 301-323.

"Extended Disjunctive Normal Form for Efficient Processing of Recursive Logic Queries", IBM Technical Disclosure Bulletin, vol. 30 No. 1, Jun. 1987 pp. 360-366.

Yu et al, "Automatic Knowledge Acquisition and Maintenance For Semantic Query Optimization", IEEE Transactions on Knowledge and Data Engrn, V:1, No. 3 Sep. 1989, pp. 362-375.

Kifer et al, "Sygraf: Implementing Logic Programs in a Database Style" IEEE Transactions on Software Engrn. v:14, N7, Jul. 1988 pp. 92-935.

El-Sharkawi et al, "The Architecture and Implementation of Enli: An Example-Based Natural Language Assisted Interface", Parbase 90 Intl. Conf. on Databases, Parallel Architectures & Their Applications, Mar. 7-9, 1990.

Wilschut et al, "Pipelining in Query Execution" Parbase-90 Intl. Conf. on Databases, Parallel Architectures and Their Applications, Mar. 7-9, 1990 p. 562.

Banerjee et al., "Data Model Issues for Object-Oriented Applications", ACM Transactions on Office Information Systems, vol. 5, No. 1, Jan. 1987, pp. 3-26.

Blakely et al., "Experiences Building the Open OODB Query Optimizer", 1993, pp. 287-296.

Markowitz et al., "Representing Extended Entity-Relationship Structures in Relational Databases: A Modular Approach", ACM Transactions on Office Information Systems, vol. 17, No. 3, Sep. 1992, pp. 423-464.

Teorey et al., "A Logical Design Methodology for Relational Databases Using the Extended Entity-Relationship Model", Computing Surveys, vol. 18, No. 2, Jun. 1986, pp. 197-222.

Chen, Peter, "Entity-Relationship Approach to Systems Analysis and Design", Proceedings of the International Conference in Los Angeles, Dec. 10-12, 1979, pp. 237-257.

Blakeley et al., "Experiences Building the Open OODB Query Optimizer", 1993, pp. 287-296.

Zand et al., "A Survey of Current Object-Oriented Databases", Data Base Advances, Feb. 1995, vol. 26, No. 1, pp. 14-29.

Straube et al., "Queries and Query Processing in Object-Oriented Database Systems", ACM Transactions on Information Systems, vol. 8, No. 4, Oct. 1990, pp. 387-430.

Kim et al., "Semantics and Implementation of Schema Evolution in Object-Oriented Databases", 1987, pp. 311-322.

Kim et al., "Composite Object Support in an Object-Oriented Database System", OOPSLA '87 Proceedings, Oct. 4-8, 1987, pp. 118-125.

Hull et al., "Semantic Database Modeling: Survey, Applications, and Research Issues", ACM Computing Surveys, vol. 19, No. 3, Sep. 1987, pp. 201-260.

Nixon et al., "Implementation of a Compiler for a Semantic Data Model: Experiences with Taxis", 1987, pp. 118-131.

Codd, E., "Extending the Database Relational Model to Capture More Meaning", ACM Transactions on Database Systems, vol. 4, No. 4, Dec. 1979, pp. 397-434.

Peckham et al., "Semantic Data Models", Acm Computing Surveys, vol. 20, No. 3, Sep. 1988, pp. 153-189.

Tsurt et al., "An Implementation of GEM—supporting a semantic data model on a relational back-end.", 1984, pp. 286-295.

- Wilkinson et al., "The Iris Architecture and Implementation", IEEE Transactions on Knowledge and Data Engineering, vol. 2, No. 1, Mar. 1990, 27 pages.
- Gamache et al., "Addressing Techniques Used in Database Object managers O₂ and Orion", SIGMOD Record, vol. 24, No. 3, Sep. 1995, pp. 50–55.
- Kim et al., "Architecture of the Orion Next-Generation Database System", IEEE, 1990, pp. 109–124.
- Klimbie et al., "Data Base Management", North-Holland Publishing Company, 1974, pp. 1–59.
- Hudson et al., "Cactis: A Self-Adaptive, Concurrent Implementation of an Object-Oriented Database Management System", ACM Transactions on Database Systems, vol. 14, No. 3, Sep. 1989, pp. 291–321.
- Annevelink et al., "Object SQL—A Language for the Design and Implementation of Object Databases", Jan. 3, 1994, pp. 1–21.
- Chen, P., "Entity-Relationship Approach to Information Modeling and Analysis", International Conference in Washington, D.C., Oct. 12–14, 1981, pp. 49–72.
- Wiederhold, G., "Database Design Appendix B", McGraw-Hill, 2001, pp. 689–698.
- Hanks, D.R., "The Payoff of Modest Price Adjustments," (Abstract only), Bank Marketing, vol. 12, No. 9, p. 13., Sep. 1980.
- Fishman et al., "Overview of the Iris DBMS", Association for Computing Machinery, Inc., pp. 219–250.
- Halper et al., "An OODB "Part" Relationship Model", 10 pages.
- Kim et al., "Feature of the Orion Object-Oriented Database System", pp. 251–282.
- Kim et al., "Evaluation of the Object-relational DBMS Postgres .I. Administrative Data", Computing Science, Oct. 1994, pp. 1–52.
- Hendler, James A. Expert Sytems: The User Interface. Albex Publishing Corporation. Norwood, NJ. 1988. pp. 31, 46–47, 109–110, 113 and 132–134.
- Rose, Peter S., et al. Financial Institution, Understanding and Managing Financial Services, 4th Edition, Richard D. Irwin, Inc., 1993. pp. 1–217;328–356;423–446;659–792.
- Parsaye, Kamran & Chignell, Mark. Expert Systems For Experts. John Wiley & Sons, 1988. pp. 35–60, 177–178, 191–210 and 295–309.
- Howcroft, "Contemporary issues in UK bank delivery systems", Inter. Jour. of Service Industry Management, vol. 3, No. 1, pp. 39–56, ISBN 096–4223, 1992.
- "The Smart Card's Chief Advocate", Credit Card Management, vol. 10, No. 1, p. 26+, ISBN: 0896–9329, 1992.
- Bharadwaj et al., Determinants of success in service industries: a PIMS-based empirical investigation, Journal of Service Marketing, v7n4, pp. 19–40, 1993, 23 pages from Dialog file 15, acc. # 00813287.
- Cattell, R. and Rogers, T., "Combining Object-Oriented and Relational Models of Data", 1986 International Workshop on Sep. 26, 1986, pp. 212–213.
- Rumbaugh, J., "Relations as Semantic Constructs in an Object-Oriented Language", OOPSLA '87 Proceedings, Oct. 4–8, 1987, pp. 466–481.
- Dewan et al. "Engineering the Object-Relation Database Model in O-Raid", Lecture Notes in Computer Science, 3rd International Conference—Paris, Jun. 21–23, 1989, pp. 389–403.
- Blaha et al., "Relational Database Design using an Object-Oriented Methodology", Communications of the ACM, Apr. 1988, vol. 31, No. 4, pp. 414–427.
- Wiederhold, G., "Views, Objects, and Databases" Computer Database Architecture, Dec. 1986, pp. 37–44.
- Mark et al., "Metadata Management", Computer Database Architecture, Dec. 1986, pp. 26–36.
- Osborn et al., "The Design of a relational Database System with Abstract Data Types for Domains", ACM Transactions on Database Systems, vol. 11, No. 3, Sep. 1986, pp. 357–373.
- Whang et al., "Query Optimization in a Memory-Resident Domain Relational Calculus Database System", ACM Transactions on Database Systems, vol. 15, No. 1, Mar. 1990, pp. 67–95.
- Finkelstein et al., "Physical Database Design for Relational Databases", ACM Transactions on Database Systems, vol. 13, No. 1, Mar. 1988, pp. 91–128.
- Takahashi, J., "Hybrid Relations for Database Schema Evolution", IEEE, 1990, pp. 465–470.
- Khoshafian, S. and Copeland, G., "Object Identity", Microelectronics and Computer Technology Corporation, pp. 37–46.
- Rowe, L. and Stonebraker, M., "The POSTGRES Data Model", Computer Science Division, EECS Department, University of California, pp. 1–21.
- Stonebraker, M. and Moore, D., "Object-Relational DBMSs The Next Great Wave", Morgan Kaufman Publishers, Inc., 1996, pp. 56–61.
- Anon., "Future of European Payment Systems? Integrating the Card, ATM's, and Eurocheque," (Abstract only), World of Banking, vol. 9, No. 2, p. 19, Mach/Apr. 1990.
- Nadler, P.S. "Comment: Pitfalls of Relationship Banking," (Abstract only) American Banker, p. 4, Feb. 3, 1992.
- Stuchfield, N., et al., "Modeling of Profitability of Customer Relationships: Development and Impact of Barclays de Zoete Wedd's Beatrice," Journal of Management Information Systems, vol. 9, No. 2, p. 53, Fall 1992.
- Toby J. Teorey, et al., A Logical Design Methodology for Relational Databases Using the Extended Entity-Relationship Model, Computing Surveys, vol. 18, No. 2, Jun. 1986, pp. 197–222 ("Teorey").
- Daniel R. Dolk, et al., A Relational Information Resource Dictionary System, Computing Practices, Communications of the ACM (Jan. 1987).
- M.M. Zloof, Query-by-Example: A Data Base Language, IBM Systems Journal, No. 4 (1977).
- Rudolph Munz, "Das WEB-Modell", (translated pages), pp. 155–156, Fig. 10.2.1, (1976) ("Munz 111"), with English translation.
- Gio Wiederhold, "Database Design Second Edition", Discloses Definition Tables, Sections 7–3–1, 7–3–7, 7–4–4, 7–4–5, and 9–7–6 and Figs. 8–5, 8–7, 8–9 (1995).
- Pin-Shan Chen, The entity-relationship model—A basis for the enterprise view of data 77 (1977).
- Mark L. Gillenson, Database Step-by-step 141–42, 2d Ed. (1990).
- The IBM Dictionary of Computing Terms 87 (8th Ed. 1987).
- Webster's New World Dictionary of Computer Terms 107 (3d Ed. 1988).
- Rudolph Munz, "Das WEB-Modell" (English Translated pages), Chapter 10 (1976), 18 pages.
- Introduction to NonStop SQL, Tandem Computers, May 1988, pp. I–3–19.

Adiba et al., "Database Snapshots", Proceedings of the 1980 International Conference on Very Large Data Bases, IEEE 1980, pgs. 86-91.

Blakeley et al., "Join Index, Materialized View, and Hybrid-Hash Join: A Performance Analysis", Technical Report No. 280, Indiana University Computer Science Department, IEEE 1990, pgs. 256-263.

Elmasri et al., "Fundamentals Of Database Systems", 1989.

Hainaut, J. L., "Theoretical And Practical Tools For Data Base Design", Proceedings of the Seventh International Conference on Very Large Data Bases, IEEE 1981, pgs. 215-224.

* cited by examiner

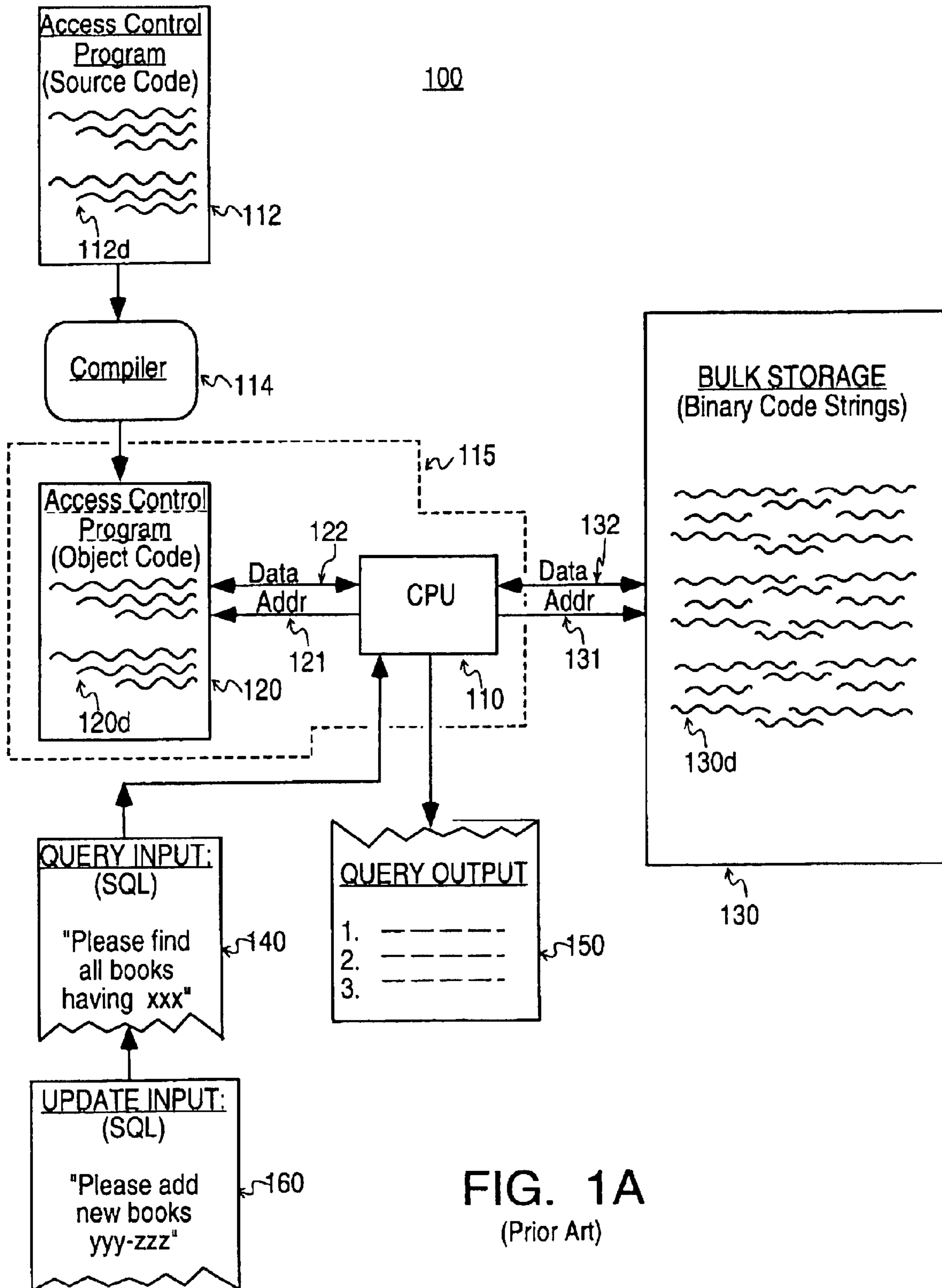

FIG. 1A
(Prior Art)

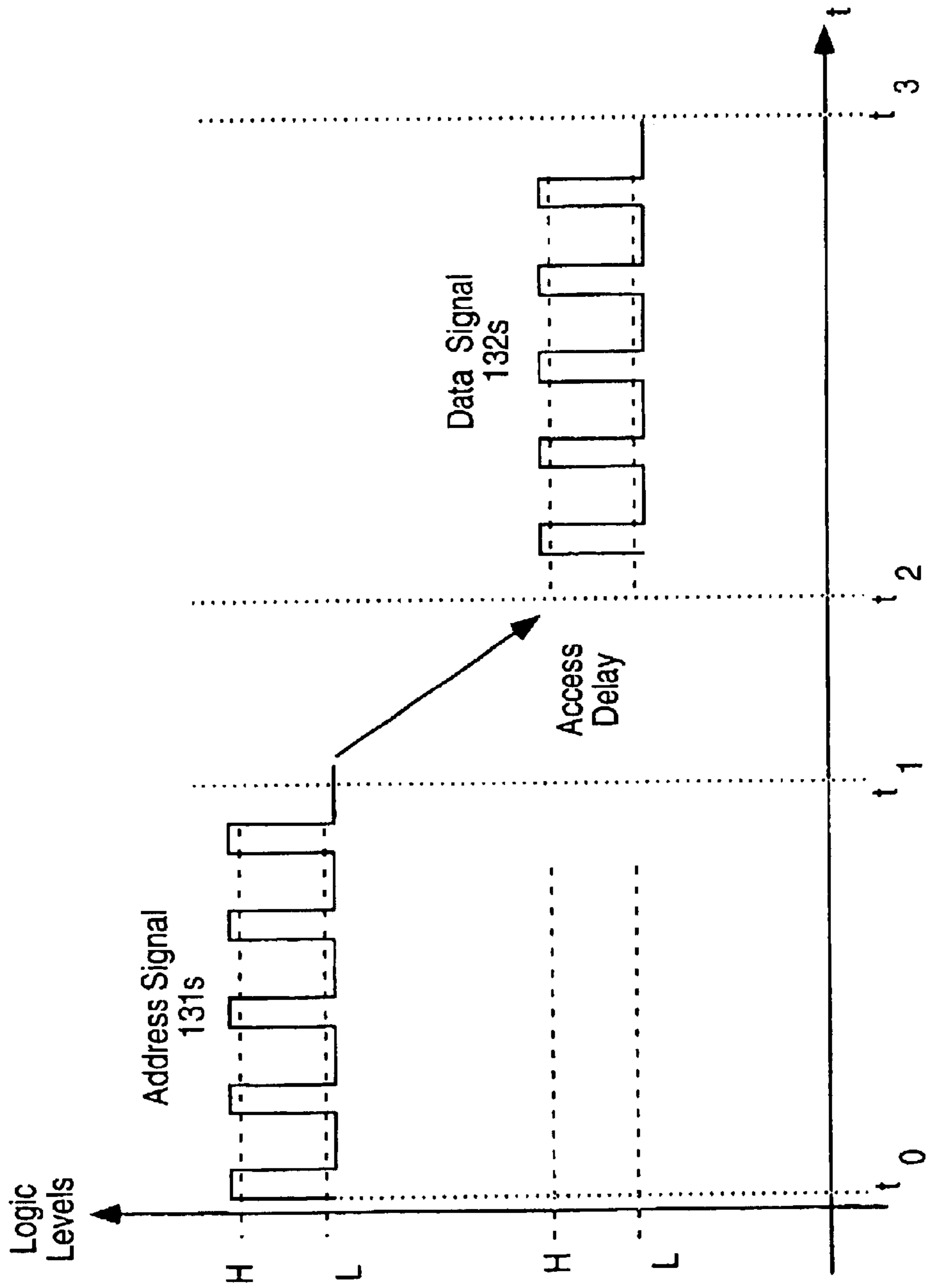
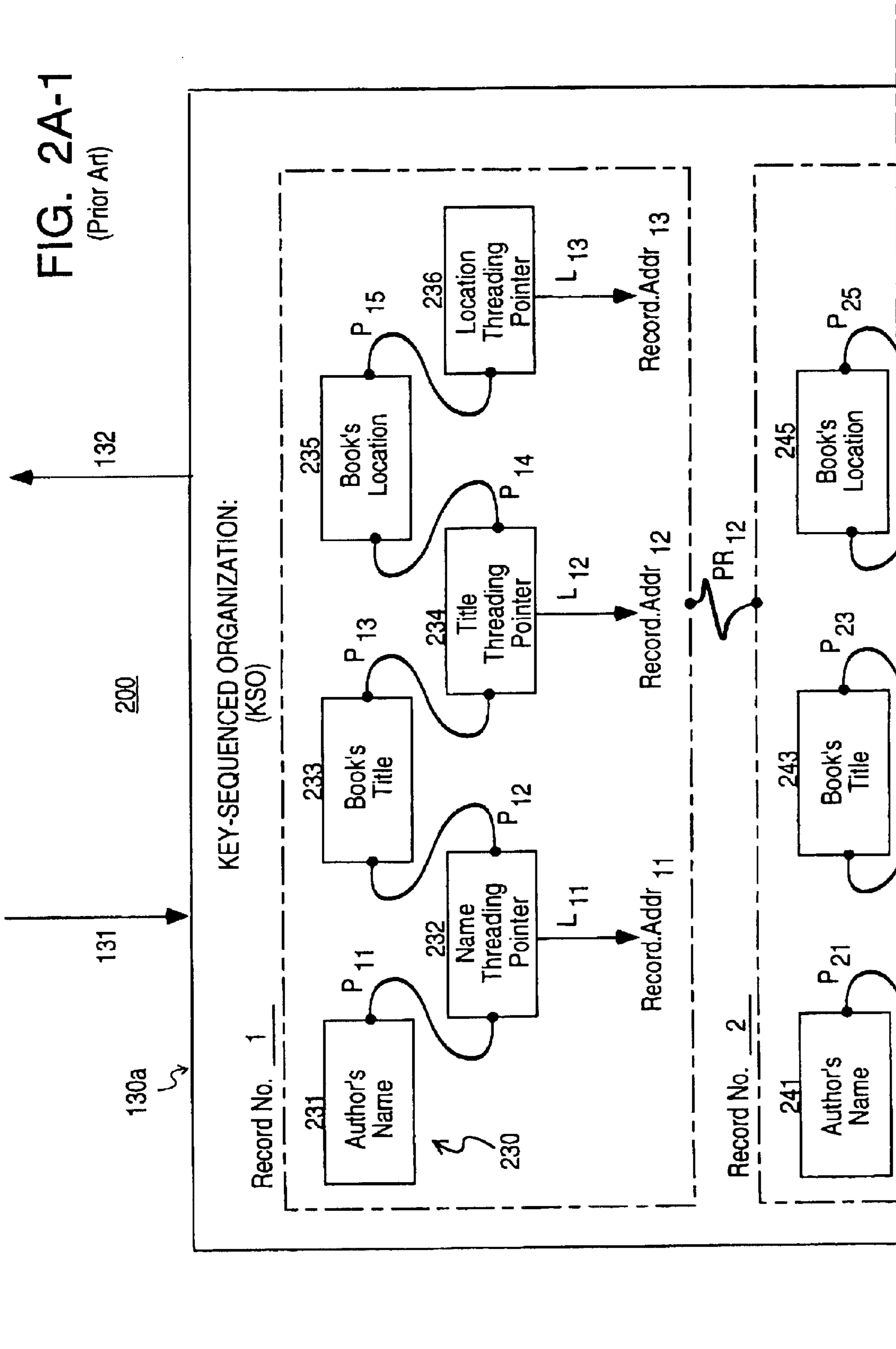

FIG. 1B
(Prior Art)

FIG. 2A-1
(Prior Art)



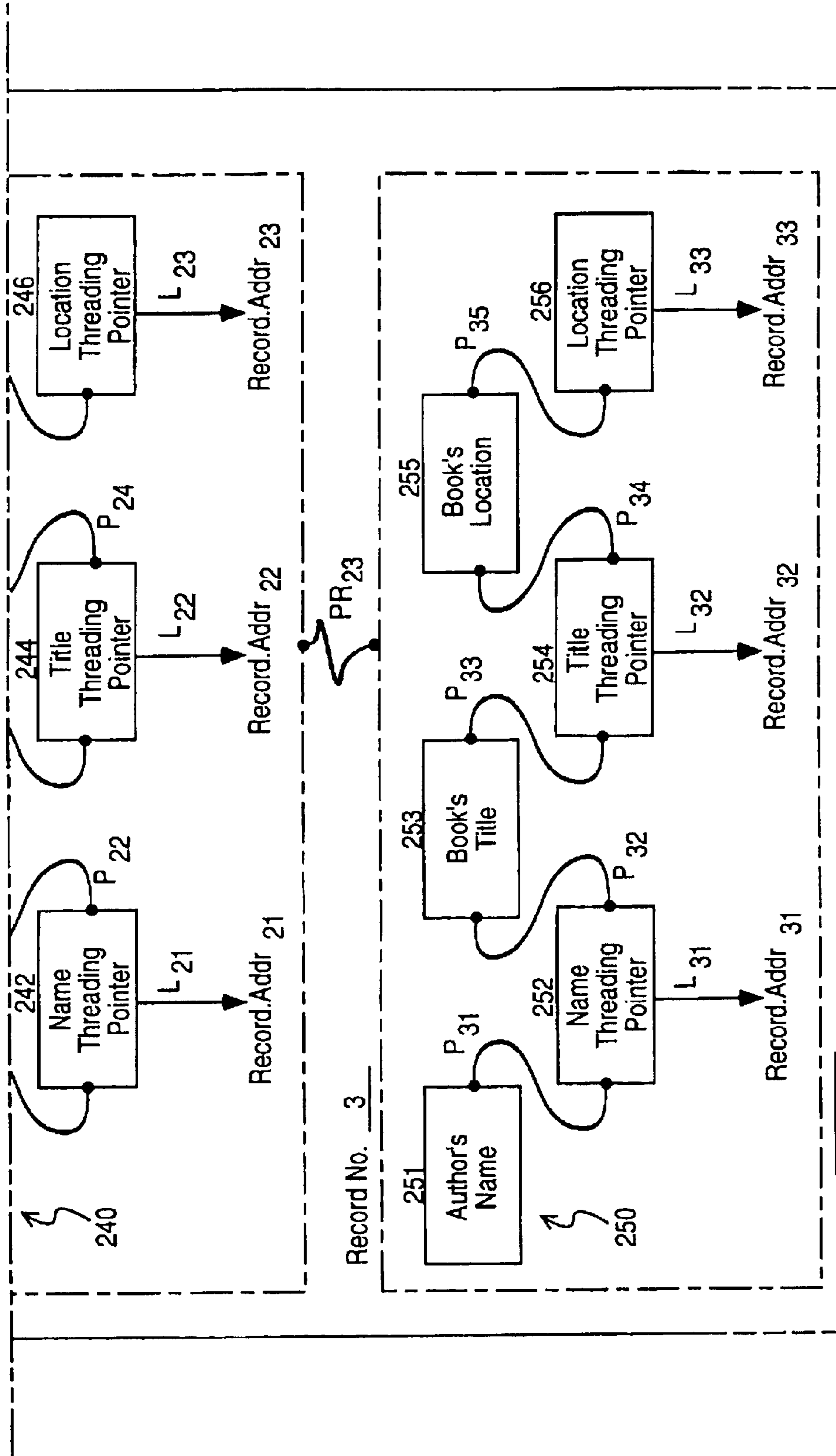
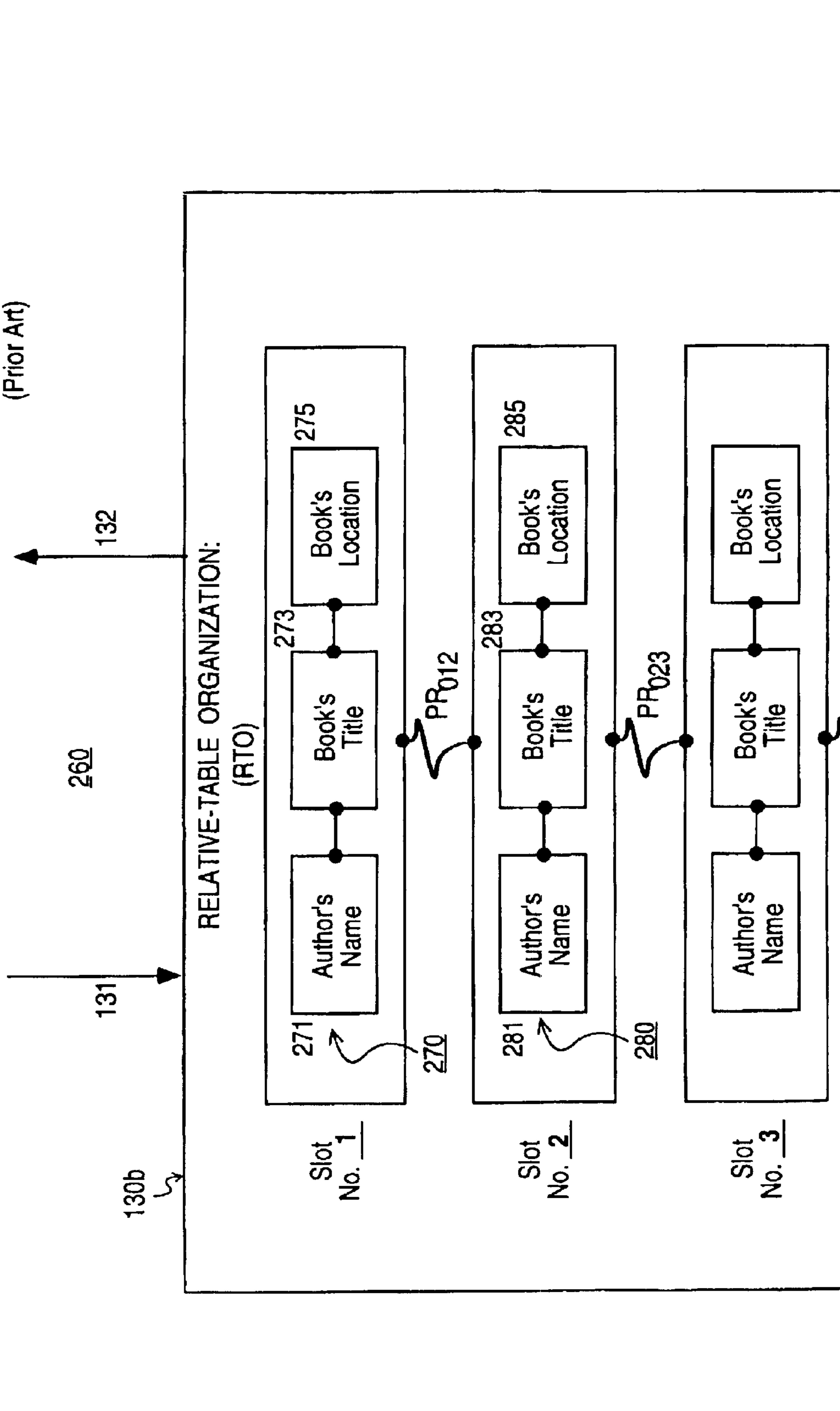

FIG. 2A-2
(Prior Art)

FIG. 2A-1	FIG. 2A
FIG. 2A-2	

FIG. 2B-1
(Prior Art)



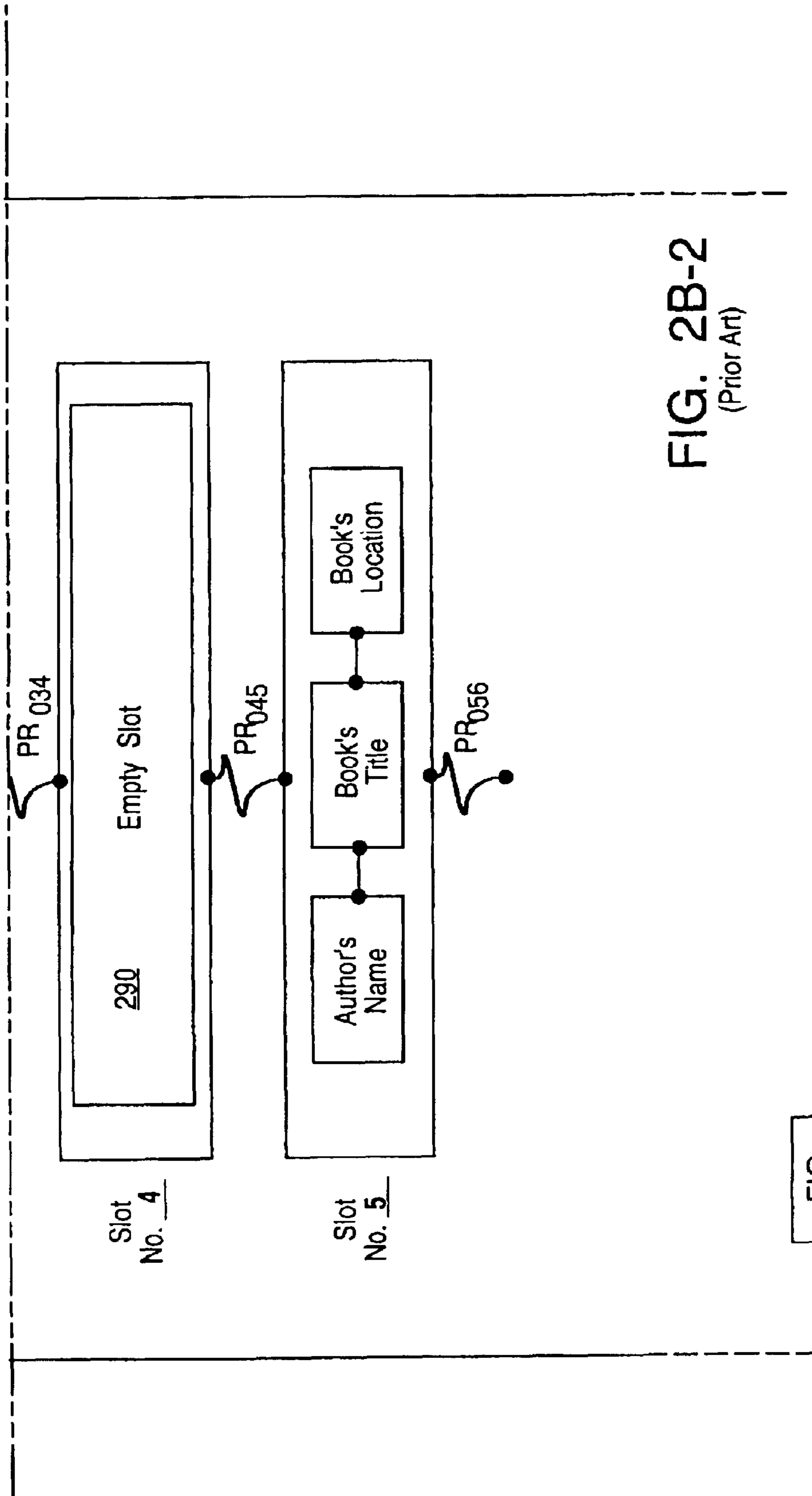

FIG. 2B-2
(Prior Art)

FIG. 2B-1
FIG. 2B-2

FIG. 2B

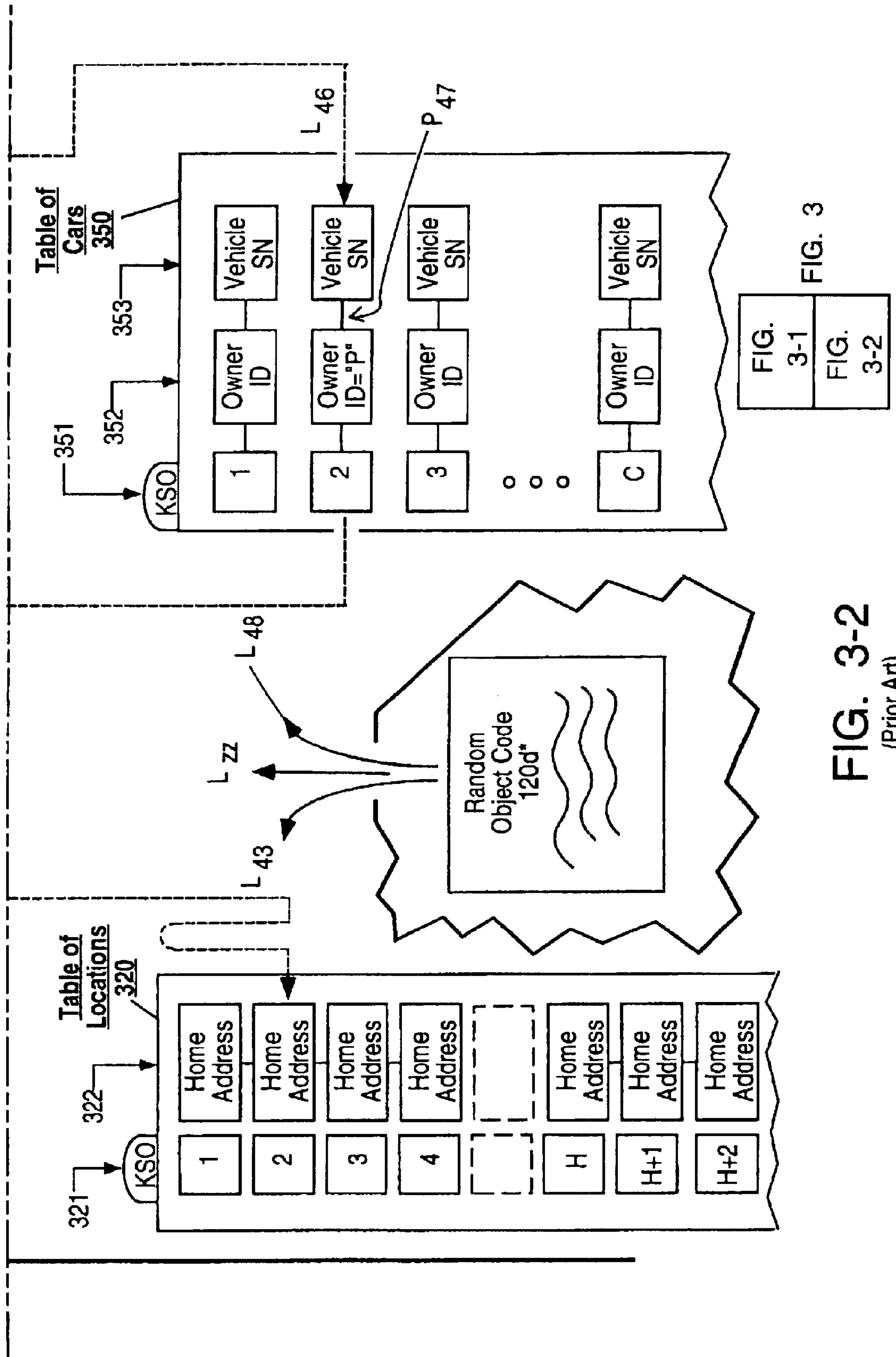

FIG. 3-2
(Prior Art)

FIG. 4A

400

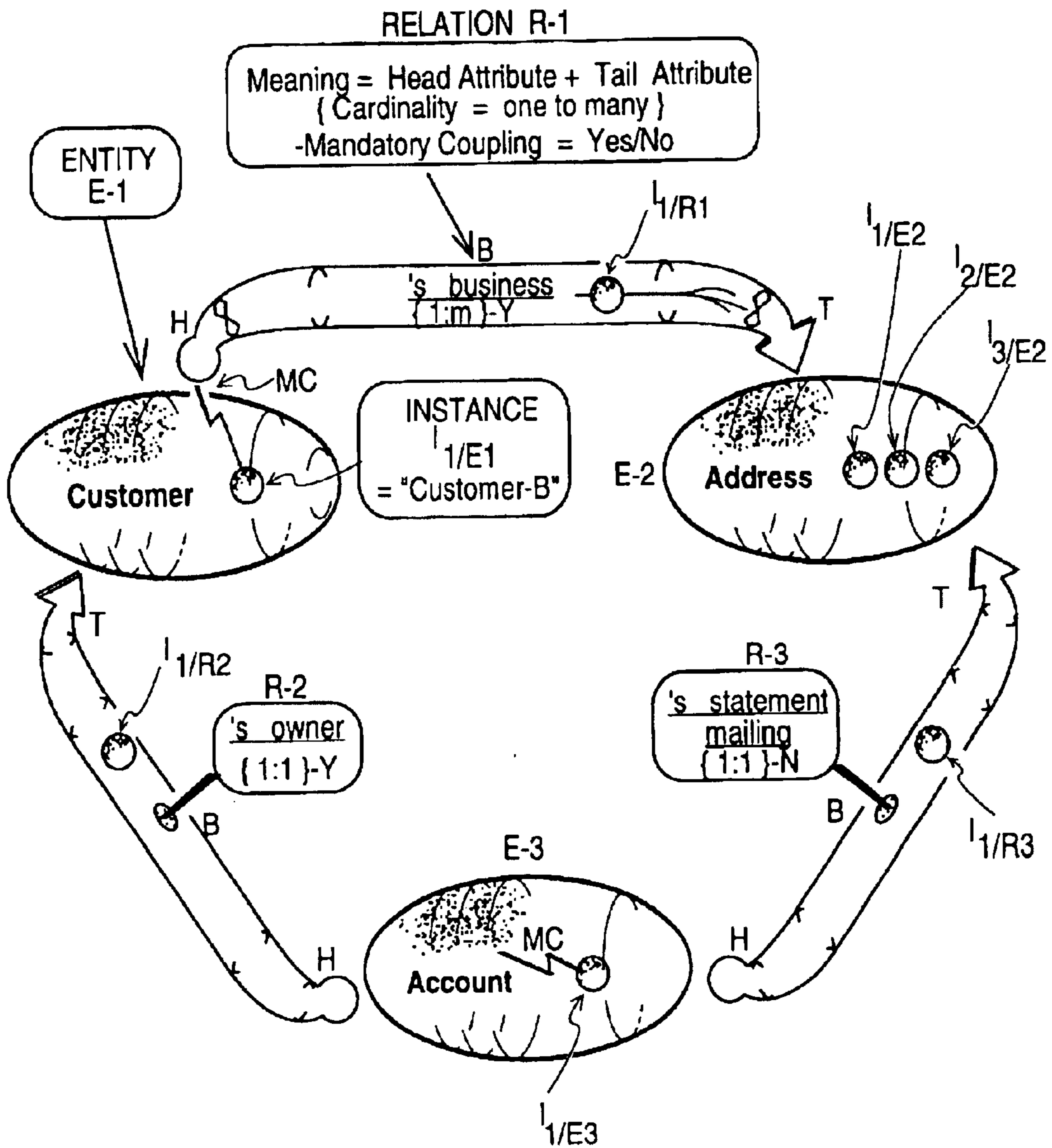

FIG. 4B

450

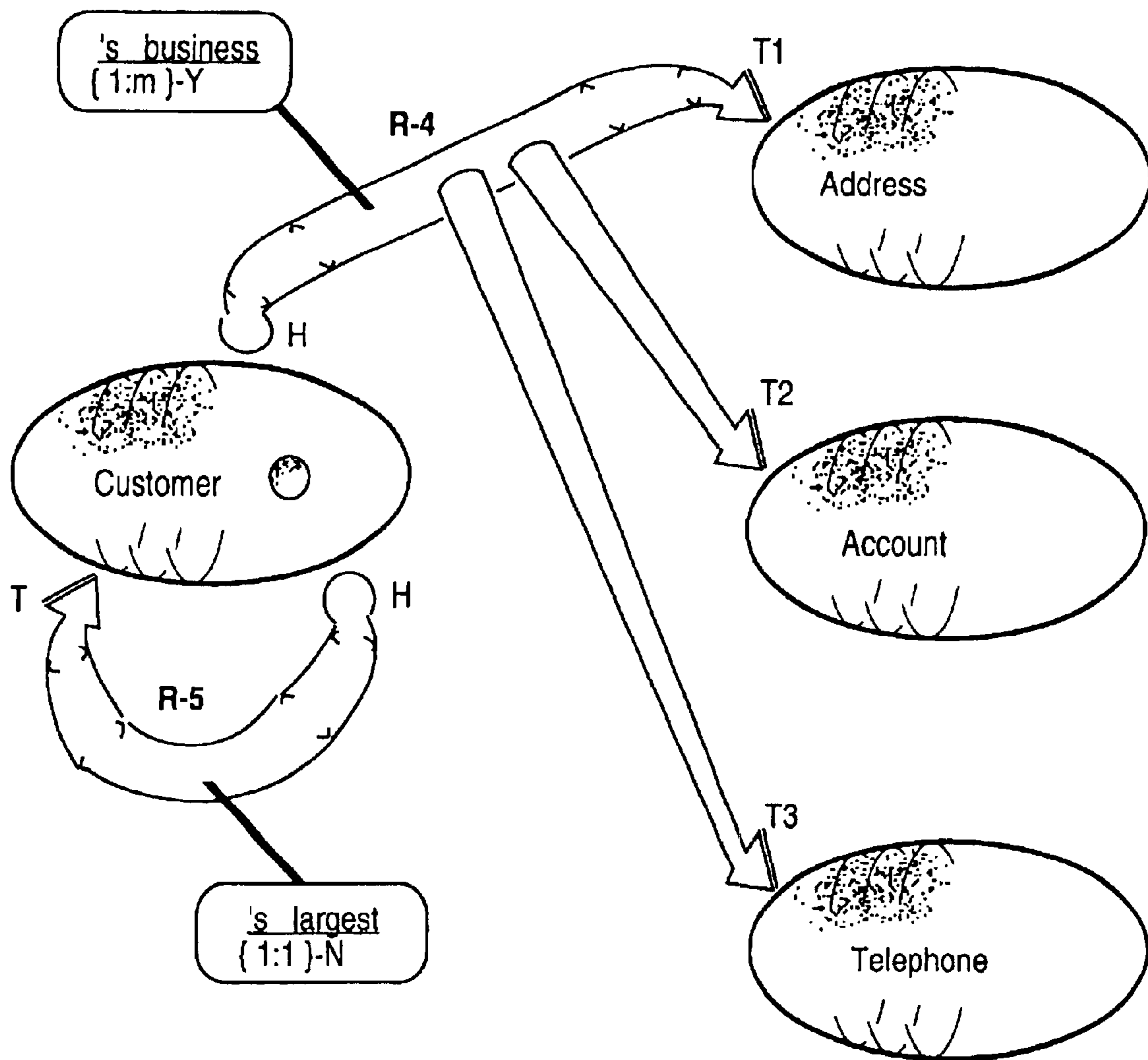

FIG. 5

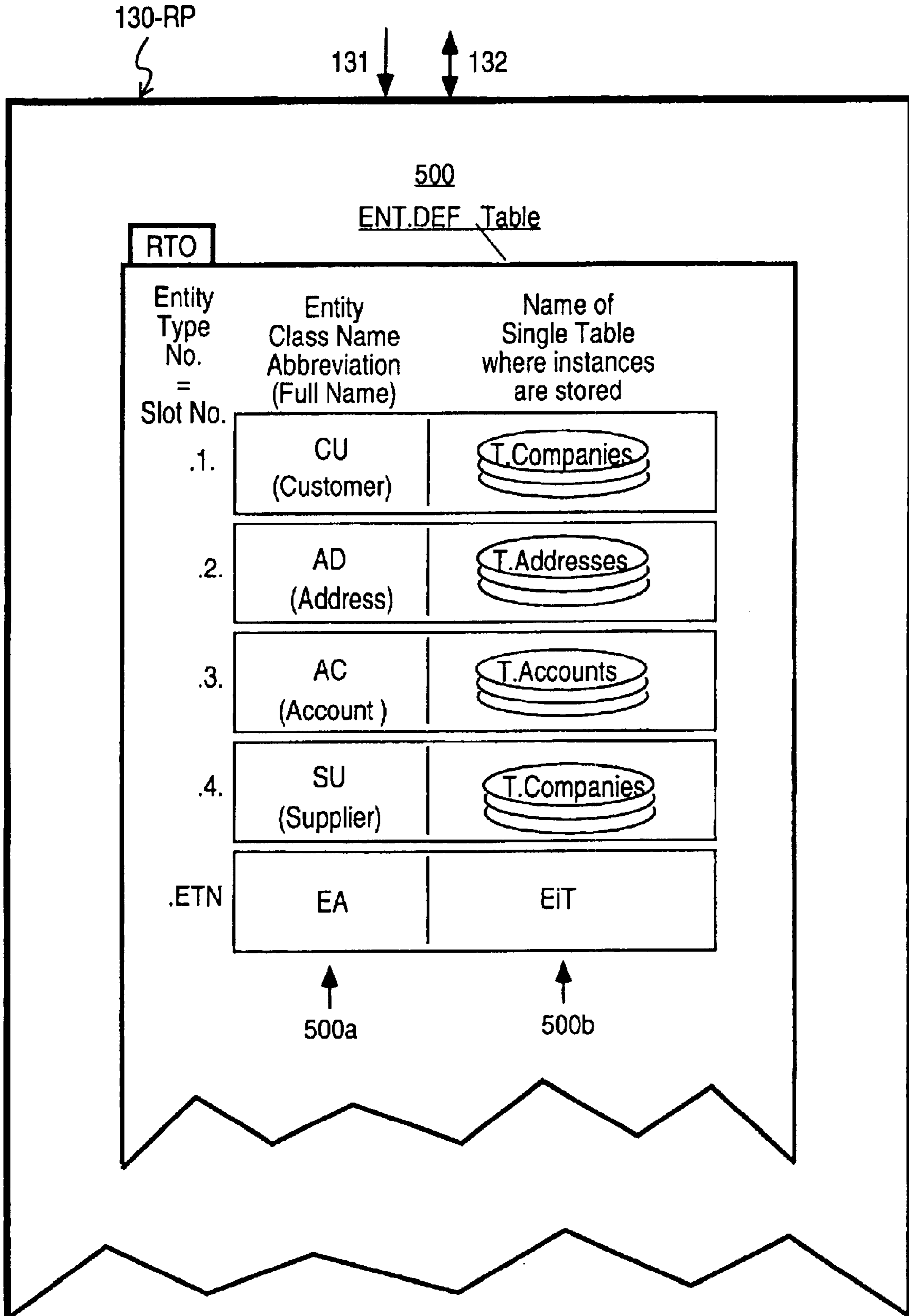
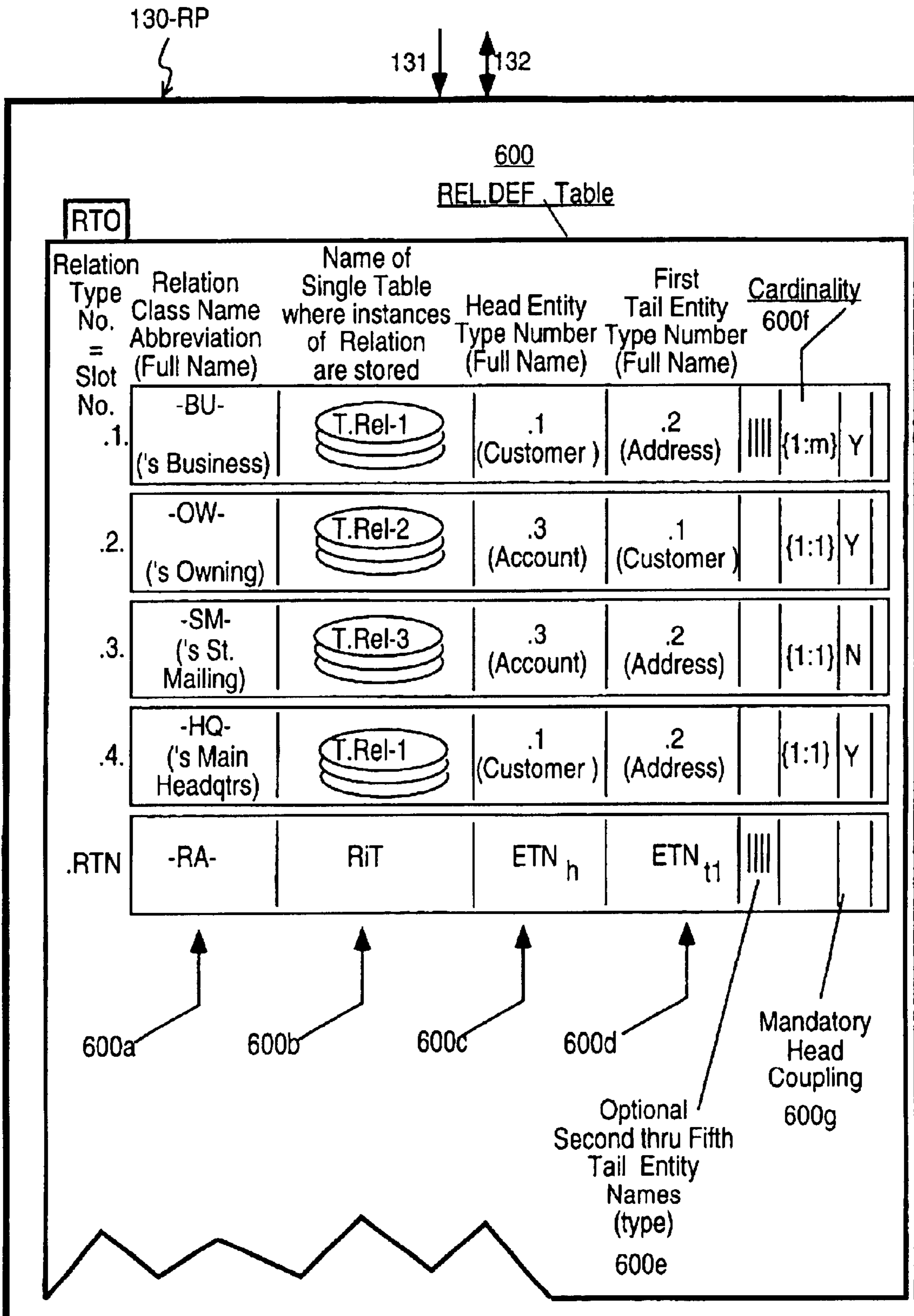

FIG. 6A



130-RP

131

132

FIG. 6B

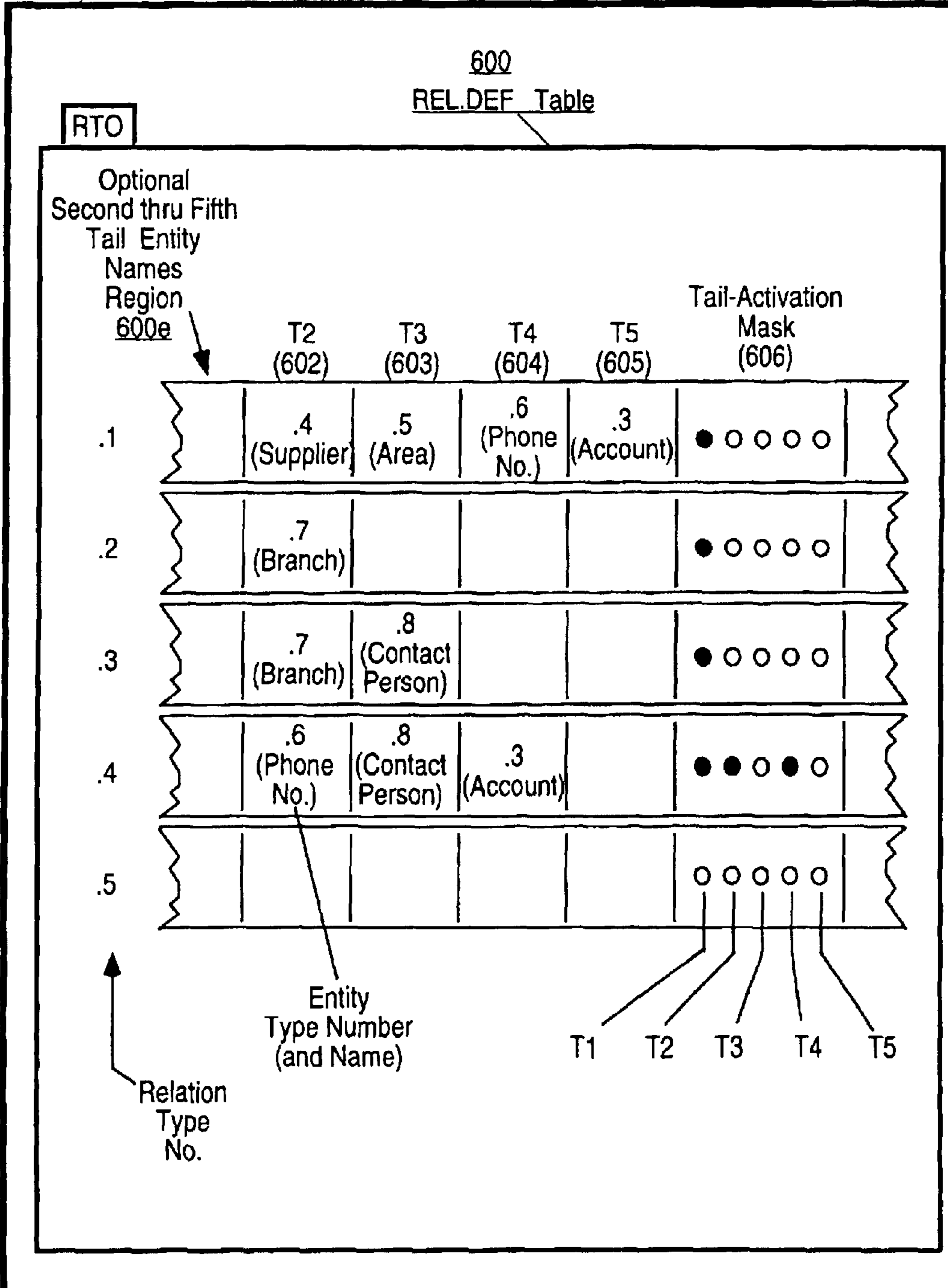

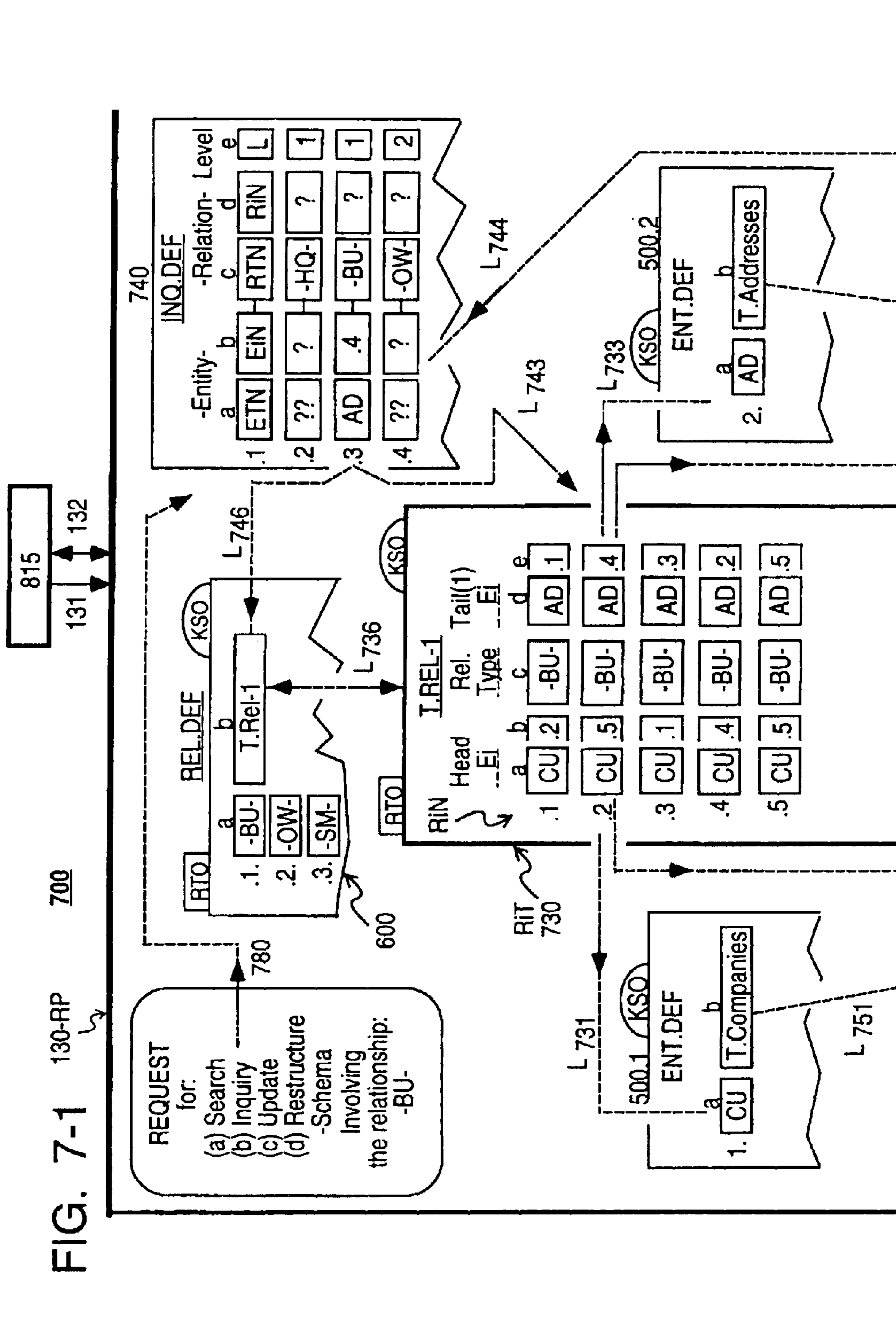

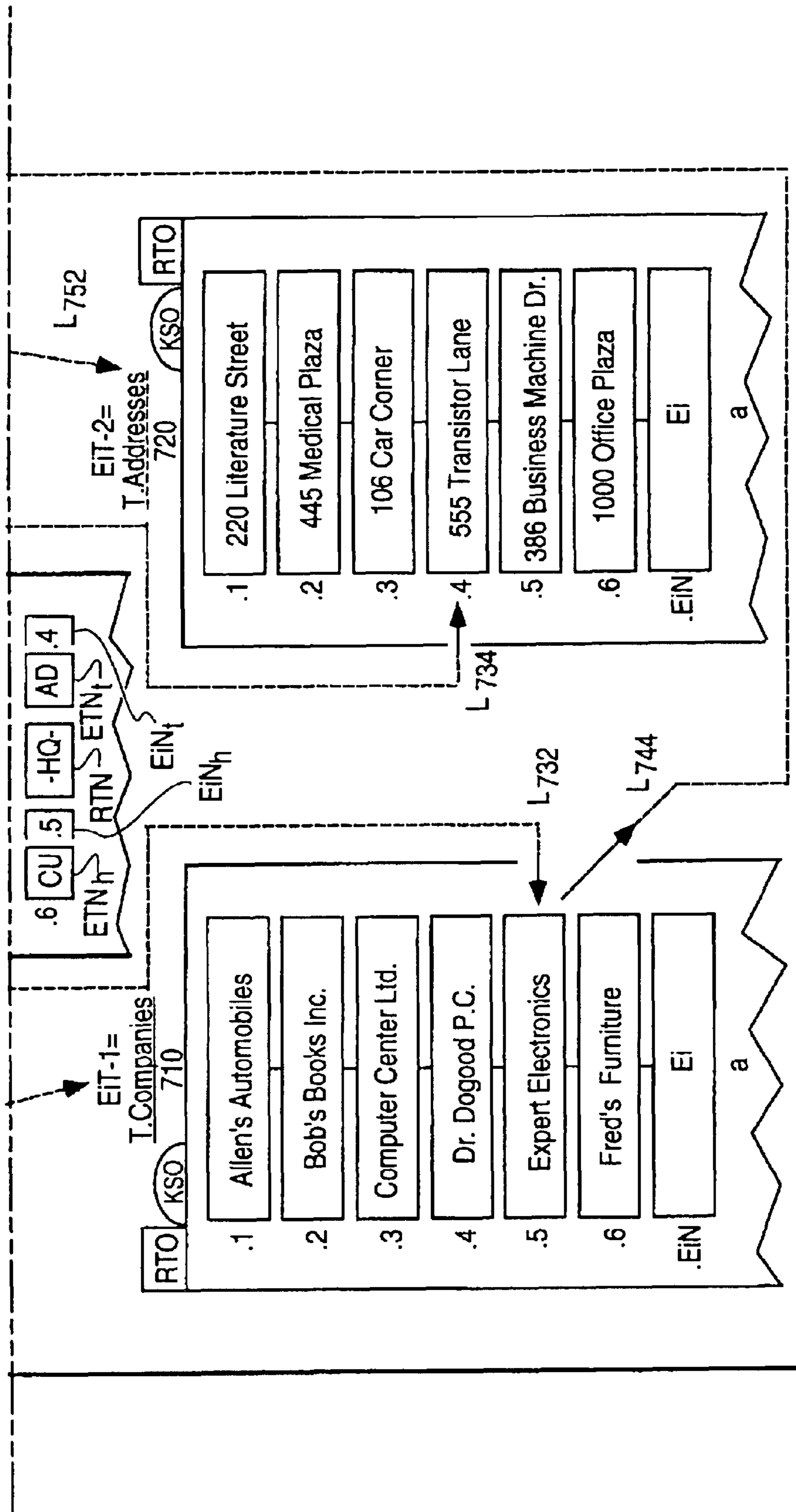

FIG. 7-1
FIG. 7-2

FIG. 7-2

FIG. 7

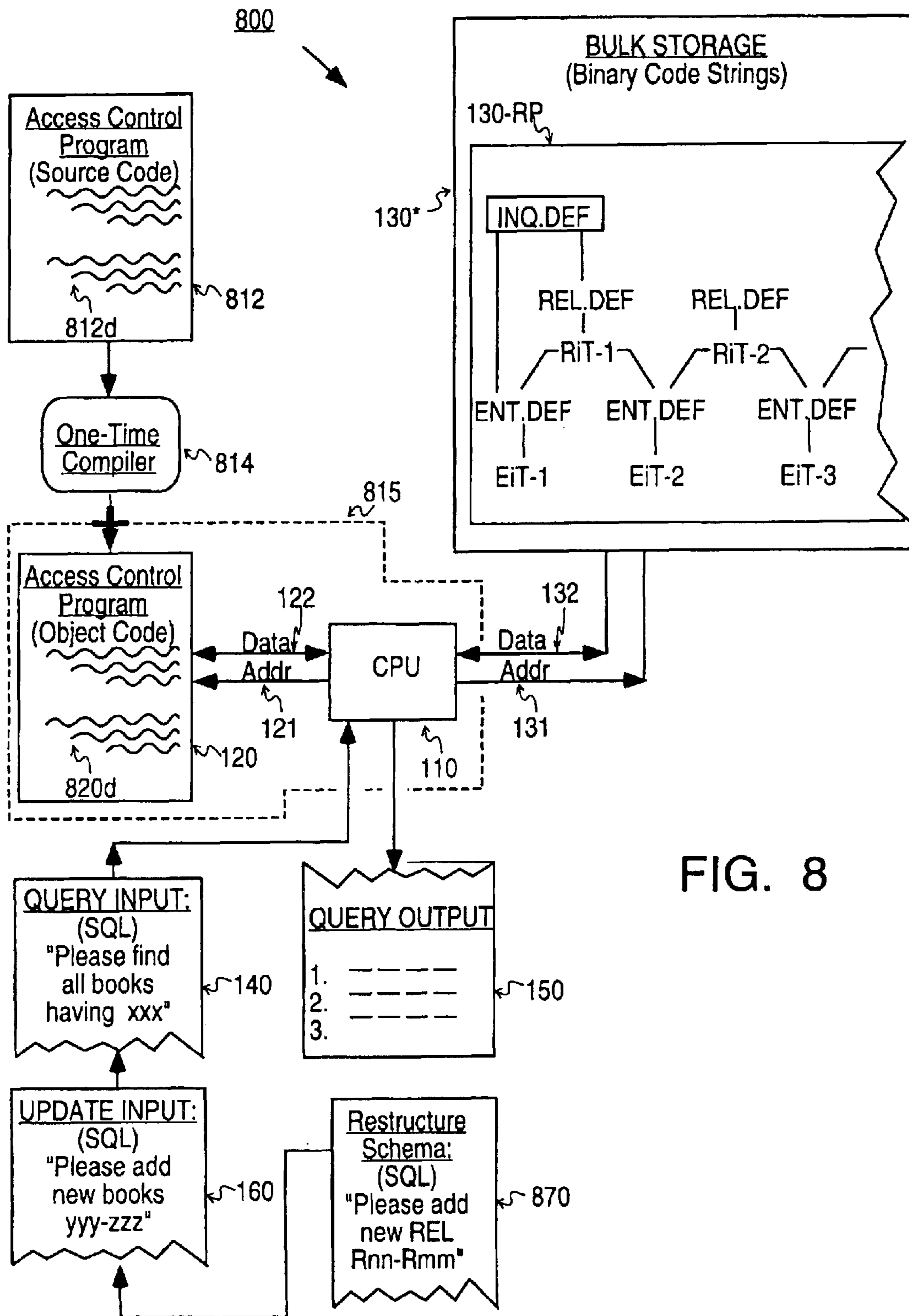
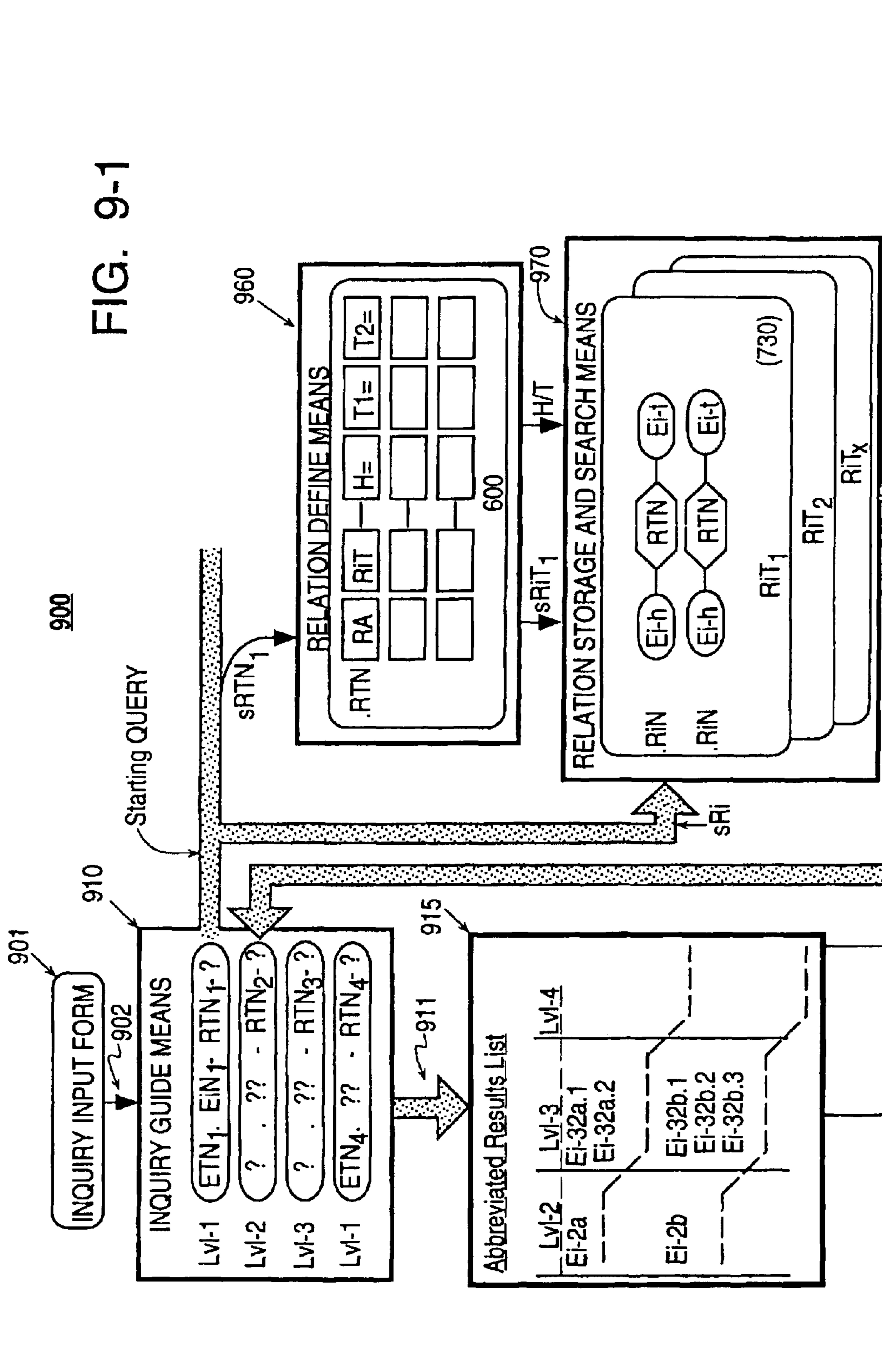

FIG. 8

FIG. 9-1



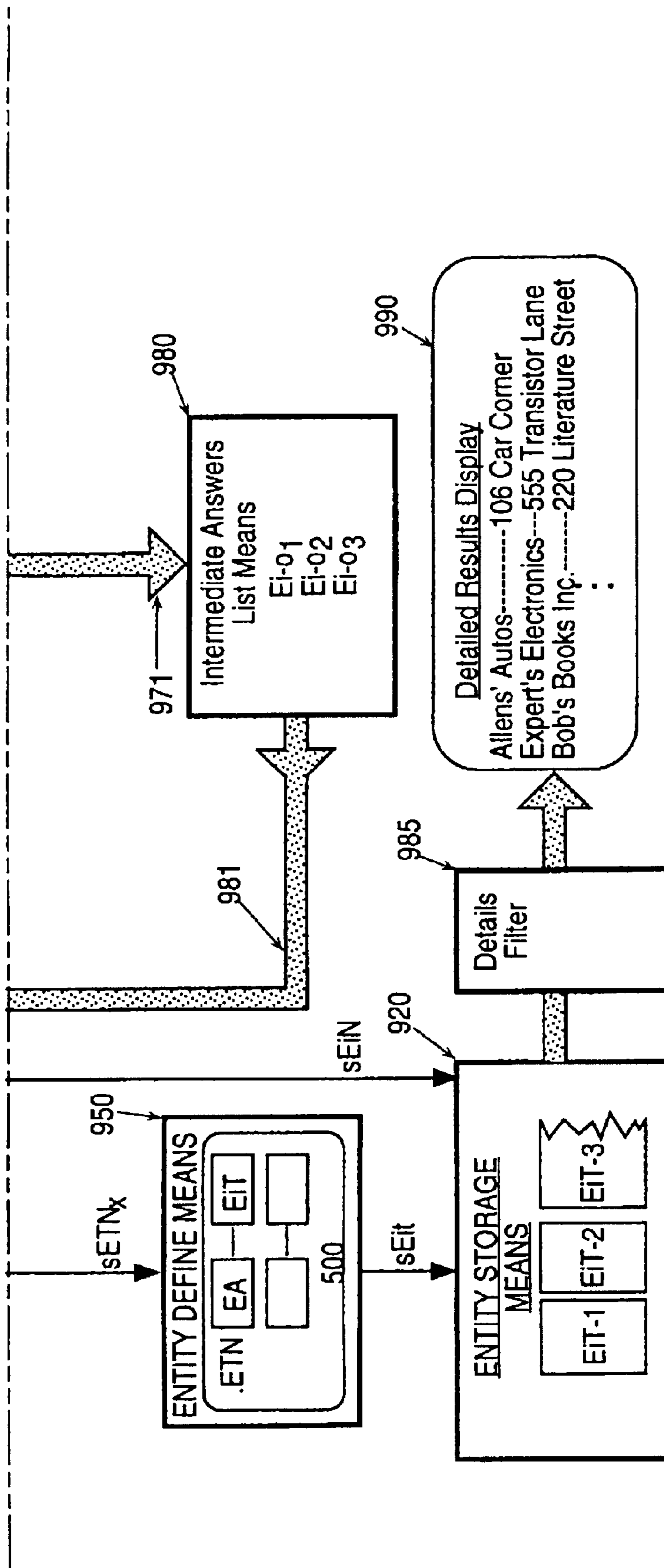

FIG. 9-2

FIG. 9-1
FIG. 9-2

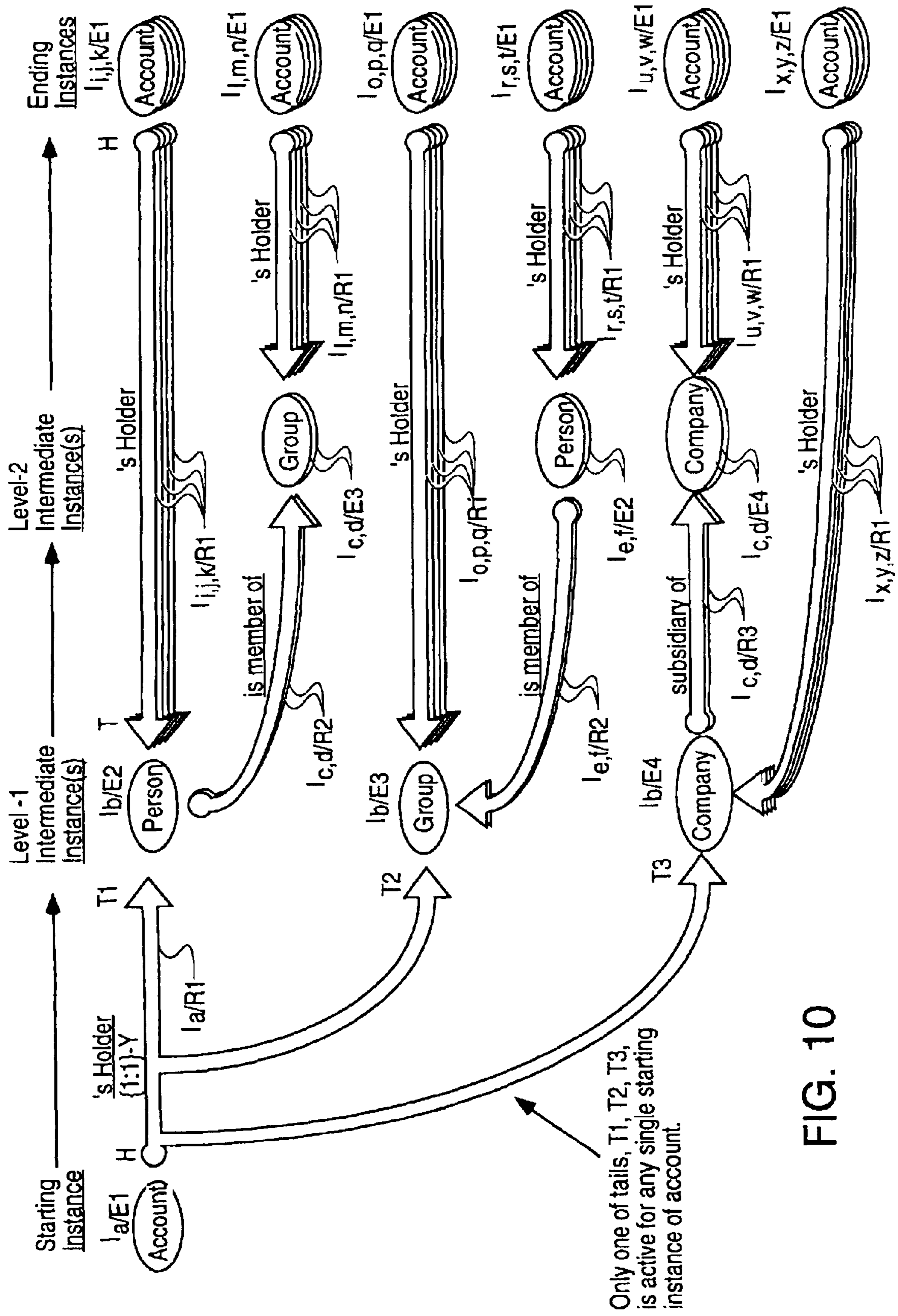

FIG. 10

EASILY EXPANDABLE DATA PROCESSING SYSTEM AND METHOD

Matter enclosed in heavy brackets [] appears in the original patent but forms no part of this reissue specification; matter printed in italics indicates the additions made by reissue.

This application is a continuation of application Ser. No. 08/439,207, filed May 11, 1995, now U.S. Pat. No. 5,675,779, which is a divisional of Ser. No. [08/083,361] 08/083,861, filed Jun. 28, 1993, now [issued:] U.S. Pat. No. 5,604,899, which issued on Feb. 18, 1997, which is a continuation of Ser. No. 07/526,424, filed May 21, 1990, now abandoned.

BACKGROUND OF THE INVENTION

Cross Reference to Microfiche Appendix

This application includes a plurality of computer program listings (modules) in the form of a Microfiche Appendix which is being filed concurrently herewith as 1162 frames (not counting target and title frames) distributed over 20 sheets of microfiche in accordance with 37 C.F.R. § 1.96. The disclosed computer program listings are incorporated into this specification by reference but it should be noted that the source code and/or the resultant object code of the disclosed program modules are subject to copyright protection. The copyright owner has no objection to the facsimile reproduction by anyone of the patent document (or the patent disclosure as it appears in the files or records of the U.S. Patent and Trademark Office) for the sole purpose of studying the disclosure but otherwise reserves all other rights to the disclosed computer program modules including the right to reproduce said computer program modules in machine-executable form.

Field of Invention

The present invention relates generally to computer database management systems and more specifically to apparatus and methods for modifying and searching through large scale databases at high speed.

Description of Related Art

Modern computer systems are capable of storing voluminous amounts of information in bulk storage means such as magnetic disk banks. The volume of stored information can be many times that of the textural information stored in a conventional encyclopedia or in the telephone directory of a large city. Moreover, modern computer systems can sift through the contents of their bulk storage means at extremely high speed, accessing as many as one million bytes of information or more per second (a byte is a string of eight bits, equivalent to approximately one character of text in layman's terms). Despite this capability, it may take an undesirably long time (i.e., hours or days) to retrieve desired pieces of information. In commercial settings such as financial data storage facilities, there will be literally billions of pieces of information that could be sifted through before the right one or more pieces of information are found. Thus, even at speeds of one million examinations per second, it can take thousands of seconds (many hours) to retrieve a desired piece of information. Efficient organization of the stored information is needed in order to minimize retrieval time.

The methods by which pieces of information are organized within a computer, searched through or reorganized, often parallel techniques used by older types of manual

information processing systems. A well known example of a manual system is the index card catalog found in public libraries. Such a card catalog consists of a large number of uniformly dimensioned paper cards which are serially stacked in one or more trays. The cards are physically positioned such that each card is directly adjacent to no more than two others (for each typical examination there is a preceding card, the card under examination and a following card in the stack). On the front surface of each index card a librarian enters, in left to right sequence; the last name of an author, the first name of the author, the title of a single book which the author wrote and a shelf number indicating the physical location within the library where the one book may be found. Each of these four entries may be referred to as a "column" entry. Sufficient surface area must be available on each card to contain the largest of conceivable entries.

After the entries are made, the index cards are stacked one after the next in alphabetical order, according to the author's last name and then according to the author's first name and then by title. This defines a "key-sequenced" type of database whose primary sort key is the author's name. The examination position of each card is defined relative to the contents of preceding and following cards in the stack. That is, when cards are examined, each intermediate card is examined immediately after its alphabetically preceding card and immediately before is alphabetically succeeding card. When a new book is acquired, the key-sequenced database is easily "updated" by inserting a new card between two previously created cards. Similarly, if a book is removed from the collection, its card is simply pulled from the card stack to reflect the change.

If a library user has an inquiry respecting the location of a particular book or the titles of several books written by a named author, the librarian may quickly search through the alphabetically ordered set of index cards and retrieve the requested information. However, if a library user has an inquiry which is not keyed to an author's name, the search and retrieval process can require substantially more time; the worst case scenario being that for each inquiry the librarian has to physically sift through and examine each card in the entire catalog. As an example of such a scenario, suppose that an inquiring reader asks for all books in the library where the author's first name is John and the title of the book contains the word "neighbor" or a synonym thereof. Although it is conceptually possible to answer this inquiry using the information within the catalog, the time for such a search may be impractically long, and hence, while the information is theoretically available, it is not realistically accessible.

To handle the more common types of inquiries, libraries often keep redundant sets of index cards. One set of cards is sorted according to author names and another set is sorted according to the subject matter of each book. This form of redundant storage is disadvantageous because the size of the card catalog is doubled and hence, the cost of information storage is doubled. Also, because two index cards must be generated for each new book added to the collection the cost of updating the catalog is also doubled.

The size of a library collection tends to grow over time as more and more books are acquired. During the same time, more and more index cards are added to the catalog. The resulting stack of cards, which may be viewed as a kind of "database", therefore grows both in size and in worth. The "worth" of the card-based system may be defined in part as the accumulated cost of all work that is expended in creating each new index card and in inserting the card into an appropriate spot in the stack.

As time goes by, not only does the worth and size of the database grow, but new technologies, new rules, new services, etc., begin to emerge and the information requirements placed on the system change. Some of these changes may call for a radical reorganization of the card catalog system. In such cases, a great deal of work previously expended to create the catalog system may have to be discarded and replaced with new work.

For the sake of example, let it be supposed that the library acquires a new microfilm machine which stores copies of a large number of autobiographies. The autobiographies discuss the life and literary works of many authors whose books are kept in the library. Let it further be supposed that the original, first card catalog system is now required to cross reference each book to the microfilm location (or plural locations) of its author's (or plural authors') autobiographies. In such a case, the card catalog system needs to be modified by adding at least one additional column of information to each index card to indicate the microfilm storage locations of the relevant one or more autobiographies.

We will assume here that there is not enough surface area available on the current index cards for adding the new information. Larger cards are therefore purchased, the information from the old cards is copied to the new cards, and finally, the new microfilm cross referencing information is added to the larger cards. This type of activity will be referred to here as "restructuring" the database.

Now let us suppose, that as more time goes by, an additional but previously unanticipated, cross indexing category is required because of the introduction of a newer technology or a new government regulation. It might be that the just revised and enlarged second card system does not have the capacity to handle the demands of the newer technology or regulation. In such a situation, a third card system has to be constructed from scratch. The value of work put into the creation of the just-revised second system is lost. As more time passes and further changes emerge in technology, regulations, etc., it is possible that more major organizational changes will have to be made to the catalog system. Time after time, a system will be built up only to be later scrapped because it fails to anticipate a new type of information storage and retrieval operation. This is quite wasteful.

Although computerized database systems are in many ways different from manual systems, the computerized information storage and retrieval systems of the prior art are analogous to manual systems in that the computerized databases require similar restructuring every time a new category of information relationships or a new type of inquiry is created.

At a fundamental level, separate pieces of information are stored within a computerized database system as a large number of relatively short strings of binary bits where each string has finite length. The bit strings are distributed spatially within a tangible medium of data storage such as an array of magnetic disks, optical devices or other information representing means capable of providing mass storage. Each bit is represented by a magnetic flux reversal, an optical perturbation and/or some other variance in the physical attributes of a data storage medium. A transducer or amplifier means converts these variances into signals (e.g., electrical, magnetic, or optical) which can be processed on a digital data processing machine. Each string of bits is often uniquely identified by its physical location or by a logical storage address. Some bit strings may function as address pointers, rather than as the final pieces of "real" information which a database user wishes to obtain. The address pointers

are used to create so-called "threaded list" organizations of data wherein logical links between a first informational "object" (first piece of real data) and a second informational "object" (second piece of real data) are established by a chain of direct or indirect address pointers. The user-desired objects of real information themselves can be represented by a collection of one or more physically or logically connected strings.

Typically, "tables" of information are created within the mass storage means of the computerized system. A horizontal "row" of related objects, which is analogous to a single card in a card catalog system, may be defined by placing the corresponding bit strings of the objects in physical or address proximity with each other. Logical interconnections may be defined between different rows by using ancillary pointers (which are not considered here as the "real" data sought by a database user). A serial sequence of "rows" (analogous to a stack of cards) is then defined by linking one row to another according to a predefined sorting algorithm using threaded list techniques.

A vast number of different linking "threads" may be defined in this way through a database table having millions or billions of binary information bits. Unlike manual systems, the same collection of rows (which replaces the manual stack of cards) can be simultaneously ordered in many different ways by utilizing a multiplicity of threaded paths so that redundant data storage is not necessary. Searches and updates may be performed by following a pre-specified thread from one row to the next until a sought piece of information (or its address) is found within a table. A threaded-list type of table can be "updated" in a manner similar to manual card systems by breaking open a logical thread within the list, at a desired point, and inserting a new row (card) or removing an obsolete row at the opened spot.

Tables are often constructed according to a "key-sequenced" approach. One column of a threaded-list table is designated as the sort-key column and the entries in that column are designated as "sort keys". Address pointers are used to link one row of the table to another row according to a predefined sequencing algorithm which orders the entries (sort-keys) of the sort column as desired (i.e., alphabetically, numerically or otherwise). Once a table is so sorted according to the entries of its sort column, it becomes a simple task to search down the sort column looking for an alphabetically, numerically or otherwise ordered piece of data. Other pieces of data which are located within the row of each sort key can then be examined in the same sequence that each sort key is examined. Any column can serve as the sort column and its entries as the sort keys. Thus a table having a large plurality of columns can be sorted according to a large number of sorting algorithms.

The key-sequencing method gives tremendous flexibility to a computerized database but not without a price. Each access to the memory location of a list-threading address pointer or to the memory location of a sort-key or to the memory area of "real" data which is located adjacent to a sort-key takes time. As more and more accesses are required to fetch pointers and keys leading to the memory location of a piece of sought-after information ("real data"), the response time to an inquiry increases and system performance suffers.

There is certain class of computerized databases which are referred to as "relational databases". Such database systems normally use threaded list techniques to define a plurality of key-sequenced "tables". Each table contains at least two columns, One column serves as the sort column while a

second or further columns of the table store either the real data that is being sought or additional sort-key data which will ultimately lead to a sought-after piece of real data. The rows of the table are examined in an ordered fashion according to the contents of the sort column. Target data is located by first threading down the sort column and thus moving through the chain of rows within a table according to a pre-specified sort algorithm until a specific sort-key is found. Then the corresponding row is examined horizontally and the target data (real data or the next key) is extracted from that row.

An example of "real" data would be the full-legal names of unique persons such as in the character strings, "Mr. Harry W. Jones", "Mrs. Barbara R. Smith", etc. The sort-key can be a number which is stored adjacent to the full name and which sequences the names (real data) according to any of a wide variety of ordering patterns including by age, by height, by residential address, alphabetically, etc. Because the real data (e.g., full name of a person) is stored in a separate column, it is independent from the sort key data. A large variety of different relations can therefore be established between a first piece of real data (e.g., a first person's name) and a second piece of real data (e.g., a second person's name) simply by changing the sort keys that are stored in the separate sort column (e.g., who is older than whom, who is taller, etc.). Plural orderings of the real data can be obtained at one time by providing many columns in one table, by storing alternate keys in the columns and by choosing one or more of these columns as the primary sort key column.

Relational database systems often include tables that do not store real data in a column adjacent to their sort-key columns, but rather store a secondary key number which directs a searcher to a row in another key-sequenced table where a matching key number is held together with either a piece of sought-after real data or yet another forward referencing key number (e.g., an entry which in effect says "find the row which holds key number x of yet another table for further details"). With this indirect key-sequenced approach, a large number of tables can be simultaneously updated by changing one entry in a "base" table.

Relational database tables are normally organized to create implied set and subset "relations" between their respective items of pre-stored information. The elements of the lowest level subsets are stored in base tables and higher level sets are built by defining, in other tables, combinations of keys which point to the base tables. The implied relations between elements cannot be discerned by simply inspecting the raw data of each table. Instead, relations are flushed out only with the aid of an access control program which determines in its randomly-distributed object code, which table to examine first and what column to look at before beginning to search down the table's column for a key number and, when that key number is found, what other column to look at for the real data or a next key number. Relations between various "entities" of a relational database are implied by the sequence in which the computer accesses them.

By way of a concrete example, consider a first relational table (Names-Table) which lists the names of a large number of people in telephone directory style. Each name (each separate item of real data) is paired to a unique key number and the rows of this Names-Table are sorted sequentially according to the key number. A second relational table may be provided in the database (Cars-table) which lists automobile (vehicle) identification numbers (VIN) each paired in its row with a second key number. If the second key number is matched by a corresponding key number in the first table, then a relationship might be implied between the entries of

the two separate tables (Names-Table and Cars-Table). The "implied" relationship might be one of an infinite set of possibilities. The relationship could be, for example, that the car listed in the second table is "owned" by the person whose name is found next to a matching key in the first table. On the other hand, it might be implied that the matched person in the first table "drives" the car, or "cleans" the car or has some other relation to the car. It is left to the access control program to define what the relationship is between entities in the first table and entities in the second table.

It can be seen that relational database systems offer users a great deal of flexibility since an infinite number of relations may be defined (implied). Economy in maintaining (updating) the database is also provided-since a change to a base table propagates through all other tables which reference the base table. The access control program of the database system can include information-updating modules which, for example, change the key number in the second table (Cars-Table) whenever ownership of a car changes. If the name of the new owner is already in the first table (Names-Table), it does not have to be typed a second time into a new storage area and thus, extra work and storage redundancy are avoided. The vehicle identification number (VIN) remains unchanged. Minimal work is thus expended on updating the database.

Despite these advantages, relational database systems suffer from expandability and restructuring problems similar to those of the above-described manual system. Sometimes the rows within a particular table have to be altered to add additional columns. This is not easily done. Suppose for example, that a new government regulation came into being, mandating that vehicles are to always be identified not only by a vehicle identification number (VIN) but also by the name and location of the factory where the vehicle was assembled. If spare columns are not available in the Cars-Table, the entire database may have to be restructured to create extra room in the storage means (i.e. the disk bank) for adding the newly required columns. New key numbers will have to be entered into the new columns of each row (e.g., a new "factory of assembly" key number) and sorted in order to comply with the newly mandated regulation. New search and inquiry routines will have to be written for handling the newly structured tables.

In the past, much of this restructuring work was done by reprogramming the computer at the object code or source code level. This process relied heavily on an expert programming staff. It was time consuming, costly and prone to programming errors. Worst of all, it had to be redone time and again as new informational requirements emerged just after a last restructuring project was completed. There is a need in the industry for a database management system which provides quick responses to inquiries and which can also be continuously updated or restructured without reprogramming at the source or object code level.

SUMMARY OF THE INVENTION

It is an objective of the present invention to provide a database system which is capable of storing voluminous amounts of information, sifting through the information at high speed, and is at the same time easily expandable or restructurable to take on new forms of entities and relationships.

In accordance with a first aspect of the invention, an entity definition table (ENT.DEF) is defined within the memory means of a computer system to store the name of an allowed entity type (class) and the name of a single other table

(Entity-instances Table or "EiT" for short) where instances of the allowed entity type may be stored. A separate relationships definition table (REL.DEF) is defined in the memory means to list in each row of the table: (a) the name of an allowed relations type, (b) the name of a single Relation-instances Table (RiT) where instances of the allowed relationship type may be stored, (c) the name of a primary (head) entity type to which the relation type may apply and (d) the names of one or more secondary (tail) entity types to which the named relationship may apply. Each row of the Relation-instances Table (RiT) is provided with at least one primary pointer which points to the storage location of a first instance of the primary entity type and at least one secondary pointer which points to the storage location of a corresponding first instance of the secondary entity type. Each row of the Relation-instances Table (RiT) further includes a pointer to a relationship-defining row in the REL.DEF table. The pointer can be the name of an applicable relation type as recorded in the REL.DEF table. Relationships between instances of a primary entity and a secondary entity are thus expressly defined by entries in the Relation-instances Table (RiT). Adding new rows to this Relation-instances Table (RiT) allows for the addition of new relations. Adding new rows to the REL.DEF table allows for the creation of new classes (types) of relationships. Since relation-defining tables can be updated using a fixed set of update modules, reprogramming at the source or assembly level is not needed for restructuring the schema of the database.

BRIEF DESCRIPTION OF THE DRAWINGS

The invention will be described with reference to the following figures in which:

FIG. 1A is a block diagram of a conventional database system.

FIG. 1B is a timing diagram showing the delay between the addressing and the delivery of storage data.

FIG. 2A is a block diagram of a conventional key-sequenced table organization.

FIG. 2B is a block diagram of a conventional relative-record table organization.

FIG. 3 diagrams a multiple table system which is based on a conventional relational database approach and which has key-sequence organized tables.

FIG. 4A is a conceptual diagram illustrating an entity-relation schema in accordance with the invention.

FIG. 4B is a further conceptual diagram of an entity-relation schema according to the invention.

FIG. 5 is a block diagram of an entity definition (ENT.DEF) table in accordance with the invention.

FIGS. 6A and 6B are block diagrams of a relationship definition (REL.DEF) table in accordance with the invention.

FIG. 7 is a connection diagram showing how relations may be explicitly defined in a Relation-instance Table (RiT) so that unique relations between instances of a first entity class and instances of a second entity class can be identified.

FIG. 8 is a block diagram of a database system according to the invention.

FIG. 9 is a block diagram of a relations processing engine according to the invention.

FIG. 10 graphs a variety of sample inquiry paths that may be followed by the engine of FIG. 9.

DETAILED DESCRIPTION

The following includes a detailed description of the best mode or modes presently contemplated by the inventor for

carrying out the invention. It is to be understood that these modes are merely exemplary of the invention. The detailed description is not intended to be taken in a limiting sense.

Referring to FIG. 1A, the block diagram of a conventional database system 100 is shown. The database system 100 comprises a central processing unit (CPU) 110 which is operatively coupled so as to be controlled by an access control program (object code) 120d stored in a first memory means 120 (i.e., read-only-memory, ROM, or random access memory, RAM). The CPU 110 in combination with the first memory means 120 can be viewed as one or more machine means for performing functions specified by the object code 120d. The CPU 110 is further operatively coupled to access the data 130d of a "bulk storage" second memory means 130 also included in the database system 100. Individual strings of digital information are represented by wiggled lines (e.g., 120d, 103d) in FIG. 1A. The bulk storage means 130 typically takes the form of a large array of magnetic disk drives, tape drives, or other mass storage devices (e.g., arrays of Dynamic Random Access Memory [DRAM] chips). The first (control) memory means 120 usually takes the form of high speed RAM and/or ROM.

To access a particular string of data 130d stored within the bulk storage means 130, the CPU 110 must provide a corresponding address signal 131s (FIG. 1B) in the form of logic highs (H) and lows (L) to the bulk storage means 130 over an address bus 131. As seen in the time versus logic-level graph of FIG. 1B, the address signal 131s (usually an electrical signal) comprises a set of logic high and logical low levels (H and L) transmitted in a first time period t_0-t_1 . There follows a second time period, t_1-t_2 , which is often referred to as an "access delay", during which addressing circuits attempt to access the addressed memory location. Depending on whether a memory read or memory write operation is occurring, data signals 132s are then transferred over a data bus 132 (FIG. 1A) from the addressed location within the bulk storage means 130 to the CPU 110 or vice versa during a following third time period, t_2-t_3 .

Referring still to FIG. 1A, the object code 120d of the access control program determines when and how the CPU 110 will access information 130d stored in the bulk storage means 130. The CPU 110 issues address signals 121s (not shown) over an address bus 121 to the first memory means 120, and in response, the first memory means 120 supplies instruction signals 122s (not shown) over a data bus 122 to the CPU 110. Information signals 122s can be exchanged bidirectionally over data bus 122 between the CPU 110 and the first memory means 120. FIG. 1B may represent the timing relation between address signals 121s and first memory information signals 122s by replacing reference numerals 131s and 132s with 121s and 122s, respectively.

It should be understood that neither the object code 120d of the first memory means 120 nor the data code 130d of the mass storage means 130 is in human-readable form. A translation machine is needed to convert the binary bit strings of either memory means (120 or 130) into a form which might be understandable to an experienced computer programmer or to a lay computer user.

The object code 120d of the access control program is produced by first generating (e.g., manually writing and encoding) a source code listing 112 whose lines of information 112d are usually understandable only to a highly trained computer programmer. The source code listing 112 which is written in an assembly level or higher level language (e.g., C, COBOL, FORTRAN, PASCAL, etc.) is transformed into machine-readable form, and passed through a first transla-

tion machine which may be referred to as a compiler (or assembler) means **114**. The compiler means **114** produces the machine-readable object code **120d** according to instructions provided by a machine readable version of the source code listing **112**. After it is stored in the first memory means **120**, the object code **120d** is expressed as machine detectable alternations (ones and zeroes) in a physical attribute (e.g., voltage) of the medium which makes up the first memory means **120**. In this form, the object code **120d** is more readily convertible into data signals **122s** which are understandable to the CPU **110** than into information which is understandable to a lay (non-programmer) person. It is highly improbable that a lay person will ever wish to access or understand or modify the object code **120d** stored within the first memory means **120**.

The information strings **130d** within the bulk storage means **130** are similarly expressed as alternations in the physical property of the storage medium making up the second memory means **130**. Some of the data strings **130d** represent "real" data which a lay-user may wish to access while others of the strings **130d** represent "ancillary" data such as sequencing keys, threading pointers or control codes which a lay-user is not interested in. The object code **120d** of the control program defines which is which.

When "real" data is to be extracted from the data strings **130d** within the bulk storage means **130**, read and understood by a lay person, a translation process similar to compilation (or more correctly de-compilation) needs to take place. Just like the compiler means **114** functions as a man-to-machine translator, the combination of the first memory means **120** and the CPU **110** defines a second man-to-machine search-and-translate machine **115** which is used to search through parts of the bulk stored data **130d**, extract relevant pieces of "real" data and convert the extracted data from machine-readable form into human-readable form. The human-readable output of the second translation machine **115** may be produced in the form of a query output listing **150** (e.g., on paper or on a video screen) as indicated in FIG. 1A.

If a lay user (defined here as someone other than a person who is an expert programmer familiar with details of the source listing **112**) wishes to obtain useful ("real") information from the bulk storage means **130**, the lay user will normally supply a query input **140**, in a form dictated by a so-called "structured query language" (SQL) to the CPU **110**. (In the illustrated example the user inputs the request string "Please find all books having attribute xxx," where xxx could be the relations "author's last name=Jones".) The combination of the CPU **110** and first memory means **120** (which combination forms the second search-and-translate machine **115**) process this query input **140** and in response, produces a series of address signals **131s** which are sent to the bulk storage means **130** and processes a series of data retrievals **132s** which eventually lead to the production of a corresponding query output listing **150**. (In the example, it would be a listing of all books whose author's name is "Jones".) The access control program **120d** is charged with the task of enabling various types of queries **140** and making sure that the queries do not violate basic rules of logic.

When the information **130d** within the bulk storage means **130** needs to be updated, by for example adding new books, a similar exchange occurs between the translating machine **115** and a lay user. The lay user supplies an update input **160**, again as dictated by a pre-specified structured query language (SQL), and in response, the translating machine **115** rearranges the data **130d** within the bulk storage means **130** to achieve the requested update.

Referring to FIG. 2A, a first embodiment **200** of the data base system **100** will be described in more detail. FIG. 2A schematically illustrates a section **130a** of the bulk storage means **130** according to embodiment **200** wherein some of the stored data strings **130d** are arranged to define a key-sequenced type of table. In a first record region (Record No. 1) of the table **130a** there is provided a first continuous data string **230** which is subdivided to have a first string portion **231** representing an author's name (illustrated as the contents of a rectangular box), a second string portion **232** contiguous thereto for representing a name threading pointer (illustrated as a second rectangular box coupled to the first rectangular box by an address proximity link P_{11}), a third data string portion **233** representing the book's title (which is linked to the second portion **232** by proximity link P_{12}), a fourth subsection **234** representing a title threading pointer (linked to box **233** by address proximity link P_{13}), a fifth subsection **235** representing the book's location (linked to box **234** by proximity link P_{14}) and sixth subsection **236** representing a location threading pointer (linked to box **235** by proximity link P_{15}).

The name threading pointer **232** is located directly adjacent to the author's name subsection **231** within the address space of Record No. 1, as indicated by address proximity link P_{11} and thus, there is an "implied" logical connection between the data contents of boxes **231** and **232**. The book's title subsection **233** is located directly adjacent to the name threading pointer **232** as indicated by address proximity link P_{12} . The combined, proximity linkage, P_{11} - P_{12} , "implies" a relationship between the contents of boxes **231** and **233**, namely that they apply to various attributes of a common book. This format repeats for data subportions **234**-**236**. Only boxes **231**, **233** and **235** contain "real" data which is useful to a lay person. The other boxes **232**, **234** and **236** of Record No. 1 contain "ancillary" data which is useful to the search machine **115** but does not provide the kind of "real" information sought by an inquiring lay person.

The implied relations between the "real" data boxes **231**, **233** and **235** of Record No. 1, arise only after "meaning" is assigned to all the boxes **231**-**236**. Such "meaning" comes from the operation of the search-and-translation machine **115** (FIG. 1). To understand this concept, assume that an automated "searching" machine (computer) **115/200** of embodiment **200** is examining the data string **230** held within the single Record No. 1. Assume further that this searching machine **115/200** includes means for assigning appropriate "meanings" to each of the data subportions contained in each of subsections **231**-**236** to thereby designate some as containing "real" data and others as containing "ancillary" (e.g., pointer) data. In that case the search machine **115/200** can scan horizontally across the record, parse the data string **230** into subsections of appropriate size and extract the name of the book's author, the book's title and the location of the book within the library, as desired. On the other hand, if the searching machine **115/200** does not possess information which tells it that box **232** is a threading pointer, box **233** is a title, etc., then all boxes will look alike to the search machine, there will be no "meaning" assigned and the search machine **115/200** will not be able to extract a desired piece of data. Thus, while not shown in FIG. 2A, it is to be understood that there is a cooperative relation between how the object code **120d** of the search machine **115/200** causes that search machine to access the parts of bit string **230** via the signal busses, **131** and **132**, how subportions of bit string **230** become designated as "real" or "ancillary" data, and how relations are implied between separate pieces of real data. The structure, meanings interrelations between

the parts of bit string **230** are intimately linked to the structuring of the object code **120d**.

In FIG. 2A, the bulk memory means section **130a** is shown to include additional record areas. (Record No. 2, Record No. 3, etc.) each having the same data structure (represented respectively as string **240** which comprises data subsections **241-246** and string **250** which comprises data subsections **251-256**). Although Record No. 1 is in physical proximity with Record No. 2, as indicated by physical (or address) proximity link $PR_{1,2}$, and Record No. 2 is in physical proximity with Record No. 3 as indicated by physical proximity link $PR_{2,3}$, the data items (**231-236**, **241-246**, **251-256**) within each record do not need to be examined according to this physical ordering. Instead, the name threading pointer **232** of Record No. 1 can represent the address of any other arbitrary record area within the bulk storage means section **130a** whose author's-name will serially follow the author's-name of box **231** during a search process. This is represented in FIG. 2A by the dashed logical link $L_{1,1}$ which points to some arbitrary record area, $Record.Addr_{1,1}$ of section **130a**. The name threading pointer of the referenced record, $Record.Addr_{1,1}$, can point to yet another arbitrary record. With this mechanism, a list which is sorted (alphabetically for example) according to author's last name may be formed even though the records are not physically ordered in any specific sequence. The list is referred to as a "key-sequenced" list in cases where, as here, the sequencing key (or sort key) is data stored in the boxes e.g., **231**, **241**, **251**, etc., of a table column.

The title threading pointers (**234**, **244**, **254**) of each record may be used to form a different key-sequenced path in which books are examined according to subject matter or alphabetically according to the book's title or according to some other ordering algorithm. The location threading pointers (**236**, **246**, **256**) can be similarly used to create a key-sequenced list which will identify what book is physically located next to what other book on the library's shelves.

For the sake of illustrative simplicity, only one threading pointer (i.e., **232**) is shown attached to each real data item (i.e. **231**) of each record, but it should be apparent that the author's name **231** may have many threading pointers, one for threading alphabetically according to last name, and others for threading according to additional relations such as geographic location, age, number of published books and so forth. It is up to the computer programmer and the access control program **120d** to assign "meaning" to each box and thus determine whether that box will function as a storage area for real data or for ancillary data such as pointer data.

The records of FIG. 2A may be visualized as being serially stacked one on the next according to a sequence defined by a preselected one of the threading pointers (e.g. **232** or **234** or **236**) to thereby create a displayable table which has as entries in the columns of each row, the real data items: author's name **231**, book's title **233** and book's location **235**. The ancillary threading pointers **232**, **234**, **236** are hidden from the lay user's view. New rows are added to the table by breaking a logical link (e.g., $L_{1,1}$) between a preceding pointer (e.g. **232**) and a next pointer (e.g. **252**) to insert a new record in the search path. The rows can be of variable length since the linking address pointers can point to any arbitrary location in the bulk memory means **130**. To get to the N^{th} item of a threaded list, one normally sequences from the beginning of the list (table) through all the threading pointers until the N^{th} access is performed, at which point the contents of the addressed record area can then be read. For relatively large tables (e.g. those having thousands of rows), this process of sequencing through all the threading pointers to reach the N^{th} row of a table can take a significant amount of time.

Referring to a second embodiment **260** shown in FIG. 2B, the structure of an older and less sophisticated data organizing system will be described. In a bulk memory section **130b** of this older system **260**, data is organized according to what is commonly referred to as "relative table" addressing. Threading pointers are not used for logically linking one record (row) to the next. Instead, each data string (e.g., **270**) can be shrunk to contain only the essential target information, such as in this example, author's name (**271**), book's title (**273**) and book's location (**275**), with one item of real data being physically located adjacent to the next. The examination of all record items in this structure **260** may be performed according to the physical location of each record (**270**) within the address space of bulk storage area **130b** (the next adjacent string **280** follows first string **270** and so forth). Unlike the purely key-sequenced organization of FIG. 2A, the physical proximity links $PR_{0,1,2}$, $PR_{0,2,3}$, $PR_{0,3,4}$, etc., of FIG. 2B do indicate a particular ordering of the stored information.

The relative-table organization is somewhat similar to the way that index cards are physically ordered in a manual library system according to author's last name, except that the library catalog trays should now be visualized as having sequentially arranged grooves defined on their bottom-inner surfaces. Each groove is numbered according to its absolute position and only one card can be slotted into each groove. With this system, each card can be immediately located by its groove number rather than by thumbing through the information of all previous cards. If a groove number is known, substantial time can be saved in locating the corresponding card and obtaining the information written on its face. If the groove number is not known, the same relative-table organization can be searched by sequentially thumbing through the trays and examining the cards according to a key-sequenced approach in order to find a desired card even though the cards are stored in grooves. The relative-table organizing method is not mutually exclusive of a key-sequenced examination method. There is a difference between a purely key-sequenced table and a relative table, however. A relative-table organized system is not as easily updated as is a purely key-sequenced system. In the relative table system, a new card cannot be inserted between two cards which already fill adjacent slots. This inflexibility has led many in the database management field away from the relative-table method and towards purely key-sequenced systems since the latter can accept any number of new cards for insertion between old cards.

In FIG. 2B, all the record areas are of a fixed and pre-defined length. The fixed length of each record defines the groove size. To access the N^{th} item of a "relative-table" type of list **130b**, one need only multiply the fixed record length by the value N to directly obtain the physical address (slot) of the desired record. There is no need to sequence through a chain of threading pointers in order to find a desired row once its slot number (groove number) is known. Empty slots **290**, such as the slot number **4** shown in FIG. 2B, are preferably scattered throughout the address space of the bulk memory section **130b** to allow for occasional insertion of new items.

It should be noted that while the relative table organization **130b** of FIG. 2B is neither as flexible nor as easily updated as the key-sequenced organization **130a** of FIG. 2A, the relative-table structure **130b** has one major advantage over the key-sequenced structure **130a**; an N^{th} item in a relative-table list **130b** may be accessed much faster than the N^{th} item of a key-sequenced list **130a**.

FIG. 3 is a block diagram of a bulk storage area **130c** whose data **130d** is organized according to a known key-

sequenced scheme which is often referred to in the industry as a “relational” database. A “tables” area **300** contains a plurality of tables **310**, **320**, **330**, **340** and **350**. Each of these tables is defined purely by a threaded-list, key-sequenced structure such as shown in FIG. 2A. For the sake of illustrative brevity the list threading pointers (i.e., **232**, **234**, **236**) are not shown. Only the non-threading boxes (i.e., **231**, **233**, **235**) are shown.

Rows are illustrated to extend horizontally (in the “x” direction) in FIG. 3 while table columns are illustrated to extend vertically (in the “y” direction). Each table **310-350** is shown to have its respective rows sorted numerically according to “key” numbers that are stored in its leftmost column (referred to here as the “sort column”).

A first of the key-sequenced tables, **310** (also labeled “Table of Names”), is shown to have two columns. One (right side) column **312** holds “real” data representing the names of various persons while a preceding (left side) column **311** holds unique key-numbers, 1, 2, 3, . . . , N, N+1, N+2, . . . , each associated with a unique name of a person. The association of a person’s name to a key-number is “implied” by the fact that the key number 1, 2, 3, . . . , N, . . . , is located in the same row of table **310** as is the corresponding “Person’s Name”. Each key-number of left column **311** is referred to as a “Name Identification Number” (abbreviated here as N-IDN). Table **310** is shown to have been pre-sorted according to the N-IDN’s of column **311**. The sorting method is indicated in FIG. 3 by positioning the initials “KSO” over column **311** to tag that column as the Key-Sequenced-Ordering column of table **310**.

To find the name of a person within table **310** whose associated identification number is known to be N, one normally starts at row number 1 of the left column **311**, where the N-IDN of the first person’s name is stored and threads downwardly (in the y direction) through the threaded-list pointers (not shown) associated with this sort column **311**, testing each corresponding entry of column **311** for a match until the position holding the number N is found. Then one moves horizontally (in the x direction) across that row to the right column **312** to extract the name associated with the Nth name identification number (N-IDN).

When an automated search machine **115** performs this thread and test process, it must retrieve data from the memory area **130c** at least N times before the target data (Person’s-Name) is retrieved. The time for retrieving the target data is thus at least N times the access delay period (e.g., the t_2-t_1 , period of FIG. 1B) of the memory means **130**. By way of example, if N=1000 and the access time of memory means **130** is 30 milliseconds, then it can take 30 seconds or more just to retrieve one name. If a thousand names are to be randomly retrieved at different times from the range N, N+1, N+2, . . . , N+M (where M would be 1000 or higher), then it can take as much as 30,000 seconds (8.3 hours) or longer just to perform this simple table look-up task.

The N-IDN field of each row is generally made much shorter in bit length than its associated Person’s-Name field. The N-IDN can be viewed therefore as an abbreviation of a person’s full name. The first table **310** can be viewed as a conversion list or look-up table which allows one to easily convert a given abbreviation (N-IDN) into a full name.

A second, separate, table **320** (also labeled as “Table of Locations”) is shown to contain two similar columns. Right column **322** stores “Home Addresses” in full while left column **321** holds unique, Home-Identification-Numbers (abbreviated H-IDN) which are generally shorter in bit length than the associated “Home-Address” fields. The

H-IDN’s thus can serve as abbreviations for the full address fields. Table **320** is ordered numerically according to the H-IDN’s as indicated by the legend “KSO” over column **321**. The table **320** can therefore easily serve as part of an H-IDN abbreviation to full address converting means.

Since many people often live at a single home address, it is plausible that a single home address will be shared by persons of different names. Relational database theory recognizes this and teaches to separate information (e.g., home address) that might be shared by many entities away from any unique one of those entities (e.g., person’s name). Table **310** is accordingly separated from table **320**. Concurrently, it should be possible to relate a person’s full name to a full home address without having to repeatedly duplicate the full name string or full address string within the bulk storage means **130**. The data organization **300** shown in FIG. 3 includes a third key-sequenced table **330** which is structured for doing just that; linking one persons’ name with one home address while using the abbreviated bit strings, N-IDN and H-IDN.

Third table **330** comprises three vertical columns, **331**, **332** and **333**. Left columns **331** holds Person Identification Numbers (P-IDN’s), 1, 2, 3, . . . , P. The rows of third table **330** are sorted using the P-IDN’s as the sort key. For each row of the third table **330**, the second column **332** contains a Name-IDN and the third column **333** contains a Home-IDN. Each Name-IDN of third table **330** (for example, at row 4 of table **330** whose column **332** contains the value “N”) should have in the left column **311** of the Names table **310** a matching key number (e.g., the number N which is pointed to by arrow L_{41}). Thus an N-IDN stored in the third table **330** can be used to indicate the row within the first table **310** where a person’s full name may be found. Each Home-IDN of the third table **330** should similarly have a matching key number (e.g., the number 2 which is pointed to by arrow L_{43}) within left column **321** of the second “Locations” table **320** at whose row a corresponding full home address may be found.

Each row (e.g., row 4) within the third table **330** implicitly creates a set of logical links or “relations”, L_{41} - P_{42} - L_{43} which join a person’s name to a particular home address. These links, L_{41} , P_{42} and L_{43} are represented in FIG. 3 by dashed connecting lines which, in combination, join the Person’s-Name held in table **310**, row N, to the Home-Address held in table **320**, row 2. The implied linkage, L_{41} - P_{42} - L_{43} , does not arise from the contents of the first three tables, **310**, **320** and **330** taken alone. The key numbers (e.g., N-IDN, H-IDN, P-IDN) that are held within these tables are by themselves a meaningless series of numbers. It is only when randomly distributed modules of object code **120d*** stored within the memory means **120** of this “relational database” system (**300**) cooperatively interact with the CPU **110** that the implied relations come into being. The object code **120d*** instructs the CPU **110** to select a specific row (i.e., row 4) in the third table **330**, to extract the numbers from adjoining columns **332** and **333** of that row (thus implying the proximity link, P_{42}), to select table **310**, to sequence down its KSO column **311** looking for a match to the number from column **332** (thus implying logical link L_{41}), to select table **320**, to sequence down its KSO column **321** looking for a match to the number extracted from column **333** (thus implying logical link L_{43}), and to then extract from each respectively matching row of tables **310** and **320** the corresponding person’s full name and full home address. It is only by performing these data processing steps, as directed by the object-code **120d***, that the search-and-translation machine **115** or embodiment **300** is able to link (L_{41}) an otherwise meaningless number (N) held in the third table **330** to a

specific row (i.e. the row holding the same number N) positioned in another table (310) and to link (L_{43}) further numbers (i.e., the number "2" in col. 333) of the third table 330 to a specific row (i.e. the row holding the same number 2) of yet another table (320). This object-code dictated linkage L_{41} - P_{42} - L_{43} then implies a "relation" between the Person's-Name field stored at row N of table 310 and the Home-Address field stored in row 2 of table 320. Arrow L_{xx} denotes that all illustrated linkages (L_{41} - L_{48}) in FIG. 3 spring forth from randomly-distributed object code modules 120d* of the access control program 120d. Note that the third table 330 assumes by its three column structure a one-to-one cardinality between person-name and home-address. It is assumed that a person can have only one home address. The structure of table 330 is incapable of handling a situation where a person has, for example, both a summer home-address and a winter home-address. Restructuring of the third table 330 would be called for if it becomes desirable to associate each person's name with more than one home address.

A number of advantages come from organizing the tables of data storing area 300 separately according to relational database theory. Storage space is conserved in cases where plural entities of a first type (person) are related to a common entity of a second type (home address). The same Home-IDN can appear many times down column 333 without consuming large amounts of memory space while the actual full address is stored only once in second table 320. When a person moves to a new home address, the corresponding Home-IDN in column 333 can be easily altered to point to a new position within the second table 320 which contains the new home address (e.g., H+1) thereby implying the new person-to-address relation. If a person changes their name (i.e., by way of marriage) the home address can remain the same. Only the first table 310 needs to be modified and updating working is thus minimized. Also, the basic listings "Names" 310 and "Addresses" 320 can be used to imply a wide variety of "relations" other than a relation between a person's name and his/her home address using the same abbreviated set of identification numbers (IDN's).

By way of example, assume that the first three tables, 310, 320 and 330, are used by a business institution (company) to keep track of the names of their employees and the corresponding home addresses of these employees. Let it be supposed that many employees need to commute to work by a privately-owned car. Some employees drive their own car, some drive a car owned by another employee and some are merely passengers. Let it be further assumed that after tables 310, 320, 330 are defined in a mass storage means 130, the company decides to also keep track of which person drives which car, which person is a passenger in which car and further, who the owner of the car is.

A fourth table 340 (Table of Drivers) may be constructed as shown in FIG. 3 to have a first key-sequenced column 341 storing plural driver identification numbers (abbreviated here as D-IDN's), 1, 2, 3, . . . , D. A second column 342 is provided for holding person identification numbers (P-IDN's) and a third column 343 is provided for holding car identification numbers (C-IDN's). A fifth table 350 (Table of Cars) may be similarly constructed as shown with a first KSO column 351 for holding the C-IDN's (1, 2, 3, . . . , C) with a second column 352 for holding owner identification numbers (O-IDN's) which will point to the one person who owns the vehicle and with a third column 353 for holding a vehicle serial number (SN). While not shown, it should be apparent that a sixth table (Table of Passengers) would be constructed with the same organization as that of fourth table 340 to identify passengers and their corresponding car.

Referring to row D of table 340, it can be seen that one implied link L_{44} identifies driver D as being the person of P-IDN=4 who has the name implied by earlier link L_{41} and the home address implied by earlier link L_{43} . Proximity link P_{45} implies that driver D drives the car having C-IDN=2. The latter number implies a logical link L_{46} to row 2 of table 350 which holds the serial number (SN) of the driven car. BY way of another proximity link, P_{47} , in row 2 of the same fifth table 350, a further logical link, L_{48} , indicates that the owner of car C-IDN=2 is the person P-IDN=P of table 320. It was assumed by the structure of table 359 that each car can have only one owner and one serial number.

Consider, however, what happens if a new government regulation comes into being allowing for more than one owner per car or requiring multiple identification numbers for each car. The fifth table 350 may have to be restructured to add new columns (i.e., 354, 355, etc.; not shown) which would allow for the implication of such new relations. This means that the access control modules 120d* which define the "meaning" of each data field (subsection) within table 350 would have to be revised. Referring back to FIG. 1 it can be seen that modification to the control code 120d* will usually occur first in the original source code 112, which is then compiled 114 as indicated in FIG. 1, debugged to correct programming errors (not shown) and thereafter repeatedly compiled 114 and debugged until all apparent errors are removed. The process of restructuring relations within a relational-type database system (300) therefore tends to be time-consuming, costly, and prone to error.

A newer form of database organization, referred to sometimes as the "object oriented" approach, has been proposed to solve some of the problems associated with reorganizing and updating previous database systems. According to the object-oriented approach, encapsulation bubbles are defined to hide from external view, data which is encapsulated within the bubble. Each bubble is referred to as an "object" and the encapsulated information of the object is referred to as the object's "attributes." One bubble may encapsulate a second bubble which in turn encapsulates third, fourth and further bubbles so that a relatively complex data structure may be defined. Objects can be assigned to "classes" and by such assignment they can be made to automatically "inherit" the attributes of other objects in the same class, even when the class attributes are changed after creation of the objects.

There is still controversy in the field over what constitutes "object oriented" and how such a concept may be practically applied to database management systems. Experimental versions of object-oriented systems are often too slow in performing update and inquiry servicing to be practical in commercial settings. The present invention takes an approach which might be considered a partial hybrid of the object-oriented approach and the earlier-described relational database methodology. It provides a database system which is capable of operating at commercially acceptable speeds and which is easily restructured as well as updated. The invention will be explained first conceptually and then by concrete examples.

Referring to FIG. 4A, there is shown a relation graph or "schema" 400 which contains three egg-shaped bubbles labeled respectively as "Customer", "Address" and "Account". These bubbles are not intended to represent "objects" from the object-oriented school of thought, but rather "classes" of entities. Each of these bubbles is referred to as an "entity type" or "entity class". The "Customer" entity class generically covers all entities which might fit under the broad descriptor "Customer", regardless of whether that entity is a natural person, a business

corporation, an association or so forth. The "Address" entity class covers all entities which fit under the broad descriptor "Address" regardless of whether the subject entity is a residential address, a business address, a post-office mailing address or so forth. Similarly, the "Account" entity class covers all sorts of accounts including savings accounts, checking accounts, trust accounts, etc.

Each entity bubble may contain one or more "instances" of the entity class (i.e., Customer, Address, Account) which it represents. By way of example, let it be assumed that there are three customers whose names are "Customer-A", "Customer-B" and "Customer-C". Let it be further supposed that because of a peculiar rule, the Customer bubble (also labeled as entity class "E-1") is restricted to contain the name of only one customer at a time, say "Customer-B", while the address bubble (E-2) can at the same time contain many "addresses", each corresponding to that Customer-B. If Customer-B is a person, the address instances might be summer-home and winter-home addresses. If Customer-B is the name of a business having a chain of stores, the plural addresses in the second bubble (E-2) might be the mailing address of those stores. The name "Customer-B" is an example of a first instance, $I_{1/E1}$, of the E-1 entity class and is illustrated conceptually in FIG. 4A as a small sphere $I_{1/E1}$ enclosed in the entity class bubble E-1. Three instances, $I_{1/E2}$, $I_{2/E2}$ and $I_{3/E2}$ of entity class E-2 are similarly illustrated as three spheres inside of entity bubble E-2. It is also assumed here that the Account bubble (E-3) is restricted by a peculiar rule so that at any one time it may contain only one account number (instance $I_{1/E3}$) which is somehow associated with Customer-B.

Until now we have been visualizing the instances, $I_{1/E1}$, $I_{1/E2}$, $I_{2/E2}$, $I_{3/E2}$ and $I_{1/E3}$ of respective entity classes, E-1, E-2 and E-3 as isolated spheres floating separate from one another, without identifying any specific relation between the instances. The present invention treats "relations" as being objects of equal substance to the entities they tie together. There are relation "classes" and instances of a specified relation class. Three arrow-shaped bubbles, R-1, R-2 and R-3, are shown in FIG. 4A to be respectively coupling the Customer entity class (E-1) to the Address entity class (E-2), the Account entity class (E-3) to the Customer entity class (E-1) and the Account entity class (E-3) to the Address entity class (E-2). These linking bubbles (R-1, R-2, R-3) are referred to here as "relationship" types or classes. Each relation bubble R-x (where x is an arbitrary identifier, 1, 2, 3, etc.) is visualized as having a bulb-shaped Head portion, H, an elongated body portion B and an arrow-shaped Tail portion, T. A "Head attribute" can be assigned by each relation bubble R-x to the entity bubble (E-h) located at its head end (H). A "Tail attribute" can be correspondingly assigned by each relationship bubble R-x to the entity bubble (E-t) located near its tail end (T). The combination of the Head-attribute, if any, plus the Tail-attribute, if any, can be used to give the relationship bubble (R-x) a "meaning". This meaning is generated by associating with the body portion B of each relationship bubble (R-x), a "meaning-string" which preferably, but not necessarily, has a head character-string and a tail character-string. The combination of an "entity-class name" (ECN-h) associated with the head entity type (E-h), the meaning-string (M-s) of the connecting relation type (R-x) and another entity class name (ECN-t) associated with the tail entity type (E-t) are concatenated according to the formula, (ECN-h)+(M-s)+(ECN-t), to expressly define a relational phrase. The expressly defined phrase can be modified by changing any one or all of its three components; (ECN-h), (M-s) and (ECN-t).

In more concrete terms, the top relation bubble R-1 is shown to have the meaning string "'s business". The substring, "'s" is a head character-string while the substring "business" is a tail character string. By itself, the meaning-string ('s business) appears to be nonsensical, but in conjunction with the class names its head and tail entities, E-1 ("Customer") and E-2 ("Address"), this first relations bubble, R-1, forms the relation phrase: "The Customer's business Address". Instance $I_{1/E1}$ is a specific customer's name (i.e., "Customer-B") and instances $I_{1/E2}$, $I_{2/E2}$ and $I_{3/E2}$ are now defined as specific instances of that customer's business addresses (i.e., the addresses of individual stores in a chain of stores owned by Customer-B).

Of importance, it is to be noted that the first entity bubble, E-1 (Customer), does not itself encapsulate the attribute of possession as indicated by the apostrophed head character-string "'s". Instead, that attribute of possession is encapsulated by the first relationship bubble, R-1. Furthermore, the second entity, E-2 (Address), does not encapsulate the modifying attribute "business". Instead that attribute is also encapsulated by the relation bubble R-1. Thus, each entity bubble (E-1, E-2, E-3) is free of any narrowing attributes or modifiers and instead, represents a relatively broad and generic listing of data items which can come under the heading of either "Customer" or "Address" or "Account". The advantage of this structure will become apparent shortly.

Consider for a moment what happens if the meaning-string in relation bubble R-1 is changed from "'s business" to "'s headquarters". Under this circumstance, the rules change. The address bubble (E-2) should be restricted to at any one time contain only a single instance (e.g., $I_{1/E2}$) representing the "Customer's headquarters Address" rather than many instances. Presumably each customer can have only one headquarters address. Thus, the "cardinality" of relations bubble R-1 must be changed from its earlier one-to-many {1:m} format, as was possible with business addresses, to a one-to-one setting {1:1}. According to the invention, each relation bubble, R-x, has a cardinality rule (e.g., {1:1} or {1:m}) associated with its body B as well as a meaning-string (e.g., "'s business").

Consider, next what happens in a business database if users are allowed to enter a customer name but leave out the mailing address or telephone number of that customer. Most companies operate under a strict rule which requires its office workers to record at least one forwarding address or telephone number when the name of a new customer is entered. To enforce this requirement, each relation bubble (R-1) further incorporates a mandatory-coupling character which can be either "Y" or "N" (representing yes or no). If it is required that at least one instance ($I_{1/E2}$) of a tail entity class E-2 should be created whenever an instance ($I_{1/E1}$) of a head entity class E-1 is created, then the mandatory-coupling character of relation bubble R-1 is set to "Y". This indicates that instance $I_{1/E1}$ should not exist without instance $I_{1/E2}$. The "MC" lightning bolt shown emanating from $I_{1/E1}$ represents this mandatory coupling of instances. On the other hand, if such coupling is not mandatory, the coupling character is set to "N" and there is no "MC" connection.

As further examples of the concepts behind the invention, the second relation bubble, R-2, is shown to contain in FIG. 4A the meaning string, "'s owning", the cardinality rule, {1:1}, and the mandatory-coupling character, "Y" (presumably every account should have an owner). The third relation bubble, R-3, is shown to contain the meaning string, "'s statement mailing", the cardinality rule, {1:1}, and the mandatory-coupling character, "N" (presumably an account holder can pick up his/her statement rather than having it

mailed). Instances of entity E-1 which satisfy the relationship created by relation bubble R-2 are read as "The Account's owning Customer". Instances of entity E-2 which comply with the relationship created by relation bubble R-3 satisfy the descriptive phrase, "Account's statement mailing Address", or stated otherwise, the address to which account statements are mailed for the particular instance $I_{1/E3}$ of the Account entity class E-3.

By changing the meaning-string within a relation bubble R-x, it is possible to create new relational phrases although the Head and Tail entity classes remain the same. By changing either or both of the Head and Tail entity classes (E-h or E-t), it is possible to again create new relational phrases although the relation bubble R-x remains unchanged.

Consider what happens for example when the meaning-string of relation bubble R-3 is changed to the phrase: "which is managed at bank branch having". Then the combination of the class names or meanings associated with entity bubble E-3, relation bubble R-3 and entity bubble E-2 provides for an inquiry path allowing one to find the Account which has a specific bank branch address as its managing branch. Consider what happens if the tail portion T of relation bubble R-3 were moved from E-2 to a new entity bubble (not shown) which is labeled "Managing Officer" rather than "Address". Then the relational phrase becomes "Account which is managed at bank branch having [this person as its] Managing Officer". It can be seen that an entirely different inquiry path is formed with each change of a head entity type, tail entity type or relation type.

Inquiry paths can be defined to extend through pluralities of entity and relation bubbles as well as between just two entity bubbles. Still referring to FIG. 4A, suppose that a bank officer finds an important document bearing only an account number on it. The bank officer needs to immediately contact a person who is authorized to manage that account for more details about the document. In such a case, the bank officer would turn to a database processing engine according to the invention (explained later with reference to FIG. 9), start at the known instance of the account number, $I_{1/E3}$, which is shown contained within the Account bubble (E-3), jump through the relation bubble R-2 ('s owner) to the Customer bubble (E-1) in order to learn who the owning customer is (instance $I_{1/E1}$) and then with that new information ($I_{1/E1}$) serving as a stepping stone, jump from the Customer bubble (E-1) through the relation bubble R-1 ('s business) to the Address bubble (E-2) to learn the address at which he may contact the account manager. This is merely an example, inquiry paths can include many more bubbles, they can branch out to form a tree rather than being serial and they can produce many pieces of information which are useful for solving a puzzle rather than just one piece of target information.

Relation bubbles (R-x) do not have to be single tailed. Referring to FIG. 4B, further variations of the concept behind the invention are illustrated. A fourth relation bubble, R-4, is shown to have a plurality of tail ends, T1, T2 and T3, so that a single meaning-string (e.g., "'s business") can simultaneously couple a common Head entity (Customer) to a plurality of Tail entities (e.g., Address, Account and Telephone). Moreover, a relation bubble does not need to span between different entity bubbles. FIG. 4B shows another relation bubble, R-5, which folds back in a loop so that the Head entity (Customer) is also the Tail entity. In the illustrated example, the relation bubble R-5 contains the meaning string "'s largest". Given the name of a first customer, this back-looping relation bubble R-5 allows one to find that customer's largest customer. The loop may be

followed around ad infinitum to obtain a long list of largest customers belonging to other largest customers.

With the above-mentioned conceptual models in mind, a concrete embodiment of the invention now will be constructed piece by piece. Referring to FIG. 5, there is shown a first table 500 which is referred to as an entity definition table or in abbreviated form, ENT.DEF Table 500. This entity definition table 500 is stored within a data storing area 130-RP of a database engine in accordance with the invention. Data storing area 130-RP preferably resides within a bulk storage means 130* such as diagrammed in later-to-be described FIG. 8. Unlike the earlier described tables 310-350 of the relational system shown in FIG. 3, which relied on a purely key-sequenced organization, the entity definition table 500 of FIG. 5 can rely on a relative table organization (abbreviated here as "RTO") which features faster data access properties and is also adaptable to key-sequenced search algorithms (but not key-sequenced update methods). Each row of the ENT.DEF table 500 is of a fixed bit length and has two columns. The first (left) column 500a stores a two character field (e.g., "CU," "AD," "AC" or "SU") which is an abbreviation of an entity class name. The abbreviation "EA" will be used here to mean "the abbreviated form of the entity class name" (Entity-name Abbreviation). By way of example, slot number 1 is shown to contain the two-character abbreviation "CU" (representing the entity name "Customer") in its left column 500a.

For expedience sake, a matrix notation is used here to identify the columns of table 500 with letters, a, b, c, . . . , etc. and the rows with a numeral preceded by a period. The symbol 500a.1 thus refers to the box in table 500 at column 500a and row 500.1.

As further seen in FIG. 5, the abbreviation "AD" is stored in box 500a.2 to represent the entity name "Address". Box 500a.3 holds the abbreviation "AC" for "Account" and box 500a.4 stores the abbreviation "SU" for "Supplier". The slot or row numbers, .1, .2, .3 and .4 of table 500 do not occupy storage space within memory means 130-RP. They merely represent the physical or logical address of their respective rows, 500.1, 500.2, 500.3 and 500.4.

In the corresponding right column 500b of the ENT.DEF table 500 there is stored, for each slot (.1, .2, .3, .4, etc.) the name of a single other table where instances of the named entity class are stored. The abbreviation "EiT" (Entity-instances-Table) will be used here to mean the table where instances of the entity class are stored. Again by way of example, box 500b.1 is shown to reference an EiT called "T.Companies" as the single table where instances of the entity class "Customer" are stored. The entry in box 500b.2 is "T.Addresses" and the entry in box 500b.3 is "T.Accounts". Note that the entry in box 500b.4 is "T.Companies" just as it is for box 500b.1. Instances belonging to two different entity classes (e.g., "CU" and "SU") may be stored in one instances table (EiT) under situations where the data structures of the instances are compatible to the structure of that EiT (e.g., the entity instances table has enough columns of appropriate widths to support the descriptions of each entity instance).

Each entity class can be referenced not only by its abbreviated name (e.g., EA="AD") but also by the slot number (e.g., slot .2) where it is stored in the entity definition table 500. The slot number may function as an "entity type number" (abbreviated here as ETN) for numerically identifying its corresponding entity class. Alternatively, an additional "type number" column (not shown) may be added to the ENT.DEF table, 500, unique type numbers may then be

entered into each row of the type number column and these can serve as the ETN's. Thus, the "Address" entity class may be referenced not only by the abbreviation EA="AD" but also by an entity type number whose value, ETN=2. For the relatively table organization (RTO) shown in FIG. 5, the ETN happens to be the same as the slot number (e.g. slot 500.2) where the entity name abbreviation (e.g., AD) is stored in the ENT.DEF table together with the name of the corresponding EiT (e.g., T. Addresses). For the case where an additional type number column (not shown) is added, the unique ETN's can be assigned arbitrarily such as according to the alphabetic ordering of the EA's in which case the ETN's may be used as sort keys for alphabetically ordering the ENT.DEF table rows according to entity class names (e.g. using threaded-list techniques).

Referring next to FIG. 6, there is shown another table 600 which is also stored within the data storage area 130-RP of an engine according to the invention. This table 600 may also have a relative-table organization (RTO) and it is referred to as a relations-definition table, or REL.DEF table 600 for short. As before, a matrix notation is used here to identify vertical columns of the REL.DEF table as 600a, 600b, 600c, etc.; horizontal rows as 600.1, 600.2, 600.3, etc.; and individual boxes as 600a.1, 600a.2, 600b.1, 600b.2, etc.

The left-most column 600a holds a two character abbreviation representing the class name and/or meaning-string of a relation bubble. The mnemonic, RA, will be used here to designate such a relationship abbreviation. By way of example, box 600a.1 holds the abbreviation "-BU-" which represents the meaning-string "'s Business". (Hyphens embrace the relation abbreviations here to distinguish them from entity abbreviations [EA's].) Box number 600a.2 stores the abbreviation "-OW-" to represent the meaning-string "'s Owing". Box number 600a.3 stores the abbreviation "-SM-" to represent the meaning-string "'s Statement Mailing". Box number 600a.4 holds the abbreviation "-HQ-" to represent the meaning-string "'s Main Headquarters".

Each row of the REL.DEF table 600 may also be identified numerically by a "relationship type number" (RTN) which in the illustrated example happens to be the same as the slot number (.1, .2, .3, etc.) where its corresponding two character code (-BU-, -OW-, -SM-, etc.) is stored. Alternatively, a type number column (not shown) may be added to the REL.DEF table 600 and unique RTN's may be assigned according to any desired, unique number generating scheme, such as according to the alphabetic ordering of the RA's. In the latter case, the RTN's can also function as sort keys for ordering the rows of the REL.DEF table (using threaded list techniques) alphabetically according to relationship class names (RA's). Thus, when given a specific RTN, one can quickly calculate the physical or sequence to the logical address in the REL.DEF table 600 where details about the corresponding relation class are stored so as to quickly retrieve those details.

In the second column 600b of the REL.DEF table, there is stored, for each slot (.1, .2, .3, etc.), the name of a single table where instances of the named relation class are stored. The mnemonic, "RiT" (Relation instance Table), is used here to represent such a table. By way of example, the entries in boxes 600b.1, 600b.2, 600b.3 and 600b.4 are respectively: "T.Rel-1", "T.Rel-2", "T.Rel-3" and "T.Rel-1". Note that the entries of box numbers 600b.1 and 600b.4 are the same. Compatible instances of two different relation classes may be represented by two corresponding rows of data stored in a common relation-instances holding table (RiT).

The third column 600c of the REL.DEF table stores the type number (ETN_h) of a head entity (E-h). Here, the entity

type number (ETN_t) is the same as an ETN assigned to a corresponding row in the ENT.DEF table 500 where the abbreviated class name (EA) of that head entity bubble is stored. Similarly, the fourth column 600d of the REL.DEF table stores the type number (ETN_{r1}) of a corresponding first tail entity (E-t1).

Note that the first three rows (600.1, 600.2 and 600.3) in FIG. 6A correspond to the relations schema shown in FIG. 4A. When row number 600.1 is read across using the column sequence: c, a, d, it corresponds to the relationship descriptor phrase "Customers'business Address". Box 600b.2 tells us that instances of this relationship are stored in an RiT table called "T.Rel-1".

Similarly, row number 600.2, columns c, a, d correspond to the relationship descriptor phrase "Account's owning Customer". Box 600b.2 tells us that instances of this relation are stored in table T.Rel-2. Row number 600.3 likewise corresponds to the relationship describing phrase "Account's statement mailing Address" and tells us that instances of this relation are found in the T.Rel-3 table.

The REL.DEF table 600 can be updated indefinitely by adding new rows to its bottom so as to encompass a great number of further relation classes. There is no need to physically order the data describing each of the relational classes and thus descriptions of new classes can be added to the bottom or other empty slots of the REL.DEF table 600 sporadically as the need arises over time. Relation classes which become obsolete can be deleted to leave behind an empty slot. Similarly, there is no need to order the entity classes defined by the ENT.DEF table 500. The ENT.DEF table can be updated by arbitrarily adding new entity class describing rows to its bottom or other empty slots or by deleting obsolete entries as the need arises. Accordingly, when demands on the database system of the invention change over time, new relation classes may be defined in combination with new head and tail entity classes. The schema of the invention can be continuously restructured as the need arises simply by updating the REL.DEF and ENT.DEF tables, 600 and 500.

The fifth columnar region 600e of FIG. 6A represents a plurality of additional columns within the REL.DEF table 600. The names of multiple tail entities which are activated in addition to or in substitution for the first ETN, of column 600d may be optionally entered in this region 600e. Referring briefly to FIG. 6B, an exploded view of this fifth region 600e is illustrated. In the example, each relation class R-x can have as many as five tail entities (T1, T2, T3, T4, T5). The invention is, of course, not limited to five. Columns 600d identifies the first tail entity, T1, while extension columns 602 through 605 in region 600e identify the optional, other tail entities, T2-T5. The opening phrase "Customer's business . . ." of slot number 600.1 columns, c and a, may apply to the first tail entity T1="Address" and/or to a second tail entity T2="Supplier" and/or to a third tail entity T3="Area", etc.

Extension region 600e is shown to include a tail activating column 606 which functions as a mask to activate or deactivate each of the corresponding tail entity columns 600d, 602-605. In the illustrated example, a dark filled circle means that the corresponding tail entity of that slot (row) is active while an unshaded circle means that the respective tail entity is deactivated. As an alternate embodiment, the mask column 606 may be dispensed with and the lack of an ETN entry (or a "null" entry) in a box of columns 602-605 will be regarded as indicating a deactivated tail while the inclusion of an ETN value will be regarded as indication an active tail.

When two or more tail entities are activated, the relation bubble takes on a multi-tailed form such as shown in FIG. 4B at R-4. The same meaning-string is applied to the plural tail entity bubbles of the activated tails. Multiple copies of a prespecified row in the REL.DEF table **600** may be added to empty slots within the table **600** in a boiler-plate stamping manner with only the tail activation masks **606** being modified or some ETN entries of columns **602-605** nulled from copy to copy in order to generate a wide variety of different relation classes.

Returning to FIG. 6A, the next column **600f** of the REL.DEF table holds a code indicating the cardinality of the corresponding relation bubble (e.g., {1:m} or {1:1}). The next following column **600g** contains a one character code indicating whether there is mandatory coupling (MC) between an instance of the head entity and an instance (or instances) of the tail entity (or active tail entities).

Referring to FIG. 7 a broader view **700** of a relation-processing storage area **130-RP** in accordance with the invention is now shown. Storage means **130-RP** is coupled to a data search-and-retrieval machine **815** by way of address bus **131** and data bus **132**. Starting at the bottom of FIG. 7, we see that two relative-organized (RTO) tables are shown: a T.Companies table **710** and T.Addresses table **720**. Both of these are Entity-instance Tables (EiT-1 and EiT-2, respectively). The T.Companies table **710** has one column **710a** in whose numbered slots (**710a.1**, **710a.2**, **710a.3**, etc.) are stored the names of various companies. The T.Addresses table **720** has one column **720a** in whose slots (**720a.1**, **720a.2**, **720a.3**, etc.) there are stored data fields representing various street addresses. Each piece of "real" data such as the name of a company (e.g., "Allen's Automobiles") is referred to as an "Entity-instance" or Ei for short. The slot number where the Ei is stored defines an "Entity-instance Number" or EiN for short.

The broader view **700** reveals a third table **730** which is labeled in FIG. 7 as the T.Rel-1 table and also as RiT **730**. Each of the numbered slots, **730.1**, **730.2**, . . . , **730.6**, etc., in this "Relation-instances Table" (RiT) **730** has five columnar entries. They are respectively: (a) a head entity-type identifier [ETN_h], (b) a head-entity instance identifier [EiN_h], (c) a relationship class identifier [RTN], (d) a first tail entity-type identifier [ETN_s] and (e) a first tail-entity instance identifier [EiN_s]. For the sake of illustrative clarity two-character abbreviation identifiers are shown entered in the vertical columns **730a**, **730c** and **730d** of the T.REL-1 table **730**. It is within the contemplation of the invention to alternatively enter the corresponding entity or relation type number (ETN or RTN) for these two-character abbreviations. This allows the retrieval machine **815** to quickly and directly access the corresponding row of the ENT.DEF or REL.DEF table where data of interest is stored using either relative-table or key-sequenced access techniques.

Columns **730a** and **730b** in combination identify particular instances of a head entity class (Head Ei) while columns **730d** and **730e** in combination identify particular instances of a tail entity class (Tail Ei). Referring specifically to box number **730a.2** of the T.REL-1 table **730**, the "CU" (or alternatively ETN_h=0.1) entry of this box directs the data retrieval machine **815** of the invention to a first section **500.1** of the ENT.DEF table where there is stored the name of a first table (EiT-1="T.Companies") where instances of this named entity class ("CU") are stored. The logical link from third table (RiT) **730** to table area **500.a** is labeled as L₇₃₁. The link from table area **500.1** to the first table (EiT-1) **710** is labeled as L₇₅₁.

The second column **730b** of the T.REL-1 table holds the slot number or "Entity-instance Number" (EiN=.5 of box

730b.2 for example) of the indirectly referenced Entity-instances table (T.Companies **710**) within which a specific instance (Ei="Expert Electronics") of the named head entity class (EA="CU") is stored. In this example, box number **710a.5** of the first EiT **710** contains the name "Expert Electronics" and this name-string is the entity instance referenced by the "CU.5" entries of boxes **730a.2** and **730b.2**. The link from box **730b.2** to box **710a.5** is labeled as logical link L₇₃₂.

Referring to columns **730d** and **730e** of slot number **730.2**, a similar linkage is created to the instance of a tail entity class. In the illustrated example, the "AD" entry of box **730d.2** points to a second section **500.2** of the ENT.DEF table (thereby defining link L₇₃₂) where a second pointer is found to a second Entity-instances Table (EiT-2) which in this example is the T.Addresses table **720** (thereby defining link L₇₅₂). Box **730e.2** holds the slot number (.4) of the indirectly referenced table **720** in which the target data "555 Transistor Lane" is stored (thereby defining link L₇₃₄). Thus, the illustrated Relationship-instances Table (RiT) **730** defines a connecting relationship (extending from the arrowhead of L₇₃₂ to row **730.2** to the arrowhead of L₇₃₄) which joins the instance "Expert Electronics" of entity class "Customer" (CU) with the instance "555 Transistor Lane" of the "Address" (AD) entity class. Each row of the RiT **730** is referred to as a "Relation-instance" (abbreviated as Ri) and the slot number of that row defines a corresponding "Relation-instance Number" (RiN). (while not shown, it is within the contemplation of the invention to add a "instance number" column to any of tables **710**, **720** or **730** so as to uniquely identify their rows by arbitrarily assigned instance numbers, EiN or RiN, rather than relying on an RTO slot number, but the RTO slot number approach is believed to result in faster data access.) Columns **730a-730b** accordingly define the head portion of a "Relation-instance" (Ri) and columns **730d-730e** define a tail portion of the relation-instance (as conceptually shown in FIG. 4A). Column **730c**, as will now be seen, defines the body portion of each Relation-instance (Ri).

Referring to the middle column, **730c**, of the T.REL-1 table **730**, this column holds an identifier pointing to a corresponding row in the REL.DEF table **600** where the relationship class of the instant relationship (Ri) is defined. For the sake of illustrative clarity, the RA of each relation class is shown entered in column **730c**. It is within the contemplation of the invention to alternatively enter the corresponding slot number, RTN, of the REL.DEF table **600** so as to speed the access time of the retrieval machine **815**. By way of example, the entry "-BU-" in box **730c.2** indicates that the relationship between the head instance, Customer.5, and the tail instance, Address.4, is the "'s Business" meaning-string associated with slot **600.1** of the REL.DEF table (FIG. 6).

The relation instances table, T.REL-1 **730**, may contain many rows, each of which has the identical head entity-instance entries (in col.s **730a** and **730b**), identical tail entity-instance entries (in col.s **730d** and **730e**), but different relationship-defining entries (e.g., -BU-, -HQ-, -OW-, etc.) in column **730c**. Each of these almost identical rows would represent a different Relation-instance (Ri). As an example, the address instance AD.4 might be the "Business" address of customer instance CU.5 as shown in slot **730.2**. But it may also be the headquarters address "-HQ-" of that same customer CU.5 as shown in slot **730.6**. Each of these is considered a different relation instance (Ri). The T.REL-1 table **730** is accordingly shown to include two separate row entries: **730.2=Cu.5-Bu-Ad.4** and **730.6=Cu.5-HQ-AD.4**. A relational query which asks the question, "What is the head-

quarters address of my customer, Expert Electronics?" would be answered by accessing row **730.6** of the T.REL-1 table **730**. The slightly different relational query, "What are all the business addresses of my customer, Expert Electronics?" would be answered by accessing all rows in the T.REL-1 table **730** beginning with the entries, "Cu.5-BU-", which in the illustrated case includes rows **730.2** and **730.5**.

With the illustrated structuring of a Relation-instances Table (RiT **730**), all sorts of relational inquiries can be answered by starting with a known first instance of a first entity class, irrespective of whether the class is a head entity class or tail entity class, and searching through the RiT **730** to locate all relationship-instances (Ri's) of which that starting instance is a member. Once the matching Ri rows are found within a designated Relation-instances Table (RiT), it becomes a simple matter to scan horizontally across the row from the starting instance through the relation descriptor of column **730c** to find the corresponding, but until now, unknown instances of the opposed tail and head entity classes.

The uncovered instances can then serve as stepping stones for answering further parts of a compound query. Consider for example, the two-level query, "What are all the business addresses of my customer Expert Electronics, and once you know that, what other customers use those addresses as their business addresses?" There may be a plurality of business addresses satisfying the first part (Level-1) of the question and each such answer would serve as a new stepping stone leading to the answers which satisfy the second part (Level-2) of the question.

In accordance with the invention compound queries are answered by defining one or more question lines in an inquiry-definition (INQ.DEF) table **740**. Each question line is identified as belonging to either a one level question or to a particularly level of a compound question. A first column **740a** of the INQ.DEF table is provided for holding the entity type numbers (ETN) of one or more entity classes, regardless of whether they are known at the start of a query. A second column **740b** of the INQ.DEF table is provided for holding corresponding instance-identification numbers (EiN), again regardless of whether they are known at the start of a query. A third column **740c** is provided for holding one or more relation type numbers (RTN) while a fourth column **740d** is provided for holding corresponding relation-instance numbers (RiN), some of which may be known and others not known at the start of a query. Fifth column **740e** defines the level of each question row relative to preceding question rows.

An RTN value, which if known, is entered in a box of third column **740c** in order to indicate to the retrieval machine **815** a corresponding row in the REL.DEF table **600** from which the retrieval machine **815** can obtain the name of the single table (RiT-x) where all instances of the named relation type (RTN) reside. The identified table, RiT-x, can then be searched for one or more Ri rows which hold information relevant to a posed query. When found, the RiN values of those rows are entered into one or more boxes of fourth column **740d**. The specific Ri rows (e.g., row **730.2**) which are fully specified by filled in RTN-RiN data pairs of the INQ.DEF table **740** can then be accessed to direct the retrieval machine **815** to the corresponding head and tail entity instances of interest (e.g., the CU.5 and AD.4; instances which are related to one another by the -BU- entry of box **730c.2**).

If a specific Ri row is not fully identified at the beginning of a query within a row of the INQ.DEF table **740** by a

completed RTN-RiN pair, the Ri row or rows of interest can be nonetheless located by partially filling in a row within the INQ.DEF table **740** and then searching the REL.DEF or ENT.DEF tables for additional information. Row **740.2** of the INQ.DEF table is shown to have the question line, "??.-HQ-?" which may mean "Please identify the Headquarter addresses of all my customers". In such a case, all rows of the T.REL-1 table **730** which have the entry -HQ- in their middle column **730c** would provide the required information. Each such -HQ- row of RiT **730** would pair an identified instance of a Customer (head Ei) with an identified instance of a headquarters Address (Tail(1) Ei). It is to be appreciated that for cases of multi-tailed relation classes, the corresponding RiT would have columns for identifying the other tail entity instances (e.g. Tail(2) Ei, Tail(3) Ei, etc., not shown).

Sometimes a question is more specific. By way of example, let it be assumed that an inquiring user has a specific but fragmentary piece of starting information such as the street address "555 Transistor Lane". The inquiring user wishes to find out the names of one or more companies for whom "555 Transistor Lane" is a "Business Address". The user identifies the fragmentary information to the data retrieval machine **815** as belonging to the "Address" entity class. In response, the machine **815** searches through the ENT.DEF table **500** to locate the entity type number "ETN" of the named class and the Entity-instances Table "EiT" where all instances of this "Address" entity class are stored. It should be recalled that the illustrated relative-table organization "RTO" of the ENT.DEF table **500** is not mutually exclusive of a key-sequenced organization "KSO". According to the invention, the EA column **500a** of the ENT.DEF table is threaded alphabetically so that the row of a desired entity class (e.g., EA="AD") can be easily found using known key-sequenced search algorithms. A different table (not shown) can serve as an abbreviation to full name look-up table for converting between the entity name abbreviation (EA) and the full name or narrative description of the entity class (ECN) if desired or, alternatively, the ENT.DEF table **500** may include one or more additional columns (not shown) for providing this search and conversion function.

Once the corresponding type number (ETN) of the entity class is identified, in this case ETN=.2 referencing slot **500.2**, the retrieval machine **815** places this first puzzle piece into an appropriate box of the INQ.DEF table. In this example it will be box **740a.3** of INQ.DEF question line **740.3** which is for illustrative purposes filled with the corresponding EA="AD".

The retrieval machine **815** then obtains from box **500b.2** of the ENT.DEF table the name of the corresponding EiT where it is to search for the occurrence of the fragmentary information "555 Transistor Lane". The EiT's can be key-sequence organized (KSO) in addition to their RTO structuring to facilitate such searching. After the corresponding EiT (in this case, the T.Addresses table **720**) is searched and the row of the fragmentary information is found, its corresponding EiN, in this case .4, is entered as an entity-instance number (EiN) in box **740b.3** of the INQ.DEF table **740**.

The earlier found entity type number (ETN) which corresponds to EA="AD" now combines with the EiN=.4 of INQ.DEF row **740.3** to define the "starting instance" for resolving question line **740.3**. The starting instance is AD.4.

The relationship type number (RTN) of the relationship under question (-BU-) is entered in box **740c.3**. If the RTN value is not known, the REL.DEF table **600** is first searched to generate the appropriate RTN. While not shown, the REL-

.DEF table or some other table will include a full name or narrative column for converting between a relationship's full name/description and its abbreviated form (RA). Box 740d.3 is now the last puzzle piece to be filled in as indicated by a question mark in FIG. 7.

Since the ETN.EiN-RTN- entries of boxes 740a.3, 740b.3 and 740c.3 are now all known, the retrieval machine 815 searches through the corresponding RiT (T.REL-1 table 730) to locate all relation-instances (Ri's) which have the corresponding ETN plus EiN in the tail entity instances columns 730d and 730e and the corresponding RTN in column 730c. The REL.DEF table 600 identifies the starting entity class of the AD.4-BU-? question as being a tail entity. (When there is more than one tail entity, the RiT will have plural columns for identifying first, second, etc. tail instances and the REL.DEF table 600 will specify which of these tail columns is to be searched.) In the illustrated example, row 730.2 of the T.REL-1 table will be found to have matching information. The retrieval machine 815 can now fill the last empty box 740d.3 of the INQ.DEF row 740.3 with the information RiN=.2. Once question row 740.3 is completely filled, the retrieval machine 816 may use the information of this INQ.DEF row 740.3 to retrieve the detailed information about the head entity instance, Ei="Expert Electronics" from table row 710a.5 of the T.Companies table.

The ETN.EiN identifiers of the uncovered Level-1 answer, "Expert Electronics" can now serve as stepping stones which fuel a second part of a compound query. For example, the full query might have been "Who has business address, 555 Transistor Lane and what bank accounts belong to the entity or entities that satisfy the first part of this question?" The first part is defined here as "Level-1" of the question and the second part as "Level-2". Column 740e of the INQ.DEF table is shown to identify the level number. Referring to a feedback link L_{744} shown in FIG. 7, the Level-1 answer (ECN="CU" and EiN=.5) can now be fed back as an entry to a subsequent inquiry-defining row 740.4 so that the multi-level inquiry path may continue. Inquiry box 740c.4 is shown already filled with the relationship identifier (-OW-) for locating account owners. The answer to inquiry row 740.4 may be used to fuel yet a further level (Level-3, not shown) of a compound inquiry and the answer or answers to that inquiry may fuel yet further inquiry rows.

Referring to FIG. 8, a block diagram of a database system 800 in accordance with the invention is shown. Bulk storage means 130* is indicated to include a relation-processing region 130-RP in accordance with the invention. The bulk storage means 130* may also include previously-utilized relational tables for defining "implied" relationships between entities. Such "implied" relationships are not incompatible with the "explicit" relationships that are defined by the REL.DEF table 600 of the invention. As shown in region 130-RP of FIG. 8, the REL.DEF table and ENT.DEF table may be used to define a continuously expandable backbone which supports various relationships (RiT-1, RiT-2, etc.) between various entity instances (EiT-1, EiT-2, EiT-3, etc.). The INQ.DEF table may be visualized as having two legs (dashed vertical lines) which sequentially step from a starting instance table (EiT-1), across a starting table of relationship instances (RiT-1) to an explicitly linked table which holds relationship-opposed instances (EiT-2) of the starting instances. The opposing instances (of EiT-2) then become starting instances for a next inquiry step over yet a further set of relationship instances (RiT-2).

Since the REL.DEF and ENT.DEF tables may be expanded as desired by adding new entries to empty middle or bottom slots found within them, a lay user can create new

entities, new relation classes and restructure the schema of explicitly-defined relationships and entities forever without having to reprogram the database system 800 at the source or object code level. Instead, the lay user supplies schema restructuring commands, in an appropriate structured language, as indicated at 870 for restructuring the schema whenever needed. The screen control program 820d of the retrieval machine 815 may remain fixed while the entity-to-explicit-relationship schema of region 130-RP is forever changed. Accordingly, object-code compilation 814 needs to occur only once. The source code listing 812 of this access control program needs to be developed and debugged only once. Substantial cost savings are realized, especially as time progresses and new entity-relationship schemas are required.

In some commercial applications, the ENT.DEF table and REL.DEF table may be relatively short, having for example less than 1000 rows each (e.g., the ENT.DEF table may have 30 rows or less and the REL.DEF table may have approximately 100 rows or less). For such cases it has been found advantageous to "copy" the ENT.DEF and REL.DEF tables from the bulk storage means 130* to a higher speed memory area within first memory means 120 in order to shorten processing time. The copied versions of the ENT.DEF and REL.DEF tables can be purely-key-sequenced if an additional "type number" column is added for storing the respective ETN's and RTN's of each row. The higher data access speed of the first memory means 120 more than compensates for any speed reduction which might be caused by switching to a purely key-sequenced organization. These "mirror" copies of the ENT.DEF and REL.DEF tables are then accessed by the CPU 110 in place of the original ENT.DEF and REL.DEF tables. It is advisable to periodically check the original ENT.DEF and REL.DEF tables for possible revisions, since lay users may update that original tables at any time, and when such revisions are detected, to immediately recopy the ENT.DEF and REL.DEF tables into the first memory means 120 so that the mirror tables faithfully reproduce the contents of the original tables.

The CPU 110 in combination with the various modules of the object code 820d can be visualized as one or more machine means for performing data-altering functions as specified by the object code 820d. A Microfiche Appendix is included here listing sample modules written in Tandem COBOL'85™ and TANDEM SCREEN COBOL™ for execution on a Tandem NONSTOP™ computer system running under Tandem NonSTOP SQL™, TMFT™, Pathway™, SCOBOLX™ and Guardian™ systems (all available from Tandem Computers of Cupertino, Calif.). It is to be understood that the sample modules disclosed in the Microfiche Appendix are merely exemplary. The invention may be practiced using different computer hardware and/or software.

Referring to FIG. 9, a schematic diagram of an inquiry processing engine 900 in accordance with the invention is shown. The engine 900 comprises an inquiry guide means 910 which is coupled to a relationship defining means 960, a relationship storage and search means 970 and to an intermediate-answers receiving means 980. The intermediate answers means 980 feeds abbreviated answers back to the inquiry guide means 910 after such answers are produced by the relation storage means 970. Desired ones of all produced results are sent from the inquiry guide means 910 to an abbreviated results gathering means 915 which then expands them into full result details by sending an entity type signal $sETN_x$ to an Entity Define means 950 which includes within itself, the earlier described ENT.DEF table 500. The $sETN_x$ signal is converted by the entity define

means 950 into an entity table selecting signal sEiT which is fed into an entity storage means 920 that includes within itself a plurality of entity-instances tables (EiT-1, EiT-2, etc.) such as earlier described. Results gathering means 915 also feeds an instance row selecting signal, sEiN, to entity storage means 920. Details from the addressed entity instance row are then transmitted through a details filter 985 and portions of the details which are selected by the filter 985 are then printed on a detailed results display (e.g. a video monitor) 990.

Relationship inquiry in general is a two step operation: path selection (to create an Inquiry) and inquiry execution. On a Path Selection screen (not shown) the operator selects starting and optionally ending entity types and supplies detailed description of the path to follow. Each path is defined in terms of:

- a starting entity type to initiate the query path,
- a connecting relationship type which will lead to an intermediate entity type and then to another connecting relationship type and another intermediate entity type, and so forth until
- a last connecting relationship type leads to a terminating entity type

Taking out all but the key words from the above, we get the form structure:

```

-----
<starting entity type>
<connecting relationship type><intermediate
entity type>
<connecting relationship type><intermediate
entity type>
...
<connecting relationship type><terminating entity
type>
-----

```

A single inquiry definition may initiate several parallel paths which extend from a starting entity type to an ending entity type. When the ending entity type has not been specified in the header of the path-selecting screen then all these parallel paths can end with different entity types. For example, an inquiry to show a person's total involvement with all accounts held at a bank could be defined as shown in the following Table I:

TABLE I

Entity	Level-1 Relationship	Connected Entity	Level-2 Relationship	Connected Entity
Person --->	Account Holder	---> Account		
Person --->	Loan Guarantor	---> Account		
Person --->	Signatory	---> Account		
Person --->	Card Holder	---> Account		
Person --->	Group Member	--> Joint Party	---> Account Holder	---> Account
Person --->	Group Member	--> Joint Party	---> Card Holder	--> Account

Each of the above lines is a separate path generated by one inquiry form. The results of the inquiry would show all Accounts a Person had influence over, either directly or as a member of a partnership.

For simplicity the above inquiry is shown on the screen as in the following Table II:

TABLE II

Level	Relationship	Entity
5 1	Account Holder	Account
1	Loan Guarantor	Account
1	Signatory	Account
1	Card Holder	Card
1	Group Member	Joint Party
10 2	Account Holder	Account
2	Card Holder	Card

Note that level numbers are used to determine which entity types are intermediate to a path, which entity types terminate a path, and which relationship types commence a new parallel path. A line containing a level number which is the same as that of an immediately previous line indicates a parallel path separate from the previous line. A level number greater than that on the previous line indicates the entity on the previous line is an intermediate entity (i.e. the path is an association, and will follow several relationship links before terminating the path.)

Once a set of paths have been stored as an inquiry and recorded in the system it may be executed. Each unique set of inquiries is given a unique name, stored as such in the inquiry-definition table (INQ.DEF) and may be recalled for execution repeatedly at any time without need to go through the path selection process again. Before executing the pre-defined inquiry, the operator must select one or more starting entity instances for which the query is to run. Hence for each execution of an inquiry, the operator must choose which occurrence of the Starting Entity Type to use. Using the previous sample inquiry to investigate persons of the names, "John Smith" and "Bill Brown", the operator would execute the same inquiry once using "John Smith" as the Starting Entity instance and once using "Bill Brown" as the Starting Entity instance.

The Inquiry is executed by examining each of the defined paths in turn. Starting with the selected entity and following the first relationship, a list of intermediate (or target) entities is assembled. For each of the intermediate entities the next leg of the path is followed through the level 2 relationship etc. until the inquiry operation arrives at the ending entity type at which time the results of the entire path (with all intermediate entities and relationships) may be displayed to the operator.

If the ending entity type has been specified during inquiry definition, then at execution time the operator may select not only the starting entity occurrence of interest but also the occurrence of an ending entity. In this case the inquiry will return results from only the paths that satisfy this termination condition.

Reusable inquiry sets would normally only be created by privileged users. However, each inquiry set that is created for subsequent executions may be given its own security settings and attached to its own menu. Hence where sensitive data was involved, normal operators would be given access to only those inquiry sets they specifically need for their day to day business operations.

Despite its complexity, the inquiry engine **900** of the invention can operate at high speed because the EiT and RiT structures, while they may be large in size rely on relative tables. Relative table structures have always offered high performance for Random memory access (as opposed to key-sequenced access) but presented many complications and difficulties in other areas of use (e.g. updating). Because of this, conventional wisdom has been to use purely Key-Seqenced structures almost exclusively. Key-Seqenced structures pay performance penalties for the use of extra indexing levels.

The first problem with Relative structures was that with some early versions, deleted row locations (or slots) could not be re-used without file (table) reorganization. Reorganization of Relative structures in this case meant compressing the file (table) to regain unused slots. This process can change the relative addresses from their original values, which can cause corruption of the database. Reorganization is no longer required because Relative structures such as offered in Tandem's NonSTOP SQL™ system allow deleted row slots to be reused immediately. The Tandem system actually ensures that vacated slots are used again and again. Relative tables in NonSTOP SQL™ can be partitioned and re-partitioned without risk of corrupting the database, but table compression is no longer necessary or allowed. Partitioning a table means that the table can be split across a plurality of data storage devices, usually disks, transparent to the object code of the application program running under NonSTOP SQL™.

The second problem with Relative structures was implementing meaningful keys that allowed access to the data in a sequence based on indicative data, such as numerical order of account number or alphabetical order of customer name. However, by using Alternate Key index tables it is possible to provide meaningful sequential access of entities sorted within Relative Tables.

The Relationships Processor or "engine" of the present invention is a "Closed Loop" system in that all explicit schema definitions are stored within the system. The finite set of tables and their meanings are also defined within the system. This provides an infrastructure that makes the Table Structures transparent to users and developers. Hence, Relative tables can be used for performance improvements while avoiding any usability penalties that once existed.

Hence this invention has gone against conventional attitudes because of new data processing techniques used by the invention.

The above advances in Relative structure techniques, coupled with the closed loop nature of the Relationships Processor has allowed Relative tables to be used in a controlled and meaningful way, destroying the premise that Key-Seqenced structures are the best way to store relationships.

A benchmark was run on a Tandem NonSTOP SQL™ system to test the system's performance capabilities. The benchmark was to simulate the normal processing requirements of an extremely large bank's Customer Information System.

The database used 14 Gigabytes of disk storage space, and was populated with 5 million Customers, 7 million Cards, 9 million Addresses, 10 million Accounts and 67 million relationships.

The benchmark simulated 1000 simultaneous users (tellers), with each user executing 100 typical on-line transactions.

The invented system achieved a rate of 64 transactions per second with less than 2.6 second response time for 90% of all transactions which included all screen formatting. This is quite remarkable for a database system of this size and complexity.

The invented system was also benchmarked for batch processing at rates of hundreds of transactions per second. This shows that the system is able to process inquiries at commercially acceptable rates.

Referring to FIG. 9, an inquiry begins by transmitting a signal representing starting entity instance and relation information (e.g., "Level-1=ETN₁.EiN₁-RTN₁-?") from an input form means **901** to the inquiry guide means **910**. The data of this starting instances and relationship signal, **902**, is stored in an inquiry-defining table **740** provided within the inquiry guide means **910**. The inquiry guide means **910** transmits a starting relationship type signal sRTN₁ to the relation defining means **960** and a relationship instance defining signal sRi=ETN₁ and/or EiN₁ and/or RTN₁ to the relationship storage and search means **970**. The relation defining means **960**, which includes REL.DEF table **600**, transmits a Relation-instances table selecting signal sRiT₁ to the relationship storage means **970** in order to select one of a plurality of Relation-instances tables, RiT₁, RiT₂, RiT₃, etc. stored within the relation storage means **970**. The relation defining means **960** further transmits a head or tail identifying signal, H/T, to the relation storage means **970** to identify a head or tail instance defining column, Ei-h or Ei-t, which should be searched for information matching the ETN₁ and/or EiN₁ information of the starting instance signal, sRi. (While not shown, each RiT can have multiple columns specifying a plurality of tail entity instances, i.e., Ei-t1, Ei-t2, etc. and in such a case, the H/T signal also indicates which one or more tail columns of the target RiT are to be searched for matching information.) In response, the relationship storage and search means **970** searches through the selected relationship instances table RiT-x to find information matching that of the input signals, sRi, sRiT and H/T. Signals **971** representing the opposing entity instances (Ei-o) of each matched row are then transmitted to an intermediate answer gathering means **980** which compiles within its memory area a list of entity instances, Ei-o₁, Ei-o₂, Ei-o₃, etc., which oppose the starting entity instances found in matching rows of the referenced RiT (**730**). The collected intermediate answers are then fed back along path **981** to the inquiry guide means **910** in order to fill stepping-stone boxes (shown as still open question,?.??) in a next level query row (e.g. Lvl-2). The next query row (e.g. Lvl-2) now becomes the new starting row and its contained information, Ei-o₂-RTN₂?, is now fed as the new sRi signal to the relation storage means **970** and the relation define means **960**. The inquiry loop repeats until an inquiry path terminates on its own or a terminating entity is struck.

After termination, the results of the inquiry loop are fed through signal bus **911** to an abbreviated results compiling means **915** which orders the results according to their level number and interrelation. By way of example, a first Level-2 inquiry may produce intermediate answer, Ei-2a. That intermediate answer together with its forward-connecting relation (RTN₂) may produce a plurality of intermediate answers at Level-3, namely, Ei-32a.1, Ei-32a.2, etc. Each of these Level-3 answers may then result in a larger plurality of Level-4 answers (not shown) and so forth. Likewise the Level-2 answer Ei-2b may produce a plurality of Level-3

answers, Ei-32b.1, Ei-32b.2, Ei-32b.3, etc. Each of these answers is recorded as a paired set of an entity class number ETN and an entity instance number EiN. The abbreviated results are then expanded into user-understandable results by sending an entity type number signal, sETN_x to the entity definition means **950** and a corresponding entity instance signal, sEiN to the entity storage means **920**. In response the entity storage means **920** then produces detailed information from the referenced entity instances tables. Often, the database user may not wish to see all of the detailed information within a row, but rather wishes to see only prespecified columns of the referenced row and wishes the data to be displayed according to a predetermined display format. The details filter **985** filters out information from undesired columns and orders the remaining data according to a predetermined display format selected by the user. The desired "real" information then appears in the selected format on display means **990**.

Referring to FIG. **10**, it will now be explained how a single starting instance can lead to the production of a large plurality of answers. A database user has a first account number (instance I_{a/E1}) from which the user wishes to find all persons, groups or companies which are holders of that account, and once known, all other accounts held by those persons, groups or companies; and further, where a person is a member of a group or a group has many persons as its members or where a company has subsidiary companies, the accounts held by these entities. As shown in FIG. **10**, the relationship instance I_{a/R1}, has three tails, T1, T2 and T3, only one of which will be active for a given instance of the head entity I_{a/E1}. Tail T1 points to person instance I_{b/E2}. Tail T2 points to group instance I_{b/E3}. Tail T3 points to company instance I_{b/E4}. These instances of person, group and company represent intermediate instances which lead to the desired answer, namely, the accounts held by such persons. One person I_{b/E2}, may hold many other accounts as indicated by the multiple instances of the 's Holder relationship instances, I_{i/R1}, I_{j/R1}, I_{k/R1}, etc. Each of these relationship instances has a corresponding account instance at its head (H) end. In FIG. **10**, these are I_{i/E1}, I_{j/E1}, I_{k/E1} etc. The rest of FIG. **10** is self-explanatory. A person can belong to several groups and each of those groups may hold several accounts. A group may have many members and each of those members may have several accounts. A company may be a subsidiary of many other companies and each of those companies can hold several accounts. Thus, the list of ending instances shown in FIG. **10**, I_{i,j,k/E1}-I_{x,y,z/E1}, can be quite long compared to the starting instance I_{a/E1} which started the inquiry.

A variety of modifications will become apparent to those skilled in the art in light of the above description. The scope of the claimed invention is accordingly, defined, not by any specified embodiment described herein, but rather by the following claims.

What is claimed is:

1. A method for retrieving a desired entity of a desired entity type from a relational database, wherein said desired entity is related to a provided entity by a provided relation type associating an entity type of said provided entity with said desired entity type, said method comprising:

retrieving a specific relation type record defining said provided relation type from a relation definition table;

retrieving a specific relation instance record defining a relation of said provided relation type between said provided entity and said desired entity from a relation instance table corresponding to said specific relation type record;

retrieving a desired entity type record containing said desired entity type from an entity definition table, wherein said desired entity type record specifies a desired entity instance table associated with said desired entity type; and

retrieving said desired entity from said desired entity instance table.

2. The method of claim **1**, wherein said relation instance record specifies said desired entity by said desired entity type and a desired record identifier.

3. The method of claim **2**, wherein said desired entity is identified by said desired record identifier in said desired entity instance table.

4. The method of claim **1**, wherein said retrieving a specific relation [type] instance record [defining said provided relation type from a relation definition table] comprises:

retrieving a table identifier for said relation instance table from said specific relation type record; and

retrieving said specific relation instance record from said relation instance table based on said specific relation type record and said provided entity.

5. The method of claim **1**, further comprising retrieving data specifying said provided relation type from an inquiry table.

6. The method of claim **1**, further comprising retrieving data specifying said provided entity from an inquiry table.

7. The method of claim **1**, further comprising retrieving a second desired entity type record containing a second desired entity type from said entity definition table, wherein said second desired entity type record specifies a second desired entity instance table associated with said second desired entity type.

8. The method of claim **7**, further comprising retrieving a third desired entity type record containing a third desired entity type from said entity definition table, wherein said third desired entity type record specifies a third desired entity instance table associated with said third desired entity type.

9. The method of claim **1**, further comprising retrieving a second specific relation instance record defining a [second] relation of [said] a second provided relation type between said provided entity and said desired entity from a second relation instance table corresponding to said second provided specific relation type [record].

10. A relational database processing system comprising: an entity definition table containing a first entity type record defining a first entity type;

[an] a first entity instance table associated with said first entity type;

a plurality of entity instance records stored in said first entity instance table;

a relation definition table containing a first relation type record defining a provided relation type;

a first relation instance table associated with said provided relation type; and

a first relation instance record of said provided relation type, said first relation instance record relating a desired entity in one of said entity instance records to a provided entity.

11. The relational database processing system of claim **10**, wherein each of said entity instance records is identified by a record identifier.

12. The relational database processing system of claim **10**, wherein said first relation instance record contains a desired record identifier and a desired entity type corresponding to a desired entity instance record containing said desired entity.

35

13. The relational database processing system of claim 10, wherein said first relation type record comprises a table identifier identifying said first relation instance table.

14. The relational database processing system of claim 10, further comprising an inquiry table containing an inquiry record, wherein said inquiry record specifies said provided relation type and said provided entity.

15. The relational database processing system of claim 10 further comprising:

a second entity instance table associated with a second entity type; and

wherein said entity definition table contains a second entity type record containing said second entity type and associating said second entity instance table with said second entity type.

16. The relational database processing system of claim [10] 15 further comprising:

a third entity instance table associated with a third entity type; and

36

wherein said entity definition table contains a third entity type record containing said third entity type and associating said third entity instance table with said third entity type.

17. The relational database processing system of claim 10 further comprising:

a second relation instance table associated with a second [entity] *relation* type; and

wherein said relation definition table contains a second relation type record containing said second relation type and associating said second relation instance table with said second relation type.

18. The relational database processing system of claim [10] 17 further comprising:

a third relation instance table associated with a third [entity] *relation* type; and

wherein said relation definition table contains a third relation type record containing said third relation type and associating said third relation instance table with said third relation type.

* * * * *

UNITED STATES PATENT AND TRADEMARK OFFICE
CERTIFICATE OF CORRECTION

PATENT NO. : RE 40,520 C1
APPLICATION NO. : 90/008648
DATED : January 5, 2010
INVENTOR(S) : Doktor

Page 1 of 2

It is certified that error appears in the above-identified patent and that said Letters Patent is hereby corrected as shown below:

Title page should be deleted and replace with the attached title page.

On the title page, item (10) Number: should read -- US RE40,520 C1 --

Signed and Sealed this

Twenty-ninth Day of June, 2010

A handwritten signature in black ink that reads "David J. Kappos". The signature is written in a cursive style with a large initial 'D' and a stylized 'K'.

David J. Kappos
Director of the United States Patent and Trademark Office

(12) **EX PARTE REEXAMINATION CERTIFICATE (7285th)**
United States Patent
Doktor

(10) Number: **US RE40,520 C1**
 (45) Certificate Issued: **Jan. 5, 2010**

(54) **EASILY EXPANDABLE DATA PROCESSING SYSTEM AND METHOD**

(75) Inventor: **Karol Doktor, Wheelers Hill (AU)**

(73) Assignee: **Financial Systems Technology, Malvern, Victoria (AU)**

Reexamination Request:
 No. 90/008,648, Jun. 11, 2007

Reexamination Certificate for:
 Patent No.: **Re. 40,520**
 Issued: **Sep. 23, 2008**
 Appl. No.: **11/152,835**
 Filed: **Jun. 14, 2005**

Related U.S. Patent Documents

Reissue of:
 (64) Patent No.: **Re. 40,520**
 Issued: **Sep. 23, 2008**
 Appl. No.: **08/862,176**
 Filed: **May 22, 1997**

Related U.S. Application Data

(63) Continuation of application No. 08/439,207, filed on May 11, 1995, now Pat. No. 5,675,779, which is a division of application No. 08/083,861, filed on Jun. 28, 1993, now Pat. No. 5,604,899, which is a continuation of application No. 07/526,424, filed on May 21, 1990, now abandoned.
 (51) Int. Cl. **G06F 17/30 (2006.01)**
 (52) U.S. Cl. **707/4; 707/2**
 (58) Field of Classification Search None
 See application file for complete search history.

(56) **References Cited**

U.S. PATENT DOCUMENTS

4,506,326 A 3/1985 Shaw et al.
 4,774,661 A 9/1988 Kumpati
 4,918,593 A 4/1990 Huber

OTHER PUBLICATIONS

Toby J. Teorey, et al., "A Logical Design Methodology for Relational Databases Using the Extended Entity-Relationship Model", *Computing Surveys*, vol. 18, No. 2, pp. 197-222 (Jun. 1986).
 Daniel R. Dolk, et al., "A Relational Information Resource Dictionary System", *Computing Practices, Communications of the ACM*, vol. 30, No. 1 (Jan. 1987).
 M. M. Zloof, "Query-by-Example: a data base language", *IBM Systems Journal*, No. 4, pp. 324-343 (1977).
 D. Tsichritzis, "LSL: A Link and Selector Language", *Proceedings of the 1976 ACM SIGMOD International Conference on Management of Data*, Washington, DC, (Jun. 2-4, 1976).
 Rudolph Munz, "The Well System: A Multi-User Database System Based on Bunary Relationships and Graph-Pattern-Matching", *3 Information Systems*, pp. 99-115, Pergamon Press (1978).
 Peter Pin-Shan Chen, "The entity-relationship model—A basis for the enterprise view of data" 77 (1977).
 Mark L. Gillenson, "Database Step-by-Step", pp. 141-142, 2d Ed. (1990).

Primary Examiner—Alexander J Kosowski

(57) **ABSTRACT**

Machine automated techniques are described for a method of data processing called Relationships Processing. A computing system is disclosed which provides for the high speed recording and extraction of data objects (entities) and for the development data representing a queried relationship between the entities. The system is expandable to handle the relatively voluminous data bases of large, commercial data repositories. A user defines set of entities and allowed relationships between the entities. The user can expand this set of allowed entities and relationships at any time during the life of the system without reprogramming or compiling of computer program code or disrupting concurrent operational user of the system. Large systems can now be built that are no longer limited to a scope of design requirements known during initial systems development. For a given set of defined relationships the system allows the user to perform complex inquiries (again without programming at the code level) that would normally require multiple nested inquiries to be coded programmatically and would not achieve the performance levels of the Relationships Processor.

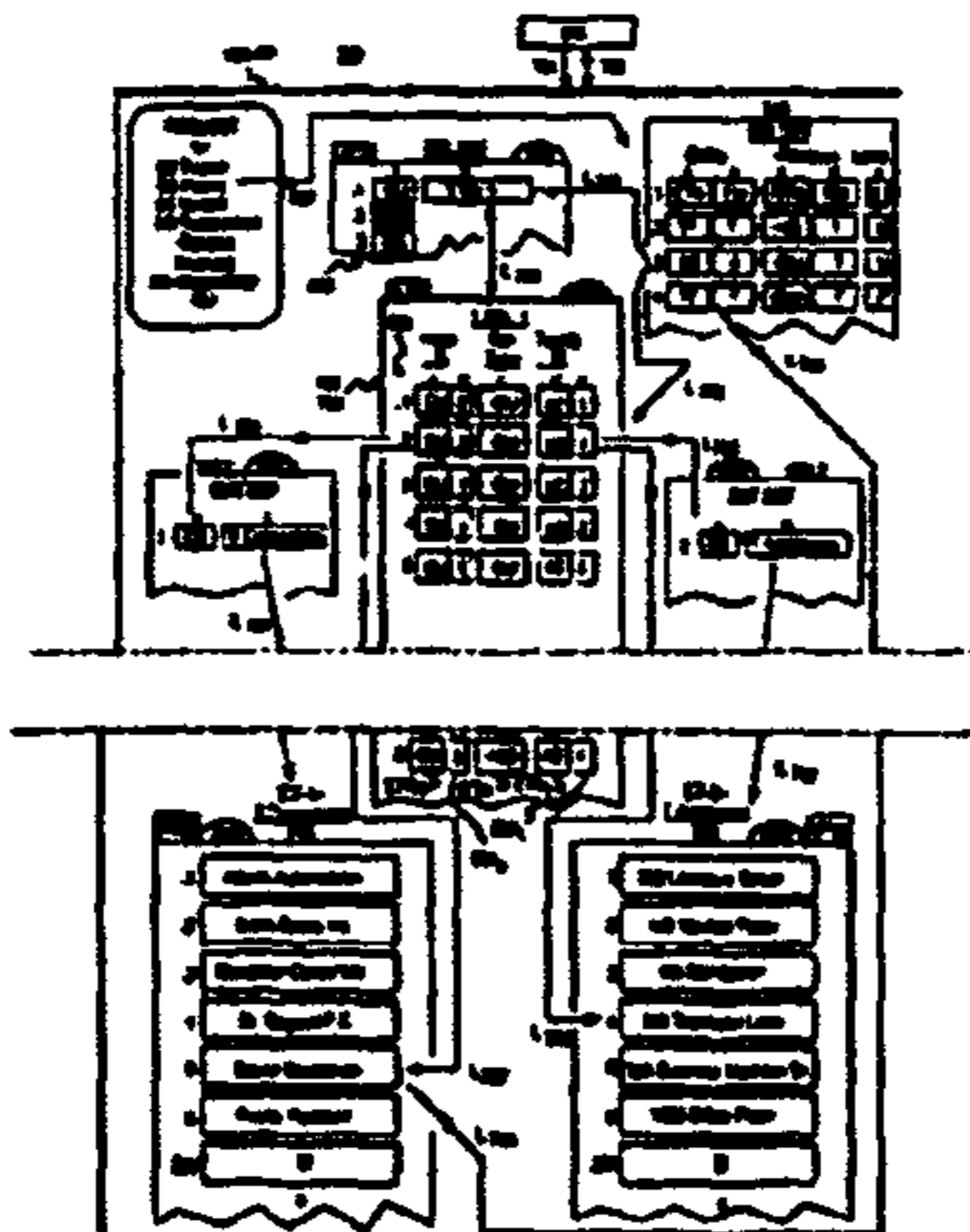



US00RE40520F1

(12) EX PARTE REEXAMINATION CERTIFICATE (7285th)
United States Patent
Doktor

(10) Number: US RE40,520 F1
(45) Certificate Issued: Jan. 5, 2010

(54) EASILY EXPANDABLE DATA PROCESSING SYSTEM AND METHOD

(75) Inventor: Karol Doktor, Wheelers Hill (AU)
(73) Assignee: Financial Systems Technology, Malvern, Victoria (AU)

Reexamination Request:
No. 90/008,648, Jun. 11, 2007

Reexamination Certificate for:
Patent No.: Re. 40,520
Issued: Sep. 23, 2008
Appl. No.: 11/152,835
Filed: Jun. 14, 2005

Related U.S. Patent Documents

Reissue of:
(64) Patent No.: Re. 40,520
Issued: Sep. 23, 2008
Appl. No.: 08/862,176
Filed: May 22, 1997

Related U.S. Application Data

- (63) Continuation of application No. 08/439,207, filed on May 11, 1995, now Pat. No. 5,675,779, which is a division of application No. 08/083,861, filed on Jun. 28, 1993, now Pat. No. 5,604,899, which is a continuation of application No. 07/526,424, filed on May 21, 1990, now abandoned.
(51) Int. Cl. G06F 17/30 (2006.01)
(52) U.S. Cl. 707/4; 707/2
(58) Field of Classification Search None
See application file for complete search history.

(56) References Cited

U.S. PATENT DOCUMENTS

Table with 3 columns: Patent No., Date, Inventor. Rows include 4,506,326 A (3/1985 Shaw et al.), 4,774,661 A (9/1988 Kumpati), 4,918,593 A (4/1990 Huber)

OTHER PUBLICATIONS

Toby J. Teorey, et al., "A Logical Design Methodology for Relational Databases Using the Extended Entity-Relationship Model", Computing Surveys, vol. 18, No. 2, pp. 197-222 (Jun. 1986).
Daniel R. Dolk, et al., "A Relational Information Resource Dictionary System", Computing Practices, Communications of the ACM, vol. 30, No. 1 (Jan. 1987).
M. M. Zloof, "Query-by-Example: a data base language", IBM Systems Journal, No. 4, pp. 324-343 (1977).
D. Tsichritzis, "LSL: A Link and Selector Language", Proceedings of the 1976 ACM SIGMOD International Conference on Management of Data, Washington, DC, (Jun. 2-4, 1976).
Rudolph Munz, "The Well System: A Multi-User Database System Based on Bunary Relationships and Graph-Pattern-Matching", 3 Information Systems, pp. 99-115, Pergamon Press (1978).
Peter Pin-Shan Chen, "The entity-relationship model-A basis for the enterprise view of data" 77 (1977).
Mark L. Gillenson, "Database Step-by-Step", pp. 141-142, 2d Ed. (1990).

Primary Examiner-Alexander J Kosowski

(57) ABSTRACT

Machine automated techniques are described for a method of data processing called Relationships Processing. A computing system is disclosed which provides for the high speed recording and extraction of data objects (entities) and for the development data representing a queried relationship between the entities. The system is expandable to handle the relatively voluminous data bases of large, commercial data repositories. A user defines set of entities and allowed relationships between the entities. The user can expand this set of allowed entities and relationships at any time during the life of the system without reprogramming or compiling of computer program code or disrupting concurrent operational user of the system. Large systems can now be built that are no longer limited to a scope of design requirements known during initial systems development. For a given set of defined relationships the system allows the user to perform complex inquiries (again without programming at the code level) that would normally require multiple nested inquiries to be coded programmatically and would not achieve the performance levels of the Relationships Processor.

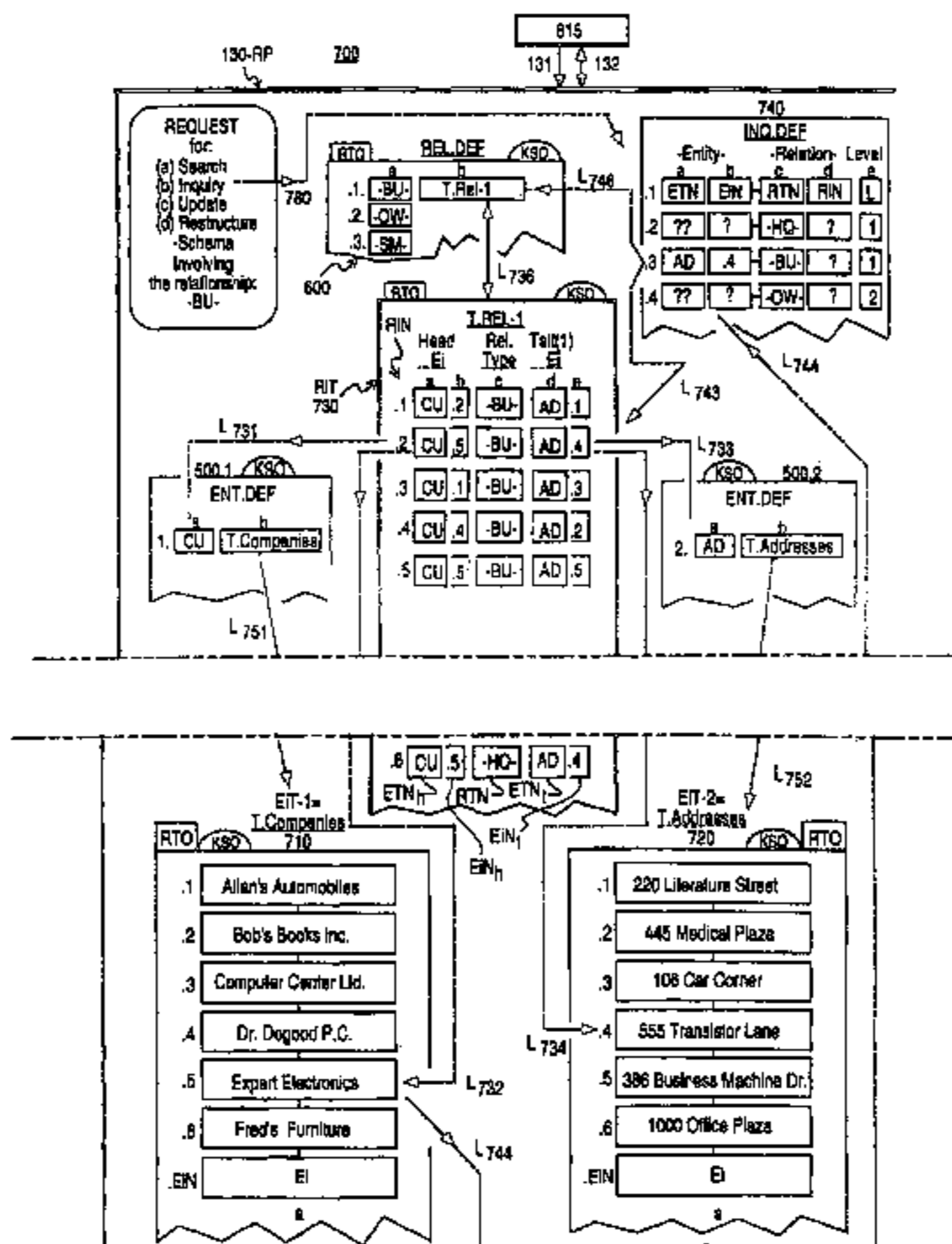

Table with 2 columns: Entity ID, Entity Name. Rows include 1. Allen's Automobiles, 2. Bob's Booths Inc., 3. Computer Center Ltd., 4. Dr. Dogood P.C., 5. Expert Electronics, 6. Friede Furniture, 7. 220 Literature Street, 8. 445 Medical Plaza, 9. 108 Car Corner, 10. 555 Transfield Lane, 11. 388 Business Machine Dr., 12. 1000 Office Plaza.

1
EX PARTE
REEXAMINATION CERTIFICATE
ISSUED UNDER 35 U.S.C. 307

NO AMENDMENTS HAVE BEEN MADE TO
THE PATENT

2
AS A RESULT OF REEXAMINATION, IT HAS BEEN
DETERMINED THAT:

5 The patentability of claims **1-18** is confirmed.

* * * * *