



US00RE38865E

(19) **United States**
(12) **Reissued Patent**
Dumarot et al.

(10) **Patent Number: US RE38,865 E**
(45) **Date of Reissued Patent: Nov. 1, 2005**

(54) SYSTEM AND METHOD FOR OPTIMIZING COMPUTER SOFTWARE AND HARDWARE	5,428,791 A * 6/1995 Andrew et al. 717/121 5,436,748 A * 7/1995 Vinel et al. 359/125 5,497,490 A * 3/1996 Harada et al. 713/100
(75) Inventors: Daniel Peter Dumarot , Cornwall, NY (US); David Alan Stevenson , Poughkeepsie, NY (US); Nicolas Richard Dono , Hopewell Jtn., NY (US); James Randall Moulic , Poughkeepsie, NY (US); Clifford Alan Pickover , Yorktown Hts., NY (US); Bengt-Olaf Schneider , Yorktown Hts., NY (US); Adelbert Smith , Poughkeepsie, NY (US)	5,506,952 A * 4/1996 Choy et al. 345/763 5,530,887 A * 6/1996 Harper et al. 710/104 5,613,125 A * 3/1997 Nguyen et al. 713/1 5,668,992 A * 9/1997 Hammer et al. 713/1 5,668,995 A * 9/1997 Bhat 718/104 5,713,009 A * 1/1998 DeRosa et al. 713/2 5,745,880 A * 4/1998 Strothmann 705/7 5,784,539 A * 7/1998 Lenz 706/45 5,809,282 A * 9/1998 Cooper et al. 709/226 5,815,152 A * 9/1998 Collier et al. 345/839 5,822,565 A * 10/1998 DeRosa et al. 703/24 5,944,819 A * 8/1999 Kumar et al. 713/1 5,978,594 A * 11/1999 Bonnell et al. 710/17 6,177,860 B1 * 1/2001 Cromer et al. 340/10.1
(73) Assignee: International Business Machines Corporation , Armonk, NY (US)	

(21) Appl. No.: **10/141,383**

* cited by examiner

(22) Filed: **May 8, 2002**

Related U.S. Patent Documents

Reissue of:

(64) Patent No.: **6,059,842**
Issued: **May 9, 2000**
Appl. No.: **09/060,028**
Filed: **Apr. 14, 1998**

(51) **Int. Cl.**⁷ **G06F 9/45**
(52) **U.S. Cl.** **717/153; 345/846; 345/961; 345/965; 345/967**
(58) **Field of Search** **717/121, 122, 717/127, 153; 345/846, 961**

(56) **References Cited**

U.S. PATENT DOCUMENTS

5,263,164 A * 11/1993 Kannady et al. 713/1

Primary Examiner—Antony Nguyen-Ba
(74) *Attorney, Agent, or Firm*—Douglas W. Cameron; Anne Vachon Dougherty

(57) **ABSTRACT**

A method of optimizing the operation of a computer system in running application programs in accordance with system capabilities, user preferences and configuration parameters of the application program. More specifically, with this invention, an optimizing program gathers information on the system capabilities, user preferences and configuration parameters of the application program to maximize the operation of the application program or computer system. Further, user selected rules of operation can be selected by dragging rule icons to target optimizer icon.

58 Claims, 7 Drawing Sheets

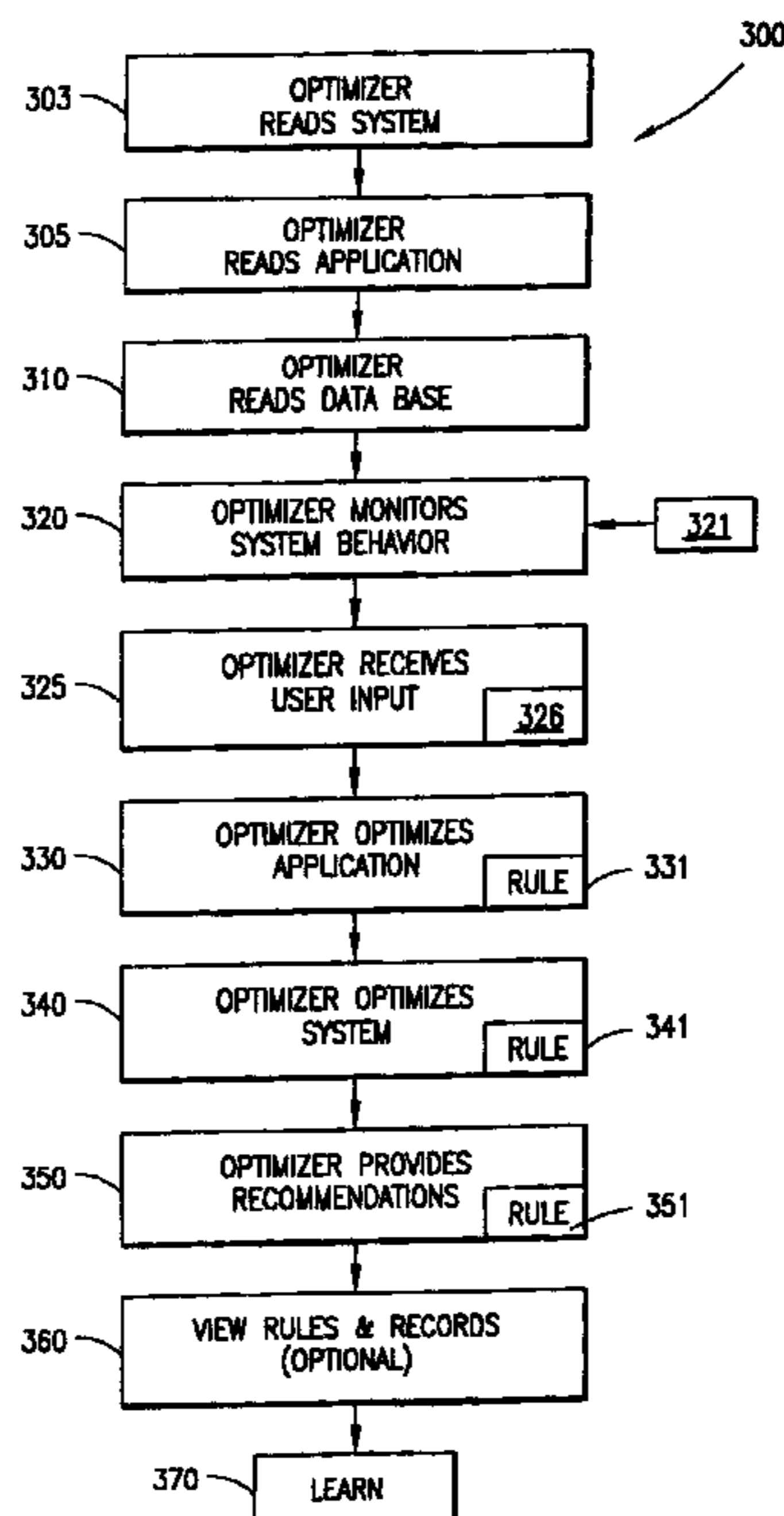

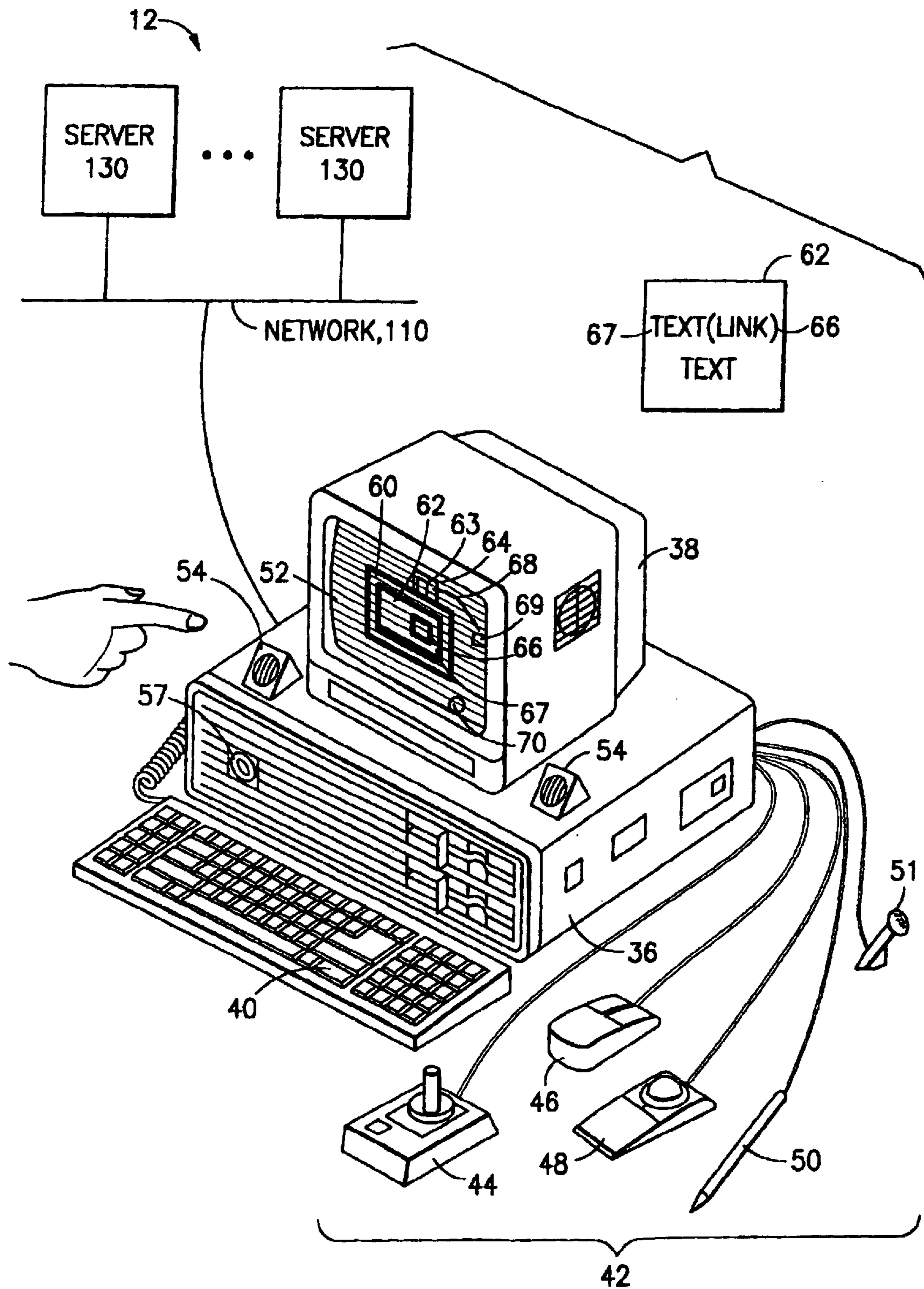

FIG. 1
PRIOR ART

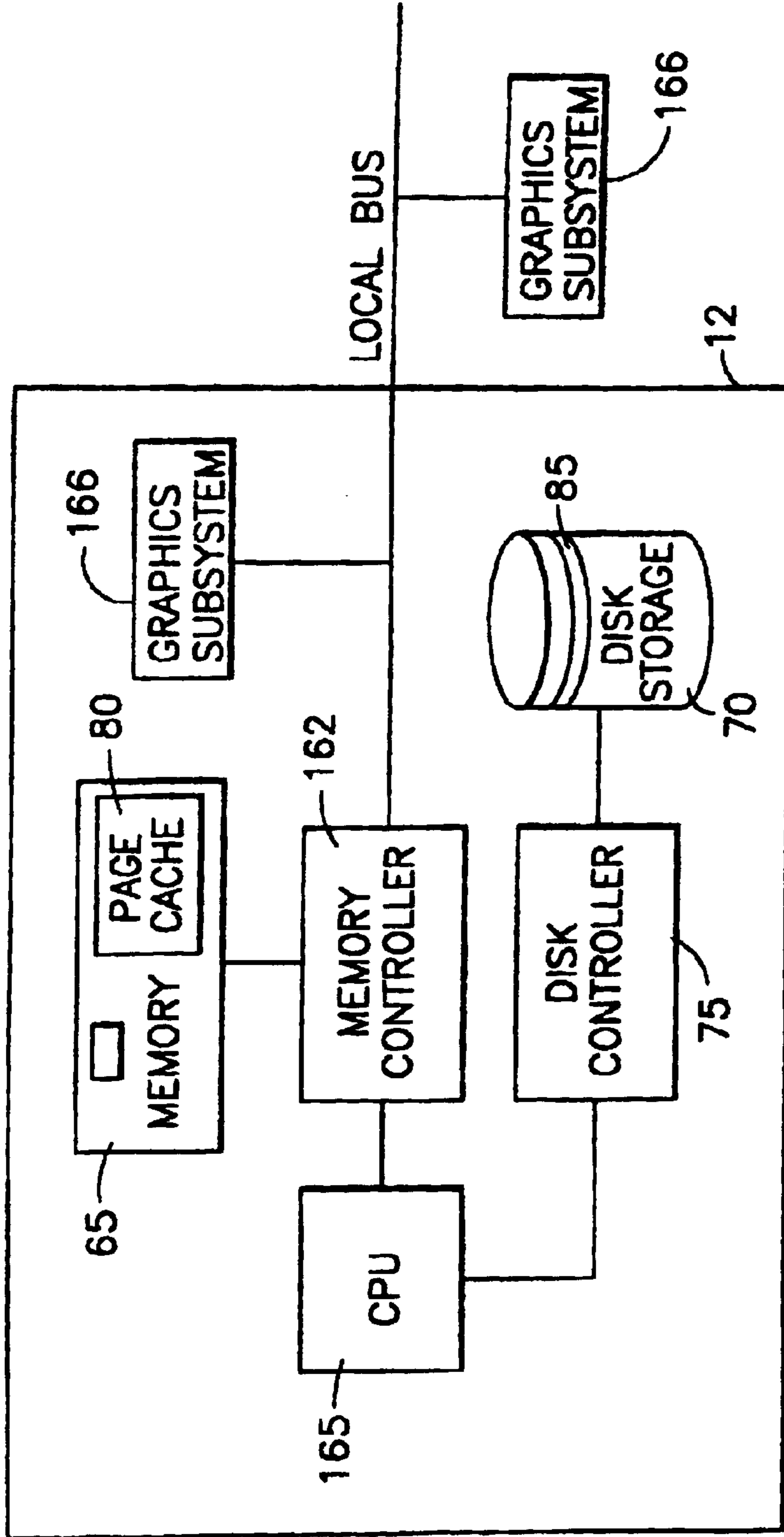

FIG. 2

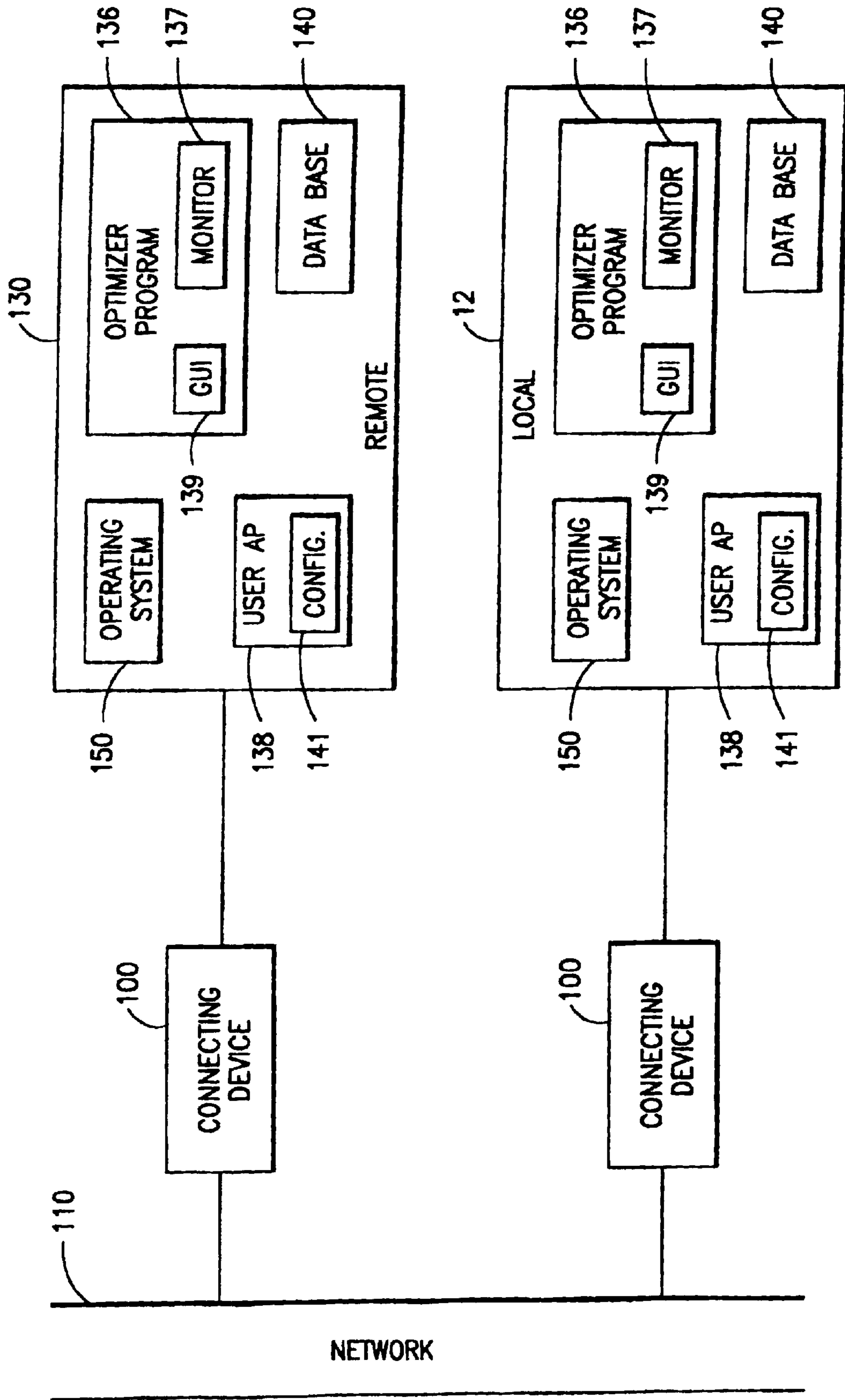

FIG. 3

APPLICATION NAME	APPLICATION SETTINGS	SYSTEM SETTINGS	DYNAMIC DATA	SUGGESTIONS
NAME 1	A1, A2, A3, ...	S1, S2, S3, ...	M1, M2, M3, ...	R1, R2, R3, ...
NAME 2	A1, A2, A3, ...	S1, S2, S3, ...	M1, M2, M3, ...	R1, R2, R3, ...
:	:	:	:	:

FIG. 4

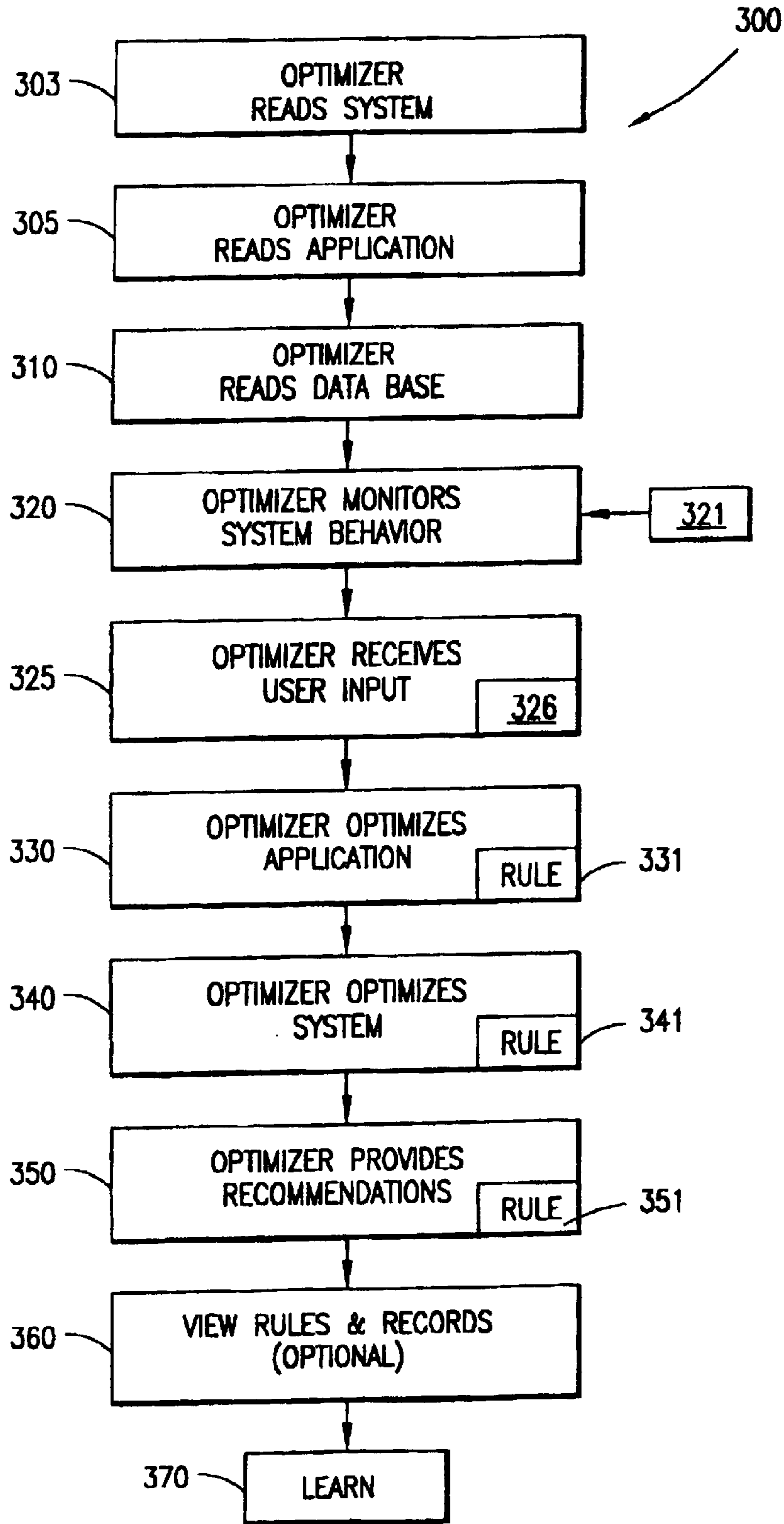

FIG.5

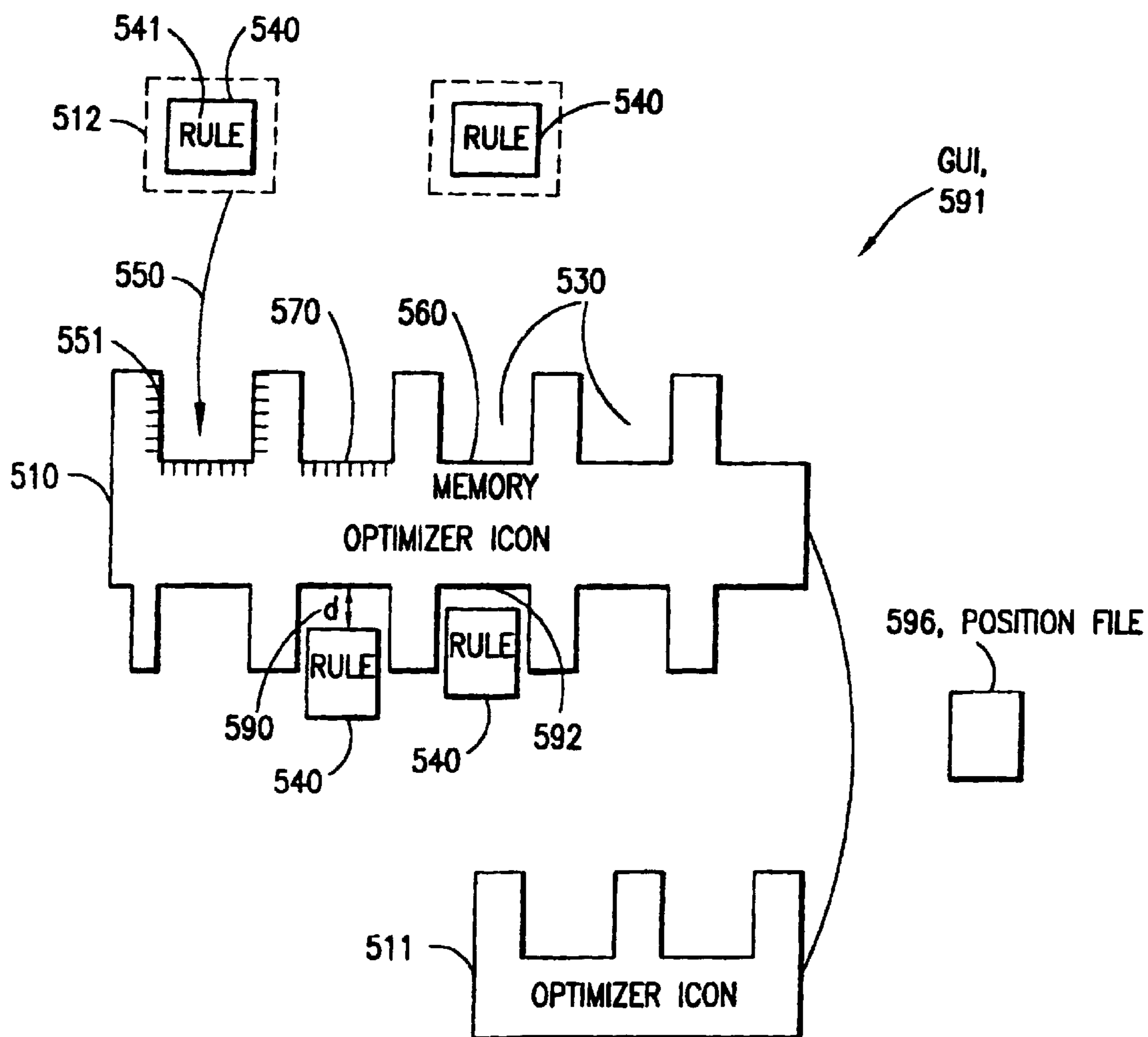

FIG.6

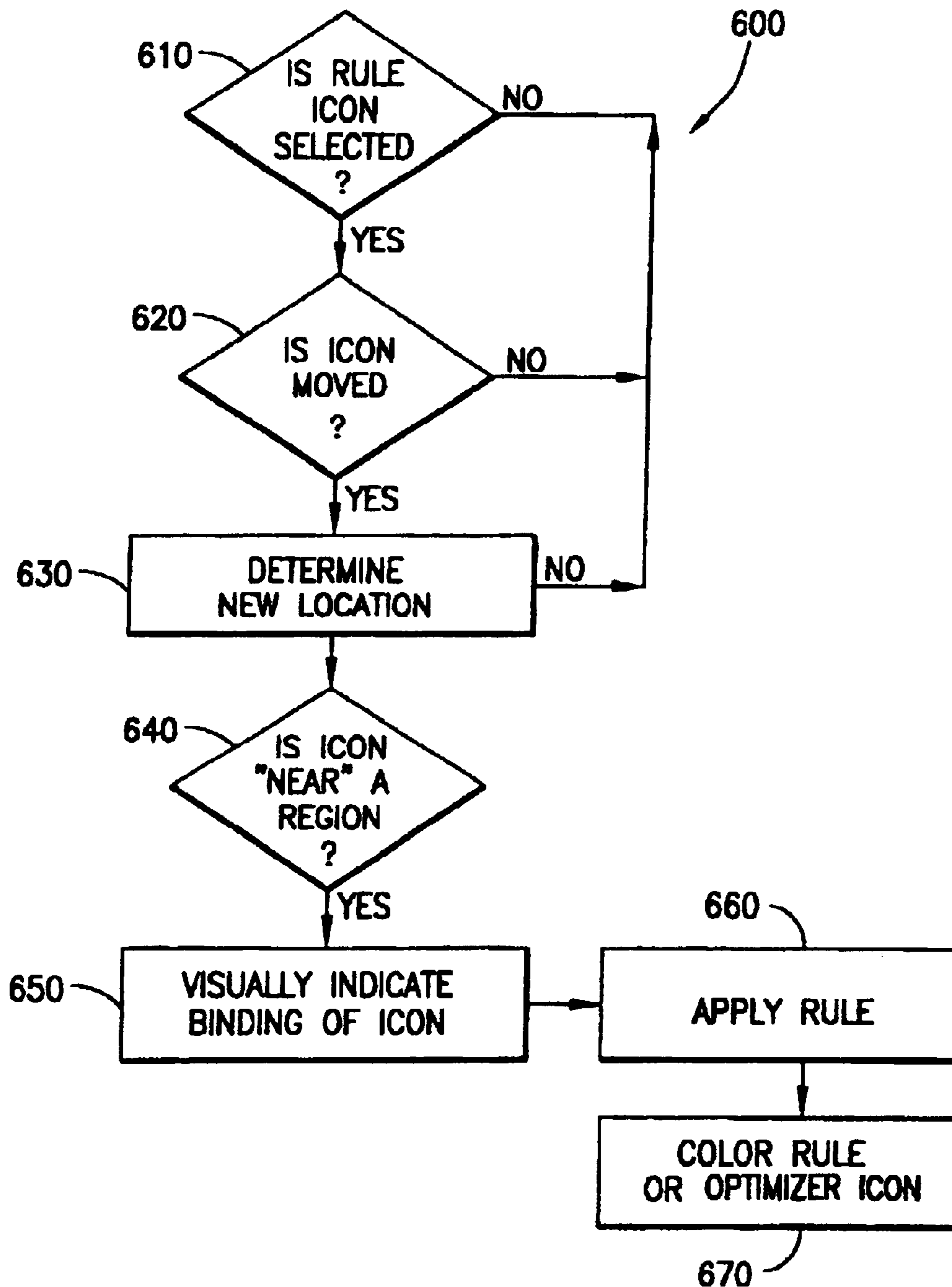

FIG.7

SYSTEM AND METHOD FOR OPTIMIZING COMPUTER SOFTWARE AND HARDWARE

Matter enclosed in heavy brackets [] appears in the original patent but forms no part of this reissue specification; matter printed in italics indicates the additions made by reissue.

TECHNICAL FIELD

This invention relates to the optimization of computer software and hardware, and in particular to optimization according to user-specified preferences, databases, and dynamic monitoring of system behavior and performance.

BACKGROUND OF THE INVENTION

Computer operating systems include a large number of parameters, many of which may be queried, controlled, and changed in order to alter the characteristics of the computer system. Similarly, software applications running on computer systems also often include a large number of parameters, many of which may be controlled and changed to alter the characteristics of the application running on the computer system. As an example, in Microsoft's Windows NT operating system, the resolution and color characteristics of the computer system's display may be changed by selecting the "Control Panel" icon from a "Settings" menu item. When the control panel is displayed, a user is presented with a set of new icons, one of which ("Display Properties") may be selected to bring up another panel containing a set of tabs. The "Settings" tab on the "Display Properties" panel may be selected which allows a user to manually change the number of colors, resolution, video refresh rate, font size, and related graphical characteristics. The user specifies the refresh frequency by selecting from a pull-down menu list of available settings (e.g. 60 Hz, 70 Hz, etc.). The user can specify the screen resolution by selecting a slider icon and moving it right or left to increase or decrease the screen resolution (e.g., from 1024×1280 pixels to 600×800 pixels). Some of these settings may affect the performance of applications running on the system. For example, decreasing the color resolution and screen resolution may increase the speed of some graphics applications.

This example focuses on system settings. When one also considers the numerous application settings and various different hardware configurations available to users, and the interaction of all of these settings and configurations, the control accessing of the plurality of settings and configurations can be cumbersome and often requires detailed knowledge on the part of computer users. The need for a dynamic, semi-automatic, consolidated, and rule-based system that changes such settings and other aspects of the computer system, and makes recommendations, becomes apparent. Although many graphical user interfaces exist to control various aspects of the system (such as the graphical slider which controls screen resolution for Windows platforms) and in applications, the need for improved graphical user interfaces becomes apparent as computer systems become more complex.

With reference now to the figures and in particular to FIG. 1, there is illustrated a computer system in accordance with the method and system of the present invention. Typically the computer system 12 includes a computer 36, a computer display 38, a keyboard 40, and multiple input pointing devices 42. Those skilled in the art will appreciate that input pointing devices may be implemented utilizing a pointing stick 44, a mouse 46, a track ball 48, a pen 50, display screen

52 (e.g. a touch display screen 52), or any other device that permits a user to manipulate objects, icons, and other display items in a graphical manner on the computer display 38. Connected to the computer system may also be audio speakers 54 and/or audio input devices 51. (See for example, IBM's Voice Type Dictation system. "Voice Type" is a trademark of the IBM Corporation.) A graphical user interface may be displayed on screen 52 and manipulated using any input pointing device 42. This graphical user interface may include display of an application 60 that displays information pages 62 using any known browser. The information pages may include graphical, audio, or text information 67 presented to the user via the display screen 52, speakers 54, or other output device. The information pages may contain selectable links 66 to other information pages, where such links can be activated by one of the input devices, like mouse 46, to request the associated information pages. This hardware is well known in the art and is also used in conjunction with televisions ("web TV") and multimedia entertainment centers. The system 12 contains one or more memories (See 65 of FIG. 2.) where a remote computer 130, connected to the system 12 through a network 110, can send information. Here the network can be any known (public or privately available) local area network (LAN) or wide area network (WAN), e.g., the Internet. The display may be controlled by a graphics adaptor card such as an Intergraph Intense 3D,

Graphical user interfaces (GUIs) provide ways for users of computers and other devices to effectively communicate with the computer. In GUIs, available applications and data sets are often represented by icons 63 consisting of small graphical representations which can be selected by a user and moved on the screen. The data sets (including pages of information) and applications may reside on the local computer or on a remote computer accessed over a network. The selection of icons often takes the place of typing in a command using a keyboard in order to initiate a program or access a data set. In general, icons are tiny on-screen symbols that simplify access to a program, command, or data file. Icons are often activated or selected by moving a mouse-controlled cursor onto the icon and pressing one or more times on a mouse button.

GUIs include graphical images on computer monitors and often consist of both icons and windows. (GUIs may also reside on the screens of televisions, kiosks, personal digital assistants (PDAs), automatic teller machines (ATMs), and on other devices and appliances such as ovens, cameras, video recorders and instrument consoles.) A computer window is a portion of the graphical image that appears on the monitor and is dedicated to some specific purpose. Windows allow the user to treat the graphical images on the computer monitor like a desktop where various files can remain open simultaneously. The user can control the size, shape, and position of the windows.

Although the use of GUIs with icons usually simplifies a user's interactions with a computer, GUIs are often tedious and frustrating to use. Icons must be maintained in a logical manner. It is difficult to organize windows and icons when many are similarly displayed at the same time on a single device.

In a drag-and-drop GUI, icons are selected 64 and moved 68 (i.e. "dragged") to a target icon 69 to achieve a desired effect. For example, an icon representing a computer file stored on disk may be dragged over an icon containing an image of a printer in order to print the file, or dragged over an icon of a trash can to delete the file. An icon representing a page of information on the World Wide Web may be

selected and dragged to a trash can to delete the link to the page of information. The page of information may be on the local machine or on a remote machine. A typical user's screen contains many icons, and only a subset of them will at any one time be valid, useful targets for a selected icon. For example, it would not be useful to drag the icon representing a data file on top of an icon whose only purpose is to access an unrelated multimedia application.

Icons **63** could include static or animated graphics, text, multimedia presentations, and windows displaying TV broadcasts. Icons **63** could also include three dimensional images, for example, those used in virtual reality applications.

SUMMARY OF THE INVENTION

An object of this invention is a method and system for increasing the apparent speed of a computer by automatically optimizing software and hardware according to user-specified preferences.

Another object of this invention is to provide a method and system for increasing the apparent speed of a computer using a database.

Yet another object of this invention is to provide a method and system for effectively increasing the apparent speed of a computer based on results obtained by dynamically monitoring system behavior and performance.

This invention permits users to conveniently optimize software running on a computer. The term "optimize" refers to running of a computer system or software more efficiently, for example, by maximizing both the speed with which a software application runs and user satisfaction, and/or minimizing cost or resource use. "Optimization" includes the setting of various parameters in hardware, operating system software, or application software such that the system as a whole runs as efficiently as possible. These parameters might be set to optimize speed, system resource cost, or other variables corresponding to a user's satisfaction.

Accordingly, this invention provides for a method of enhancing, for example, program application performance on a computer system. With this invention configuration information and performance capabilities based on characteristics of the program/system are determined. Then, the configuration information and the performance capabilities are used to optimize configuration parameters of the program applications so as to enhance the performance of the workstation in running the program'system. Further, with this invention user preferences in the operation of the program are selected by, for example, dragging rule icons to a target optimizer icon to provide user selected rules of operation of the application program.

BRIEF DESCRIPTION OF THE DRAWINGS

The invention will be further understood by reference to the following detailed description when read in conjunction with the accompanying drawings, wherein:

FIG. **1** depicts a pictorial representation of an example computer system that embodies the present invention.

FIG. **2** is a block diagram of the computer system architecture showing an optimization database.

FIG. **3** is a block diagram showing portions of a computer network wherein a local computer and a remote computer are both connected directly to the network.

FIG. **4** are example database records that may be used for optimization.

FIG. **5** is a flow chart depicting the steps performed in the optimization.

FIG. **6** is a schematic illustration display with an optimizer and rule icons thereon.

FIG. **7** is a flow chart showing the steps of one preferred method of the present invention pertaining to the use of iconic rules.

DESCRIPTION OF THE PREFERRED EMBODIMENT

With reference now to FIG. **2**, there is illustrated a block diagram of the architecture of the computer system **12** in accordance with the present invention.

The core architecture includes a Central Processing Unit **165**, memory controller **162**, system memory **65**, disk storage **70**, disk storage controller **75**, and graphics subsystem **166**. The computer system **12** can be either a stand alone workstation or a server and a workstation connected to each other via a communications network such as the internet. A portion of the system memory is set aside for an optimizer-database cache **80**. Additionally, file space **85** on the disk storage unit **70** may be set aside for the optimizer database **140**. Generally speaking, a cache or buffer is a place where data (files, images, and other information) can be stored to avoid having to read the data from a slower device, such as a remote, network-attached computer disk. For instance, a disk cache can store information that can be read without accessing remote disk storage.

With reference now to FIG. **3**, there is illustrated a partial portion of a computer network in accordance with the method and system of the present invention. Computer system **12** connects to the network backbone **110** by means of a connecting device **100**. Also connected to the network **110** are one or more server computers **130** by means of their own connecting device **100'**. Those skilled in the art will appreciate that these connecting devices **100** may take various forms, including modems, token-ring hubs, and other network-enabling devices depending on the capabilities and technology of the connecting devices. The remote computer **130** may include an area of system memory and/or disk storage space dedicated to storing and maintaining a optimization database table **140** (e.g. data file). The optimization database table **140** may reside on the local client or reside on both the client and remote computer. Portions of the optimizer program **136** may reside on the local computer and/or the remote computer. The optimizer program contains or accesses a dynamic monitor **137** of system and application activity. Various user applications **138** run on the remote or local computer. For example, these applications may be office productivity, scientific and engineering, finance, transaction processing, Internet, or any other software a user needs to run. Such applications may be controlled by a configuration file **141** or a central database that controls particular settings of the application that may affect application performance. The optimizer program **136** may contain a graphical user interface **139**, used to specify settings or provide information to the user. An operating system **150** runs on the local computer. The operating system, such as Windows NT, primarily provides an interface between the user application and the computer hardware. The operating system also provides services on behalf of the user and applications such as networking, file management, etc.

FIG. **4** includes example records **430** for optimizing system performance. The set of records comprise the database **140**. Application settings **420** may consist of a set of

5

control parameters **A1**, **A2**, . . . , **AN** shown in this example in rows **430** and associated with a particular unique identifier **410** for a software application. The software application may be designated in the database **140** as an alphanumeric string **410**. By way of example, parameter **A1** may control the graphical quality of an engineering application's 3-D graphics. Lower graphical quality often implies faster use of an application. System settings **440** contain information usually relating to static qualities of the computer system such as the particular operating system, amount of memory, processor speed, graphics card name, and bios version. These values **S1**, **S2**, . . . , **SN** are static in the sense that they do not usually change during the operation of an application. Dynamic data **460** may contain current or prior reports of system behavior or performance. The dynamic data is generally dynamic information, such as current CPU, memory, and disk use, all of which change as an application performs operations, and reads and writes information to memory and disk. The values **M1**, **M2**, **M3** . . . for this dynamic data **460** may be obtained by a monitor program **137** which, for example, scans the system for CPU, memory, and disk use at specific increments of time. Suggestions **480** consist of alphanumeric information (**R1**, **R2**, **R3**, . . .) that may be supplied to the user (e.g., recommendations or warning messages) for particular applications. The optimizer program **136** may scan a row or record **430** of database **400** to optimize a single, particular application, or it might join the results of numerous rows to optimize for a set of concurrently running applications designated by identifiers **410**. Note that in FIG. 4, parameters **A1**, **A2**, **A3** . . . control application settings. Parameters **S1**, **S2**, **S3** . . . control system settings. Parameters **M1**, **M2**, **M3** . . . control dynamic settings. Parameters **R1**, **R2**, **R3** . . . are recommendations.

FIG. 5 comprises a flow chart for an optimization process **300** that the local computer **12** or server **130** uses to optimize software applications **138** and system response or utilization, or to provide recommendations **480**. In step **303**, the optimizer **136** gathers relevant system information including: operating system **150** version and release data, installed hardware components, hardware configuration, and software configurations. For example, the optimizer determines the size of RAM, BIOS level, installed options etc. This information gathering can be accomplished using standard operating system or other commands. For example, on Microsoft's Windows NT operating system, the "Winmsd/f" calls, the Win32 API, queries to the system registry, and other methods known to those skilled in the art, allow the optimizer to collect such information. In step **305**, the optimizer **136** gathers relevant application information, for example, release version, installed options, etc. In step **310**, the optimizer **136** reads records **430** from database **140**, that control various parameters **420**, associated with a particular application name **410**. The database **140** may reside on a remote computer or server **130** accessed over a network **110** or on the local computer **12**.

In step **320**, the optimizer **136** monitors system **12** behavior. For example, the optimizer may query the current CPU use, memory use, or other activity **321** using operating system commands known to those skilled in the art. Also, a monitor program **137** may use such commands to monitor such activity. This monitor program **137** may contain a graphical user interface **139** that displays such activity in graphical form, such as with bar graphs, pie charts, numerical indicators, gauges, etc. This activity **321** may be stored in the form of dynamic values **M1**, **M2**, . . . , **MN** in settings **460** and read by the optimizer program **136**. Alternatively, the values corresponding to system activity/use may be directly

6

obtained using operating system commands. One benefit of storing the dynamic data is that the optimizer **136** may compare current to past system activity. In this step **320**, the optimizer also may perform performance measurements to "benchmark" the system by running built-in test routines. For example, the optimizer may time the rotation of a 3-D graphical object to assess the speed of the graphics subsystem **166**.

In step **325**, the optimizer **136** reads user input. For example, the user may enter text or data at the keyboard **40** (or with various input devices **46**, **48**, **50**, or by voice input using audio input device **51**) that specifies a level of optimization **326**. This level of optimization may control which of the application settings **420** are used to optimize the application in step **330** or optimize the system **12** in step **340**. A user wishing to have maximum performance may, for example, sacrifice graphic quality controlled in applications settings **420**, that are generally read upon invocation of application **138**.

By way of example, the optimizer **136** can adjust the following parameter settings **420**, in the Unigraphics control file to adjust performance. (Unigraphics is a graphically-intensive engineering application created by EDS.) The values for each of these settings may be determined in step **325** and stored in record **430**.

Low Performance settings

*Ugraf130.realTimeDynamics: TRUE
 *Ugraf130.suppressAutoRefresh: FALSE
 *Ugraf130.backfaceCulling : FALSE
 *Ugraf130.depthSortedWireframe: TRUE
 *Ugraf130.lineAntialiasing: TRUE
 *Ugraf130.disableTranslucency: FALSE

High Performance settings

*Ugraf130.realTimeDynamics: FALSE
 *Ugraf130.suppressAutoRefresh: TRUE
 *Ugraf130.backfaceCulling: TRUE
 *Ugraf130.depthSortedWireframe: FALSE
 *Ugraf130.lineAntialiasing: FALSE
 *Ugraf130.disableTranslucency: TRUE

In this example, if a user sets suppressAutoRefresh to TRUE, the application performance can improve by reducing excess redrawing. "Low Performance" is generally correlated with higher graphical quality. The "level" of optimization **326** may correspond to the number of "high performance" settings selected. For example, highest performance (highest level of optimization) may correspond to the use of all the settings in their high performance states. Lower levels of optimization correspond to fewer of the high-performance settings being used. Those values that constitute high performance settings may be stored in application settings **420**.

Similarly, the optimizer also optimizes system settings **440**. These are settings independent of applications and generally associated with the computer or its hardware or software components. For example, the graphics card may have general settings that control the resolution, color depth, synchronization on vertical refresh, and other features. The disk may have a fragmentation state which may be altered. The size of "swap" spaces may be specified. These system settings are sometimes stored in the system registry or in initialization files which may be modified using methods known to those skilled in the art.

Returning to step **325** in FIG. 5, as an alternative to text, a graphical user interface **139** may be used to provide input

data. For example, a graphical depiction of a slider may be used to control the program optimization level by causing the optimizer **136** to optimize **330** the application by writing discrete records in an application configuration file **141** stored on disk. See step **330**. Such a file as the configuration file **141** is typically read by an application when the application starts and controls various performance characteristics of a particular application. The audio input device **51** also permits speech input in step **325**. Generally speaking, in steps **330** and **340**, the optimizer uses the information acquired in steps **303**, **305**, **310**, **320**, and **325** to adjust system or application parameters in order to optimize the operation of the application. For example, the ensemble of data from **310**, **320**, and **325** may cause the optimizer to not only specify settings to the application but also to the graphics card, or system to alter the speed of the application. In general, the optimizer adjusts system and application settings to best meet user-specified quality/performance trade-offs. The information gathered in steps **303**, **305**, and **320** may be stored in the database **140** maintained by the optimizer. The database can be helpful in determining changes to system and application configurations at different points in time, in evaluating the effects of changing application settings, and in comparing actual system/application settings with recommended settings.

In step **350**, the optimizer **136** may provide suggestions or recommendations **480**, for example, in the form of specific text that is output to the user. This output may appear in the optimizer's graphical user interface **139**, in a web browser **90**, or as audible sound played through speakers **54** another audio output device. These recommendations may be used to warn the user of various conditions (e.g. "disk space is low"), or give suggestions on how to improve performance (e.g. "purchase more memory"). The optimizer contains rules **331**, **341**, **351** that it uses to make such optimizations **330**, **340** and recommendations **350**. For example, a rule may be: If **A1**=yes, and **S1**=200 MHz, or **M1**=90%, then make suggestion and change (in step **340**) the graphic card settings (e.g. **450**) that control "synchronization on vertical refresh". In this example, **S1** corresponds to the processor frequency, and **M1** corresponds to the percentage of memory used. A rule may consist of a set of conditionals and Boolean operations (e.g. if **A** and **B** are true and **C** is false then make suggestions and take action).

Note that the suggestions **480**, entire records **430**, and rules **331**, **341**, **351** may be segregated into different files in database **400**, stored at a local machine **12** or remote machine **130**. Users may view (**360**) the rules **331**, **341**, **350**, records **430**, and suggestions **480** using graphical user interface **53**, which may visually segregate these items based on origin of the suggestions (e.g. companies, individuals, etc.), severity, date, or other criteria. These rules and suggestions may be web accessible (using network **110**) for dynamic optimization across the web using a propriety program product at the web server.

Referring to FIGS. **1** and **5**, note that the rules **331**, **341**, **351** may also be represented as icons **63** displayed on the graphics screen. (These icons representing rules are hereafter sometimes referred to as "iconic rules".) Particular rules may be selected **64** from a set of available rules by the user and dragged **68** to an icon **69** representing the optimizer **136** so that the optimizer will implement **330**, **340**, **350** the rules. Additionally, the rules **331**, **341**, **351** may require password protection so that only certain users or classes of users have permission to implement the rules. In an example scenario, a user drags **68** an iconic rule **63** to optimizer icon **69**. This rule may require that the graphical quality be degraded for

a model part if the model part consists of greater than 100,000 triangular facets. (This will enhance the display speed of the model part.) When the user drops the iconic rule on the optimizer icon, the user must enter a password (e.g. consisting of a keyboard entry, speech input, mouse swipes, a sequence of mouse key presses, a secret position on the optimizer icon, or by other means) before the rule is acted upon in steps **330**, **340**, or **350**. In another embodiment, the rules are dragged to a region **70** of the screen and not to the optimizer icon in order for the rules to take effect. Password protection may be useful in a variety of situations, for example, if certain rules are being tested by developers and administrators or if certain rules cause actions that should be restricted (e.g. access to confidential databases, CPU or cost-intensive jobs, the allocation of e-money and credit information, etc.)

The optimizer in steps **330**, **340** and **350** may learn **370** from a user's past activity. For example, if the user has always used an application with small files, and past CPU use has always been low (e.g. as stored in settings **470**), the software optimizer can make suggestions (**480**), accordingly. Note that one benefit of having portions of the database **140** (e.g. the settings and suggestions) and rules **331**, **341**, and **351** on a remote machine **130** is that a company or system administrator can continually manage and update messages and rules as new information is provided by application vendors. When a user runs an application in **410**, the user can make use of the latest information in the database. If the database **140** resides on a remote machine **130** the optimization **330**, **340**, and **350** can be performed either on the local machine or the remote machine. If performed on a remote machine, messages and other parameters are fed from the remote server **130** to the client **12** using the network **110**.

FIG. **6** is a block diagram of a GUI **591** with rule icons **540,63** (See FIG. **1**.) including optimizer icons **69**, **510**, **511**. In the present invention, the user uses a selection device such as mouse **46** to select **512** an icon **540** and drags **550** the icon to optimizer icons **510**, **511**. If the icon **540**, representing a rule, is touching or close (within a threshold distance **590**) to the optimizer icon **510**, then the rule **541**, **331**, **341**, **351** is applied. In other words, "closeness" of an icon is determined by computing the distances from the selected icon **540** to regions **520** of the optimizer icon displayed on the GUI. If the distance is smaller than a particular threshold **592**, the icon **540** is close to a region of the optimizer.

In one embodiment, the optimizer icon **510** consists of different regions **520** to which iconic rules **540** are dragged. The optimizer software determines near what location **520** icon is positioned using techniques which are well known to those skilled in the art of GUI interfaces. In addition to performing general optimization, the optimizer icons **510** may be used to specify the 'nature' of the update; for example, one optimizer icon **510** may be specified for optimization concerning graphics, while another icon **511** may be specific for controlling all aspects of memory and disk space. The optimizer icon may change its graphical attribute such as color or brightness **570** in response to the information gained when the optimizer software applies the rules **541**. For example, once a rule is successfully applied, then the optimizer region **520** may turn red **570**. The iconic rules **541** may also change graphical attributes in a similar manner. (Changes in graphical characteristics of the iconic rules and optimizer icons are carried out in step **670** in FIG. **7**).

The rule application can be carried out by the optimizer software by comparing the position **585** of icon **540** to values stored in a position file **596** which may be stored on disk.

The optimizer icon **510** may also contain graphical indications of regions **520**, such as cutouts **530**, to which iconic rules **540** may be dragged. In this manner, when the icons are placed in the optimizer icon **510** there can be a graphical indication **551** of the binding to the user. Additionally, the area around the cutout may change color or brightness **570** once an icon **540** is located in the cutout. The use of discrete cutouts **530** may be useful when only a limited number of rules may be used. The rules may be evident to the user by text **560** written on the optimizer icon or by colors **570**.

FIG. 7 is a flow chart **600** showing the steps **600** performed for a preferred version of optimizer **163** executed by the system in FIG. 1. In step **610**, a program checks if an icon **540** (e.g., if an iconic rule) is selected. The selected icon **540** may be selected by any selection method: e.g., pointing and clicking or by an application program. If the icon is moved **620**, its new location is determined **630**. If the icon is near (within a threshold distance **590** from) an optimizer region **520** (step **640**), then a visual indication **650** of placement such as changing color or brightness **570** of a region **520** optionally may be given. As stated in the description of FIG. 5, the region **520** may be graphically depicted as cutouts **530** to help give users a graphical (visual) indication of the placement. Also as mentioned in the description for FIG. 5, "nearness" or "closeness" is determined by computing the distances from the selected icon to all optimizer icons regions **520** on the GUI. In one preferred embodiment, distances are computed using known geometrical methods. For example, if (x_1, y_1) are the coordinates of an icon **540** and (x_2, y_2) are the coordinates of a region **520**, then the distance is $d = \sqrt{(x_2 - x_1)^2 + (y_2 - y_1)^2}$. This formula may be extended to include additional variables for higher dimensional spaces, such as in a virtual reality or three-dimensional environment. An optimizer table (file) **596** on disk may store the x,y locations of regions **520**.

The rule **541** represented by an icon **540** is applied **660**. The icon **540** or optimizer icon **510** optionally may change color, brightness, texture, blink rate, shape, size, or other graphical attribute (see step **670**). This graphical attribute may be a function of the nature of the rule. For example, an iconic rule that increases graphics quality may be red. An icon representing a rule that decreases graphics quality may be green. The optimizer icon may change colors when the rule is successfully applied or has a beneficial effect.

Having thus described our invention, what we claim as new and desire to secure by Letters Patent is:

1. In a computer system, a method of enhancing program application [or system] performance of said computer system, said method comprising:

- a. determining configuration information of said computer system;
- b. determining performance capabilities of said computer system based on known characteristics and behaviors of said program application; and
- c. *automatically* optimizing configuration parameters of said program application in response to said configuration information and said performance capabilities.

2. A method as recited in claim 1, further comprising:

- a. determining user preferences for the operation of said computer system and further *automatically* optimizing said computer system in response to said user preferences.

3. A method as recited in claim 1, wherein said determining performance capabilities of said computer system comprises:

- a. comparing system performance against previous system performance, where said previous system performance is stored in a database with said configuration parameters.

4. A method as recited in claim 2, wherein said user preferences are determined using a graphic user interface through which a user enters said user preferences.

5. A method as recited in claim 1, further comprising:

- a. providing recommended system configurations in response to said performance capabilities that are determined.

6. A method as recited in claim 1, wherein said configuration information comprises at least one of the following:

- a. CPU speed, memory capacity, disk subsystem capabilities, system BIOS version, graphics adapter type, driver levels, operating system software and service pack release levels.

7. A method as recited in claim 1, wherein said performance capabilities comprise at least one of the following:

- a. CPU performance for integer and floating point tasks, memory subsystem throughput, disk subsystem throughput,
- b. 3D graphics performance, and
- c. 2D graphics performance.

8. A method as recited in claim 1, wherein said computer system can operate according to a plurality of rules of operation, wherein said graphic user interface comprises user selectable rule icons, each of which represents one of said rules of operation for said computer system, and wherein a user can select at least one of said rules of operation by selecting at least corresponding one of said rule icons.

9. A method as recited in claim 8, wherein said user selects one of said rule icons by dragging and dropping said one icon to an optimizer icon, wherein said dropping results in the application of said selected one rule of operation.

10. A method as recited in claim 9, wherein said optimizer icon comprises a plurality of locations, each location capable of accepting one of said rule icons, wherein one of said rules is implemented when a corresponding one of said rule icons representing said one rule is placed on said graphical user interface within a threshold distance of said one location.

11. A method as recited in claim 10, wherein each location is visually distinguished.

12. A method as recited in claim 10, wherein each location is visually distinguished by at least one of the following characteristics: color, outline, textures, and brightness.

13. A method as recited in claim 10, wherein each location is spatially distinguished.

14. A method as recited in claim 10, wherein at least one of said locations is a cutout on said optimizer icon.

15. A method as recited in claim 10, wherein there is a visual indication that one of said rule icons is within said threshold distance.

16. A method as recited in claim 1, further comprising:

- a. storing said known characteristics and behaviors of said program application in a database.

17. A method as recited in claim 16, wherein said database is hard-coded into said program application.

18. A method as recited in claim 16, wherein said database is stored as a table.

19. A method as recited in claim 16, wherein said database is constructed by the user via a graphical user interface that uses a drag-and-drop paradigm to construct rules by combining graphical user interface components representing components of the rule.

20. A method as recited in claim 16, wherein said database is stored in a storage device that is remote from said workstation.

11

21. A method as recited in claim 1, wherein said computer system comprises a server and a remote station which can be interconnected to each other through a communications network.

22. A method as recited in claim 1, further comprising optimizing configuration parameters of said computer system in response to said configuration information and said performance capabilities.

23. A method as recited in claim 1, wherein determining performance capabilities of said computer system comprises:

a. determining real time resource utilization when said program application is being executed.

24. A method of running an application program on a computer system to accomplish a user selected result in the running of the application program, said method comprising:

a. determining the utilization of selected resources of said computer system at selected intervals during the running of the application program;

b. comparing said resource utilization with predefined thresholds; and

c. alerting a user of said computer system to alter application program parameters if said resource utilization comparison satisfies predefined criteria with respect to said thresholds.

25. A method as recited in claim 24, wherein said predefined criteria comprises a combination of resource utilization requirements for a set of said resources of said computer system.

26. A method of enhancing computer systems performance, said method comprising:

a. monitoring user activity;

b. determining user activity patterns;

c. matching said user activity patterns against entries in a database; and

d. *performing at least one of* making suggestions [or] and alerting said user to alter at least one of computer system parameters and application program parameters in accordance with said entries.

27. A program storage device readable by machine, tangibly embodying a program of instructions executable by the machine to perform method steps for enhancing program application [or system] performance of a computer system, said method steps comprising:

a. determining configuration information of said computer system;

b. determining performance capabilities of said computer system based on known characteristics and behaviors of said program application; and

c. *automatically* optimizing configuration parameters of said program application in response to said configuration information and said performance capabilities.

28. A program storage device readable by machine, tangibly embodying a program of instructions executable by the machine to perform method steps for running an application program on a computer system to accomplish a user selected result in the running of the application program, said method steps comprising:

a. determining the utilization of selected resources of said computer system at selected intervals during the running of the application program;

b. comparing said resource utilization with predefined thresholds; and

c. alerting a user of said computer system to alter application program parameters if said resource utilization

12

comparison satisfies predefined criteria with respect to said thresholds.

29. A program storage device readable by machine, tangibly embodying a program of instructions executable by the machine to perform method steps for enhancing computer systems performance, said method comprising:

a. monitoring user activity;

b. determining user activity patterns;

c. matching said user activity patterns against entries in a database; and

d. *performing at least one of* making suggestions [or] and alerting said user to alter at least one of computer system parameters and application program parameters in accordance with said entries.

30. A system for enhancing program application [or system] performance of a computer system comprising:

a. means for determining configuration information of said computer system;

b. means for ascertaining performance capabilities of said computer system based on known characteristics and behaviors of said program application; and

c. processing means for automatically optimizing configuration parameters of said program application based on said configuration information and said performance capabilities.

31. The system of claim 30 further comprising notifying means for notifying a user of said optimal configuration parameters.

32. The system of claim 30 wherein said automatically optimizing comprises automatically resetting configuration parameters of said program application.

33. *In a computer system, a method of enhancing program application performance of said computer system, said method comprising:*

a. *determining performance capabilities of said computer system based on known characteristics and behaviors of said program application; and*

b. *automatically optimizing configuration parameters of said program application in response to said performance capabilities.*

34. *A method as recited in claim 33, further comprising:*

a. *determining user preferences for the operation of said computer system and further automatically optimizing said configuration parameters of said program application in response to said user preferences.*

35. *A method as recited in claim 33, wherein said determining performance capabilities of said computer system comprises:*

a. *comparing system performance against previous system performance, where said previous system performance is stored in a database with said configuration parameters.*

36. *A method as recited in claim 34, wherein said user preferences are determined using a graphic user interface through which a user enters said user preference.*

37. *A method as recited in claim 33, further comprising:*

a. *providing recommended system configurations in response to said performance capabilities that are determined.*

38. *A method as recited in claim 33, wherein said performance capabilities comprise at least one of the following:*

a. *CPU performance for integer and floating point tasks, memory subsystem throughput, disk subsystem throughput,*

b. *3D graphics performance, and*

c. *2D graphics performance.*

13

39. A method as recited in claim 33, wherein said computer system can operate according to a plurality of rules of operation, wherein said graphic user interface comprises user selectable rule icons, each of which represents one of said rules of operation for said computer system, and wherein a user can select at least one of said rules of operation by selecting at least corresponding one of said rule icons.

40. A method as recited in claim 39, wherein said user selects one of said rule icons by dragging and dropping said one icon to an optimizer icon, wherein said dropping results in the application of said selected one rule of operation.

41. A method as recited in claim 40, wherein said optimizer icon comprises a plurality of locations, each location capable of accepting one of said rule icons, wherein one of said rules is implemented when a corresponding one of said rule icons representing said one rule is placed on said graphical user interface within a threshold distance of said one location.

42. A method as recited in claim 41, wherein each location is visually distinguished.

43. A method as recited in claim 41, wherein each location is visually distinguished by at least one of the following characteristics: color, outline, textures, and brightness.

44. A method as recited in claim 41, wherein each location is spatially distinguished.

45. A method as recited in claim 41, wherein at least one of said locations is a cutout on said optimizer icon.

46. A method as recited in claim 41, wherein there is a visual indication that one of said rule icons is within said threshold distance.

47. A method as recited in claim 33, further comprising:

a. storing said known characteristics and behaviors of said program application in a database.

48. A method as recited in claim 47, wherein said database is hard-coded into said program application.

49. A method as recited in claim 47, wherein said database is stored as a table.

50. A method as recited in claim 47, wherein said database is constructed by the user via a graphical user interface that uses a drag-and-drop paradigm to construct rules by combining graphical user interface components representing components of the rule.

14

51. A method as recited in claim 47, wherein said database is stored in a storage device that is remote from said workstation.

52. A method as recited in claim 33, wherein said computer system comprises a server and a remote station which can be interconnected to each other through a communication network.

53. A method as recited in claim 33, further comprising optimizing configuration parameters of said computer system in response to said performance capabilities.

54. A method as recited in claim 33, wherein determining performance capabilities of said computer system comprises:

a. determining real time resource utilization when said program application is being executed.

55. A program storage device readable by machine, tangibly embodying a program of instructions executable by the machine to perform method steps for enhancing computer application performance of a computer system, said method steps comprising:

a. determining performance capabilities of said computer system based on known characteristics and behaviors of said program application; and

b. automatically optimizing configuration parameters of said program application in response to said performance capabilities.

56. A system for enhancing program application performance of a computer system comprising:

a. means for ascertaining performance capabilities of said computer system based on known characteristics and behaviors of said program application; and

b. means for automatically optimizing configuration parameters of said program application in response to said performance capabilities.

57. The system of claim 56 further comprising notifying means for notifying a user of said optimal configuration parameters.

58. The system of claim 56 wherein said automatically optimizing comprises automatically resetting configuration parameters of said program application.

* * * * *