



US00RE38188E

(19) **United States**
 (12) **Reissued Patent**
Ogura et al.

(10) **Patent Number:** **US RE38,188 E**
 (45) **Date of Reissued Patent:** **Jul. 15, 2003**

(54) **ETHYLENE DERIVATIVES AND PESTICIDES CONTAINING SAID DERIVATIVES**

(75) Inventors: **Tomoyuki Ogura**, Funabashi (JP); **Hiroshi Murakami**, Funabashi (JP); **Akira Numata**, Funabashi (JP); **Rika Miyachi**, Funabashi (JP); **Toshiro Miyake**, Minamisaitama (JP); **Norihiko Mimori**, Minamisaitama (JP); **Shinji Takii**, Minamisaitama (JP)

(73) Assignee: **Nissan Chemical Industries, Ltd.**, Tokyo (JP)

(21) Appl. No.: **09/983,477**

(22) Filed: **Oct. 24, 2001**

Related U.S. Patent Documents

Reissue of:

(64) Patent No.: **6,063,734**
 Issued: **May 16, 2000**
 Appl. No.: **09/177,501**
 Filed: **Oct. 23, 1998**

U.S. Applications:

(63) Continuation-in-part of application No. PCT/JP97/01449, filed on Apr. 24, 1997.

(30) Foreign Application Priority Data

Apr. 25, 1996 (JP) 8-104878
 Jun. 7, 1996 (JP) 8-145802
 Jun. 20, 1996 (JP) 8-159346
 Feb. 13, 1997 (JP) 9-28916

(51) **Int. Cl.⁷** **C07D 249/06**

(52) **U.S. Cl.** **504/261; 514/359; 548/255**

(58) **Field of Search** **548/255; 514/359; 504/261**

(56) References Cited

U.S. PATENT DOCUMENTS

3,337,565 A 8/1967 Bencze et al.
 3,337,566 A 8/1967 Walker et al.
 4,600,712 A 7/1986 Haken et al.
 4,639,447 A 1/1987 Roeser et al.
 4,988,818 A 1/1991 Lauer et al.
 5,064,844 A 11/1991 O'Mahony et al.

FOREIGN PATENT DOCUMENTS

DE 283 916 A5 10/1990
 EP 0 102 163 7/1984
 EP 0 412 849 A 2/1991
 EP 0 706 758 A 4/1996
 JP 52-105167 9/1977
 JP 53-92769 8/1978
 JP 57-502215 12/1982
 JP 59-219228 12/1984
 JP 60-11401 1/1985
 JP 60-11452 1/1985
 JP 60-209571 10/1985
 JP 18-104878 4/1996
 JP 18-145802 6/1996

JP 18-159346 6/1996
 JP 19-28916 2/1997
 WO WO 95/29591 11/1995
 WO WO 97/40009 A 10/1997
 WO WO 98/42683 10/1998
 WO WO 99/02507 1/1999

OTHER PUBLICATIONS

F. Eiden et al.; "Polycarbonylmethyl-Derivate: Reaktionen von 2-(3-Methyl-5-isoxazolyl)-1-phenylethanon", *Institut für Pharmazie und Lebensmittelchemie der Universität München*, pp. 242-251, (1985).

T. Eicher et al., "Zur Reaktion von Triäfulvenen mit Isonitrilen, Eine einfache Synthese von diphenylsubstituierten funktionalisierten Cyclobuten-Derivaten und deren Folgeprodukten", *Universität des Saarlandes*, pp. 619-626, (1987).

Ukr. Khim. Zh. (Russ. Ed.), 51(6), (1985), pp. 649-652.

A. Alberola et al., Produccion Y Transformacion De Carbaniones Derivados De 3,5-Dimetilisoxazoles Funcionalizados En C-4, *Universidad de Valladolid*, vol. 83, pp. 182-194, (1986).

V. Kantlehner et al., "Umsetzung von 2,5-Dimethyl-1,3,4-thiadiazol mit Saurechloriden", *Chemiker-Zeitung*, vol. 113, pp. 125-127, (1989).

V. Kantlehner et al., "Umsetzung von 2,5-Dimethyl-1,3,4-thiadiazol mit Carbonsäureestern", *Chemiker-Zeitung*, vol. 113, pp. 217-219, (1989).

L. Zirngibl et al., Structure-Activity Relationships of 2-(1H-Imidazol-1-yl) vinyl Ethers (Route to the New Broad-Spectrum Antifungal Agent Omoconazole); *Annals New York Academy of Sciences*, pp. 64-73.

Khim.-Farm. Zh., 22(10), (1988), pp. 1223-1225.

Chemical Abstracts, vol. 109, Abstract No. 93171 & *Zh. Obshch. Khim.*, 57(10), (1987), pp. 2234-2249.

Chemical Abstracts, vol. 101, Abstract No. 211021 & *Bull. Chem. Soc. Jpn.*, 57(8), (1984), pp. 2329-2330.

Chemical Abstracts, vol. 96, Abstract No. 217794 & *Indian J. Chem., Sect. B*, 21B(1), pp. 1-3.

Primary Examiner—Robert Gerstl

(74) *Attorney, Agent, or Firm*—Oliff & Berridge, PLC

(57) ABSTRACT

Ethylene derivatives of formula (I):

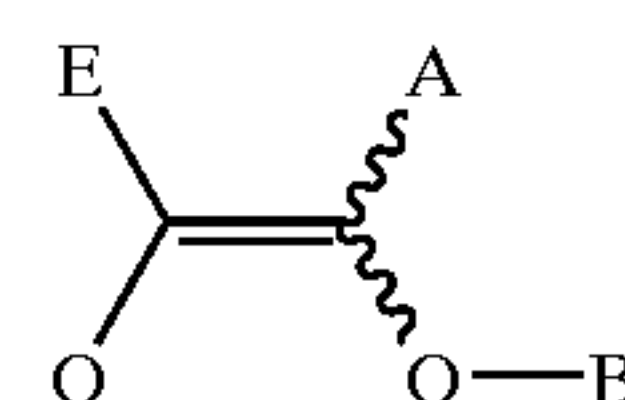

where Q is an unsubstituted or substituted phenyl or heterocyclic group, especially a 4-thiazolyl, 1- or 3-pyrazolyl, 1,3-oxazol-4-yl, phenyl or pyridyl group; E is a substituent such as a cyano group; A is a substituent such as a 4-pyrazolyl or thiazolyl group; and B is a substituent such as an alkylcarbonyl group. Agricultural chemicals and agents for preventing the attachment of aquatic organisms containing one or more such ethylene derivatives.

39 Claims, No Drawings

**ETHYLENE DERIVATIVES AND
PESTICIDES CONTAINING SAID
DERIVATIVES**

Matter enclosed in heavy brackets [] appears in the original patent but forms no part of this reissue specification; matter printed in italics indicates the additions made by reissue.

This is a cont.-in-part of international application No. PCT/JP97/01449, filed Apr. 24, 1997.

BACKGROUND OF THE INVENTION

1. Field of the Art

The present invention relates to novel ethylene derivatives, and also to agricultural chemicals and agents for preventing the attachment of aquatic organisms containing said derivatives as an active ingredient. The agricultural chemicals as referred to herein include insecticides, acaricides, nematocides, herbicides and fungicides, etc., and are especially pesticides in the field of agriculture, horticulture, stock farming and sanitation. The agent for preventing the attachment of aquatic organisms are chemicals for preventing the attachment of harmful aquatic organisms such as shells and algae to fishing nets, the bottoms of ships, marine equipment such as buoys, marine constructions, circulating water systems in thermal and atomic power plants, inlet channels for heat exchanger cooling water in chemical industry, underwater constructions and reservoirs.

2. Description of the Related Art

For acrylonitrile derivatives, Japanese Patent Application Laid-Open No. Sho 53-92769 discloses the use of 2'-chloro-3-hydroxy-2-(4-phenyl-2-thiazolyl)-cinnamoyl nitrile as an insecticide; and International Patent Application Laid-Open No. WO-95/29591 discloses its use as an aquatic adhesion inhibitor. Japanese Patent Application Laid-open No. Sho 60-11452 discloses the use of 2-(4-chlorophenyl)-3-(3-pyridyl)-3-oxopropionitrile as a herbicide and Japanese Patent Application Laid-open No. Sho 60-11401 discloses its use as a fungicide.

With the long-term use of insecticides and fungicides, recently, some pests have become resistant to chemicals and are often difficult to exterminate with conventional insecticides and fungicides. In addition, some insecticides are highly toxic and are prone to remain long, without being decomposed, to destroy the ecosystem. Accordingly, it is always expected to develop novel, low-toxic and low-persistent insecticides and fungicides.

On the other hand, in order to prevent the adhesion and growth of marine and freshwater aquatics, it is used anti-fouling coatings comprising organic tin compounds such as bis(tributyltin) oxide or copper compounds such as copper sulfate and cuprous oxide. However, organic tin compounds are highly toxic, though being effective in preventing the adhesion of aquatics, and are especially prone to accumulate in the bodies of fishes and shellfishes. As so promoting the environmental pollution, the use of those compounds is now under legal controls. Copper compounds are widely used in antifouling coatings for inlet channels and for the bottoms of ships. However, like tin compounds, copper compounds contain a copper as a heavy metal. Therefore, the use of copper compounds will bring about the environmental pollution in future, and agents for preventing the attachment of aquatic organisms comprising such copper compounds are not preferred. Under the above-mentioned situation, it has been desired agents for preventing the attachment of aquatic

organisms that have few influences on the ecosystem and bring about little secondary pollution.

SUMMARY OF THE INVENTION

In order to solve the above-mentioned problems, the present inventors have assiduously studied to develop agricultural chemicals and agents for preventing the attachment of aquatic organisms which can exhibit excellent pesticidal activities even when used in small amounts, and which have few negative influences on non-targeted organisms such as mammals, fishes and useful insects, and, as a result, have found that the compounds mentioned hereinunder are highly safe and have excellent pesticidal activities and activities for preventing the attachment of aquatic organisms. On the basis of these findings, the present inventors have completed the present invention.

**DETAILED DESCRIPTION OF THE
INVENTION**

Specifically, the present invention provides the following [1] to [25]

[1] Ethylene derivatives of a formula (I):
[wherein;

Q represents a phenyl group optionally substituted by G, a naphthyl group optionally substituted by G, or a heterocyclic group optionally substituted by R (said heterocyclic group being a thienyl, furyl, pyrrolyl, oxazolyl, isoxazolyl, thiazolyl, isothiazolyl, pyrazolyl, imidazolyl, 1,3,4-oxadiazolyl, 1,2,4-oxadiazolyl, 1,3,4-thiadiazolyl, 1,2,4-thiadiazolyl, 1,2,4-triazolyl, 1,2,3-thiadiazolyl, 1,2,3-triazolyl, 1,2,3,4-tetrazolyl, pyridinyl, pyrimidinyl, pyrazinyl, pyridazinyl, 1,3,5-triazinyl, 1,2,4-triazinyl, 1,2,4,5-tetrazinyl, pyrazolinyl, imidazolinyl, oxazolinyl, isoxazolinyl, thiazolinyl, imidazolinone, imidazolidinedione, 3(2H)-pyridazinone, benzothiazolyl, benzimidazolyl, indazolyl, benzoxazolyl, quinolyl, isoquinolyl, quinoxalinyl, phthalazinyl, cinnolinyl or quinazolinyl group);

A represents a phenyl group optionally substituted by W, a naphthyl group optionally substituted by W, or a heterocyclic group optionally substituted by Y (said heterocyclic group being a thienyl, furyl, pyrrolyl, oxazolyl, isoxazolyl, thiazolyl, isothiazolyl, pyrazolyl, imidazolyl, 1,3,4-oxadiazolyl, 1,2,4-oxadiazolyl, 1,3,4-thiadiazolyl, 1,2,4-thiadiazolyl, 1,2,4-triazolyl, 1,2,3-thiadiazolyl, 1,2,3-triazolyl, 1,2,3,4-tetrazolyl, pyridinyl, pyrimidinyl, pyrazinyl, pyridazinyl, 1,3,5-triazinyl, 1,2,4-triazinyl, pyrazolinyl, imidazolinyl, oxazolinyl, isoxazolinyl, thiazolinyl, 3(2H)-pyridazinone, benzothiazolyl, benzimidazolyl, indazolyl, benzoxazolyl, quinolyl, isoquinolyl, quinoxalinyl, phthalazinyl, cinnolinyl or quinazolinyl group);

provided that, (a) when Q is a thienyl group optionally substituted by R, a furyl group optionally substituted by R, a quinolyl group optionally substituted by R, or an isoquinolyl group optionally substituted by R, then A is a phenyl group optionally substituted by W, a naphthyl group optionally substituted by W, or a heterocyclic group optionally substituted by Y (said heterocyclic group being a pyrrolyl, oxazolyl, isoxazolyl, thiazolyl, isothiazolyl, pyrazolyl, imidazolyl, 1,3,4-oxadiazolyl, 1,2,4-oxadiazolyl, 1,3,4-thiadiazolyl, 1,2,4-thiadiazolyl, 1,2,4-triazolyl, 1,2,3-thiadiazolyl, 1,2,3-triazolyl, 1,2,3,4-tetrazolyl, pyrimidinyl, pyrazinyl, pyridazinyl, 1,3,5-triazinyl, 1,2,4-triazinyl, pyrazolinyl, imidazolinyl, oxazolinyl, isoxazolinyl, thiazolinyl, 3(2H)-pyridazinone, benzothiazolyl,

benzimidazolyl, indazolyl, benzoxazolyl, quinoxaliny, phthalazinyl, cinnoliny or quinazoliny group);

(b) when Q is a 2-thiazolyl group optionally substituted by R, then A is a naphthyl group optionally substituted by W, or a heterocyclic group optionally substituted by Y (said heterocyclic group being a thienyl, furyl, pyrrolyl, oxazolyl, isoxazolyl, thiazolyl, isothiazolyl, pyrazolyl, imidazolyl, 1,3,4-oxadiazolyl, 1,2,4-oxadiazolyl, 1,3,4-thiadiazolyl, 1,2,4-thiadiazolyl, 1,2,4-triazolyl, 1,2,3-thiadiazolyl, 1,2,3-triazolyl, 1,2,3,4-tetrazolyl, pyridinyl, pyrimidinyl, pyrazinyl, pyridazinyl, 1,3,5-triazinyl, 1,2,4-triazinyl, pyrazolinyl, imidazoliny, oxazoliny, isoxazoliny, thiazolinyl, 3(2H)-pyridazinone, benzothiazolyl, benzimidazolyl, indazolyl, benzoxazolyl, quinolyl, isoquinolyl, quinoxaliny, phthalazinyl, cinnoliny or quinazoliny group);

(c) when Q is a pyridyl group optionally substituted by R, then A is a heterocyclic group optionally substituted by Y (said heterocyclic group being a pyrrolyl, oxazolyl, isoxazolyl, thiazolyl, isothiazolyl, pyrazolyl, imidazolyl, 1,3,4-oxadiazolyl, 1,2,4-oxadiazolyl, 1,3,4-thiadiazolyl, 1,2,4-thiadiazolyl, 1,2,4-triazolyl, 1,2,3-thiadiazolyl, 1,2,3-triazolyl, 1,2,3,4-tetrazolyl, pyrazinyl, 1,3,5-triazinyl, 1,2,4-triazinyl, pyrazolinyl, imidazoliny, oxazoliny, isoxazoliny, thiazolinyl, 3(2H)-pyridazinone, benzothiazolyl, benzimidazolyl, indazolyl, benzoxazolyl, quinoxaliny, phthalazinyl, cinnoliny or quinazoliny group);

(d) when Q is an isothiazolyl group optionally substituted by R, a 1,2,3-triazolyl group optionally substituted by R, or a benzoxazolyl group optionally substituted by R, then A is a naphthyl group optionally substituted by W, or a heterocyclic group optionally substituted by Y (said heterocyclic group being a thienyl, furyl, pyrrolyl, oxazolyl, isoxazolyl, thiazolyl, isothiazolyl, pyrazolyl, imidazolyl, 1,3,4-oxadiazolyl, 1,2,4-oxadiazolyl, 1,3,4-thiadiazolyl, 1,2,4-thiadiazolyl, 1,2,4-triazolyl, 1,2,3-thiadiazolyl, 1,2,3-triazolyl, 1,2,3,4-tetrazolyl, pyridinyl, pyrimidinyl, pyrazinyl, pyridazinyl, 1,3,5-triazinyl, 1,2,4-triazinyl, pyrazolinyl, imidazoliny, oxazoliny, isoxazoliny, thiazolinyl, 3(2H)-pyridazinone, benzothiazolyl, benzimidazolyl, indazolyl, benzoxazolyl, quinolyl, isoquinolyl, quinoxaliny, phthalazinyl, cinnoliny or quinazoliny group);

(e) when Q is a 1,2,4-triazolyl group optionally substituted by R, then A is a heterocyclic group optionally substituted by Y (said heterocyclic group being a thienyl, furyl, pyrrolyl, oxazolyl, isoxazolyl, thiazolyl, isothiazolyl, pyrazolyl, imidazolyl, 1,3,4-oxadiazolyl, 1,2,4-oxadiazolyl, 1,3,4-thiadiazolyl, 1,2,4-thiadiazolyl, 1,2,4-triazolyl, 1,2,3-thiadiazolyl, 1,2,3-triazolyl, 1,2,3,4-tetrazolyl, pyrimidinyl, pyrazinyl, pyridazinyl, 1,3,5-triazinyl, 1,2,4-triazinyl, pyrazolinyl, imidazoliny, oxazoliny, isoxazoliny, thiazolinyl, 3(2H)-pyridazinone, benzothiazolyl, benzimidazolyl, indazolyl, benzoxazolyl, quinolyl, isoquinolyl, quinoxaliny, phthalazinyl, cinnoliny or quinazoliny group);

(f) when Q is a benzothiazolyl group optionally substituted by R, then A is a naphthyl group optionally substituted by W, or a heterocyclic group optionally substituted by Y (said heterocyclic group being a furyl, pyrrolyl, oxazolyl, isoxazolyl, thiazolyl, isothiazolyl, pyrazolyl, imidazolyl, 1,3,4-oxadiazolyl, 1,2,4-oxadiazolyl, 1,3,4-thiadiazolyl, 1,2,4-thiadiazolyl, 1,2,4-triazolyl, 1,2,3-thiadiazolyl, 1,2,3-triazolyl, 1,2,3,4-tetrazolyl, pyridinyl, pyrimidinyl, pyrazinyl, pyridazinyl, 1,3,5-triazinyl, 1,2,4-triazinyl, pyrazolinyl, imidazoliny, oxazoliny, isoxazoliny,

thiazolinyl, 3(2H)-pyridazinone, benzothiazolyl, benzimidazolyl, indazolyl, benzoxazolyl, quinolyl, isoquinolyl, quinoxaliny, phthalazinyl, cinnoliny or quinazoliny group);

(g) when Q is a benzimidazolyl group optionally substituted by R, then A is a naphthyl group optionally substituted by W, or a heterocyclic group optionally substituted by Y (said heterocyclic group being a pyrrolyl, oxazolyl, isoxazolyl, thiazolyl, isothiazolyl, pyrazolyl, imidazolyl, 1,3,4-oxadiazolyl, 1,2,4-oxadiazolyl, 1,3,4-thiadiazolyl, 1,2,4-thiadiazolyl, 1,2,4-triazolyl, 1,2,3-thiadiazolyl, 1,2,3-triazolyl, 1,2,3,4-tetrazolyl, pyrazinyl, 1,3,5-triazinyl, 1,2,4-triazinyl, pyrazolinyl, imidazoliny, oxazoliny, isoxazoliny, thiazolinyl, 3(2H)-pyridazinone, benzothiazolyl, benzimidazolyl, indazolyl, benzoxazolyl, quinolyl, isoquinolyl, quinoxaliny, phthalazinyl, cinnoliny or quinazoliny group);

(h) when Q is a phenyl group optionally substituted by G, then A is a heterocyclic group optionally substituted by Y (said heterocyclic group being a pyrrolyl, oxazolyl, isoxazolyl, thiazolyl, isothiazolyl, pyrazolyl, 1,3,4-oxadiazolyl, 1,2,4-oxadiazolyl, 1,3,4-thiadiazolyl, 1,2,4-thiadiazolyl, 1,2,4-triazolyl, 1,2,3-thiadiazolyl, 1,2,3-triazolyl, 1,2,3,4-tetrazolyl, pyrazinyl, pyridazinyl, 1,3,5-triazinyl, 1,2,4-triazinyl, pyrazolinyl, imidazoliny, oxazoliny, isoxazoliny, thiazolinyl, 3(2H)-pyridazinone, benzothiazolyl, benzimidazolyl, indazolyl, benzoxazolyl, quinoxaliny, phthalazinyl, cinnoliny or quinazoliny group);

(i) when Q is a naphthyl group optionally substituted by G, then A is a heterocyclic group optionally substituted by Y (said heterocyclic group being a thienyl, pyrrolyl, oxazolyl, isoxazolyl, thiazolyl, isothiazolyl, pyrazolyl, imidazolyl, 1,3,4-oxadiazolyl, 1,2,4-oxadiazolyl, 1,3,4-thiadiazolyl, 1,2,4-thiadiazolyl, 1,2,4-triazolyl, 1,2,3-thiadiazolyl, 1,2,3-triazolyl, 1,2,3,4-tetrazolyl, pyridinyl, pyrimidinyl, pyrazinyl, pyridazinyl, 1,3,5-triazinyl, 1,2,4-triazinyl, pyrazolinyl, imidazoliny, oxazoliny, isoxazoliny, thiazolinyl, 3(2H)-pyridazinone, benzothiazolyl, benzimidazolyl, indazolyl, benzoxazolyl, quinolyl, isoquinolyl, quinoxaliny, phthalazinyl, cinnoliny or quinazoliny group);

B represents H, a C₁-C₄ alkyl group, a C₁-C₄ haloalkyl group, a C₂-C₄ alkoxyalkyl group, CH₃SCH₂, CH₃OC₂H₄OCH₂, a C₁-C₄ alkyl group substituted by a phenyl group optionally substituted by a halogen or a C₁-C₄ alkyl group, a C₁-C₄ alkyl group substituted by a benzoyl group optionally substituted by a halogen or a C₁-C₄ alkyl group, a tetrahydropyranyl group, (CH₃)₃Si, a C₁-C₄ alkylsulfonyl group, a phenylsulfonyl group optionally substituted by a halogen or a C₁-C₄ alkyl group, —SO₂CF₃, a C₁-C₄ monoalkylaminosulfonyl group, a C₂-C₈ dialkylaminosulfonyl group, a phenylaminosulfonyl group, a C₂-C₅ monoalkylaminothiocarbonyl group, a C₃-C₉ dialkylaminothiocarbonyl group, a C₂-C₅ cyanoalkyl group, a C₃-C₉ alkoxy-carbonylalkyl group, —C(=O)T¹, —P(=O)T²T³, —P(=S)T²T³, an alkali metal atom, an alkaline earth metal atom, or NHT⁴T⁵T⁶;

provided that, when Q is a 2-thiazolyl or 2-benzothiazolyl group, then B is a C₁-C₄ alkyl group, a C₁-C₄ haloalkyl group, a C₂-C₄ alkoxyalkyl group, CH₃SCH₂, CH₃OC₂H₄OCH₂, a C₁-C₄ alkyl group substituted by a phenyl group optionally substituted by a halogen or a C₁-C₄ alkyl group, a C₁-C₄ alkyl group substituted by a benzoyl group optionally substituted by a halogen or a C₁-C₄ alkyl group, a tetrahydropyranyl group, (CH₃)₃Si, a C₁-C₄ alkylsulfonyl group, a phenylsulfonyl group optionally substituted

tuted by a halogen or a C₁-C₄ alkyl group, —SO₂CF₃, a C₁-C₄ monoalkylaminosulfonyl group, a C₂-C₈ dialkylaminosulfonyl group, a phenylaminosulfonyl group, a C₂-C₅ monoalkylaminothiocarbonyl group, a C₃-C₉ dialkylaminothiocarbonyl group, a C₂-C₅ cyanoalkyl group, a C₃-C₉ alkoxyalkyl group, —C(=O)T¹, —P(=O)T²T³, or —P(=S)T²T³;

E represents a heterocyclic group optionally substituted by a C₁-C₄ alkyl or C₁-C₄ haloalkyl group—(said heterocyclic group being a 2-oxazolyl, 2-thiazolyl, 2-imidazolyl, 1,2,4-triazol-3-yl, 1,2,4-oxadiazol-3-yl, 1,2,4-thiadiazol-3-yl, 1,3,4-oxadiazol-2-yl, 5-tetrazolyl, 2-oxazoliny or 1,2,4,5-tetrazin-3-yl group) - or represents a halogen, a C₂-C₄ alkynyl group, a phenylethynyl group optionally substituted by Z, a C₁-C₄ haloalkyl group, CN, an isonitrile group, NO₂, N₃, CHO, a C₂-C₅ alkylcarbonyl group, a C₂-C₅ alkoxyalkyl group, a C₃-C₅ alkenyloxyalkyl group, a C₂-C₄ alkylaminocarbonyl group, a C₃-C₉ dialkylaminocarbonyl group, a benzoyl group optionally substituted by Z, an aminothiocarbonyl group, a C₁-C₄ alkylsulfenyl group, a C₁-C₄ alkylsulfanyl group, a C₁-C₄ alkylsulfonyl group, a phenylsulfenyl group optionally substituted by Z, a phenylsulfanyl group optionally substituted by Z, a phenylsulfonyl group optionally substituted by Z, —P(=O)T²T³, or —P(=S)T²T³.

G is a substituent freely selected from a halogen atom, a C₁-C₁₀ alkyl group, a C₂-C₄ cyanoalkyl group, a C₁-C₄ alkyl group substituted by a phenyl group optionally substituted by a halogen or a C₁-C₄ alkyl group, a C₂-C₄ alkenyl group, a C₂-C₆ alkynyl group, a C₁-C₆ haloalkyl group, a C₂-C₆ haloalkenyl group, a C₂-C₆ haloalkynyl group, a C₃-C₆ halocycloalkyl group, a C₃-C₆ cycloalkyl group optionally substituted by a C₁-C₃ alkyl group, a C₁-C₁₀ alkoxy group, a C₂-C₆ alkenyloxy group, a C₂-C₆ alkynyloxy group, a C₁-C₄ haloalkoxy group, a C₂-C₆ haloalkenyloxy group, a C₂-C₆ haloalkynyloxy group, a C₁-C₄ alkylsulfenyl group, a C₁-C₄ alkylsulfanyl group, a C₁-C₄ alkylsulfonyl group, a C₂-C₆ alkenylsulfenyl group, a C₂-C₆ alkenylsulfanyl group, a C₂-C₆ alkenylsulfonyl group, a C₂-C₆ alkynylsulfenyl group, a C₂-C₆ alkynylsulfanyl group, a C₂-C₆ alkynylsulfonyl group, a C₁-C₄ haloalkylsulfenyl group, a C₁-C₄ haloalkylsulfanyl group, a C₁-C₄ haloalkylsulfonyl group, a C₂-C₆ haloalkenylsulfenyl group, a C₂-C₆ haloalkenylsulfanyl group, a C₂-C₆ haloalkenylsulfonyl group, a C₂-C₆ haloalkynylsulfenyl group, a C₂-C₆ haloalkynylsulfanyl group, a C₂-C₆ haloalkynylsulfonyl group, CHO, NO₂, CN, —NU¹U², OH, a naphthyl group, a methoxy group substituted by a phenyl group optionally substituted by a halogen or a C₁-C₄ alkyl group, a C₂-C₇ alkoxyalkyl group, a C₂-C₄ alkoxyalkyl group, a C₂-C₄ alkylcarbonyl group, a C₂-C₄ haloalkylcarbonyl group, a C₂-C₅ alkylcarbonyloxy group, a C₂-C₅ haloalkylcarbonyloxy group, a C₃-C₇ dialkylaminocarbonyloxy group, a phenyl group optionally substituted by Z, a phenoxy group optionally substituted by Z, a benzoyl group optionally substituted by Z, a pyridyl group optionally substituted by Z, a pyridyloxy group optionally substituted by Z, a thienyl group optionally substituted by Z, a methylenedioxy group as bonded at the adjacent substituting positions, a halomethylenedioxy group as bonded at the adjacent substituting positions, and —N=CT⁷T⁸ (in which T⁷ and T⁸ each independently represent H, or a phenyl, benzyl or C₁-C₆ alkyl group, or T⁷ and T⁸, together with the carbon atom to which they are bonded, form a 5-, 6-, 7- or 8-membered ring), (provided that when the the substituent is two or more, then said substituents may be the same or different), and the number of the substituent, G, is 1, 2, 3 or

4; or G is an alkylene group as bonded to the adjacent substituting positions to form a 5-, 6-, 7- or 8-membered ring;

R is a substituent freely selected from a halogen atom, a C₁-C₁₀ alkyl group, a C₁-C₄ alkyl group substituted by a phenyl group optionally substituted by a halogen or a C₁-C₄ alkyl group, a C₂-C₈ alkenyl group, a C₂-C₆ alkynyl group, a C₁-C₆ haloalkyl group, a C₂-C₆ haloalkenyl group, a C₂-C₆ haloalkynyl group, a C₃-C₆ halocycloalkyl group, a C₃-C₆ cycloalkyl group optionally substituted by a C₁-C₃ alkyl group, a C₁-C₆ alkoxy group, a C₂-C₆ alkenyloxy group, a C₂-C₆ alkynyloxy group, a C₁-C₄ haloalkoxy group, a C₂-C₆ haloalkenyloxy group, a C₂-C₆ haloalkynyloxy group, a C₁-C₄ alkylsulfenyl group, a C₁-C₄ alkylsulfanyl group, a C₁-C₄ alkylsulfonyl group, a C₂-C₆ alkenylsulfenyl group, a C₂-C₆ alkenylsulfanyl group, a C₂-C₆ alkenylsulfonyl group, a C₂-C₆ alkynylsulfenyl group, a C₂-C₆ alkynylsulfanyl group, a C₂-C₆ alkynylsulfonyl group, a C₁-C₄ haloalkylsulfenyl group, a C₁-C₄ haloalkylsulfanyl group, a C₁-C₄ haloalkylsulfonyl group, a C₂-C₆ haloalkenylsulfenyl group, a C₂-C₆ haloalkenylsulfanyl group, a C₂-C₆ haloalkenylsulfonyl group, a C₂-C₆ haloalkynylsulfenyl group, a C₂-C₆ haloalkynylsulfanyl group, a C₂-C₆ haloalkynylsulfonyl group, NO₂, CN, —NU¹U², a phenoxy group, OH, a naphthyl group, a C₂-C₇ alkoxyalkyl group, a C₂-C₄ alkoxyalkyl group, a C₂-C₄ alkylcarbonyl group, a C₂-C₅ alkylcarbonyloxy group, a C₂-C₅ haloalkylcarbonyloxy group, a benzoyl group optionally substituted by X, a phenyl group optionally substituted by X, a pyridyl group optionally substituted by X, a thienyl group optionally substituted by X, and —N=CT⁷T⁸, (provided that when the substituent is two or more, then said substituents may be the same or different), and the number of the substituents, R, is 1, 2, 3 or 4; or R is an alkylene group as bonded to the adjacent substituting positions to form a 5-, 6-, 7- or 8-membered ring;

Y is a substituent freely selected from a halogen atom, a C₁-C₁₀ alkyl group, a C₁-C₆ haloalkyl group, a C₁-C₆ alkoxy group, a C₂-C₆ alkenyloxy group, a C₂-C₆ alkynyloxy group, a C₁-C₄ haloalkoxy group, a C₂-C₆ haloalkenyloxy group, a C₂-C₆ haloalkynyloxy group, a C₁-C₄ alkylsulfenyl group, a C₁-C₄ alkylsulfanyl group, a C₁-C₄ alkylsulfonyl group, a C₂-C₆ alkenylsulfenyl group, a C₂-C₆ alkenylsulfanyl group, a C₂-C₆ alkenylsulfonyl group, a C₂-C₆ alkynylsulfenyl group, a C₂-C₆ alkynylsulfanyl group, a C₂-C₆ alkynylsulfonyl group, a C₁-C₄ haloalkylsulfenyl group, a C₁-C₄ haloalkylsulfanyl group, a C₁-C₄ haloalkylsulfonyl group, a C₂-C₆ haloalkenylsulfenyl group, a C₂-C₆ haloalkenylsulfanyl group, a C₂-C₆ haloalkenylsulfonyl group, a C₂-C₆ haloalkynylsulfenyl group, a C₂-C₆ haloalkynylsulfanyl group, a C₂-C₆ haloalkynylsulfonyl group, a C₁-C₄ haloalkylsulfenyl group, a C₁-C₄ haloalkylsulfanyl group, a C₁-C₄ haloalkylsulfonyl group, a C₂-C₆ haloalkenylsulfenyl group, a C₂-C₆ haloalkenylsulfanyl group, a C₂-C₆ haloalkenylsulfonyl group, a C₂-C₆ haloalkynylsulfenyl group, a C₂-C₆ haloalkynylsulfanyl group, a C₂-C₆ haloalkynylsulfonyl group, NO₂, CN, —NU¹U², OH, a C₂-C₇ alkoxyalkyl group, a C₂-C₄ alkoxyalkyl group, a C₂-C₆ alkylcarbonyloxy group, a C₂-C₅ haloalkylcarbonyloxy group, a C₃-C₇ dialkylaminocarbonyloxy group, a phenyl group optionally substituted by X, and —N=CT⁷T⁸ (in which T⁷ and T⁸ each independently represent H, or a phenyl, benzyl or C₁-C₆ alkyl group, or T⁷ and T⁸ may, together with the carbon atom to which they are bonded, form a 5-, 6-, 7- or 8-membered ring), (provided that when the substituent is two or more, then said substituents may be the same or different), and the number of the substituent, Y, is 1, 2, 3 or 4; or Y is an alkylene group as bonded to the adjacent substituting positions to form a 5-, 6-, 7- or 8-membered ring;

W is a substituent freely selected from a halogen atom, a C₁-C₆ alkyl group, a C₁-C₄ haloalkyl group, a C₁-C₄

alkoxy group, a C₁-C₄ haloalkoxy group, a C₁-C₄ alkylsulfenyl group, a C₁-C₄ alkylsulfanyl group, a C₁-C₄ alkylsulfonyl group, a C₁-C₄ haloalkylsulfenyl group, a C₁-C₄ haloalkylsulfanyl group, a C₁-C₄ haloalkylsulfonyl group, a C₂-C₄ alkenyl group, a C₂-C₄ haloalkenyl group, a C₂-C₄ alkenyloxy group, a C₂-C₄ haloalkenyloxy group, a C₂-C₄ alkenylsulfenyl group, a C₂-C₄ alkenylsulfanyl group, a C₂-C₄ alkenylsulfonyl group, a C₂-C₄ haloalkenylsulfenyl group, a C₂-C₄ haloalkenylsulfanyl group, a C₂-C₄ haloalkenylsulfonyl group, a C₂-C₄ alkynyl group, a C₂-C₄ haloalkynyl group, a C₂-C₄ alkynyloxy group, a C₂-C₄ haloalkynyloxy group, a C₂-C₄ alkynylsulfenyl group, a C₂-C₄ alkynylsulfanyl group, a C₁-C₄ alkynylsulfonyl group, a C₂-C₄ haloalkynylsulfenyl group, a C₂-C₄ haloalkynylsulfanyl group, a C₂-C₄ haloalkynylsulfonyl group, NO₂, CN, a formyl group, a C₂-C₆ alkoxy-carbonyl group, a C₂-C₆ alkylcarbonyl group, a C₂-C₆ haloalkylcarbonyl group, a C₂-C₆ alkylcarbonyloxy group, and —NU¹U², (provided that when the substituent is two or more, then said substituents may be the same or different), and the number of the substituent, W, is 1, 2, 3 or 4;

T¹ represents a C₁-C₂₀ alkyl group, a C₂-C₆ alkenyl group, a C₁-C₆ haloalkyl group, a C₁-C₄ alkoxy-C₁-C₄ alkyl group, a C₃-C₆ halocycloalkyl group, a C₁-C₄ alkyl group substituted by a phenyl group optionally substituted by a halogen or a C₁-C₄ alkyl group, a C₃-C₆ cycloalkyl group optionally substituted by a C₁-C₃ alkyl group, a cycloalkyl group substituted by a phenyl group optionally substituted by a halogen or a C₁-C₃ alkyl group, a cyclopropyl group substituted by both a phenyl group optionally substituted by a halogen or a C₁-C₄ alkyl group and a C₁-C₄ alkyl group, a C₃-C₄ cycloalkyl group substituted by both a phenyl group optionally substituted by a halogen or a C₁-C₄ alkoxy group, and a halogen, a cyclopropyl group substituted by both a C₂-C₄ alkenyl group optionally substituted by a halogen, and a C₁-C₄ alkyl group, a C₂-C₄ alkenyl group substituted by a phenyl group optionally substituted by a halogen or a C₁-C₄ alkyl group, a C₁-C₁₂ alkoxy group, a C₁-C₄ haloalkoxy group, a C₂-C₅ alkenyloxy group, a C₃-C₆ cycloalkoxy group optionally substituted by a C₁-C₃ alkyl group, a benzyloxy group, a C₂-C₆ alkoxy-carbonyl group, —NU¹U², a phenylamino group, a phenyl group optionally substituted by Z, a phenoxy group optionally substituted by Z, a phenylthio group optionally substituted by Z, a naphthyl group optionally substituted by Z, or a 5-membered or 6-membered heterocyclic group optionally substituted by Z, (said heterocyclic group being selected from thienyl, furyl, pyrrolyl, oxazolyl, isoxazolyl, thiazolyl, isothiazolyl, pyrazolyl, imidazolyl, 1,3,4-oxadiazolyl, 1,2,4-oxadiazolyl, 1,3,4-thiadiazolyl, 1,2,4-thiadiazolyl, 1,2,3-thiadiazolyl, 1,2,3-triazolyl, 1,2,3,4-tetrazolyl, pyridinyl, pyrimidinyl, pyrazinyl, pyridazinyl, 1,3,5-triazinyl, 1,2,4-triazinyl, pyrazolinyl, imidazolinyl, oxazolynyl, isoxazolynyl, thiazolinyl and 3(2H)-pyridazinone groups);

T² and T³ each independently represent OH, a phenyl group, a C₁-C₆ alkyl group, a C₁-C₆ alkoxy group, or a C₁-C₄ alkylsulfenyl group;

T⁴, T⁶ and T⁸ each independently represent H, a C₁-C₆ alkyl group, a C₁-C₆ alkenyl group, a C₃-C₆ cycloalkyl group optionally substituted by a C₁-C₃ alkyl group, or a benzyl group; or any two of T⁴, T⁵ and T⁶ may, together with the nitrogen atom to which they are bonded, form a 5-, 6-, 7- or 8-membered cyclic group optionally containing oxygen, nitrogen and/or sulfur atoms;

X and Z are independently substituents as freely selected from a halogen atom, a C₁-C₄ alkyl group, a C₁-C₄

haloalkyl group, a C₁-C₄ alkoxy group, a C₁-C₄ haloalkoxy group, a C₁-C₄ alkylsulfenyl group, a C₁-C₄ alkylsulfanyl group, a C₁-C₄ alkylsulfonyl group, a C₂-C₅ alkenylsulfenyl group, a C₂-C₅ alkenylsulfanyl group, a C₂-C₅ alkenylsulfonyl group, a C₁-C₄ haloalkylsulfenyl group, a C₁-C₄ haloalkylsulfanyl group, a C₁-C₄ haloalkylsulfonyl group, NO₂, CN, CHO, OH, —NU¹U², a phenyl group, a phenoxy group, and a C₂-C₅ alkoxy-carbonyl group, (provided that when the substituent is two or more, then said substituents may be the same or different), and the number of the substituent, X and Z, is 1, 2, 3, 4 or 5 each;

T⁷ and T⁸ each independently represent H, or a phenyl, benzyl or C₁-C₆ alkyl group, or T⁷ and T⁸ may, together with the carbon atom to which they are bonded, form a 5-, 6-, 7- or 8-membered ring; and

U¹ and U² each independently represent H, a C₁-C₆ alkyl, C₂-C₆ alkylcarbonyl, phenyl or benzyl group, or U¹ and U² may, together with the nitrogen atom to which they are bonded, form a 5-, 6-, 7- or 8-membered ring.

[2] Ethylene derivatives of the above-mentioned 1], in which;

Q is a phenyl group optionally substituted by G, a naphthyl group optionally substituted by G, or a heterocyclic group optionally substituted by R, (said heterocyclic group being a thienyl, furyl, pyrrolyl, oxazolyl, isoxazolyl, thiazolyl, isothiazolyl, pyrazolyl, imidazolyl, 1,3,4-oxadiazolyl, 1,2,4-oxadiazolyl, 1,3,4-thiadiazolyl, 1,2,4-thiadiazolyl, 1,2,4-triazolyl, 1,2,3-triazolyl, 1,2,3,4-tetrazolyl, pyridinyl, pyrimidinyl, pyrazinyl, pyridazinyl, 1,3,5-triazinyl, 1,2,4-triazinyl, 1,2,4,5-tetrazinyl, pyrazolinyl, imidazolinyl, imidazolinone or imidazolidinedione group;

A is a phenyl group optionally substituted by W, a naphthyl group optionally substituted by W, or a heterocyclic group optionally substituted by Y, said heterocyclic group being a thienyl, furyl, pyrrolyl, oxazolyl, isoxazolyl, thiazolyl, isothiazolyl, pyrazolyl, imidazolyl, 1,3,4-oxadiazolyl, 1,2,4-oxadiazolyl, 1,3,4-thiadiazolyl, 1,2,4-thiadiazolyl, 1,2,4-triazolyl, 1,2,3-thiadiazolyl, 1,2,3-triazolyl, 1,2,3,4-tetrazolyl, pyridinyl, pyrimidinyl, pyrazinyl, pyridazinyl, 1,3,5-triazinyl, 1,2,4-triazinyl, pyrazolinyl or imidazolinyl group;

B is H, a C₁-C₄ alkyl group, a C₁-C₄ haloalkyl group, a C₂-C₄ alkoxyalkyl group, CH₃OC₂H₄OCH₂, a C₁-C₄ alkylsulfonyl group, a phenylsulfonyl group optionally substituted by a halogen or a C₁-C₄ alkyl group, —SO₂CF₃, a C₁-C₈ dialkylaminosulfonyl group, a C₂-C₉ dialkylaminothiocarbonyl group, a C₃-C₉ alkoxy-carbonylalkyl group, —C(=O)T¹, —P(=O)T²T³, —P(=S)T²T³, an alkali metal atom, an alkaline earth metal atom, or NHT⁴T⁵T⁶; and

T¹ is a C₁-C₂ O alkyl group, a C₂-C₆ alkenyl group, a C₁-C₄ haloalkyl group, a C₁-C₄ alkoxy-C₁-C₄ alkyl group, a C₁-C₄ alkyl group substituted by a phenyl group optionally substituted by a halogen or a C₁-C₄ alkyl group, a C₃-C₆ halocycloalkyl group, a C₃-C₆ cycloalkyl group optionally substituted by a C₁-C₃ alkyl group, a cycloalkyl group substituted by a phenyl group optionally substituted by a halogen or a C₁-C₄ alkyl group, a cyclopropyl group substituted by both a phenyl optionally substituted by a halogen or a C₁-C₄ alkyl group, and a C₁-C₄ alkyl group, a C₃-C₄ cycloalkyl group substituted by both a phenyl group optionally substituted by a halogen or a C₁-C₄ alkoxy group and a halogen, a cyclopropyl group substituted by both a C₂-C₄ alkenyl group optionally substituted by a halogen and a C₁-C₄ alkyl group, a C₂-C₄ alkenyl group substituted by a phenyl group optionally substituted by a halogen or a C₁-C₄ alkyl group, a C₁-C₁₂ alkoxy group, a C₁-C₄

9

haloalkoxy group, a C₂-C₅ alkenyloxy group, a C₃-C₆ cycloalkoxy group optionally substituted by a C₁-C₃ alkyl group, a benzyloxy group, a C₂-C₆ alkoxy carbonyl group, a phenyl group optionally substituted by Z, a phenoxy group optionally substituted by Z, a phenylthio group, a naphthyl group, or a heterocyclic group optionally substituted by Z, said heterocyclic group being selected from thienyl, furyl, oxazolyl, thiazolyl, pyrazolyl and pyridinyl groups.

[3] Ethylene derivatives of the above-mentioned [2], in which;

Q is a phenyl group optionally substituted by G, a naphthyl group optionally substituted by G, or a heterocyclic group optionally substituted by R, said heterocyclic group being

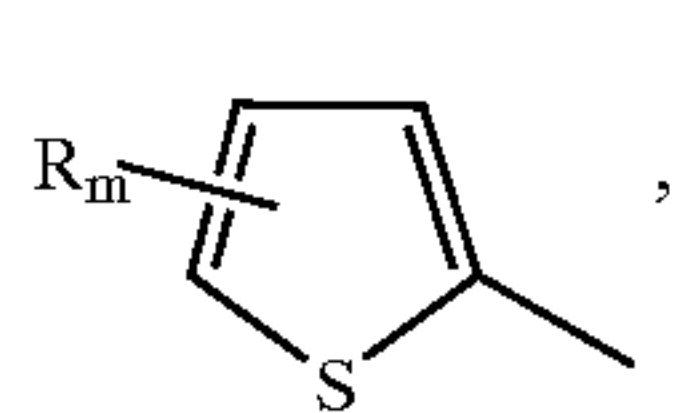

Q-1

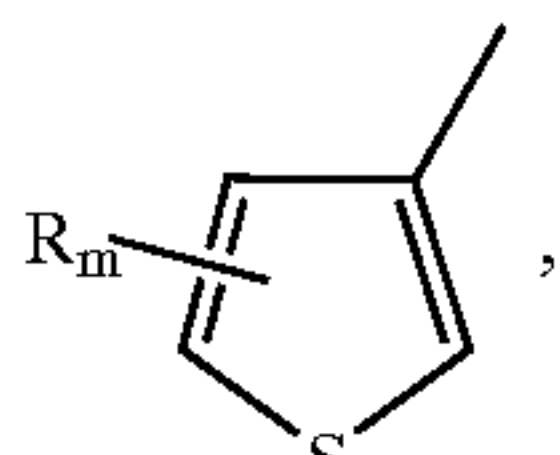

Q-2

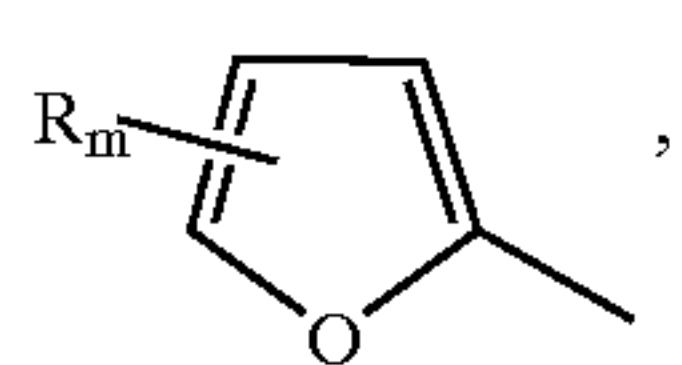

Q-3

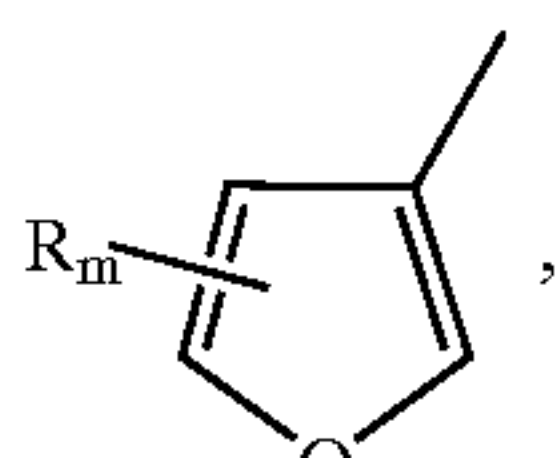

Q-4

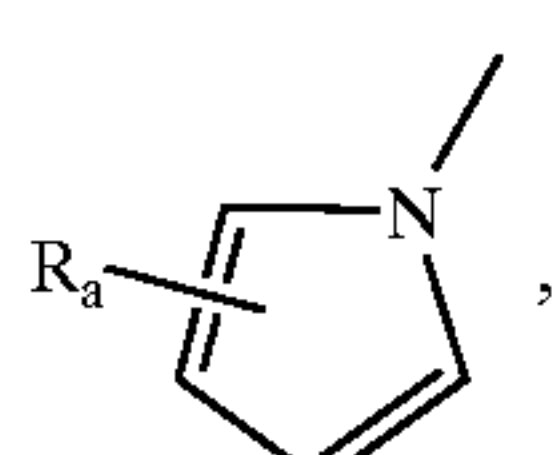

Q-5

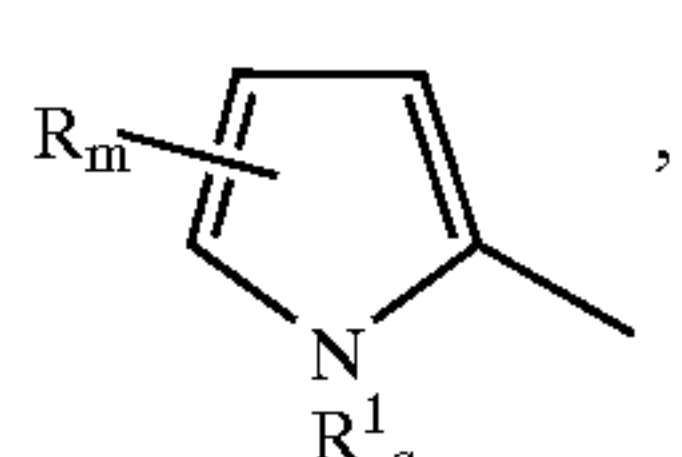

Q-6

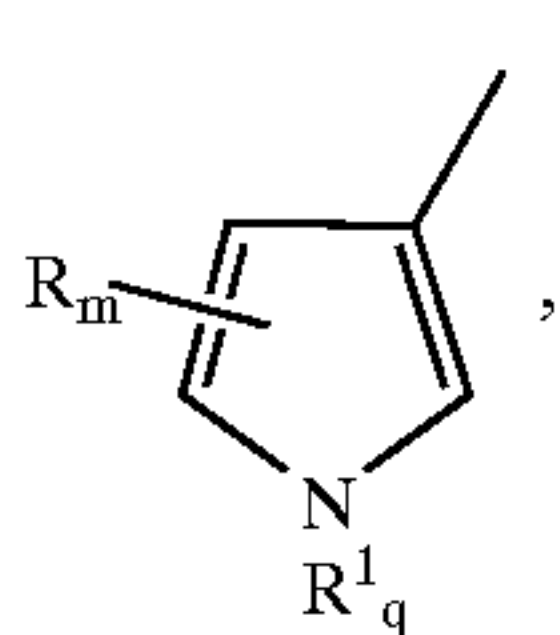

Q-7

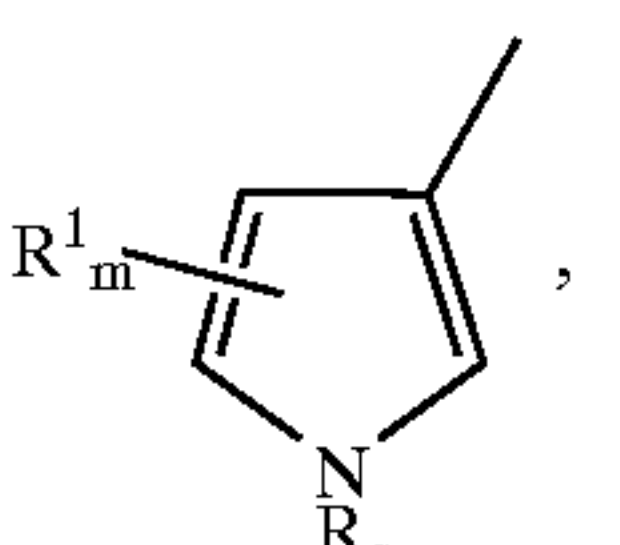

Q-8

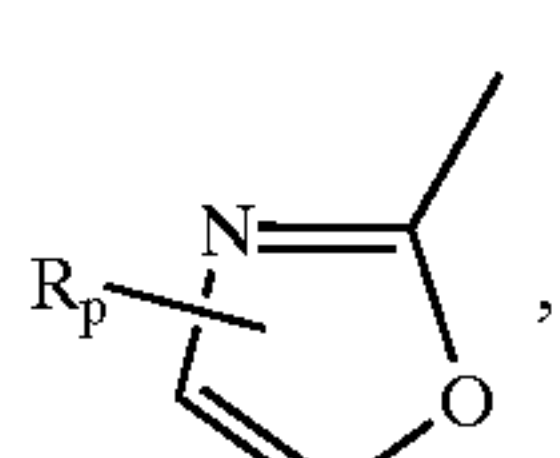

Q-9

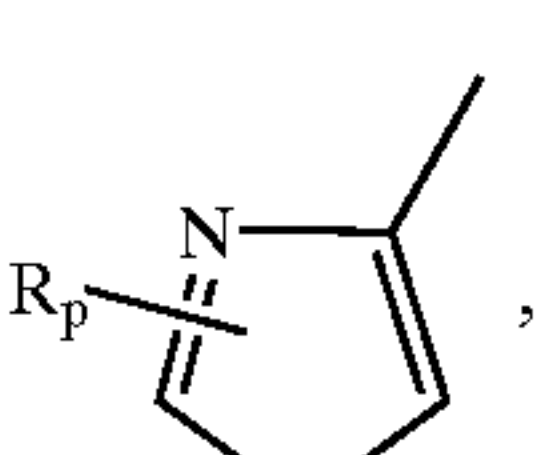

Q-10

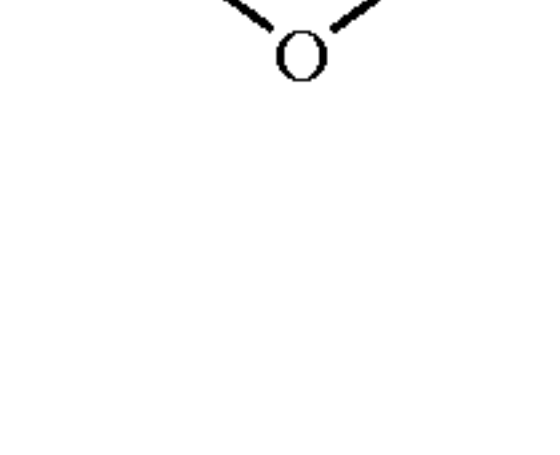

Q-11

10

-continued

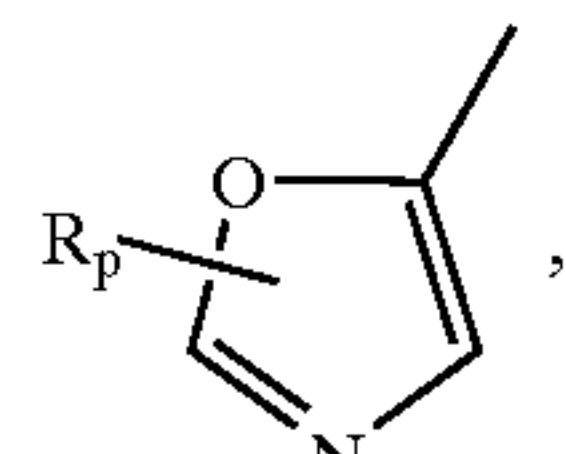

Q-11

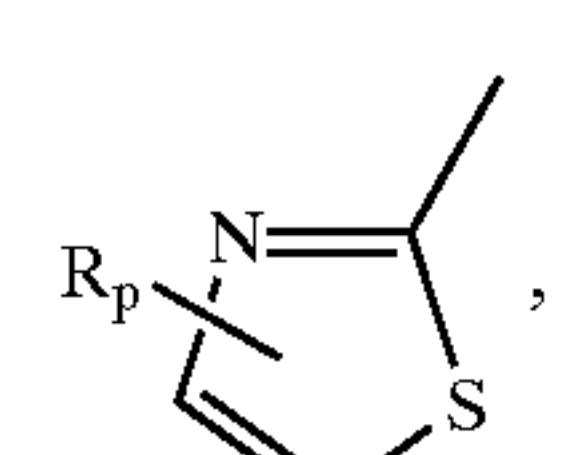

Q-12

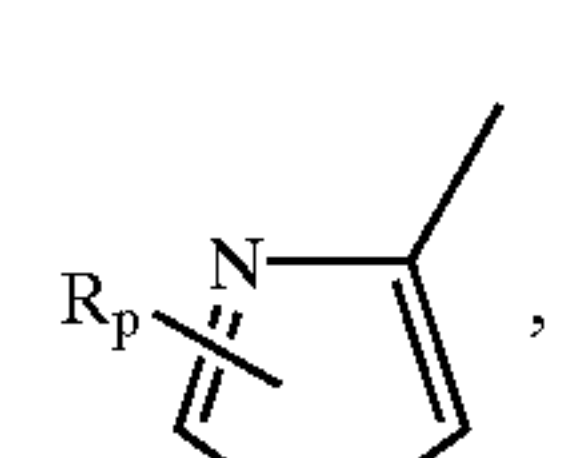

Q-13

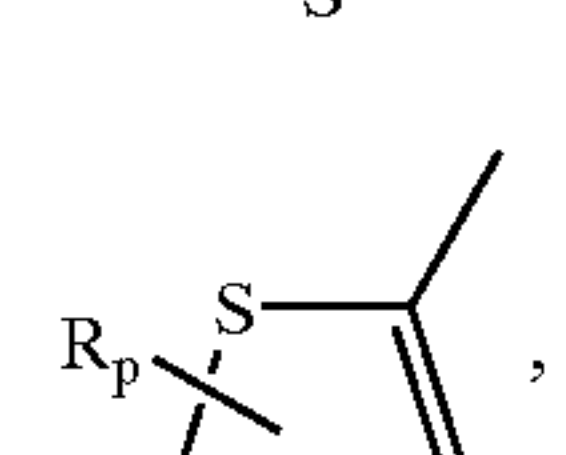

Q-14

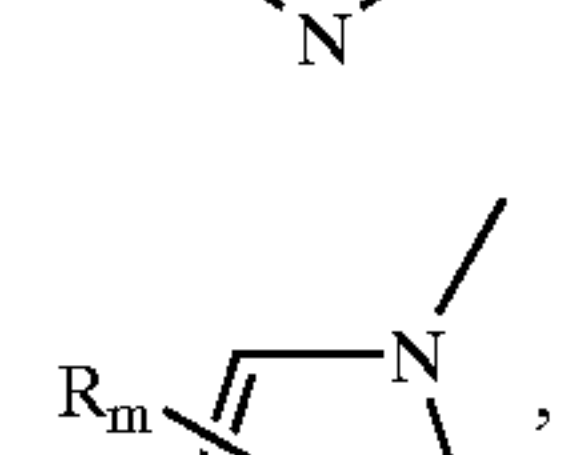

Q-15

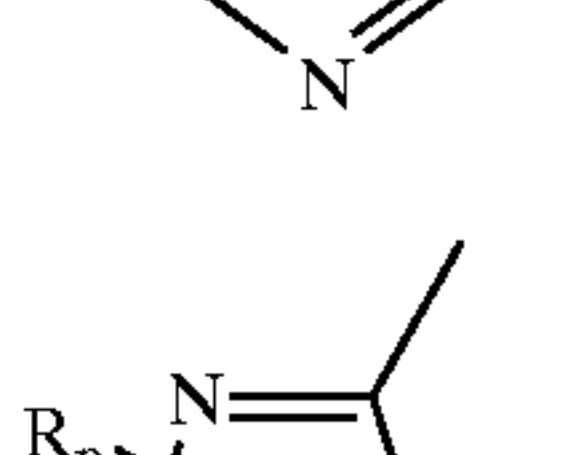

Q-16

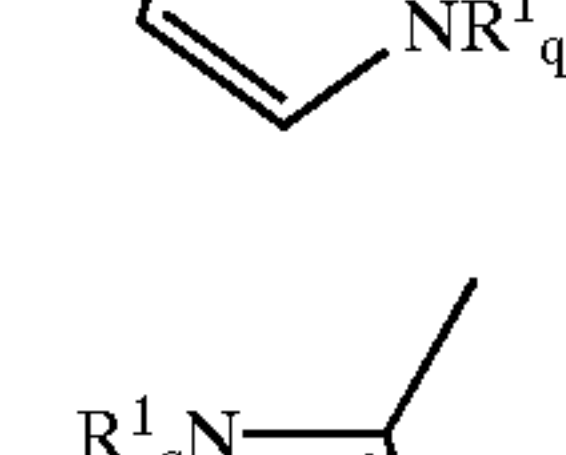

Q-17

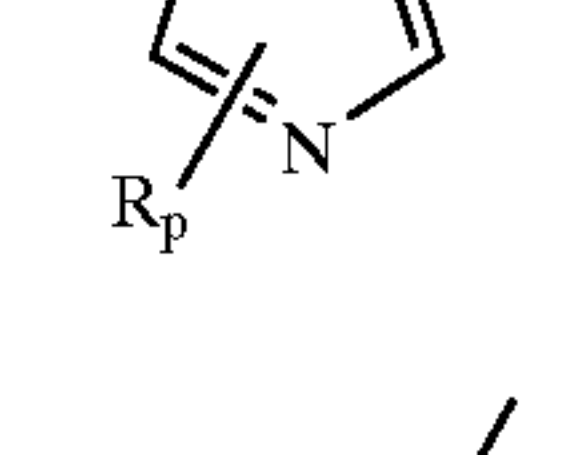

Q-18

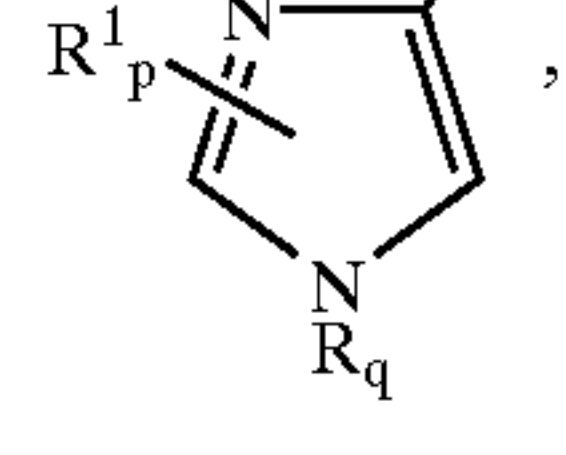

Q-19

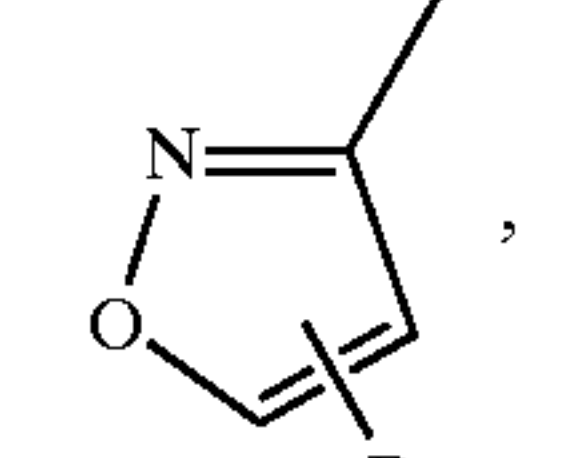

Q-20

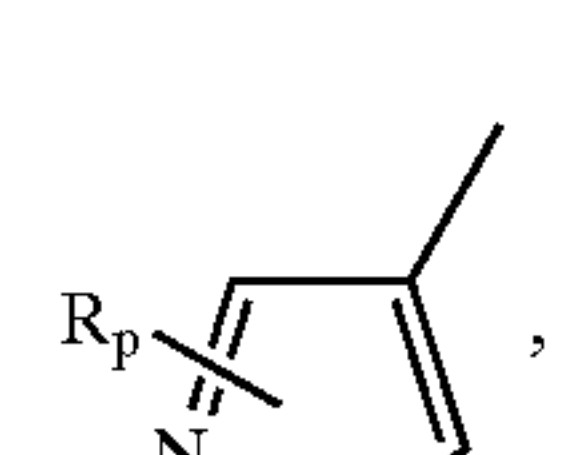

Q-21

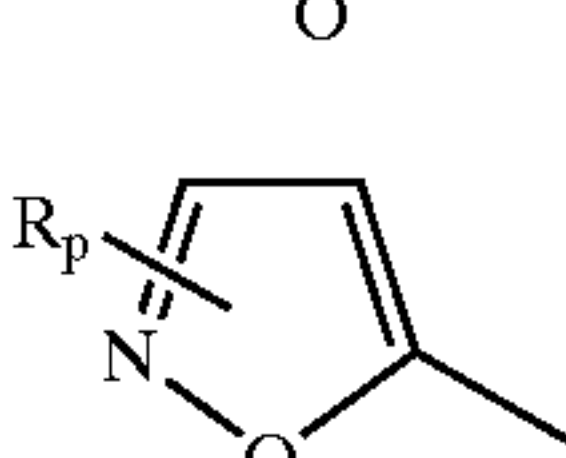

Q-22

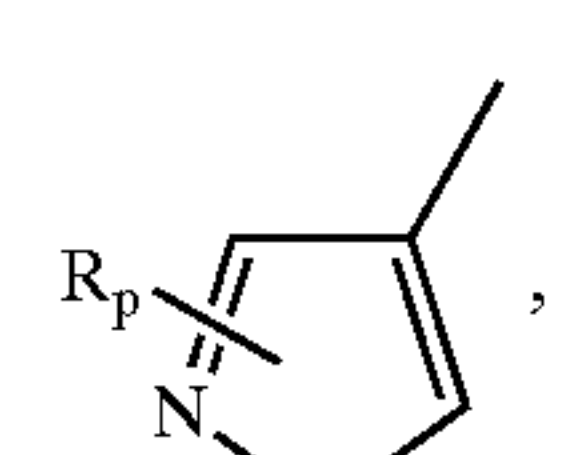

Q-23

11

-continued

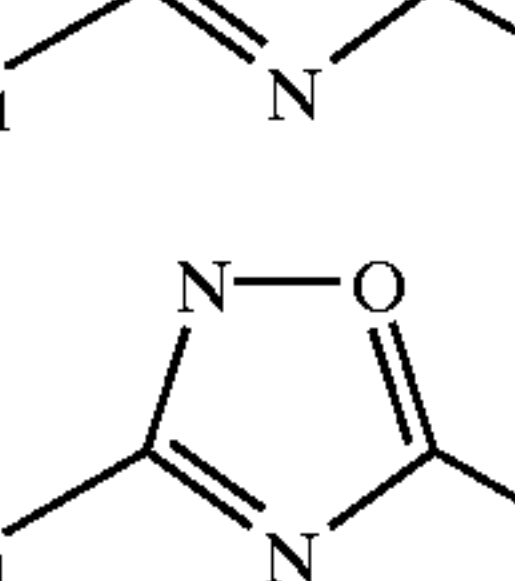
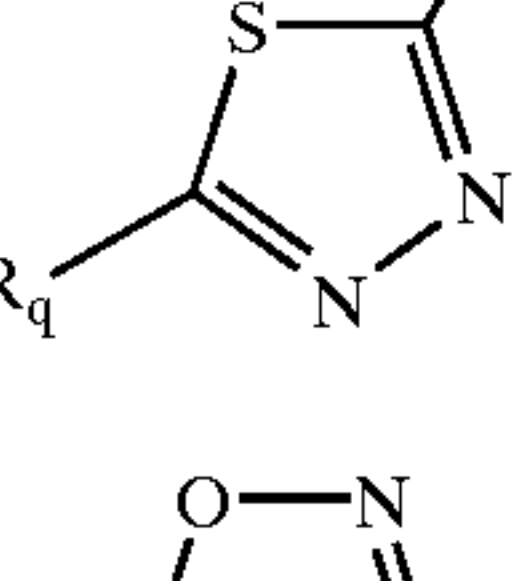
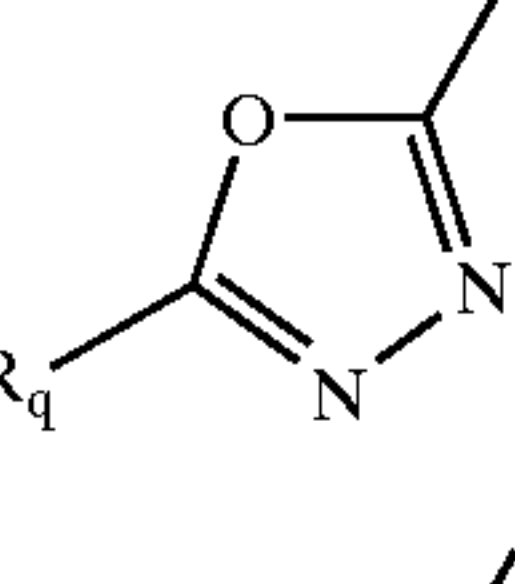
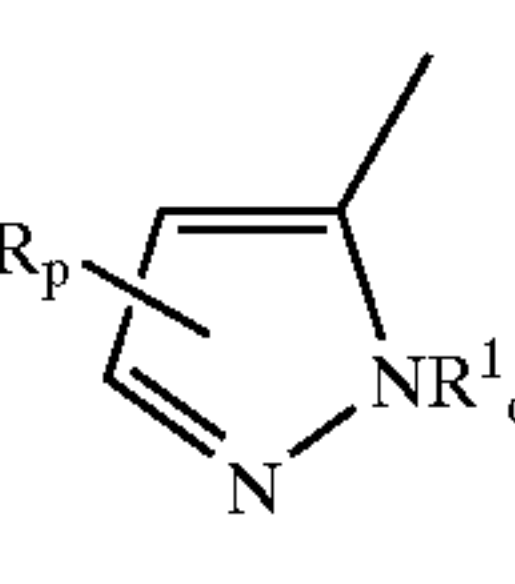
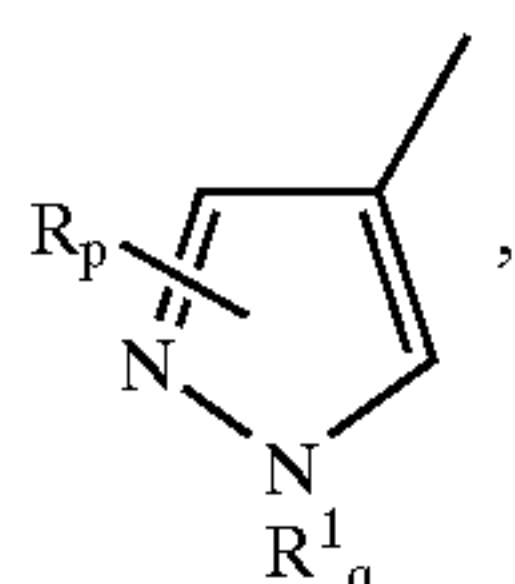
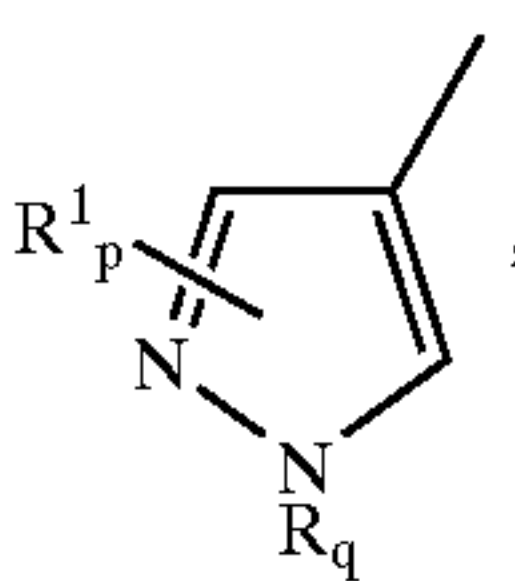
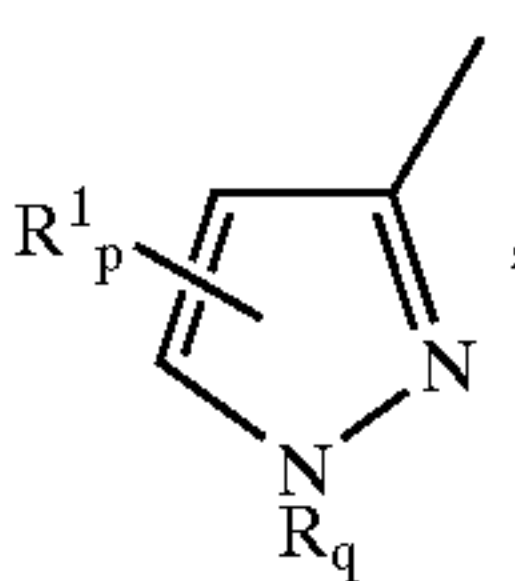
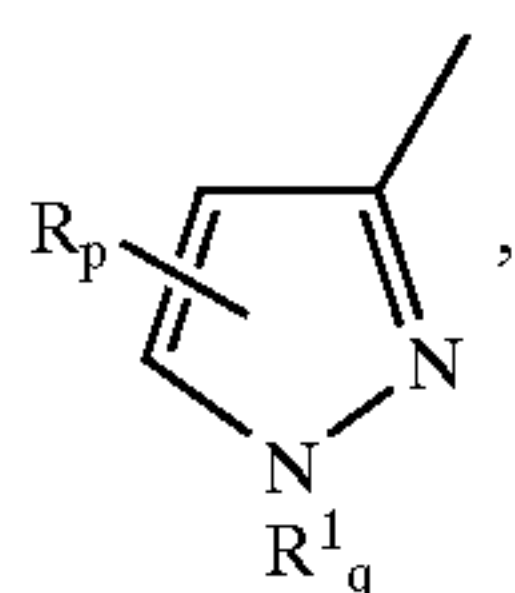
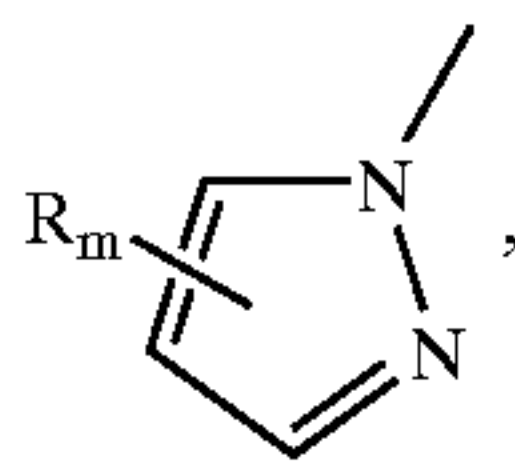
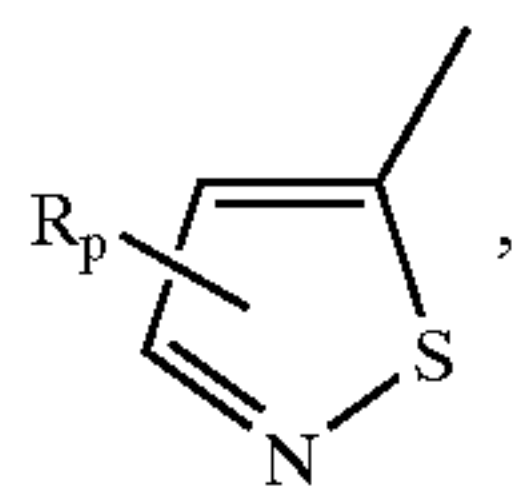
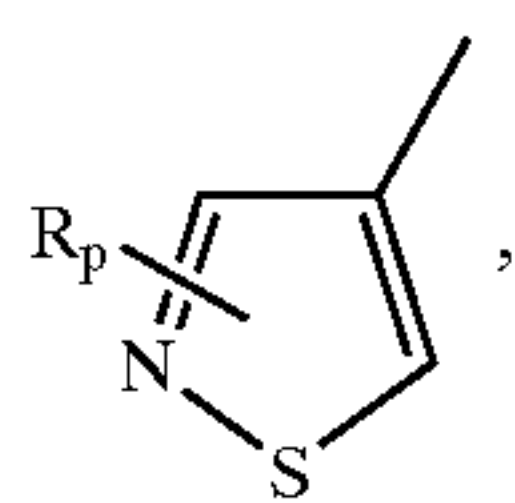

12

-continued

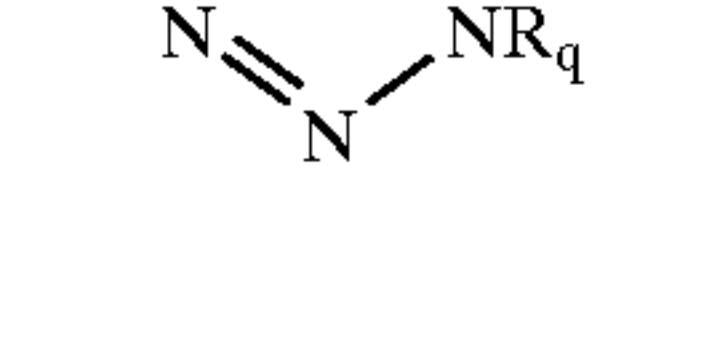
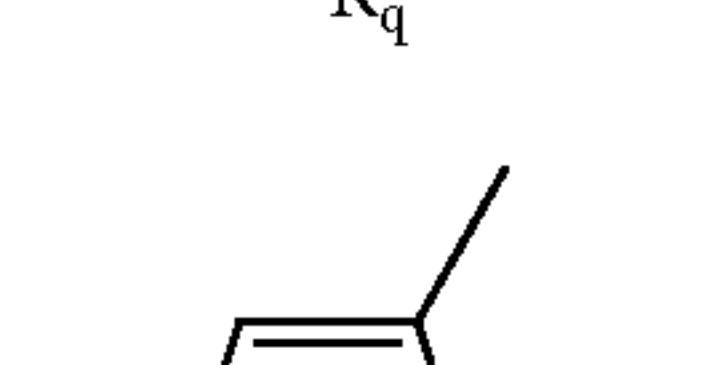
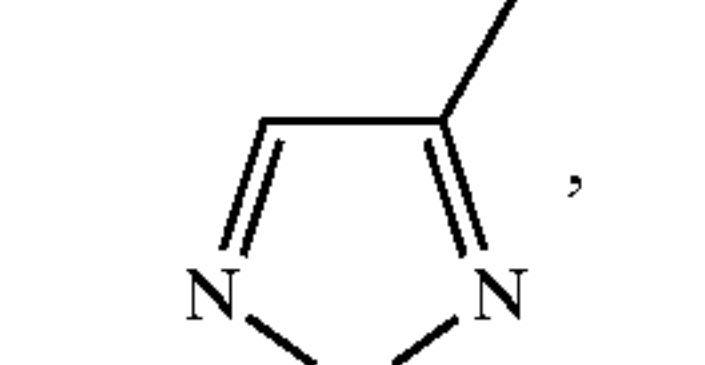
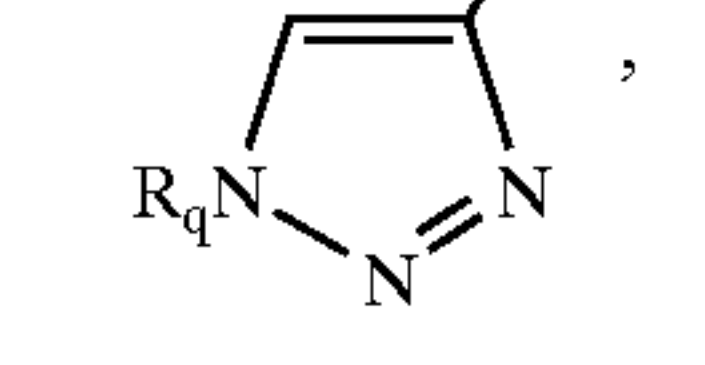
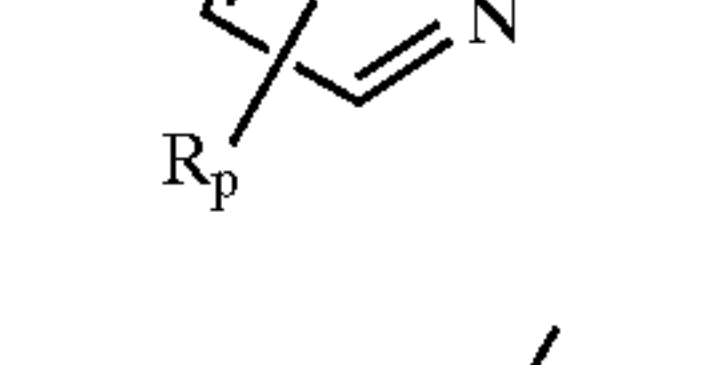
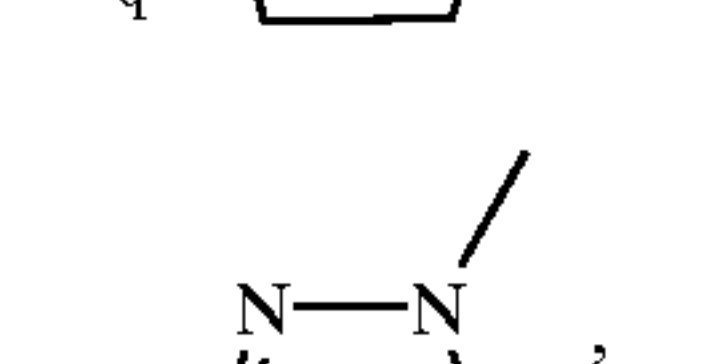
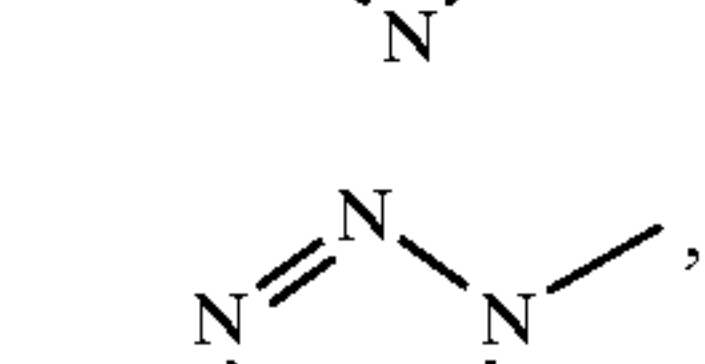
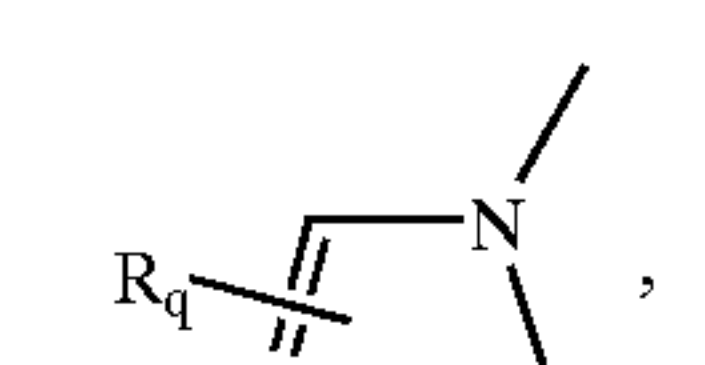
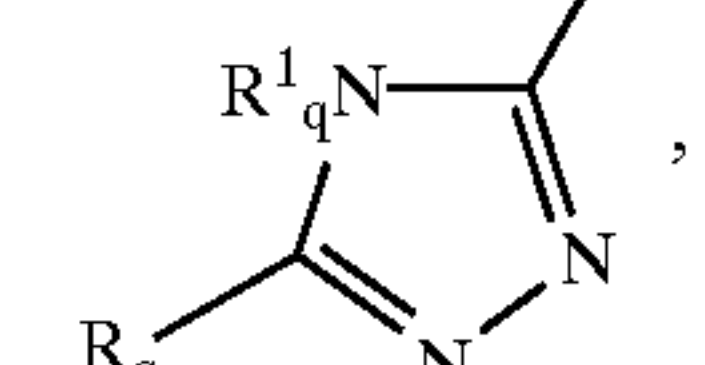
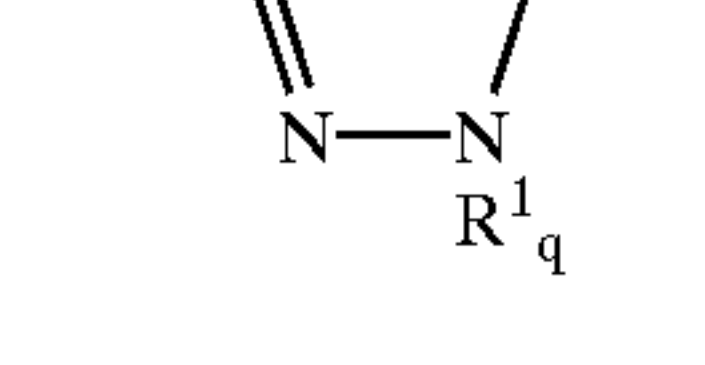
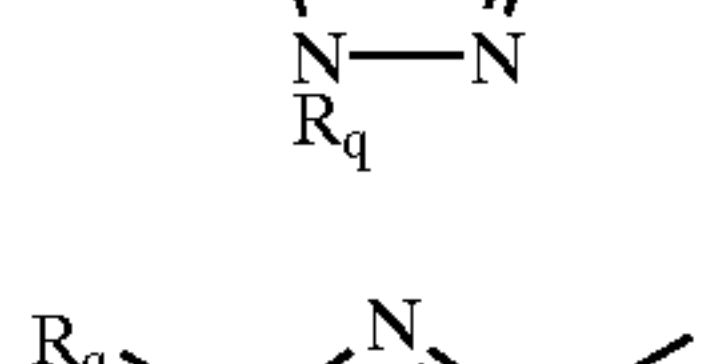
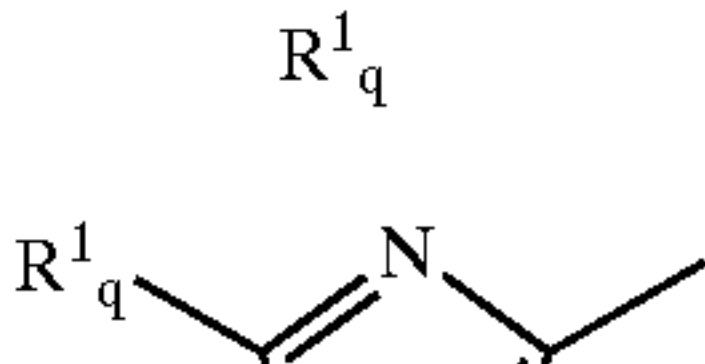
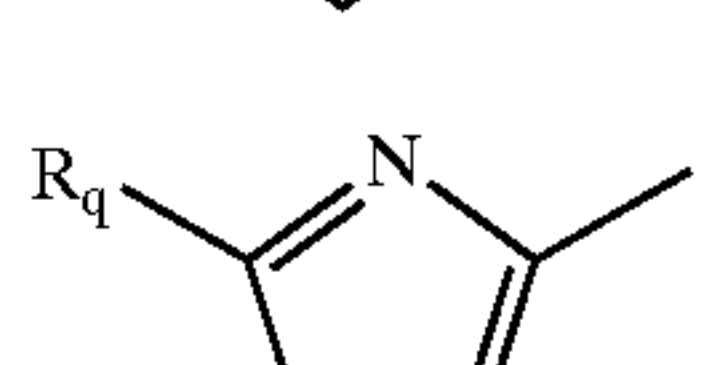
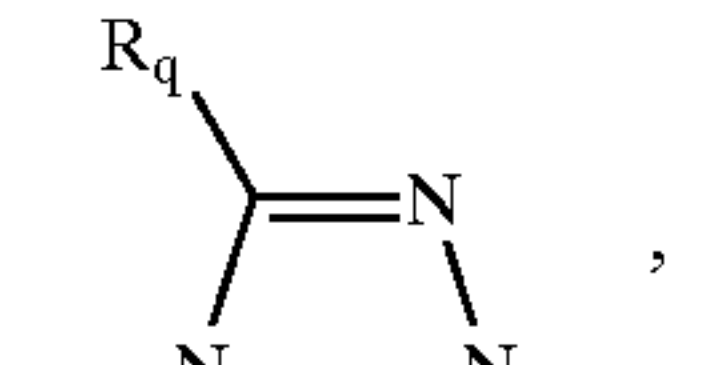
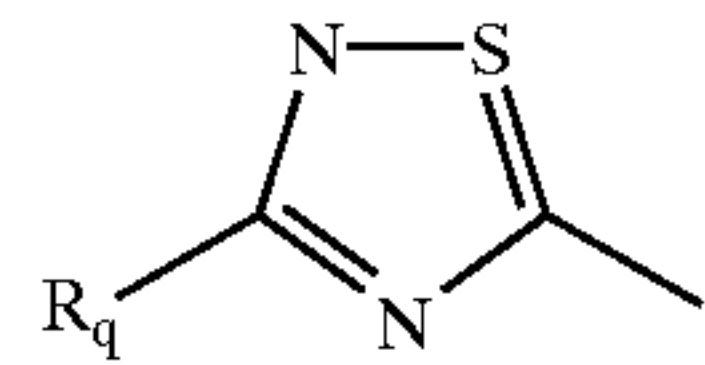
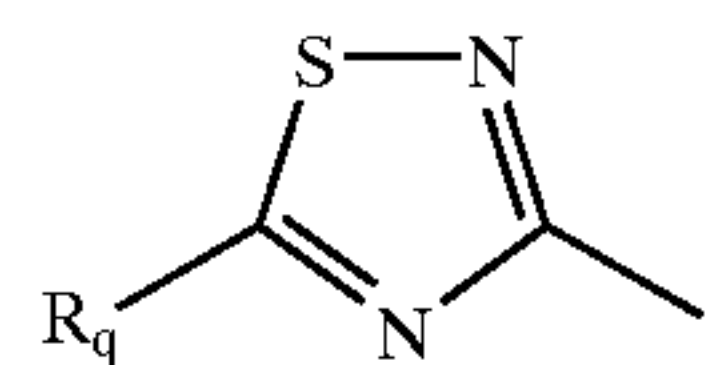

13

-continued

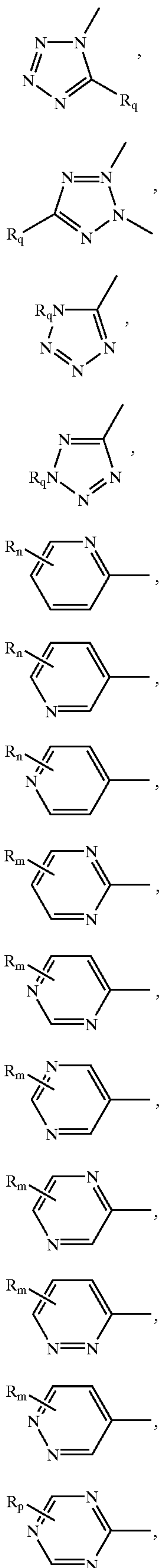

14

-continued

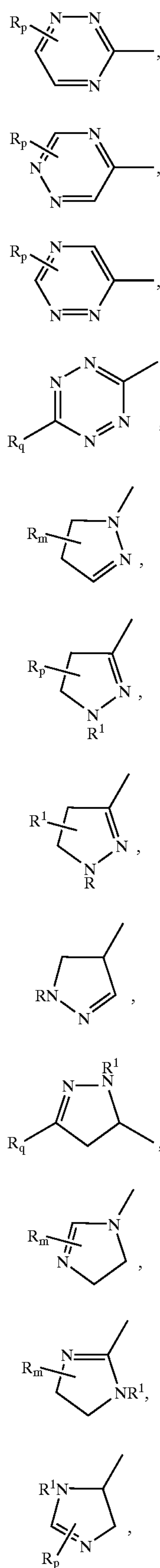

15

-continued

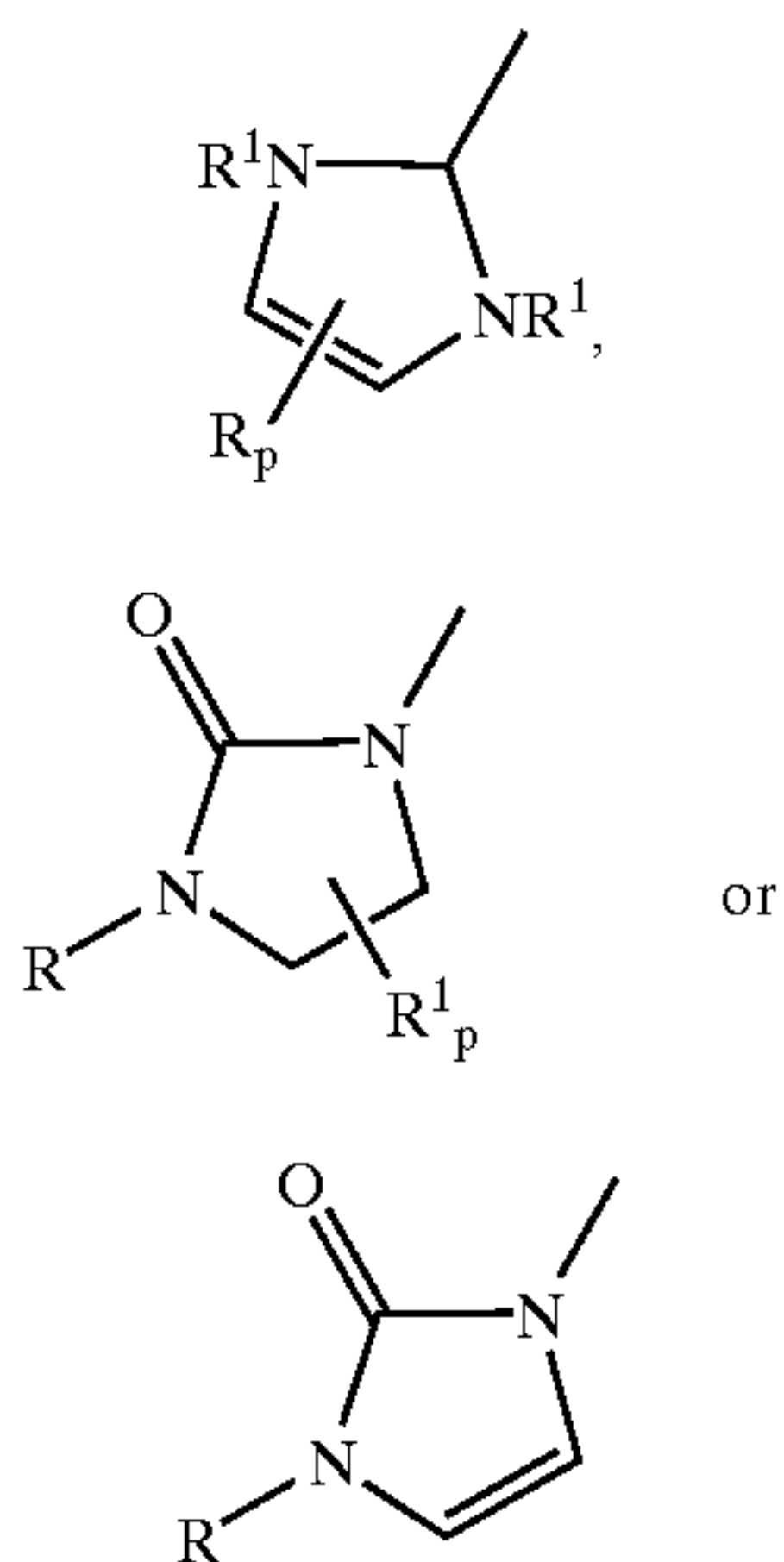

A is a phenyl group optionally substituted by W, a naphthyl group optionally substituted by W, or a heterocyclic group optionally substituted by Y, said heterocyclic group being

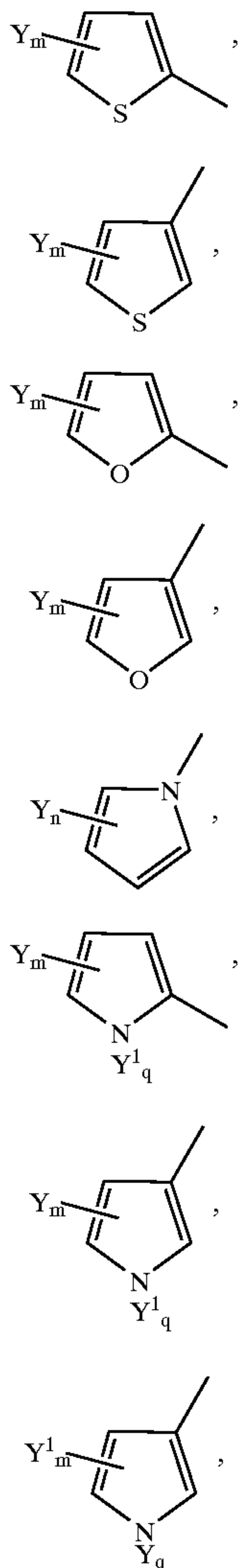

16

-continued

- Q-74 5
- Q-75 10
- Q-76 15
- 20
- 25
- A-1 30
- A-2 35
- A-3 40
- A-4 45
- A-5 50
- A-6 55
- A-7 60
- A-8 65

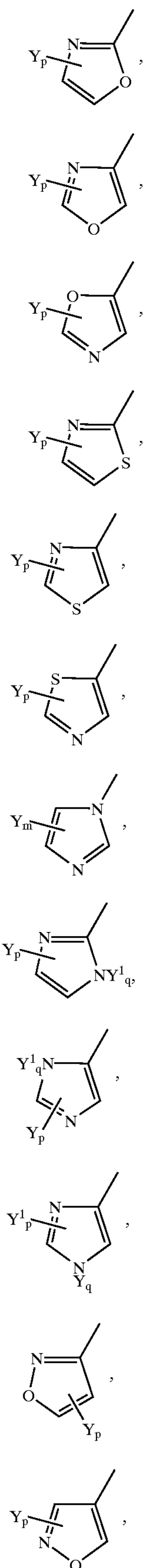

- A-9
- A-10
- A-11
- A-12
- A-13
- A-14
- A-15
- A-16
- A-17
- A-18
- A-19
- A-20

17

-continued

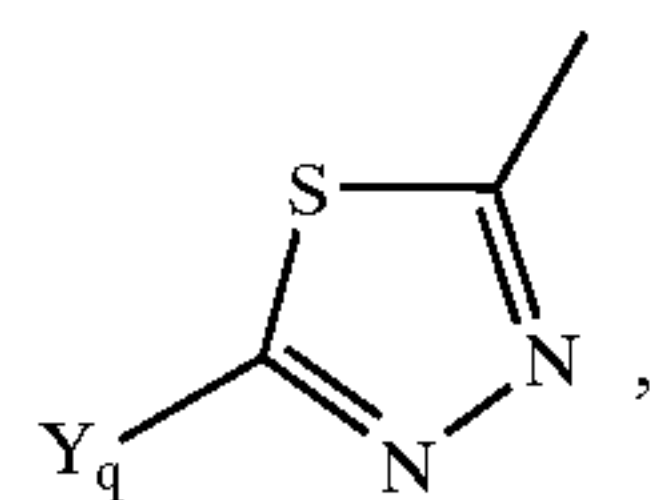
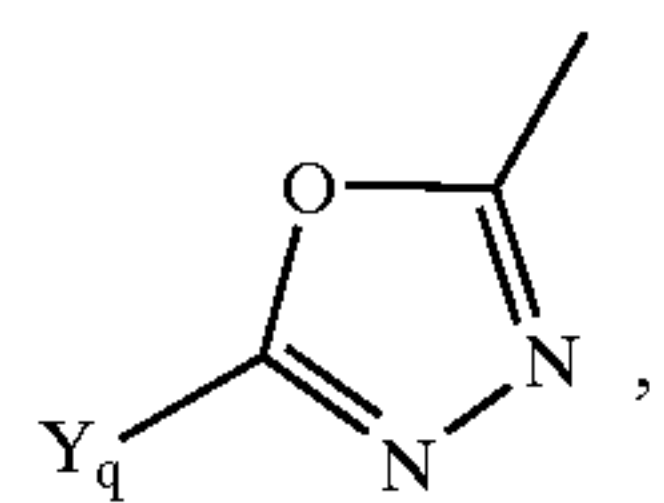
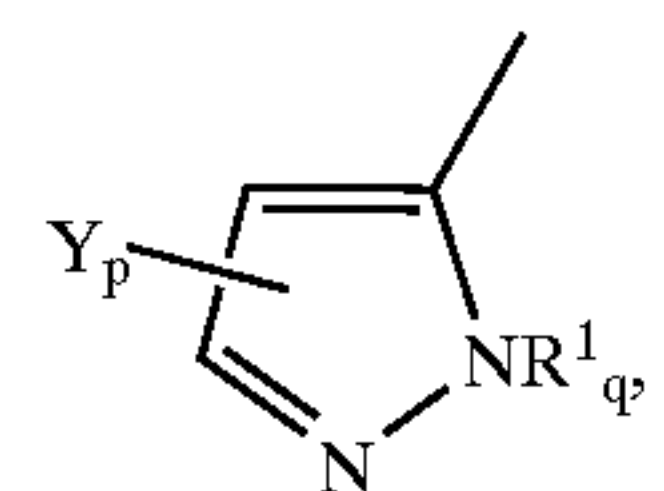
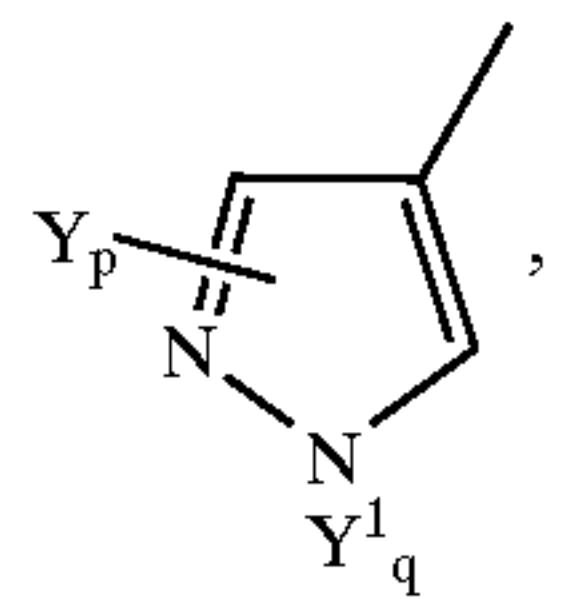
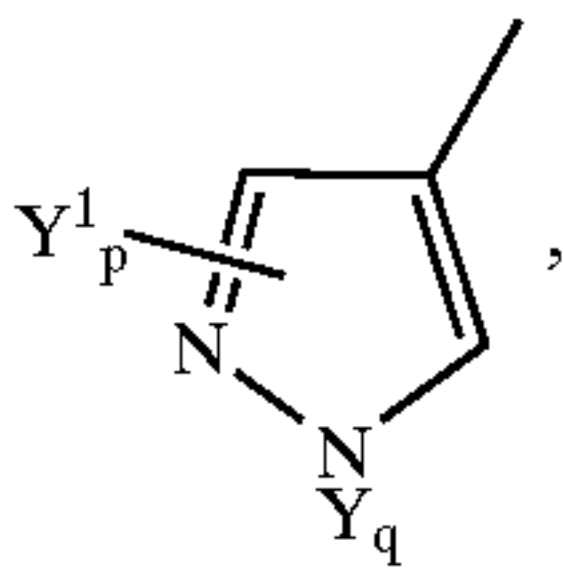
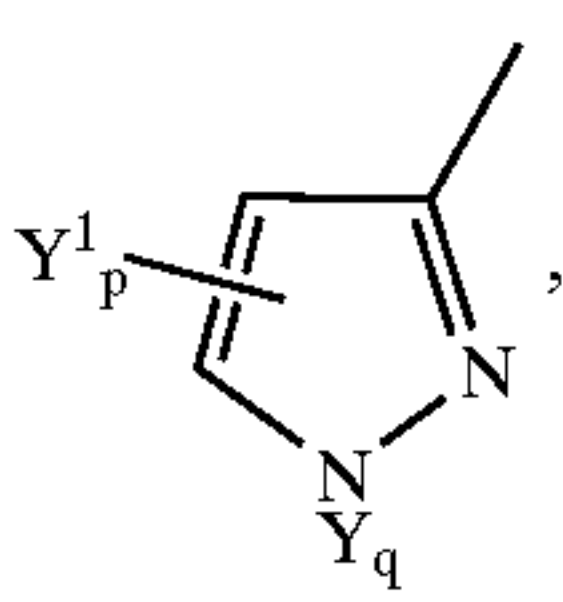
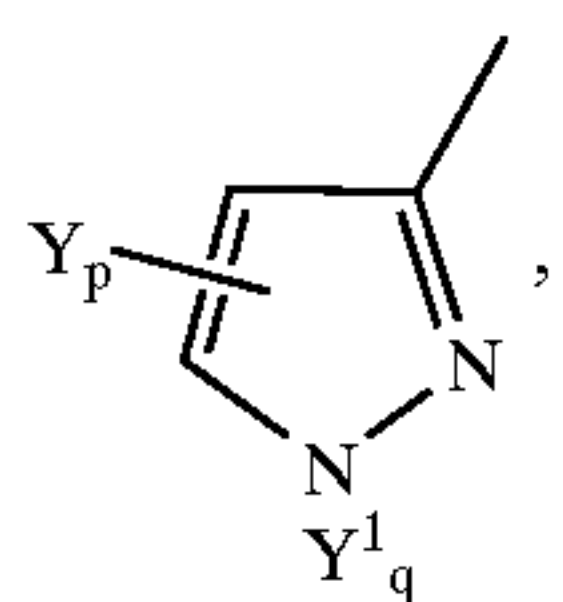
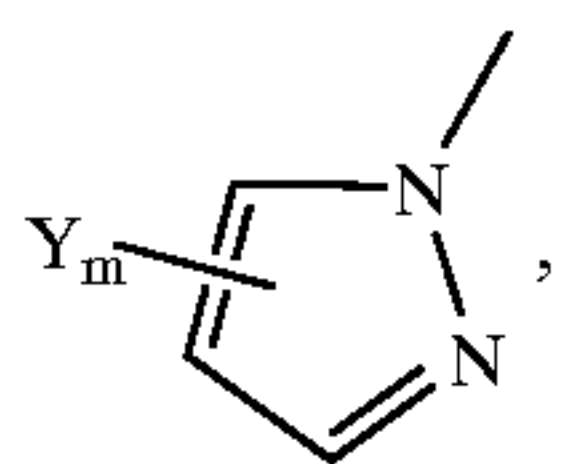
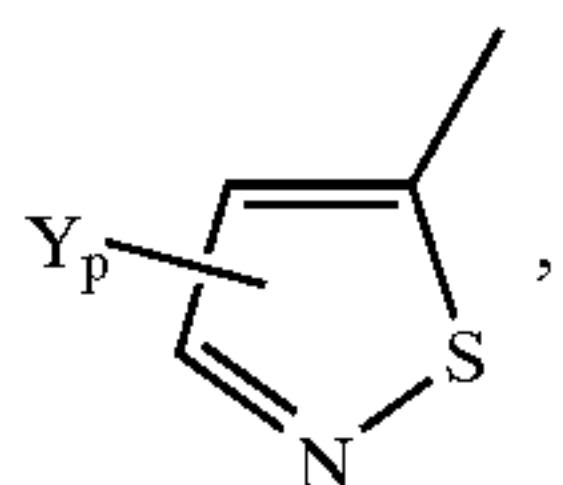
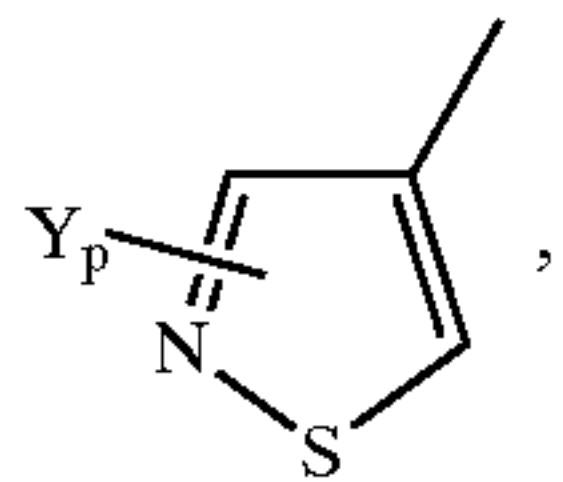
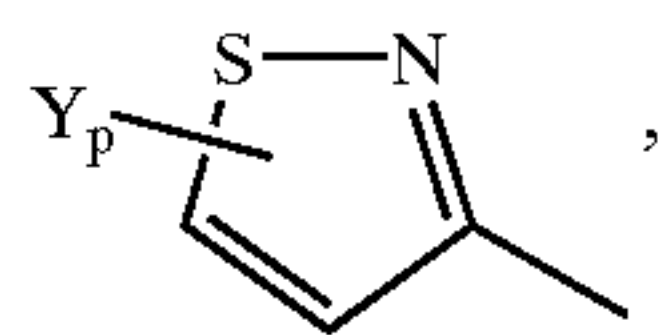
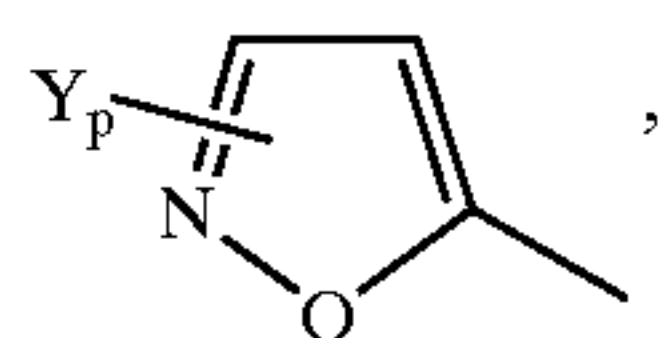

18

-continued

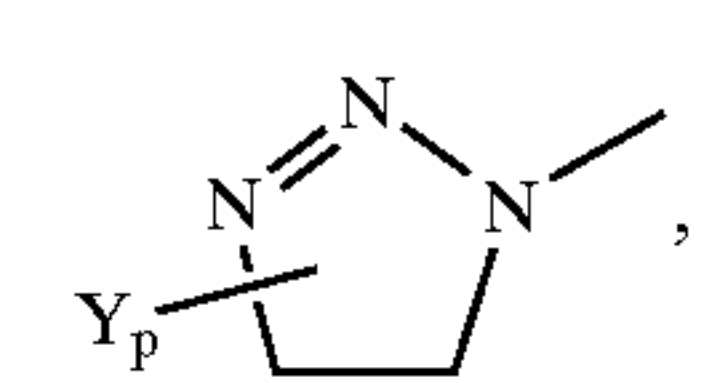
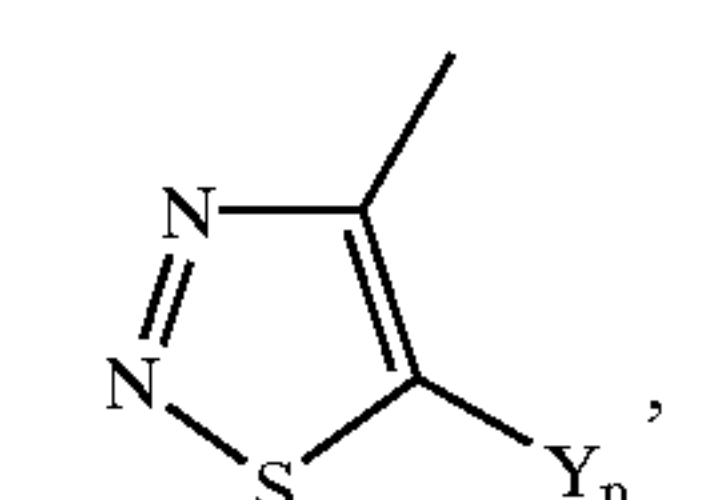
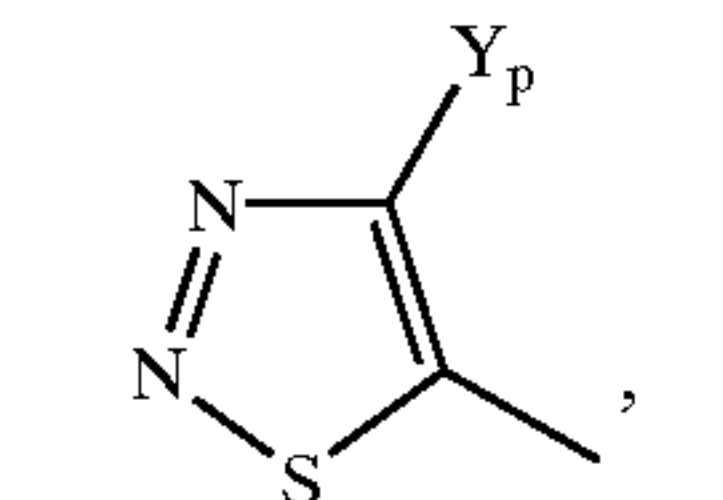
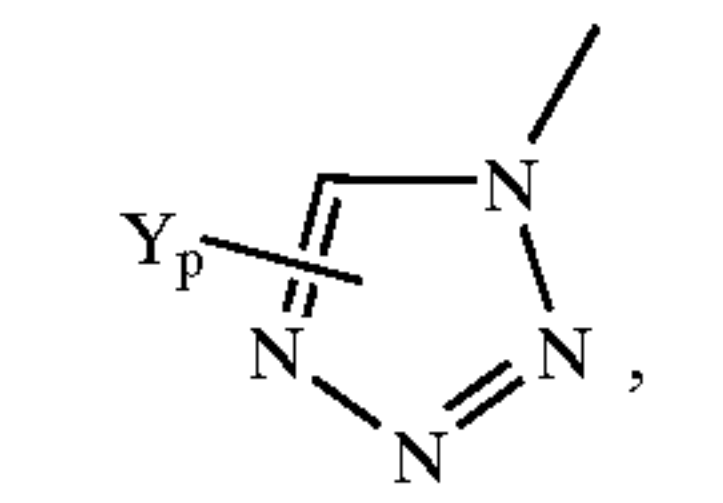
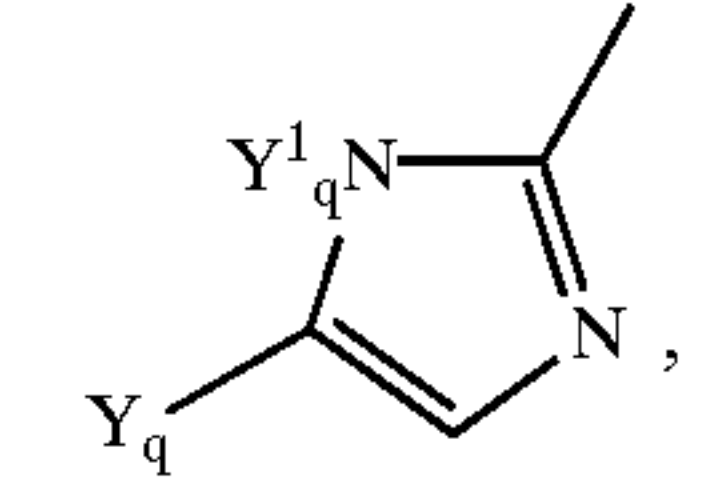
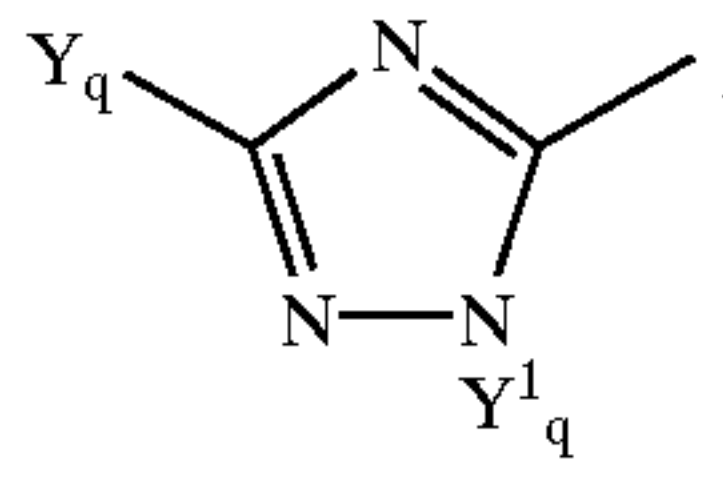
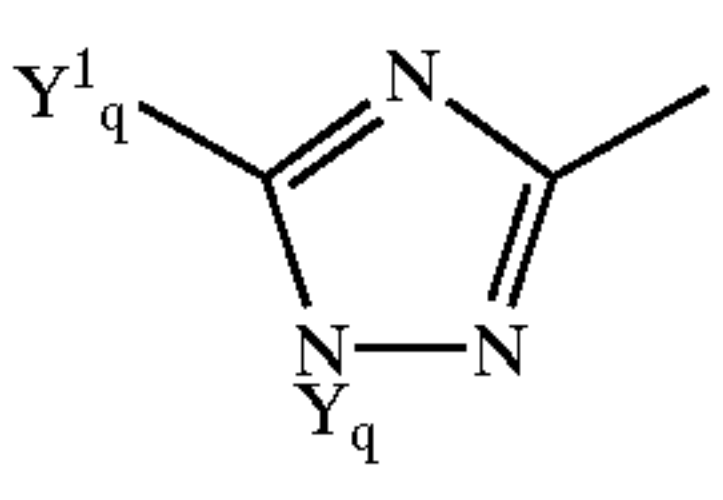
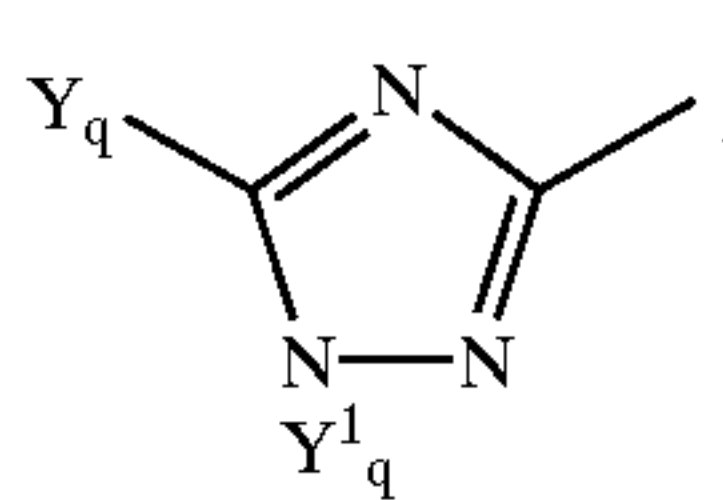
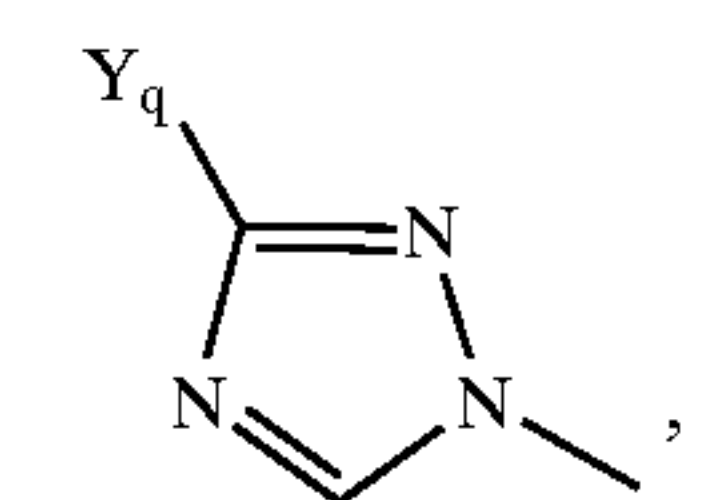
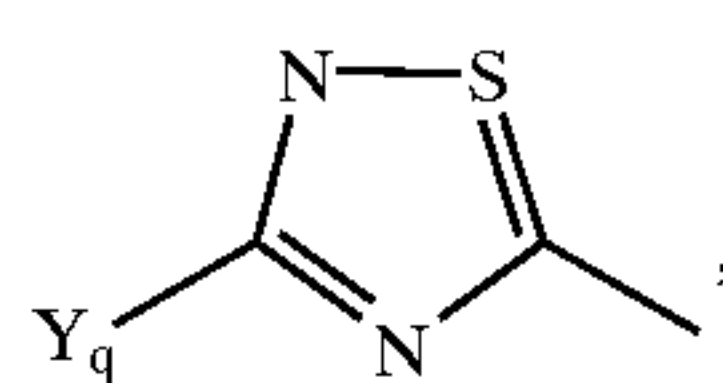
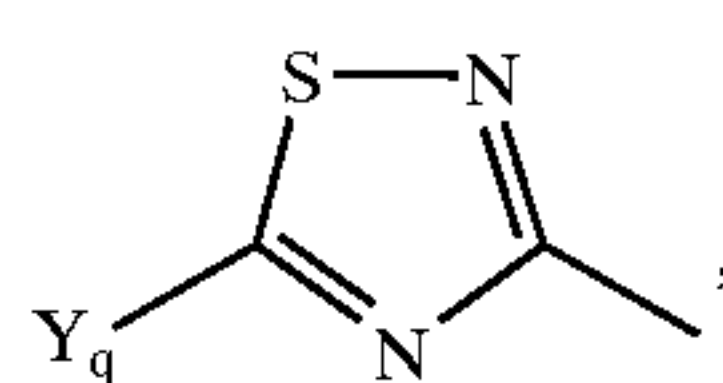
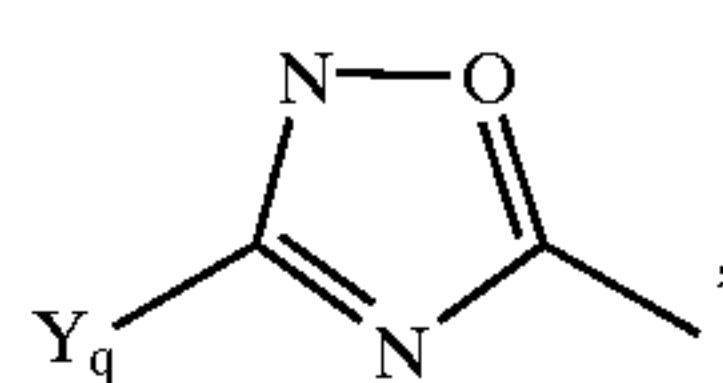
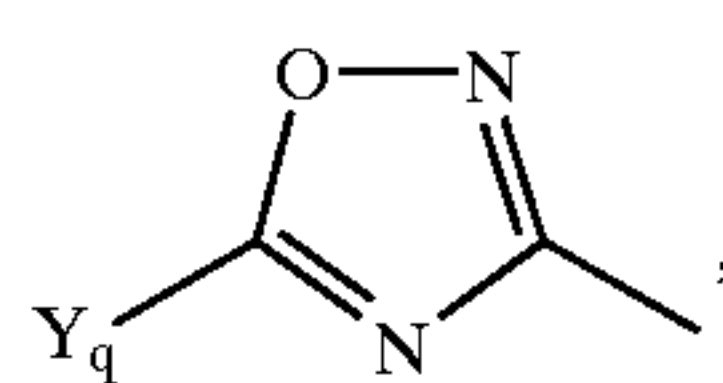

19

-continued

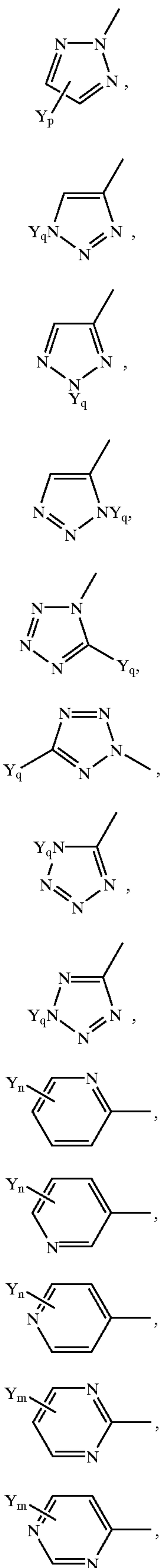

20

-continued

A-46
5
A-47
10
A-48
15
A-49
20
A-50
25
A-51
30
A-52
35
A-53
40
A-54
45
A-55
50
A-56
55
A-57
60
A-58
65

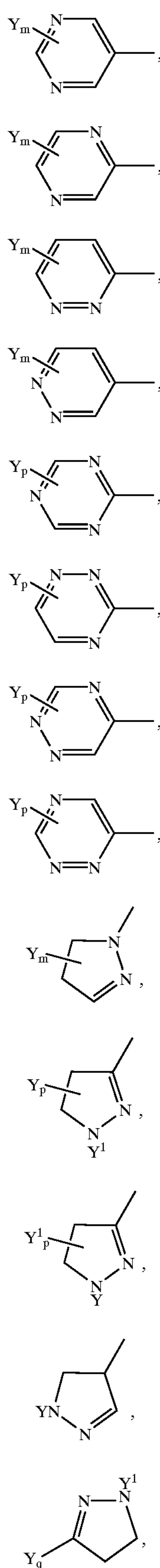

A-59
A-60
A-61
A-62
A-63
A-64
A-65
A-66
A-67
A-68
A-69
A-70
A-71

21

-continued

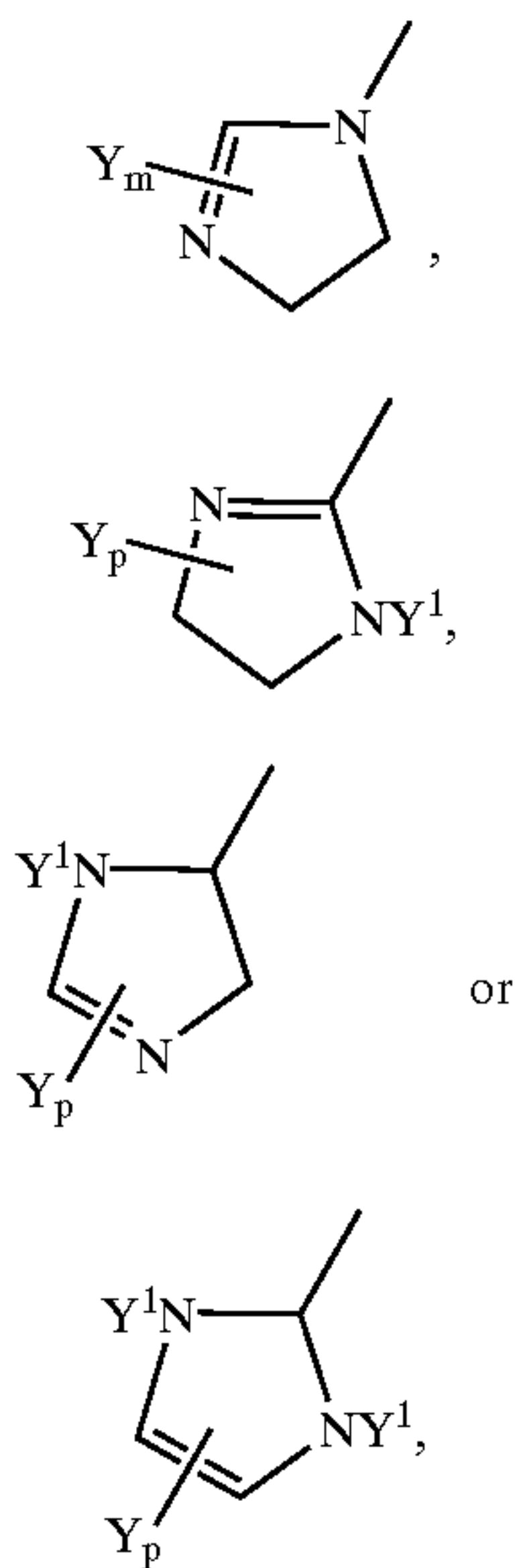

provided that, when (a) Q is any of Q-1, Q-2, Q-3 or Q-4, then A is a phenyl group optionally substituted by W, a naphthyl group optionally substituted by W, or a heterocyclic group optionally substituted by Y, (said heterocyclic group being any of A-5, A-6, A-7, A-8, A-9, A-10, A-11, A-12, A-13, A-14, A-15, A-16, A-17, A-18, A-19, A-20, A-21, A-22, A-23, A-24, A-25, A-26, A-27, A-28, A-29, A-30, A-31, A-32, A-33, A-34, A-35, A-36, A-37, A-38, A-39, A-40, A-41, A-42, A-43, A-44, A-45, A-46, A-47, A-48, A-49, A-50, A-51, A-52, A-53, A-57, A-58, A-59, A-60, A-61, A-62, A-63, A-64, A-65, A-66, A-67, A-68, A-69, A-70, A-71, A-72, A-73, A-74 or A-75),

(b) when Q is Q-12, then A is a naphthyl group optionally substituted by W, or a heterocyclic group optionally substituted by Y, (said heterocyclic group being any of A-1, A-2, A-3, A-4, A-5, A-6, A-7, A-8, A-9, A-10, A-11, A-12, A-13, A-14, A-15, A-16, A-17, A-18, A-19, A-20, A-21, A-22, A-23, A-24, A-25, A-26, A-27, A-28, A-29, A-30, A-31, A-32, A-33, A-34, A-35, A-36, A-37, A-38, A-39, A-40, A-41, A-42, A-43, A-44, A-45, A-46, A-47, A-48, A-49, A-50, A-51, A-52, A-53, A-54, A-55, A-56, A-57, A-58, A-59, A-60, A-61, A-62, A-63, A-64, A-65, A-66, A-67, A-68, A-69, A-70, A-71, A-72, A-73, A-74 or A-75),

(c) when Q is any of Q-52, Q-53 or Q-54, then A is a heterocyclic group optionally substituted by Y, (said heterocyclic group being any of A-5, A-6, A-7, A-8, A-9, A-10, A-11, A-12, A-13, A-14, A-15, A-16, A-17, A-18, A-19, A-20, A-21, A-22, A-23, A-24, A-25, A-26, A-27, A-28, A-29, A-30, A-31, A-32, A-33, A-34, A-35, A-36, A-37, A-38, A-39, A-40, A-41, A-42, A-43, A-44, A-45, A-46, A-47, A-48, A-49, A-50, A-51, A-52, A-53, A-60, A-63, A-64, A-65, A-66, A-67, A-68, A-69, A-70, A-71, A-72, A-73, A-74 or A-75),

(d) when Q is any of Q-23, Q-24, Q-43, Q-44, Q-45, Q-46 or Q-49, then A is a naphthyl group optionally substituted by W, or a heterocyclic group optionally substituted by Y, (said heterocyclic group being any of A-1, A-2, A-3, A-4, A-5, A-6, A-7, A-8, A-9, A-10, A-11, A-12, A-13, A-14, A-15, A-16, A-17, A-18, A-19, A-20, A-21, A-22, A-23, A-24, A-25, A-26, A-27, A-28, A-29, A-30, A-31, A-32, A-33, A-34, A-35, A-36, A-37, A-38, A-39, A-40, A-41, A-42, A-43, A-44, A-45, A-46, A-47, A-48, A-49, A-50, A-51, A-52, A-53, A-54, A-55, A-56, A-57, A-58, A-59, A-60,

22

A-61, A-62, A-63, A-64, A-65, A-66, A-67, A-68, A-69, A-70, A-71, A-72, A-73, A-74 or A-75),

(e) when Q is any of Q-37, Q-38, Q-39, Q-40, Q-41 or Q-42, then A is a heterocyclic group optionally substituted by Y, (said heterocyclic group being any of A-1, A-2, A-3, A-4, A-5, A-6, A-7, A-8, A-9, A-10, A-11, A-12, A-13, A-14, A-15, A-16, A-17, A-18, A-19, A-20, A-21, A-22, A-23, A-24, A-25, A-26, A-27, A-28, A-29, A-30, A-31, A-32, A-33, A-34, A-35, A-36, A-37, A-38, A-39, A-40, A-41, A-42, A-43, A-44, A-45, A-46, A-47, A-48, A-49, A-50, A-51, A-52, A-53, A-57, A-58, A-59, A-60, A-61, A-62, A-63, A-64, A-65, A-66, A-67, A-68, A-69, A-70, A-71, A-72, A-73, A-74 or A-75),

(f) when Q is a phenyl group optionally substituted by G, then A is a heterocyclic group optionally substituted by Y, said heterocyclic group being any of A-5, A-6, A-7, A-8, A-9, A-10, A-11, A-12, A-13, A-14, A-19, A-20, A-21, A-22, A-23, A-24, A-25, A-26, A-27, A-28, A-29, A-30, A-31, A-32, A-33, A-34, A-35, A-36, A-37, A-38, A-39, A-40, A-41, A-42, A-43, A-44, A-45, A-46, A-47, A-48, A-49, A-50, A-51, A-52, A-53, A-60, A-61, A-62, A-63, A-64, A-65, A-66, A-67, A-68, A-69, A-70, A-71, A-72, A-73, A-74 or A-75,

(g) when Q is a naphthyl group optionally substituted by G, then A is a heterocyclic group optionally substituted by Y, (said heterocyclic group being any of A-1, A-2, A-5, A-6, A-7, A-8, A-9, A-10, A-11, A-12, A-13, A-14, A-15, A-16, A-17, A-18, A-19, A-20, A-21, A-22, A-23, A-24, A-25, A-26, A-27, A-28, A-29, A-30, A-31, A-32, A-33, A-34, A-35, A-36, A-37, A-38, A-39, A-40, A-41, A-42, A-43, A-44, A-45, A-46, A-47, A-48, A-49, A-50, A-51, A-52, A-53, A-54, A-55, A-56, A-57, A-58, A-59, A-60, A-61, A-62, A-63, A-64, A-65, A-66, A-67, A-68, A-69, A-70, A-71, A-72, A-73, A-74 or A-75),

R¹ is selected from a halogen atom, a C₁-C₁₀ alkyl group, a C₂-C₆ alkenyl group, a C₂-C₆ alkynyl group, a C₁-C₆ haloalkyl group, a C₁-C₆ alkoxy group, a C₂-C₆ alkenyloxy group, NO₂, CN, —NU¹U², OH, a C₂-C₇ alkoxy carbonyl group, a C₂-C₄ alkoxyalkyl group, a C₂-C₄ alkylcarbonyl group, a phenyl group optionally substituted by X, a pyridyl group optionally substituted by X, a thienyl group optionally substituted by X, and —N=CT⁷T⁸ (in which T⁷ and T⁸ each independently represent H, a phenyl, benzyl or C-C, alkyl group, or T⁷ and T⁸ may, together with the carbon atom to which they are bonded, form a 5-, 6-, 7- or 8-membered ring); or may, together with the adjacent R, form a 5-, 6-, 7- or 8-membered ring as an alkylene group

Y¹ is selected from a halogen atom, a C₁-C₁₀ alkyl group, a C₁-C₆ haloalkyl group, a C₁-C₆ alkoxy group, a C₂-C₆ alkenyloxy group, NO₂, CN, —NU¹U², OH, a C₂-C₇ alkoxy carbonyl group, a C₂-C₄ alkoxyalkyl group, a phenyl group optionally substituted by X, and —N=CT⁷T⁸ (in which T⁷ and T⁸ each independently represent H, or a phenyl, benzyl or C₁-C₆ alkyl group, or T⁷ and T⁸ may, together with the carbon atom to which they are bonded, form a 5-, 6-, 7- or 8-membered ring); or may, together with the adjacent Y¹, form a 5-, 6- 7- or 8-membered ring an alkylene group;

X is a substituent of which the number is from 1 to 4 and which is freely selected from a halogen atom, a C₁-C₄ alkyl group, a C₁-C₄ haloalkyl group, a C₁-C₄ alkoxy group, a C₁-C₄ haloalkoxy group, a C₁-C₄ alkylsulfenyl group, a C₁-C₄ alkylsulfinyl group, a C₁-C₄ alkylsulfonyl group, a C₂-C₅ alkenylsulfenyl group, a C₂-C₅ alkenylsulfinyl group, a C₂-C₅ alkenylsulfonyl group, a C₁-C₄ haloalkylsulfenyl group, a C₁-C₄ haloalkylsulfinyl group, a C₁-C₄ haloalkylsulfonyl group, NO₂, CN, CHO, OH, —NU¹U², a

phenyl group, a phenoxy group, and a C₂-C₅ alkoxy-carbonyl group, (provided that when the number of the substituent, X, is two or more then said substituents may be the same or different);

Z is a substituent of which the number is from 1 to 4 and which is freely selected from a halogen atom, a C₁-C₄ alkyl group, a C₁-C₄ haloalkyl group, a C₁-C₄ alkoxy group, a C₁-C₄ haloalkoxy group, a C₁-C₄ alkylsulfenyl group, a C₁-C₄ alkylsulfinyl group, a C₁-C₄ alkylsulfonyl group, a C₁-C₄ alkenylsulfenyl group, a C₁-C₄ alkenylsulfinyl group, a C₁-C₄ alkenylsulfonyl group, NO₂, CN, —NU¹U², a phenyl group, a phenoxy group, and a C₂-C₅ alkoxy-carbonyl group, (provided when the number of the substituent, Z, is two or more, said substituents may be the same or different);

m indicates the number of the substituents, and is 0, 1, 2 or 3;

n indicates the number of the substituents, and is 0, 1, 2, 3, or 4;

p indicates the number of substituents, and is 0, 1 or 2;

q indicates the number of the substituents, and is 0 or 1;

(provided that when m, n and p each are an integer of 2 or more, the substituents may be the same or different).

[4] Ethylene derivatives of the above-mentioned [2], in which E is CN.

[5] Ethylene derivatives of the above-mentioned [5], in which E is CN.

[6] Ethylene derivatives of the above-mentioned [2], in which E is a heterocyclic group optionally substituted by a C₁-C₄ alkyl or C₁-C₄ haloalkyl group—(said heterocyclic group being a 2-oxazolyl, 2-thiazolyl, 2-imidazolyl, 1,2,4-triazol-3-yl, 1,2,4-oxadiazol-3-yl, 1,2,4-thiadiazol-3-yl or 1,3,4-oxadiazol-2-yl group)—or is a halogen atom, a C₂-C₄ alkynyl group, a phenylethynyl group optionally substituted by Z, a C₁-C₄ haloalkyl group, CN, NO₂, N₃, CHO, a C₂-C₅ alkylcarbonyl group, a C₂-C₅ alkoxy-carbonyl group, a C₂-C₄ alkylaminocarbonyl group, a C₃-C₉ dialkylaminocarbonyl group, a benzoyl group optionally substituted by Z, an aminothiocarbonyl group, a C₁-C₄ alkylsulfenyl group, a C₁-C₄ alkylsulfinyl group, a C₁-C₄ alkylsulfonyl group, a phenylsulfenyl group optionally substituted by Z, a phenylsulfinyl group optionally substituted by Z, a phenylsulfonyl group optionally substituted by Z, —P(=O)T²T³, or —P(=S)T²T³.

[7] Ethylene derivatives of the above-mentioned [3], in which E is a heterocyclic group optionally substituted by a C₁-C₄ alkyl or C₁-C₄ haloalkyl group—(said heterocyclic group being a 2-oxazolyl, 2-thiazolyl, 2-imidazolyl, 1,2,4-triazol-3-yl, 1,2,4-oxadiazol-3-yl, 1,2,4-thiadiazol-3-yl or 1,3,4-oxadiazol-2-yl group)—or is a halogen atom, a C₂-C₄ alkynyl group, a phenylethynyl group optionally substituted by a Z, a C₁-C₄ haloalkyl group, CN, NO₂, N₃, CHO, a C₂-C₅ alkylcarbonyl group, a C₂-C₅ alkoxy-carbonyl group, a C₂-C₄ alkylaminocarbonyl group, a C₃-C₉ dialkylaminocarbonyl group, a benzoyl group optionally substituted by Z, an aminothiocarbonyl group, a C₁-C₄ alkylsulfenyl group, a C₁-C₄ alkylsulfinyl group, a C₁-C₄ alkylsulfonyl group, a phenylsulfenyl group optionally substituted by Z, a phenylsulfinyl group optionally substituted by Z, a phenylsulfonyl group optionally substituted by Z, —P(=O)T²T³, or —P(=S)T²T³.

[8] Ethylene derivatives of the above-mentioned [4], in which Q is a phenyl group optionally substituted by G, an oxazolyl group optionally substituted by R, a thiazolyl group optionally substituted by R, a pyrazolyl group optionally substituted by R, a 1,2,3-triazolyl group optionally substituted by R, a pyridinyl group optionally substituted by R, or a pyrimidinyl group optionally substituted by R.

[9] Ethylene derivatives of the above-mentioned [8], in which Q is a phenyl group optionally substituted by G.

[10] Ethylene derivatives of the above-mentioned [8], in which Q is an oxazolyl group optionally substituted by R or a 1,2,3-triazolyl group optionally substituted by R.

[11] Ethylene derivatives of the above-mentioned [8], in which Q is a thiazolyl group optionally substituted by R.

[12] Ethylene derivatives of the above-mentioned [8], in which Q is a pyrazolyl group optionally substituted by R.

[13] Ethylene derivatives of the above-mentioned [5], in which Q is a phenyl group optionally substituted by G, or is Q-9, Q-10, Q-11, Q-12, Q-13, Q-14, Q-25, Q-26, Q-27, Q-28, Q-29, Q-30, Q-44, Q-45, Q-46, Q-47, Q-52, Q-53, Q-54, Q-55, Q-56, or Q-57.

[14] Ethylene derivatives of the above-mentioned [7], in which Q is a phenyl group optionally substituted by G, or is Q-9, Q-10, Q-11, Q-12, Q-13, Q-14, Q-25, Q-26, Q-27, Q-28, Q-29, Q-30, Q-44, Q-45, Q-46, Q-47, Q-52, Q-53, Q-54, Q-55, Q-56, or Q-57.

[15] Ethylene derivatives of the above-mentioned [13], in which Q-10, Q-44, Q-45, Q-46 or Q-47.

[16] Ethylene derivatives of the above-mentioned [13], in which Q is Q-12, Q-13 or Q-14.

[17] Ethylene derivatives of the above-mentioned [13], in which Q is Q-25, Q-26, Q-27, Q-28, Q-29 or Q-30.

[18] Ethylene derivatives of the above-mentioned [13], in which Q is a phenyl group optionally substituted by G.

[19] Ethylene derivatives of the above-mentioned [2], in which A is a phenyl group optionally substituted by W, a thiazolyl group optionally substituted by Y, a pyrazolyl group optionally substituted by Y, a pyridinyl group optionally substituted by Y, or a pyrimidinyl group optionally substituted by Y.

[20] Ethylene derivatives of the above-mentioned [3], in which;

Q is a phenyl group optionally substituted by G, a naphthyl group, Q-31, Q-32, Q-33, Q-34, Q-35, Q-36, Q-37, Q-44, Q-45, Q-46, Q-49,

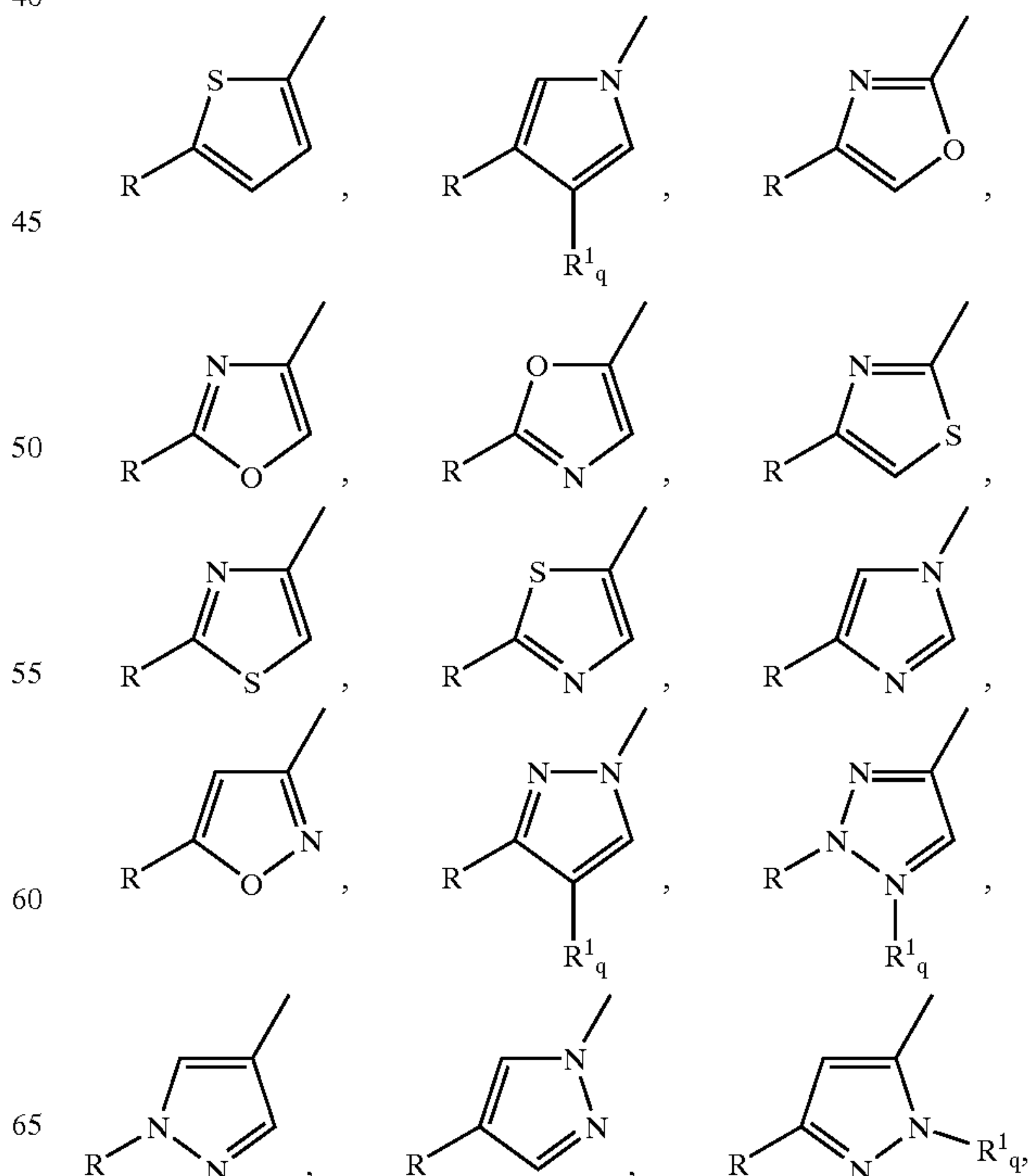

25

-continued

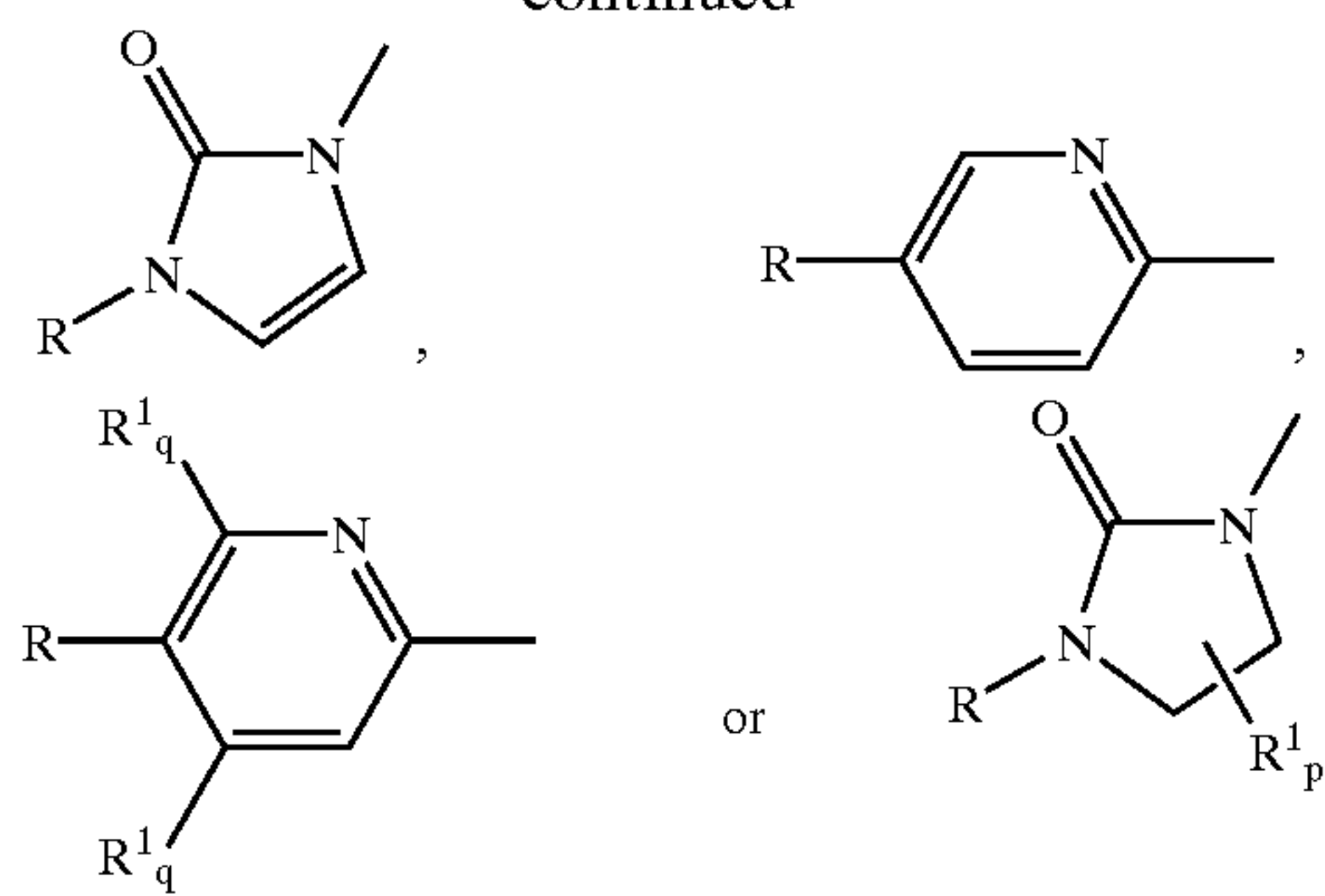

A is

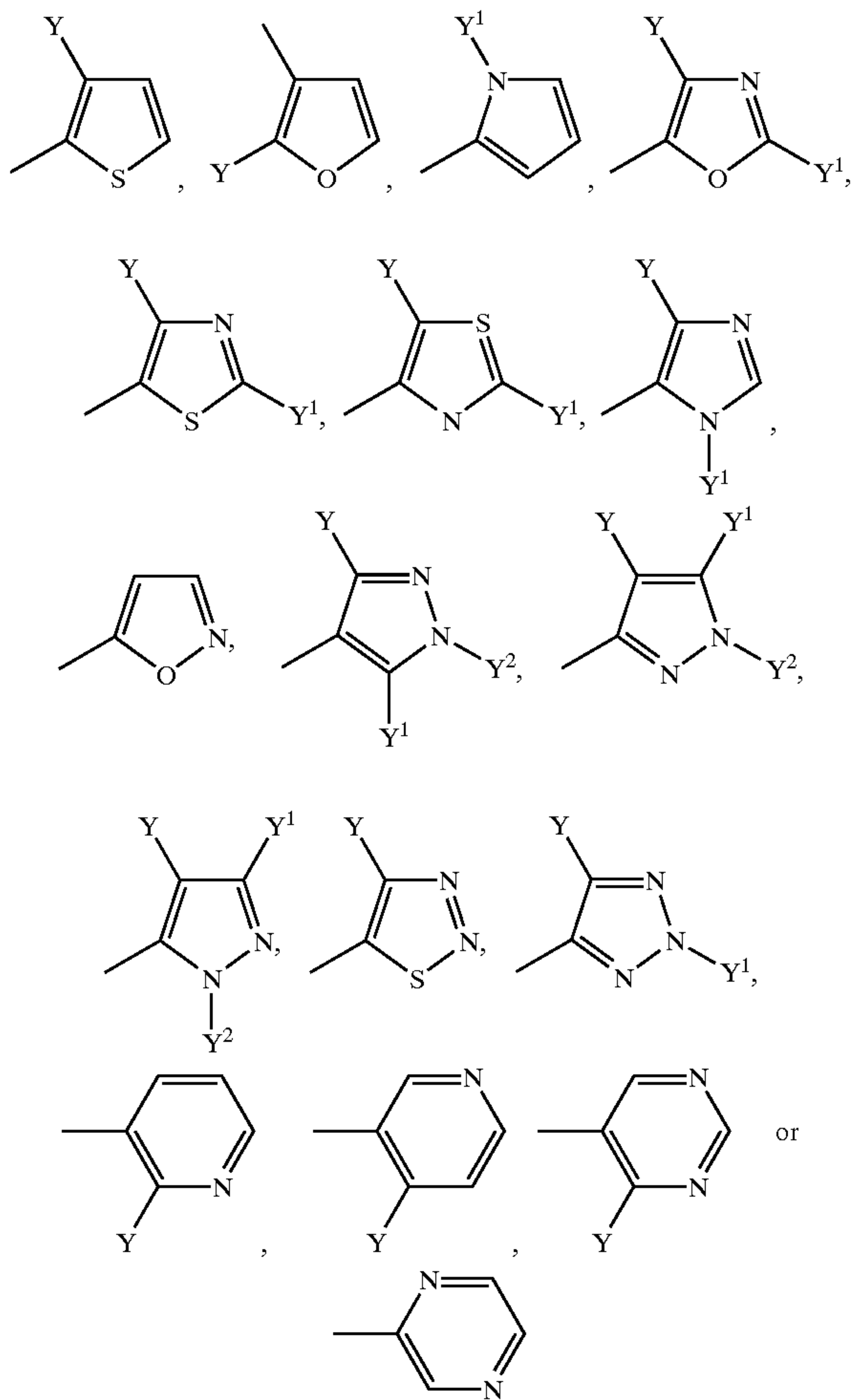

Y² is a halogen atom, a C₁-C₄ alkyl group, a C₁-C₄ haloalkyl group, a C₁-C₄ alkoxy group, NO₂, CN, or a C₂-C₅ alkoxy carbonyl group; and

Y³ is a halogen atom, a C₁-C₄ alkyl group, a C₁-C₆ haloalkyl group, a C₂-C₄ alkoxyalkyl group, or a phenyl group optionally substituted by X.

[21] Ethylene derivatives of the above-mentioned [20], in which E is CN.

[22] Ethylene derivatives of the above-mentioned [20], in which E is a heterocyclic group optionally substituted by a C₁-C₄ alkyl or C₁-C₄ haloalkyl group—(said heterocyclic group being a 2-oxazolyl, 2-thiazolyl, 2-imidazolyl, 1,2,4-triazol-3-yl, 1,2,4-oxadiazol-3-yl, 1,2,4-thiadiazol-3-yl or 1,3,4-oxadiazol-2-yl group)—or is a halogen atom, a C₂-C₄ alkynyl group, a phenylethynyl group optionally substituted

26

by Z, a C₁-C₄ haloalkyl group, CN, NO₂, N₃, CHO, a C₂-C₅ alkylcarbonyl group, a C₂-C₅ alkoxy carbonyl group, a C₂-C₄ alkylaminocarbonyl group, a benzoyl group optionally substituted by Z, an aminothiocarbonyl group, a C₁-C₄ alkylsulfenyl group, a C₁-C₄ alkylsulfinyl group, a C₁-C₄ alkylsulfonyl group, a phenylsulfenyl group optionally substituted by Z, a phenylsulfinyl group optionally substituted by Z, a phenylsulfonyl group optionally substituted by Z, —P(=O)T²T³, or —P(=S)T²T³.

[23] Ethylene derivatives of the above-mentioned [1], which are selected from the following:

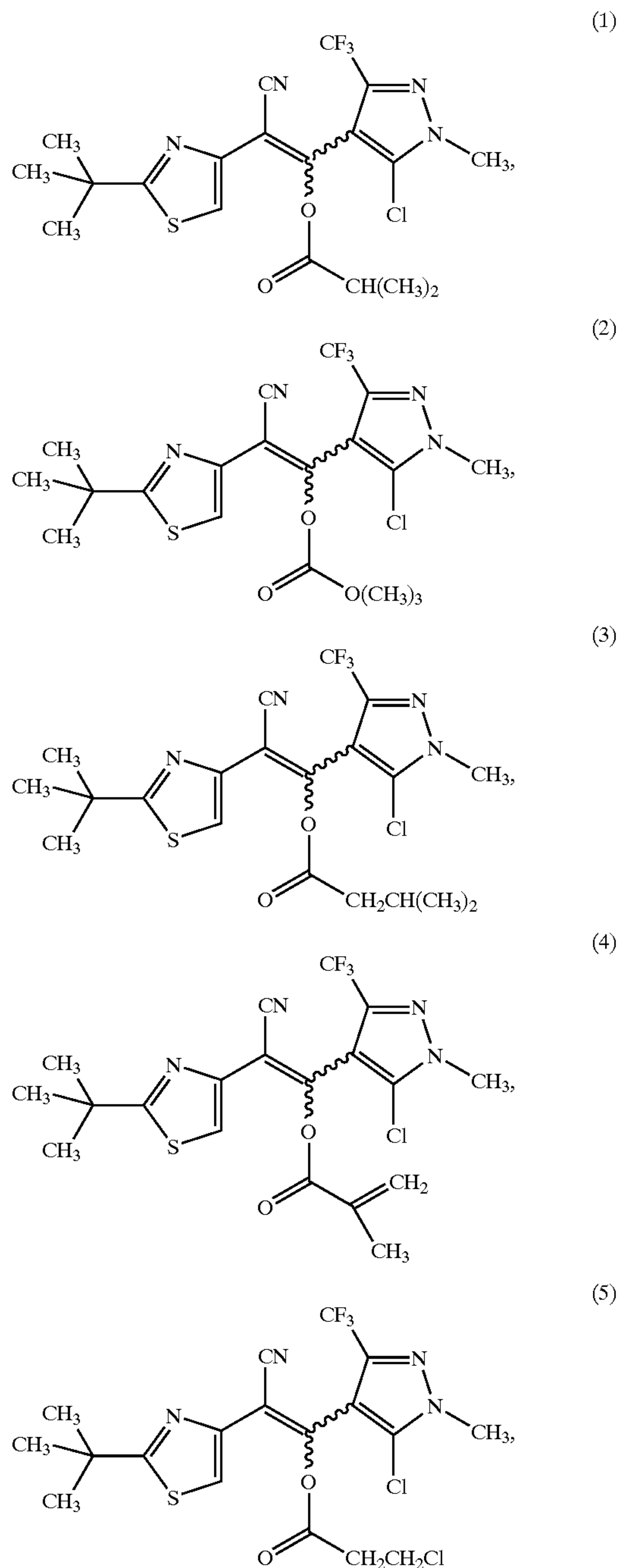

27

-continued

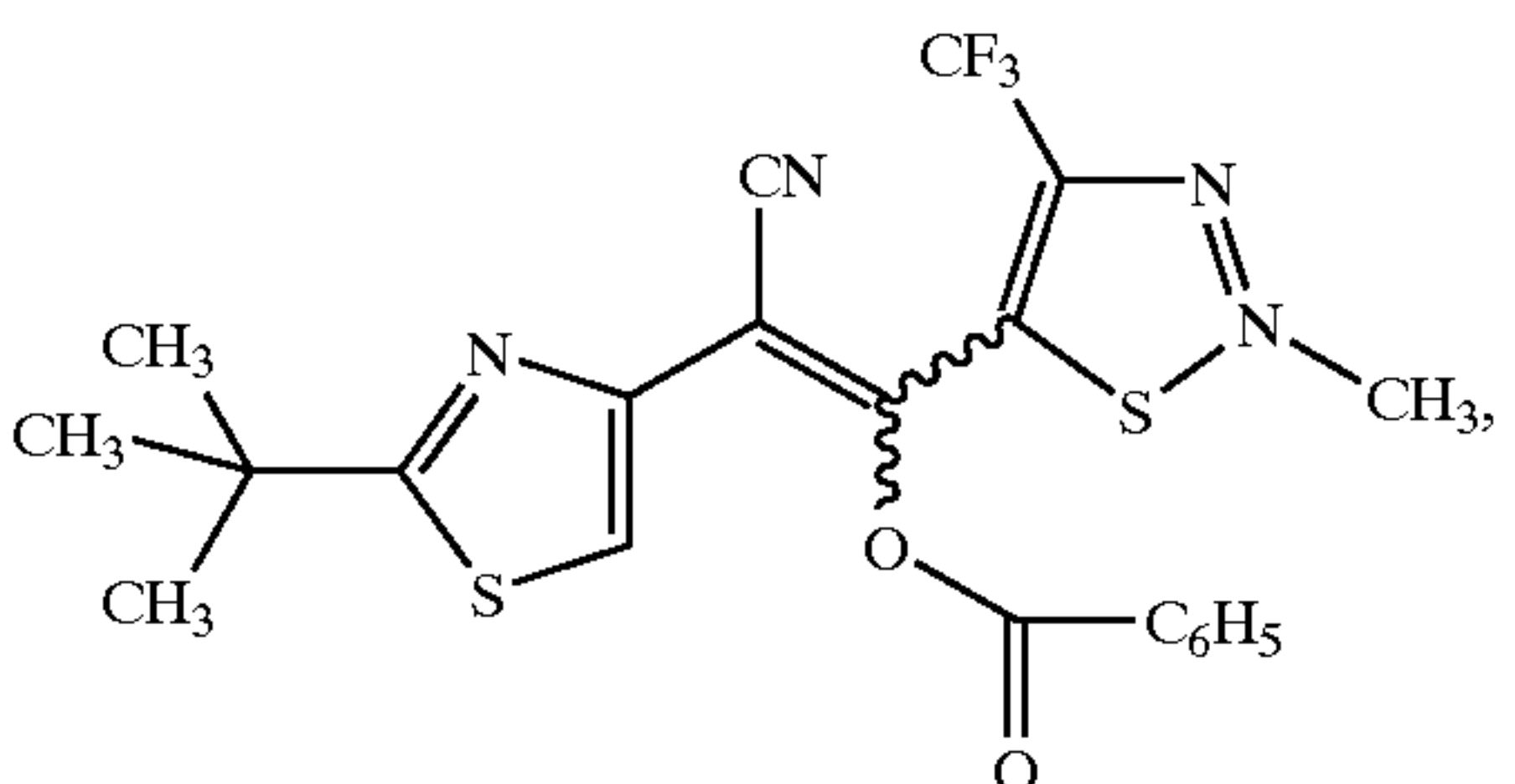
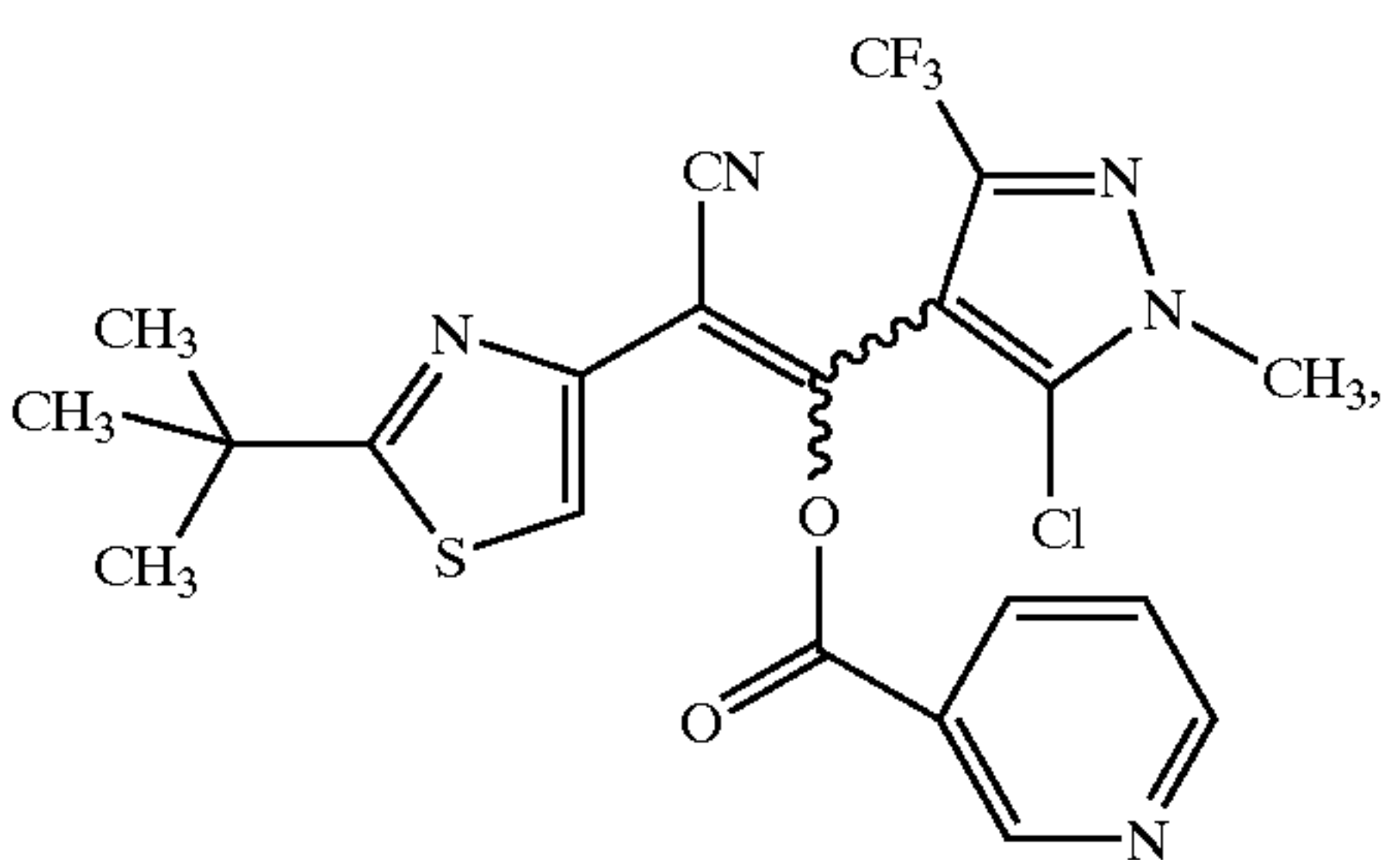
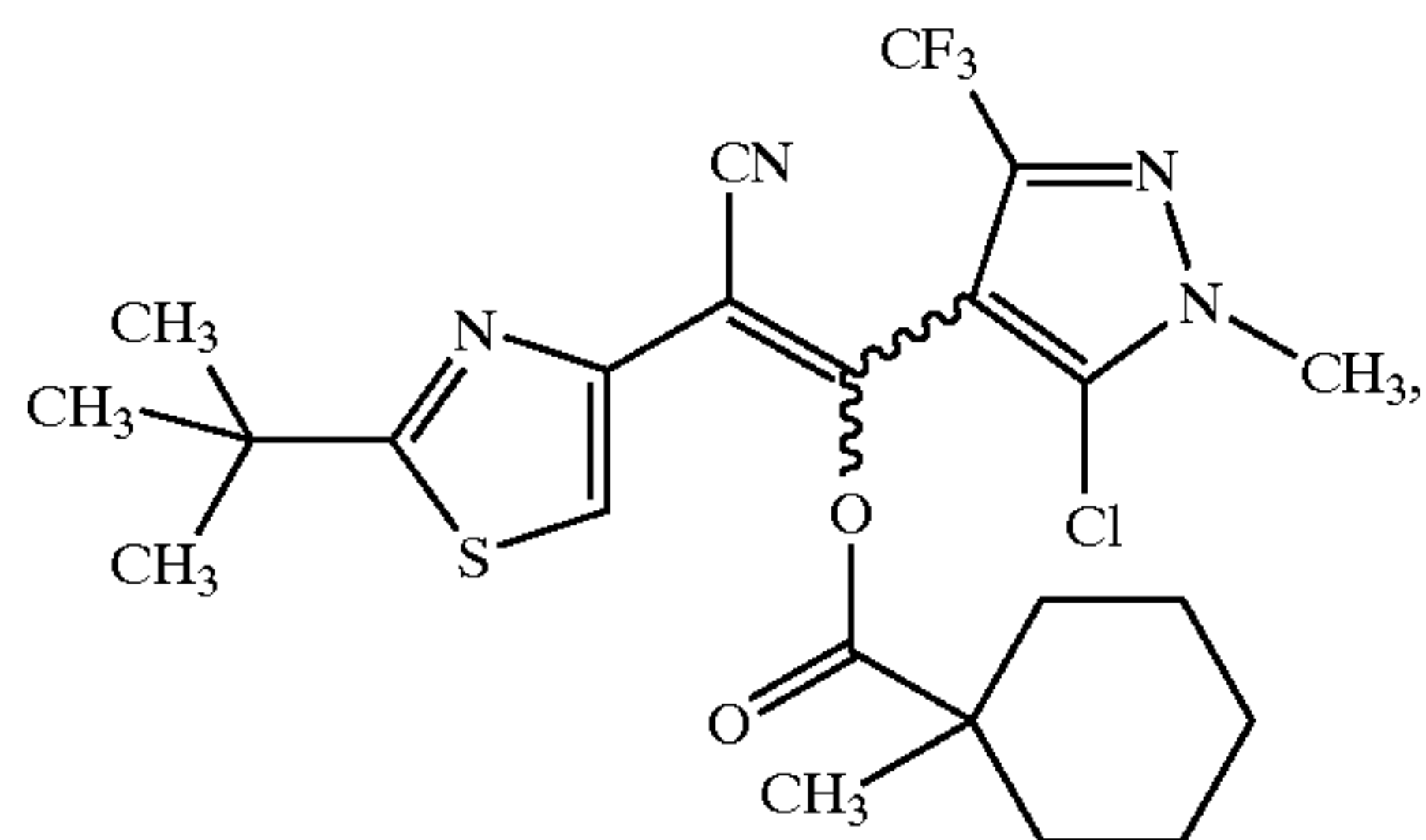
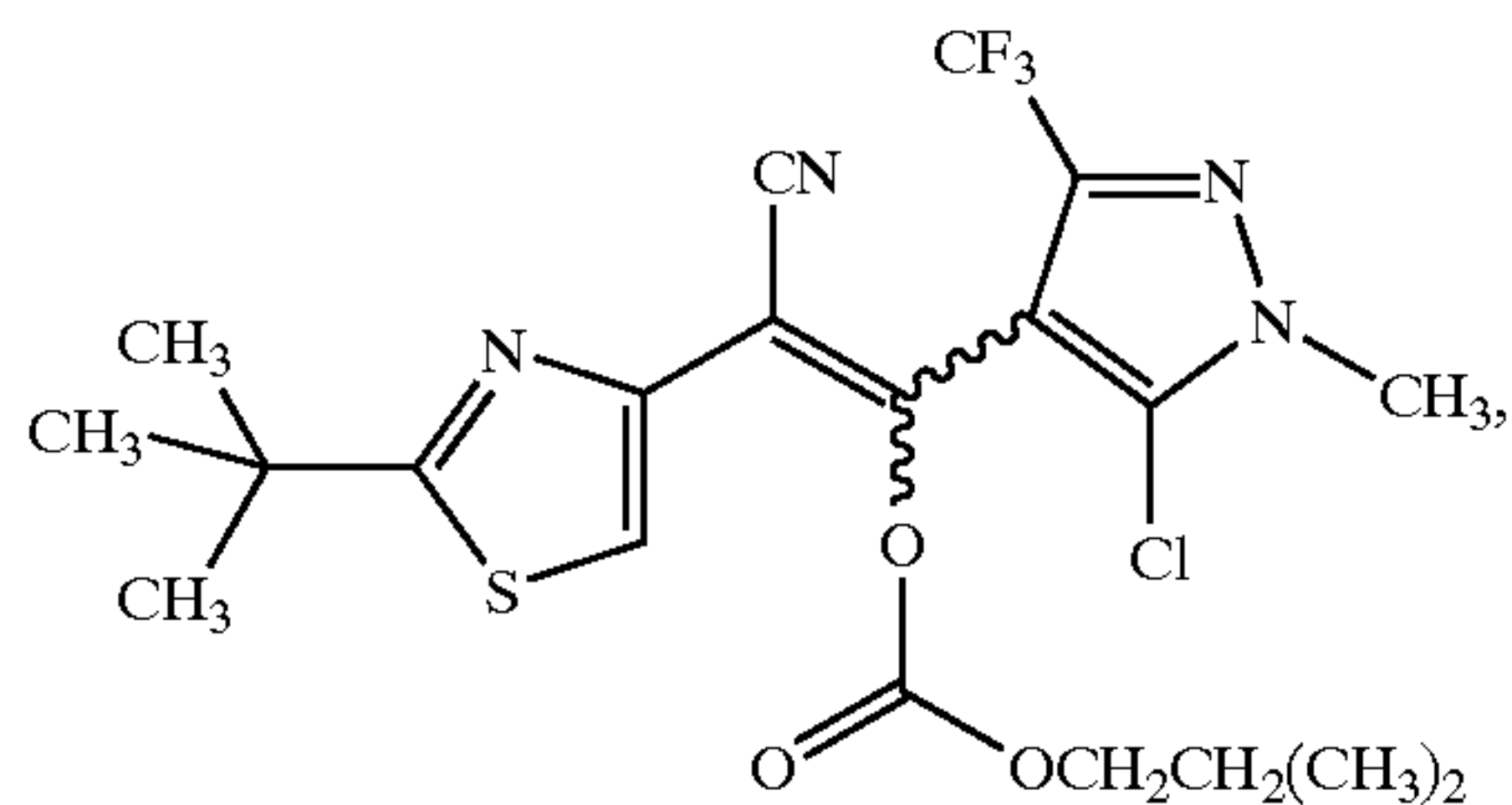
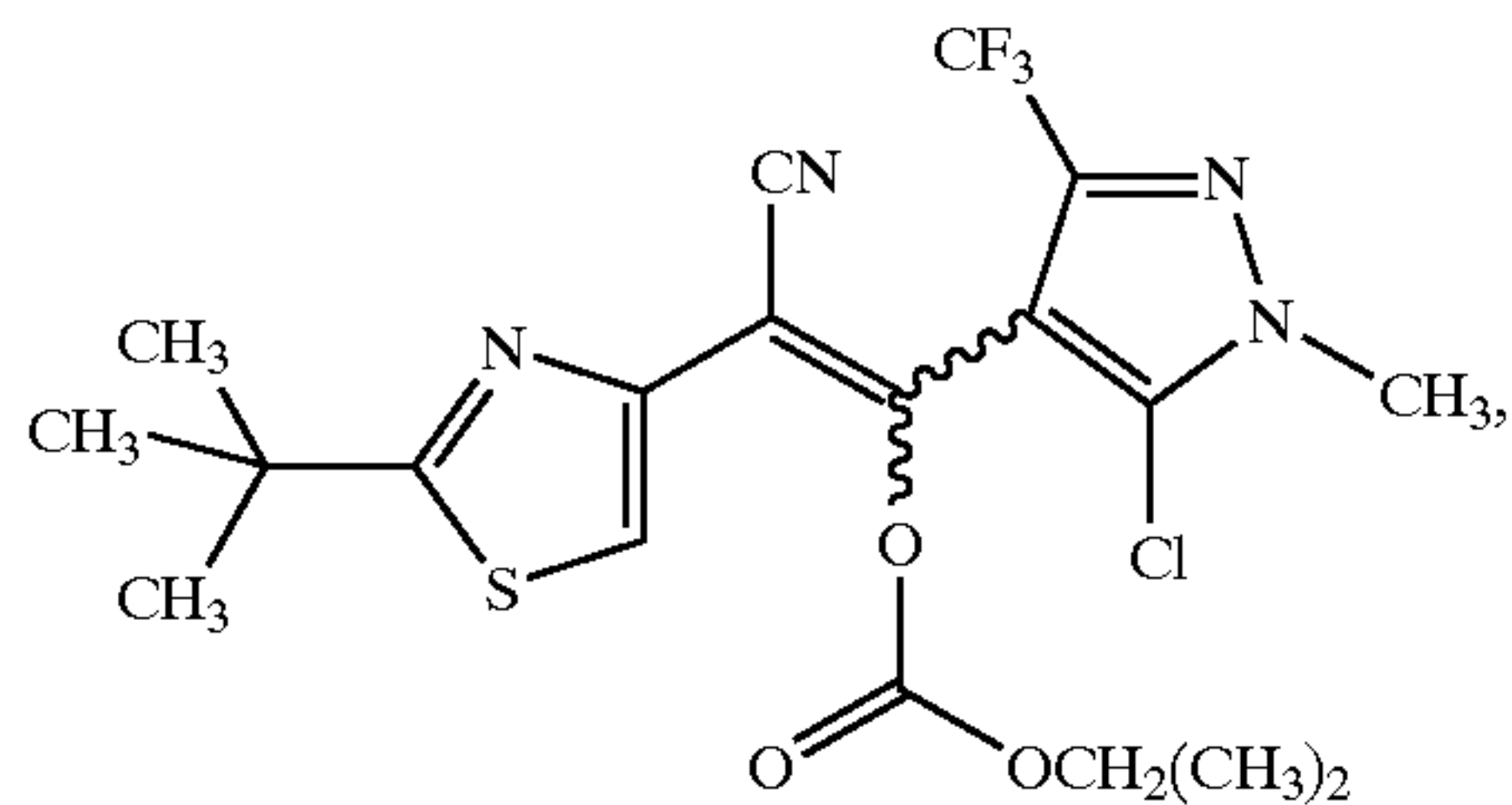
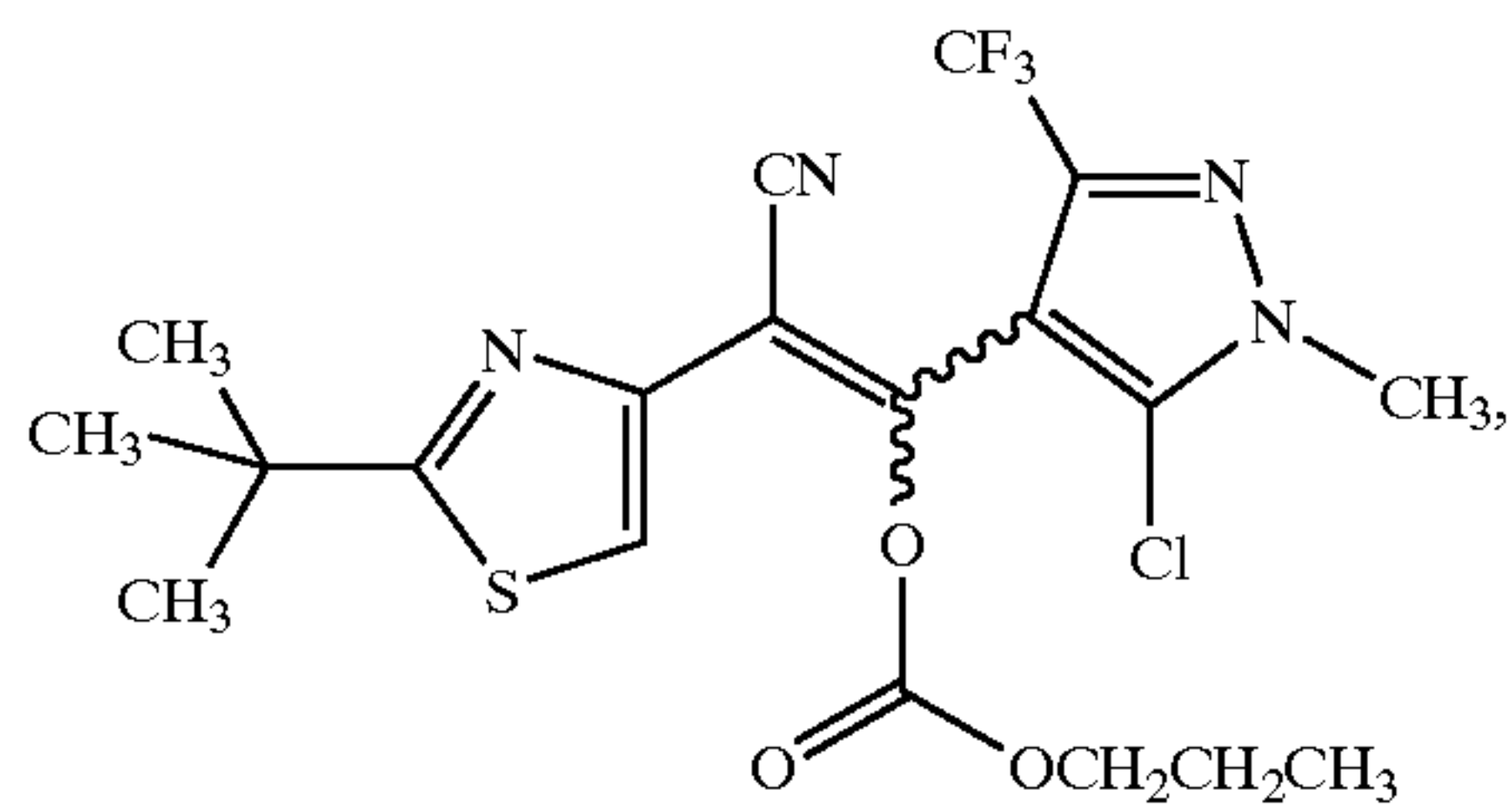

28

-continued

(6)

5

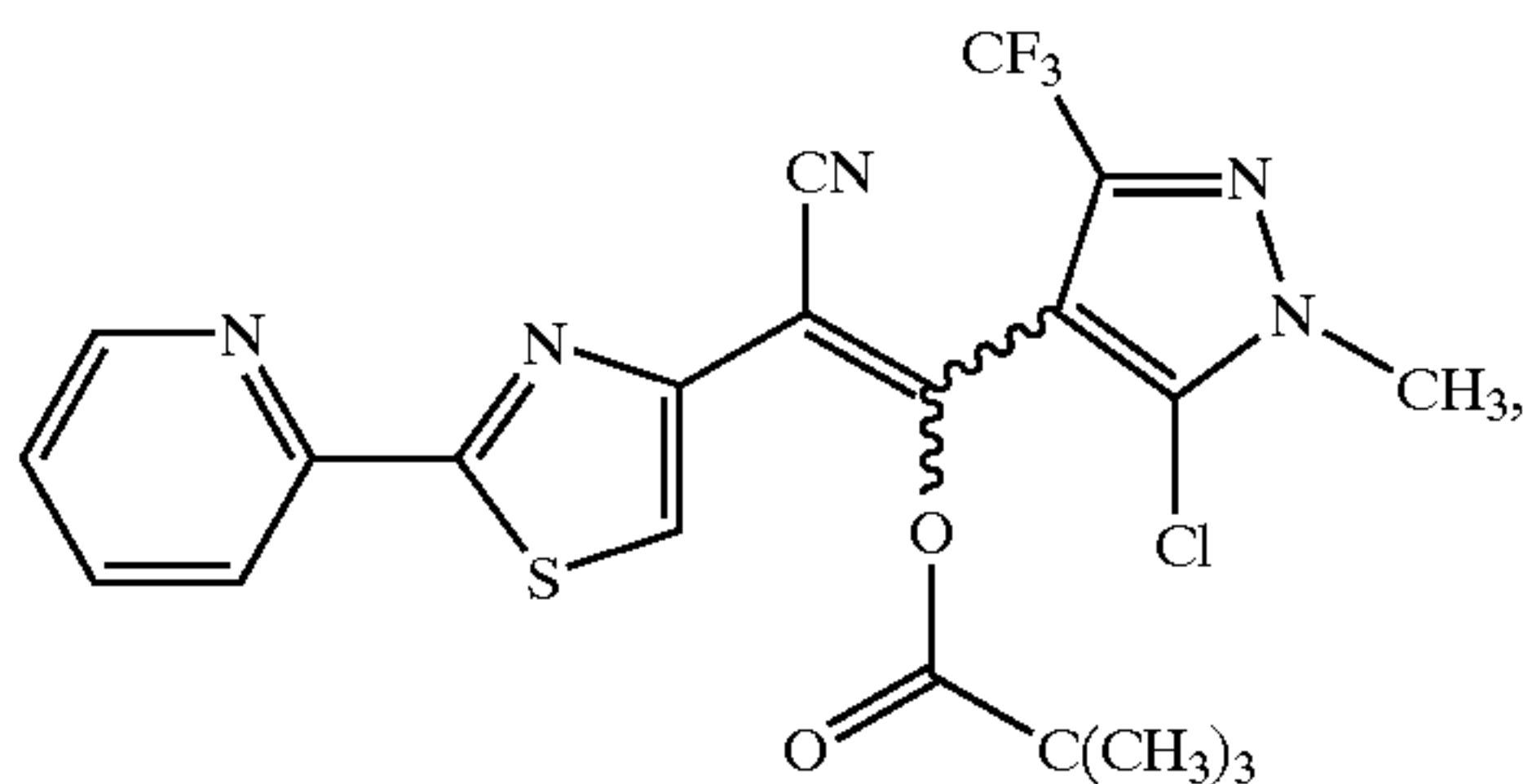

(7)

15

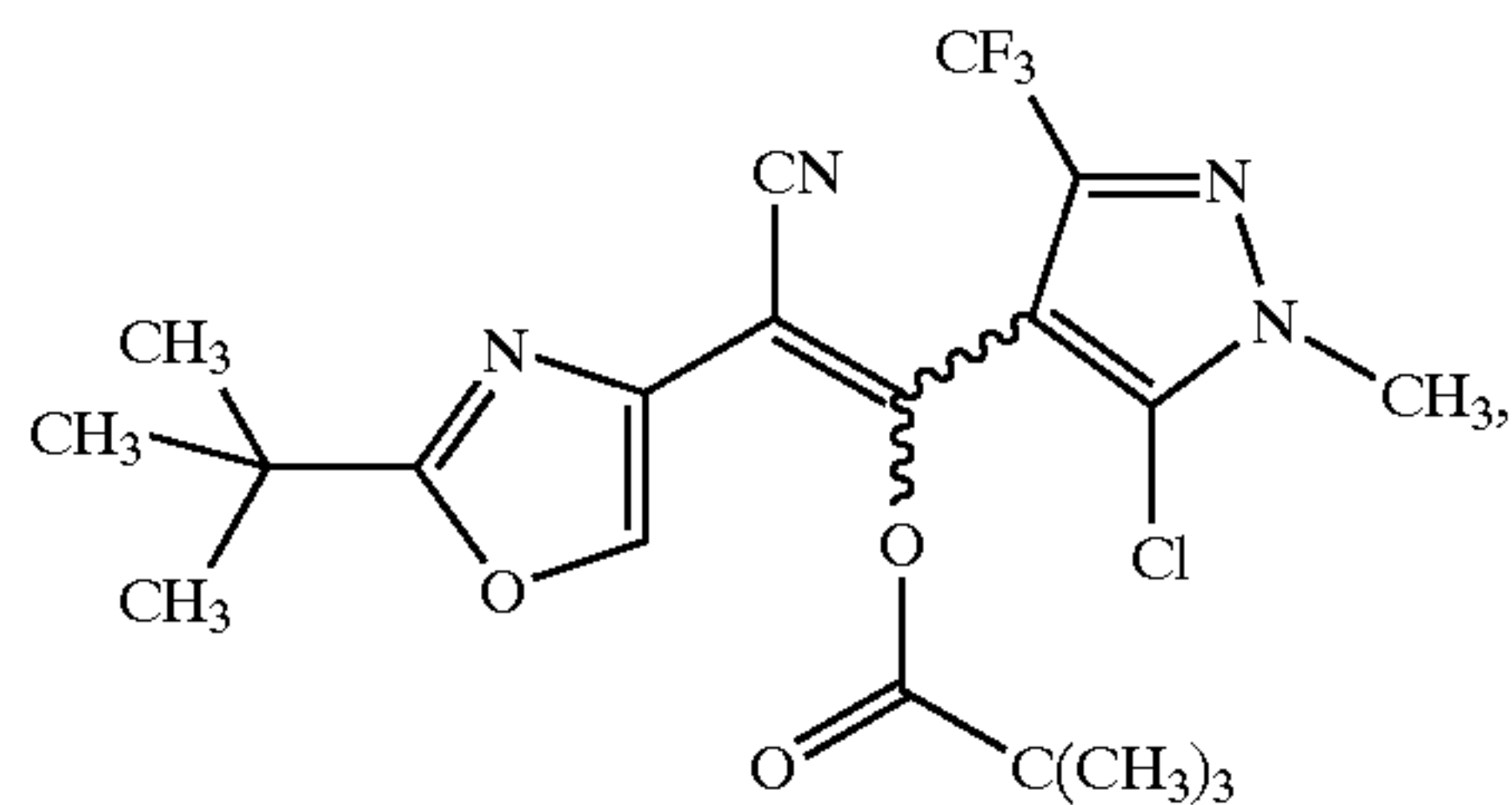

(8)

25

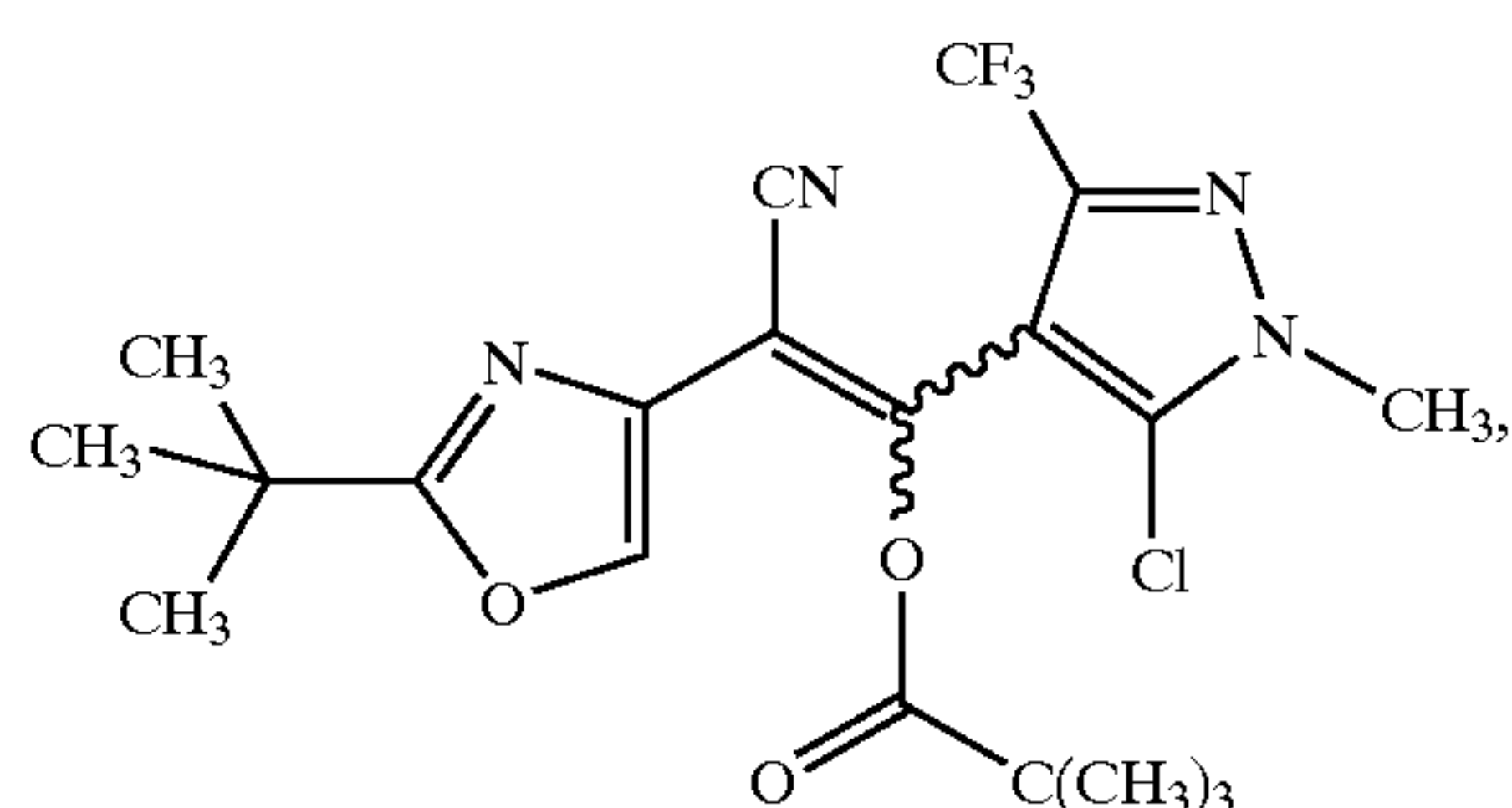

(9)

35

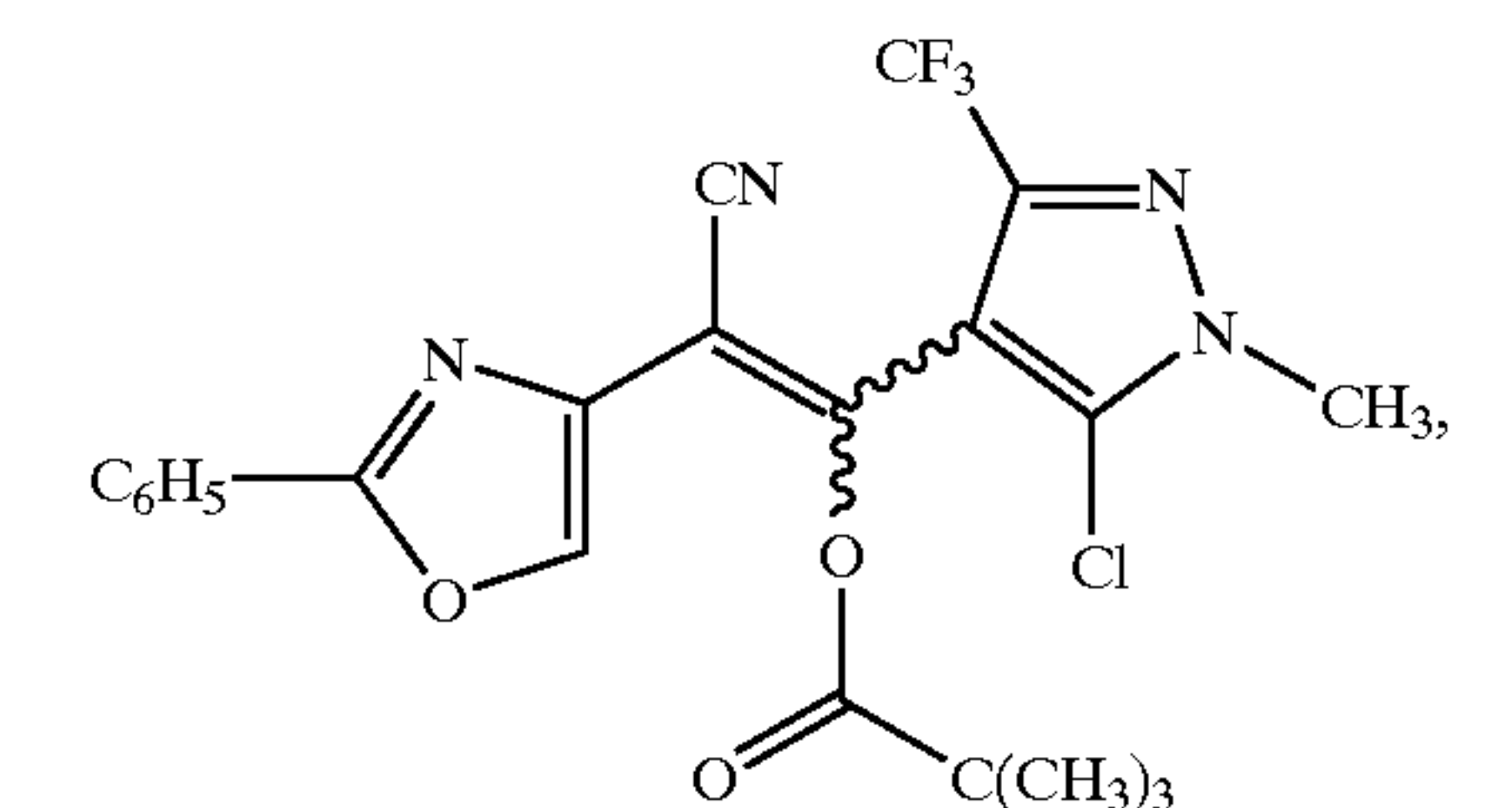

(10)

45

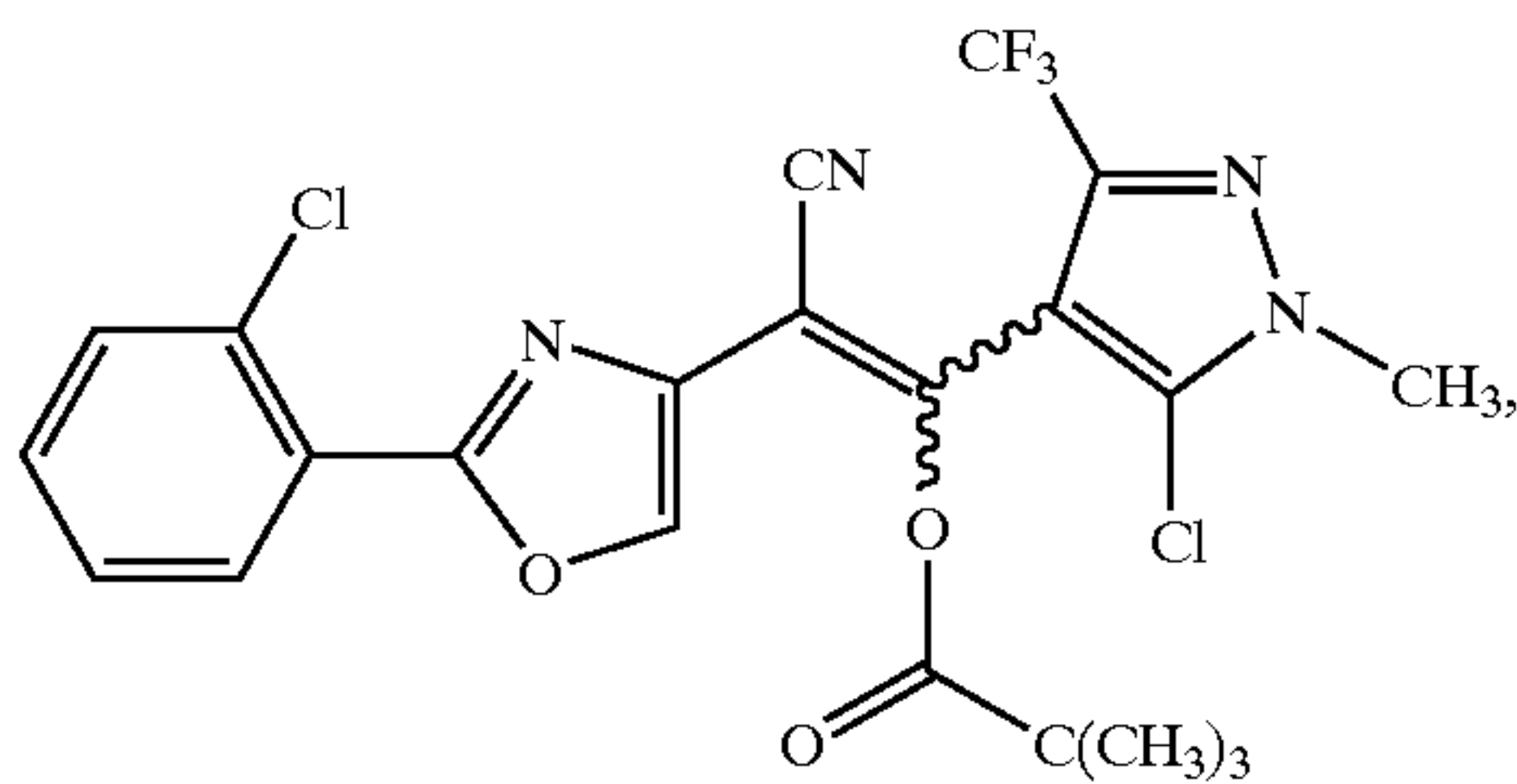

(11)

60

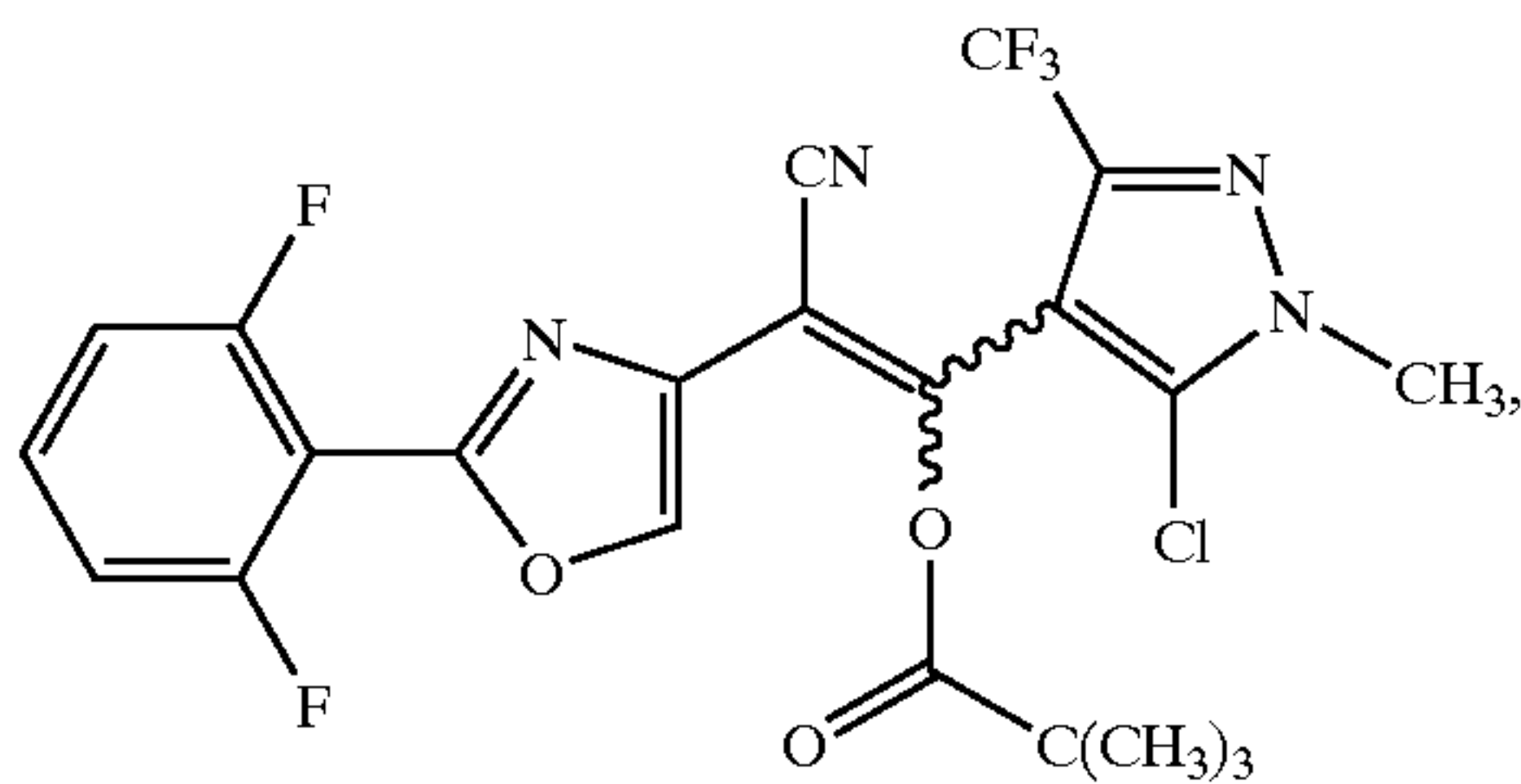

(12)

(13)

(14)

(15)

(16)

(17)

65

29
-continued

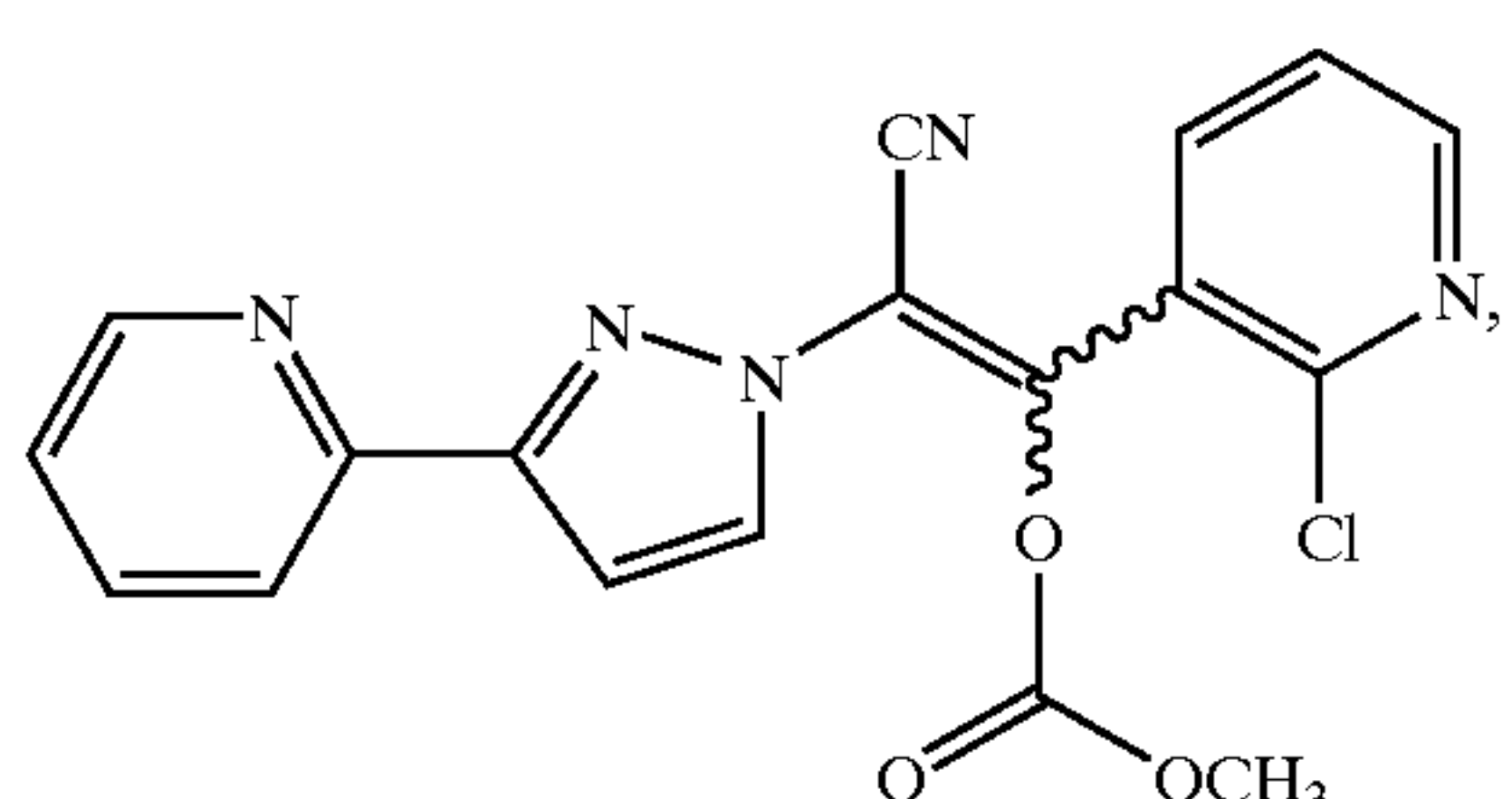
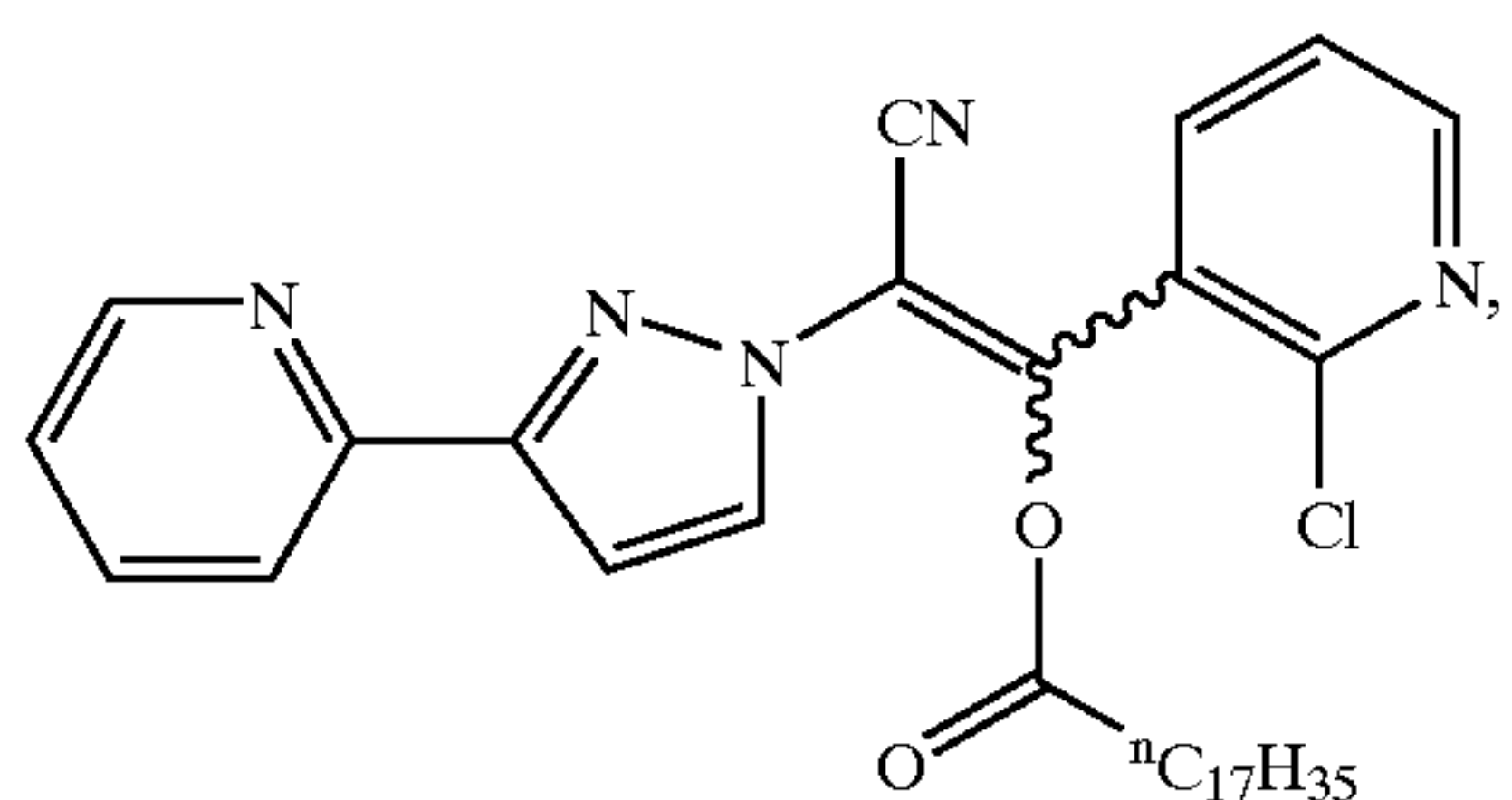
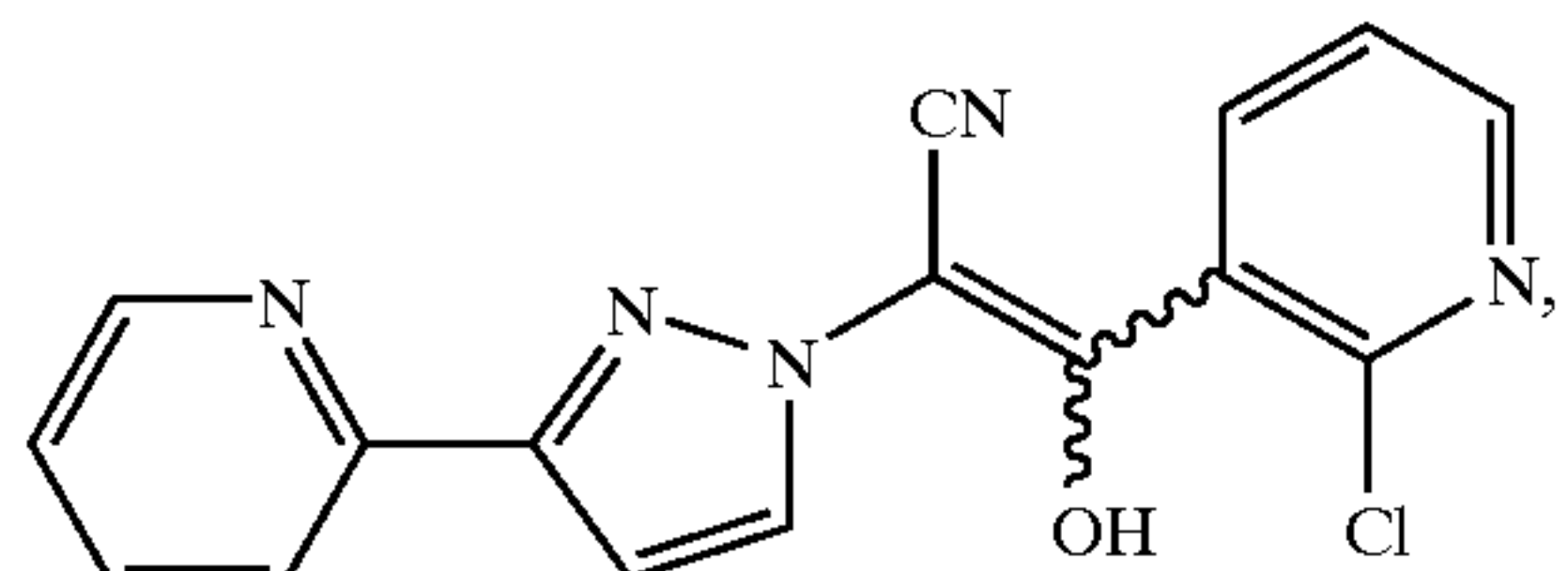
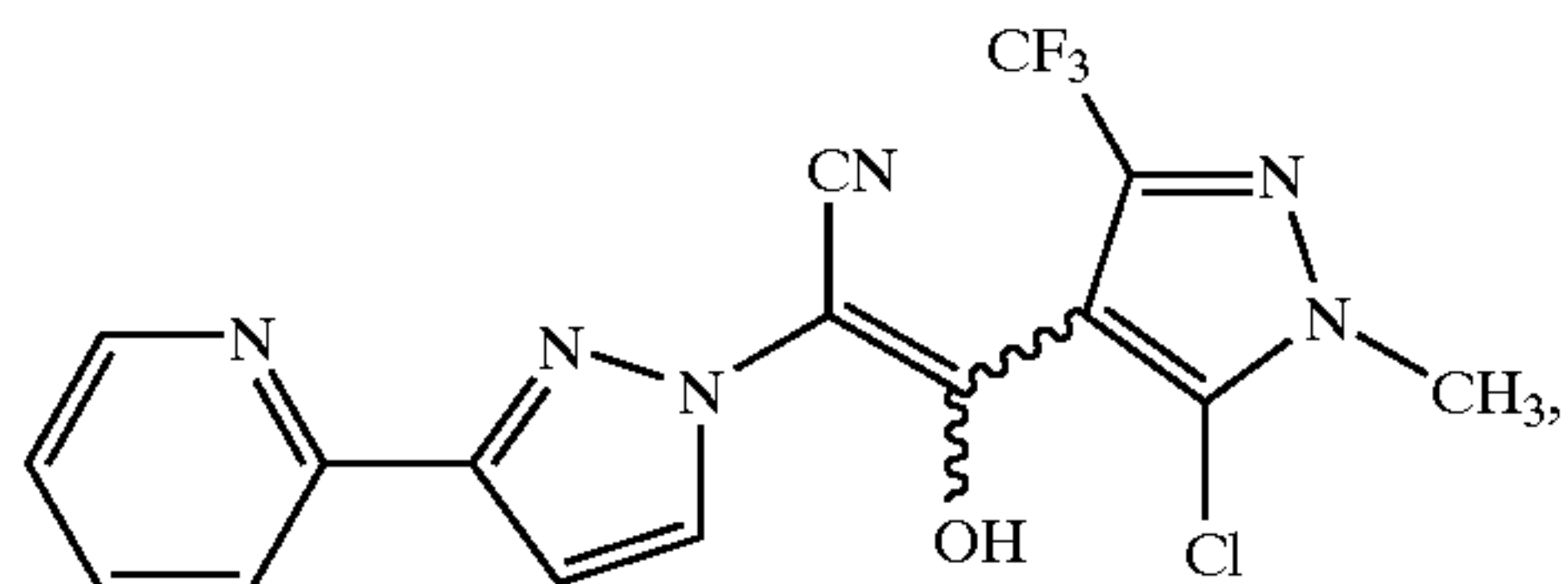
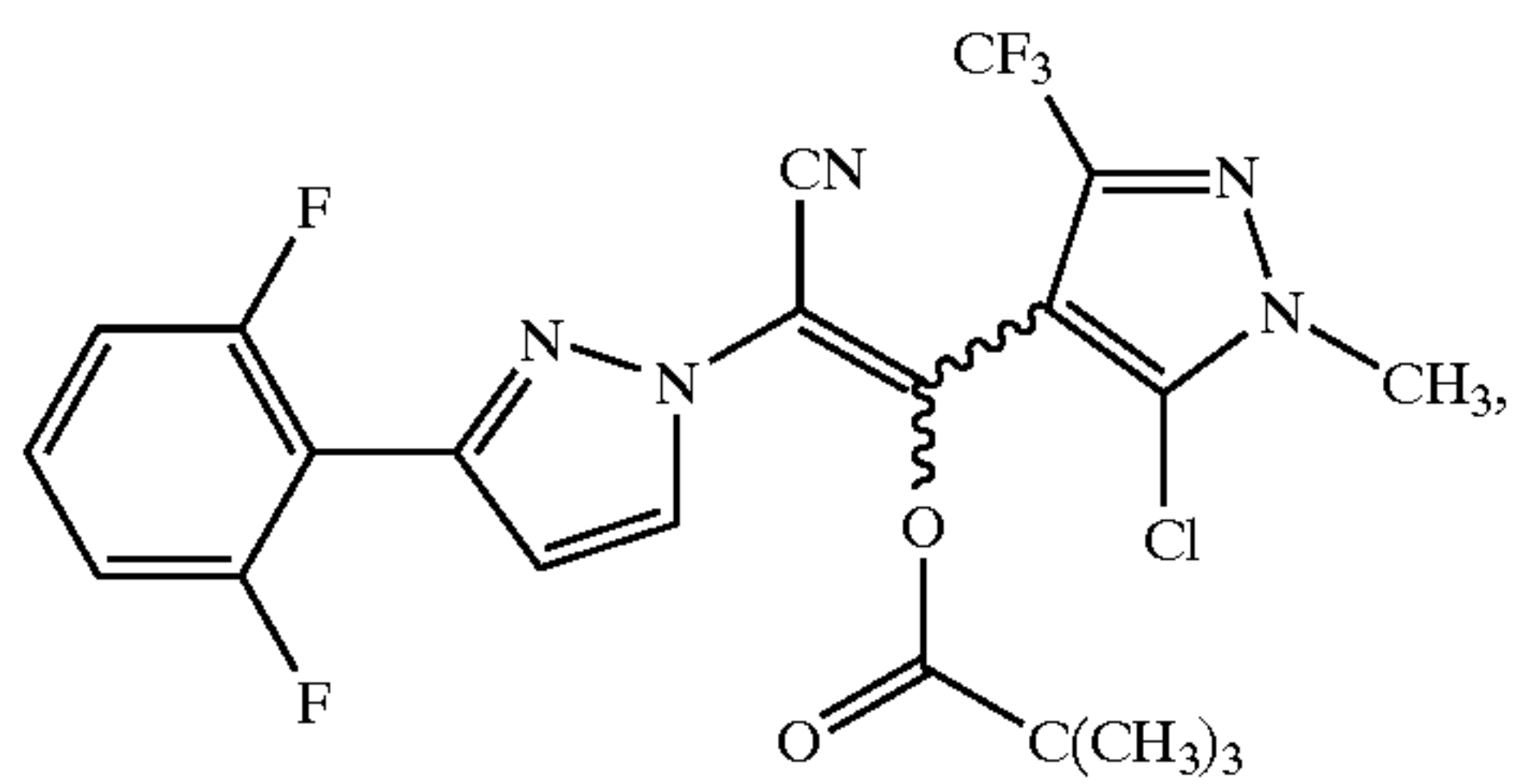
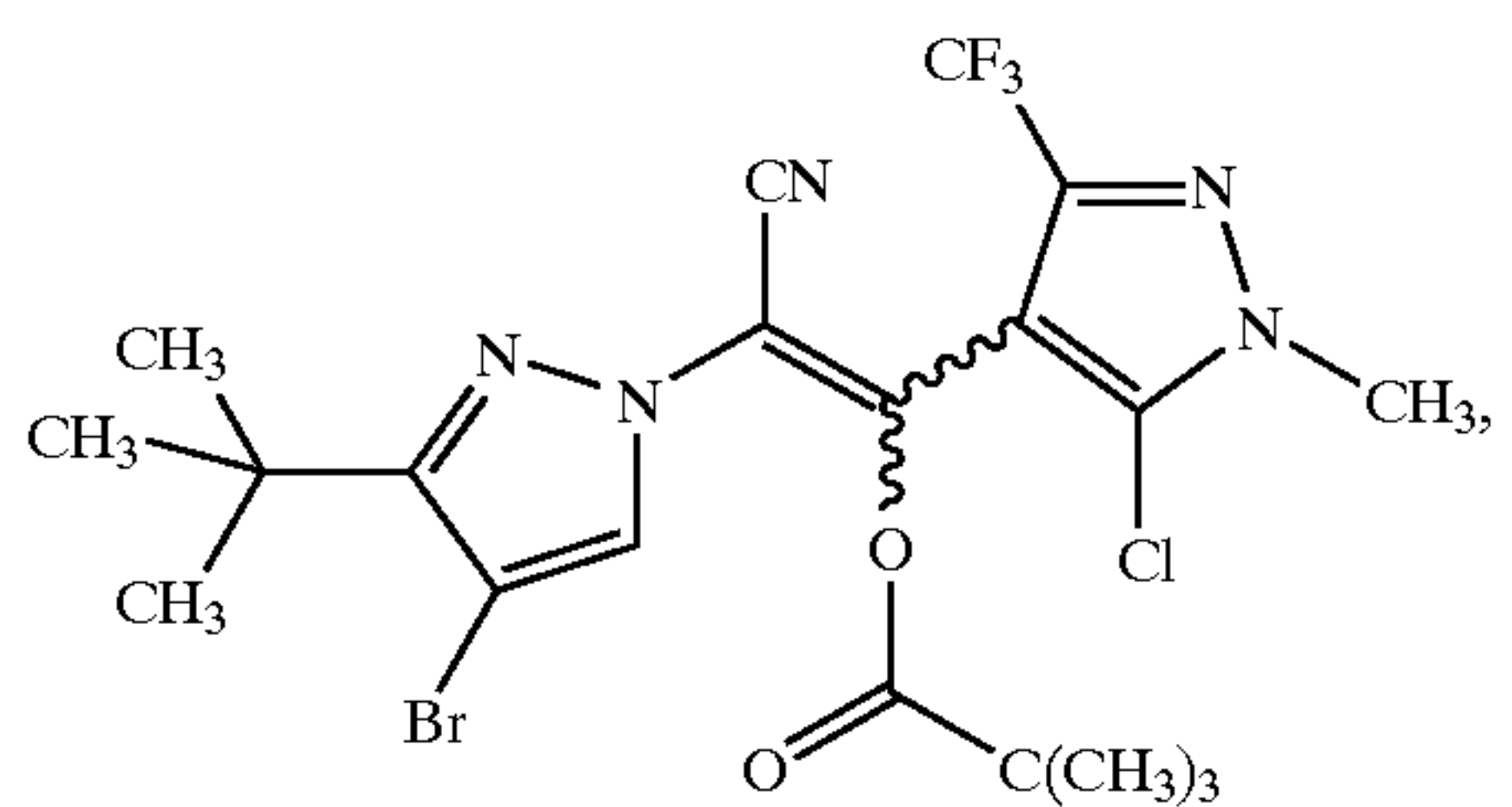
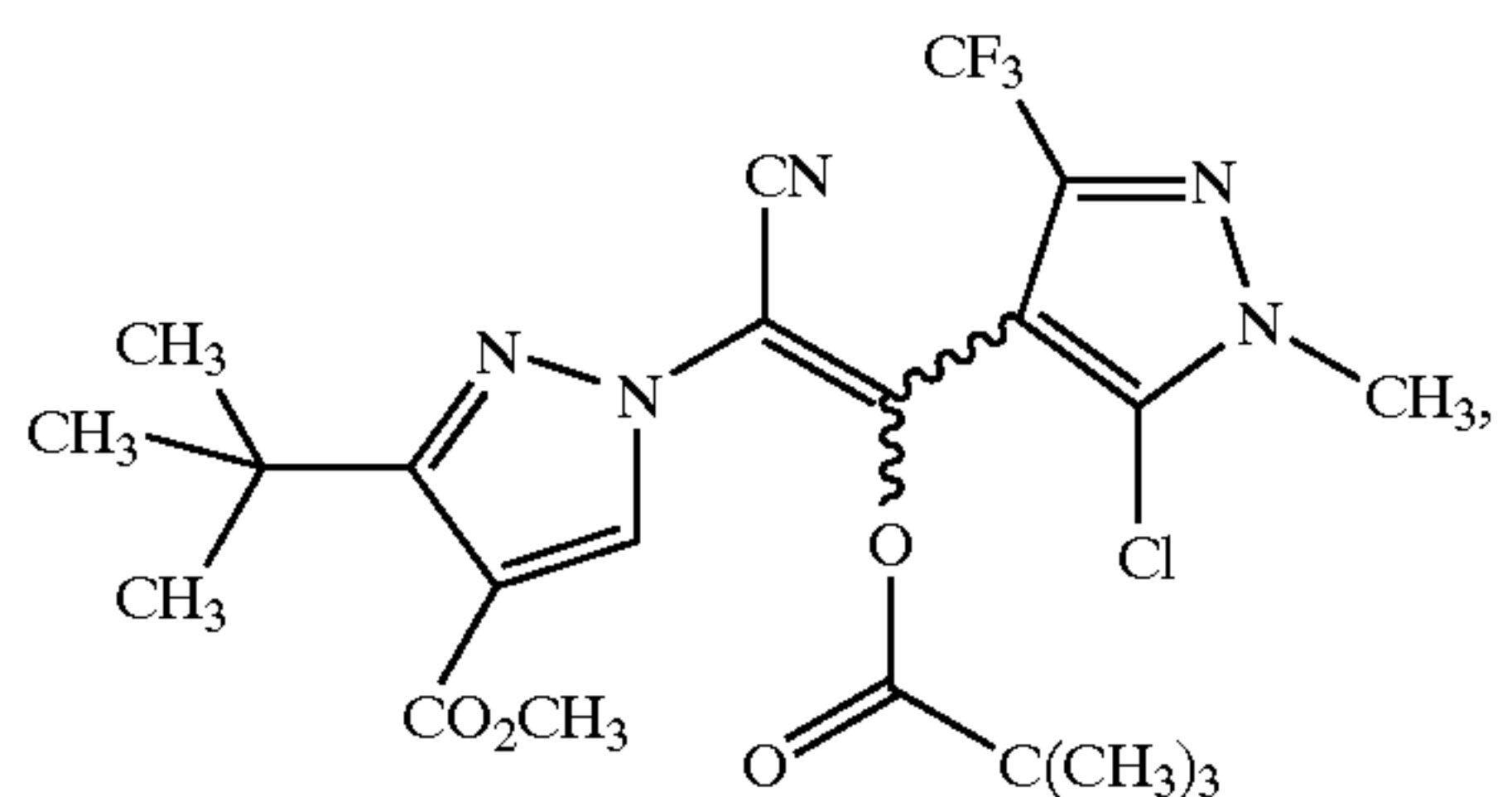

30
-continued

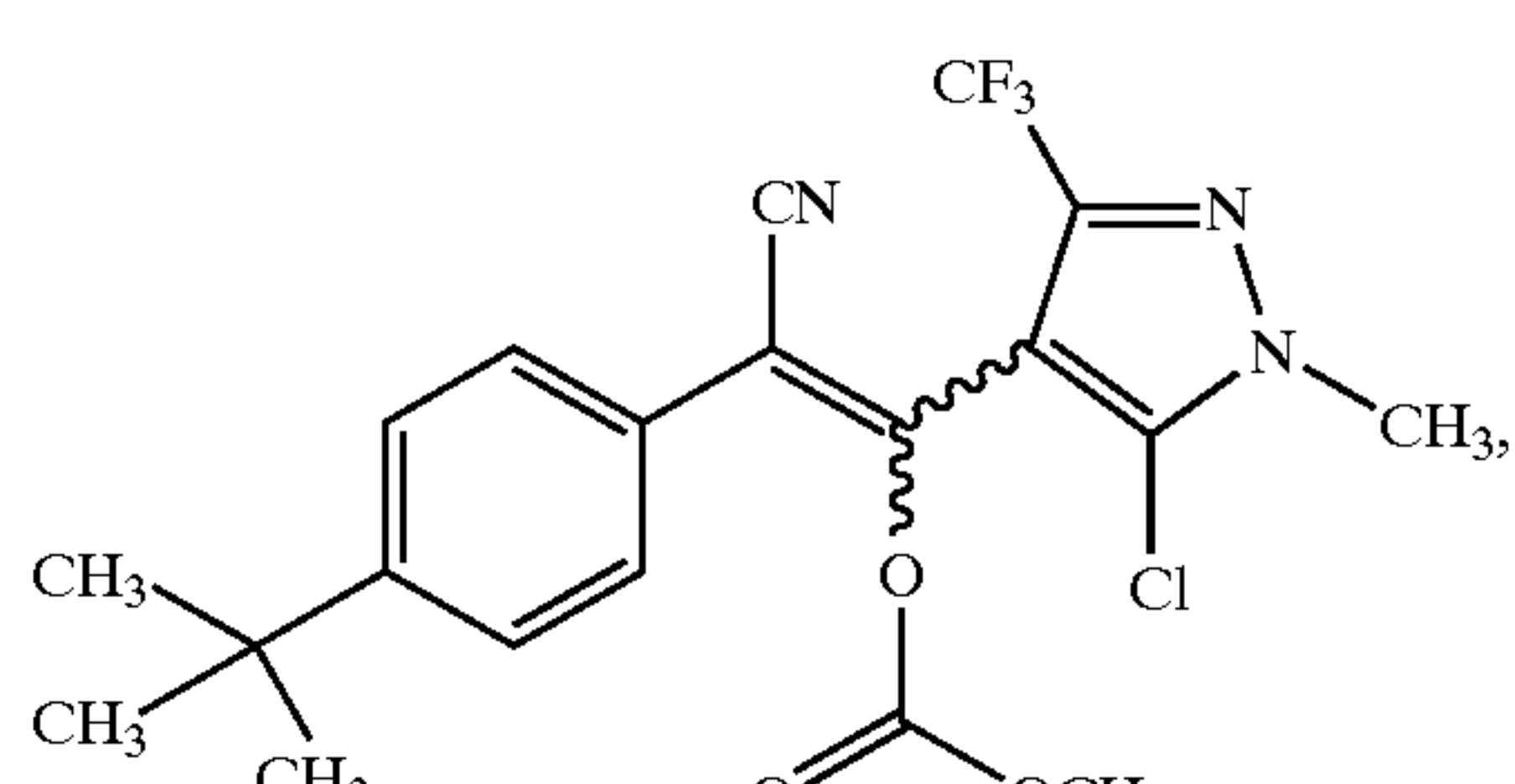
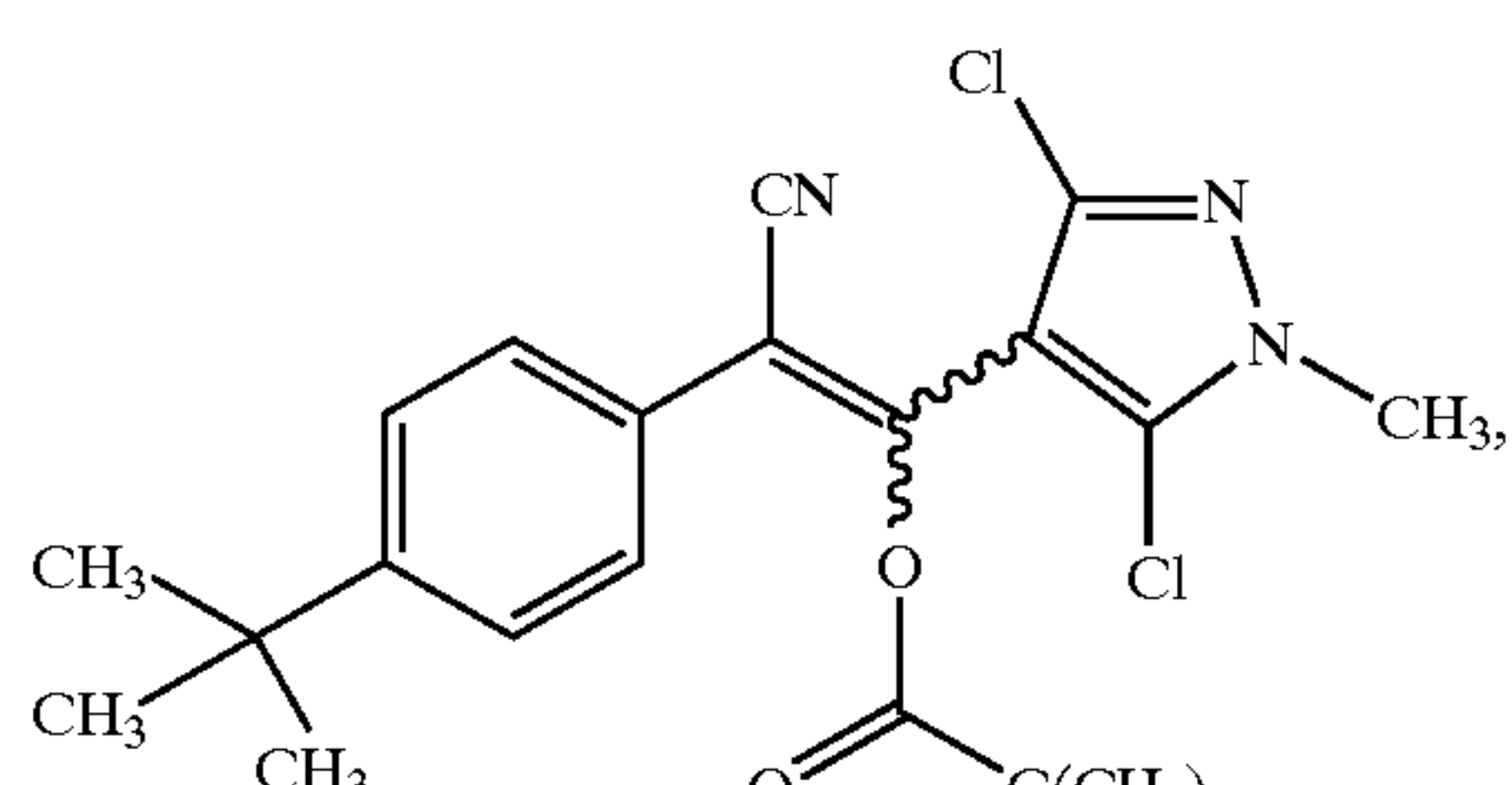
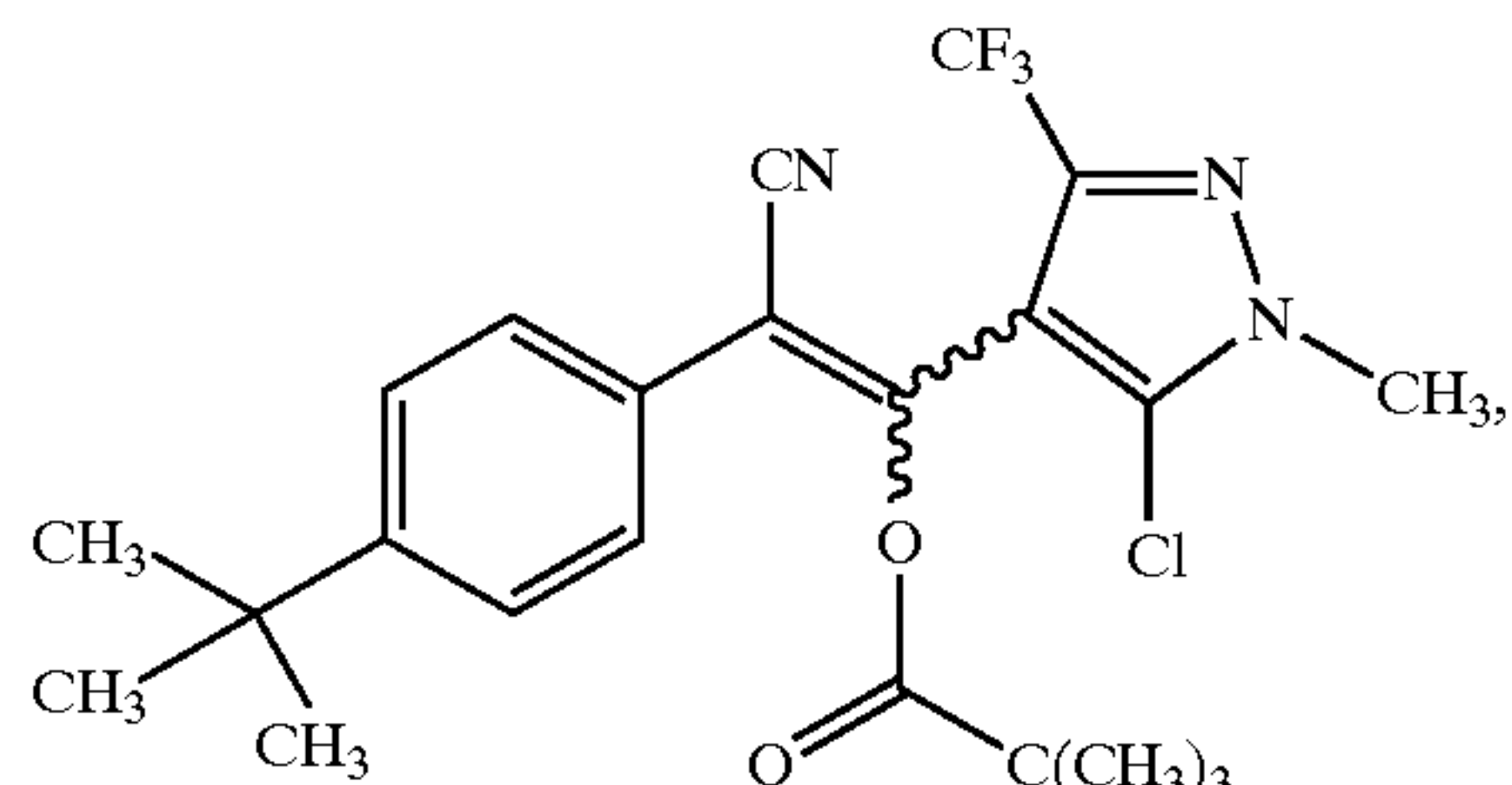
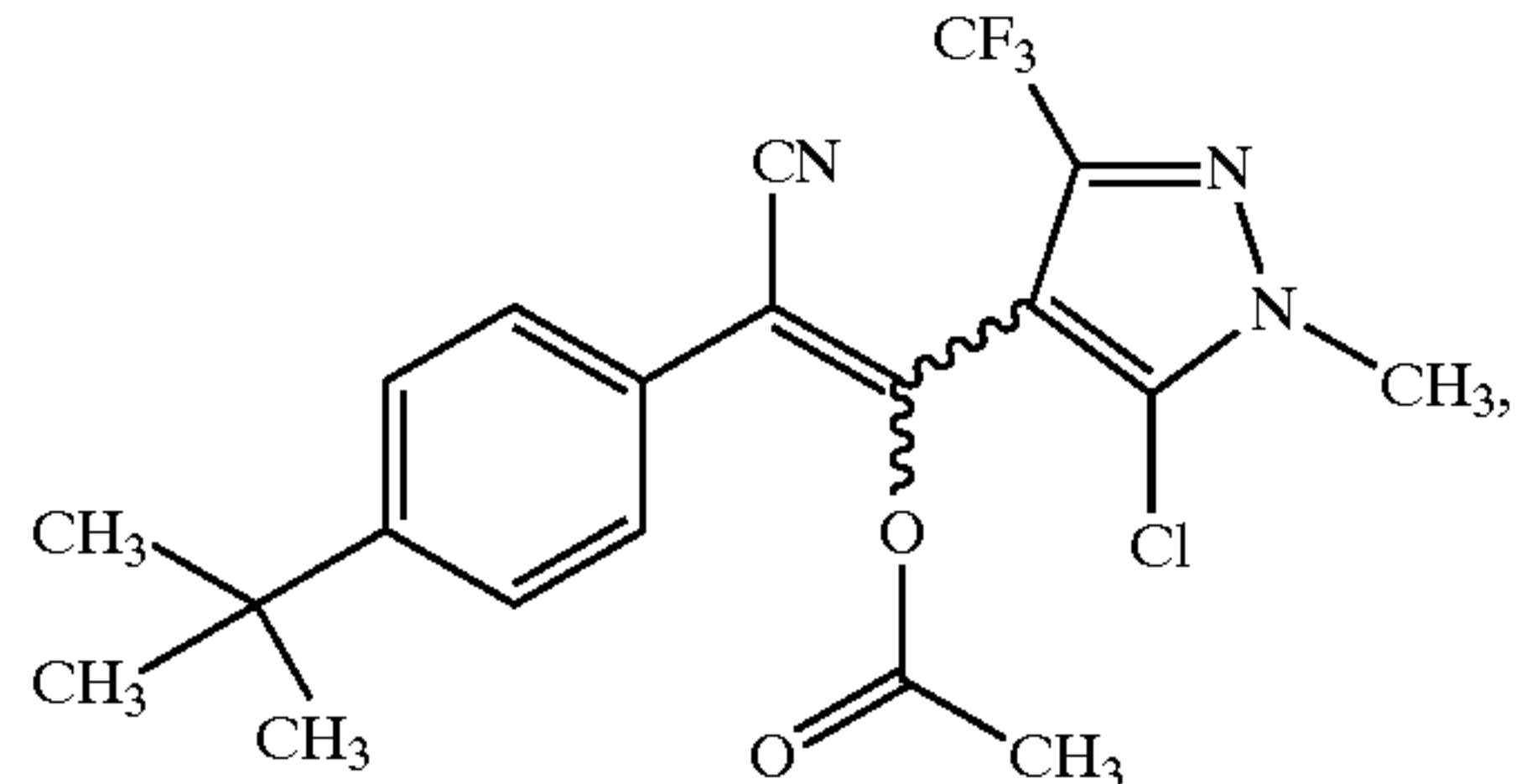
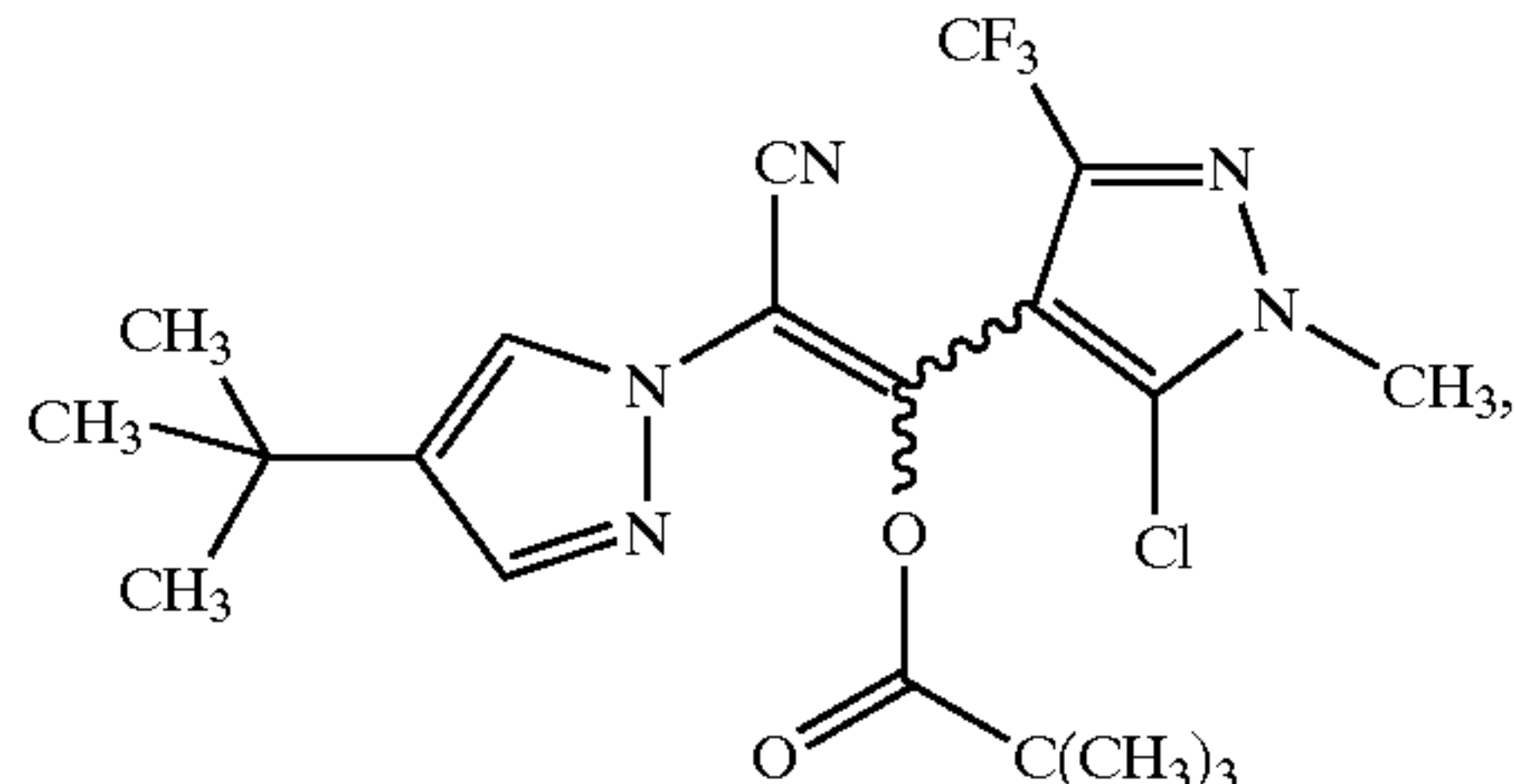
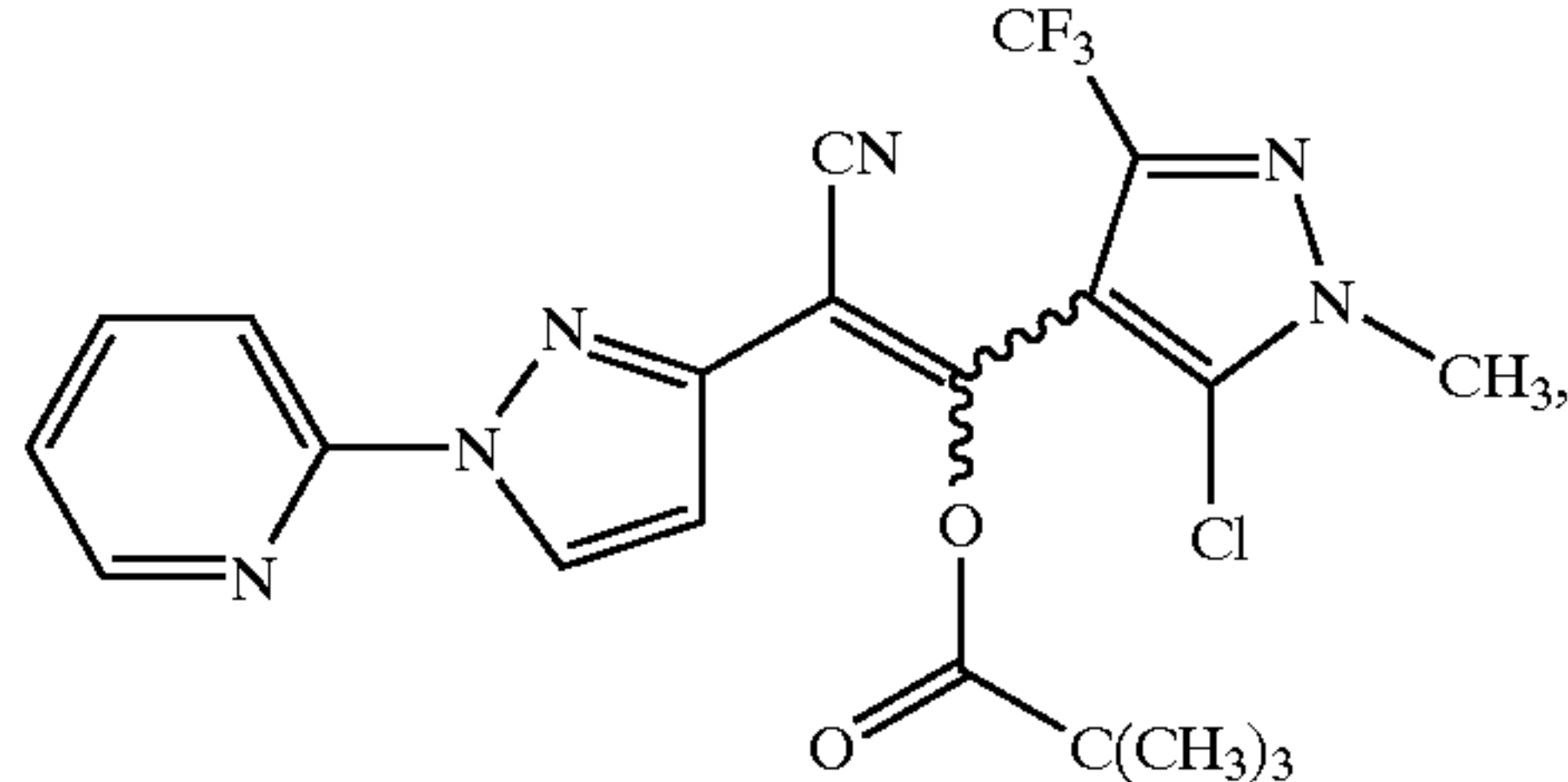

31

-continued

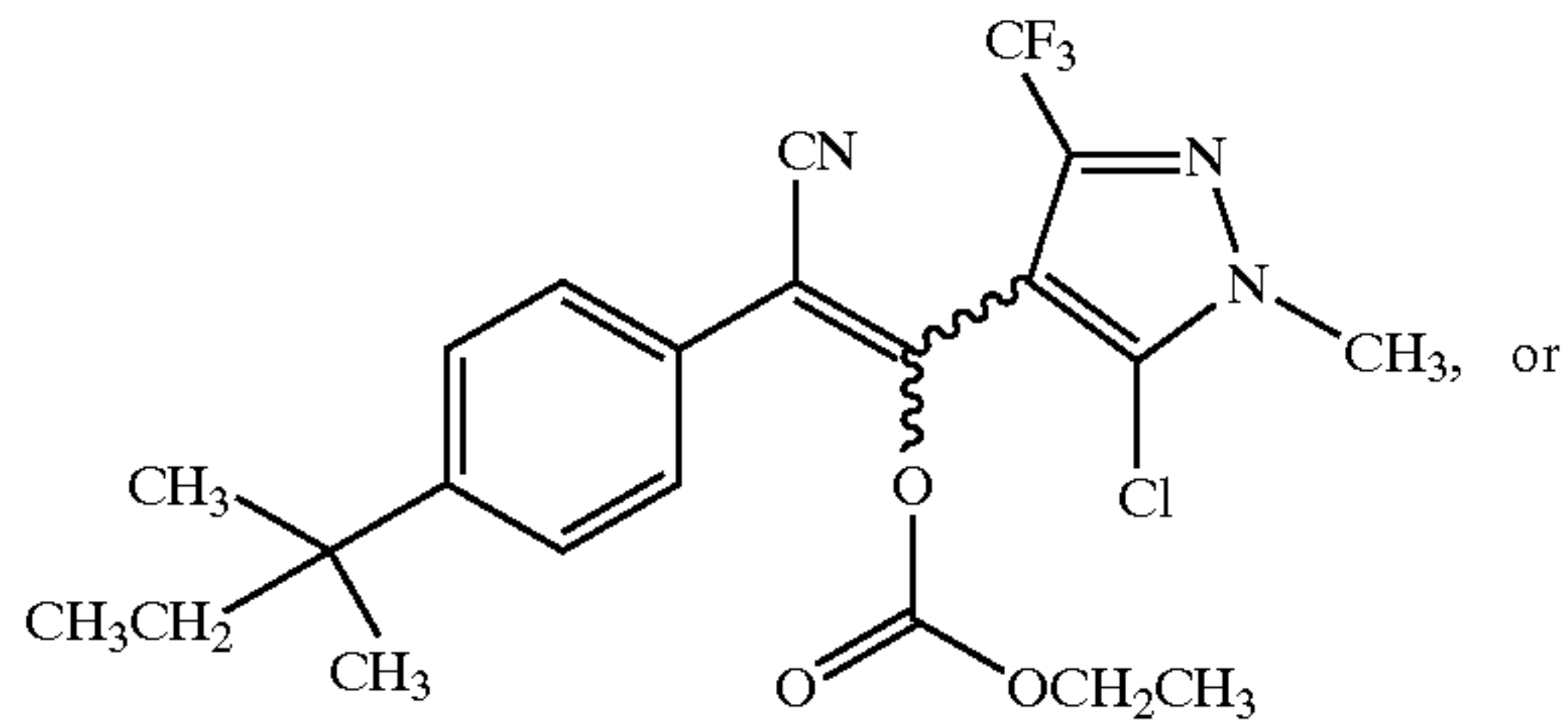
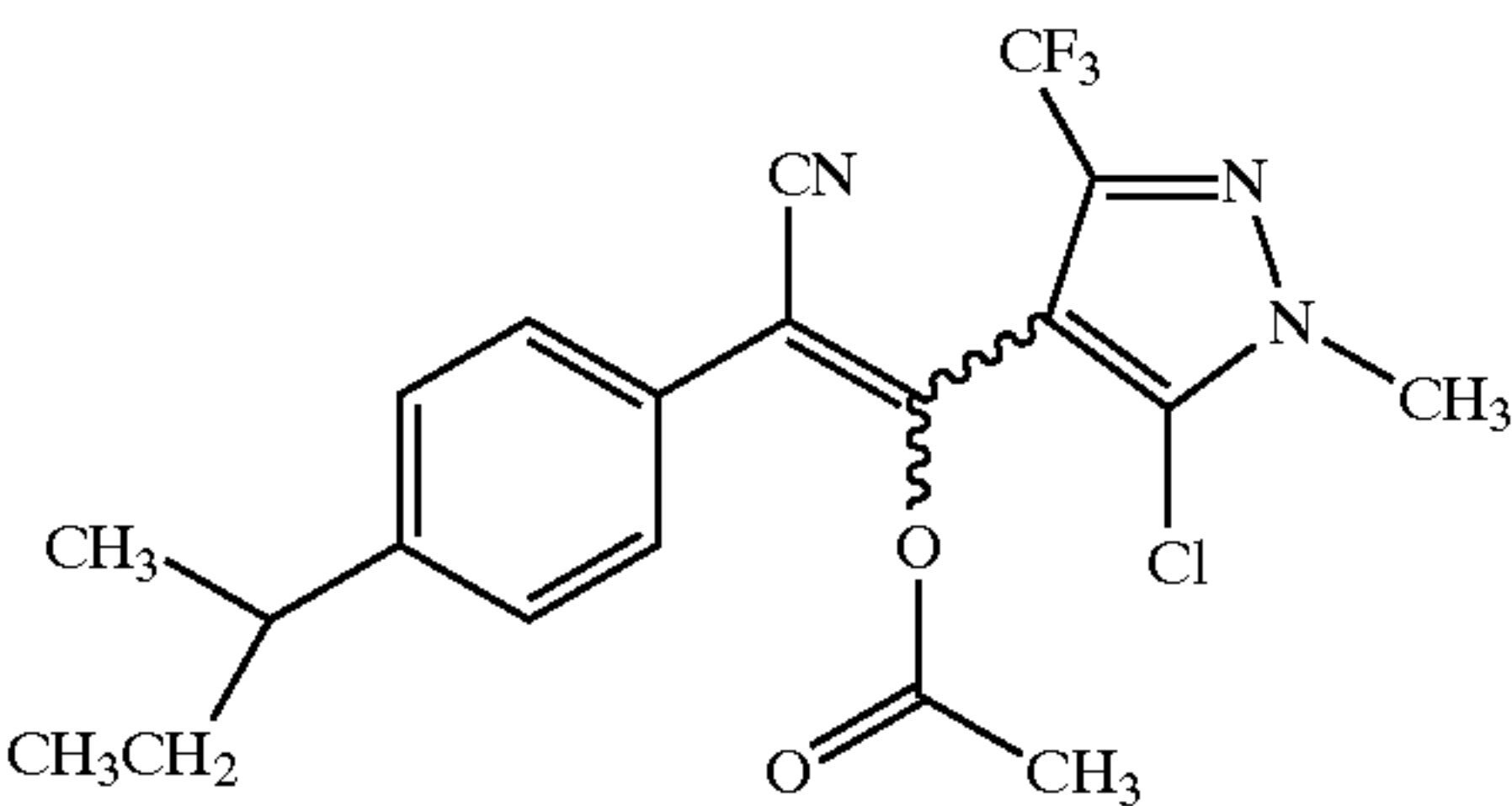
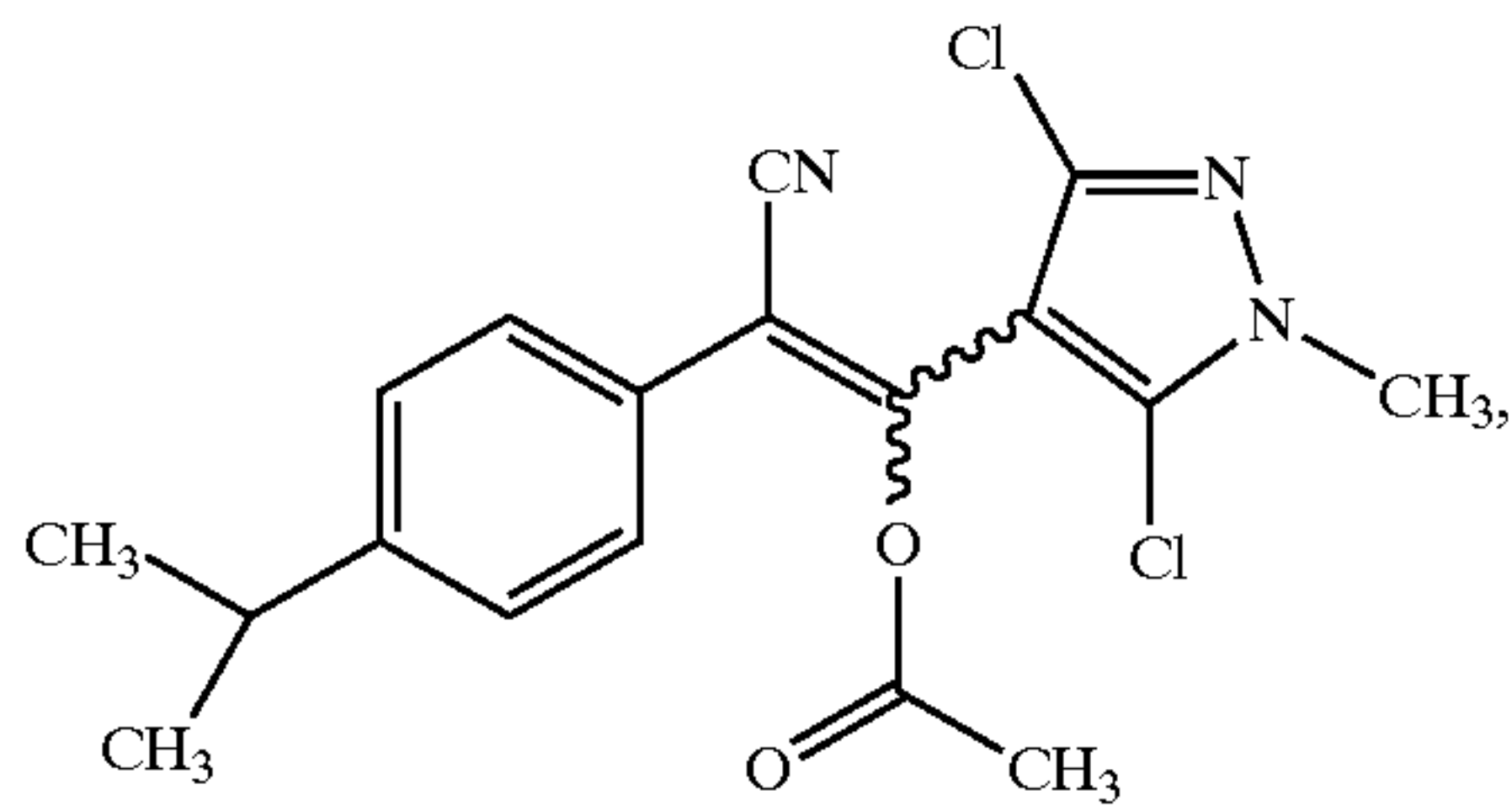
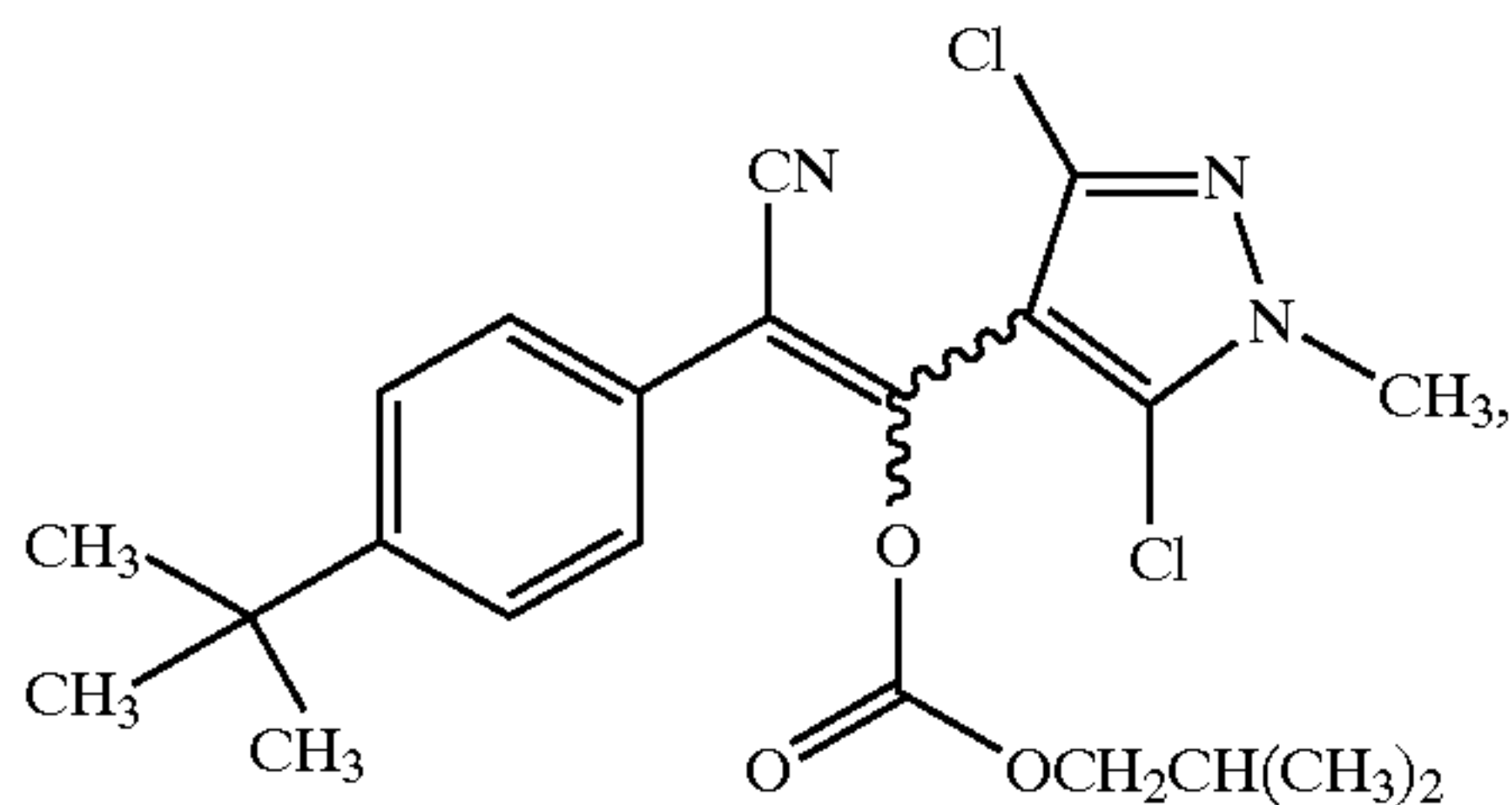
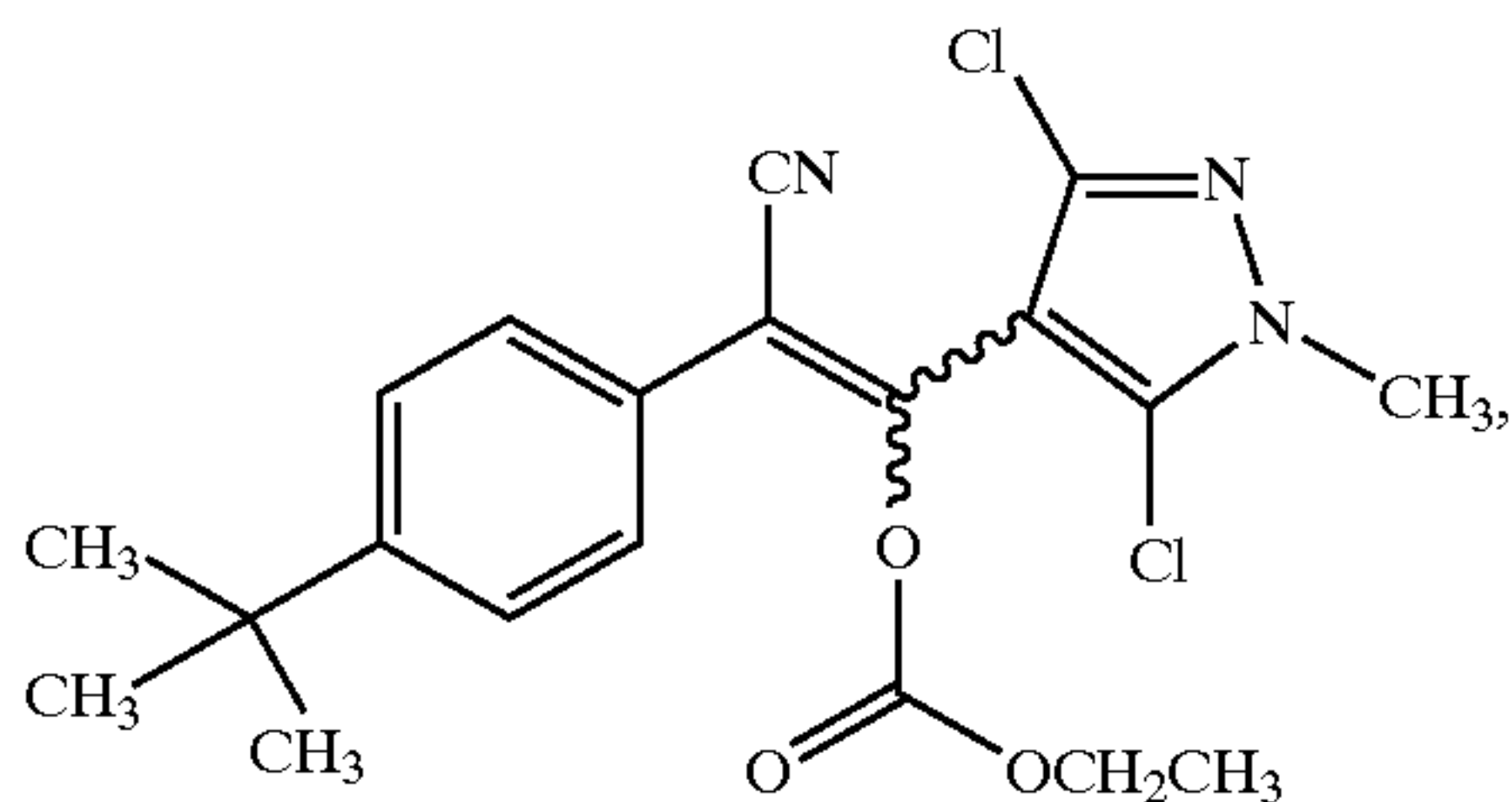
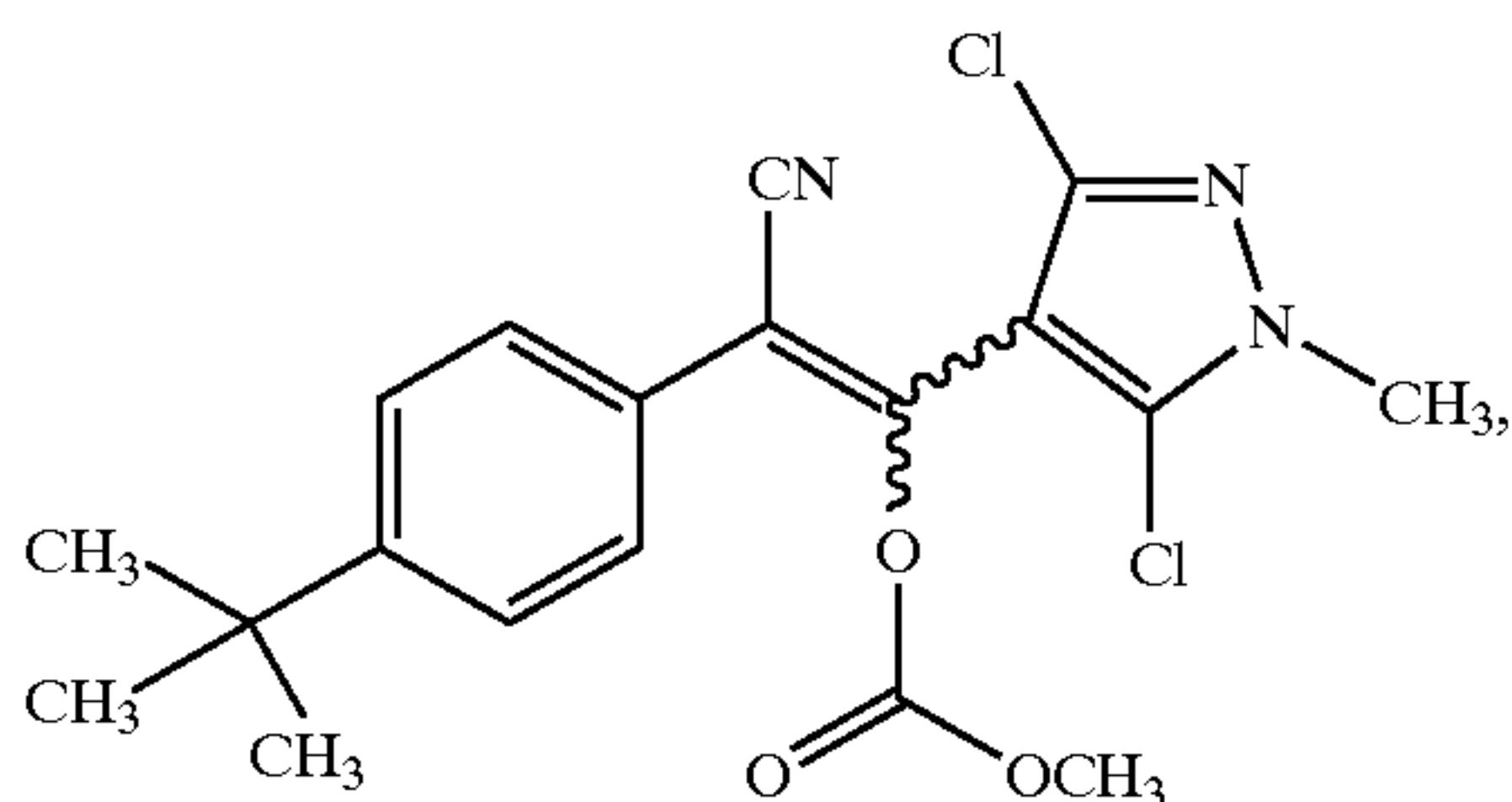

32

-continued

(31)

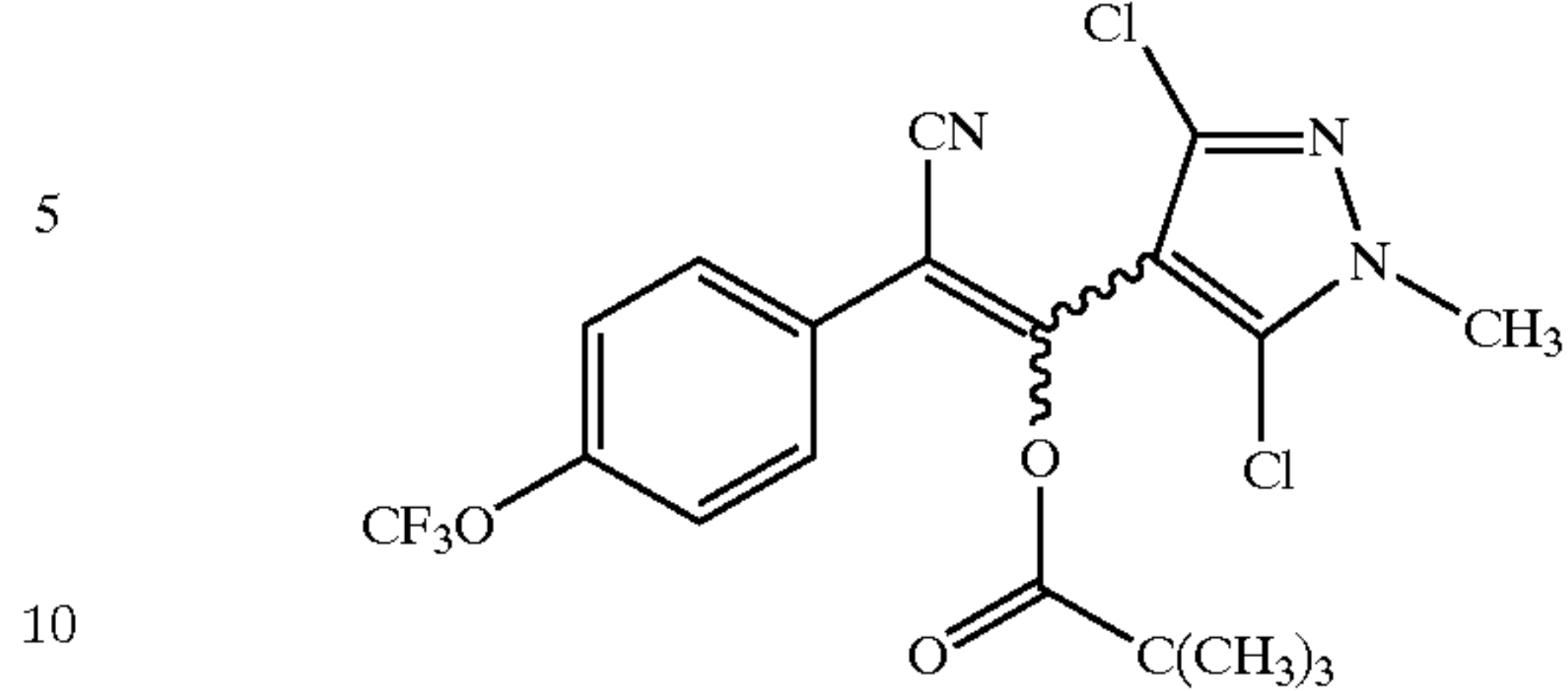

(37)

(32)

[24] An agricultural chemical comprising, as the active ingredient, one or more ethylene derivatives of the above-mentioned [1] to [23].

[25] An agent for preventing the attachment of aquatic organisms containing, as an active ingredient, one or more ethylene derivatives of the above-mentioned [1] to [23].

MODES OF CARRYING OUT THE INVENTION

The moiety —C(E)=C(OB)— of the compounds (I) of the present invention includes two isomers of E-form and Z-form, both of which are within the scope of the invention.

It will be understood that the compounds (I) of the present invention where the substituent B is a hydrogen atom exist as tautomers to be represented by the following:

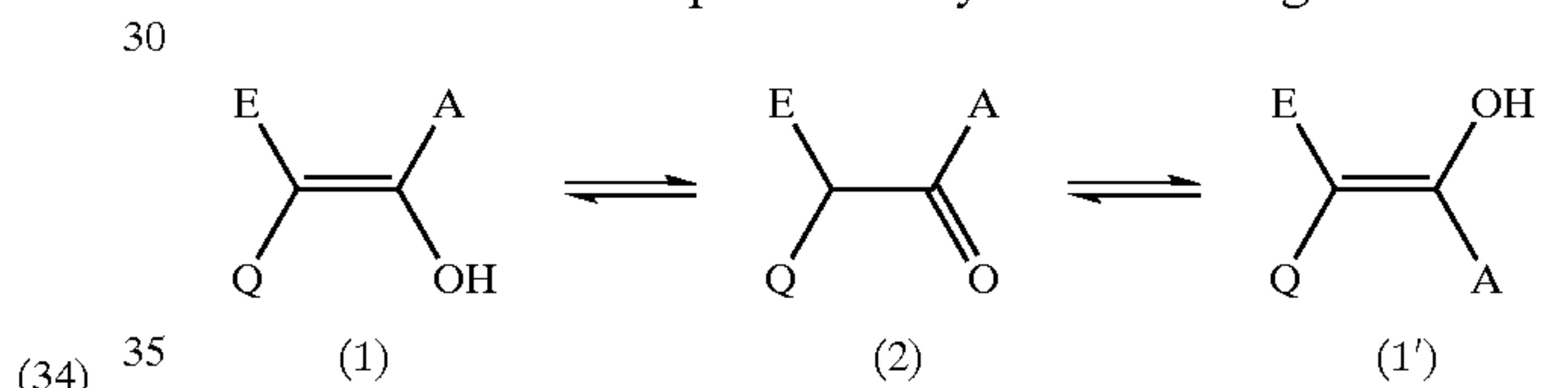

Although the compounds (I) will exist essentially as the enol-form (1'), they could be as the tautomer form (2) under some conditions. It should be understood that the present invention includes all these three tautomers and their mixtures.

Now, preferred embodiments of Q, A, B, E, G, R, R¹, Y, Y¹, Y², W, X, Z, T¹, T², T³, T⁴, T⁵, T⁶, T⁷, T⁸, U¹, U², m, n, p and q are referred to hereunder.

The heterocyclic group for Q, A and B indicates the following meanings.

Specifically, thienyl is thiophen-2-yl or thiophen-3-yl; furyl is furan-2-yl or furan-3-yl; pyrrolyl is pyrrol-1-yl, pyrrol-2-yl or pyrrol-3-yl; oxazolyl is oxazol-2-yl, oxazol-3-yl, oxazol-4-yl or oxazol-5-yl; thiazolyl is thiazol-2-yl, thiazol-4-yl or thiazol-5-yl; imidazolyl is imidazol-1-yl, imidazol-2-yl or imidazol-4-yl; isoxazolyl is isoxazol-3-yl, isoxazol-4-yl or isoxazol-5-yl; isothiazolyl is isothiazol-3-yl, isothiazol-4-yl or isothiazol-5-yl; pyrazolyl is pyrazol-1-yl, pyrazol-3-yl, pyrazol-4-yl or pyrazol-5-yl; 1,3,4-oxadiazolyl is 1,3,4-oxadiazol-2-yl; 1,3,4-thiadiazolyl is 1,3,4-thiadiazol-2-yl; 1,2,4-oxadiazolyl is 1,2,4-oxadiazol-3-yl or 1,2,4-oxadiazol-5-yl; 1,2,4-thiadiazolyl is 1,2,4-thiadiazol-3-yl or 1,2,4-thiadiazol-5-yl; 1,2,4-triazolyl is 1,2,4-triazol-1-yl, 1,2,4-triazol-3-yl or 1,2,4-triazol-4-yl; 1,2,3-thiadiazolyl is 1,2,3-thiadiazol-4-yl or 1,2,3-thiadiazol-5-yl; 1,2,3-triazolyl is 1,2,3-triazol-1-yl; 1,2,3-triazol-2-yl or 1,2,3-triazol-4-yl; 1,2,3,4-tetrazolyl is 1,2,3,4-tetrazol-1-yl, 1,2,

3,4-tetrazol-2-yl or 1,2,3,4-tetrazol-5-yl; pyridinyl is pyridin-2-yl, pyridin-3-yl or pyridin-4-yl; pyrimidinyl is pyrimidin-2-yl, pyrimidin-4-yl or pyrimidin-5-yl; pyrazinyl is pyrazin-2-yl; pyridazinyl is pyridazin-3-yl or pyridazin-4-yl; 1,3,5-triazinyl is 1,3,5-triazin-2-yl; 1,2,4-triazinyl is 1,2,4-triazin-3-yl, 1,2,4-triazin-5-yl or 1,2,4-triazin-6-yl; 1,2,4,5-tetrazinyl is 1,2,4,5-tetrazin-3-yl; pyrazolinyl is 3-pyrazolin-1-yl, 3-pyrazolin-3-yl, 3-pyrazolin-4-yl or 3-pyrazolin-5-yl; imidazolyl is 1-imidazolin-3-yl, 1-imidazolin-2-yl, 1-imidazolin-4-yl or 4-imidazolin-2-yl; oxazolyl is 2-oxazolin-2-yl, 2-oxazolin-4-yl or 2-oxazolin-5-yl; isoxazolyl is 2-isoxazolin-3-yl, 2-isoxazolin-4-yl or 2-isoxazolin-5-yl; thiazolyl is 2-thiazolin-2-yl, 2-thiazolin-4-yl or 3-thiazolin-2-yl; imidazolidinon-yl is imidazolidin-2-on-1-yl; imidazolinon-yl is 2-imidazolinon-1-yl; and 3(2H)-pyridazinon-yl is 3(2H)-pyridazinon-2-yl, 3(2H)-pyridazinon-4-yl, 3(2H)-pyridazinon-5-yl or 3(2H)-pyridazinon-6-yl.

Preferred scope of Q is the following groups.

QI: phenyl, thienyl, furyl, pyrrolyl, oxazolyl, isoxazolyl, thiazolyl, isothiazolyl, pyrazolyl, imidazolyl, 1,3,4-oxadiazolyl, 1,2,4-oxadiazolyl, 1,3,4-thiadiazolyl, 1,2,4-thiadiazolyl, 1,2,4-triazolyl, 1,2,3-thiadiazolyl, 1,2,3-triazolyl, 1,2,3,4-tetrazolyl, pyridinyl, pyrimidinyl, pyrazinyl, pyridazinyl, 1,3,5-triazinyl, 1,2,4-triazinyl, 1,2,4,5-tetrazinyl.

QII: phenyl, thienyl, furyl, pyrrolyl, oxazolyl, isoxazolyl, thiazolyl, pyrazolyl, imidazolyl, 1,3,4-oxadiazolyl, 1,2,4-oxadiazolyl, 1,2,4-thiadiazolyl, , 1,2,4-triazolyl, 1,2,3-triazolyl, 1,2,3,4-tetrazolyl, pyridinyl, pyrimidinyl.

QIII: phenyl, thienyl, oxazolyl, thiazolyl, pyrazolyl, pyridinyl, pyrimidinyl, 1,2,3-triazolyl.

QIV: phenyl.

QV: oxazolyl.

QVI: thiazolyl.

QVII: pyrazolyl.

QVIII: pyrimidinyl.

QIX: 1,2,3-triazolyl.

Preferred scope of A is the following groups.

AI: phenyl, thienyl, furyl, pyrrolyl, oxazolyl, isoxazolyl, thiazolyl, isothiazolyl, pyrazolyl, imidazolyl, 1,3,4-oxadiazolyl, 1,2,4-oxadiazolyl, 1,3,4-thiadiazolyl, 1,2,4-thiadiazolyl, 1,2,4-triazolyl, 1,2,3-thiadiazolyl, 1,2,3-triazolyl, 1,2,3,4-tetrazolyl, pyridinyl, pyrimidinyl, pyrazinyl, pyridazinyl, 1,3,5-triazinyl, 1,2,4-triazinyl.

AII: phenyl, thienyl, furyl, pyrrolyl, oxazolyl, isoxazolyl, thiazolyl, pyrazolyl, imidazolyl, 1,2,3-triazolyl, 1,2,3-thiadiazolyl, pyridinyl, pyrimidinyl, pyrazinyl, pyridazinyl.

AIII: phenyl, thiazolyl, pyrazolyl, pyridinyl, pyrimidinyl.

AIV: thiazolyl, pyrazolyl, pyridinyl.

AV: thiazolyl.

AVI: pyrazolyl.

AVII: pyridinyl.

Preferred scope of B is the following groups.

BI: H, C₂-C₄ alkyl, C₁-C₄ haloalkyl, C₂-C₄ alkoxyalkyl, CH₃OC₂H₄OCH₂, C₁-C₄ alkylsulfonyl, phenylsulfonyl optionally substituted by halogen or C₁-C₄ alkyl, —SO₂CF₃, C₂-C₈ dialkylaminosulfonyl, C₃-C₉ dialkylaminothiocarbonyl, C₃-C₉ alkoxyalkylalkyl, —C(=O)T¹, —P(=O)T²T³, —P(=S)T²T³, alkali metal, alkaline earth metal or NHT⁴T⁵T⁶.

BII: H, C₁-C₄ alkyl, C₁-C₄ haloalkyl, C₂-C₄ alkoxyalkyl, CH₃OC₂H₄OCH₂, C₁-C₄ alkylsulfonyl, —SO₂CF₃, —C(=O)T¹, alkali metal, alkaline earth metal or NHT⁴T⁵T⁶.

BIII: H, C₂-C₄ alkoxyalkyl, C₁-C₄ alkylsulfonyl, —SO₂CF₃, —C(=O)T¹, alkali metal, alkaline earth metal, NHT⁴T⁵T⁶.

BIV: C₂-C₄ alkoxyalkyl, C₁-C₄ alkylsulfonyl, —SO₂CF₃, —C(=O)T¹, alkali metal, alkaline earth metal or NHT⁴T⁵T⁶.

Preferred scope of E is the following groups.

EI: halogen, C₂-C₄ alkynyl, phenylethynyl optionally substituted by Z, C₁-C₄ haloalkyl, CN, NO₂, N₃, CHO, C₂-C₅ alkylcarbonyl, C₂-C₅ alkoxyalkyl, C₂-C₄ alkylaminocarbonyl, C₃-C₉ dialkylaminocarbonyl, benzoyl optionally substituted by Z, aminothiocarbonyl, C₁-C₄ alkylsulfonyl, C₁-C₄ alkylsulfinyl, C₁-C₄ alkylsulfonyl, phenylsulfonyl optionally substituted by Z, phenylsulfinyl optionally substituted by Z, phenylsulfonyl optionally substituted by Z, —P(=O)T²T³, —P(=S)T²T³.

EII: halogen, C₂-C₄ alkynyl, phenylethynyl optionally substituted by Z, CN, C₂-C₅ alkylcarbonyl, C₂-C₅ alkoxyalkyl, C₂-C₄ alkylaminocarbonyl, C₃-C₉ dialkylaminocarbonyl, benzoyl optionally substituted by Z, aminothiocarbonyl, C₁-C₄ alkylsulfonyl, C₁-C₄ alkylsulfinyl, C₁-C₄ alkylsulfonyl, phenylsulfonyl optionally substituted by Z, phenylsulfinyl optionally substituted by Z or —P(=O)T²T³.

EIII: CN.

Preferred scope of G is the following groups.

GI: substituents freely selected from halogen, C₁-C₆ alkyl, C₂-C₄ alkenyl, C₂-C₄ alkynyl, C₁-C₄ haloalkyl, C₂-C₄ haloalkenyl, C₂-C₄ haloalkynyl, C₃-C₆ cycloalkyl optionally substituted by C₁-C₃ alkyl, C₁-C₆ alkoxy, C₂-C₄ alkenyloxy, C₂-C₄ alkynyloxy, C₁-C₄ haloalkoxy, C₂-C₄ haloalkenyloxy, C₃-C₄ haloalkynyloxy, C₁-C₄ alkylsulfonyl, C₁-C₄ alkylsulfinyl, C₁-C₄ alkylsulfonyl, C₂-C₄ alkenylsulfonyl, C₂-C₄ alkenylsulfinyl, C₂-C₄ alkenylsulfonyl, C₂-C₄ alkynylsulfonyl, C₂-C₄ alkynylsulfinyl, C₂-C₄ alkynylsulfonyl, C₁-C₄ haloalkylsulfonyl, C₂-C₄ haloalkylsulfinyl, C₁-C₄ haloalkylsulfonyl, C₂-C₄ haloalkenyloxy, C₂-C₄ haloalkenyloxy, C₂-C₄ haloalkynyloxy, C₂-C₄ haloalkynyloxy, C₂-C₄ haloalkynyloxy, NO₂, CN, —NU¹U², methoxy substituted by phenyl optionally substituted by halogen, or C₁-C₄ alkyl, C₂-C₆ alkoxyalkyl, C₂-C₄ alkoxyalkyl, C₂-C₄ alkylcarbonyl, C₂-C₄ haloalkylcarbonyl, C₂-C₄ alkylcarbonyloxy, C₂-C₆ haloalkylcarbonyloxy, C₃-C₇ dialkylaminocarbonyloxy, phenyl optionally substituted by Z, phenoxy optionally substituted by Z, benzoyl optionally substituted by Z, pyridyl optionally substituted by Z, and pyridyloxy optionally substituted by Z (provided that when the substituent is two or more, said substituents may be the same or different) and the number of the substituent G, is 1, 2, 3 or 4, or G is an alkylene group as bonded to the adjacent substituting positions to form a 5-, 6-, 7- or 8-membered ring.

GII: substituents freely selected from halogen, C₁-C₆ alkyl, C₂-C₄ alkenyl, C₂-C₄ alkynyl, C₁-C₄ haloalkyl, C₁-C₆ cycloalkyl optionally substituted by C₁-C₃ alkyl, C₁-C₆ alkoxy, C₂-C₄ alkenyloxy, C₂-C₄ alkynyloxy, C₁-C₄ haloalkoxy, C₂-C₄ haloalkenyloxy, C₁-C₄ alkylsulfonyl, C₁-C₄ alkylsulfinyl, C₁-C₄ alkylsulfonyl, C₂-C₄ alkenylsulfonyl, C₂-C₄ alkenylsulfinyl, C₂-C₄ alkenylsulfonyl, C₂-C₄ alkynylsulfonyl, C₂-C₄ alkynylsulfinyl, C₂-C₄ alkynylsulfonyl, C₁-C₄ haloalkylsulfonyl, C₁-C₄ haloalkylsulfinyl, C₁-C₄ haloalkylsulfonyl, C₂-C₄ haloalkenyloxy, C₂-C₄ haloalkenyloxy, methoxy substituted by phenyl optionally substituted by halogen or C₁-C₄ alkyl, C₂-C₆ alkoxyalkyl, C₂-C₅ alkylcarbonyloxy, C₂-C₅ haloalkylcarbonyloxy, phenoxy optionally substituted by Z, and pyridyloxy optionally sub-

stituted by Z (provided that the number of the substituent is two or more, said substituents may be the same or different), and the number of the substituent, G, is 1, 2 or 3.

GIII: substituents freely selected from halogen, C₁-C₆ alkyl, C₁-C₄ haloalkyl, C₃-C₆ cycloalkyl optionally substituted by C₁-C₃ alkyl, C₁-C₆ alkoxy, C₂-C₄ alkenyloxy, C₂-C₄ alkynyloxy, C₁-C₄ haloalkoxy, C₂-C₄ haloalkenyloxy, C₁-C₄ alkylsulfenyl, C₁-C₄ alkylsulfanyl, C₁-C₄ alkylsulfonyl, C₂-C₄ alkenylsulfenyl, C₂-C₄ alkenylsulfanyl, C₂-C₄ alkenylsulfonyl, C₂-C₄ alkynylsulfenyl, C₂-C₄ alkynylsulfanyl, C₂-C₄ alkynylsulfonyl, C₁-C₄ haloalkylsulfenyl, C₁-C₄ haloalkylsulfanyl, C₁-C₄ haloalkylsulfonyl, C₂-C₄ haloalkenylsulfenyl, C₂-C₄ haloalkenylsulfanyl, C₂-C₄ haloalkenylsulfonyl, methoxy substituted by phenyl optionally substituted by halogen or C₁-C₄ alkyl, C₂-C₆ alkoxy carbonyl, C₂-C₅ alkylcarbonyloxy, phenoxy optionally substituted by Z, and pyridyloxy optionally substituted by Z (provided that when the substituent is two or more, said substituents may be the same or different), and the number of the substituent, G is 1 or 2.

Preferred scope of R is the following group.

RI: substituents freely selected from halogen, C₁-C₆ alkyl, C₁-C₃ alkyl substituted by phenyl optionally substituted by halogen or C₁-C₄ alkyl, C₁-C₆ haloalkyl, C₃-C₆ cycloalkyl optionally substituted by C₁-C₃ alkyl, C₁-C₄ alkoxy, C₂-C₄ alkenyloxy, C₂-C₄ alkynyloxy, C₁-C₄ haloalkoxy, C₂-C₄ haloalkenyloxy, C₂-C₄ haloalkynyloxy, C₁-C₄ alkylsulfenyl, C₁-C₄ alkylsulfanyl, C₁-C₄ alkylsulfonyl, C₂-C₄ alkenylsulfenyl, C₂-C₄ alkenylsulfanyl, C₂-C₄ alkenylsulfonyl, C₂-C₄ alkynylsulfenyl, C₂-C₄ alkynylsulfanyl, C₂-C₄ alkynylsulfonyl, C₁-C₄ haloalkylsulfenyl, C₁-C₄ haloalkylsulfanyl, C₁-C₄ haloalkylsulfonyl, C₂-C₄ haloalkenylsulfenyl, C₂-C₄ haloalkenylsulfanyl, C₂-C₄ haloalkenylsulfonyl, NO₂, CN, —NU¹U², naphthyl, C₂-C₄ alkoxy carbonyl, C₂-C₄ alkoxyalkyl, phenyl optionally substituted by X, pyridyl optionally substituted by X, and thienyl optionally substituted by X (provided that when the substituent is two or more, said substituents may be the same or different), and the number of the substituent, R, is 1, 2 or 3, or R is an alkylene group as bonded to the adjacent substituting positions to form a 5-, 6-, 7- or 8-membered ring.

RII: substituents freely selected from halogen, C₁-C₆ alkyl, C₁-C₃ alkyl substituted by phenyl optionally substituted by halogen or C₁-C₄ alkyl, C₁-C₄ haloalkyl, C₃-C₆ cycloalkyl optionally substituted by C₁-C₃ alkyl, NO₂, CN, —NU¹U², naphthyl, C₂-C₄ alkoxy carbonyl, C₁-C₄ alkoxyalkyl, phenyl optionally substituted by X, and pyridyl optionally substituted by X (provided that when the substituents is two or more, said substituents may be the same or different), and the number of the substituents, R, is 1, 2 or 3.

RIII: substituents freely selected from halogen, C₁-C₆ alkyl, C₁-C₃ alkyl substituted by phenyl optionally substituted by halogen or C₁-C₄ alkyl, C₁-C₄ haloalkyl, C₃-C₆ cycloalkyl optionally substituted by C₁-C₃ alkyl, NO₂, CN, —NU¹U², naphthyl, C₂-C₄ alkoxy carbonyl, phenyl optionally substituted by X, and pyridyl optionally substituted by X (provided that when the substituent is two or more, said substituents may be the same or different), and the number of the substituent R, is 1 or 2.

Depending on the type of the heterocyclic group to be substituted by R, the number of R differs. For the group of 1,3,4-oxadiazolyl, 1,2,4-oxadiazolyl, 1,3,4-thiadiazolyl, 1,2,4-thiadiazolyl, 1,2,3-oxadiazolyl, 1,2,3-thiadiazolyl or 1,2,

3,4-tetrazolyl, the number of R is 0 or 1, preferably 1. For the group of thiazolyl, oxazolyl, isoxazolyl, isothiazolyl, 1,3,4-triazolyl, 1,2,4-triazolyl, 1,2,3-triazolyl, 1,3,5-triazinyl, 1,2,4-triazinyl or 1,2,4-triazinyl, the number of R is an integer of from 0 to 2, preferably 1 or 2. For the group of thienyl, furyl, pyrazolyl, imidazolyl, pyrimidinyl, pyrazinyl or pyridazinyl, the number of R is an integer of from 0 to 3, preferably an integer of from 0 to 2, member preferably 1 or 2. For the group of pyrrolyl, pyridinyl, pyrazolinyl, imidazolyl, oxazolyl, isoxazolyl or thiazolinyl, the number of R is an integer of from 0 to 4, preferably an integer of from 0 to 3, more preferably 1 or 2.

Preferred scope of Y is the following groups.

YI: substituents freely selected from halogen, C₁-C₆ alkyl, C₁-C₄ haloalkyl, C₁-C₄ alkoxy, C₂-C₄ alkenyloxy, C₂-C₄ alkynyloxy, C₁-C₄ haloalkoxy, C₂-C₄ haloalkenyloxy, C₂-C₄ haloalkynyloxy, C₁-C₄ alkylsulfenyl, C₁-C₄ alkylsulfanyl, C₁-C₄ alkylsulfonyl, C₂-C₄ alkenylsulfenyl, C₂-C₄ alkenylsulfanyl, C₂-C₄ alkenylsulfonyl, C₂-C₄ alkynylsulfenyl, C₂-C₄ alkynylsulfanyl, C₂-C₄ alkynylsulfonyl, C₁-C₄ haloalkylsulfenyl, C₁-C₄ haloalkylsulfanyl, C₁-C₄ haloalkylsulfonyl, C₂-C₄ haloalkenylsulfenyl, C₂-C₄ haloalkenylsulfanyl, C₂-C₄ haloalkenylsulfonyl, C₂-C₄ haloalkynyloxy, C₂-C₄ haloalkynyloxy, C₂-C₄ haloalkynyloxy, NO₂, CN, —NU¹U², C₂-C₄ alkoxy carbonyl, C₂-C₄ alkoxyalkyl, C₂-C₄ alkylcarbonyloxy, C₂-C₄ haloalkylcarbonyloxy, and phenyl optionally substituted by X (provided that the substituent is two or more, said substituents may be the same or different) and the number of the substituent, Y, is 1, 2 or 3.

YII: substituents freely selected from halogen, C₁-C₄ alkyl, C₁-C₄ haloalkyl, C₁-C₄ alkoxy, C₁-C₄ alkylsulfenyl, C₁-C₄ alkylsulfanyl, C₁-C₄ alkylsulfonyl, C₁-C₄ haloalkylsulfenyl, C₁-C₄ haloalkylsulfanyl, C₁-C₄ haloalkylsulfonyl, NO₂, CN, C₂-C₄ alkoxy carbonyl, and phenyl optionally substituted by X (provided that when the substituent is two or more, said substituents may be the same or different) and the number of the substituent, Y, is 1, 2 or 3.

Depending on the type of the heterocyclic group to be substituted by Y, the number of Y differs. For the group of 1,3,4-oxadiazolyl, 1,2,4-oxadiazolyl, 1,3,4-thiadiazolyl, 1,2,4-thiadiazolyl, 1,2,3-thiadiazolyl or 1,2,3,4-tetrazolyl, the number of Y is 0 or 1, preferably 1. For the group of thiazolyl, oxazolyl, isoxazolyl, isothiazolyl, 1,3,4-triazolyl, 1,2,4-triazolyl, 1,2,3-triazolyl, 1,3,5-triazinyl, 1,2,4-triazinyl or 1,2,4-triazinyl, the number of Y is an integer of from 0 to 2, preferably 1 or 2. For the group of thienyl, furyl, pyrazolyl, imidazolyl, pyrimidinyl, pyrazinyl or pyridazinyl, the number of Y is an integer of from 0 to 3, preferably an integer of from 0 to 2, more preferably 1 or 2. For the group of pyrrolyl, pyridinyl, pyrazolinyl, imidazolyl, oxazolyl, isoxazolyl or thiazolinyl, the number of Y is an integer of from 0 to 4, preferably an integer of from 0 to 3, more preferably 1 or 2.

Preferred scope of W is the following group.

WI: substituents freely selected from halogen, C₁-C₆ alkyl, C₁-C₄ haloalkyl, C₁-C₄ alkoxy, C₁-C₄ haloalkoxy, C₁-C₄ alkylsulfenyl, C₁-C₄ alkylsulfanyl, C₁-C₄ alkylsulfonyl, C₁-C₄ haloalkylsulfenyl, C₁-C₄ haloalkylsulfanyl, C₁-C₄ haloalkylsulfonyl, C₂-C₄ alkenyloxy, C₂-C₄ haloalkenyloxy, C₂-C₄ alkenylsulfenyl, C₂-C₄ alkenylsulfanyl, C₂-C₄ alkenylsulfonyl, C₂-C₄ haloalkenylsulfenyl, C₂-C₄ haloalkenylsulfanyl, C₂-C₄ haloalkenylsulfonyl, C₂-C₄ alkynyloxy, C₂-C₄ alkynylsulfenyl, C₂-C₄ alkynylsulfanyl, C₂-C₄

alkynylsulfonyl, NO₂, CN, C₂-C₄ alkoxy-carbonyl, C₂-C₄ alkylcarbonyl, C₂-C₄ haloalkylcarbonyl, C₂-C₄ alkylcarbonyloxy, and —NU¹U² (provided that when the substituent is two or more, said substituents are the same or different) and the number of the substituent, W is 1, 2, 3 or 4.

WII: substituents freely selected from halogen, C₁-C₄ alkyl, C₁-C₄ haloalkyl, C₁-C₄ alkoxy, C₁-C₄ haloalkoxy, C₁-C₄ alkylsulfonyl, C₁-C₄ alkylsulfinyl, C₁-C₄ alkylsulfonyl, C₁-C₄ haloalkylsulfonyl, C₁-C₄ haloalkylsulfinyl, C₁-C₄ haloalkylsulfonyl, C₂-C₄ alkenyloxy, C₂-C₄ haloalkenyloxy, C₂-C₄ alkenylsulfonyl, C₂-C₄ alkenylsulfinyl, C₁-C₄ alkenylsulfonyl, C₂-C₄ alkynyloxy, C₂-C₄ alkynylsulfonyl, C₂-C₄ alkynylsulfinyl, C₂-C₄ alkynylsulfonyl, NO₂, and CN (provided that the substituent is two or more, said substituents may be the same or different) and the number of the substituent, W, is 1, 2 or 3.

WIII: substituents freely selected from halogen, C₁-C₄ alkyl, C₁-C₄ haloalkyl, C₁-C₄ alkoxy, C₁-C₄ haloalkoxy, C₁-C₄ alkylsulfonyl, C₁-C₄ alkylsulfinyl, C₁-C₄ alkylsulfonyl, C₁-C₄ haloalkylsulfonyl, C₁-C₄ haloalkylsulfinyl, C₁-C₄ haloalkylsulfonyl, NO₂, and CN (provided that when the substituent is two or more, the substituents may be the same or different) and the number of the substituent, W, is 1 or 2.

Preferred scope of T¹ is the following groups.

T¹I: C₁-C₁₈ alkyl, C₂-C₆ alkenyl, C₁-C₄ haloalkyl, C₁-C₄ alkoxy-C₁-C₄ alkyl, C₁-C₄ alkyl substituted by phenyl optionally substituted by halogen or C₁-C₄ alkyl, C₃-C₆ halocycloalkyl, C₃-C₆ cycloalkyl optionally substituted by C₁-C₃ alkyl, cycloalkyl substituted by phenyl optionally substituted by halogen or C₁-C₄ alkyl, C₂-C₄ alkenyl substituted by phenyl optionally substituted by halogen or C₁-C₄ alkyl, C₁-C₁₀ alkoxy, C₁-C₄ haloalkoxy, C₂-C₆ alkenyloxy, C₃-C₆ cycloalkoxy optionally substituted by C₁-C₄ alkyl, benzyloxy, C₂-C₆ alkoxy-carbonyl, —NU¹U², phenyl optionally substituted by Z, phenoxy optionally substituted by Z, phenylthio optionally substituted by Z, naphthyl, and heterocyclic group optionally substituted by Z. (said heterocyclic group being selected from thienyl, furyl, pyrrolyl, oxazolyl, isoxazolyl, thiazolyl, pyrazolyl, imidazolyl, 1,3,4-oxadiazolyl, 1,2,4-oxadiazolyl, 1,3,4-thiadiazolyl, 1,2,4-thiadiazolyl, 1,2,4-triazolyl, 1,2,3-thiadiazolyl, 1,2,3-triazolyl, 1,2,3,4-tetrazolyl, pyridinyl, pyrimidinyl, pyrazinyl, pyridazinyl, 1,3,5-triazinyl, and 1,2,4-triazinyl groups).

T¹II: C₁-C₁ alkyl, C₂-C₆ alkenyl, C₁-C₄ haloalkyl, C₂-C₄ alkoxyalkyl, C₁-C₄ alkyl substituted by phenyl optionally substituted by halogen or C₁-C₄ alkyl, C₃-C₆ cycloalkyl optionally substituted by C₁-C₃ alkyl, cycloalkyl substituted by phenyl optionally substituted by halogen or C₁-C₄ alkyl, C₂-C₄ alkenyl substituted by phenyl optionally substituted by halogen or C₁-C₄ alkyl, C₁-C₁₀ alkoxy, C₁-C₄ haloalkoxy, C₂-C₅ alkenyloxy, C₃-C₆ cycloalkoxy, benzyloxy, C₂-C₅ alkoxy-carbonyl, phenyl optionally substituted by Z, phenoxy optionally substituted by Z, phenylthio, naphthyl, and heterocyclic group optionally substituted by Z (said heterocyclic group selected from thienyl, furyl, oxazolyl, thiazolyl, pyrazolyl and pyridinyl groups).

T¹III: C₁-C₁₇ alkyl, C₂-C₆ alkenyl, C₁-C₄ haloalkyl, C₁-C₄ alkoxyalkyl, C₁-C₄ alkyl substituted by phenyl, C₃-C₆ cycloalkyl optionally substituted C₁-C₃ alkyl, cycloalkyl substituted by phenyl, C₂-C₄ alkenyl substituted by phenyl, C₁-C₈ alkoxy, C₁-C₄ haloalkoxy, C₂-C₅ alkenyloxy, C₃-C₆ cycloalkoxy, benzyloxy, C₁-C₅ alkoxy-carbonyl, phenyl optionally substituted by Z, phe-

noxy optionally substituted by Z, phenylthio, naphthyl, pyrazolyl optionally substituted by Z or pyridinyl optionally substituted by Z.

Preferred scope of T² is the following groups.

T²I: phenyl, C₁-C₄ alkyl, C₁-C₄ alkoxy of C₁-C₄ alkyl-sulfonyl.

Preferred scope of T⁴ is the following groups.

T³I: phenyl, C₁-C₄ alkyl, C₃-C₆ alkoxy or C₁-C₄ alkyl-sulfonyl.

Preferred scope of T⁴ is the following groups.

T⁴I: H, C₁-C₄ alkyl, C₃-C₆ cycloalkyl or benzyl. Also preferred is such that any two of T⁴, T⁵ and T⁶, together with the nitrogen atom to which they are bonded, forms a 5-, 6- or 7-membered ring optionally having oxygen, nitrogen and/or sulfur atoms.

Preferred scope of T⁵ is the following groups.

T⁵I: H, C₁-C₄ alkyl, C₃-C₆ cycloalkyl or benzyl. Also, preferred is such that any two of T⁴, T⁵ and T⁶, together with the nitrogen atom to which they are bonded, forms a 5-, 6- or 7-membered ring optionally having oxygen, nitrogen and/or sulfur atoms.

Preferred scope of TO is the following groups.

T⁶I: H, C₁-C₄ alkyl, C₃-C₆ cycloalkyl or benzyl. Also, preferred is such that any two of T⁴, T⁵ and T⁶, together with the nitrogen atom to which they are bonded, forms a 5-, 6- or 7-membered ring optionally having oxygen, nitrogen and/or sulfur atoms.

Preferred scope of X is the following groups.

XI: substituents freely selected from halogen, C₁-C₄ alkyl, C₁-C₄ haloalkyl, C₁-C₄ alkoxy, C₁-C₄ haloalkoxy, C₁-C₄ alkylsulfonyl, C₁-C₄ alkylsulfinyl, C₁-C₄ alkylsulfonyl, C₂-C₅ alkenylsulfonyl, C₂-C₅ alkenylsulfinyl, C₂-C₅ alkenylsulfonyl, C₁-C₄ haloalkylsulfonyl, C₁-C₄ haloalkylsulfinyl, C₁-C₄ haloalkylsulfonyl, NO₂, CN, —NU¹U² and C₂-C₅ alkoxy-carbonyl (provided that the substituent is two or more, said substituents may be the same or different) and the substituent X is 1,2 or 3.

XII: substituents freely selected from halogen, C₁-C₄ alkyl, C₁-C₄ haloalkyl, C₁-C₄ alkoxy, C₁-C₄ haloalkoxy, C₁-C₄ alkylsulfonyl, C₁-C₄ alkylsulfinyl, C₁-C₄ alkylsulfonyl, C₂-C₅ alkenylsulfonyl, C₁-C₄ haloalkylsulfonyl, C₁-C₄ haloalkylsulfinyl, C₁-C₄ haloalkylsulfonyl, and NO₂ (provided that when the substituent is two or more, said substituents may be the same or different) and the number of the substituent X, is 1, 2 or 3.

XIII: substituents freely selected from halogen, C₁-C₄ alkyl, C₁-C₄ haloalkyl, and C₁-C₄ alkoxy (provided that when the substituent is two is more, said substituents may be the same or different) and the number of the substituent, X, is 1 or 2.

Depending on the type of the ring to be substituted by X, the number of X differs. For phenyl, the number of X is an integer of from 0 to 5, preferably an integer of from 0 to 3, more preferably an integer of from 0 to 2. For pyridyl, the number of X is an integer of from 0 to 4, preferably 0, 1 or 2, more preferably 0 or 1. For thienyl, the number of X is an integer of from 0 to 3, preferably 0 or 1.

Preferred scope of Z is the following groups.

ZI: substituents freely selected from halogen, C₁-C₄ alkyl, C₁-C₄ haloalkyl, C₁-C₄ alkoxy, C₁-C₄ haloalkoxy, C₁-C₄ alkylsulfonyl, C₁-C₄ alkylsulfinyl, C₁-C₄ alkylsulfonyl, C₂-C₅ alkenylsulfonyl, C₂-C₆ alkenylsulfinyl, C₂-C₅ alkenylsulfonyl, C₁-C₄ haloalkylsulfonyl, C₁-C₄ haloalkylsulfinyl, C₁-C₄ haloalkylsulfonyl, NO₂, CN, —NU¹U² and C₂-C₅ alkoxy-carbonyl (provided that when the substituent is two or more,

said substituents may be the same or different) and the number of the substituent, Z, is 1, 2, 3, or 4.

ZII: substituents freely selected from halogen, C₁-C₄ alkyl, C₁-C₄ haloalkyl, C₁-C₄ alkoxy, C₁-C₄ haloalkoxy, C₁-C₄ alkylsulfenyl, C₁-C₄ alkylsulfinyl, C₁-C₄ alkylsulfonyl, C₂-C₅ alkenylsulfenyl, C₂-C₅ alkenylsulfinyl, C₂-C₅ alkenylsulfonyl, C₁-C₄ haloalkylsulfenyl, C₁-C₄ haloalkylsulfinyl and C₁-C₄ haloalkylsulfonyl (provided that when the substituent is two or more, said substituents may be the same or different) and the substituent Z, is 1, 2, 3, or 4.

Depending on the type of the ring to be substituted by Z, the number of Z differs. For phenyl, the number of Z is an integer of from 0 to 5, preferably an integer of from 0 to 4, more preferably 0, 1, 2 or 3, even more preferably 0, 1 or 2. For naphthyl, the number of Z is an integer of from 0 to 7, preferably 0. Where the ring to be substituted by Z is a heterocyclic group, the number of the substituents of Z also differs depending on the type of the heterocyclic group. For the group of 1,3,4-oxadiazolyl, 1,2,4-oxadiazolyl, 1,3,4-thiadiazolyl, 1,2,4-thiadiazolyl, 1,2,3-oxadiazolyl, 1,2,3-thiadiazolyl, 1,2,3,4-tetrazolyl or 1,2,3,5-tetrazolyl, the number of Z is 0 or 1. For the group of thiazolyl, oxazolyl, isoxazolyl, isothiazolyl, 1,3,4-triazolyl, 1,2,4-triazolyl, 1,2,3-triazolyl, 1,3,5-triazinyl, 1,2,4-triazinyl or 1,2,4-triazinyl, the number of Z is an integer of from 0 to 2, preferably 1 or 2. For the group of thienyl, furyl, pyrazolyl, imidazolyl, pyrimidinyl, pyrazinyl or pyridazinyl, the number of Z is an integer of from 0 to 3, preferably an integer of from 0 to 2, more preferably 1 or 2. For the group of pyrrolyl, pyridinyl, pyrazolinyl, imidazolynyl, oxazolynyl, isoxazolynyl or thiazolynyl, the number of Z is an integer of from 0 to 4, preferably an integer of from 0 to 2, more preferably 1 or 2.

Preferred scope of T⁷ is the following groups.

T⁷I: H, phenyl, benzyl or C₁-C₄ alkyl. Also preferred is such that T⁷ and T⁸, together with the carbon atom to which they are bonded, form a 5-membered or 6-membered ring.

Preferred scope of T⁸ is the following groups.

T⁸I: phenyl, benzyl or C₁-C₄ alkyl. Also preferred is such that T⁷ and T⁸, together with the carbon atom to which they are bonded, form a 5-membered or 6-membered ring.

Preferred scope of U¹ is the following groups.

U¹I: H, C₁-C₄ alkyl or C₂-C₅ alkylcarbonyl. Also preferred is such that U¹ and U², together with nitrogen atom to which they are bonded, form a 5-, 6- or 7-membered ring.

Preferred scope of U² is the following groups.

U²I: H, C₁-C₄ alkyl or C₂-C₅ alkylcarbonyl. Also preferred is such that U¹ and U², together with the carbon atom to which they are bonded, form a 5-, 6- or 7-membered ring.

Preferably, m is 1, 2, or 3, more preferably 1 or 2.

Preferably n is 0, 1, 2 or 3, more preferably 1 or 2.

Preferably, p is 1 or 2.

The above-mentioned preferred groups in the scopes of the preferred substituents can be optionally combined and show the scopes of the preferred compounds of the present invention. Hereinunder mentioned are especially preferred scopes.

Compounds of the invention comprising preferred substituents of QI, AI, BI, EI, GI, RI, YI, WI, T¹I, T²I, T³I, T⁴I, T⁵I, T⁶I, XI, ZI, T⁷I, T⁸I, U¹I and U²I.

Compounds of the invention comprising preferred substituents of QI, AI, BI, EIII, GI, RI, YI, WI, T¹I, T²I, T³I, T⁴I, T⁵I, T⁶I, XI, ZI, T⁷I, T⁸I, U¹I and U²I.

Compounds of the invention comprising preferred substituents of QII, AII, BI, EII, GI, RI, YI, WI, T¹I, T²I, T³I, T⁴I, T⁵I, T⁶I, XI, ZI, T⁷I, T⁸I, U¹I and U²I.

Compounds of the invention comprising preferred substituents of QII, AII, BI, EIII, GI, RI, YI, WI, T¹I, T²I, T³I, T⁴I, T⁵I, T⁶I, XI, ZI, T⁷I, T⁸I, U¹I and U²I.

Compounds of the invention comprising preferred substituents of QIII, AIII, BI, EIII, GI, RI, YI, WI, T¹I, T²I, T³I, T⁴I, T⁵I, T⁶I, XI, ZI, T⁷I, T⁸I, U¹I and U²I.

Compounds of the invention comprising preferred substituents of QIII, AIII, BII, EIII, GII, RII, YII, WII, T¹II, T²I, T³I, T⁴I, T⁵I, T⁶I, XII, ZII, T⁷I, T⁸I, U¹I and U²I.

Compounds of the invention comprising preferred substituents of QIII, AIII, BII, EIII, GIII, RIII, YII, WII, T¹III, T²I, T³I, T⁴I, T⁵I, T⁶I, XIII, ZII, T⁷I, T⁸I, U¹I and U²I.

Compounds of the invention comprising preferred substituents of QIII, AIV, BIII, EIII, GIII, RIII, YII, WII, T¹III, T²I, T³I, T⁴I, T⁵I, T⁶I, XIII, ZII, T⁷I, T⁸I, U¹I and U²I.

Compounds of the invention comprising preferred substituents of QIV, AIV, BIII, EIII, GIII, RIII, YII, WII, T¹III, T²I, T³I, T⁴I, T⁵I, T⁶I, XIII, ZII, T⁷I, T⁸I, U¹I and U²I.

Compounds of the invention comprising preferred substituents of QV, AIII, BIII, EIII, GIII, RIII, YII, WII, T¹III, T²I, T³I, T⁴I, T⁵I, T⁶I, XIII, ZII, T⁷I, T⁸I, U¹I and U²I.

Compounds of the invention comprising preferred substituents of QVI, AIII, BIII, EIII, GIII, RIII, YII, WII, T¹III, T²I, T³I, T⁴I, T⁵I, T⁶I, XIII, ZII, T⁷I, T⁸I, U¹I and U²I.

Compounds of the invention comprising preferred substituents of QVI, AIV, BIII, EIII, GIII, RIII, YII, WII, T¹III, T²I, T³I, T⁴I, T⁵I, T⁶I, XIII, ZII, T⁷I, T⁸I, U¹I and U²I.

Compounds of the invention comprising preferred substituents of QVII, AIII, BIII, EIII, GIII, RIII, YII, WII, T¹III, T²I, T³I, T⁴I, T⁵I, T⁶I, XIII, ZII, T⁷I, T⁸I, U¹I and U²I.

Compounds of the invention comprising preferred substituents of QVIII, AIII, BIII, EIII, GIII, RIII, YII, WII, T¹III, T²I, T³I, T⁴I, T⁵I, T⁶I, XIII, ZII, T⁷I, T⁸I, U¹I and U²I.

Compounds of the invention comprising preferred substituents of QIX, AIII, BIII, EIII, GIII, RIII, YII, WII, T¹III, T²I, T³I, T⁴I, T⁵I, T⁶I, XIII, ZII, T⁷I, T⁸I, U¹I and U²I.

Compounds of the invention comprising preferred substituents of QIII, AVI, BIII, EIII, GIII, RIII, YII, WII, T¹III, T²I, T³I, T⁴I, T⁵I, T⁶I, XIII, ZII, T⁷I, T⁸I, U¹I and U²I.

Compounds of the invention comprising preferred substituents of QIII, AVI, BIII, EIII, GIII, RIII, YII, WII, T¹III, T²I, T³I, T⁴I, T⁵I, XIII, ZII, T⁷I, T⁸I, U¹I and U²I.

Compounds of the invention comprising preferred substituents of QIII, AVII, BIII, EIII, GIII, RIII, YII, WII, T¹III, T²I, T³I, T⁴I, T⁵I, T⁶I, XIII, ZII, T⁷I, T⁸I, U¹I and U²I.

Now specific examples of Q, A, B, E, G, R, R¹, Y, Y¹, Y², W, X, Z, T¹, T², T³, T⁴, T⁵, T⁶, T⁷, T⁸, U¹ and U² are mentioned below.

The halogen atom for E, G, R, R¹, W, X, Y, Y¹, Y², Y³ and Z includes a fluorine atom, a chlorine atom, a bromine atom, and an iodine atom. Preferred are a fluorine atom, a chlorine atom and a bromine atom.

The alkyl group for B, G, R, R¹, T¹, T², T³, T⁴, T⁵, T⁶, T⁷, T⁸, U¹, U², W, X, Y, Y¹, Y², Y³ and Z may be a straight chain or branched alkyl group having indicated carbon atoms, which includes, for example, methyl, ethyl, n-propyl, isopropyl, n-butyl, isobutyl, tert-butyl, sec-butyl, pentyl-1, pentyl-2, pentyl-3, 2-methylbutyl-1, 2-methylbutyl-2, 2-methylbutyl-3, 3-methylbutyl-1, 2,2-dimethylpropyl-1, hexyl-1, hexyl-2, hexyl-3, 1-methylpentyl, 2-methylpentyl, 3-methylpentyl, 4-methylpentyl, 1,1-dimethylbutyl, 1,2-dimethylbutyl, 1,3-dimethylbutyl, 2,2-dimethylbutyl, 2,3-dimethylbutyl, 3,3-dimethylbutyl, 1-ethylbutyl, 2-ethylbutyl, 1,1,2-trimethylpropyl, 1,2,2-trimethylpropyl, 1-ethyl-1-methylpropyl, 1-ethyl-2-methylpropyl, n-heptyl, n-octyl, n-nonyl, n-undecyl, n-dodecyl, n-tridecyl, n-tetradecyl, n-pentadecyl, n-hexadecyl, n-heptadecyl, n-octadecyl, n-nonadecyl and n-eicosyl groups.

The alkenyl group for G, R, R¹, T¹, T⁴, T⁵, T⁶, Y¹ and W may be a straight chain or branched alkenyl group having

indicated carbon atoms, which includes, for example, ethenyl, 1-propenyl, 2-propenyl, 1-butenyl, 2-butenyl, 3-butenyl, 1-methyl-2-propenyl, 2-methyl-2-propenyl, 1-pentenyl, 2-pentenyl, 3-pentenyl, 4-pentenyl, 1-methyl-2-butenyl, 2-methyl-2-butenyl, 3-methyl-2-butenyl, 1-methyl-3-butenyl, 2-methyl-3-butenyl, 3-methyl-3-butenyl, 1,1-dimethyl-2-propenyl, 1,2-dimethyl-2-propenyl, 1-ethyl-2-propenyl, 1-hexenyl, 2-hexenyl, 3-hexenyl, 4-hexenyl, 5-hexenyl, 1-methyl-2-pentenyl, 2-methyl-2-pentenyl, 3-methyl-2-pentenyl, 4-methyl-2-pentenyl, 1-methyl-3-pentenyl, 2-methyl-3-pentenyl, 3-methyl-3-pentenyl, 4-methyl-3-pentenyl, 1-methyl-4-pentenyl, 2-methyl-4-pentenyl, 3-methyl-4-pentenyl, 4-methyl-4-pentenyl, 1,1-dimethyl-2-butenyl, 1,1-dimethyl-3-butenyl, 1,2-dimethyl-2-butenyl, 1,2-dimethyl-3-butenyl, 1,3-dimethyl-2-butenyl, 1,3-dimethyl-3-butenyl, 2,3-dimethyl-2-butenyl, 2,3-dimethyl-3-butenyl, 3,3-dimethyl-2-butenyl, 1-ethyl-2-butenyl, 1-ethyl-3-butenyl, 2-ethyl-2-butenyl, 2-ethyl-3-butenyl, 1,1,2-trimethyl-2-propenyl and 1-ethyl-1-methyl-2-propenyl groups.

The alkynyl group for E, G, R, R¹, Y¹ and W may be a straight chain or branched alkynyl group having indicated carbon atoms, which includes, for example, ethynyl, 1-propynyl, 2-propynyl, 1-butylnyl, 2-butylnyl, 3-butylnyl, 1-methyl-2-propynyl, 1-pentylnyl, 2-pentylnyl, 3-pentylnyl, 4-pentylnyl, 1-methyl-2-butylnyl, 1-methyl-3-butylnyl, 2-methyl-3-butylnyl, hexynyl, 1-methyl-3-pentylnyl, 1-methyl-4-pentylnyl, 2-methyl-3-pentylnyl, 2-methyl-4-pentylnyl, 3-methyl-4-pentylnyl, 4-methyl-2-pentylnyl, 1,1-dimethyl-2-butylnyl, 1,1-dimethyl-3-butylnyl, 1,2-dimethyl-3-butylnyl, 2,2-dimethyl-3-butylnyl, 1-ethyl-2-butylnyl, 1-ethyl-3-butylnyl and 2-ethyl-3-butylnyl groups.

The haloalkyl group for B, E, G, R, R¹, T¹, W, X, Y, Y¹, Y², Y³ and Z may be a straight chain or branched haloalkyl group having indicated carbon atoms, which includes, for example, fluoromethyl, chloromethyl, bromomethyl, fluoroethyl, chloroethyl, bromoethyl, fluoro-n-propyl, chloro-n-propyl, difluoromethyl, chlorodifluoromethyl, trifluoromethyl, dichloromethyl, trichloromethyl, difluoroethyl, trifluoroethyl, trichloroethyl, chlorodifluoromethyl, bromodifluoromethyl, trifluoroethyl, hexafluoro-n-propyl, chlorobutyl, fluorobutyl, chloro-n-pentyl, fluoro-n-pentyl, chloro-n-hexyl and fluoro-n-hexyl groups.

The C₃-C₆ cycloalkyl group optionally substituted by a C₁-C₃ alkyl group for G, R, T¹, T⁴, T⁵ and T⁶ includes, for example, cyclopropyl, 1-methylcyclopropyl, 2,2,3,3-tetramethylcyclopropyl, cyclobutyl, 1-ethylcyclobutyl, 1-n-butylcyclobutyl, cyclopentyl, 1-methylcyclopentyl, cyclohexyl, 1-methylcyclohexyl and 4-methylcyclohexyl groups.

The C₁-C₄ alkyl group substituted by a phenyl group optionally substituted by a halogen atom or a C₁-C₄ alkyl group for B, G, R and T¹ includes, for example, benzyl, 2-chlorobenzyl, 3-bromobenzyl, 4-chlorobenzyl, 4-methylbenzyl, 4-tert-butylbenzyl, 1-phenylethyl, 1-(3-chlorophenyl)ethyl, 2-phenylethyl, 1-methyl-1-phenylethyl, 1-(4-chlorophenyl)-1-methylethyl, 1-(3-chlorophenyl)-1-methylethyl, 1-phenylpropyl, 2-phenylpropyl, 3-phenylpropyl, 1-phenylpropyl, 2-phenylbutyl, 3-phenylbutyl, 4-phenylbutyl, 1-methyl-1-phenylpropyl, 1-methyl-2-phenylpropyl, 1-methyl-3-phenylpropyl, 2-methyl-2-phenylpropyl, 2-(4-chlorophenyl)-2-methylpropyl and 2-methyl-2-(3-methylphenyl)propyl groups.

For T¹, the C₃-C₆ cycloalkyl group substituted by a phenyl group optionally substituted by a halogen atom or a

C₁-C₄ alkyl group includes, for example, 1-phenylcyclopropyl, 1-(3-chlorophenyl)cyclopropyl, 1-(4-chlorophenyl)cyclopropyl, 1-(4-bromophenyl)cyclopropyl, 1-(4-fluorophenyl)cyclopropyl, 1-(4-ethylphenyl)cyclopropyl, 1-(4-propylphenyl)cyclopropyl, 2-phenylcyclopropyl, 1-phenylcyclobutyl, 2-phenylcyclobutyl, 1-phenylcyclopentyl, 1-(4-chlorophenyl)cyclopentyl, 2-phenylcyclopentyl, 3-phenylcyclopentyl, 1-phenylcyclohexyl, 1-(3-fluorophenyl)cyclohexyl, 1-(4-chlorophenyl)cyclohexyl, 1-(4-tert-butylphenyl)cyclohexyl, 2-phenylcyclohexyl, 3-phenylcyclohexyl and 4-phenylcyclohexyl groups.

For T¹, the cyclopropyl group substituted by both a phenyl group optionally substituted by a halogen atom or a C₁-C₄ alkyl group and a C₁-C₄ alkyl group includes, for example, 2,2-dimethyl-1-phenylcyclopropyl, 1-(4-chlorophenyl)-2,2-dimethylcyclopropyl, 2,2-dimethyl-3-phenylcyclopropyl, 3-(3-chlorophenyl)-2,2-dimethylcyclopropyl, (4-chlorophenyl)-2,2-dimethyl-3-phenylcyclopropyl, (4-bromophenyl)-2,2-dimethyl-3-phenylcyclopropyl, 2,2-dimethyl-3-(4-methylphenyl)cyclopropyl and (4-tert-butylphenyl)-2,2-dimethyl-3-phenylcyclopropyl groups.

For T¹, the C₃-C₄ cycloalkyl group substituted by both a phenyl group optionally substituted by a halogen atom or a C₁-C₄ alkoxy group and a halogen atom includes, for example, 2,2-dichloro-1-phenylcyclopropyl, 2,2-dichloro-1-(3-chlorophenyl)cyclopropyl, 2,2-dichloro-1-(4-methoxyphenyl)cyclopropyl, 2,2-dichloro-1-(4-ethoxyphenyl)cyclopropyl, 2,2-dichloro-(4-isopropoxyphenyl)cyclopropyl, 2,2-dichloro-(4-tert-butylphenyl)cyclopropyl, 2,2-dichloro-1-(4-methoxyphenyl)-3-phenylcyclopropyl and 1-(4-ethoxyphenyl)-2,2,3,3-tetrafluorobutyl groups.

For T¹, the cyclopropyl group substituted by both a C₂-C₄ alkenyl group optionally substituted by a halogen atom, and a C₁-C₄ alkyl group includes, for example, 2,2-dimethyl-3-(2,2-dimethylethenyl)cyclopropyl, 3-(2,2-dibromoethenyl)-2,2-dimethylcyclopropyl, 3-(2,2-dichloroethenyl)-2,2-dimethylcyclopropyl and 3-(2,2-chlorotrifluoroethenyl)-2,2-dimethylcyclopropyl groups.

For T¹, the C₃-C₆ cycloalkoxy group optionally substituted by a C₁-C₃ alkyl group includes, for example, cyclopropoxy, cyclobutoxy, cyclopentoxy, cyclohexyloxy and 1-methylcyclopropoxy groups.

For T¹, the C₂-C₄ alkenyl group substituted by a phenyl group optionally substituted by a halogen atom or a C₁-C₄ alkyl group includes, for example, 1-phenylethenyl, 2-phenylethenyl, 2-(2-chlorophenyl)ethenyl, 2-(3-chlorophenyl)ethenyl, 2-(4-chlorophenyl)ethenyl, 2-(4-methylphenyl)ethenyl, 2-(2,6-difluorophenyl)ethenyl, 2-(2,5-dimethylphenyl)ethenyl, 1-methyl-2-phenylethenyl, 2-phenyl-1-propenyl, 2-(4-bromophenyl)-1-propenyl and 2-(2,4,6-trimethylphenyl)-1-propenyl groups.

The alkoxy group for G, R, T¹, T², T³, R¹, W, X, Y, Y¹, Y² and Z may be straight chain or branched alkoxy group having indicated carbon atoms, which includes, for example, methoxy, ethoxy, n-propoxy, isopropoxy, n-butoxy, isobutoxy, sec-butoxy, tert-butoxy, n-pentyloxy, 1-methylbutyloxy, 2-methylbutyloxy, 3-methylbutyloxy, 1,1-dimethylpropoxy, 1,2-dimethylpropoxy, 2,2-dimethylpropoxy, 1-ethylpropyloxy, n-hexyloxy, 1-methylpentyloxy, 2-methylpentyloxy, 3-methylpentyloxy, 4-methylpentyloxy, 1,1-dimethylbutyloxy, 1,2-dimethylbutyloxy, 1,3-dimethylbutyloxy, 2,2-dimethylbutyloxy, 2,3-dimethylbutyloxy, 3,3-dimethylbutyloxy, 1-ethylbutyloxy, 2-ethylbutyloxy, 1,1,2-

trimethylpropyloxy, 1,2,2-trimethylpropyloxy, 1-ethyl-1-methylpropyloxy, 1-ethyl-2-methylpropyloxy, n-heptyloxy, n-octyloxy, n-nonyloxy and n-decyloxy groups.

The C₃-C₆ halocycloalkyl group for G, R and T¹ includes, for example, fluorocyclopropyl, difluorocyclopropyl, chlorocyclopropyl, dichlorocyclopropyl, 1-methyl-2,2-dichlorocyclopropyl, chlorocyclobutyl, dichlorocyclobutyl, chlorocyclopentyl, dichlorocyclopentyl, chlorocyclohexyl, dichlorocyclohexyl and tetrafluorocyclobutyl groups.

The group —NU¹U² for G, R, R¹, T¹, W, X, Y, Y¹ and Z includes, for example, methylamino, ethylamino, n-propylamino, isopropylamino, n-butylamino, isobutylamino, sec-butylamino, tert-butylamino, n-pentylamino, 1-methylbutylamino, 2-methylbutylamino, 3-methylbutylamino, 1,1-dimethylpropylamino, 1,2-dimethylpropylamino, 2,2-dimethylpropylamino, 1-ethylpropylamino, n-hexylamino, 1-methylpentylamino, 2-methylpentylamino, 3-methylpentylamino, 4-methylpentylamino, 1,1-dimethylbutylamino, 1,2-dimethylbutylamino, -1,3-dimethylbutylamino, 2,2-dimethylbutylamino, 2,3-dimethylbutylamino, 3,3-dimethylbutylamino, 1-ethylbutylamino, 2-ethylbutylamino, 1,1,2-trimethylpropylamino, 1,2,2-trimethylpropylamino, 1-ethyl-1-methylpropylamino, 1-ethyl-2-methylpropylamino, dimethylamino, diethylamino, di-n-propylamino, diisopropylamino, di-n-butylamino, di-sec-butylamino, diisobutylamino, di-n-pentylamino, di-n-hexylamino, methylethylamino, methylpropylamino, methylisopropylamino, methylbutylamino, methyl-sec-butylamino, methylisobutylamino, methyl-tert-butylamino, methylpentylamino, methylhexylamino, ethylpropylamino, ethylisopropylamino, ethylbutylamino, ethyl-sec-butylamino, ethyl-isobutylamino, ethylpentylamino, ethylhexylamino, phenylamino, benzylamino, N-merthylacetamido, N-ethylacetamido, N-phenylacetamido and N-acerylacetamido groups, to which is applied the indicated scope of the carbon atoms constituting it.

The C₂-C₅ alkoxy-carbonyl group for E, G, R, R¹T¹, W, X, Y, Y¹, Y² and Z includes, for example, methoxycarbonyl, ethoxycarbonyl, n-propoxycarbonyl, iso-propoxycarbonyl, n-butoxycarbonyl, sec-butoxycarbonyl, iso-butoxycarbonyl and tart-butoxycarbonyl groups.

The C₁-C₄ haloalkoxy group for G, R, T¹, W, X, Y and Z may be a straight chain or branched C₁-C₄ haloalkoxy group, including, for example, fluoromethoxy, difluoromethoxy, trifluoromethoxy, chlorodifluoromethoxy, bromodifluoromethoxy, dichlorofluoromethoxy, chloromethoxy, dichloromethoxy, trichloromethoxy, bromomethoxy, fluoromethoxy, chloromethoxy, bromomethoxy, difluoroethoxy, trifluoroethoxy, tetrafluoroethoxy, pentafluoroethoxy, trichloroethoxy, trifluorochloroethoxy, fluoropropoxy, chloropropoxy, bromopropoxy, fluorobutoxy, chlorobutoxy, fluoro-iso-propoxy and chloro-iso-propoxy groups.

The C₁-C₄ alkylsulfenyl group for E, G, R, T², T³, W, X, Y and Z includes, for example, methylthio, ethylthio, n-propylthio, iso-propylthio, n-butylthio, iso-butylthio, sec-butylthio and tert-butylthio groups.

The C₁-C₄ alkylsulfinyl group for E, G, R, X, W, Y and Z includes, for example, methylsulfinyl, ethylsulfinyl, n-propylsulfinyl, iso-propylsulfinyl, n-butylsulfinyl, iso-butylsulfinyl, sec-butylsulfinyl and tart-butylsulfinyl groups.

The C₁-C₄ alkylsulfonyl group for B, E, G, R, W, X, Y and Z includes, for example, methylsulfonyl, ethylsulfonyl, n-propylsulfonyl, iso-propylsulfonyl, n-butylsulfonyl, iso-butylsulfonyl, sec-butylsulfonyl and tart-butylsulfonyl groups.

The C₂-C₄ alkoxyalkyl group for B, G, R, R¹, T¹, Y, Y¹ and Y² includes, for example, C₁-C₃ alkoxy-methyl, C₁-C₂ alkoxy-ethyl, methoxyethoxymethyl and methoxypropyl groups.

The C₂-C₄ alkylcarbonyl group for E, G, R, R¹, U¹, U², Y¹, Y² and W includes, for example, acetyl, propionyl, butanoyl and iso-butanoyl groups.

The C₂-C₆ haloalkylcarbonyl group for G and W includes, for example, chloroacetyl, trifluoroacetyl, 3,3,3-trifluoropropionyl and pentafluoropropionyl groups.

The C₂-C₅ haloalkylcarbonyloxy group for G, R and Y includes, for example, chloroacetyloxy, trifluoroacetyloxy, 3,3,3-trifluoropropionyloxy and pentafluoropropionyloxy groups.

The C₃-C₇ dialkylaminocarbonyloxy group for G and Y includes, for example, dimethylaminocarbonyloxy, diethylaminocarbonyloxy and di-i-propylaminocarbonyloxy groups.

The naphthyl group for R, Y, Z and T¹ includes, for example, 1-naphthyl and 2-naphthyl groups.

The pyridyl group optionally substituted by Z for G and T¹ includes, for example, 2-pyridyl, 3-pyridyl and 4-pyridyl groups all optionally substituted by Z. Preferred are 2-pyridyl and 3-pyridyl groups both optionally substituted by Z; and more preferred is a 2-pyridyl group optionally substituted by Z.

The pyridyloxy group optionally substituted by Z for G and T¹ includes, for example, 2-pyridyloxy, 3-pyridyloxy and 4-pyridyloxy groups all optionally substituted by Z.

The pyridyl group optionally substituted by X for R and R¹ includes, for example, 2-pyridyl, 3-pyridyl and 4-pyridyl groups all optionally substituted by X. Preferred are 2-pyridyl and 3-pyridyl groups both optionally substituted by X; and more preferred is a 2-pyridyl group optionally substituted by X.

The pyridyloxy group optionally substituted by X for N and R¹ includes, for example, 2-pyridyloxy, 3-pyridyloxy and 4-pyridyloxy groups all optionally substituted by X.

The thienyl group optionally substituted by X for R and R¹ includes, for example, 2-thienyl and 3-thienyl groups both optionally substituted by X.

The thienyl group optionally substituted by Z for G and Y¹ includes, for example, 2-thienyl and 3-thienyl groups both optionally substituted by Z.

The group —N=CT⁷T⁸ for G, R, R¹, Y and Y¹ indicates an alkylidenamino group, a benzylidenamino group, an arylidenamino group or a cycloalkylidenamino group, including, for example, methylidenamino, ethylidenamino, propylidenamino, isopropylidenamino, 4-methyl-2-pentylidenamino, cyclopentylidenamino and cyclohexylidenamino groups.

The C₂-C₄ alkylaminocarbonyl group for E includes, for example, methylaminocarbonyl, ethylaminocarbonyl and n-propylaminocarbonyl groups.

The C₃-C₉ dialkylaminocarbonyl group for E includes, for example, dimethylaminocarbonyl, diethylaminocarbonyl, di-n-propylaminocarbonyl, di-isopropylaminocarbonyl and di-n-butylaminocarbonyl groups.

The C₁-C₄ alkylaminosulfonyl group for B includes, for example, methylaminosulfonyl, ethylaminosulfonyl, n-propylaminosulfonyl, iso-propylaminosulfonyl and n-butylaminosulfonyl groups.

The C₂-C₈ dialkylaminosulfonyl group for B includes, for example, dimethylaminosulfonyl, diethylaminosulfonyl, di-n-propylaminosulfonyl, di-isopropylaminosulfonyl and di-n-butylaminosulfonyl groups.

The C₂-C₅ alkylaminothiocarbonyl group for B includes, for example, methylaminothiocarbonyl, ethylaminothiocarbonyl, n-propylaminothiocarbonyl, isopropylaminothiocarbonyl and n-butylaminothiocarbonyl groups.

The C₃-C₉ dialkylaminothiocarbonyl group for B includes, for example, dimethylaminothiocarbonyl, diethylaminothiocarbonyl, di-n-propylaminothiocarbonyl, di-isopropylaminothiocarbonyl and di-n-butylaminothiocarbonyl groups.

The C₁-C₄ alkyl group substituted by a benzoyl group optionally substituted by a halogen atom or a C₁-C₄ alkyl group for B includes, for example, phenacyl, 2-fluorophenacyl, 3-chlorophenacyl, 4-bromophenacyl, 2-methylphenacyl, 3-ethylphenacyl, 4-i-propylphenacyl and 4-t-butylphenacyl groups.

The phenylsulfonyl group optionally substituted by a halogen atom or a C₁-C₄ alkyl group for B includes, for example, 2-fluorophenylsulfonyl, 4-fluorophenylsulfonyl, 2-chlorophenylsulfonyl, 4-chlorophenylsulfonyl, 4-bromophenylsulfonyl, 2,5-dichlorophenylsulfonyl, pentafluorophenylsulfonyl, 4-methylphenylsulfonyl, 2-methylphenylsulfonyl, 4-t-butylphenylsulfonyl, 2,5-dimethylphenylsulfonyl, 2,4-dimethylphenylsulfonyl, 2,4,6-trimethylphenylsulfonyl and 2,4,6-tri-i-propylphenylsulfonyl groups.

The C₂-C₅ cyanoalkyl group for G and B includes, for example, cyanomethyl, 2-cyanoethyl, 3-cyanopropyl and 1-cyano-1-methylethyl groups.

The C₃-C₉ alkoxy carbonylalkyl group for B may be a straight chain or branched one, including, for example, methoxycarbonylmethyl, ethoxycarbonylmethyl, n-propoxycarbonylmethyl, i-propoxycarbonylmethyl, n-butoxycarbonylmethyl, i-butoxycarbonylmethyl, t-butoxycarbonylmethyl, n-hexyloxycarbonylmethyl, n-heptyloxycarbonylmethyl, 1-methoxycarbonylethyl, 1-ethoxycarbonylethyl, 1-n-butoxyethyl, 2-methoxycarbonylethyl, 2-ethoxycarbonylethyl, 1-methoxycarbonylpropyl, 3-ethoxycarbonylpropyl, 4-methoxycarbonylbutyl, 6-ethoxycarbonylhexyl, 1-methoxycarbonyl-1-methylethyl, 1-iso-propoxycarbonyl-1-methylethyl and 1-ethoxycarbonyl-2-methylpropyl groups.

The alkali metal for B includes, for example, lithium sodium and potassium.

The alkaline earth metal for H includes, for example, magnesium, calcium, strontium and barium. Preferred are magnesium, calcium and barium.

The ammonium group of NHT⁴T⁵T⁶ for B includes, for example, ammonium, monomethylammonium, dimethylammonium, trimethylammonium, diethylammonium, triethylammonium, di-isopropylammonium, di-isopropylethylammonium, hexylmethylammonium, cyclopropylmethylammonium, cyclohexylmethylammonium, allylmethylammonium, benzylmethylammonium and 4-methylcyclohexylethylammonium groups. Any two of T⁴, T⁵ and T⁶ may form, along with the nitrogen atom to which they are bonded, a heterocyclic, 5-, 6-, 7- or 8-membered ammonium group optionally having oxygen, nitrogen and/or sulfur atoms.

The methoxy group substituted by a phenyl group optionally substituted by a halogen atom or a C₁-C₄ alkyl group for G includes, for example, benzyloxy, 2-chlorobenzyloxy, 3-chlorobenzyloxy, 4-chlorobenzyloxy, 3-methylbenzyloxy, 4-t-butylbenzyloxy, 2,6-difluorobenzyloxy and 2-fluoro-4-chlorobenzyloxy groups.

The heterocyclic, 5-, 6-, 7- or 8-membered ammonium group optionally having oxygen, nitrogen and/or sulfur atoms, which is formed by two of T⁴, T⁵ and T⁶ along with the nitrogen atom to which they are bonded, includes, for example, pyrrolidine, pyrazolidine, imidazolidine, oxazolidine, isoxazolidine, thiazolidine, piperazine, piperazine, morpholine, thiamorpholine, hexamethylenimine and heptamethylenimine groups. The haloalkylsulfenyl group for G, R, W, X, Y and Z may be a straight chain or branched C₁-C₄ haloalkylthio group, including, for example, fluoromethylthio, chlorodifluoromethylthio, bromodifluoromethylthio, trifluoromethylthio, trichloromethylthio, 2,2,2-trifluoroethylthio, 1,1,2,2-tetrafluoroethylthio, fluoroethylthio, pentafluoroethylthio and fluoro-iso-propylthio groups.

The haloalkylsulfinyl group for G, R, W, X, Y and Z may be a straight chain or branched, C₁-C₄ haloalkylsulfinyl group, including, for example, fluoromethylsulfinyl, chlorodifluoromethylsulfinyl, bromodifluoromethylsulfinyl, trifluoromethylsulfinyl, trichloromethylsulfinyl, 2,2,2-trifluoroethylsulfinyl, 1,1,2,2-tetrafluoroethylsulfinyl, fluoroethylsulfinyl, pentafluoroethylsulfinyl and fluoro-iso-propylsulfinyl groups.

The haloalkylsulfonyl group for G, R, W, X, Y and Z may be a straight chain or branched, C₂-C₄ haloalkylsulfonyl group, including, for example, fluoromethylsulfonyl, chlorodifluoromethylsulfonyl, bromodifluoromethylsulfonyl, trifluoromethylsulfonyl, trichloromethylsulfonyl, 2,2,2-trifluoroethylsulfonyl, 1,1,2,2-tetrafluoroethylsulfonyl, fluoroethylsulfonyl, pentafluoroethylsulfonyl and fluoro-isopropylsulfonyl groups.

The haloalkenyl group for G, R, T¹ and W may be a straight chain or branched C₂-C₄ haloalkenyl group, including, for example, 2-chloroethenyl, 2-bromoethenyl and 2,2-dichloroethenyl groups.

The alkenyloxy group for G, R, R¹, T¹, W, Y and Y¹ may be a straight chain or branched C₂-C₄ alkenyloxy group, including, for example, allyloxy, 2-propenyloxy, 2-butenyloxy and 2-methyl-2-propenyloxy groups.

The haloalkenyloxy group for G, R, W and Y may be a straight chain or branched C₂-C₅ haloalkenyloxy group, including, for example, 3-chloro-2-propenyloxy, 3,3-dichloro-2-propenyloxy, 4-chloro-2-butenyloxy, 4,4-dichloro-3-butenyloxy and 4,4-difluoro-3-butenyloxy groups.

The alkenylsulfenyl group for G, R, W, X, Y and Z may be a straight chain or branched C₂-C₄ alkenylsulfenyl group, including, for example, allylsulfenyl, 2-propenylsulfenyl, 2-butenylsulfenyl and 2-methyl-2-propenylsulfenyl groups.

The alkenylsulfinyl group for G, R, W, X, Y and Z may be a straight chain or branched C₂-C₅ alkenylsulfinyl group, including, for example, allylsulfinyl, 2-propenylsulfinyl, 2-butenylsulfinyl and 2-methyl-2-propenylsulfinyl groups.

The alkenylsulfonyl group for G, R, W, X, Y and Z may be a straight chain or branched C₂-C₄ alkenylsulfonyl group, including, for example, allylsulfonyl, 2-propenylsulfonyl, 2-butenylsulfonyl and 2-methyl-2-propenylsulfonyl groups.

The haloalkenylsulfenyl group for G, R, W and Y may be a straight chain or branched C₂-C₄ haloalkenylsulfenyl group, including, for example, 3-chloro-2-propenylsulfenyl, 4-chloro-2-butenylsulfenyl, 3,3-dichloro-2-propenylsulfenyl, 4,4-dichloro-3-butenylsulfenyl and 4,4-difluoro-3-butenylsulfenyl groups.

The haloalkenylsulfinyl group for G, R, W and Y may be a straight chain or branched C₂-C₄ haloalkenylsulfinyl

group, including, for example, 3-chloro-2-propenylsulfanyl, 3,3-dichloro-2-propenylsulfanyl, 4-chloro-2-butenylsulfanyl, 4,4-dichloro-3-butenylsulfanyl and 4,4-difluoro-3-butenylsulfanyl groups.

The haloalkenylsulfonyl group for G, R, W and Y may be a straight chain or branched C₂-C₄ haloalkenylsulfonyl group, including, for example, 3-chloro-2-propenylsulfonyl, 3,3-dichloro-2-propenylsulfonyl, 4-chloro-2-butenylsulfonyl, 4,4-dichloro-3-butenylsulfonyl and 4,4-difluoro-3-butenylsulfonyl groups.

The C₂-C₄ haloalkynyl group for G, R and W includes, for example, chloroethynyl, bromoethynyl, iodoethynyl, 3-chloro-1-propynyl and 3-bromo-1-butynyl groups.

The C₂-C₄ alkenyloxy group for G, R, W and Y includes, for example, 2-propynyloxy, 2-butenyloxy and 1-methyl-2-propynyloxy groups.

The C₂-C₄ haloalkenyloxy group for G, R, W and Y includes, for example, 3-chloro-2-propynyloxy, 3-bromo-2-propynyloxy and 3-iodo-2-propynyloxy groups.

The C₂-C₆ alkenylsulfenyl group for G, R, W and Y includes, for example, 2-propynylsulfenyl, 2-butynylsulfenyl and 1-methyl-2-propynylsulfenyl groups.

The C₂-C₆ alkenylsulfanyl group for G, R, W and Y includes, for example, 2-propynylsulfanyl, 2-butenylsulfanyl and 1-methyl-2-propynylsulfanyl groups.

The C₂-C₆ alkenylsulfonyl group for G, R, W and Y includes, for example, 2-propynylsulfonyl, 2-butynylsulfonyl and 1-methyl-2-propynylsulfonyl groups.

The C₂-C₆ haloalkenylsulfenyl group for G, R, W and Y includes, for example, 3-chloro-2-propynylsulfenyl, 3-bromo-2-propynylsulfenyl and 3-iodo-2-propynylsulfenyl groups.

The C₂-C₆ haloalkenylsulfanyl group for G, R, W and Y includes, for example, 3-chloro-2-propynylsulfanyl, 3-bromo-2-propynylsulfanyl and 3-iodo-2-propynylsulfanyl groups.

The C₂-C₆ haloalkynylsulfonyl group for G, R, W and Y includes, for example, 3-chloro-2-propynylsulfonyl, 3-bromo-2-propynylsulfonyl and 3-iodo-2-propynylsulfonyl groups.

The C₂-C₄ alkylcarbonyloxy group for G, R, W and Y includes, for example, acetoxy, propanoyloxy, butanoyloxy and isopropylcarbonyloxy groups.

The benzoyl group optionally substituted by X for E and G includes, for example, benzoyl, 2-chlorobenzoyl, 3-chlorobenzoyl, 4-chlorobenzoyl, 4-bromobenzoyl, 4-fluorobenzoyl, 3-methylbenzoyl, 4-methylbenzoyl, 4-tert-butylbenzoyl and 3,4-dichlorobenzoyl groups.

Even at low concentration, the compounds of the present invention effectively prevent various pests, which include, for example, so-called agricultural insect pests that injure agricultural and horticultural crops and trees, so-called livestock insect pests that live on livestock and poultry, so-called sanitary insect pests that have various negative influences on the human living environment including houses, so-called stored products insect pests that injure grains stored in storehouses, and also acarids, nematodes, molluscs and crustaceans that live in the same sites as above and injure those mentioned above.

Examples of insect pests, stands, nematodes, molluscs and crustaceans capable of being exterminated by the compounds of the present invention are mentioned below, which, however, are not limitative.

Insect pests of Lepidoptera, such as rice stem borer (*Chilo suppressalis* Walker), rice leafroller (*Cnaphalocrocis medinalis* Guenée), green rice caterpillar (*Naranga aenescens* Moore), rice skipper (*Parnara guttata* Bremer et Gvey),

diamond back moths (*Plutella xylostella* Linneé), cabbage armyworms (*Mamestra brassicae* Linneé), common white (*Pieris rapae crucivora* Boisduval), turnip moth (*Agrotis segetum* Denis et Schiffermüller), common cutworm (*Spodoptera litura* Fabricius), beet armyworm (*Spodoptera exigua* Hübner), smaller tea tortrix (*Adoxophyes* sp.), oriental tea tortrix (*Homona magnanima* Diakonoff), peach fruit moth (*Carposina niponensis* Walsingham), oriental fruit moth (*Grapholita molests* Busck), summer fruit tortrix (*Adoxophyes orana fascists* Walsingham), apple leafminers (*Phyllonorycter ringoniella* Matsumura), corn earworm (*Helicoverpa zea* Boddie), tobacco bad worms (*Heliothis virescens* Fabricius), European corn borer (*Ostrinia nubilalis* Hübner), fall armyworm (*Spodoptera frugiperda* J. E. Smith), Codling moth (*Cydia pomonella* Linneé), fall webworms (*Hyphantria cunea* Drury), etc.;

Insect pests of Hemiptera, such as green rice leafhopper (*Nephotettix cincticeps* Uhler), brown rice planthoppers (*Nilaparvata lugens* Stal), green peach aphid (*Myzus persicae* Sulzer), cotton aphid (*Aphis gossypii* Glover), greenhouse whitefly (*Trialeurodes vaporariorum* Westwood), sweetpotato white fly (*Bemisia tabaci* Gennadius), pear psylla (*Psylla pyricola* Forster), azalea lace bug (*Stephanitis pyrioides* Scott), arrowhead scale (*Unaspis yanonensis* Kuwana), comstock mealybug (*Pseudococcus comstocki* Kuwana), red wax scale (*Ceroplastes rubens* Maskell), brown-marmorated stinkbug (*Halyomorpha mistis* Uhler), cabbage bug (*Eurydema rugosam* Motschulsky), bed bug (*Cimex lectularius* Linneé), etc.;

Insect pests of Coleoptera, such as twenty-eight-spotted ladybird (*Henosepilachna vigintioctopunctata* Fabricius), cupreous chafers (*Anomala cuprea* Hope), ricewater weevil (*Lissorhoptrus oryzophilus* Kuschel), sweetpotato weevil (*Cylas formicarius* Fabricius), cucurbit leaf beetle (*Aulacophora femoralis* Motschulsky), striped flea beetle (*Phyllotreta striolata* Fabricius), white-spotted longicom beetle (*Anoplophora malasiaca* Thomson), pine sawyers (*Monochamus alternatus* Hope), corn rootworms (*Diabrotica* spp.), rice weevil (*Sitophilus zeamais* Motschulsky), lesser rice weevil (*Sitophilus oryzae* Linneé), granary weevils (*Sitophilus granarius* Linneé), red four beetle (*Tribolium castaneum* Herbst), etc.;

Insect pests of Diptera, such as legume leafminer (*Liriomyza trifolii* Burgess), seedcorn maggot (*Delis platura* Meigen), Hessian fly (*Mayetiola destructor* Say), melon fly (*Dacus (Zengodacus) cucurbitae* Coquillett), Mediterranean fruit fly (*Ceratitis capitata* Wiedemann), house flies (*Musca domestica* Linneé), stable fly (*Stomoxys calcitrans* Linneé), Sheep ked (*Melophagus orinus*), common cattle grub (*Hypoderm lineatum* devillers), northern cattle grub (*Hypoderma baris* Linneé), sheep botfly (*Oestrus ovis* Linneé), tsetse fly (*Golossina palpalis* Robineau-Desvoidy), common gnat (*Culex pipiens pollens* Coquillett), yellow-fever mosquitoes (*Aedes aegypti* Linneé), *Anopheles culicifacies*), etc.

Insect pests of Hymenoptera, such as cabbage sawfly (*Athalia rosae ruficornis* Jakovlev), pine sawfly (*Neodiprion sertifer* Geoffroy), chestnut sawfly (*Apethymus kuri* Takeuchi), etc.;

Insect pests of Thysanoptera, such as melon thrips (*Thrips palmi* Karny), onion thrips (*Thrips tabaci* Lindeman), western flower thrips (*Frankliniella occidentalis* Pergande), flower thrip (*Frankliniella intonsa* Trybom), yellow tea thrip (*Scirtothrips dorsalis* Hood), etc.;

Insect pests of Dictyoptera, such as smokybrown cockroach (*Periplaneta fuliginosa* Serville), Japanese cockroach (*Periplaneta japonica* Kamy), German cockroaches (*Blattella germanica* Linneé), etc.;

Insect pests of Orthoptera, such as oriental migratory locust (*Locusts migratoria* Linneé), rice grasshopper (*Oxya yezoensis* Shiraki), desert locust (*Schistocetca gregaria* Forskal), etc.;

Insect pests of Isoptera, such as Formosan subterranean 5 termit (*Coptotermes formosanus* Shiraki), (*Reticulitermes Leucotermes speratus* Kolbe), (*Odontotermes formosanus* Shirakif), etc.;

Insect pests of Siphonaptera, such as cat fleas (*Ctenocephalides felis* Bouché), human fleas (*Pulex irritans* 10 Linneé), oriental rat flea (*Xenopsylla cheopis* Rothschild), etc.;

Insect pests of Mallophaga, such as Chicken bodylouse (*Menacanthus stramineus* Nitsch), cattle biting louse (*Bovicola bovis* Linneé), etc.;

Insect pests of Anoplura, such as short-nosed cattle louse (*Haematopinus eurysternus* Nitzsh), hog louse (*Haematopinus suis* Linneé), longnosed cattle louse (*Linognathus vituli* Linneé), little cattle louse (*Solenopates capillatus* Enderlein), etc.

Pests of TETRANYCHIDAE, such as citrus red mite (*Panonychus cirri* McGregor), European red mite (*Panonychus ulmi* Kock), two-spotted spider mite (*Tetranychus urticae* Koch), Kanzawa spider mite (*Tetranychus kanzawai* Kishida), etc.;

Pests of ERIOPHYDAE, such as pink citrus rust mite (*Aculops pelekassi* Keifer), pear rust mite (*Epitrimerus pyri* Nalepa), dry bulb mite (*Aceria tulipae* Keiter), pink tea mite (*Acaphylla theae* watt), etc.;

Pests of TARSONEMIDAE, such as broad mites 30 (*Polyphagotarsonemus lotus* Banks), cyclamen mite, strawberry mite (*Steneotarsonemus pallidus* Banks), etc.;

Pests of ACARIDAE, such as mold mite, copra mite, forage mite (*Tyrophagus putrescentiae* Schrank), bulb mite (*Rhizoglyphus robini* Claparede), etc.;

Pests of VARROIDAE, such as bee brood mite (*Varroa jacobsoni* Oudemans), etc.;

Pests of Ixodidae, such as bull ticks (*Boophilus microplus* Canestrini), (*Haemaphysalis longicornis* Neumann), etc.;

Pests of Sarcoptidae, such as sarcoptes mange mite 40 (*Sarcoptes scabiei* Linneé), etc.;

Nematodes, such as southern root-knot nematode (*Meloidogyne incognito* Kofoid et White), northern root-knot nematode (*Meloidogyne hapla* Chitwood), Cobb root-lesion nematode (*Pratylenchus penetrans* Cobb), walnut 45 root-lesion nematode (*Pratylenchus vulnus* Allen et Jensen), potato cyst nematode (*Globodera rostochiensis* Wollenweber), pine wood nematode (*Bursaphelenchus xylophilus* Steiner et Buhner), etc.;

Mollusca, such as apple snail (*Pomacea canaliculata* 50 Lamarck), (*Incilaria pilineata* Benson), (*Acusta despecta sieboldiana* Pfeiffer), (*Euhadra peliomphala* Pfeiffer), pillbug (*Armadillidium vulgare* Latreille), etc.;

Crustaceans, such as pillbug (*Armadillidium vulgare* Latreille), etc.

The plant diseases to be controlled by the compounds of the present invention are as follows:

Blast (*Pyricularia oryzae*), Helminthosporium leaf spot (*Cochliobolus miyabeanus*) and Sheath blight (*Rhizoctonia solani*) of rice,

Powdery mildew (*Erysiphe graminis* f. sp. hordei, f. sp. tritici), Leaf stripe (*Pyrenophora graminea*), Net blotch (*Pyrenophora teres*), Fusarium blight (*Gibberella zae*), yellow rust, black stem rust and brown rust (*Puccinia striiformis*, *P. graminis*, *P. recondita* and *P. hondei*), Snow 65 blight and snow mold (*Typhula* sp., *Micronectriella nivais*), Loose smut (*Ustilago tritici*, *U. nuda*), Eyespot

(*Pseudocercospora herpotrichoides*), Scald and leaf blotch (*Rhynchosporium secalis*), Speckled blotch (*Septoria tritici*), and Glume blotch (*Leptosphaeria nodorum*) of barley and wheat,

Melanose (*Diaporthe citri*), Scab (*Elsinoe fawcetti*) and Common green mold and blue mold (*Penicillium digitatum*, *P. italicum*) of citrus fruit,

Blossom blight (*Sclerotinia mali*), Canker (*Valsa mali*), Powder mildew (*Podosphaera leucotricha*), Alternaria leaf spot (*Alternaria mali*) and Scab (*Yenturia inaequalis*) of apple,

Scab (*Yenturia nashicola*), Black spot (*Alternaria Kikuchiana*) and Rust (*Gymnosporangium haraeaeum*) of pear,

Brown rot (*Sclerotinia cinerea*), Scab (*Cladosporium carpophilum*), and Phomopsis rot (*Phomopsis* sp.) of peach,

Downy mildew (*Plasmopara viticola*), Anthracnose (*Elsinoe ampelina*), Ripe rot (*Glomerella cingulata*), Powdery mildew (*Uncinula necator*) and Rust (*Phakopsora Ampelopsidis*) of grape,

Anthracnose (*Gloesporium kaki*), Powdery mildew (*Phyllactinia kakicole*), Angular leaf spot (*Cercospora kaki*), and Circular leaf spot (*Mycosphaerella nawae*) of persimmon,

Downy mildew (*Pseudoperenospora cubensis*), Anthracnose (*Colletotrichum lagenarium*), Powdery mildew (*Sphaerotheca fuliginea*), and Gummy stem blight (*Mycosphaerella melonis*) of cucurbit,

Late blight (*Phytophthora injestans*), Early blight (*Alternaria solani*) and Leaf mold (*Cladosporium fulvam*) of tomato.

Brown spot (*Phomopsis vexans*) and Powdery mildew (*Erysiphe cichoracoarum*) of egg plant,

Alternaria leaf spot (*Alternaria japonica*) and white spot (*Cercospora brassicae*) of vegetable of the family crucifers.

Rust (*Puccinia allii*) of Welsh onion.

Purple seed stain (*Cercospora kikuchii*), Sphaceloma scab (*Elsinoe glycines*) and Pot and stem blight (*Diaporthe phaseololum*) of soybean,

Anthracnose (*Collectorichum lindemuthianum*) of kidney bean.

Leaf spot (*Mycosphaerella personatum*) and Brown leaf spot (*Cercospora arachidicola*) of peanut,

Powdery mildew (*Erysiphe pisi*) of garden pea,

Early blight (*Alternaria solani*) of potato,

Powdery mildew (*Sphaerotheca humuli*) of strawberry,

Net blister blight (*Exobasidium reticulatum*) and White scab (*Elsinoe leucospila*) of tea,

Brown spot (*Alternaria longipes*), Powdery mildew (*Erysiphe cichoracearum*) and Anthracnose (*Colletotrichum tabacum*) of tobacco,

Cercospora leaf spot (*Cercospora beticola*) of sugar beat,

Black spot (*Diplocarpon rosae*) and Powdery mildew (*Sphaerotheca pannosa*) of rose,

Leaf spot (*Septoria chrysanthemiindici*) and Rust (*Puccinia horiana*) of chrysanthemum,

Grey mold (*Botrytis cinerea*) of various kinds of crops, and,

Sclerotinia rot (*Sclerotinia sclerotiorum*) of various kinds 60 of crops.

In addition, the compounds of the present invention are effective in preventing the attachment of aquatic organisms, even at extremely low concentrations. Aquatic organisms to which the invention is directed are, for example, shellfishes and algae, such as mussel, barnacle, oyster, hydrozoan, hydra, Serpula, ascidian, seamoss, Bagula, mud pond snail, sea lettuce, green lever, Ectocarpus, etc.

51

Specifically, the compounds of the present invention can effectively ezertninete various pests and phytopathogenic microbes of, for example, Orthoptera, Hemiptera, Lepidoptera, Coleoptera, Hymenoptera, Diptera, Temitidae, and also mites and louses, even when used at low concentrations. In addition, the compounds of the invention are effective in preventing the attachment of various aquatic organisms living in sea water and fresh water to aquatic constructions, etc. On the other hand, the compounds of the present invention contains useful compounds that have few negative influences on mammals, fishes, shellfishes and useful insects.

Of the compounds of the invention, those having CN as E can be produced according to the following methods (Scheme 1).

Scheme 1:

(Method A)

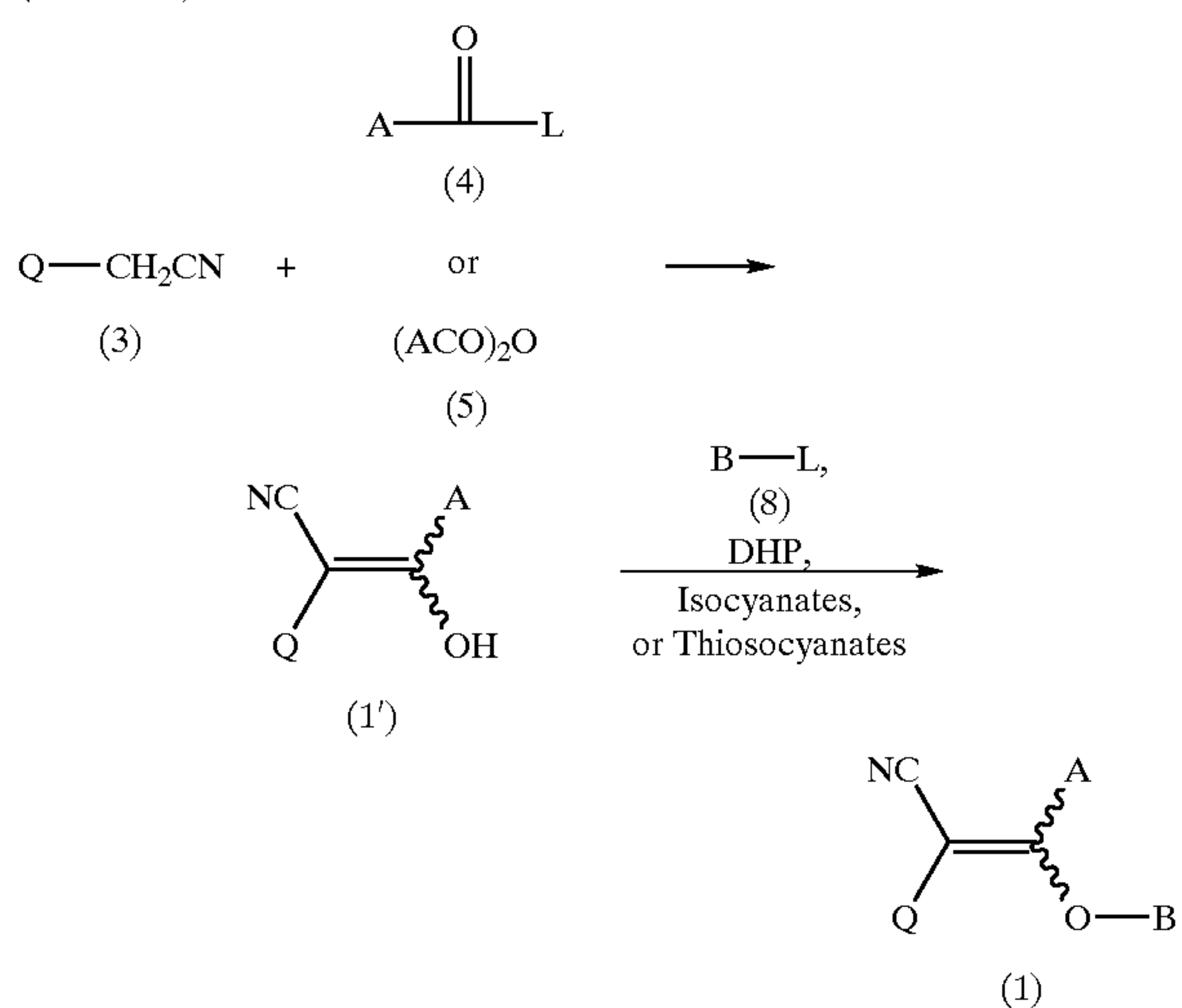

(Method B)

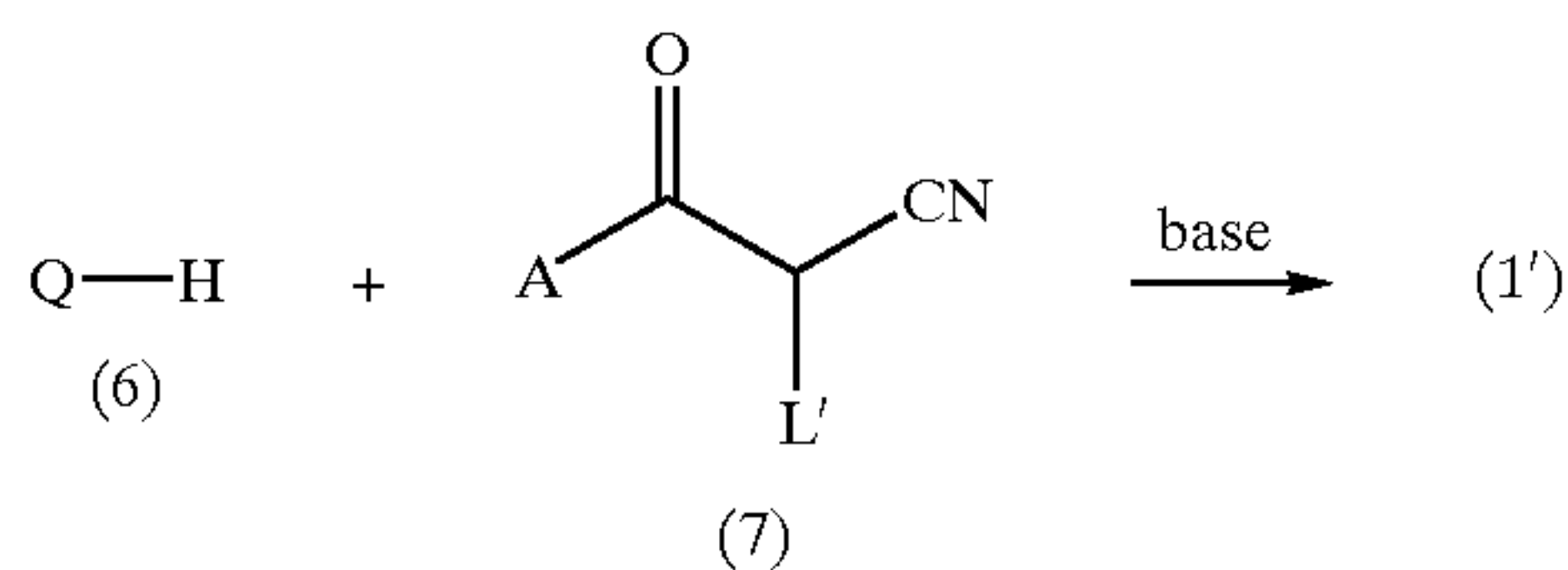

(Method C)

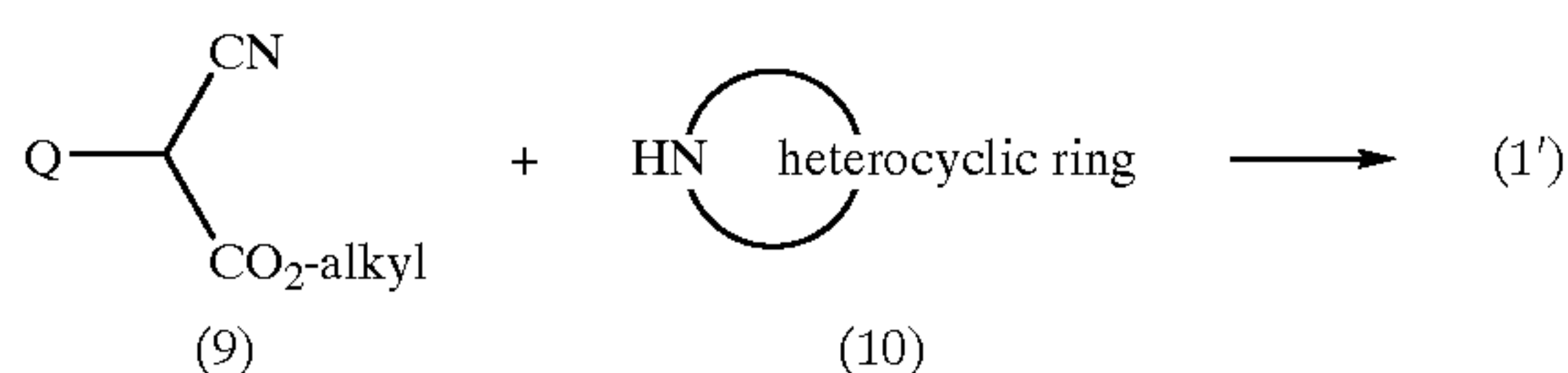

In (Scheme 1), Q, A and B have the same meanings as defined above; L represents a suitable leaving group, such as a chlorine atom, a bromine atom, an iodine atom, an alkoxy group having from 1 to 4 carbon atoms, a phenoxy group, an alkylsulfonyloxy group having from 1 to 4 carbon atoms, a benzenesulfonyloxy group, a toluenesulfonyloxy group, a phenoxy group, a 1-pyrazolyl group or a 1-imidazolyl group; L' represents a halogen atom; and alkyl represents an alkyl group preferably having from 1 to 4 carbon atoms. Method A in (Scheme 1) is to react an acetonitrile derivative of formula (3) with an acid chloride, ester or amide of formula (4) or with an acid anhydride of formula (5) to give compounds (1') of the present invention. The compound (1') of the invention is optionally reacted with an alkyl halide, an alkyl sulfonate, a trimethylsilyl halide, a sulfonyl chloride, a sulfamoyl chloride, a thiocarbamoyl chloride, an acid

52

chloride or an ester of formula (8) to be converted into compounds (1) of the invention. Depending on the type of B in the compounds (1) of the invention, the compound (1') is reacted with a dihydropyran, an isocyanate or a thioisocyanate to give the compounds (1). In Method A, if the compound of formula (4) or (5) is used in an excessive amount, the compounds (1) can be directly obtained without isolating the compounds (1').

Where Q is bonded to the acrylonitrile moiety via a nitrogen atom, compounds (1') may be produced according to Method B. Method B is to react a heterocyclic compound of formula (6) with a halogenocyanoketone derivative of formula (7) to give compounds (1') of the invention. Where A is bonded to the acrylonitrile moiety via a nitrogen atom, compounds (1') may be produced according to Method C. Method C is to react a cyanoacetic acid derivative of formula (9) with a heterocyclic compound of formula (10) to give compounds (1') of the invention. As the case may be, the compound of formula (9) will be prepared by reacting an acetonitrile derivative of formula (3), such as that used in Method A, with a carbonic acid ester in the presence of a base.

Of the compounds of the invention, those where E is

Scheme 2:

(Method D)

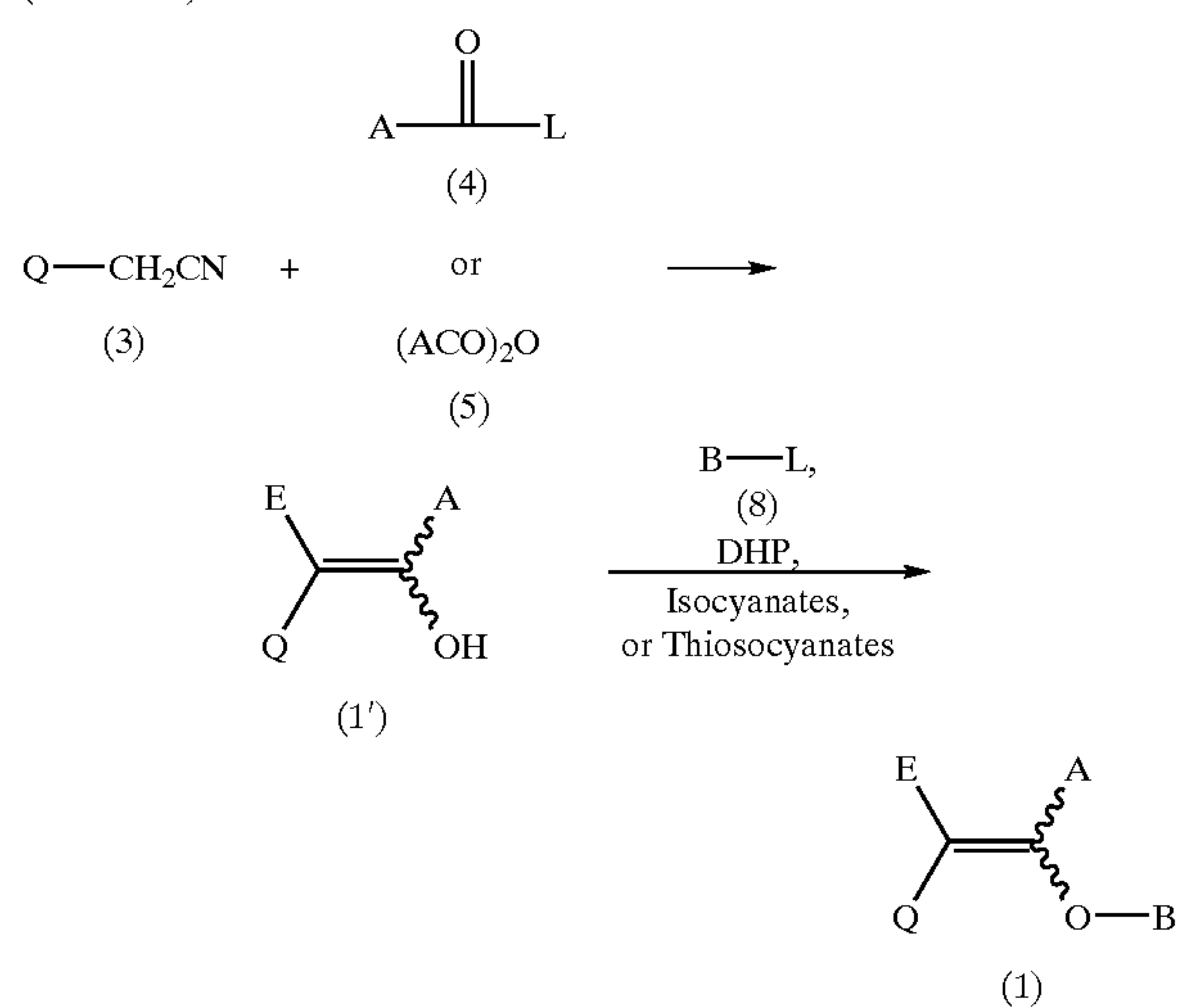

(Method E)

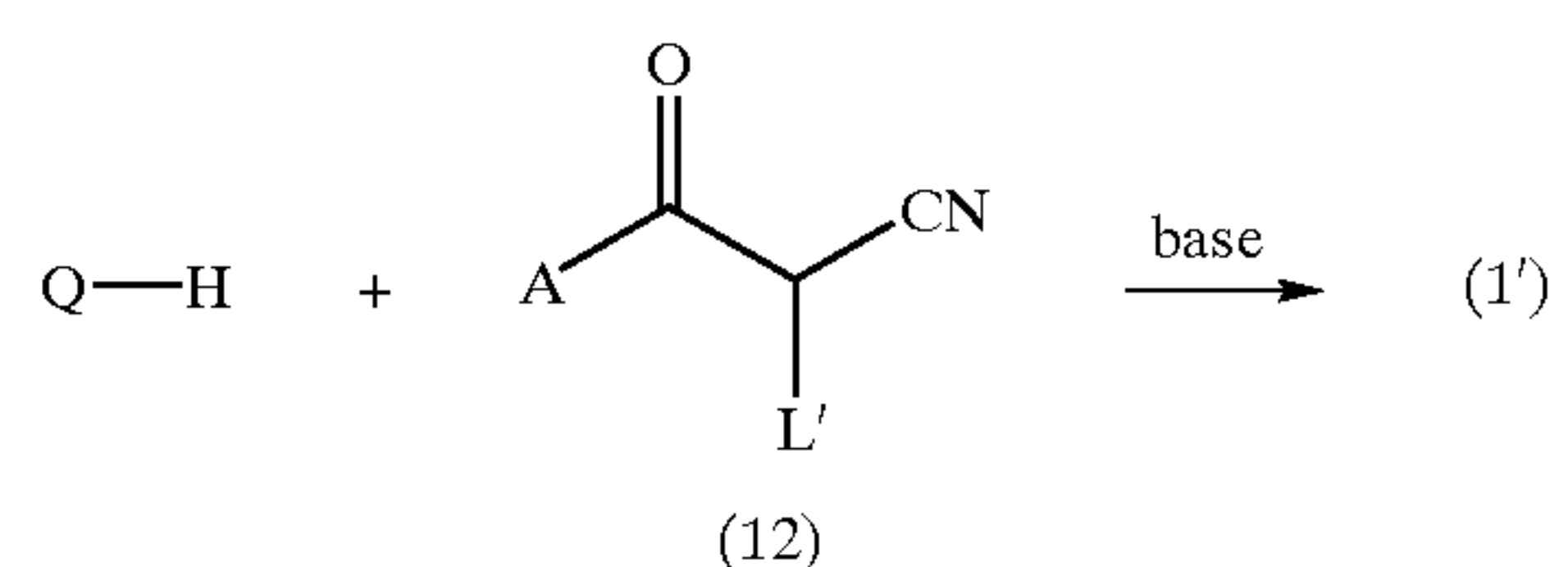

(Method F)

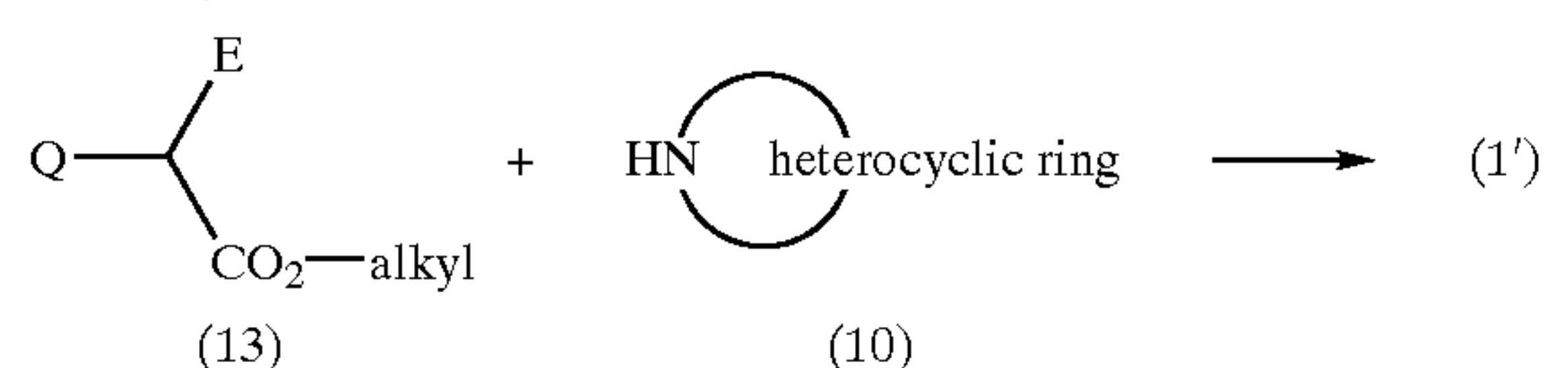

In (Scheme 2), Q, A, E, B, L, L' and alkyl have the same meanings as above.

Method D in (Scheme 2) is to react a compound of formula (11) with an acid chloride, ester or amide of formula (4) or with an acid anhydride of formula (5) to give the compounds (1') of the present invention. The compound (1') of the invention is optionally reacted with an alkyl halide, an alkyl sulfonate, a trimethylsilyl halide, a sulfonyl chloride,

a sulfamoyl chloride, a thiocarbamoyl chloride, an acid chloride or an ester of formula (8) to be converted into the compounds (1) of the invention. Depending on the type of B in the compounds (1) of the invention, the compound (1') is reacted with a dihydropyran, an isocyanate or a thioisocyanate to give the compounds (1). In Method A, if the compound of formula (4) or (5) is used in an excessive amount, the compounds (1) can be directly obtained without isolating the compounds (1').

Where Q is bonded to the ethylene moiety via a nitrogen atom, the compounds (1') may be produced according to Method E. Method E is to react a heterocyclic compound of formula (6) with a compound of formula (12) in the presence of a base to give compounds (1') of the invention.

Where A is bonded to the ethylene moiety via a nitrogen atom, the compounds (1') may be produced according to Method F. Method F is to react a compound of formula (13) with a heterocyclic compound of formula (10) through dealcoholation to give the compounds (1') of the invention. As the case may be, the compound of formula (13) will be prepared by reacting a compound of formula (11), such as that used in Method D, with a carbonic acid ester in the presence of a base.

If desired, the compounds (1') where E is an alkoxy-carbonyl group may be hydrolyzed, decarboxylated and halogenated to give the compounds of the invention where E is a halogen atom. As the case may be, the compounds of the invention where E is a halogen atom may be reacted with a nucleophilic reagent corresponding to E (e.g., triester phosphites, alkyl mercaptans, thiophenols, metal acrylides, metal cyanides, metal azides, nitrites) to give different compounds of the invention. Also as the case may be, the compounds to be obtained through decarboxylation of the compounds (1') where E is an alkoxy-carbonyl group may be reacted with an electrophilic reagent under basic conditions to give the compounds of the invention.

As the case may be, the processes of (Scheme 1) and (Scheme 2) are preferably effected in the presence of a base. The base to be used includes, for example, alkali metal alkoxides such as sodium ethoxide, sodium methoxide and t-butoxy potassium; alkali metal hydroxides such as sodium hydroxide and potassium hydroxide; alkali metal carbonates such as sodium carbonate and potassium carbonate; organic bases such as triethylamine, pyridine and DBU; organic lithium compounds such as butyl lithium; lithium amides such as lithium diisopropylamide and lithium bistrimethylsilylamide; and sodium hydride.

The reactions of (Scheme 1) and (Scheme 2) may be effected in a solvent that is inert to the reaction. The solvent includes, for example, lower alcohols such as methanol and ethanol; aromatic hydrocarbons such as benzene and toluene; etherd such as diethyl ether, tetrahydrofuran, 1,4-dioxane, 1,2-dimethoxyethane and 1,2-diethoxyethane; halogenated hydrocarbons such as methylene chloride, chloroform and 1,2-dichloroethene; amides such as dimethylformamide and dimethylacetamide; acetonitrile; dimethylsulfoxide; and mixed solvents of these. As the case may be, also employable are mixed solvent comprising said solvents and water. Also as the case may be, a quaternary ammonium salt such as tetra-n-butylammonium bromide may be added to the reaction system as a catalyst to obtain good results. The reaction temperature may be freely settled within a range between -30° C. and 200° C. Preferably, the reaction temperature falls between 0° C. and 150° C., or between 0° C. and the boiling point of the solvent if used. The base may be used in an amount of from 0.05 to 10 equivalents, preferably from 0.05 to 3 equivalents, of the reaction substrate.

The compounds of the present invention may be separated from reaction mixtures according to any ordinary methods. If the purification of the compounds of the invention is needed, they can be separated and purified by any ordinary methods of, for example, recrystallization or column chromatography.

Of the compounds of the invention, those having an asymmetric carbon atom include optically-active compounds of (+) form and (-) form.

Methods of producing the compounds (3) to be used in (Scheme 1) are referred to hereinunder. The compounds (3) can be produced according to the following (Scheme 3).

Scheme 3:

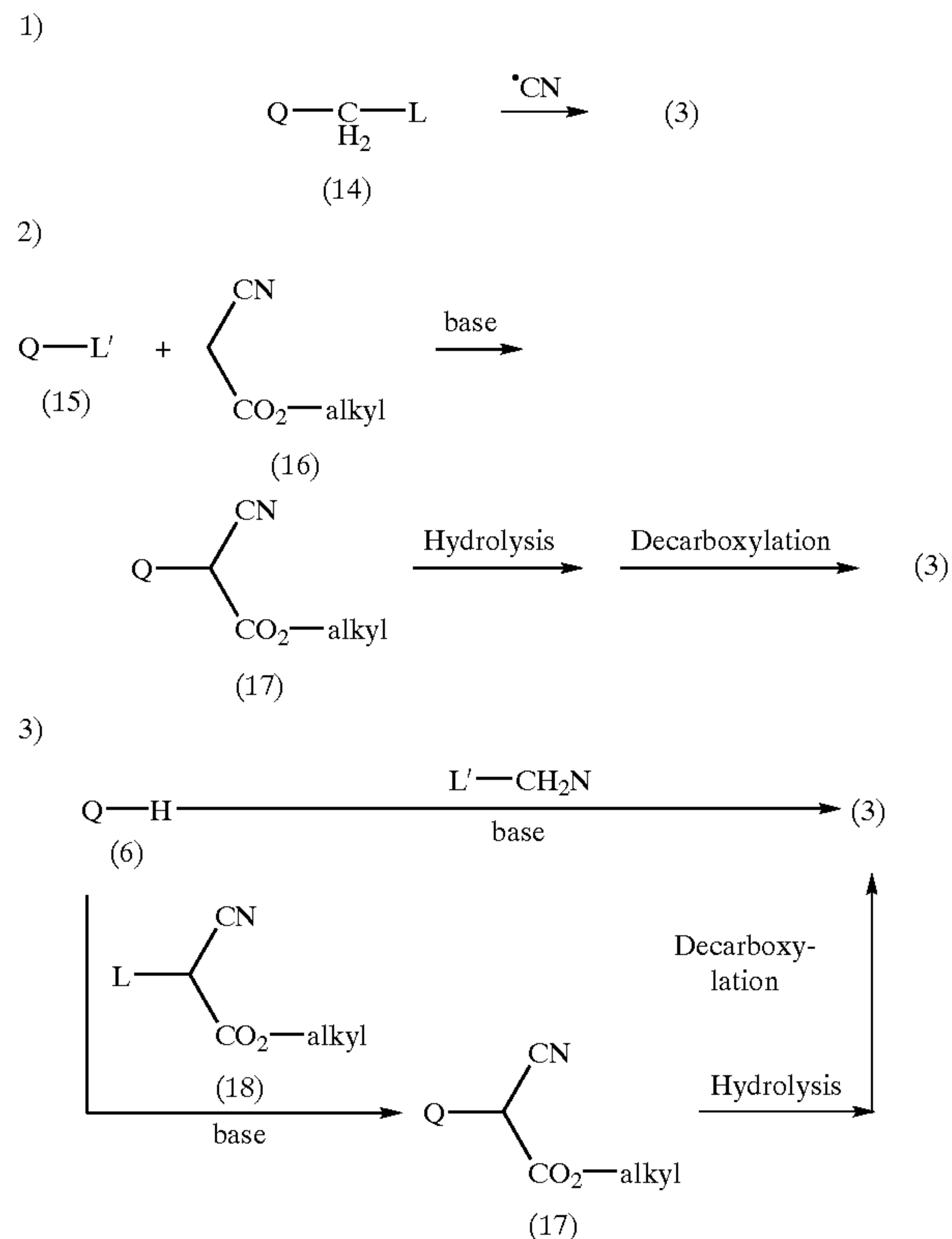

1) A benzyl halide, a benzyl alkylsulfonate, a benzyl arylsulfonate, a halomethyl-heterocyclic compound, an alkylsulfonyloxymethyl-heterocyclic compound or an arylsulfonyloxymethyl-heterocyclic compound of formula (14) is reacted with a suitable cyanating reagent to give compounds (3). Alternatively, a phenylacetic acid derivative or a heterocyclic acetic acid derivative is converted into the corresponding amide derivative, which is then dehydrated to give compounds (3).

2) A heterocyclic halide (15) is condensed with a cyanoacetate (16) in the presence of a base to give a compound (17), which is then hydrolyzed and decarboxylated to give compounds (3).

3) To obtain compounds (3) where Q is bonded to the ethylene moiety via a nitrogen atom, a heterocyclic derivative (6) where the nitrogen atom of Q is unsubstituted is reacted with a haloacetonitrile derivative in the presence of a base. Alternatively, the compound (6) is reacted with a compound (18) in the presence of a base to give a compound (17), said compound (18) being obtained through halogenation of a cyanoacetate, and thereafter the compound (17) is hydrolyzed and decarboxylated to obtain the compounds (3).

The compounds (11) to be used in (Scheme 2) can be produced in the same manner as in the production of the compounds (3) mentioned above.

55

The compounds (7) to be used in (Scheme I) can be produced by condensing a benzoic acid halide or heterocyclic carboxylic acid halide with a cyanoacetate in the presence of a base followed by halogenating the resulting condensate.

The above-mentioned halomethyl-heterocyclic compounds, alkylsulfonyloxymethyl-heterocyclic compounds and arylsulfonyloxymethyl-heterocyclic compounds can be derived from heterocyclic methane derivatives or heterocyclic carboxylate derivatives that are produced according to ordinary methods (see Alan R. Katritzky, and Charles W. Rees; Comprehensive Heterocyclic Chemistry, Vol. 2, Vol. 3, Vol. 4, Vol. 5 or Vol. 6). To produce the compounds (14) where Q is an oxazol-4-yl or thiazol-4-yl group, a carboxylic acid amide or thioamide can be reacted with 1,3-dichloro-2-propanone.

Examples of the compounds of the present invention are shown in Table 1 to Table 14 below. The abbreviations in these Tables are for the meanings mentioned below:

Me: methyl group, Et: ethyl group, Pr: propyl group, Bu: butyl group, Pen: pentyl group, Hex: hexyl group, Hep: heptyl group, Oct: octyl group, Non: nonyl group, Dec: decyl group, Ph: phenyl group, n: normal, is iso, sec: secondary, t: tertiary, c: cyclo.

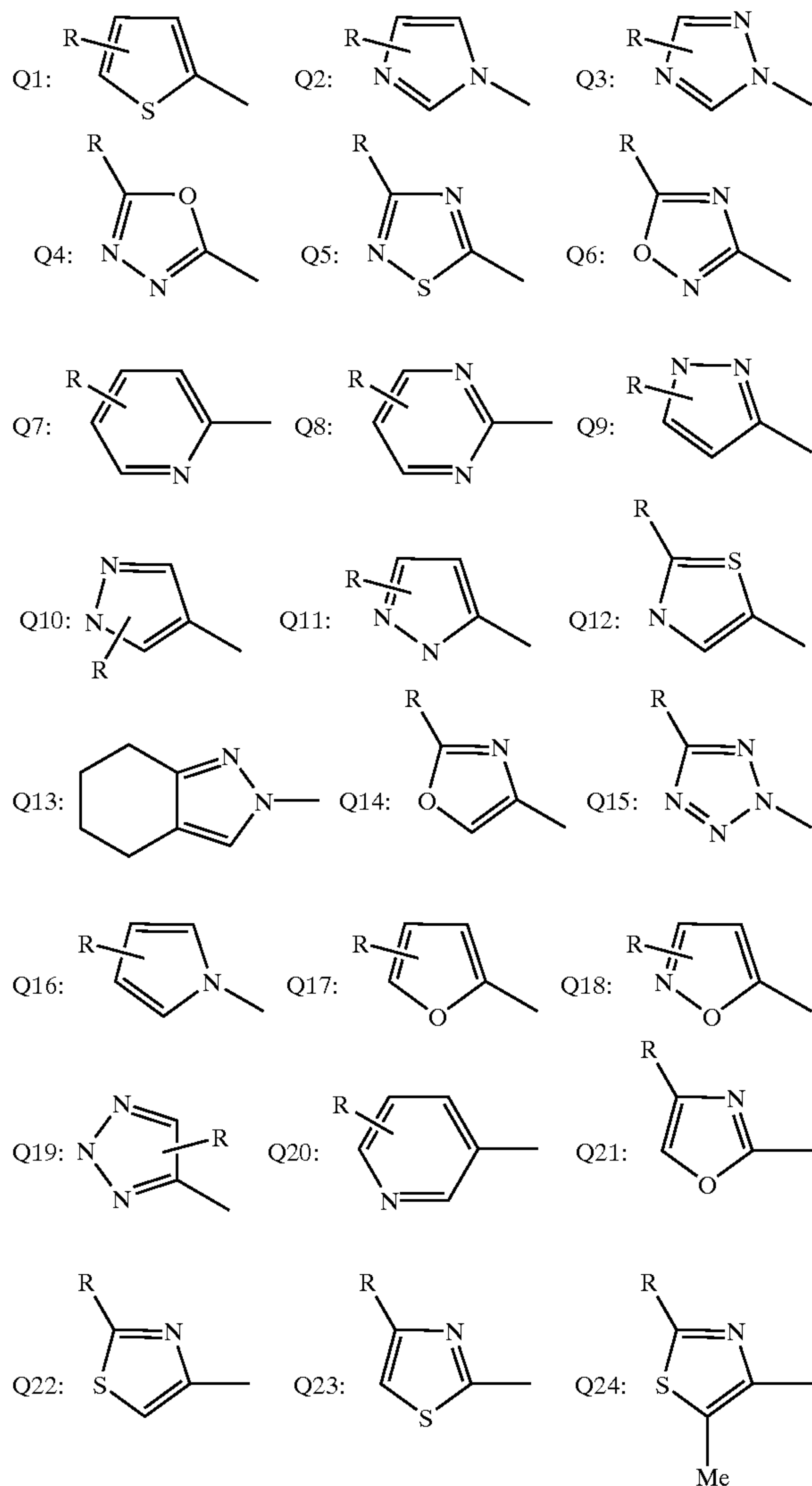

56

-continued

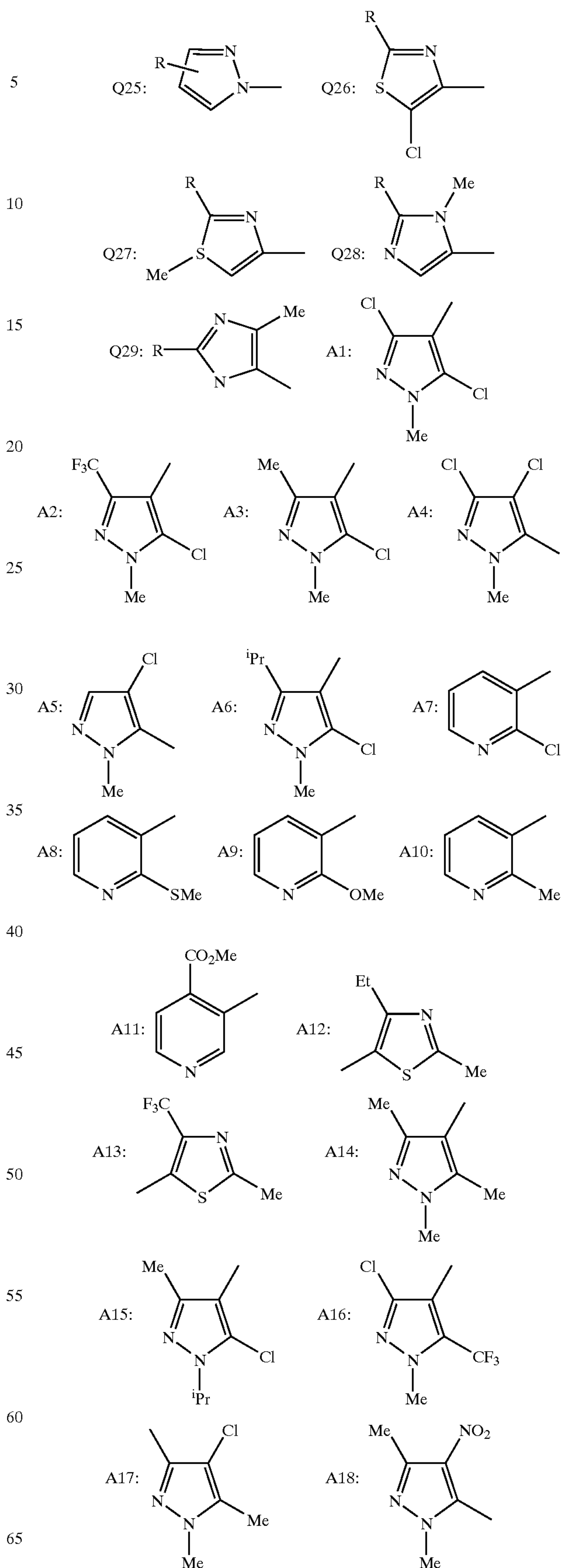

57

-continued

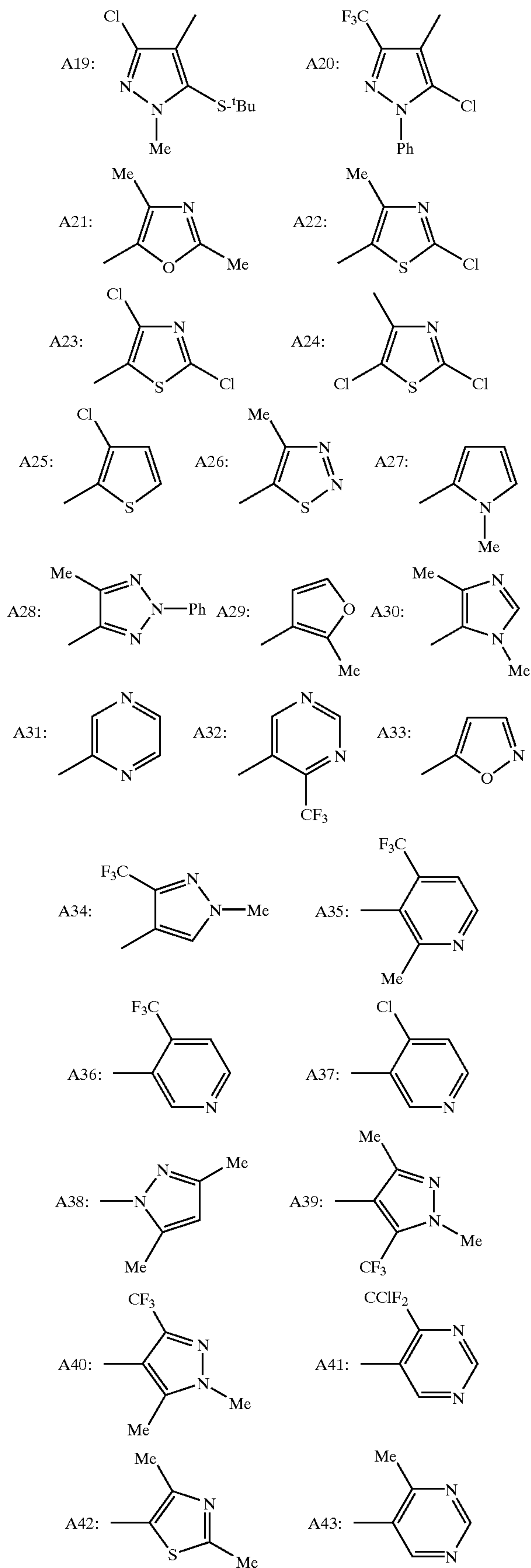

58

-continued

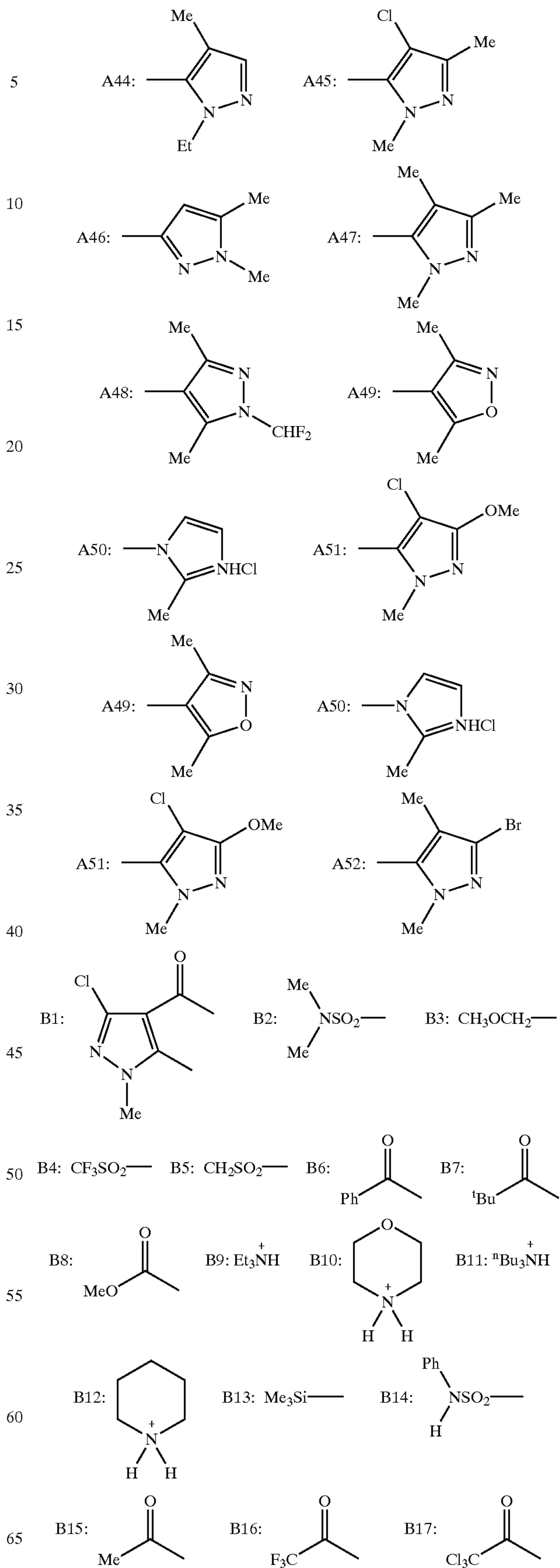

59

-continued

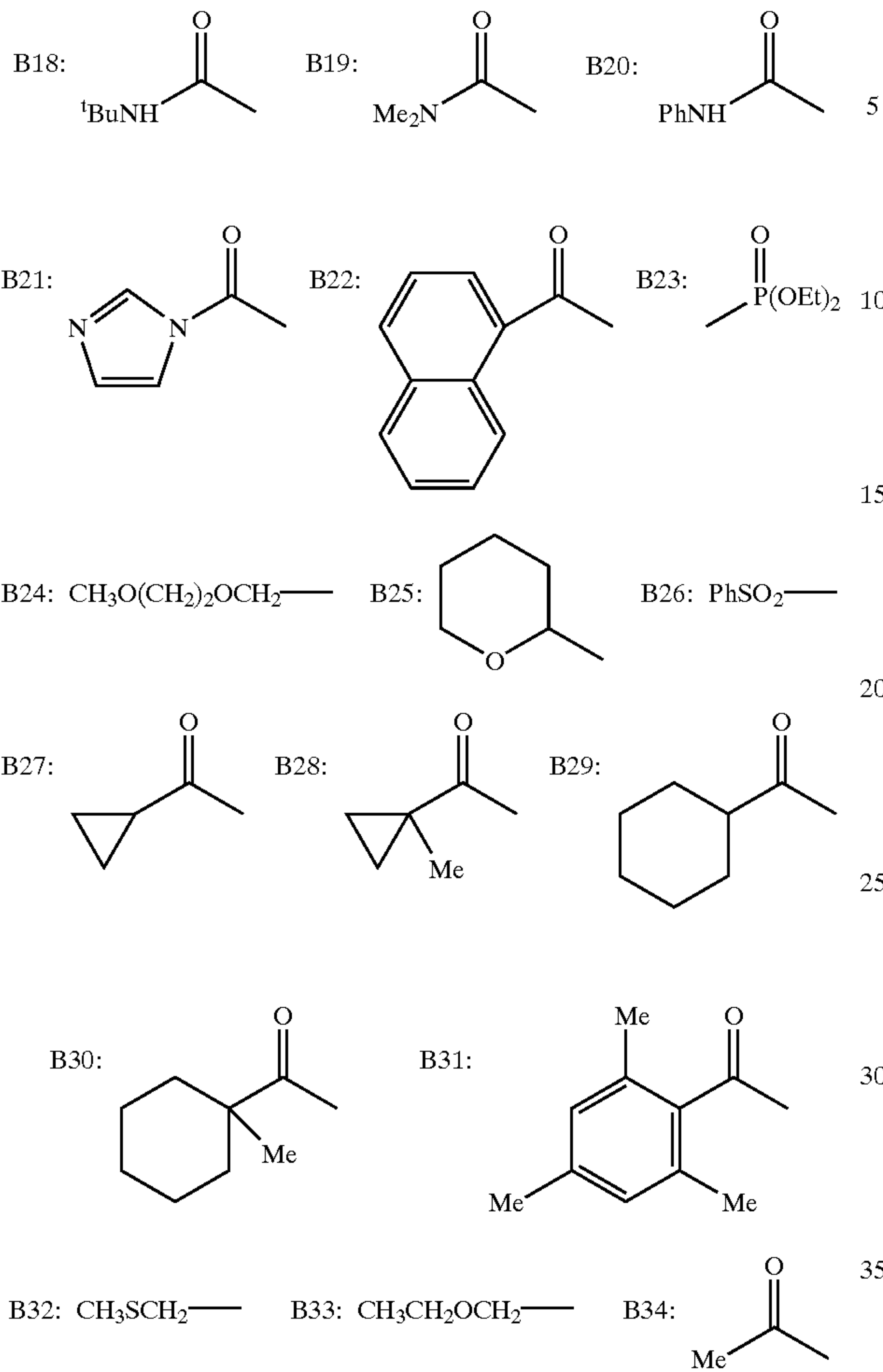

60

-continued

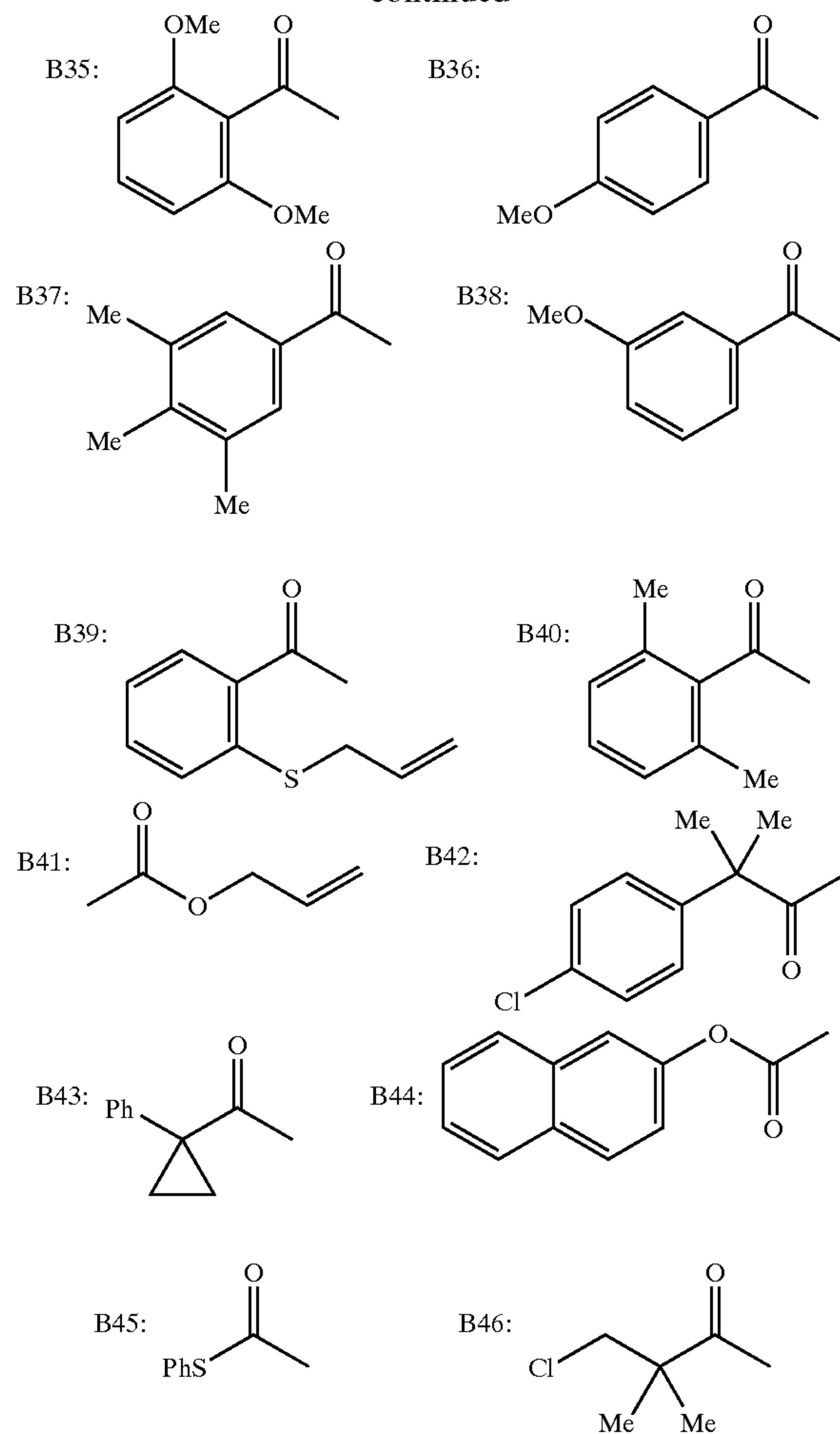

TABLE 1

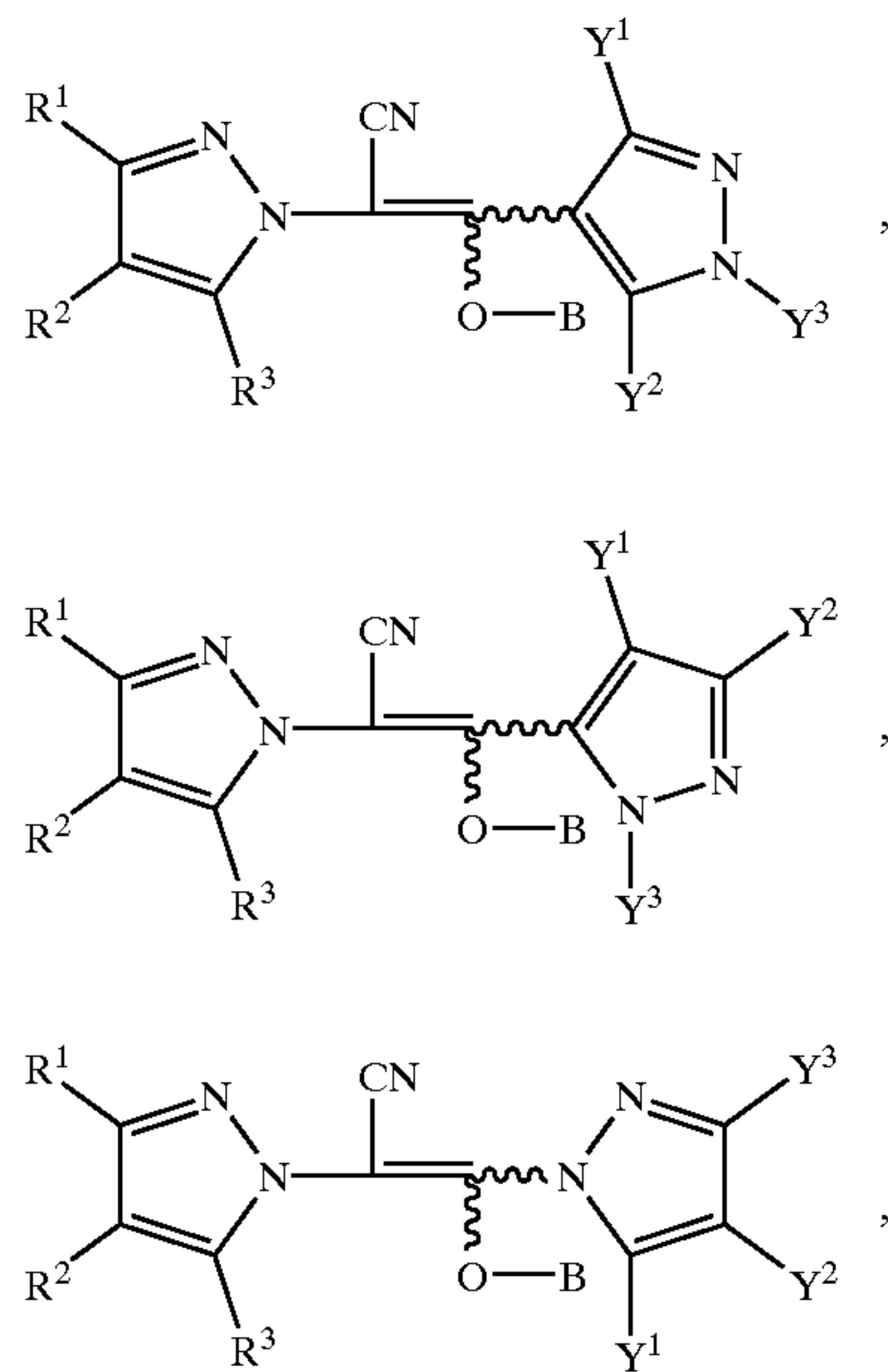

TABLE 1-continued

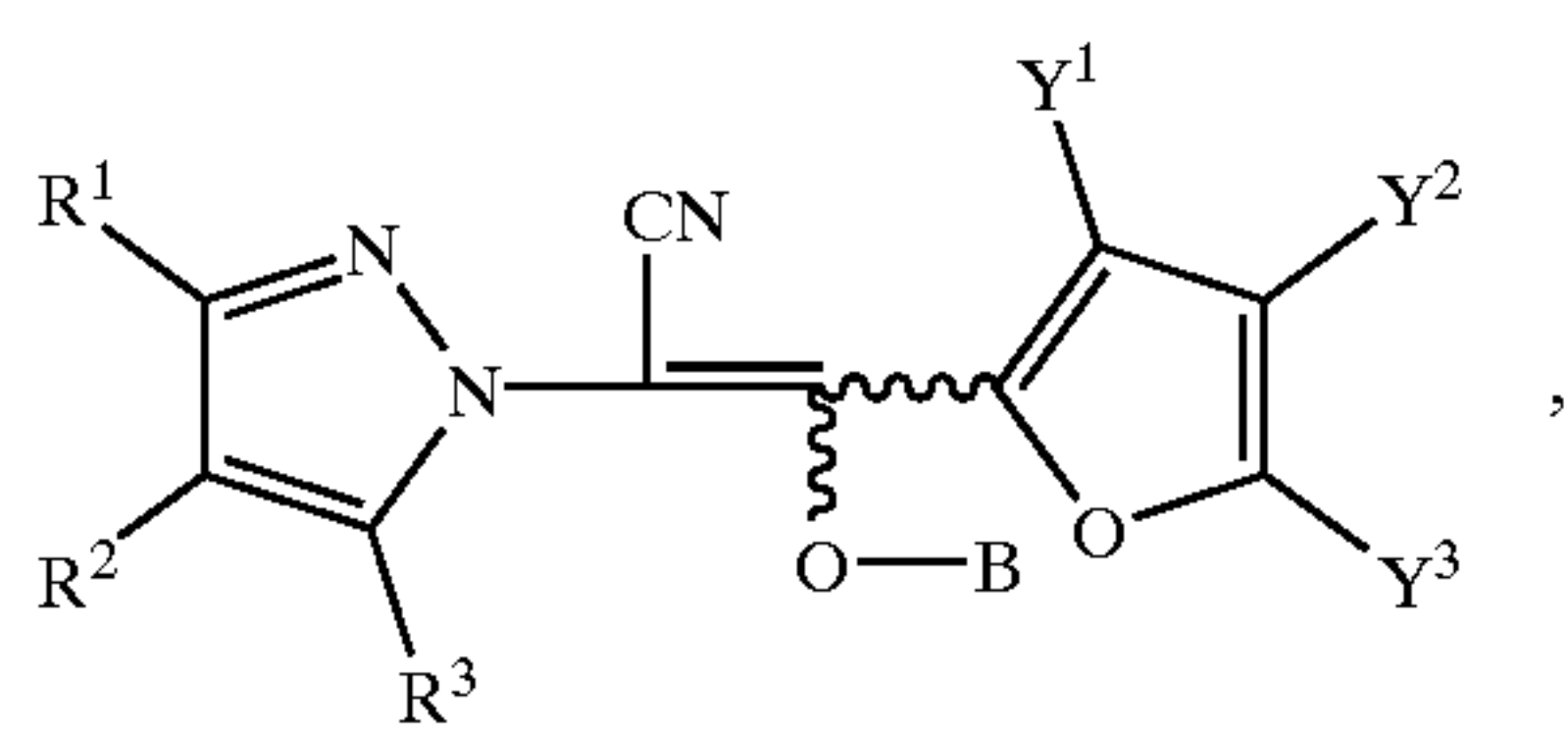
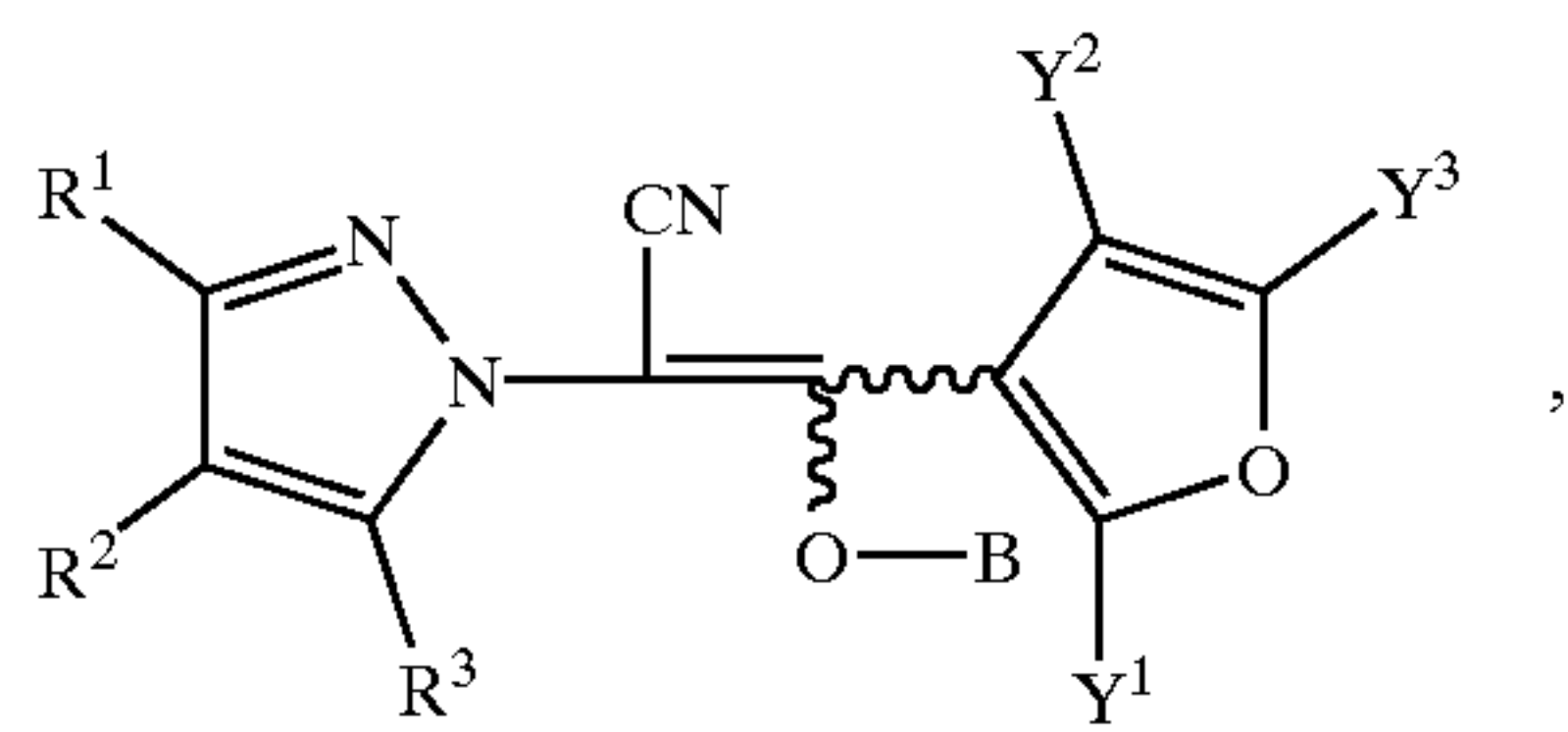
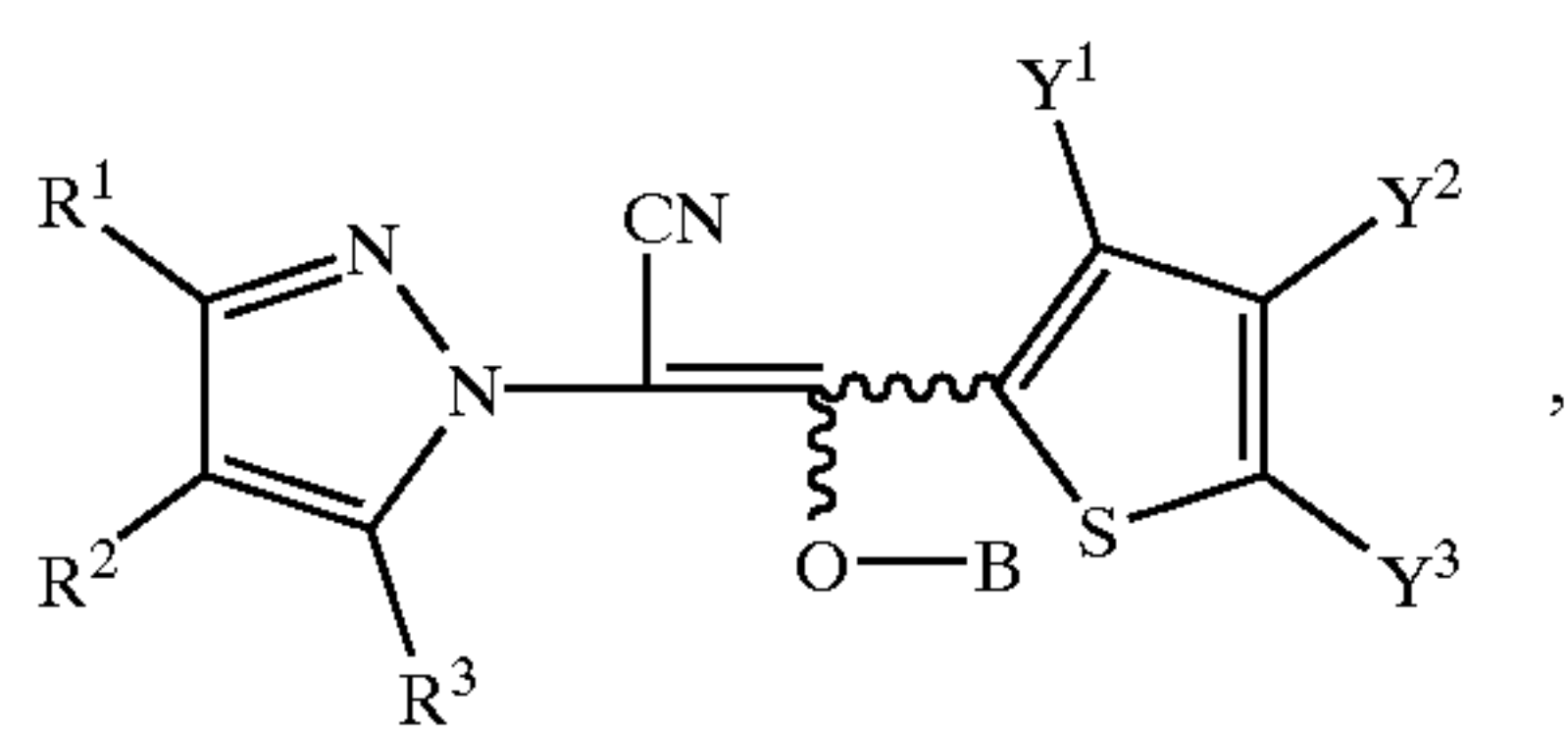
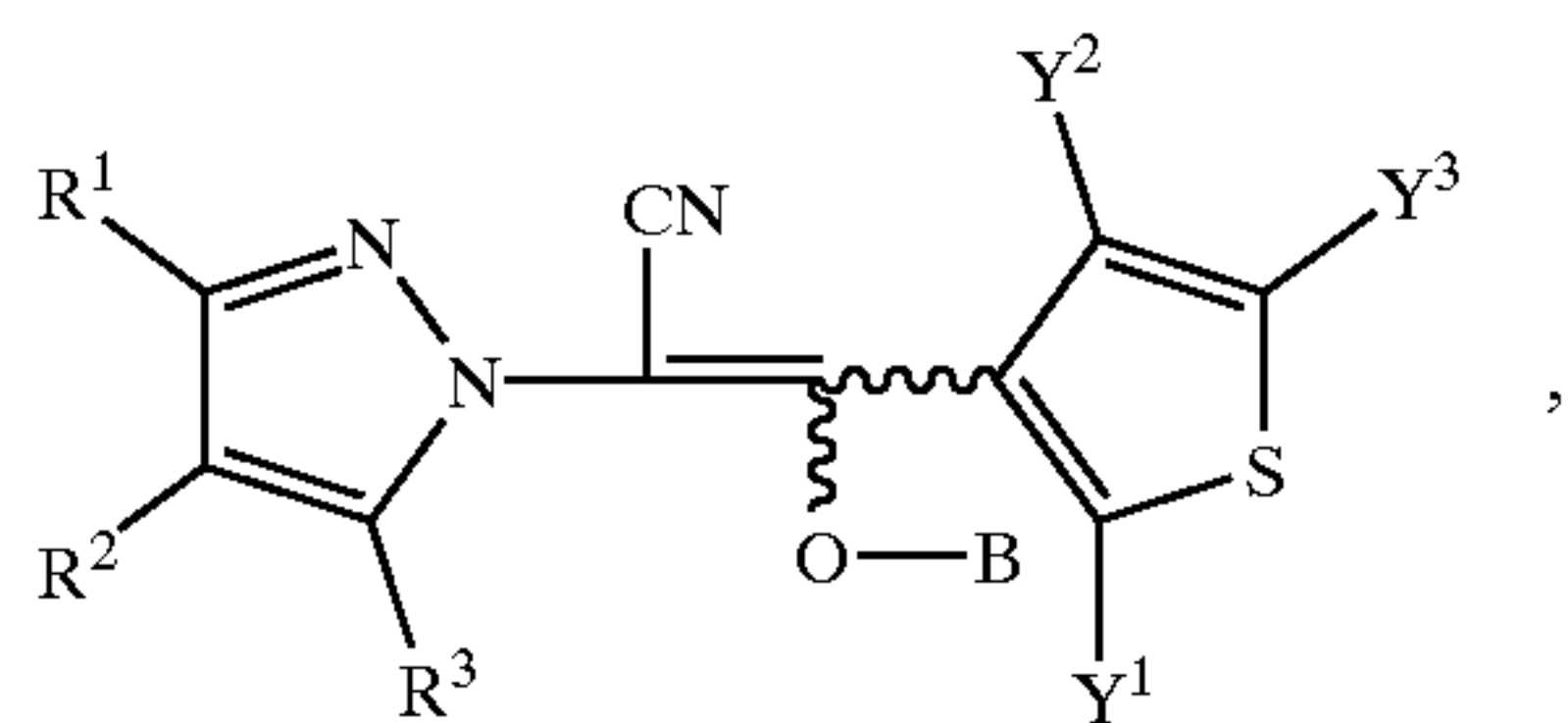
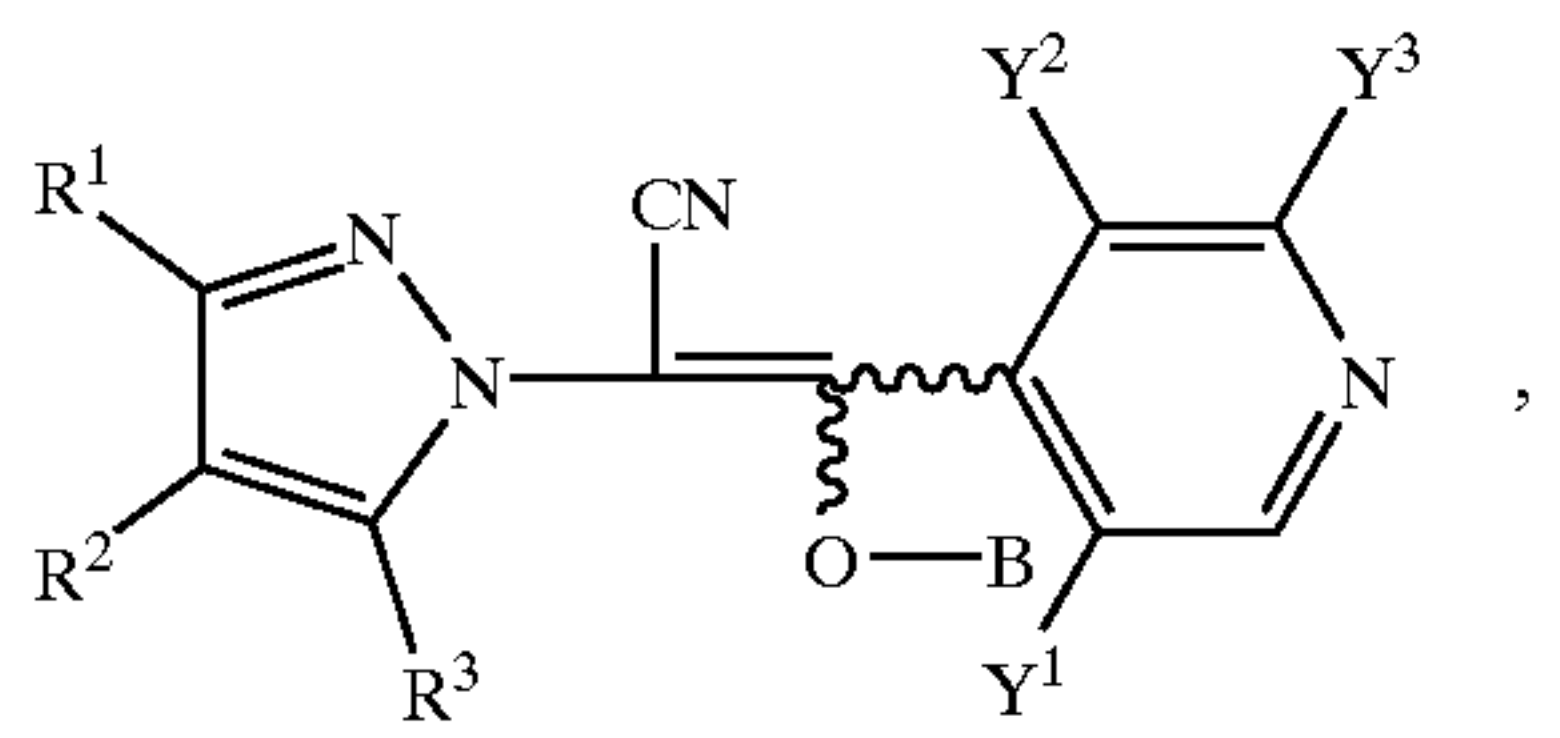
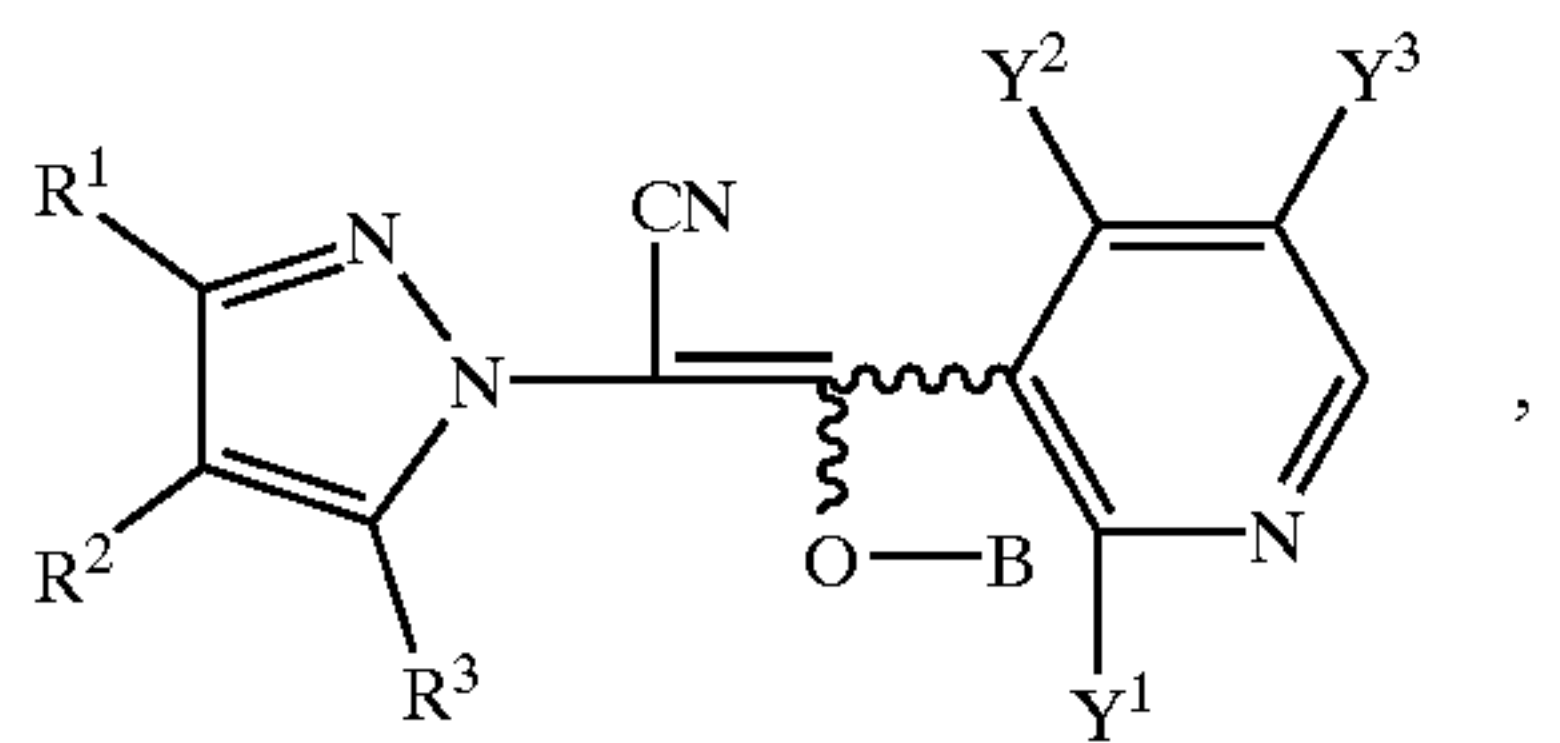
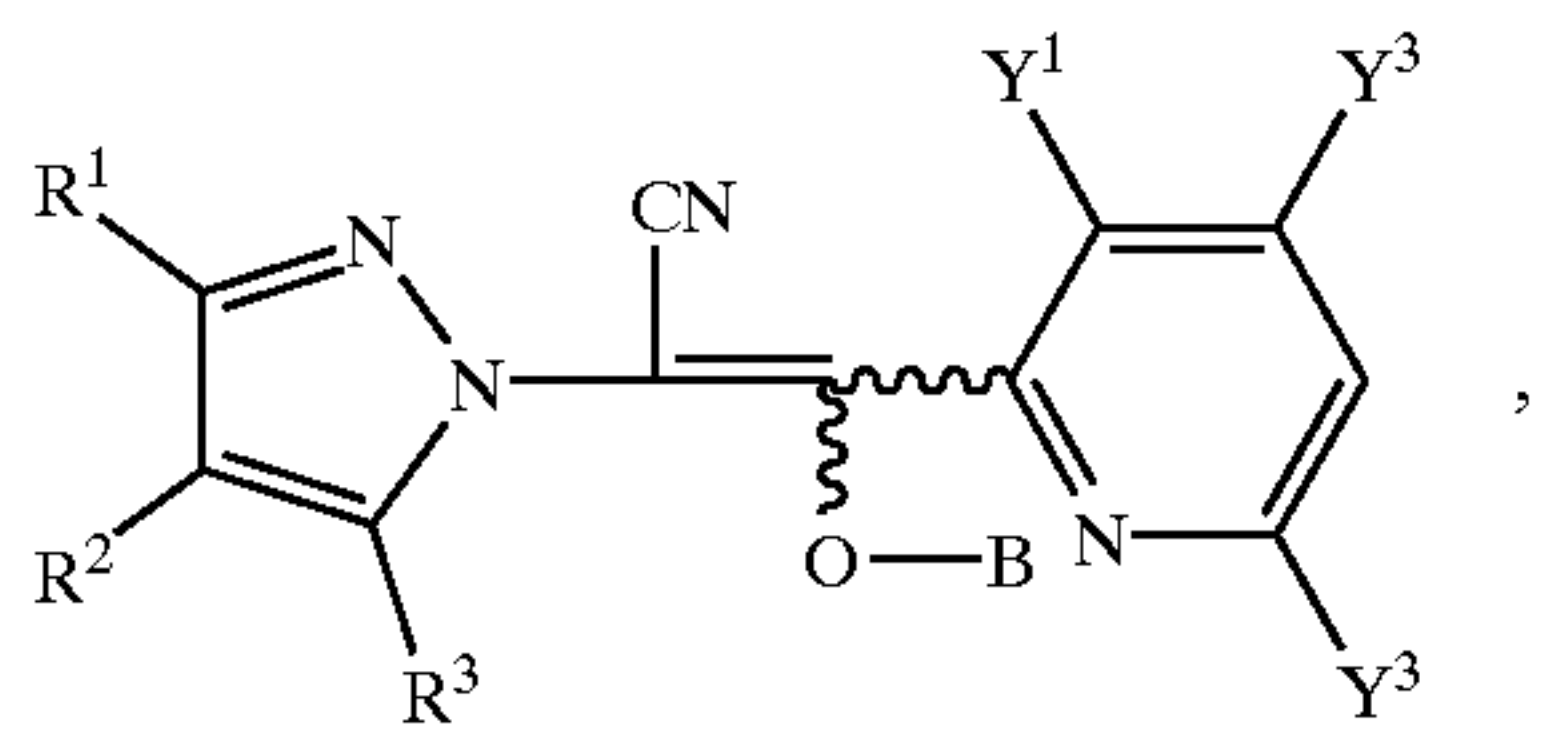
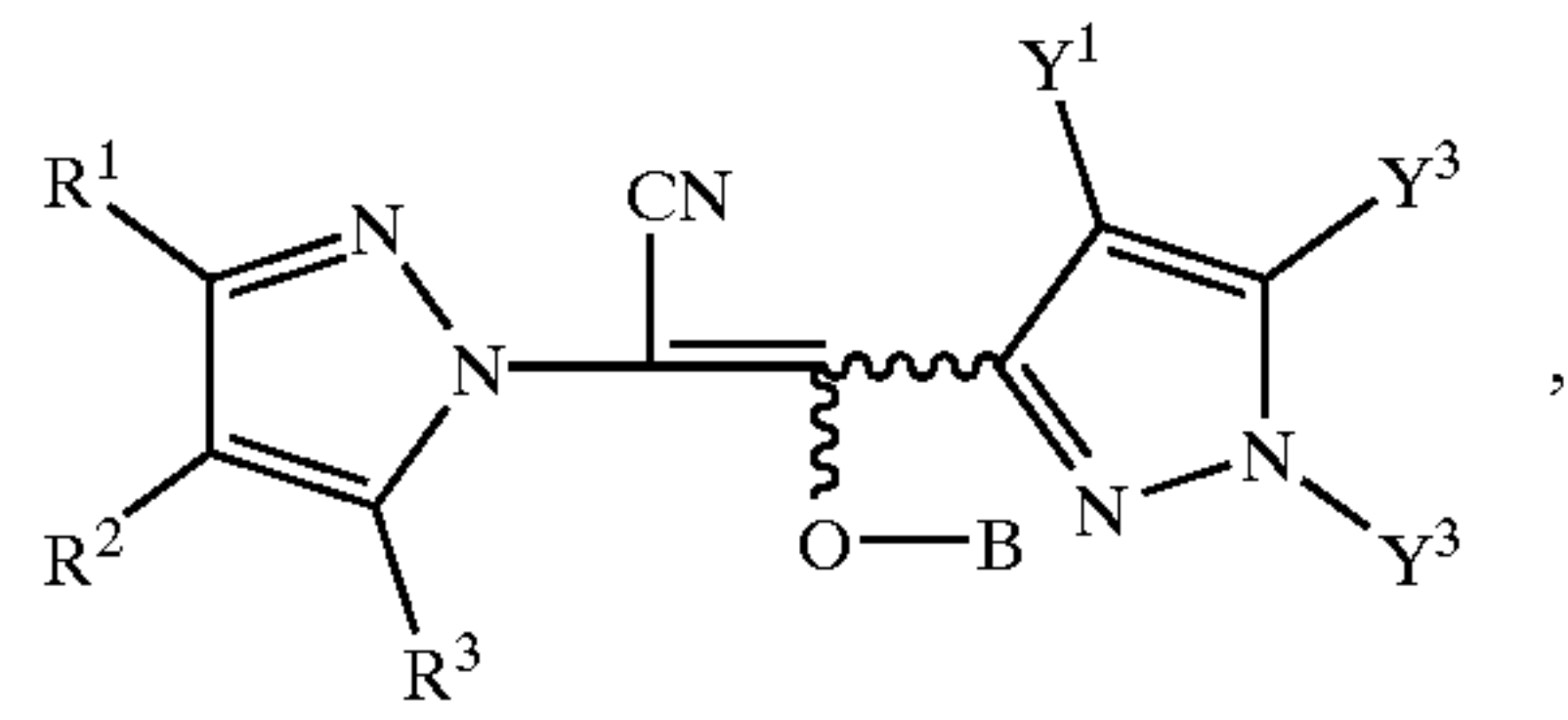

TABLE 1-continued

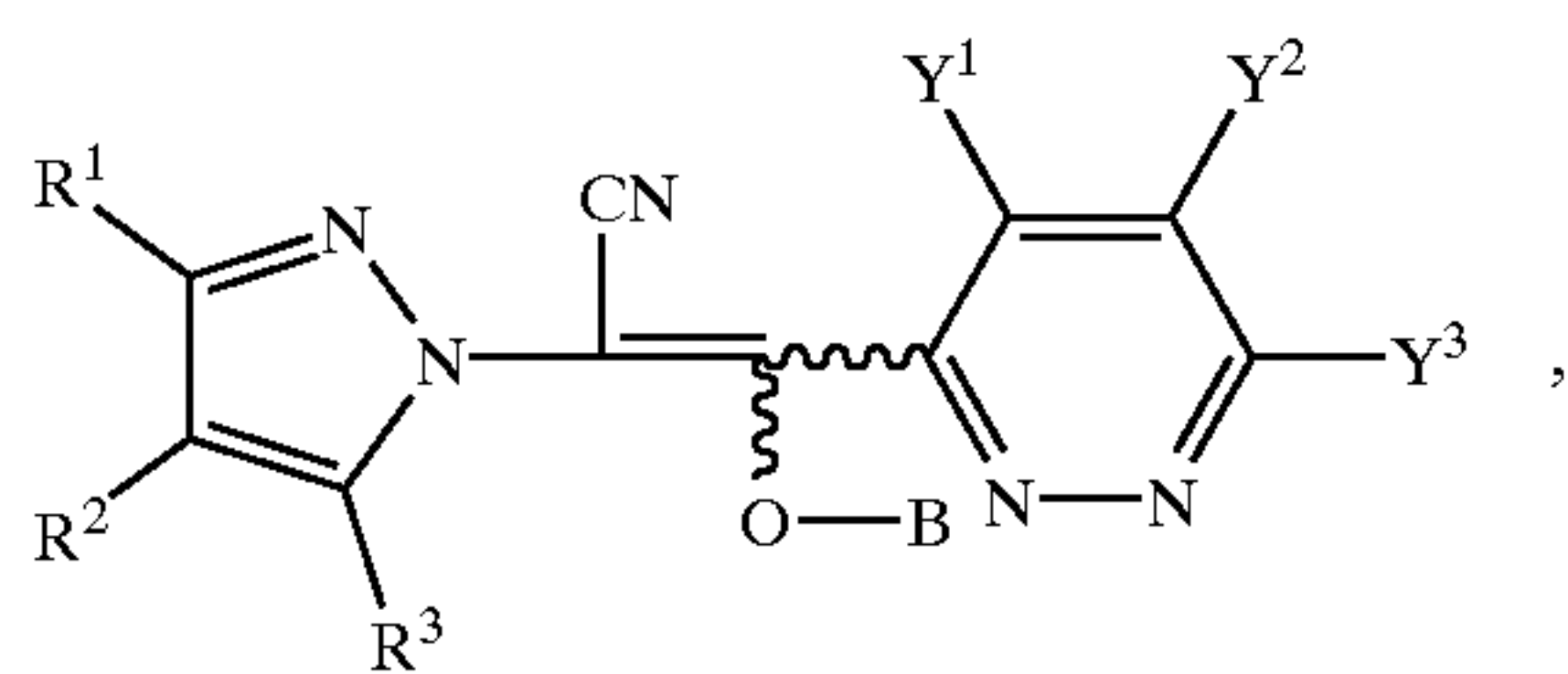
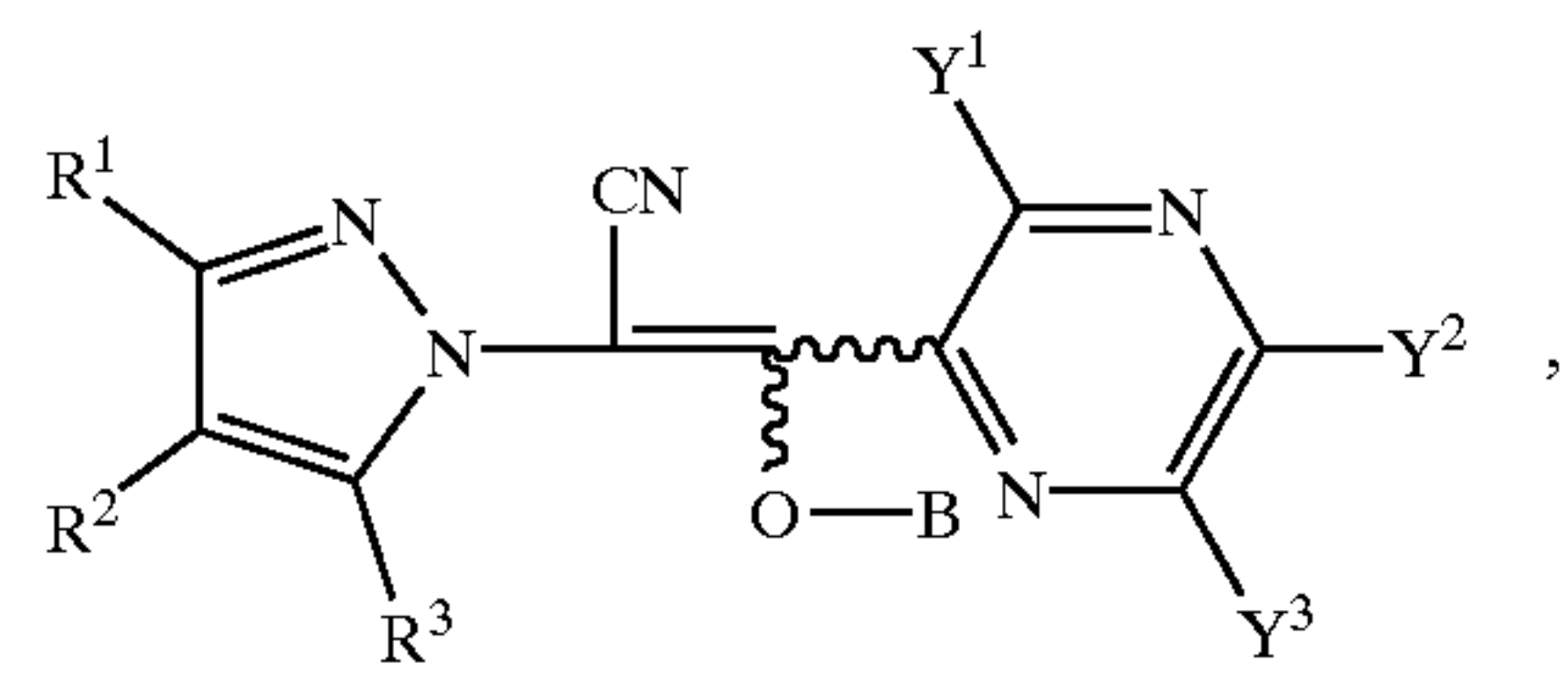
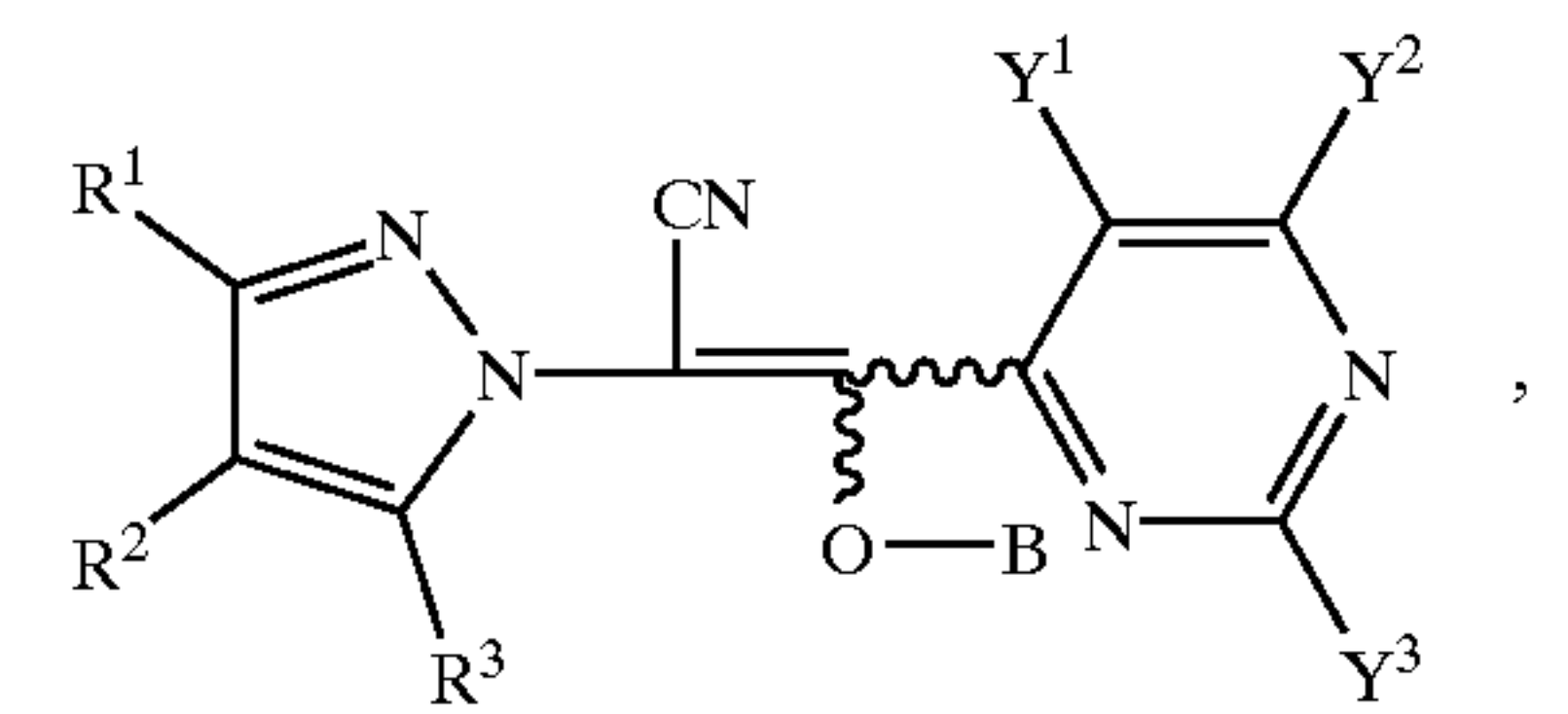
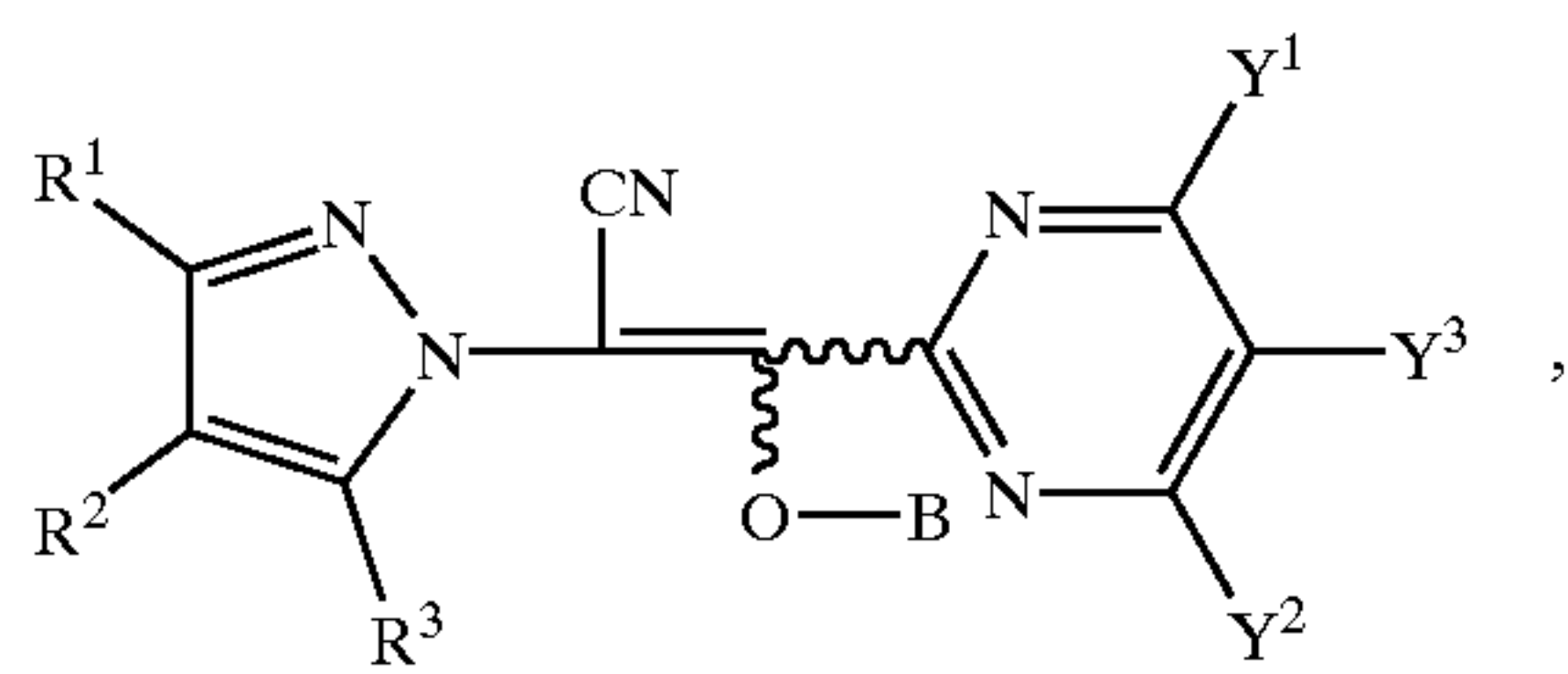
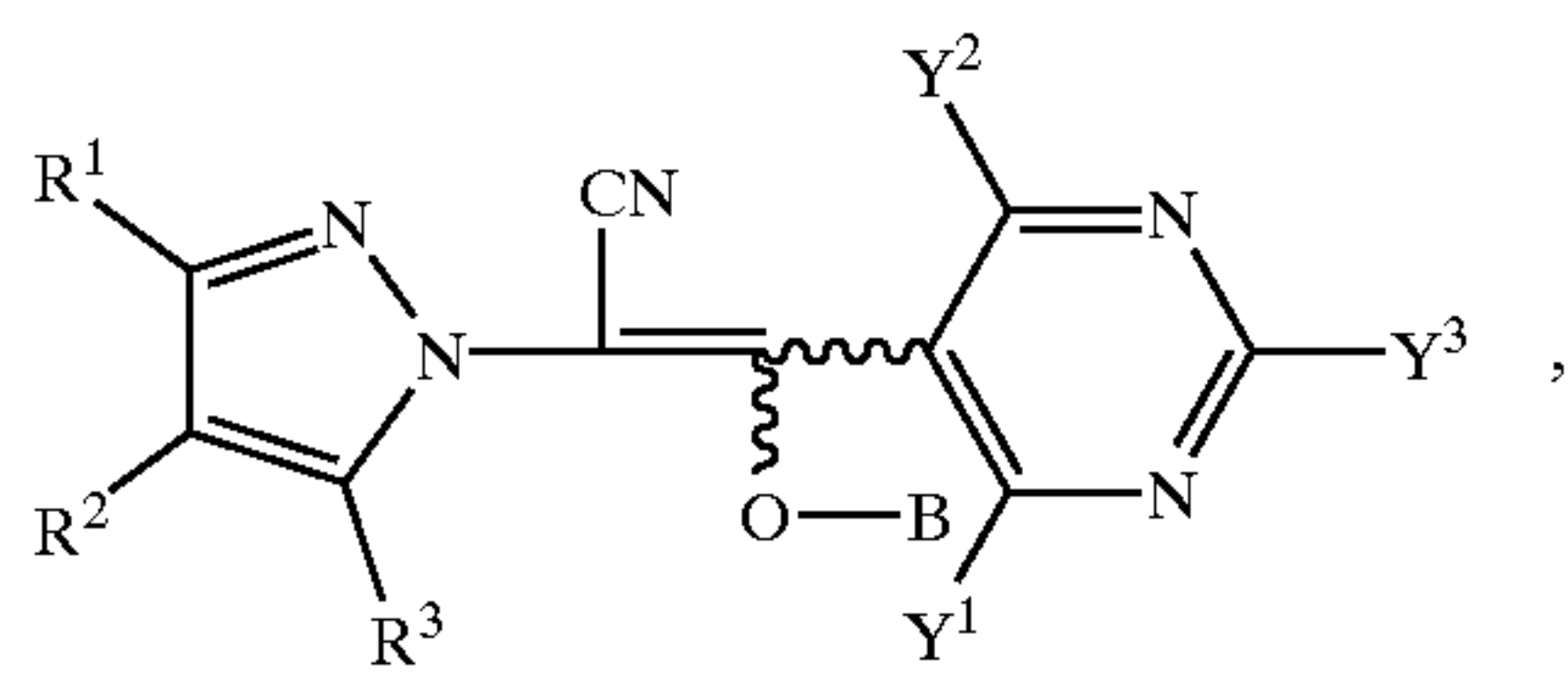
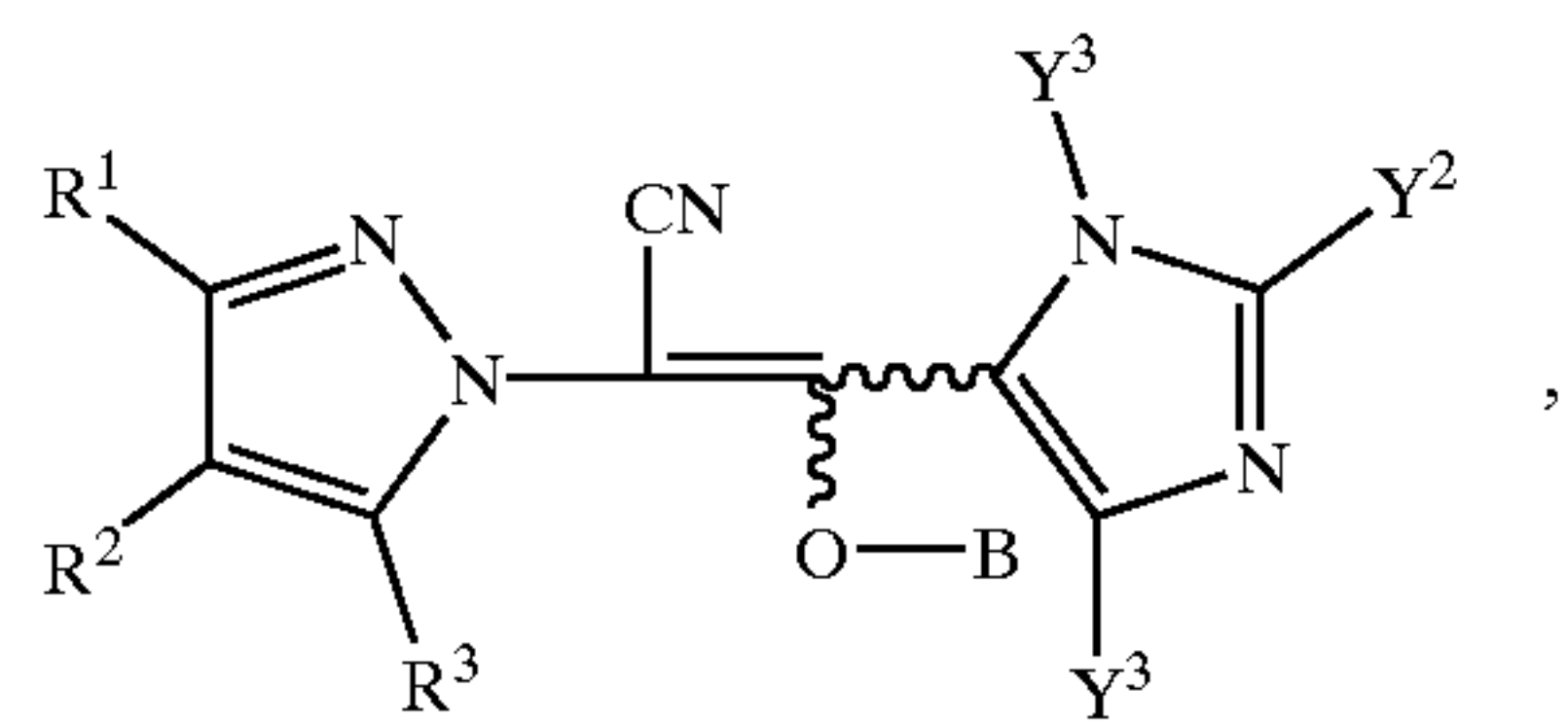
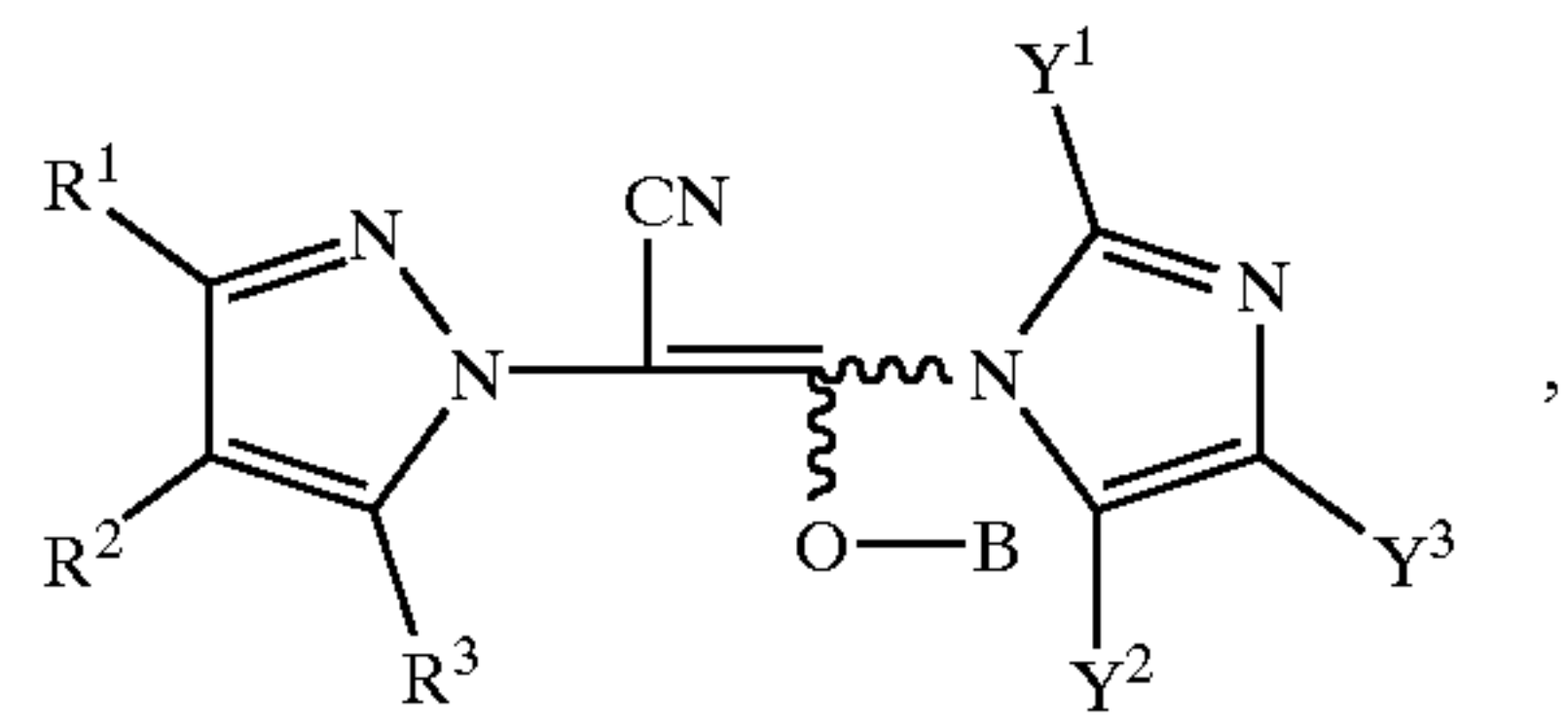
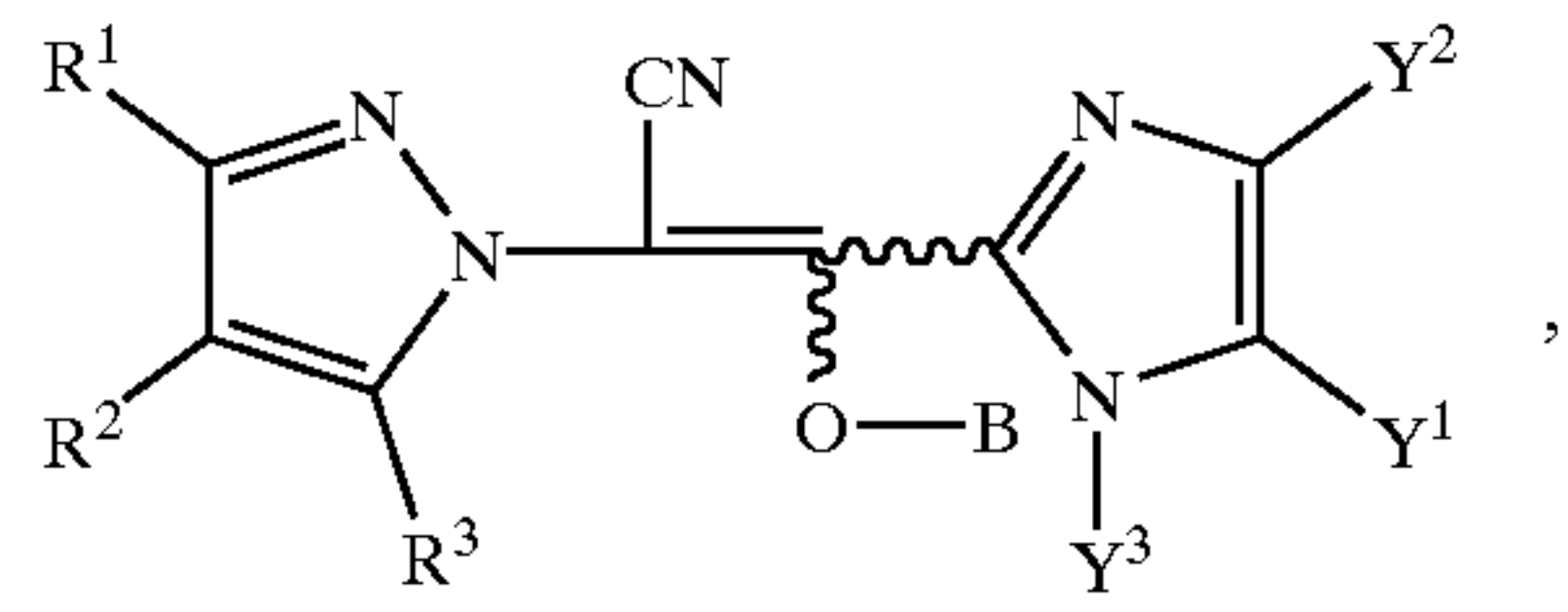

TABLE 1-continued

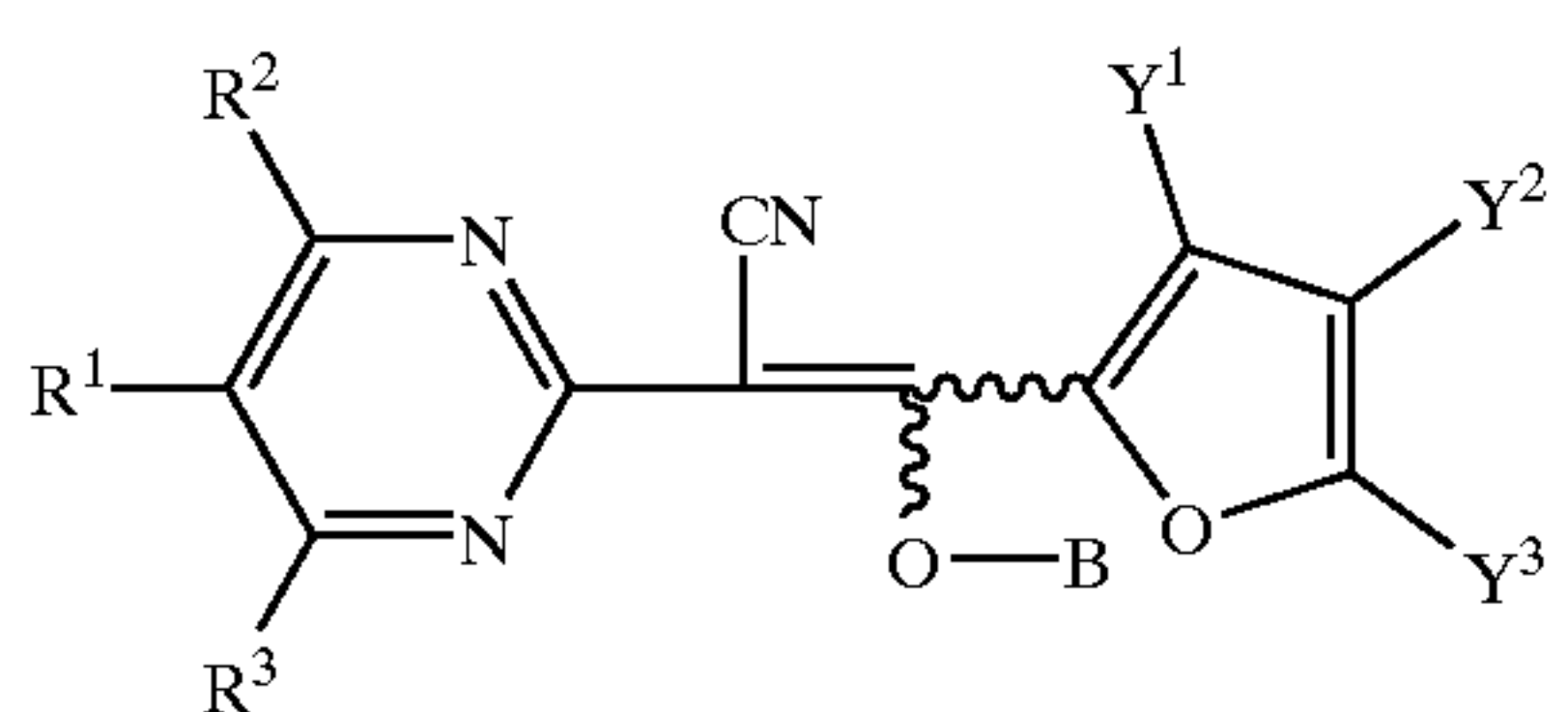
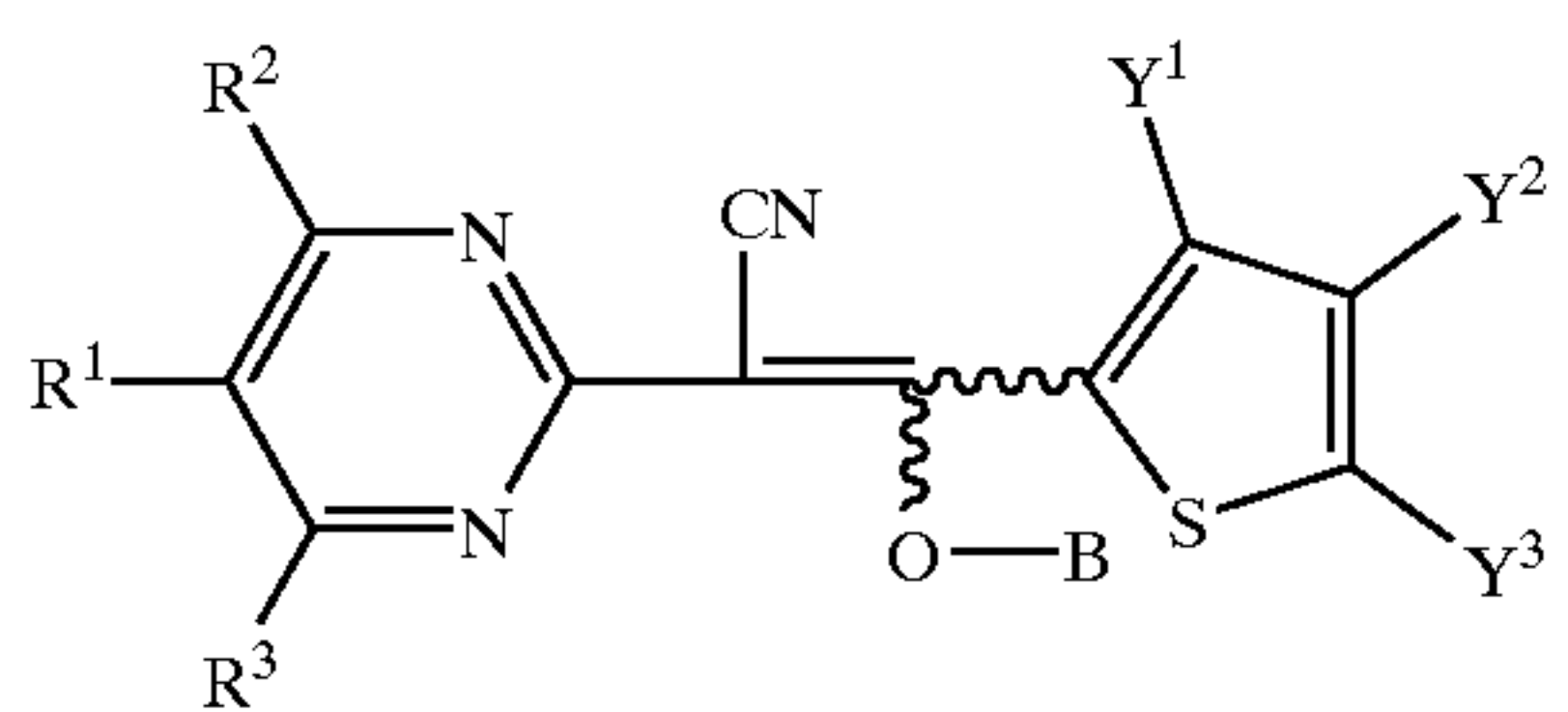
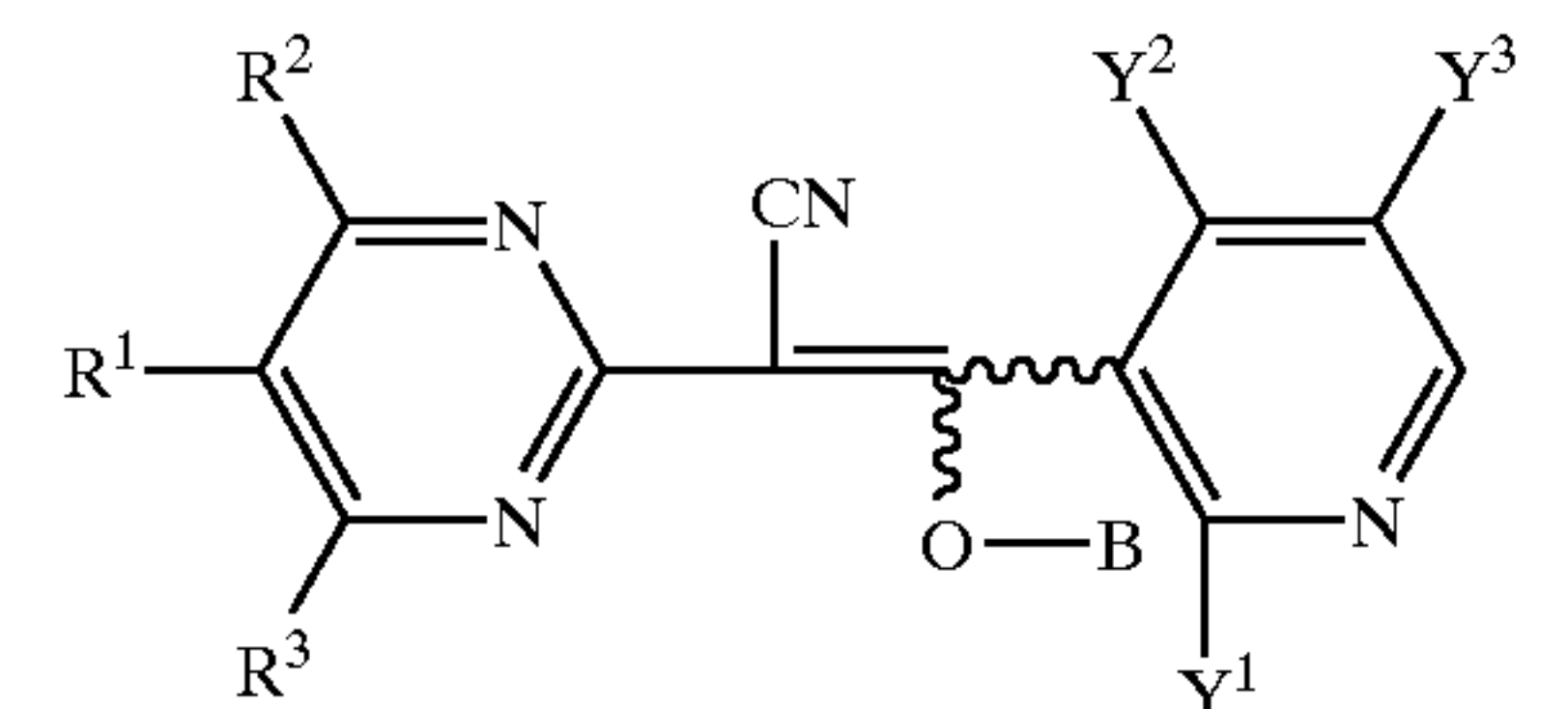
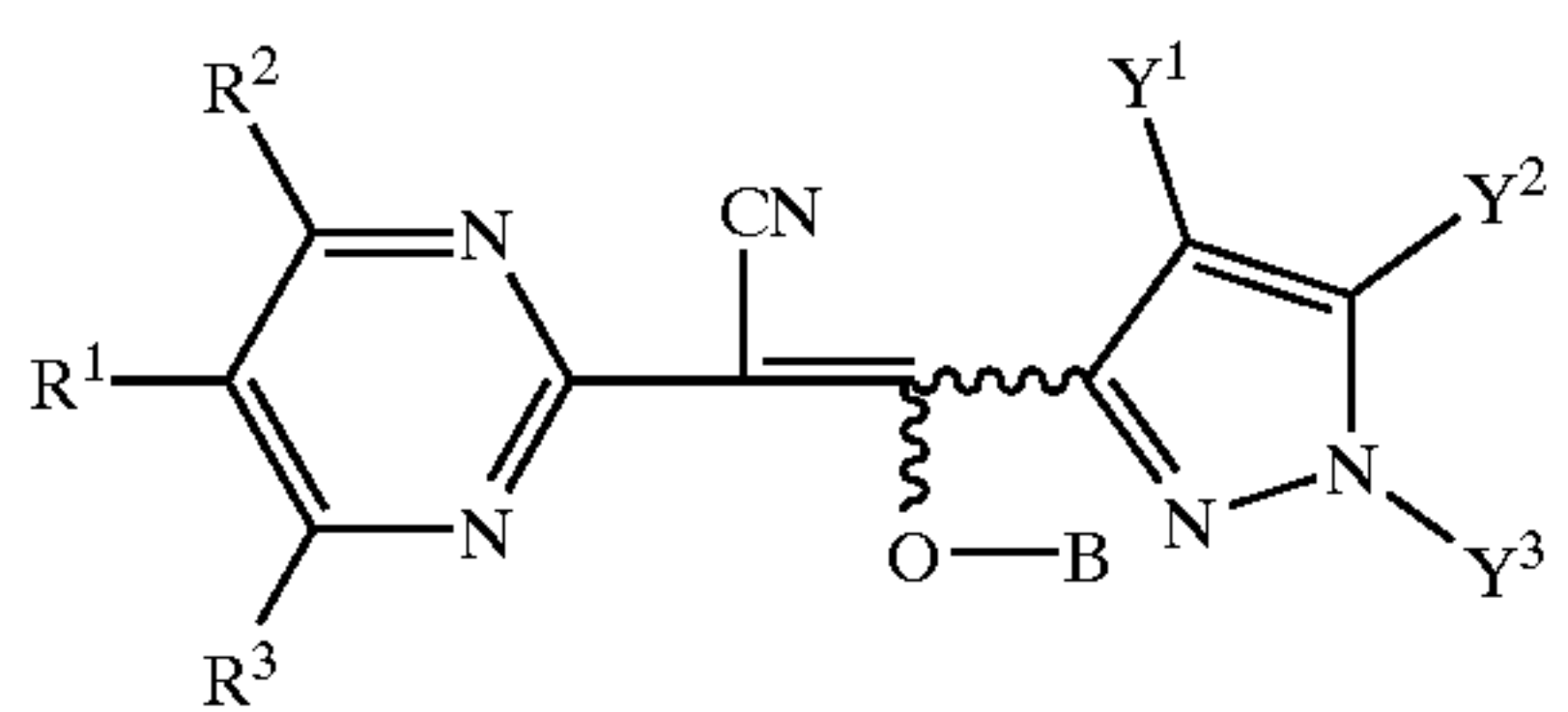
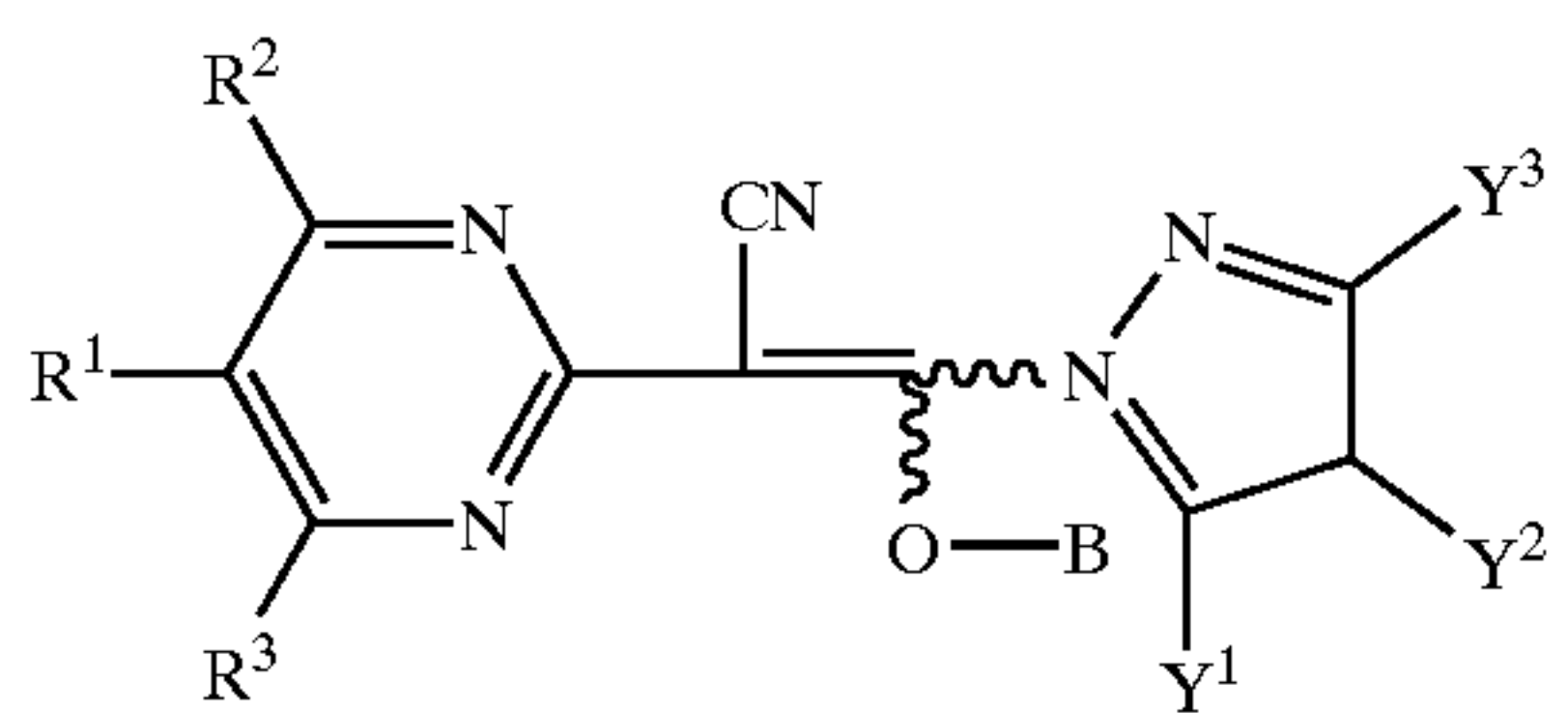
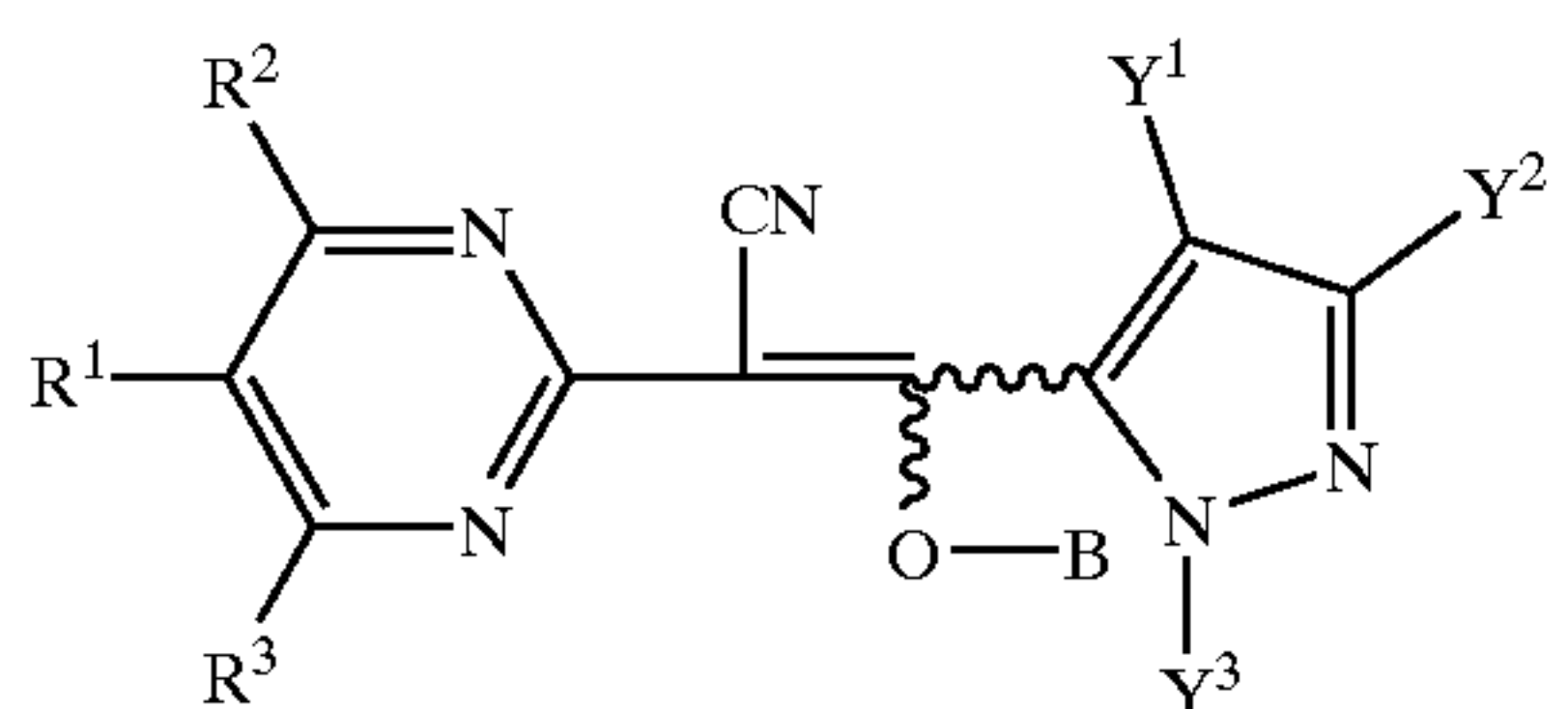
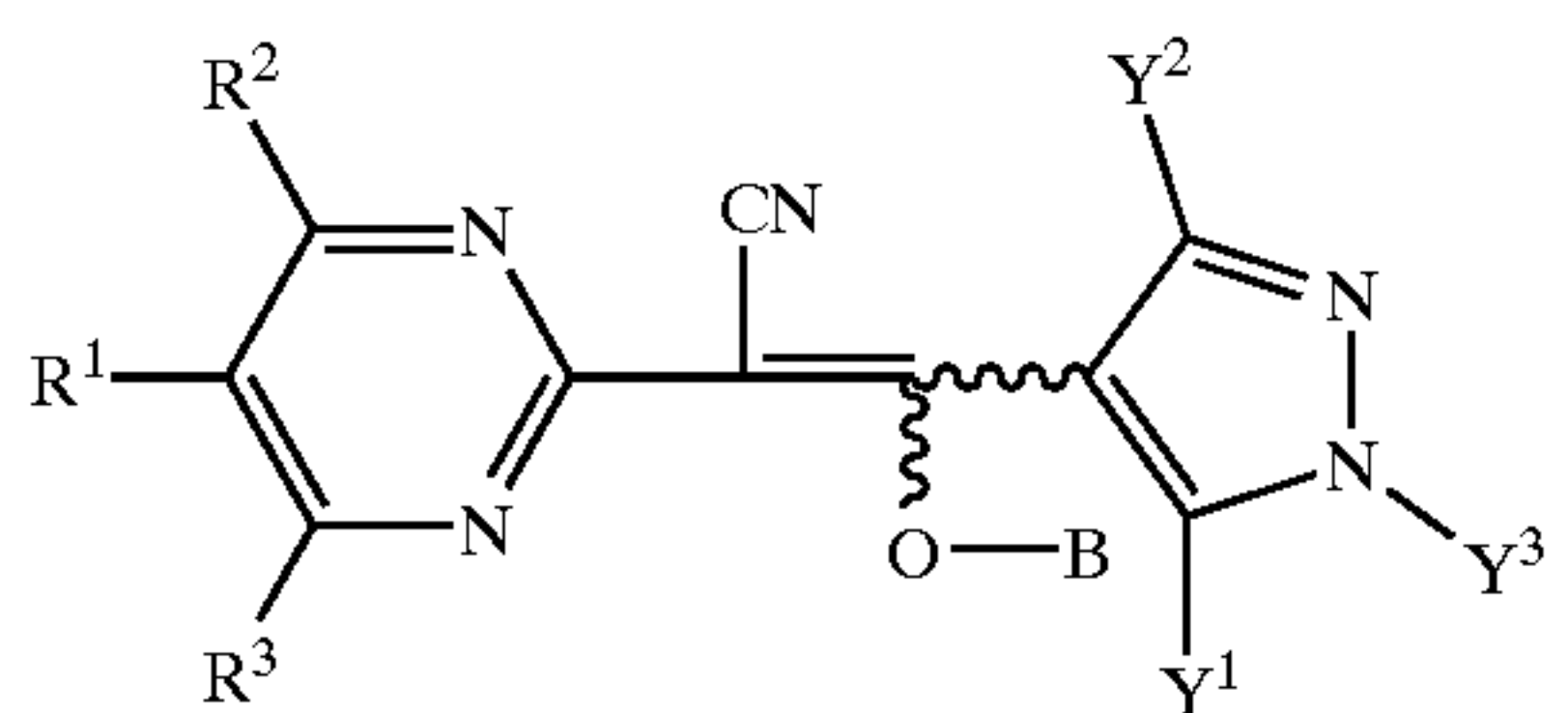
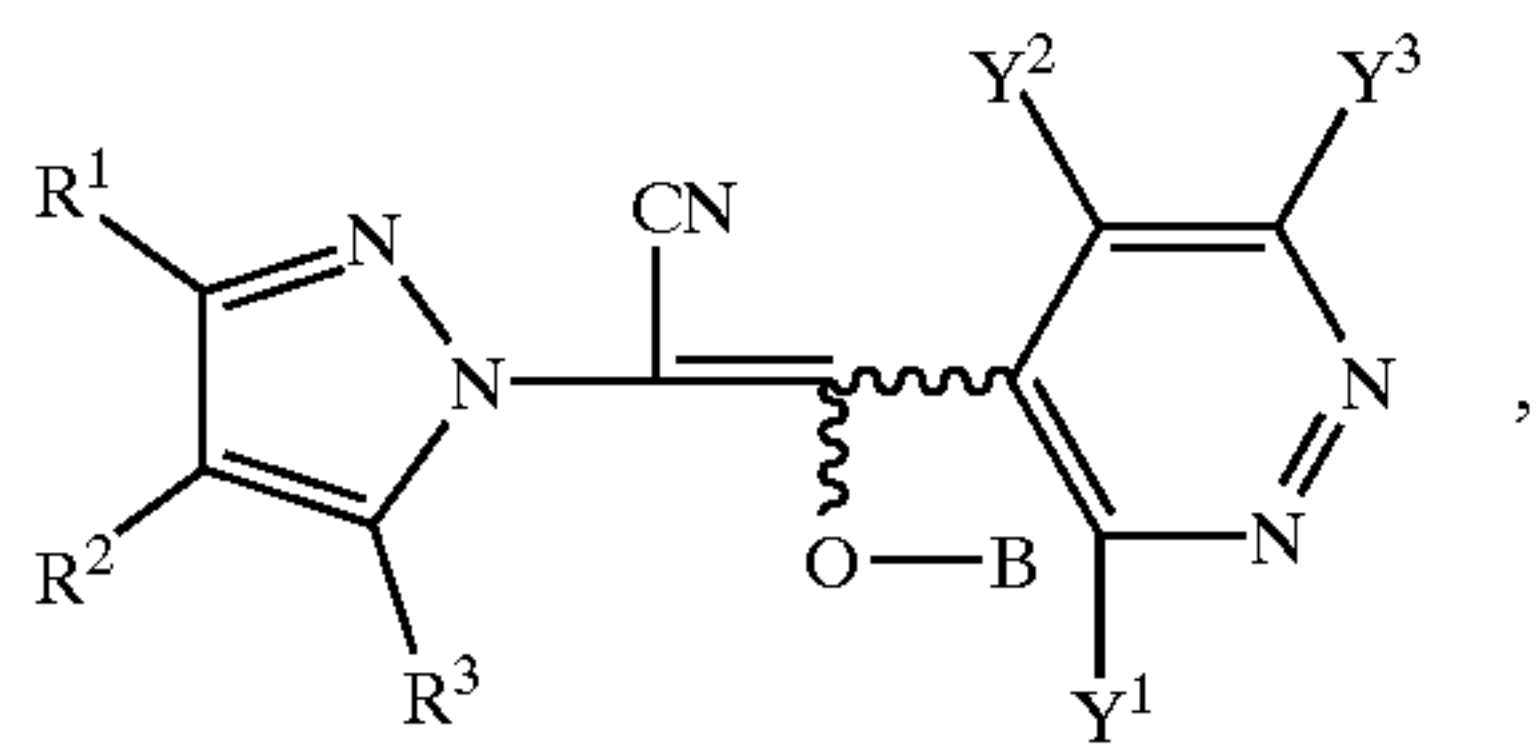

TABLE 1-continued

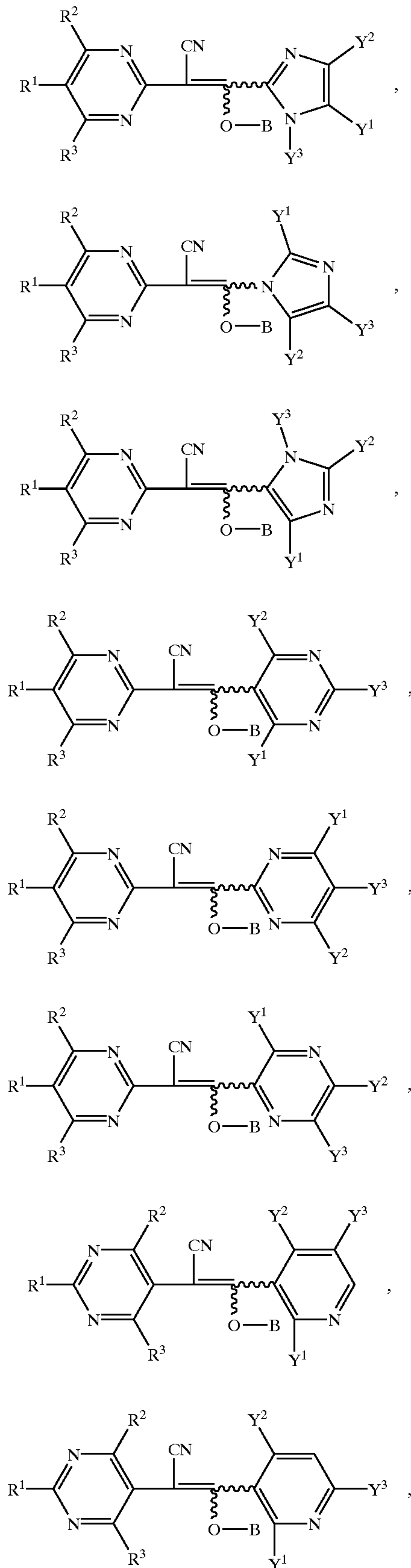
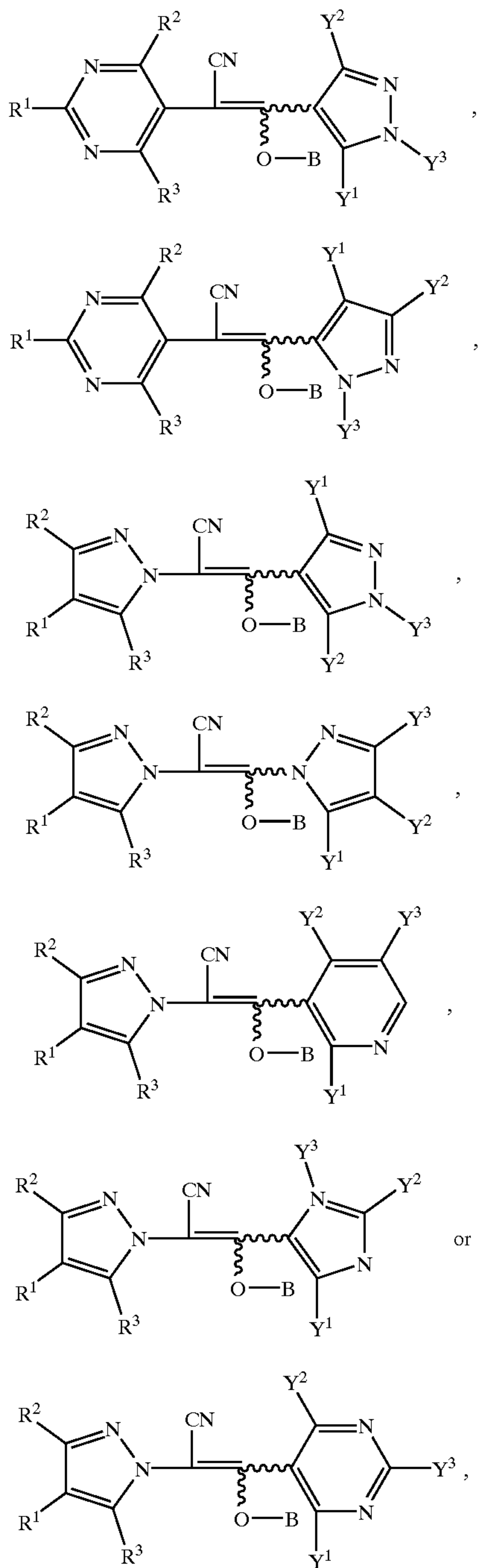

TABLE 1-continued



R ¹	R ²	R ³	B	Y ¹	Y ²	Y ³
2,6-F ₂ -Ph	H	H	H	H	H	H
2,6-F ₂ -Ph	H	H	H	H	Cl	H
2,6-F ₂ -Ph	H	H	H	H	Me	H
2,6-F ₂ -Ph	H	H	H	H	OMe	H
2,6-F ₂ -Ph	H	H	H	H	SMe	H
2,6-F ₂ -Ph	H	H	H	H	OCF ₃	H
2,6-F ₂ -Ph	H	H	H	H	CF ₃	H
2,6-F ₂ -Ph	H	H	H	H	CO ₂ Me	H
2,6-F ₂ -Ph	H	H	H	H	H	Me
2,6-F ₂ -Ph	H	H	H	Me	H	Me
2,6-F ₂ -Ph	H	H	H	Me	H	CF ₃
2,6-F ₂ -Ph	H	H	H	Me	H	H

TABLE 1-continued

2,6-F ₂ -Ph	H	H	H	Me	Me	Me
2,6-F ₂ -Ph	H	H	H	Me	Me	H
2,6-F ₂ -Ph	H	H	H	Me	Cl	Me
2,6-F ₂ -Ph	H	H	H	Me	Cl	H
2,6-F ₂ -Ph	Cl	H	H	Me	Cl	Me
2,6-F ₂ -Ph	H	H	H	Et	Me	Me
2,6-F ₂ -Ph	H	H	H	Et	H	H
2,6-F ₂ -Ph	H	H	H	nPr	Me	Me
2,6-F ₂ -Ph	H	H	H	iPr	Me	Me
2,6-F ₂ -Ph	H	H	H	iPr	Cl	Me
2,6-F ₂ -Ph	H	H	H	nBu	Me	Me
2,6-F ₂ -Ph	H	H	H	tBu	Me	Me
2,6-F ₂ -Ph	H	H	H	Cl	Me	Me
2,6-F ₂ -Ph	H	H	H	Cl	Me	H
2,6-F ₂ -Ph	H	H	H	Cl	H	Me
2,6-F ₂ -Ph	H	H	H	Cl	H	CF ₃
2,6-F ₂ -Ph	H	H	H	Cl	H	H
2,6-F ₂ -Ph	Me	H	H	Cl	H	H
2,6-F ₂ -Ph	Cl	H	H	Cl	H	H
2,6-F ₂ -Ph	NO ₂	H	H	Cl	H	H
2,6-F ₂ -Ph	CO ₂ Me	H	H	Cl	H	H
2,6-F ₂ -Ph	CO ₂ Et	H	H	Cl	H	H
2,6-F ₂ -Ph	H	H	H	Cl	Cl	Me
2,6-F ₂ -Ph	Me	H	H	Cl	Cl	Me
2,6-F ₂ -Ph	H	Me	H	Cl	Cl	Me
2,6-F ₂ -Ph	H	Cl	H	Cl	Cl	Me
2,6-F ₂ -Ph	Cl	H	H	Cl	Cl	Me
2,6-F ₂ -Ph	Cl	Cl	H	Cl	Cl	Me
2,6-F ₂ -Ph	Cl	Cl	B1	Cl	Cl	Me
2,6-F ₂ -Ph	Ph	H	H	Cl	Cl	Me
2,6-F ₂ -Ph	H	Ph	H	Cl	Cl	Me
2,6-F ₂ -Ph	CF ₃	H	H	Cl	Cl	Me
2,6-F ₂ -Ph	H	CF ₃	H	Cl	Cl	Me
2,6-F ₂ -Ph	cPr	H	H	Cl	Cl	Me
2,6-F ₂ -Ph	H	cPr	H	Cl	Cl	Me
2,6-F ₂ -Ph	OMe	H	H	Cl	Cl	Me
2,6-F ₂ -Ph	H	OMe	H	Cl	Cl	Me
2,6-F ₂ -Ph	NH ₂	H	H	Cl	Cl	Me
2,6-F ₂ -Ph	H	NH ₂	H	Cl	Cl	Me
2,6-F ₂ -Ph	NHMe	H	H	Cl	Cl	Me
2,6-F ₂ -Ph	H	NHMe	H	Cl	Cl	Me
2,6-F ₂ -Ph	NMe ₂	H	H	Cl	Cl	Me
2,6-F ₂ -Ph	H	NMe ₂	H	Cl	Cl	Me
2,6-F ₂ -Ph	NO ₂	H	H	Cl	Cl	Me
2,6-F ₂ -Ph	H	NO ₂	H	Cl	Cl	Me
2,6-F ₂ -Ph	CN	H	H	Cl	Cl	Me
2,6-F ₂ -Ph	H	CN	H	Cl	Cl	Me
2,6-F ₂ -Ph	OH	H	H	Cl	Cl	Me
2,6-F ₂ -Ph	H	OH	H	Cl	Cl	Me
2,6-F ₂ -Ph	CO ₂ Me	H	H	Cl	Cl	Me
2,6-F ₂ -Ph	H	CO ₂ Me	H	Cl	Cl	Me
2,6-F ₂ -Ph	CO ₂ Et	H	H	Cl	Cl	Me
2,6-F ₂ -Ph	H	H	H	Cl	Cl	H
2,6-F ₂ -Ph	H	H	H	Cl	Cl	CF ₃
2,6-F ₂ -Ph	H	H	H	Cl	Cl	CF ₂ H
2,6-F ₂ -Ph	H	H	H	Cl	Cl	CH ₂ OMe
2,6-F ₂ -Ph	H	H	H	Cl	Cl	COMe
2,6-F ₂ -Ph	H	H	H	Cl	Cl	Ph
2,6-F ₂ -Ph	H	H	H	Cl	Cl	CH ₂ Ph
2,6-F ₂ -Ph	H	H	H	Cl	CF ₃	Me
2,6-F ₂ -Ph	H	H	H	Br	Me	Me
2,6-F ₂ -Ph	H	H	H	Me	Br	Me
2,6-F ₂ -Ph	H	H	H	Me	Br	H
2,6-F ₂ -Ph	H	H	H	Br	H	H
2,6-F ₂ -Ph	H	H	H	OMe	Me	Me
2,6-F ₂ -Ph	H	H	H	Me	OMe	Me
2,6-F ₂ -Ph	H	H	H	OMe	H	H
2,6-F ₂ -Ph	H	H	H	H	OMe	H
2,6-F ₂ -Ph	H	H	H	Cl	OMe	Me
2,6-F ₂ -Ph	H	H	H	OCF ₃	Me	Me
2,6-F ₂ -Ph	H	H	H	OCF ₃	Cl	Me
2,6-F ₂ -Ph	H	H	H	OCF ₃	H	H
2,6-F ₂ -Ph	H	H	H	Me	OCF ₃	Me
2,6-F ₂ -Ph	H	H	H	Cl	OCF ₃	Me
2,6-F ₂ -Ph	H	H	H	SMe	Cl	Me
2,6-F ₂ -Ph	H	H	H	Me	SMe	Me
2,6-F ₂ -Ph	H	H	H	Cl	SMe	Me
2,6-F ₂ -Ph	H	H	H	SMe	H	H
2,6-F ₂ -Ph	H	H	H	SOMe	Cl	Me

TABLE 1-continued

2,6-F ₂ -Ph	H	H	H	Cl	SOMe	Me
2,6-F ₂ -Ph	H	H	H	SOMe	H	H
2,6-F ₂ -Ph	H	H	H	SO ₂ Me	Cl	Me
2,6-F ₂ -Ph	H	H	H	Cl	So ₂ Me	Me
2,6-F ₂ -Ph	H	H	H	SO ₂ Me	H	H
2,6-F ₂ -Ph	H	H	H	CF ₃	Me	Me
2,6-F ₂ -Ph	H	H	H	CF ₃	Cl	H
2,6-F ₂ -Ph	H	H	H	CF ₃	Cl	Me
2,6-F ₂ -Ph	Me	H	H	CF ₃	Cl	Me
2,6-F ₂ -Ph	Cl	H	H	CF ₃	Cl	Me
2,6-F ₂ -Ph	Br	H	H	CF ₃	Cl	Me
2,6-F ₂ -Ph	CF ₃	H	H	CF ₃	Cl	Me
2,6-F ₂ -Ph	NO ₂	H	H	CF ₃	Cl	Me
2,6-F ₂ -Ph	CN	H	H	CF ₃	Cl	Me
2,6-F ₂ -Ph	CO ₂ Me	H	H	CF ₃	Cl	Me
2,6-F ₂ -Ph	CO ₂ Et	H	H	CF ₃	Cl	Me
2,6-F ₂ -Ph	H	H	H	CF ₃	Cl	CF ₃
2,6-F ₂ -Ph	H	H	H	CF ₃	Cl	CF ₂ H
2,6-F ₂ -Ph	H	H	H	CF ₃	Cl	CH ₂ OMe
2,6-F ₂ -Ph	H	H	H	CF ₃	Cl	COCH ₃
2,6-F ₂ -Ph	H	H	H	CF ₃	H	Me
2,6-F ₂ -Ph	H	H	H	CF ₃	H	H
2,6-F ₂ -Ph	H	H	H	CF ₃	Br	Me
2,6-F ₂ -Ph	H	H	H	CF ₃	SMe	Me
2,6-F ₂ -Ph	H	H	H	CF ₃	SOMe	Me
2,6-F ₂ -Ph	H	H	H	CF ₃	SO ₂ Me	Me
2,6-F ₂ -Ph	H	H	H	CF ₃	CF ₃	Me
2,6-F ₂ -Ph	H	H	H	CF ₃	NO ₂	Me
2,6-F ₂ -Ph	H	H	H	CF ₃	CN	Me
2,6-F ₂ -Ph	H	H	H	CF ₃	NHMe	Me
2,6-F ₂ -Ph	H	H	H	CF ₃	NMe ₂	Me
2,6-F ₂ -Ph	H	H	H	CF ₃	Ph	Me
2,6-F ₂ -Ph	H	H	H	CF ₃	CH ₂ Ph	Me
2,6-F ₂ -Ph	H	H	H	CF ₃	OPh	Me
2,6-F ₂ -Ph	H	H	H	CF ₃	OH	Me
2,6-F ₂ -Ph	H	H	H	CF ₃	CO ₂ Me	Me
2,6-F ₂ -Ph	H	H	H	CF ₃	OMe	Me
2,6-F ₂ -Ph	H	H	H	CF ₃	OCF ₃	Me
2,6-F ₂ -Ph	H	H	H	CF ₃	OCF ₂ H	Me
2,6-F ₂ -Ph	H	H	H	CF ₃	OCF ₂ H	CF ₂ H
2,6-F ₂ -Ph	H	H	H	NO ₂	CF ₃	Me
2,6-F ₂ -Ph	H	H	H	NO ₂	Cl	Me
2,6-F ₂ -Ph	H	H	H	NO ₂	Me	Me
2,6-F ₂ -Ph	H	H	H	NO ₂	H	H
2,6-F ₂ -Ph	H	H	H	Cl	NO ₂	Me
2,6-F ₂ -Ph	H	H	H	CN	CF ₃	Me
2,6-F ₂ -Ph	H	H	H	CN	Cl	Me
2,6-F ₂ -Ph	H	H	H	CN	Me	Me
2,6-F ₂ -Ph	H	H	H	CN	H	H
2,6-F ₂ -Ph	H	H	H	Cl	CN	Me
2,6-F ₂ -Ph	H	H	H	Br	CN	Me
2,6-F ₂ -Ph	H	H	H	NHMe	Me	Me
2,6-F ₂ -Ph	H	H	H	NHMe	Cl	Me
2,6-F ₂ -Ph	H	H	H	NHMe	H	H
2,6-F ₂ -Ph	H	H	H	Cl	NHMe	Me
2,6-F ₂ -Ph	H	H	H	NMe ₂	Me	Me
2,6-F ₂ -Ph	H	H	H	NMe ₂	Cl	Me
2,6-F ₂ -Ph	H	H	H	NMe ₂	H	H
2,6-F ₂ -Ph	H	H	H	Cl	NMe ₂	Me
2,6-F ₂ -Ph	H	H	H	Ph	Cl	Me
2,6-F ₂ -Ph	H	H	H	Ph	H	H
2,6-F ₂ -Ph	H	H	H	Cl	Ph	Me
2,6-F ₂ -Ph	H	H	H	CH ₂ Ph	Me	Me
2,6-F ₂ -Ph	H	H	H	CH ₂ Ph	H	H
2,6-F ₂ -Ph	H	H	H	Cl	CH ₂ Ph	Me
2,6-F ₂ -Ph	H	H	H	OPh	H	H
2,6-F ₂ -Ph	H	H	H	Cl	OPh	Me
2,6-F ₂ -Ph	H	H	H	OH	Me	Me
2,6-F ₂ -Ph	H	H	H	OH	H	H
2,6-F ₂ -Ph	H	H	H	Cl	OH	Me
2,6-F ₂ -Ph	H	H	H	CO ₂ Me	Me	Me
2,6-F ₂ -Ph	H	H	H	CO ₂ Me	Cl	Me
2,6-F ₂ -Ph	H	H	H	CO ₂ Me	H	H
2,6-F ₂ -Ph	H	H	H	cPr	Me	Me
2,6-F ₂ -Ph	H	H	H	cPr	Cl	Me
2,6-F ₂ -Ph	H	H	B1	Cl	Cl	Me
2,6-F ₂ -Ph	Cl	H	B1	Cl	Cl	Me
2,6-F ₂ -Ph	H	H	B2	Cl	Cl	Me
2,6-F ₂ -Ph	H	H	B3	Cl	Cl	Me

TABLE 1-continued

2,6-F ₂ -Ph	H	H	B4	Cl	Cl	Me
2,6-F ₂ -Ph	Cl	H	B4	Cl	Cl	Me
2,6-F ₂ -Ph	Cl	Me	B4	Cl	Cl	Me
2,6-F ₂ -Ph	NO ₂	H	B4	Cl	Cl	Me
2,6-F ₂ -Ph	CO ₂ Me	H	B4	Cl	Cl	Me
2,6-F ₂ -Ph	CO ₂ Et	H	B4	Cl	Cl	Me
2,6-F ₂ -Ph	H	H	B5	Cl	Cl	Me
2,6-F ₂ -Ph	Cl	H	B5	Cl	Cl	Me
2,6-F ₂ -Ph	H	H	B6	Cl	Cl	Me
2,6-F ₂ -Ph	Cl	H	B6	Cl	Cl	Me
2,6-F ₂ -Ph	NO ₂	H	B6	Cl	Cl	Me
2,6-F ₂ -Ph	CO ₂ Me	H	B6	Cl	Cl	Me
2,6-F ₂ -Ph	CO ₂ Et	H	B6	Cl	Cl	Me
2,6-F ₂ -Ph	H	H	B7	Cl	Cl	Me
2,6-F ₂ -Ph	Cl	H	B7	Cl	Cl	Me
2,6-F ₂ -Ph	NO ₂	H	B7	Cl	Cl	Me
2,6-F ₂ -Ph	CO ₂ Me	H	B7	Cl	Cl	Me
2,6-F ₂ -Ph	CO ₂ Et	H	B7	Cl	Cl	Me
2,6-F ₂ -Ph	H	H	B8	Cl	Cl	Me
2,6-F ₂ -Ph	H	H	B9	Cl	Cl	Me
2,6-F ₂ -Ph	H	H	B10	Cl	Cl	Me
2,6-F ₂ -Ph	H	H	B11	Cl	Cl	Me
2,6-F ₂ -Ph	H	H	B12	Cl	Cl	Me
2,6-F ₂ -Ph	H	H	B13	Cl	Cl	Me
2,6-F ₂ -Ph	H	H	B14	Cl	Cl	Me
2,6-F ₂ -Ph	H	H	B15	Cl	Cl	Me
2,6-F ₂ -Ph	H	H	B16	Cl	Cl	Me
2,6-F ₂ -Ph	H	H	B17	Cl	Cl	Me
2,6-F ₂ -Ph	H	H	B18	Cl	Cl	Me
2,6-F ₂ -Ph	H	H	B19	Cl	Cl	Me
2,6-F ₂ -Ph	H	H	B20	Cl	Cl	Me
2,6-F ₂ -Ph	H	H	B21	Cl	Cl	Me
2,6-F ₂ -Ph	H	H	B22	Cl	Cl	Me
2,6-F ₂ -Ph	H	H	B23	Cl	Cl	Me
2,6-F ₂ -Ph	H	H	B24	Cl	Cl	Me
2,6-F ₂ -Ph	H	H	B25	Cl	Cl	Me
2,6-F ₂ -Ph	H	H	B26	Cl	Cl	Me
2,6-F ₂ -Ph	H	H	B27	Cl	Cl	Me
2,6-F ₂ -Ph	H	H	B28	Cl	Cl	Me
2,6-F ₂ -Ph	H	H	B29	Cl	Cl	Me
2,6-F ₂ -Ph	H	H	B30	Cl	Cl	Me
2,6-F ₂ -Ph	H	H	B31	Cl	Cl	Me
2,6-F ₂ -Ph	H	H	B32	Cl	Cl	Me
2,6-F ₂ -Ph	H	H	B33	Cl	Cl	Me
2,6-F ₂ -Ph	H	H	B34	Cl	Cl	Me
2,6-F ₂ -Ph	H	H	Na	Cl	Cl	Me
2,6-F ₂ -Ph	H	H	K	Cl	Cl	Me
2,6-F ₂ -Ph	H	H	B1	CF ₃	Cl	Me
2,6-F ₂ -Ph	H	H	B2	CF ₃	Cl	Me
2,6-F ₂ -Ph	H	H	B3	CF ₃	Cl	Me
2,6-F ₂ -Ph	H	H	B4	CF ₃	Cl	Me
2,6-F ₂ -Ph	Me	H	B4	CF ₃	Cl	Me
2,6-F ₂ -Ph	Cl	H	B4	CF ₃	Cl	Me
2,6-F ₂ -Ph	NO ₂	H	B4	CF ₃	Cl	Me
2,6-F ₂ -Ph	CO ₂ Me	H	B4	CF ₃	Cl	Me
2,6-F ₂ -Ph	CO ₂ Et	H	B4	CF ₃	Cl	Me
2,6-F ₂ -Ph	H	H	B5	CF ₃	Cl	Me
2,6-F ₂ -Ph	Cl	H	B5	CF ₃	Cl	Me
2,6-F ₂ -Ph	H	H	B6	CF ₃	Cl	Me
2,6-F ₂ -Ph	Me	H	B6	CF ₃	Cl	Me
2,6-F ₂ -Ph	Cl	H	B6	CF ₃	Cl	Me
2,6-F ₂ -Ph	NO ₂	H	B6	CF ₃	Cl	Me
2,6-F ₂ -Ph	CO ₂ Me	H	B6	CF ₃	Cl	Me
2,6-F ₂ -Ph	CO ₂ Et	H	B6	CF ₃	Cl	Me
2,6-F ₂ -Ph	H	H	B7	CF ₃	Cl	Me
2,6-F ₂ -Ph	Me	H	B7	CF ₃	Cl	Me
2,6-F ₂ -Ph	Cl	H	B7	CF ₃	Cl	Me
2,6-F ₂ -Ph	NO ₂	H	B7	CF ₃	Cl	Me
2,6-F ₂ -Ph	CO ₂ Me	H	B7	CF ₃	Cl	Me
2,6-F ₂ -Ph	CO ₂ Et	H	B7	CF ₃	Cl	Me
2,6-F ₂ -Ph	H	H	B8	CF ₃	Cl	Me
2,6-F ₂ -Ph	H	H	B9	CF ₃	Cl	Me
2,6-F ₂ -Ph	H	H	B10	CF ₃	Cl	Me
2,6-F ₂ -Ph	H	H	B11	CF ₃	Cl	Me
2,6-F ₂ -Ph	H	H	B12	CF ₃	Cl	Me
2,6-F ₂ -Ph	H	H	B13	CF ₃	Cl	Me
2,6-F ₂ -Ph	H	H	B14	CF ₃	Cl	Me
2,6-F ₂ -Ph	H	H	B15	CF ₃	Cl	Me
2,6-F ₂ -Ph	H	H	B16	CF ₃	Cl	Me

TABLE 1-continued

2,6-F ₂ -Ph	H	H	B17	CF ₃	Cl	Me
2,6-F ₂ -Ph	H	H	B18	CF ₃	Cl	Me
2,6-F ₂ -Ph	H	H	B19	CF ₃	Cl	Me
2,6-F ₂ -Ph	H	H	B20	CF ₃	Cl	Me
2,6-F ₂ -Ph	H	H	B21	CF ₃	Cl	Me
2,6-F ₂ -Ph	H	H	B22	CF ₃	Cl	Me
2,6-F ₂ -Ph	H	H	B23	CF ₃	Cl	Me
2,6-F ₂ -Ph	H	H	B24	CF ₃	Cl	Me
2,6-F ₂ -Ph	H	H	B25	CF ₃	Cl	Me
2,6-F ₂ -Ph	H	H	B26	CF ₃	Cl	Me
2,6-F ₂ -Ph	H	H	B27	CF ₃	Cl	Me
2,6-F ₂ -Ph	H	H	B28	CF ₃	Cl	Me
2,6-F ₂ -Ph	H	H	B29	CF ₃	Cl	Me
2,6-F ₂ -Ph	H	H	B30	CF ₃	Cl	Me
2,6-F ₂ -Ph	H	H	B31	CF ₃	Cl	Me
2,6-F ₂ -Ph	H	H	B32	CF ₃	Cl	Me
2,6-F ₂ -Ph	H	H	B33	CF ₃	Cl	Me
2,6-F ₂ -Ph	H	H	B34	CF ₃	Cl	Me
2,6-F ₂ -Ph	H	H	Na	CF ₃	Cl	Me
2,6-F ₂ -Ph	H	H	K	CF ₃	Cl	Me
2,6-F ₂ -Ph	H	H	B1	Cl	H	H
2,6-F ₂ -Ph	H	H	B2	Cl	H	H
2,6-F ₂ -Ph	H	H	B3	Cl	H	H
2,6-F ₂ -Ph	H	H	B4	Cl	H	H
2,6-F ₂ -Ph	Me	H	B4	Cl	H	H
2,6-F ₂ -Ph	Cl	H	B4	Cl	H	H
2,6-F ₂ -Ph	NO ₂	H	B4	Cl	H	H
2,6-F ₂ -Ph	CO ₂ Me	H	B4	Cl	H	H
2,6-F ₂ -Ph	CO ₂ Et	H	B4	Cl	H	H
2,6-F ₂ -Ph	H	H	B5	Cl	H	H
2,6-F ₂ -Ph	H	H	B6	Cl	H	H
2,6-F ₂ -Ph	NO ₂	H	B6	Cl	H	H
2,6-F ₂ -Ph	H	H	B7	Cl	H	H
2,6-F ₂ -Ph	Me	H	B7	Cl	H	H
2,6-F ₂ -Ph	Cl	H	B7	Cl	H	H
2,6-F ₂ -Ph	NO ₂	H	B7	Cl	H	H
2,6-F ₂ -Ph	CO ₂ Me	H	B7	Cl	H	H
2,6-F ₂ -Ph	CO ₂ Et	H	B7	Cl	H	H
2,6-F ₂ -Ph	H	H	B8	Cl	H	H
2,6-F ₂ -Ph	H	H	B9	Cl	H	H
2,6-F ₂ -Ph	H	H	B10	Cl	H	H
2,6-F ₂ -Ph	H	H	B11	Cl	H	H
2,6-F ₂ -Ph	H	H	B12	Cl	H	H
2,6-F ₂ -Ph	H	H	B13	Cl	H	H
2,6-F ₂ -Ph	H	H	B14	Cl	H	H
2,6-F ₂ -Ph	H	H	B15	Cl	H	H
2,6-F ₂ -Ph	H	H	B16	Cl	H	H
2,6-F ₂ -Ph	H	H	B17	Cl	H	H
2,6-F ₂ -Ph	H	H	B18	Cl	H	H
2,6-F ₂ -Ph	H	H	B19	Cl	H	H
2,6-F ₂ -Ph	H	H	B20	Cl	H	H
2,6-F ₂ -Ph	H	H	B21	Cl	H	H
2,6-F ₂ -Ph	H	H	B22	Cl	H	H
2,6-F ₂ -Ph	H	H	B23	Cl	H	H
2,6-F ₂ -Ph	H	H	B24	Cl	H	H
2,6-F ₂ -Ph	H	H	B25	Cl	H	H
2,6-F ₂ -Ph	H	H	B26	Cl	H	H
2,6-F ₂ -Ph	H	H	B27	Cl	H	H
2,6-F ₂ -Ph	H	H	B28	Cl	H	H
2,6-F ₂ -Ph	H	H	B29	Cl	H	H
2,6-F ₂ -Ph	H	H	B30	Cl	H	H
2,6-F ₂ -Ph	H	H	B31	Cl	H	H
2,6-F ₂ -Ph	H	H	B32	Cl	H	H
2,6-F ₂ -Ph	H	H	B33	Cl	H	H
2,6-F ₂ -Ph	H	H	B34	Cl	H	H
2,6-F ₂ -Ph	H	H	Na	Cl	H	H
2,6-F ₂ -Ph	H	H	K	Cl	H	H
tBu	H	H	H	H	H	Me
tBu	H	H	H	Me	H	Me
tBu	H	H	H	Me	H	CF ₃
tBu	H	H	B7	Me	H	H
tBu	H	H	H	Me	Me	Me
tBu	H	H	H	Me	Cl	Me
tBu	Cl	H	H	Me	Cl	Me
tBu	H	H	H	Et	Me	Me
tBu	H	H	B8	Et	H	H
tBu	H	H	H	Cl	Me	Me
tBu	H	H	H	Cl	Me	H
tBu	H	H	H	Cl	H	Me

TABLE 1-continued

tBu	H	H	H	Cl	H	CF ₃
tBu	H	H	H	Cl	H	H
tBu	Me	H	B7	Cl	H	H
tBu	Cl	H	B7	Cl	H	H
tBu	NO ₂	H	B7	Cl	H	H
tBu	CO ₂ Me	H	B7	Cl	H	H
tBu	CO ₂ Et	H	B7	Cl	H	H
tBu	H	H	H	Cl	Cl	Me
tBu	Me	H	H	Cl	Cl	Me
tBu	Cl	H	H	Cl	Cl	Me
tBu	CF ₃	H	H	Cl	Cl	Me
tBu	cPr	H	H	Cl	Cl	Me
tBu	OMe	H	H	Cl	Cl	Me
tBu	NO ₂	H	H	Cl	Cl	Me
tBu	CN	H	H	Cl	Cl	Me
tBu	CO ₂ Me	H	H	Cl	Cl	Me
tBu	CO ₂ Et	H	H	Cl	Cl	Me
tBu	H	H	H	Cl	Cl	H
tBu	H	H	H	Cl	Cl	CF ₃
tBu	H	H	H	Cl	Cl	CF ₂ H
tBu	H	H	H	Cl	Cl	CH ₂ OMe
tBu	H	H	H	Cl	Cl	COMe
tBu	H	H	H	Cl	CF ₃	Me
tBu	H	H	H	Br	Me	Me
tBu	H	H	H	Me	Br	Me
tBu	H	H	H	Me	Br	H
tBu	H	H	B34	Br	H	H
tBu	H	H	H	OMe	Me	Me
tBu	H	H	H	Me	OMe	Me
tBu	H	H	H	OMe	H	H
tBu	H	H	H	Cl	OMe	Me
tBu	H	H	H	OCF ₃	Me	Me
tBu	H	H	H	OCF ₃	Cl	Me
tBu	H	H	H	OCF ₃	H	H
tBu	H	H	H	Me	OCF ₃	Me
tBu	H	H	H	Cl	OCF ₃	Me
tBu	H	H	H	SMe	Cl	Me
tBu	H	H	H	Me	SMe	Me
tBu	H	H	H	Cl	SMe	Me
tBu	H	H	B7	SMe	H	H
tBu	H	H	H	CF ₃	Me	Me
tBu	H	H	H	CF ₃	Cl	H
tBu	H	H	H	CF ₃	Cl	Me
tBu	Me	H	H	CF ₃	Cl	Me
tBu	Cl	H	H	CF ₃	Cl	Me
tBu	Br	H	H	CF ₃	Cl	Me
tBu	CF ₃	H	H	CF ₃	Cl	Me
tBu	NO ₂	H	H	CF ₃	Cl	Me
tBu	CN	H	H	CF ₃	Cl	Me
tBu	CO ₂ Me	H	H	CF ₃	Cl	Me
tBu	CO ₂ Et	H	H	CF ₃	Cl	Me
tBu	H	H	H	CF ₃	Cl	CF ₃
tBu	H	H	H	CF ₃	Cl	CF ₂ H
tBu	H	H	H	CF ₃	Cl	CH ₂ OMe
tBu	H	H	H	CF ₃	Cl	COCH ₃
tBu	H	H	H	CF ₃	H	Me
tBu	H	H	H	CF ₃	H	Me
tBu	H	H	H	CF ₃	Br	Me
tBu	H	H	H	CF ₃	SMe	Me
tBu	H	H	H	CF ₃	SOMe	Me
tBu	H	H	H	CF ₃	SO ₂ Me	Me
tBu	H	H	H	CF ₃	CF ₃	Me
tBu	H	H	H	CF ₃	NO ₂	Me
tBu	H	H	H	CF ₃	CN	Me
tBu	H	H	H	CF ₃	NHMe	Me
tBu	H	H	H	CF ₃	NMe ₂	Me
tBu	H	H	H	CF ₃	OH	Me
tBu	H	H	H	CF ₃	CO ₂ Me	Me
tBu	H	H	H	CF ₃	OMe	Me
tBu	H	H	H	CF ₃	OCF ₃	Me
tBu	H	H	H	CF ₃	OCF ₂ H	Me
tBu	H	H	H	CF ₃	OCF ₂ H	CF ₂ H
tBu	H	H	H	NO ₂	Cl	Me
tBu	H	H	H	NO ₂	Me	Me
tBu	H	H	H	NO ₂	H	H
tBu	H	H	H	Cl	NO ₂	Me
tBu	H	H	H	CN	Cl	Me
tBu	H	H	H	CN	Me	Me
tBu	H	H	H	CN	H	H

TABLE 1-continued

tBu	H	H	H	Cl	CN	Me
tBu	H	H	H	NMe ₂	H	H
tBu	H	H	H	Cl	NMe ₂	Me
tBu	H	H	H	OH	Me	Me
tBu	H	H	H	OH	H	H
tBu	H	H	H	Cl	OH	Me
tBu	H	H	H	CO ₂ Me	Me	Me
tBu	H	H	H	CO ₂ Me	Cl	Me
tBu	H	H	H	CO ₂ Me	H	H
tBu	H	H	B1	Cl	Cl	Me
tBu	Cl	H	B1	Cl	Cl	Me
tBu	H	H	B2	Cl	Cl	Me
tBu	H	H	B3	Cl	Cl	Me
tBu	H	H	B4	Cl	Cl	Me
tBu	Me	H	B4	Cl	Cl	Me
tBu	Cl	H	B4	Cl	Cl	Me
tBu	NO ₂	H	B4	Cl	Cl	Me
tBu	CO ₂ Me	H	B4	Cl	Cl	Me
tBu	CO ₂ Et	H	B4	Cl	Cl	Me
tBu	H	H	B5	Cl	Cl	Me
tBu	H	H	B6	Cl	Cl	Me
tBu	Cl	H	B6	Cl	Cl	Me
tBu	H	H	B7	Cl	Cl	Me
tBu	Me	H	B7	Cl	Cl	Me
tBu	Cl	H	B7	Cl	Cl	Me
tBu	NO ₂	H	B7	Cl	Cl	Me
tBu	CO ₂ Me	H	B7	Cl	Cl	Me
tBu	CO ₂ Et	H	B7	Cl	Cl	Me
tBu	H	H	B8	Cl	Cl	Me
tBu	H	H	B9	Cl	Cl	Me
tBu	H	H	B10	Cl	Cl	Me
tBu	H	H	B11	Cl	Cl	Me
tBu	H	H	B12	Cl	Cl	Me
tBu	H	H	B13	Cl	Cl	Me
tBu	H	H	B14	Cl	Cl	Me
tBu	H	H	B15	Cl	Cl	Me
tBu	H	H	B16	Cl	Cl	Me
tBu	H	H	B17	Cl	Cl	Me
tBu	H	H	B18	Cl	Cl	Me
tBu	H	H	B19	Cl	Cl	Me
tBu	H	H	B20	Cl	Cl	Me
tBu	H	H	B21	Cl	Cl	Me
tBu	H	H	B22	Cl	Cl	Me
tBu	H	H	B23	Cl	Cl	Me
tBu	H	H	B24	Cl	Cl	Me
tBu	H	H	B25	Cl	Cl	Me
tBu	H	H	B26	Cl	Cl	Me
tBu	H	H	B27	Cl	Cl	Me
tBu	H	H	B28	Cl	Cl	Me
tBu	H	H	B29	Cl	Cl	Me
tBu	H	H	B30	Cl	Cl	Me
tBu	H	H	B31	Cl	Cl	Me
tBu	H	H	B32	Cl	Cl	Me
tBu	H	H	B33	Cl	Cl	Me
tBu	H	H	B34	Cl	Cl	Me
tBu	H	H	Na	Cl	Cl	Me
tBu	H	H	K	Cl	Cl	Me
tBu	H	H	B1	CF ₃	Cl	Me
tBu	H	H	B2	CF ₃	Cl	Me
tBu	H	H	B3	CF ₃	Cl	Me
tBu	H	H	B4	CF ₃	Cl	Me
tBu	Me	H	B4	CF ₃	Cl	Me
tBu	Cl	H	B4	CF ₃	Cl	Me
tBu	NO ₂	H	B4	CF ₃	Cl	Me
tBu	CO ₂ Me	H	B4	CF ₃	Cl	Me
tBu	CO ₂ Et	H	B4	CF ₃	Cl	Me
tBu	H	H	B5	CF ₃	Cl	Me
tBu	H	H	B6	CF ₃	Cl	Me
tBu	Cl	H	B6	CF ₃	Cl	Me
tBu	H	H	B7	CF ₃	Cl	Me
tBu	Me	H	B7	CF ₃	Cl	Me
tBu	Cl	H	B7	CF ₃	Cl	Me
tBu	NO ₂	H	B7	CF ₃	Cl	Me
tBu	CO ₂ Me	H	B7	CF ₃	Cl	Me
tBu	CO ₂ Et	H	B7	CF ₃	Cl	Me
tBu	H	H	B8	CF ₃	Cl	Me
tBu	H	H	B9	CF ₃	Cl	Me
tBu	H	H	B10	CF ₃	Cl	Me
tBu	H	H	B11	CF ₃	Cl	Me

TABLE 1-continued

tBu	H	H	B12	CF ₃	Cl	Me
tBu	H	H	B13	CF ₃	Cl	Me
tBu	H	H	B14	CF ₃	Cl	Me
tBu	H	H	B15	CF ₃	Cl	Me
tBu	H	H	B16	CF ₃	Cl	Me
tBu	H	H	B17	CF ₃	Cl	Me
tBu	H	H	B18	CF ₃	Cl	Me
tBu	H	H	B19	CF ₃	Cl	Me
tBu	H	H	B20	CF ₃	Cl	Me
tBu	H	H	B21	CF ₃	Cl	Me
tBu	H	H	B22	CF ₃	Cl	Me
tBu	H	H	B23	CF ₃	Cl	Me
tBu	H	H	B24	CF ₃	Cl	Me
tBu	H	H	B25	CF ₃	Cl	Me
tBu	H	H	B26	CF ₃	Cl	Me
tBu	H	H	B27	CF ₃	Cl	Me
tBu	H	H	B28	CF ₃	Cl	Me
tBu	H	H	B29	CF ₃	Cl	Me
tBu	H	H	B30	CF ₃	Cl	Me
tBu	H	H	B31	CF ₃	Cl	Me
tBu	H	H	B32	CF ₃	Cl	Me
tBu	H	H	B33	CF ₃	Cl	Me
tBu	H	H	B34	CF ₃	Cl	Me
tBu	H	H	Na	CF ₃	Cl	Me
tBu	H	H	K	CF ₃	Cl	Me
tBu	H	H	B1	Cl	H	H
tBu	H	H	B2	Cl	H	H
tBu	H	H	B3	Cl	H	H
tBu	H	H	B4	Cl	H	H
tBu	H	H	B5	Cl	H	H
tBu	H	H	B6	Cl	H	H
tBu	H	H	B7	Cl	H	H
tBu	H	H	B8	Cl	H	H
tBu	H	H	B9	Cl	H	H
tBu	H	H	B10	Cl	H	H
tBu	H	H	B11	Cl	H	H
tBu	H	H	B12	Cl	H	H
tBu	H	H	B13	Cl	H	H
tBu	H	H	B14	Cl	H	H
tBu	H	H	B15	Cl	H	H
tBu	H	H	B16	Cl	H	H
tBu	H	H	B17	Cl	H	H
tBu	H	H	B18	Cl	H	H
tBu	H	H	B19	Cl	H	H
tBu	H	H	B20	Cl	H	H
tBu	H	H	B21	Cl	H	H
tBu	H	H	B22	Cl	H	H
tBu	H	H	B23	Cl	H	H
tBu	H	H	B24	Cl	H	H
tBu	H	H	B25	Cl	H	H
tBu	H	H	B26	Cl	H	H
tBu	H	H	B27	Cl	H	H
tBu	H	H	B28	Cl	H	H
tBu	H	H	B29	Cl	H	H
tBu	H	H	B30	Cl	H	H
tBu	H	H	B31	Cl	H	H
tBu	H	H	B32	Cl	H	H
tBu	H	H	B33	Cl	H	H
tBu	H	H	B34	Cl	H	H
tBu	H	H	Na	Cl	H	H
tBu	H	H	K	Cl	H	H
2-pyridyl	H	H	H	H	H	Me
2-pyridyl	H	H	H	Me	H	Me
2-pyridyl	H	H	H	Me	H	CF ₃
2-pyridyl	H	H	B7	Me	H	H
2-pyridyl	H	H	H	Me	Me	Me
2-pyridyl	H	H	H	Me	Cl	Me
2-pyridyl	Cl	H	H	Me	Cl	Me
2-pyridyl	H	H	H	Et	Me	Me
2-pyridyl	H	H	H	Et	H	H
2-pyridyl	H	H	H	Cl	Me	Me
2-pyridyl	H	H	H	Cl	Me	H
2-pyridyl	H	H	H	Cl	H	Me
2-pyridyl	H	H	H	Cl	H	CF ₃
2-pyridyl	H	H	B7	Cl	H	H
2-pyridyl	Me	H	B7	Cl	H	H
2-pyridyl	Cl	H	B7	Cl	H	H
2-pyridyl	CF ₃	H	B7	Cl	H	H
2-pyridyl	cPr	H	B7	Cl	H	H

TABLE 1-continued

2-pyridyl	OMe	H	B7	Cl	H	H
2-pyridyl	NO ₂	H	B7	Cl	H	H
2-pyridyl	CN	H	B7	Cl	H	H
2-pyridyl	CO ₂ Me	H	B7	Cl	H	H
2-pyridyl	CO ₂ Et	H	B7	Cl	H	H
2-pyridyl	H	H	H	Cl	Cl	Me
2-pyridyl	Me	H	H	Cl	Cl	Me
2-pyridyl	Cl	H	H	Cl	Cl	Me
2-pyridyl	CF ₃	H	H	Cl	Cl	Me
2-pyridyl	cPr	H	H	Cl	Cl	Me
2-pyridyl	OMe	H	H	Cl	Cl	Me
2-pyridyl	NO ₂	H	H	Cl	Cl	Me
2-pyridyl	CN	H	H	Cl	Cl	Me
2-pyridyl	CO ₂ Me	H	H	Cl	Cl	Me
2-pyridyl	CO ₂ Et	H	H	Cl	Cl	Me
2-pyridyl	H	H	H	Cl	Cl	H
2-pyridyl	H	H	H	Cl	Cl	CF ₃
2-pyridyl	H	H	H	Cl	Cl	CF ₂ H
2-pyridyl	H	H	H	Cl	Cl	CH ₂ OMe
2-pyridyl	H	H	H	Cl	Cl	COMe
2-pyridyl	H	H	H	Cl	CF ₃	Me
2-pyridyl	H	H	H	Br	Me	Me
2-pyridyl	H	H	H	Me	Br	Me
2-pyridyl	H	H	H	Me	Br	H
2-pyridyl	H	H	H	Br	H	H
2-pyridyl	H	H	H	OMe	Me	Me
2-pyridyl	H	H	H	Me	OMe	Me
2-pyridyl	H	H	B7	OMe	H	H
2-pyridyl	H	H	H	Cl	OMe	Me
2-pyridyl	H	H	H	OCF ₃	Me	Me
2-pyridyl	H	H	H	OCF ₃	Cl	Me
2-pyridyl	H	H	B7	OCF ₃	H	H
2-pyridyl	H	H	H	Me	OCF ₃	Me
2-pyridyl	H	H	H	Cl	OCF ₃	Me
2-pyridyl	H	H	H	SMe	Cl	Me
2-pyridyl	H	H	H	Me	SMe	Me
2-pyridyl	H	H	H	Cl	SMe	Me
2-pyridyl	H	H	B7	SMe	H	H
2-pyridyl	H	H	H	CF ₃	Me	Me
2-pyridyl	H	H	H	CF ₃	Cl	H
2-pyridyl	H	H	H	CF ₃	Cl	Me
2-pyridyl	Me	H	H	CF ₃	Cl	Me
2-pyridyl	Cl	H	H	CF ₃	Cl	Me
2-pyridyl	Br	H	H	CF ₃	Cl	Me
2-pyridyl	CF ₃	H	H	CF ₃	Cl	Me
2-pyridyl	NO ₂	H	H	CF ₃	Cl	Me
2-pyridyl	CN	H	H	CF ₃	Cl	Me
2-pyridyl	CO ₂ Me	H	H	CF ₃	Cl	Me
2-pyridyl	CO ₂ Et	H	H	CF ₃	Cl	Me
2-pyridyl	H	H	H	CF ₃	Cl	CF ₃
2-pyridyl	H	H	H	CF ₃	Cl	CF ₂ H
2-pyridyl	H	H	H	CF ₃	Cl	CH ₂ OMe
2-pyridyl	H	H	H	CF ₃	Cl	COCH ₃
2-pyridyl	H	H	H	CF ₃	H	Me
2-pyridyl	H	H	H	CF ₃	H	H
2-pyridyl	H	H	H	CF ₃	Br	Me
2-pyridyl	H	H	H	CF ₃	SMe	Me
2-pyridyl	H	H	H	CF ₃	SOMe	Me
2-pyridyl	H	H	H	CF ₃	SO ₂ Me	Me
2-pyridyl	H	H	H	CF ₃	CF ₃	Me
2-pyridyl	H	H	H	CF ₃	NO ₂	Me
2-pyridyl	H	H	H	CF ₃	CN	Me
2-pyridyl	H	H	H	CF ₃	NHMe	Me
2-pyridyl	H	H	H	CF ₃	NMe ₂	Me
2-pyridyl	H	H	H	CF ₃	OH	Me
2-pyridyl	H	H	H	CF ₃	CO ₂ Me	Me
2-pyridyl	H	H	H	CF ₃	OMe	Me
2-pyridyl	H	H	H	CF ₃	OCF ₃	Me
2-pyridyl	H	H	H	CF ₃	OCF ₂ H	Me
2-pyridyl	H	H	H	CF ₃	OCF ₂ H	CF ₂ H
2-pyridyl	H	H	H	NO ₂	Cl	Me
2-pyridyl	H	H	H	NO ₂	Me	Me
2-pyridyl	H	H	B7	NO ₂	H	H
2-pyridyl	H	H	H	Cl	NO ₂	Me
2-pyridyl	H	H	H	CN	Cl	Me
2-pyridyl	H	H	H	CN	Me	Me
2-pyridyl	H	H	H	CN	H	H
2-pyridyl	H	H	H	Cl	CN	Me
2-pyridyl	H	H	H	NMe ₂	H	H

TABLE 1-continued

2-pyridyl	H	H	H	Cl	NMe ₂	Me
2-pyridyl	H	H	H	OH	Me	Me
2-pyridyl	H	H	H	OH	H	H
2-pyridyl	H	H	H	Cl	OH	Me
2-pyridyl	H	H	H	CO ₂ Me	Me	Me
2-pyridyl	H	H	H	CO ₂ Me	Cl	Me
2-pyridyl	H	H	H	CO ₂ Me	H	H
2-pyridyl	H	H	B1	Cl	Cl	Me
2-pyridyl	H	H	B2	Cl	Cl	Me
2-pyridyl	H	H	B3	Cl	Cl	Me
2-pyridyl	H	H	B4	Cl	Cl	Me
2-pyridyl	H	H	B5	Cl	Cl	Me
2-pyridyl	H	H	B6	Cl	Cl	Me
2-pyridyl	H	H	B7	Cl	Cl	Me
2-pyridyl	Cl	H	B7	Cl	Cl	Me
2-pyridyl	H	H	B8	Cl	Cl	Me
2-pyridyl	H	H	B9	Cl	Cl	Me
2-pyridyl	H	H	B10	Cl	Cl	Me
2-pyridyl	H	H	B11	Cl	Cl	Me
2-pyridyl	H	H	B12	Cl	Cl	Me
2-pyridyl	H	H	B13	Cl	Cl	Me
2-pyridyl	H	H	B14	Cl	Cl	Me
2-pyridyl	H	H	B15	Cl	Cl	Me
2-pyridyl	H	H	B16	Cl	Cl	Me
2-pyridyl	H	H	B17	Cl	Cl	Me
2-pyridyl	H	H	B18	Cl	Cl	Me
2-pyridyl	H	H	B19	Cl	Cl	Me
2-pyridyl	H	H	B20	Cl	Cl	Me
2-pyridyl	H	H	B21	Cl	Cl	Me
2-pyridyl	H	H	B22	Cl	Cl	Me
2-pyridyl	H	H	B23	Cl	Cl	Me
2-pyridyl	H	H	B24	Cl	Cl	Me
2-pyridyl	H	H	B25	Cl	Cl	Me
2-pyridyl	H	H	B26	Cl	Cl	Me
2-pyridyl	H	H	B27	Cl	Cl	Me
2-pyridyl	H	H	B28	Cl	Cl	Me
2-pyridyl	H	H	B29	Cl	Cl	Me
2-pyridyl	H	H	B30	Cl	Cl	Me
2-pyridyl	H	H	B31	Cl	Cl	Me
2-pyridyl	H	H	B32	Cl	Cl	Me
2-pyridyl	H	H	B33	Cl	Cl	Me
2-pyridyl	H	H	B34	Cl	Cl	Me
2-pyridyl	H	H	Na	Cl	Cl	Me
2-pyridyl	H	H	K	Cl	Cl	Me
2-pyridyl	H	H	B1	CF ₃	Cl	Me
2-pyridyl	H	H	B2	CF ₃	Cl	Me
2-pyridyl	H	H	B3	CF ₃	Cl	Me
2-pyridyl	H	H	B4	CF ₃	Cl	Me
2-pyridyl	Cl	H	B4	CF ₃	Cl	Me
2-pyridyl	CO ₂ Me	H	B4	CF ₃	Cl	Me
2-pyridyl	H	H	B5	CF ₃	Cl	Me
2-pyridyl	H	H	B6	CF ₃	Cl	Me
2-pyridyl	H	H	B7	CF ₃	Cl	Me
2-pyridyl	Cl	H	B7	CF ₃	Cl	Me
2-pyridyl	NO ₂	H	B7	CF ₃	Cl	Me
2-pyridyl	CO ₂ Me	H	B7	CF ₃	Cl	Me
2-pyridyl	H	H	B8	CF ₃	Cl	Me
2-pyridyl	H	H	B9	CF ₃	Cl	Me
2-pyridyl	H	H	B10	CF ₃	Cl	Me
2-pyridyl	H	H	B11	CF ₃	Cl	Me
2-pyridyl	H	H	B12	CF ₃	Cl	Me
2-pyridyl	H	H	B13	CF ₃	Cl	Me
2-pyridyl	H	H	B14	CF ₃	Cl	Me
2-pyridyl	H	H	B15	CF ₃	Cl	Me
2-pyridyl	H	H	B16	CF ₃	Cl	Me
2-pyridyl	H	H	B17	CF ₃	Cl	Me
2-pyridyl	H	H	B18	CF ₃	Cl	Me
2-pyridyl	H	H	B19	CF ₃	Cl	Me
2-pyridyl	H	H	B20	CF ₃	Cl	Me
2-pyridyl	H	H	B21	CF ₃	Cl	Me
2-pyridyl	H	H	B22	CF ₃	Cl	Me
2-pyridyl	H	H	B23	CF ₃	Cl	Me
2-pyridyl	H	H	B24	CF ₃	Cl	Me
2-pyridyl	H	H	B25	CF ₃	Cl	Me
2-pyridyl	H	H	B26	CF ₃	Cl	Me
2-pyridyl	H	H	B27	CF ₃	Cl	Me
2-pyridyl	H	H	B28	CF ₃	Cl	Me
2-pyridyl	H	H	B29	CF ₃	Cl	Me
2-pyridyl	H	H	B30	CF ₃	Cl	Me

TABLE 1-continued

2-pyridyl	H	H	B31	CF ₃	Cl	Me
2-pyridyl	H	H	B32	CF ₃	Cl	Me
2-pyridyl	H	H	B33	CF ₃	Cl	Me
2-pyridyl	H	H	B34	CF ₃	Cl	Me
2-pyridyl	H	H	Na	CF ₃	Cl	Me
2-pyridyl	H	H	K	CF ₃	Cl	Me
2-pyridyl	H	H	B1	Cl	H	H
2-pyridyl	H	H	B2	Cl	H	H
2-pyridyl	H	H	B3	Cl	H	H
2-pyridyl	H	H	B4	Cl	H	H
2-pyridyl	Me	H	B4	Cl	H	H
2-pyridyl	Cl	H	B4	Cl	H	H
2-pyridyl	NO ₂	H	B4	Cl	H	H
2-pyridyl	CO ₂ Me	H	B4	Cl	H	H
2-pyridyl	CO ₂ Et	H	B4	Cl	H	H
2-pyridyl	H	H	B5	Cl	H	H
2-pyridyl	H	H	B6	Cl	H	H
2-pyridyl	NO ₂	H	B6	Cl	H	H
2-pyridyl	H	H	B7	Cl	H	H
2-pyridyl	Me	H	B7	Cl	H	H
2-pyridyl	Cl	H	B7	Cl	H	H
2-pyridyl	NO ₂	H	B7	Cl	H	H
2-pyridyl	CO ₂ Me	H	B7	Cl	H	H
2-pyridyl	CO ₂ Et	H	B7	Cl	H	H
2-pyridyl	H	H	B8	Cl	H	H
2-pyridyl	H	H	B9	Cl	H	H
2-pyridyl	H	H	B10	Cl	H	H
2-pyridyl	H	H	B11	Cl	H	H
2-pyridyl	H	H	B12	Cl	H	H
2-pyridyl	H	H	B13	Cl	H	H
2-pyridyl	H	H	B14	Cl	H	H
2-pyridyl	H	H	B15	Cl	H	H
2-pyridyl	H	H	B16	Cl	H	H
2-pyridyl	H	H	B17	Cl	H	H
2-pyridyl	H	H	B18	Cl	H	H
2-pyridyl	H	H	B19	Cl	H	H
2-pyridyl	H	H	B20	Cl	H	H
2-pyridyl	H	H	B21	Cl	H	H
2-pyridyl	H	H	B22	Cl	H	H
2-pyridyl	H	H	B23	Cl	H	H
2-pyridyl	H	H	B24	Cl	H	H
2-pyridyl	H	H	B25	Cl	H	H
2-pyridyl	H	H	B26	Cl	H	H
2-pyridyl	H	H	B27	Cl	H	H
2-pyridyl	H	H	B28	Cl	H	H
2-pyridyl	H	H	B29	Cl	H	H
2-pyridyl	H	H	B30	Cl	H	H
2-pyridyl	H	H	B31	Cl	H	H
2-pyridyl	H	H	B32	Cl	H	H
2-pyridyl	H	H	B33	Cl	H	H
2-pyridyl	H	H	B34	Cl	H	H
2-pyridyl	H	H	Na	Cl	H	H
2-pyridyl	H	H	K	Cl	H	H
3-pyridyl	H	H	H	Cl	Cl	Me
3-pyridyl	H	H	H	CF ₃	Cl	Me
3-pyridyl	H	H	H	Cl	H	H
3-pyridyl	H	H	B4	Cl	H	H
3-pyridyl	H	H	B7	Cl	H	H
4-pyridyl	H	H	H	Cl	Cl	Me
4-pyridyl	H	H	H	CF ₃	Cl	Me
4-pyridyl	H	H	H	Cl	H	H
4-pyridyl	H	H	B4	Cl	H	H
4-pyridyl	H	H	B7	Cl	H	H
3-Me-pyridin-2-yl	H	H	H	Cl	Cl	Me
2-F—Ph	H	H	H	Me	H	Me
2-F—Ph	H	H	H	Me	Me	Me
2-F—Ph	H	H	H	Me	Cl	Me
2-F—Ph	H	H	H	Cl	H	H
2-F—Ph	H	H	H	Cl	H	Me
2-F—Ph	H	H	H	Cl	H	CF ₃
2-F—Ph	H	H	H	Cl	Cl	Me
2-F—Ph	Cl	H	H	Cl	Cl	Me
2-F—Ph	H	H	B7	OMe	H	H
2-F—Ph	H	H	B7	SMe	H	H
2-F—Ph	H	H	H	CF ₃	Me	Me
2-F—Ph	H	H	H	CF ₃	Cl	Me
2-F—Ph	Cl	H	H	CF ₃	Cl	Me
2-F—Ph	H	H	H	CF ₃	H	Me
2-F—Ph	H	H	B1	Cl	Cl	Me

TABLE 1-continued

2-F—Ph	Cl	H	B1	Cl	Cl	Me
2-F—Ph	H	H	B3	Cl	Cl	Me
2-F—Ph	Cl	H	B4	Cl	Cl	Me
2-F—Ph	H	H	B6	Cl	Cl	Me
2-F—Ph	H	H	B7	Cl	Cl	Me
2-F—Ph	Cl	H	B7	Cl	Cl	Me
2-F—Ph	H	H	B9	Cl	Cl	Me
2-F—Ph	H	H	B20	Cl	Cl	Me
2-F—Ph	H	H	B24	Cl	Cl	Me
2-F—Ph	H	H	B2	CF ₃	Cl	Me
2-F—Ph	H	H	B3	CF ₃	Cl	Me
2-F—Ph	H	H	B4	CF ₃	Cl	Me
2-F—Ph	Cl	H	B4	CF ₃	Cl	Me
2-F—Ph	H	H	B6	CF ₃	Cl	Me
2-F—Ph	H	H	B7	CF ₃	Cl	Me
2-F—Ph	Cl	H	B7	CF ₃	Cl	Me
2-F—Ph	H	H	B9	CF ₃	Cl	Me
2-F—Ph	H	H	B20	CF ₃	Cl	Me
2-F—Ph	H	H	B24	CF ₃	Cl	Me
2-F—Ph	H	H	B6	Cl	H	H
2-F—Ph	H	H	B7	Cl	H	H
3-F—Ph	H	H	H	Cl	Cl	Me
3-F—Ph	Cl	H	H	Cl	Cl	Me
3-F—Ph	H	H	H	CF ₃	Cl	Me
3-F—Ph	Cl	H	H	CF ₃	Cl	Me
4-F—Ph	H	H	H	Cl	Cl	Me
4-F—Ph	Cl	H	H	Cl	Cl	Me
4-F—Ph	H	H	H	CF ₃	Cl	Me
4-F—Ph	Cl	H	H	CF ₃	Cl	Me
2,3-F ₂ —Ph	H	H	H	Cl	Cl	Me
2,3-F ₂ —Ph	H	H	H	CF ₃	Cl	Me
2,4-F ₂ —Ph	H	H	H	Cl	Cl	Me
2,4-F ₂ —Ph	H	H	H	CF ₃	Cl	Me
2,5-F ₂ —Ph	H	H	H	Cl	Cl	Me
2,5-F ₂ —Ph	H	H	H	CF ₃	Cl	Me
Ph	H	H	H	Me	H	Me
Ph	H	H	H	Me	Me	Me
Ph	H	H	H	Me	Cl	Me
Ph	H	H	B7	Cl	H	H
Ph	H	H	H	Cl	H	Me
Ph	H	H	H	Cl	H	CF ₃
Ph	H	H	H	Cl	Cl	Me
Ph	Cl	H	H	Cl	Cl	Me
Ph	H	H	B7	OMe	H	H
Ph	H	H	B7	SMe	H	H
Ph	H	H	H	CF ₃	Me	Me
Ph	H	H	H	CF ₃	Cl	Me
Ph	Cl	H	H	CF ₃	Cl	Me
Ph	H	H	B7	CF ₃	H	Me
Ph	H	H	B1	Cl	Cl	Me
Ph	Cl	H	B1	Cl	Cl	Me
Ph	H	H	B3	Cl	Cl	Me
Ph	Cl	H	B4	Cl	Cl	Me
Ph	H	H	B6	Cl	Cl	Me
Ph	H	H	B7	Cl	Cl	Me
Ph	Cl	H	B7	Cl	Cl	Me
Ph	H	H	B9	Cl	Cl	Me
Ph	H	H	B20	Cl	Cl	Me
Ph	H	H	B24	Cl	Cl	Me
Ph	H	H	B2	CF ₃	Cl	Me
Ph	H	H	B3	CF ₃	Cl	Me
Ph	H	H	B4	CF ₃	Cl	Me
Ph	Cl	H	B4	CF ₃	Cl	Me
Ph	H	H	B6	CF ₃	Cl	Me
Ph	H	H	B7	CF ₃	Cl	Me
Ph	Cl	H	B7	CF ₃	Cl	Me
Ph	H	H	B9	CF ₃	Cl	Me
Ph	H	H	B20	CF ₃	Cl	Me
Ph	H	H	B24	CF ₃	Cl	Me
Ph	H	H	B6	Cl	H	H
Ph	H	H	B7	Cl	H	H
3,4-F ₂ —Ph	H	H	H	Cl	Cl	Me
3,4-F ₂ —Ph	H	H	H	CF ₃	Cl	Me
3,5-F ₂ —Ph	H	H	H	Cl	Cl	Me
3,5-F ₂ —Ph	H	H	H	CF ₃	Cl	Me
2-Cl—Ph	H	H	H	Me	H	Me
2-Cl—Ph	H	H	H	Me	Me	Me
2-Cl—Ph	H	H	H	Me	Cl	Me
2-Cl—Ph	H	H	H	Cl	H	H

TABLE 1-continued

2-Cl—Ph	H	H	H	Cl	H	Me
2-Cl—Ph	H	H	H	Cl	H	CF ₃
2-Cl—Ph	H	H	H	Cl	Cl	Me
2-Cl—Ph	Cl	H	H	Cl	Cl	Me
2-Cl—Ph	H	H	H	OMe	H	H
2-Cl—Ph	H	H	H	SMe	H	H
2-Cl—Ph	H	H	H	CF ₃	Me	Me
2-Cl—Ph	H	H	H	CF ₃	Cl	Me
2-Cl—Ph	Cl	H	H	CF ₃	Cl	Me
2-Cl—Ph	H	H	H	CF ₃	H	Me
2-Cl—Ph	H	H	H	Cl	Cl	Me
2-Cl—Ph	Cl	H	B1	Cl	Cl	Me
2-Cl—Ph	H	H	B3	Cl	Cl	Me
2-Cl—Ph	Cl	H	B4	Cl	Cl	Me
2-Cl—Ph	H	H	B6	Cl	Cl	Me
2-Cl—Ph	H	H	B7	Cl	Cl	Me
2-Cl—Ph	Cl	H	B7	Cl	Cl	Me
2-Cl—Ph	H	H	B9	Cl	Cl	Me
2-Cl—Ph	H	H	B20	Cl	Cl	Me
2-Cl—Ph	H	H	B24	Cl	Cl	Me
2-Cl—Ph	H	H	B2	CF ₃	Cl	Me
2-Cl—Ph	H	H	B3	CF ₃	Cl	Me
2-Cl—Ph	H	H	B4	CF ₃	Cl	Me
2-Cl—Ph	Cl	H	B4	CF ₃	Cl	Me
2-Cl—Ph	H	H	B6	CF ₃	Cl	Me
2-Cl—Ph	H	H	B7	CF ₃	Cl	Me
2-Cl—Ph	Cl	H	B7	CF ₃	Cl	Me
2-Cl—Ph	H	H	B9	CF ₃	Cl	Me
2-Cl—Ph	H	H	B20	CF ₃	Cl	Me
2-Cl—Ph	H	H	B24	CF ₃	Cl	Me
2-Cl—Ph	H	H	B6	Cl	H	H
2-Cl—Ph	H	H	B7	Cl	H	H
3-Cl—Ph	H	H	H	Cl	Cl	Me
3-Cl—Ph	Cl	H	H	Cl	Cl	Me
3-Cl—Ph	H	H	H	CF ₃	Cl	Me
3-Cl—Ph	Cl	H	H	CF ₃	Cl	Me
4-Cl—Ph	H	H	H	Cl	Cl	Me
4-Cl—Ph	Cl	H	H	Cl	Cl	Me
4-Cl—Ph	H	H	H	CF ₃	Cl	Me
4-Cl—Ph	Cl	H	H	CF ₃	Cl	Me
2,3-Cl ₂ —Ph	H	H	H	Cl	Cl	Me
2,3-Cl ₂ —Ph	H	H	H	CF ₃	Cl	Me
2,4-Cl ₂ —Ph	H	H	H	Cl	Cl	Me
2,4-Cl ₂ —Ph	H	H	H	CF ₃	Cl	Me
2,5-Cl ₂ —Ph	H	H	H	Cl	Cl	Me
2,5-Cl ₂ —Ph	H	H	H	CF ₃	Cl	Me
2,6-Cl ₂ —Ph	H	H	H	Me	H	Me
2,6-Cl ₂ —Ph	H	H	H	Me	Me	Me
2,6-Cl ₂ —Ph	H	H	H	Me	Cl	Me
2,6-Cl ₂ —Ph	H	H	B7	Cl	H	H
2,6-Cl ₂ —Ph	H	H	H	Cl	H	Me
2,6-Cl ₂ —Ph	H	H	H	Cl	H	CF ₃
2,6-Cl ₂ —Ph	H	H	H	Cl	Cl	Me
2,6-Cl ₂ —Ph	Cl	H	H	Cl	Cl	Me
2,6-Cl ₂ —Ph	H	H	B7	OMe	H	H
2,6-Cl ₂ —Ph	H	H	B7	SMe	H	H
2,6-Cl ₂ —Ph	H	H	H	CF ₃	Me	Me
2,6-Cl ₂ —Ph	H	H	H	CF ₃	Cl	Me
2,6-Cl ₂ —Ph	Cl	H	H	CF ₃	Cl	Me
2,6-Cl ₂ —Ph	H	H	H	CF ₃	H	Me
2,6-Cl ₂ —Ph	H	H	B1	Cl	Cl	Me
2,6-Cl ₂ —Ph	Cl	H	B1	Cl	Cl	Me
2,6-Cl ₂ —Ph	H	H	B3	Cl	Cl	Me
2,6-Cl ₂ —Ph	Cl	H	B4	Cl	Cl	Me
2,6-Cl ₂ —Ph	H	H	B6	Cl	Cl	Me
2,6-Cl ₂ —Ph	H	H	B7	Cl	Cl	Me
2,6-Cl ₂ —Ph	Cl	H	B7	Cl	Cl	Me
2,6-Cl ₂ —Ph	H	H	B9	Cl	Cl	Me
2,6-Cl ₂ —Ph	H	H	B20	Cl	Cl	Me
2,6-Cl ₂ —Ph	H	H	B24	Cl	Cl	Me
2,6-Cl ₂ —Ph	H	H	B2	CF ₃	Cl	Me
2,6-Cl ₂ —Ph	H	H	B3	CF ₃	Cl	Me
2,6-Cl ₂ —Ph	H	H	B4	CF ₃	Cl	Me
2,6-Cl ₂ —Ph	Cl	H	B4	CF ₃	Cl	Me
2,6-Cl ₂ —Ph	H	H	B6	CF ₃	Cl	Me
2,6-Cl ₂ —Ph	H	H	B7	CF ₃	Cl	Me
2,6-Cl ₂ —Ph	Cl	H	B7	CF ₃	Cl	Me
2,6-Cl ₂ —Ph	H	H	B9	CF ₃	Cl	Me
2,6-Cl ₂ —Ph	H	H	B20	CF ₃	Cl	Me

TABLE 1-continued

2,6-Cl ₂ -Ph	H	H	B24	CF ₃	Cl	Me
2,6-Cl ₂ -Ph	H	H	B8	Cl	H	H
2,6-Cl ₂ -Ph	H	H	B15	Cl	H	H
3,4-Cl ₂ -Ph	H	H	H	Cl	Cl	Me
3,4-Cl ₂ -Ph	H	H	H	CF ₃	Cl	Me
3,5-Cl ₂ -Ph	H	H	H	Cl	Cl	Me
3,5-Cl ₂ -Ph	H	H	H	CF ₃	Cl	Me
2-Me-Ph	H	H	H	Cl	Cl	Me
2-Me-Ph	H	H	H	CF ₃	Cl	Me
2,6-Me ₂ -Ph	H	H	H	Cl	Cl	Me
2,6-Me ₂ -Ph	H	H	H	CF ₃	Cl	Me
2-MeO-Ph	H	H	H	Cl	Cl	Me
2-MeO-Ph	H	H	H	CF ₃	Cl	Me
2-MeO-Ph	Cl	H	H	CF ₃	Cl	Me
2-CF ₃ O-Ph	H	H	H	Cl	Cl	Me
2-CF ₃ O-Ph	H	H	H	CF ₃	Cl	Me
2-SMe-Ph	H	H	H	Cl	Cl	Me
2-SMe-Ph	H	H	H	CF ₃	Cl	Me
2-SOMe-Ph	H	H	H	Cl	Cl	Me
2-SOMe-Ph	H	H	H	CF ₃	Cl	Me
2-SO ₂ Me-Ph	H	H	H	Cl	Cl	Me
2-SO ₂ Me-Ph	H	H	H	CF ₃	Cl	Me
2-CF ₃ -Ph	H	H	H	Cl	Cl	Me
2-CF ₃ -Ph	H	H	H	CF ₃	Cl	Me
2-NO ₂ -Ph	H	H	H	Cl	Cl	Me
2-NO ₂ -Ph	H	H	H	CF ₃	Cl	Me
2-CN-Ph	H	H	H	Cl	Cl	Me
2-CN-Ph	H	H	H	CF ₃	Cl	Me
2-NHMe-Ph	H	H	H	Cl	Cl	Me
2-NHMe-Ph	H	H	H	CF ₃	Cl	Me
2-NMe ₂ -Ph	H	H	H	Cl	Cl	Me
2-NMe ₂ -Ph	H	H	H	CF ₃	Cl	Me
4-CH ₂ Ph-Ph	H	H	H	Cl	Cl	Me
4-OPh-Ph	H	H	H	Cl	Cl	Me
2-OH-Ph	H	H	H	Cl	Cl	Me
2-OH-Ph	H	H	H	CF ₃	Cl	Me
2-CO ₂ Me-Ph	H	H	H	Cl	Cl	Me
2-CO ₂ Me-Ph	H	H	H	CF ₃	Cl	Me
2-CO ₂ Et-Ph	H	H	H	Cl	Cl	Me
2-CO ₂ Et-Ph	H	H	H	CF ₃	Cl	Me
H	CO ₂ Et	Ph	H	Cl	Cl	Me
Cl	CO ₂ Et	H	H	Cl	Cl	Me
Me	Ph	H	H	Cl	Cl	Me
Et	Me	H	H	Cl	Cl	Me
nPr	H	H	H	Cl	Cl	Me
iPr	H	H	H	Cl	Cl	Me
iPr	H	H	H	CF ₃	Cl	Me
nBu	H	H	H	Cl	Cl	Me
nBu	H	H	H	CF ₃	Cl	Me
iBu	H	H	H	Cl	Cl	Me
iBu	H	H	H	CF ₃	Cl	Me
iBu	H	H	B7	Cl	Cl	Me
iBu	H	H	B7	CF ₃	Cl	Me
secBu	H	H	H	Cl	Cl	Me
secBu	H	H	H	CF ₃	Cl	Me
2,2-Me ₂ -propyl	H	H	H	Cl	Cl	Me
nHex	H	H	H	Cl	Cl	Me
ethenyl	H	H	H	Cl	Cl	Me
1-propenyl	H	H	H	Cl	Cl	Me
1-propenyl	H	H	H	CF ₃	Cl	Me
ethynyl	H	H	H	Cl	Cl	Me
1-propynyl	H	H	H	Cl	Cl	Me
1-propynyl	H	H	H	CF ₃	Cl	Me
CF ₃	H	H	H	Cl	Cl	Me
CF ₃	H	H	H	CF ₃	Cl	Me
C ₂ F ₅	H	H	H	Cl	Cl	Me
C ₂ F ₅	H	H	H	CF ₃	Cl	Me
2,2-Cl ₂ -cPr	H	H	H	Cl	Cl	Me
2,2-Cl ₂ -cPr	H	H	H	CF ₃	Cl	Me
cPr	H	H	H	Cl	Cl	Me
cPr	H	H	H	CF ₃	Cl	Me
1-Me-cPr	H	H	H	Cl	Cl	Me
1-Me-cpr	H	H	H	CF ₃	Cl	Me
cHex	H	H	H	Cl	Cl	Me
cHex	H	H	H	CF ₃	Cl	Me
OMe	H	H	H	Cl	Cl	Me
OtBu	H	H	H	Cl	Cl	Me
OtBu	H	H	H	CF ₃	Cl	Me
OCF ₃	H	H	H	Cl	Cl	Me

TABLE 1-continued

OCF ₃	H	H	H	CF ₃	Cl	Me
StBu	H	H	H	Cl	Cl	Me
StBu	H	H	H	CF ₃	Cl	Me
SOTBu	H	H	H	Cl	Cl	Me
SOTBu	H	H	H	CF ₃	Cl	Me
SO ₂ tBu	H	H	H	Cl	Cl	Me
SO ₂ tBu	H	H	H	CF ₃	Cl	Me
NO ₂	H	H	H	Cl	Cl	Me
NO ₂	H	H	H	CF ₃	Cl	Me
CN	H	H	H	Cl	Cl	Me
CN	H	H	H	CF ₃	Cl	Me
NH ₂	H	H	H	Cl	Cl	Me
NH ₂	H	H	H	CF ₃	Cl	Me
NHMe	H	H	H	Cl	Cl	Me
NHMe	H	H	H	CF ₃	Cl	Me
NMe ₂	H	H	H	Cl	Cl	Me
NMe ₂	H	H	H	CF ₃	Cl	Me
CH ₂ Ph	H	H	H	Cl	Cl	Me
CH ₂ Ph	H	H	H	CF ₃	Cl	Me
OPh	H	H	H	Cl	Cl	Me
OPh	H	H	H	CF ₃	Cl	Me
OH	H	H	H	Cl	Cl	Me
OH	H	H	H	CF ₃	Cl	Me
naphthyl-1	H	H	H	Cl	Cl	Me
naphthyl-1	H	H	H	CF ₃	Cl	Me
naphthyl-2	H	H	H	Cl	Cl	Me
naphthyl-2	H	H	H	CF ₃	Cl	Me
CO ₂ Me	H	H	H	Cl	Cl	Me
CO ₂ Me	H	H	H	CF ₃	Cl	Me
CO ₂ Et	H	H	H	Cl	Cl	Me
CO ₂ Et	H	H	H	CF ₃	Cl	Me
2-thienyl	H	H	H	Cl	Cl	Me
2-thienyl	H	H	H	CF ₃	Cl	Me
CH ₂ OMe	H	H	H	Cl	Cl	Me
COCH ₃	H	H	H	Cl	Cl	Me
—N=CMe ₂	H	H	H	Cl	Cl	Me
—N=CMe ₂	H	H	H	CF ₃	Cl	Me
—(CH ₂) ₃ —	H	H	H	Cl	Cl	Me
—(CH ₂) ₃ —	H	H	H	CF ₃	Cl	Me
—(CH ₂) ₄ —	H	H	H	Cl	Cl	Me
—(CH ₂) ₄ —	H	H	H	CF ₃	Cl	Me

40

TABLE 2

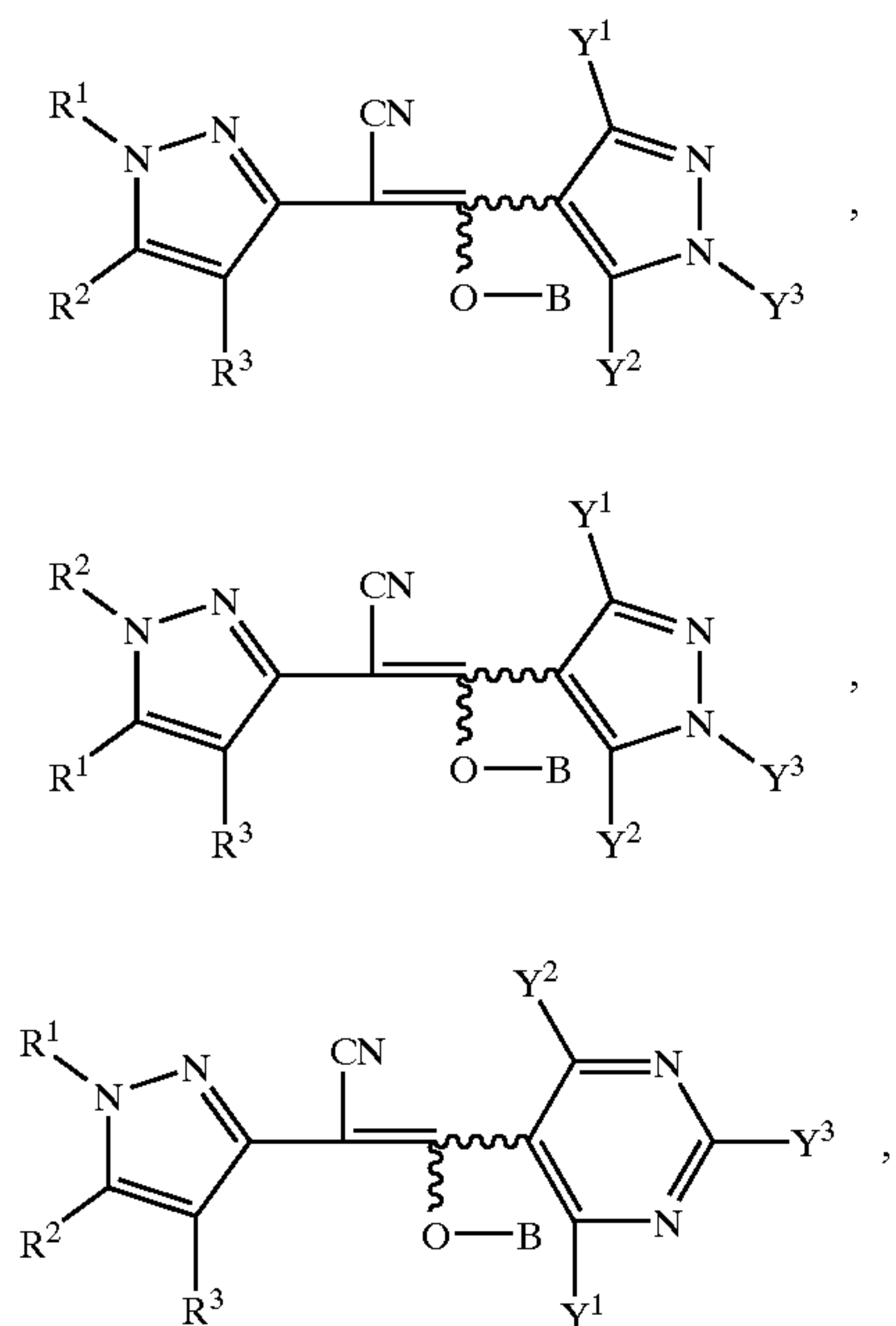

TABLE 2-continued

45

50

55

60

65

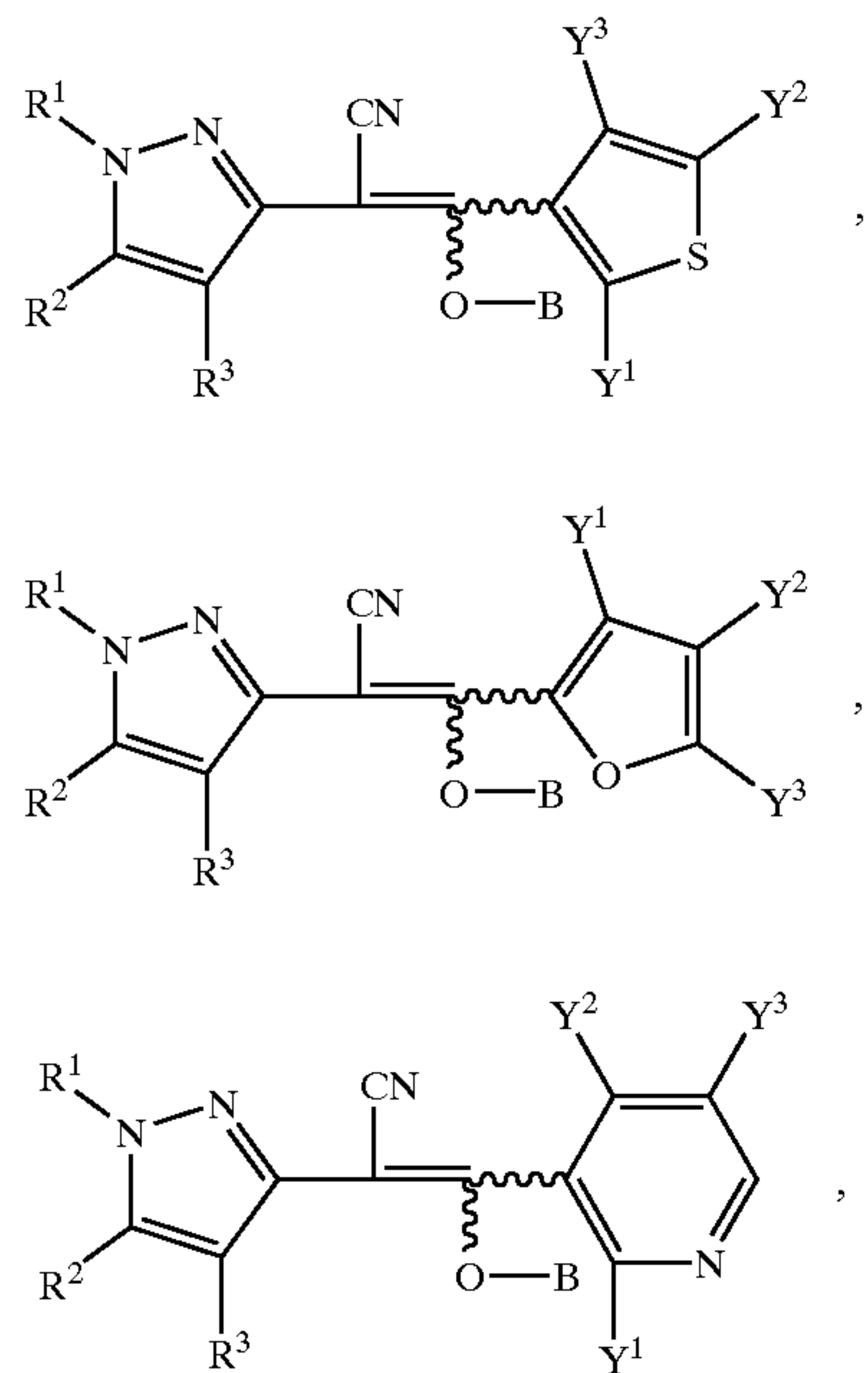

TABLE 2-continued

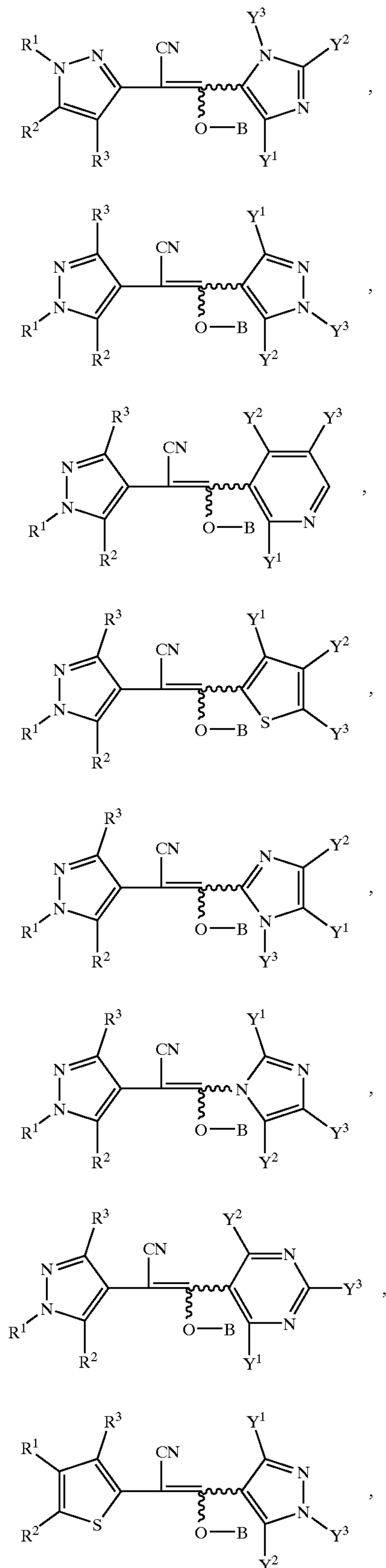

TABLE 2-continued

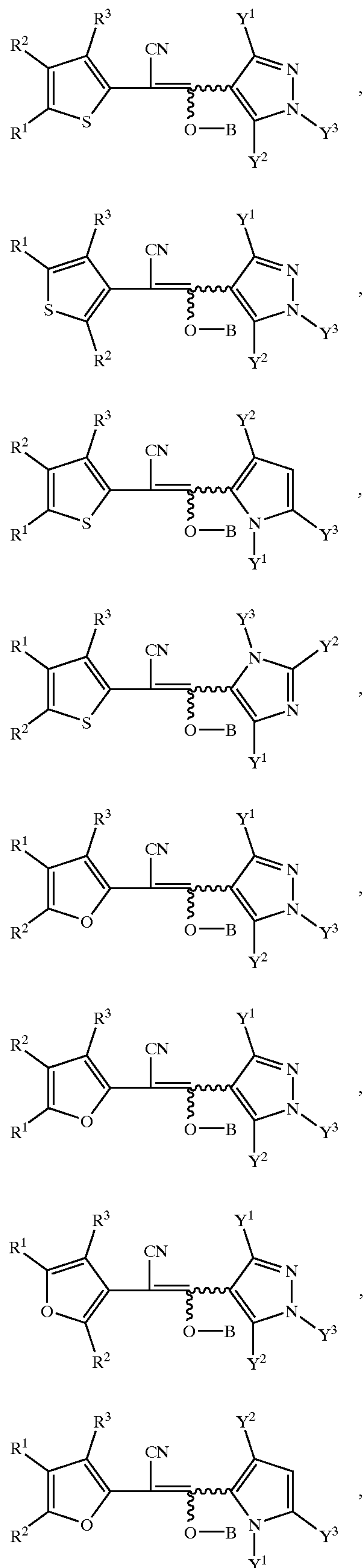
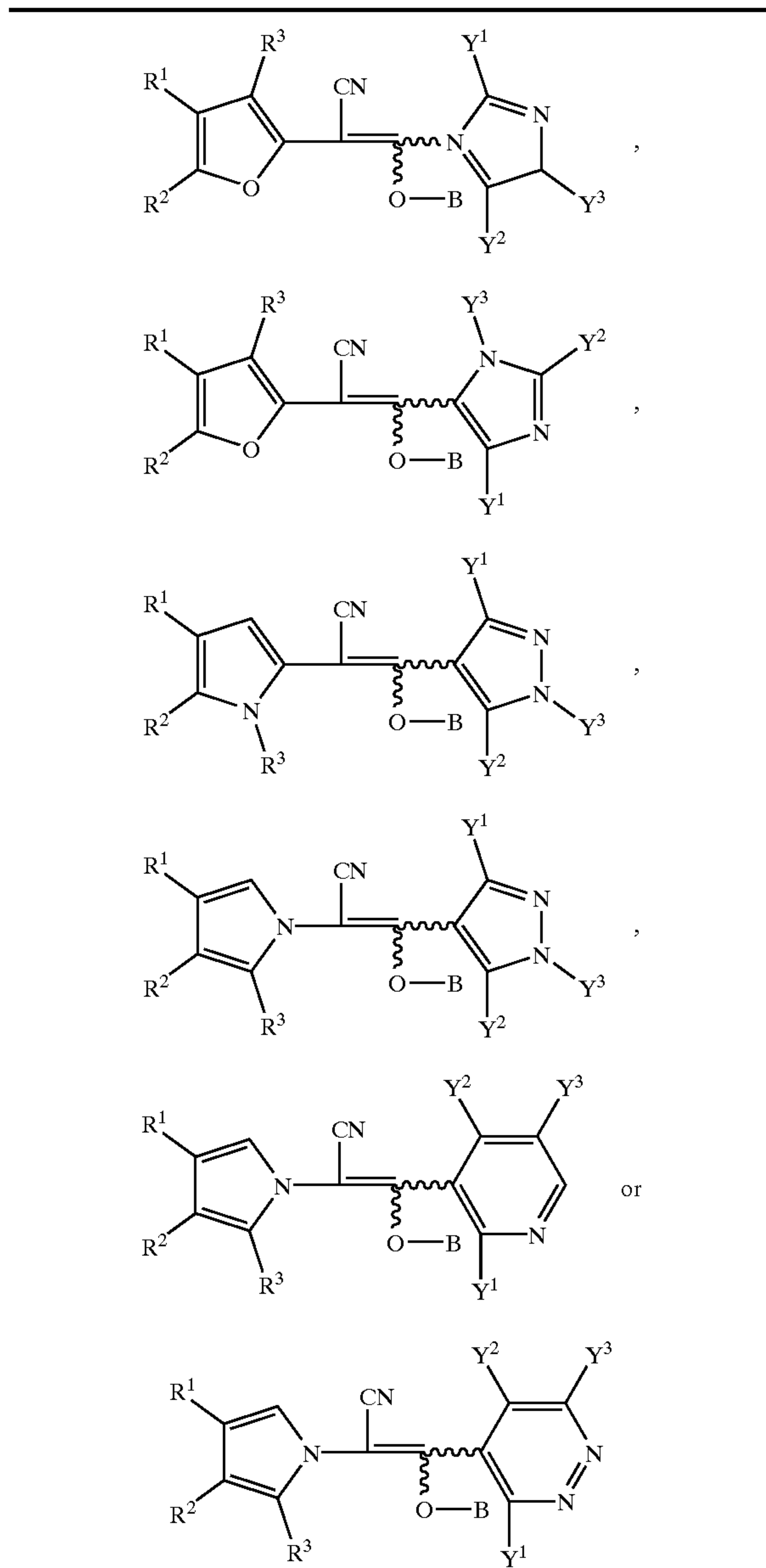

TABLE 2-continued



R ¹	R ²	R ³	B	Y ¹	Y ²	Y ³
2,6-F ₂ -Ph	H	H	H	Me	H	Me
2,6-F ₂ -Ph	H	H	H	Me	H	CF ₃
2,6-F ₂ -Ph	H	H	H	Me	H	H
2,6-F ₂ -Ph	H	H	H	Me	Me	Me
2,6-F ₂ -Ph	H	H	H	Me	Cl	Me
2,6-F ₂ -Ph	Cl	H	H	Me	Cl	Me
2,6-F ₂ -Ph	H	H	H	Et	Me	Me
2,6-F ₂ -Ph	H	H	H	Cl	Me	Me
2,6-F ₂ -Ph	H	H	H	Cl	H	CF ₃
2,6-F ₂ -Ph	H	H	H	Cl	H	H
2,6-F ₂ -Ph	Me	H	H	Cl	H	H
2,6-F ₂ -Ph	Cl	H	H	Cl	H	H
2,6-F ₂ -Ph	H	H	H	Cl	Cl	Me
2,6-F ₂ -Ph	Me	H	H	Cl	Cl	Me
2,6-F ₂ -Ph	H	Cl	H	Cl	Cl	Me
2,6-F ₂ -Ph	Cl	H	H	Cl	Cl	Me
2,6-F ₂ -Ph	CF ₃	H	H	Cl	Cl	Me
2,6-F ₂ -Ph	OMe	H	H	Cl	Cl	Me
2,6-F ₂ -Ph	NH ₂	H	H	Cl	Cl	Me
2,6-F ₂ -Ph	NHMe	H	H	Cl	Cl	Me

TABLE 2-continued

2,6-F ₂ -Ph	NMe ₂	H	H	Cl	Cl	Me
2,6-F ₂ -Ph	NO ₂	H	H	Cl	Cl	Me
2,6-F ₂ -Ph	CN	H	H	Cl	Cl	Me
2,6-F ₂ -Ph	OH	H	H	Cl	Cl	Me
2,6-F ₂ -Ph	CO ₂ Me	H	H	Cl	Cl	Me
2,6-F ₂ -Ph	CO ₂ Et	H	H	Cl	Cl	Me
2,6-F ₂ -Ph	H	H	H	Cl	Cl	CF ₃
2,6-F ₂ -Ph	H	H	H	Cl	Cl	CF ₂ H
2,6-F ₂ -Ph	H	H	H	Cl	Cl	CH ₂ OMe
2,6-F ₂ -Ph	H	H	H	Cl	Cl	COMe
2,6-F ₂ -Ph	H	H	H	Cl	Cl	Me
2,6-F ₂ -Ph	H	H	H	Cl	Cl	Me
2,6-F ₂ -Ph	H	H	H	Br	Me	Me
2,6-F ₂ -Ph	H	H	H	Me	Br	Me
2,6-F ₂ -Ph	H	H	H	Me	OMe	Me
2,6-F ₂ -Ph	H	H	H	OMe	H	H
2,6-F ₂ -Ph	H	H	H	OCF ₃	H	H
2,6-F ₂ -Ph	H	H	H	SMe	H	H
2,6-F ₂ -Ph	H	H	H	CF ₃	Me	Me
2,6-F ₂ -Ph	H	H	H	CF ₃	Cl	Me
2,6-F ₂ -Ph	Me	H	H	CF ₃	Cl	Me
2,6-F ₂ -Ph	Cl	H	H	CF ₃	Cl	Me
2,6-F ₂ -Ph	Br	H	H	CF ₃	Cl	Me
2,6-F ₂ -Ph	CF ₃	H	H	CF ₃	Cl	Me
2,6-F ₂ -Ph	NO ₂	H	H	CF ₃	Cl	Me
2,6-F ₂ -Ph	CN	H	H	CF ₃	Cl	Me
2,6-F ₂ -Ph	CO ₂ Me	H	H	CF ₃	Cl	Me
2,6-F ₂ -Ph	CO ₂ Et	H	H	CF ₃	Cl	Me
2,6-F ₂ -Ph	H	H	H	CF ₃	Cl	CF ₃
2,6-F ₂ -Ph	H	H	H	CF ₃	Cl	CF ₂ H
2,6-F ₂ -Ph	H	H	H	CF ₃	Cl	CH ₂ OMe
2,6-F ₂ -Ph	H	H	H	CF ₃	Cl	COCH ₃
2,6-F ₂ -Ph	H	H	H	CF ₃	H	Me
2,6-F ₂ -Ph	H	H	H	CF ₃	Br	Me
2,6-F ₂ -Ph	H	H	H	CF ₃	NO ₂	Me
2,6-F ₂ -Ph	H	H	H	CF ₃	CN	Me
2,6-F ₂ -Ph	H	H	H	CF ₃	NHMe	Me
2,6-F ₂ -Ph	H	H	H	CF ₃	NMe ₂	Me
2,6-F ₂ -Ph	H	H	H	CF ₃	CO ₂ Me	Me
2,6-F ₂ -Ph	H	H	H	CF ₃	OMe	Me
2,6-F ₂ -Ph	H	H	H	CF ₃	OCF ₂ H	CF ₂ H
2,6-F ₂ -Ph	H	H	H	Cl	NO ₂	Me
2,6-F ₂ -Ph	H	H	H	Cl	CN	Me
2,6-F ₂ -Ph	H	H	H	Cl	Me	Me
2,6-F ₂ -Ph	H	H	B1	Cl	Cl	Me
2,6-F ₂ -Ph	H	H	B2	Cl	Cl	Me
2,6-F ₂ -Ph	H	H	B3	Cl	Cl	Me
2,6-F ₂ -Ph	H	H	B4	Cl	Cl	Me
2,6-F ₂ -Ph	H	H	B5	Cl	Cl	Me
2,6-F ₂ -Ph	H	H	B6	Cl	Cl	Me
2,6-F ₂ -Ph	H	H	B7	Cl	Cl	Me
2,6-F ₂ -Ph	H	H	B8	Cl	Cl	Me
2,6-F ₂ -Ph	H	H	B9	Cl	Cl	Me
2,6-F ₂ -Ph	H	H	B10	Cl	Cl	Me
2,6-F ₂ -Ph	H	H	B11	Cl	Cl	Me
2,6-F ₂ -Ph	H	H	B12	Cl	Cl	Me
2,6-F ₂ -Ph	H	H	B13	Cl	Cl	Me
2,6-F ₂ -Ph	H	H	B14	Cl	Cl	Me
2,6-F ₂ -Ph	H	H	B15	Cl	Cl	Me
2,6-F ₂ -Ph	H	H	B16	Cl	Cl	Me
2,6-F ₂ -Ph	H	H	B17	Cl	Cl	Me
2,6-F ₂ -Ph	H	H	B18	Cl	Cl	Me
2,6-F ₂ -Ph	H	H	B19	Cl	Cl	Me
2,6-F ₂ -Ph	H	H	B20	Cl	Cl	Me
2,6-F ₂ -Ph	H	H	B21	Cl	Cl	Me
2,6-F ₂ -Ph	H	H	B22	Cl	Cl	Me
2,6-F ₂ -Ph	H	H	B23	Cl	Cl	Me
2,6-F ₂ -Ph	H	H	B24	Cl	Cl	Me
2,6-F ₂ -Ph	H	H	B25	Cl	Cl	Me
2,6-F ₂ -Ph	H	H	B26	Cl	Cl	Me
2,6-F ₂ -Ph	H	H	B27	Cl	Cl	Me
2,6-F ₂ -Ph	H	H	B28	Cl	Cl	Me
2,6-F ₂ -Ph	H	H	B29	Cl	Cl	Me
2,6-F ₂ -Ph	H	H	B30	Cl	Cl	Me
2,6-F ₂ -Ph	H	H	B31	Cl	Cl	Me
2,6-F ₂ -Ph	H	H	B32	Cl	Cl	Me
2,6-F ₂ -Ph	H	H	B33	Cl	Cl	Me
2,6-F ₂ -Ph	H	H	B34	Cl	Cl	Me
2,6-F ₂ -Ph	H	H	Na	Cl	Cl	Me
2,6-F ₂ -Ph	H	H	K	Cl	Cl	Me

TABLE 2-continued

2,6-F ₂ -Ph	H	H	B2	CF ₃	Cl	Me	
2,6-F ₂ -Ph	H	H	B3	CF ₃	Cl	Me	
2,6-F ₂ -Ph	H	H	B4	CF ₃	Cl	Me	5
2,6-F ₂ -Ph	H	H	B5	CF ₃	Cl	Me	
2,6-F ₂ -Ph	H	H	B6	CF ₃	Cl	Me	
2,6-F ₂ -Ph	H	H	B7	CF ₃	Cl	Me	
2,6-F ₂ -Ph	H	H	B8	CF ₃	Cl	Me	
2,6-F ₂ -Ph	H	H	B9	CF ₃	Cl	Me	
2,6-F ₂ -Ph	H	H	B10	CF ₃	Cl	Me	10
2,6-F ₂ -Ph	H	H	B11	CF ₃	Cl	Me	
2,6-F ₂ -Ph	H	H	B12	CF ₃	Cl	Me	
2,6-F ₂ -Ph	H	H	B13	CF ₃	Cl	Me	
2,6-F ₂ -Ph	H	H	B14	CF ₃	Cl	Me	
2,6-F ₂ -Ph	H	H	B15	CF ₃	Cl	Me	
2,6-F ₂ -Ph	H	H	B16	CF ₃	Cl	Me	15
2,6-F ₂ -Ph	H	H	B17	CF ₃	Cl	Me	
2,6-F ₂ -Ph	H	H	B18	CF ₃	Cl	Me	
2,6-F ₂ -Ph	H	H	B19	CF ₃	Cl	Me	
2,6-F ₂ -Ph	H	H	B20	CF ₃	Cl	Me	
2,6-F ₂ -Ph	H	H	B21	CF ₃	Cl	Me	
2,6-F ₂ -Ph	H	H	B22	CF ₃	Cl	Me	20
2,6-F ₂ -Ph	H	H	B23	CF ₃	Cl	Me	
2,6-F ₂ -Ph	H	H	B24	CF ₃	Cl	Me	
2,6-F ₂ -Ph	H	H	B25	CF ₃	Cl	Me	
2,6-F ₂ -Ph	H	H	B26	CF ₃	Cl	Me	
2,6-F ₂ -Ph	H	H	B27	CF ₃	Cl	Me	
2,6-F ₂ -Ph	H	H	B28	CF ₃	Cl	Me	
2,6-F ₂ -Ph	H	H	B29	CF ₃	Cl	Me	25
2,6-F ₂ -Ph	H	H	B30	CF ₃	Cl	Me	
2,6-F ₂ -Ph	H	H	B31	CF ₃	Cl	Me	
2,6-F ₂ -Ph	H	H	B32	CF ₃	Cl	Me	
2,6-F ₂ -Ph	H	H	B33	CF ₃	Cl	Me	
2,6-F ₂ -Ph	H	H	B34	CF ₃	Cl	Me	
2,6-F ₂ -Ph	H	H	Na	CF ₃	Cl	Me	30
2,6-F ₂ -Ph	H	H	K	CF ₃	Cl	Me	
2,6-F ₂ -Ph	H	H	B7	Cl	H	H	
2,6-F ₂ -Ph	H	H	B9	Cl	H	H	
2,6-F ₂ -Ph	H	H	B10	Cl	H	H	
2,6-F ₂ -PhPh	H	H	B11	Cl	H	H	
tBu	H	H	H	Me	H	Me	35
tBu	H	H	H	Me	H	CF ₃	
tBu	H	H	H	Me	H	H	
tBu	H	H	H	Me	Me	Me	
tBu	H	H	H	Me	Cl	Me	
tBu	Cl	H	H	Me	Cl	Me	
tBu	H	H	H	Cl	Me	Me	40
tBu	H	H	H	Cl	H	Me	
tBu	H	H	H	Cl	H	CF ₃	
tBu	H	H	H	Cl	H	H	
tBu	H	H	H	Cl	Cl	Me	
tBu	Me	H	H	Cl	Cl	Me	
tBu	Cl	H	H	Cl	Cl	Me	45
tBu	NO ₂	H	H	Cl	Cl	Me	
tBu	CO ₂ Me	H	H	Cl	Cl	Me	
tBu	CO ₂ Et	H	H	Cl	Cl	Me	
tBu	H	H	H	Cl	Cl	CF ₃	
tBu	H	H	H	Cl	Cl	CF ₂ H	
tBu	H	H	H	Cl	Cl	CH ₂ OMe	
tBu	H	H	H	Cl	Cl	COMe	50
tBu	H	H	H	Cl	CF ₃	Me	
tBu	H	H	H	Br	Me	Me	
tBu	H	H	H	Me	Br	Me	
tBu	H	H	H	OMe	H	H	
tBu	H	H	H	CF ₃	Me	Me	
tBu	H	H	H	CF ₃	Cl	Me	55
tBu	Me	H	H	CF ₃	Cl	Me	
tBu	Cl	H	H	CF ₃	Cl	Me	
tBu	NO ₂	H	H	CF ₃	Cl	Me	
tBu	CO ₂ Me	H	H	CF ₃	Cl	Me	
tBu	CO ₂ Et	H	H	CF ₃	Cl	Me	
tBu	H	H	H	CF ₃	Cl	CF ₃	60
tBu	H	H	H	CF ₃	Cl	CF ₂ H	
tBu	H	H	H	CF ₃	Cl	CH ₂ OMe	
tBu	H	H	H	CF ₃	Cl	COCH ₃	
tBu	H	H	H	CF ₃	H	Me	
tBu	H	H	H	CF ₃	NO ₂	Me	
tBu	H	H	H	CF ₃	NHMe	Me	65
tBu	H	H	H	CF ₃	NMe ₂	Me	
tBu	H	H	H	NO ₂	Me	Me	

TABLE 2-continued

tBu	H	H	H	CN	Cl	Me	
tBu	H	H	H	CN	Me	Me	
tBu	H	H	H	Cl	CN	Me	
tBu	H	H	H	CO ₂ Me	Me	Me	
tBu	H	H	H	CO ₂ Me	Cl	Me	
tBu	H	H	B1	Cl	Cl	Me	
tBu	Cl	H	B1	Cl	Cl	Me	
tBu	H	H	B2	Cl	Cl	Me	
tBu	H	H	B3	Cl	Cl	Me	
tBu	H	H	B4	Cl	Cl	Me	
tBu	H	H	B5	Cl	Cl	Me	
tBu	H	H	B6	Cl	Cl	Me	
tBu	H	H	B7	Cl	Cl	Me	
tBu	H	H	B8	Cl	Cl	Me	
tBu	H	H	B9	Cl	Cl	Me	
tBu	H	H	B10	Cl	Cl	Me	
tBu	H	H	B11	Cl	Cl	Me	
tBu	H	H	B12	Cl	Cl	Me	
tBu	H	H	B13	Cl	Cl	Me	
tBu	H	H	B14	Cl	Cl	Me	
tBu	H	H	B15	Cl	Cl	Me	
tBu	H	H	B16	Cl	Cl	Me	
tBu	H	H	B17	Cl	Cl	Me	
tBu	H	H	B18	Cl	Cl	Me	
tBu	H	H	B19	Cl	Cl	Me	
tBu	H	H	B20	Cl	Cl	Me	
tBu	H	H	B21	Cl	Cl	Me	
tBu	H	H	B22	Cl	Cl	Me	
tBu	H	H	B23	Cl	Cl	Me	
tBu	H	H	B24	Cl	Cl	Me	
tBu	H	H	B25	Cl	Cl	Me	
tBu	H	H	B26	Cl	Cl	Me	
tBu	H	H	B27	Cl	Cl	Me	
tBu	H	H	B28	Cl	Cl	Me	
tBu	H	H	B29	Cl	Cl	Me	
tBu	H	H	B30	Cl	Cl	Me	
tBu	H	H	B31	Cl	Cl	Me	
tBu	H	H	B32	Cl	Cl	Me	
tBu	H	H	B33	Cl	Cl	Me	
tBu	H	H	B34	Cl	Cl	Me	
tBu	H	H	Na	Cl	Cl	Me	
tBu	H	H	K	Cl	Cl	Me	
tBu	H	H	B2	CF ₃	Cl	Me	
tBu	H	H	B3	CF ₃	Cl	Me	
tBu	H	H	B4	CF ₃	Cl	Me	
tBu	H	H	B5	CF ₃	Cl	Me	
tBu	H	H	B6	CF ₃	Cl	Me	
tBu	H	H	B7	CF ₃	Cl	Me	
tBu	H	H	B8	CF ₃	Cl	Me	
tBu	H	H	B9	CF ₃	Cl	Me	
tBu	H	H	B10	CF ₃	Cl	Me	
tBu	H	H	B11	CF ₃	Cl	Me	
tBu	H	H	B12	CF ₃	Cl	Me	
tBu	H	H	B13	CF ₃	Cl	Me	
tBu	H	H	B14	CF ₃	Cl	Me	
tBu	H	H	B15	CF ₃	Cl	Me	
tBu	H	H	B16	CF ₃	Cl	Me	
tBu	H	H	B17	CF ₃	Cl	Me	
tBu	H	H	B18	CF ₃	Cl	Me	
tBu	H	H	B19	CF ₃	Cl	Me	
tBu	H	H	B20	CF ₃	Cl	Me	
tBu	H	H	B21	CF ₃	Cl	Me	
tBu	H	H	B22	CF ₃	Cl	Me	
tBu	H	H	B23	CF ₃	Cl	Me	
tBu	H	H	B24	CF ₃	Cl	Me	
tBu	H	H	B25	CF ₃	Cl	Me	
tBu	H	H	B26	CF ₃	Cl	Me	
tBu	H	H	B27	CF ₃	Cl	Me	
tBu	H	H	B28	CF ₃	Cl	Me	
tBu	H	H	B29	CF ₃	Cl	Me	
tBu	H	H	B30	CF ₃	Cl	Me	
tBu	H	H	B31	CF ₃	Cl	Me	
tBu	H	H	B32	CF ₃	Cl	Me	
tBu	H	H	B33	CF ₃	Cl	Me	
tBu	H	H	B34	CF ₃	Cl	Me	
tBu	H	H	Na	CF ₃	Cl	Me	
tBu	H	H	K	CF ₃	Cl	Me	
tBu	H	H	B7	Cl	H	H	
tBu	H	H	B8	Cl	H	H	

TABLE 2-continued

tBu	H	H	B15	Cl	H	H
tBu	H	H	B17	Cl	H	H
tBu	H	H	B18	Cl	H	H
tBu	H	H	B34	Cl	H	H
2-pyridyl	H	H	H	Me	H	Me
2-pyridyl	H	H	H	Me	H	CF ₃
2-pyridyl	H	H	B7	Me	H	H
2-pyridyl	H	H	H	Me	Me	Me
2-pyridyl	H	H	H	Me	Cl	Me
2-pyridyl	H	H	H	Cl	Me	Me
2-pyridyl	H	H	H	Cl	H	Me
2-pyridyl	H	H	H	Cl	H	CF ₃
2-pyridyl	H	H	H	Cl	H	H
2-pyridyl	Cl	H	H	Cl	H	H
2-pyridyl	CO ₂ Me	H	H	Cl	H	H
2-pyridyl	CO ₂ Et	H	H	Cl	H	H
2-pyridyl	H	H	H	Cl	Cl	Me
2-pyridyl	H	H	H	Cl	CF ₃	Me
2-pyridyl	H	H	H	Br	Me	Me
2-pyridyl	H	H	H	Me	Br	Me
2-pyridyl	H	H	B7	OMe	H	H
2-pyridyl	H	H	H	CF ₃	Me	Me
2-pyridyl	H	H	H	CF ₃	Cl	Me
2-pyridyl	H	H	H	CF ₃	H	Me
2-pyridyl	H	H	B7	CF ₃	H	H
2-pyridyl	H	H	B1	Cl	Cl	Me
2-pyridyl	H	H	B3	Cl	Cl	Me
2-pyridyl	H	H	B7	Cl	Cl	Me
2-pyridyl	H	H	B3	CF ₃	Cl	Me
2-pyridyl	H	H	B7	CF ₃	H	H
2-pyridyl	H	H	B7	CF ₃	Cl	Me
2-pyridyl	H	H	B3	Cl	H	H
2-pyridyl	H	H	B4	Cl	H	H
2-pyridyl	H	H	B5	Cl	H	H
2-pyridyl	H	H	B6	Cl	H	H
2-pyridyl	H	H	B7	Cl	H	H
2-pyridyl	H	H	B8	Cl	H	H
2-pyridyl	H	H	B9	Cl	H	H
2-pyridyl	H	H	B10	Cl	H	H
2-pyridyl	H	H	B11	Cl	H	H
2-pyridyl	H	H	B15	Cl	H	H
2-pyridyl	H	H	B16	Cl	H	H
2-pyridyl	H	H	B17	Cl	H	H
2-pyridyl	H	H	B28	Cl	H	H
2-pyridyl	H	H	B30	Cl	H	H
2-pyridyl	H	H	B31	Cl	H	H
2-pyridyl	H	H	B32	Cl	H	H
2-pyridyl	H	H	B34	Cl	H	H
3-pyridyl	H	H	H	Cl	Cl	Me
3-pyridyl	H	H	H	Cl	H	H
4-pyridyl	H	H	H	Cl	Cl	Me
4-pyridyl	H	H	H	Cl	H	H
2-F—Ph	H	H	H	Cl	H	H
2-F—Ph	H	H	H	Cl	Cl	Me
2-F—Ph	H	H	B7	OMe	H	H
2-F—Ph	H	H	B7	SMe	H	H
2-F—Ph	H	H	H	CF ₃	Cl	Me
2-F—Ph	H	H	H	CF ₃	H	Me
2-F—Ph	H	H	B1	Cl	Cl	Me
2-F—Ph	H	H	B3	Cl	Cl	Me
2-F—Ph	H	H	B6	Cl	Cl	Me
2-F—Ph	H	H	B7	Cl	Cl	Me
2-F—Ph	Cl	H	B7	Cl	Cl	Me
2-F—Ph	H	H	B3	CF ₃	Cl	Me
2-F—Ph	H	H	B6	CF ₃	Cl	Me
2-F—Ph	H	H	B7	CF ₃	Cl	Me
2-F—Ph	Cl	H	B7	CF ₃	Cl	Me
2-F—Ph	H	H	B7	Cl	H	H
3-F—Ph	H	H	H	Cl	Cl	Me
3-F—Ph	H	H	H	CF ₃	Cl	Me
4-F—Ph	H	H	H	Cl	Cl	Me
4-F—Ph	H	H	H	CF ₃	Cl	Me
2,3-F ₂ —Ph	H	H	H	Cl	Cl	Me
2,4-F ₂ —Ph	H	H	H	Cl	Cl	Me
2,5-F ₂ —Ph	H	H	H	Cl	Cl	Me
Ph	H	H	H	Cl	H	H
Ph	H	H	H	Cl	Cl	Me
Ph	H	H	H	OMe	Cl	H
Ph	H	H	H	SMe	Cl	H
Ph	H	H	H	CF ₃	Cl	Me

TABLE 2-continued

Ph	H	H	H	CF ₃	H	Me
Ph	H	H	B1	Cl	Cl	Me
5 Ph	H	H	B3	Cl	Cl	Me
Ph	H	H	B6	Cl	Cl	Me
Ph	H	H	B7	Cl	Cl	Me
Ph	Cl	H	B7	Cl	Cl	Me
Ph	H	H	B3	CF ₃	Cl	Me
Ph	H	H	B6	CF ₃	Cl	Me
10 Ph	H	H	B7	CF ₃	Cl	Me
Ph	Cl	H	B7	CF ₃	Cl	Me
Ph	H	H	B7	Cl	H	H
Ph	H	H	H	Cl	Cl	Me
Ph	H	H	H	Cl	Cl	Me
2-Cl—Ph	H	H	H	Cl	H	H
15 2-Cl—Ph	H	H	H	Cl	Cl	Me
2-Cl—Ph	H	H	H	OMe	H	H
2-Cl—Ph	H	H	H	SMe	H	H
2-Cl—Ph	H	H	H	CF ₃	Cl	Me
2-Cl—Ph	H	H	H	CF ₃	H	Me
2-Cl—Ph	H	H	B1	Cl	Cl	Me
2-Cl—Ph	H	H	B3	Cl	Cl	Me
20 2-Cl—Ph	H	H	B6	Cl	Cl	Me
2-Cl—Ph	H	H	B7	Cl	Cl	Me
2-Cl—Ph	Cl	H	B7	Cl	Cl	Me
2-Cl—Ph	H	H	B3	CF ₃	Cl	Me
2-Cl—Ph	H	H	B6	CF ₃	Cl	Me
25 2-Cl—Ph	H	H	B7	CF ₃	Cl	Me
2-Cl—Ph	Cl	H	B7	CF ₃	Cl	Me
3-Cl—Ph	H	H	H	Cl	Cl	Me
4-Cl—Ph	H	H	H	Cl	Cl	Me
2,3-Cl ₂ —Ph	H	H	H	Cl	Cl	Me
2,4-Cl ₂ —Ph	H	H	H	Cl	Cl	Me
30 2,5-Cl ₂ —Ph	H	H	H	Cl	Cl	Me
2,6-Cl ₂ —Ph	H	H	H	Cl	H	H
2,6-Cl ₂ —Ph	H	H	H	Cl	Cl	Me
2,6-Cl ₂ —Ph	H	H	H	OMe	H	H
2,6-Cl ₂ —Ph	H	H	H	SMe	H	H
35 2,6-Cl ₂ —Ph	H	H	H	CF ₃	Cl	Me
2,6-Cl ₂ —Ph	H	H	H	CF ₃	H	Me
2,6-Cl ₂ —Ph	H	H	B1	Cl	Cl	Me
2,6-Cl ₂ —Ph	H	H	B3	Cl	Cl	Me
2,6-Cl ₂ —Ph	H	H	B6	Cl	Cl	Me
2,6-Cl ₂ —Ph	H	H	B7	Cl	Cl	Me
2,6-Cl ₂ —Ph	Cl	H	B7	Cl	Cl	Me
40 2,6-Cl ₂ —Ph	H	H	B3	CF ₃	Cl	Me
2,6-Cl ₂ —Ph	H	H	B6	CF ₃	Cl	Me
2,6-Cl ₂ —Ph	H	H	B7	CF ₃	Cl	Me
2,6-Cl ₂ —Ph	Cl	H	B7	CF ₃	Cl	Me
2,6-Cl ₂ —Ph	H	H	B7	Cl	H	H
45 3,5-Cl ₂ —Ph	H	H	H	Cl	Cl	Me
2-MeO—Ph	H	H	H	Cl	Cl	Me
2-MeO—Ph	H	H	H	CF ₃	Cl	Me
2,6-Me ₂ —Ph	H	H	H	Cl	Cl	Me
2,6-Me ₂ —Ph	H	H	H	CF ₃	Cl	Me
2-MeO—Ph	H	H	H	Cl	Cl	Me
2-MeO—Ph	H	H	H	CF ₃	Cl	Me
50 2-CF ₃ O—Ph	H	H	H	Cl	Cl	Me
2-SMe—Ph	H	H	H	Cl	Cl	Me
2-SOMe—Ph	H	H	H	Cl	Cl	Me
2-SO ₂ Me—Ph	H	H	H	Cl	Cl	Me
2-CF ₃ —Ph	H	H	H	Cl	Cl	Me
2-NO ₂ —Ph	H	H	H	Cl	Cl	Me
55 2-CN—Ph	H	H	H	Cl	Cl	Me
2-NHMe—Ph	H	H	H	Cl	Cl	Me
2-NMe ₂ —Ph	H	H	H	Cl	Cl	Me
4-benzyl-Ph	H	H	H	Cl	Cl	Me
4-phenoxy-Ph	H	H	H	Cl	Cl	Me
2-OH—Ph	H	H	H	Cl	Cl	Me
60 2-CO ₂ Me—Ph	H	H	H	Cl	Cl	Me
2-CO ₂ Et—Ph	H	H	H	Cl	Cl	Me
H	CO ₂ Et	Ph	H	Cl	Cl	Me
Me	Ph	H	H	Cl	Cl	Me
Et	Me	H	H	Cl	Cl	Me
nPr	H	H	H	Cl	Cl	Me
iPr	H	H	H	Cl	Cl	Me
65 iPr	H	H	H	CF ₃	Cl	Me
nBu	H	H	H	Cl	Cl	Me

TABLE 2-continued

nBu	H	H	H	CF ₃	Cl	Me
iBu	H	H	H	Cl	Cl	Me
iBu	H	H	H	CF ₃	Cl	Me
iBu	H	H	B7	Cl	Cl	Me
iBu	H	H	B7	CF ₃	Cl	Me
iBu	H	H	H	Cl	Cl	H
secBu	H	H	H	Cl	Cl	Me
secBu	H	H	H	CF ₃	Cl	Me
2,2-Me ₂ -propyl	H	H	H	Cl	Cl	Me
nHex	H	H	H	Cl	Cl	Me
ethenyl	H	H	H	Cl	Cl	Me
1-propenyl	H	H	H	Cl	Cl	Me
1-propenyl	H	H	H	CF ₃	Cl	Me
ethynyl	H	H	H	Cl	Cl	Me
1-propynyl	H	H	H	Cl	Cl	Me
CF ₃	H	H	H	Cl	Cl	Me
CHF ₂	H	H	H	Cl	Cl	Me
C ₂ H ₅	H	H	H	Cl	Cl	Me
2,2-Cl ₂ -cPr	H	H	H	Cl	Cl	Me
2,2-Cl ₂ -cPr	H	H	H	CF ₃	Cl	Me
cPr	H	H	H	Cl	Cl	Me
cPr	H	H	H	CF ₃	Cl	Me
1-Me-cPr	H	H	H	Cl	Cl	Me
1-Me-cPr	H	H	H	CF ₃	Cl	Me
cHex	H	H	H	Cl	Cl	Me
cHex	H	H	H	CF ₃	Cl	Me
CH ₂ Ph	H	H	H	Cl	Cl	Me
naphthyl-1	H	H	H	Cl	Cl	Me
naphthyl-1	H	H	H	CF ₃	Cl	Me
naphthyl-2	H	H	H	Cl	Cl	Me
CO ₂ Me	H	H	H	Cl	Cl	Me
CO ₂ Et	H	H	H	Cl	Cl	Me
2-thienyl	H	H	H	Cl	Cl	Me
CH ₂ OMe	H	H	H	Cl	Cl	Me
CH ₂ OEt	H	H	H	Cl	Cl	Me
COCH ₃	H	H	H	Cl	Cl	Me
COTu	H	H	H	Cl	Cl	Me

TABLE 3

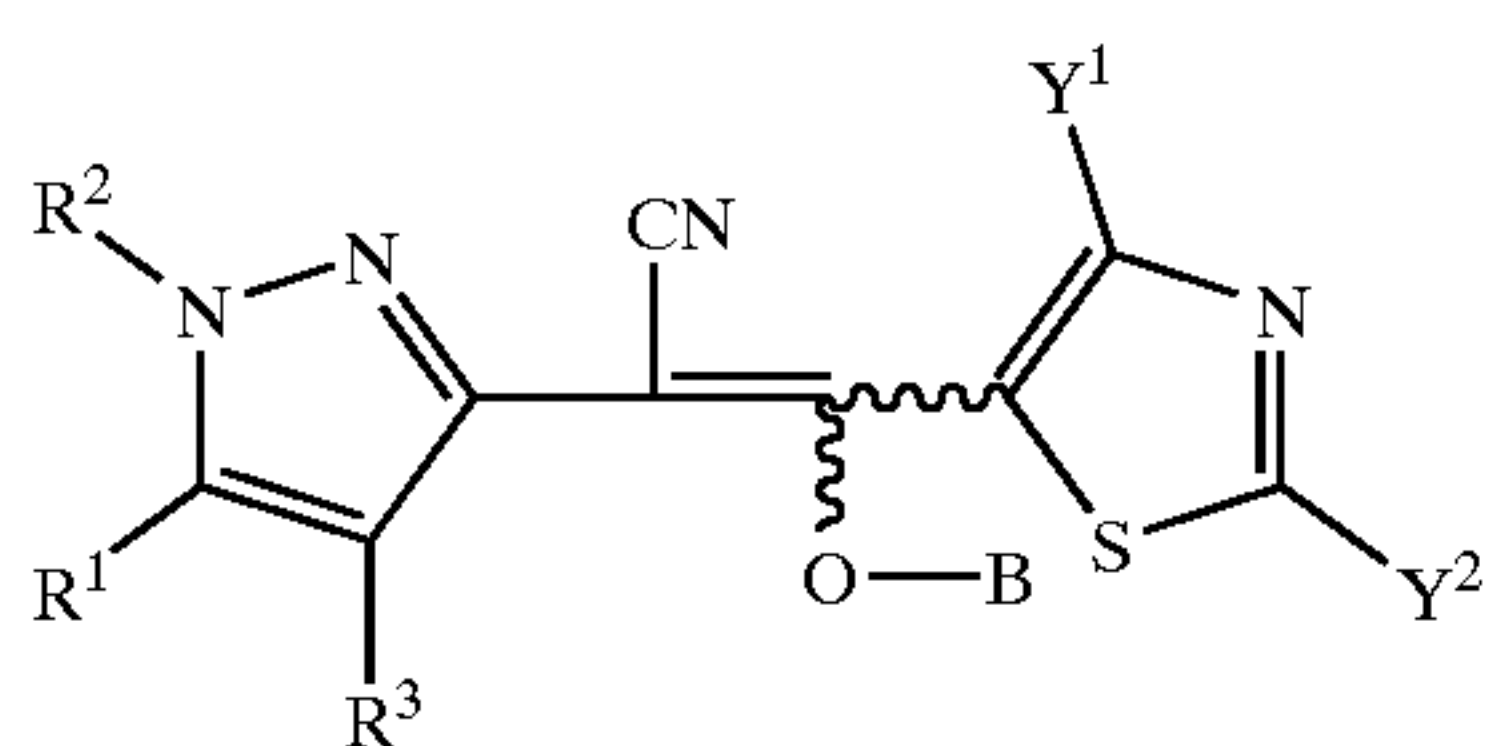
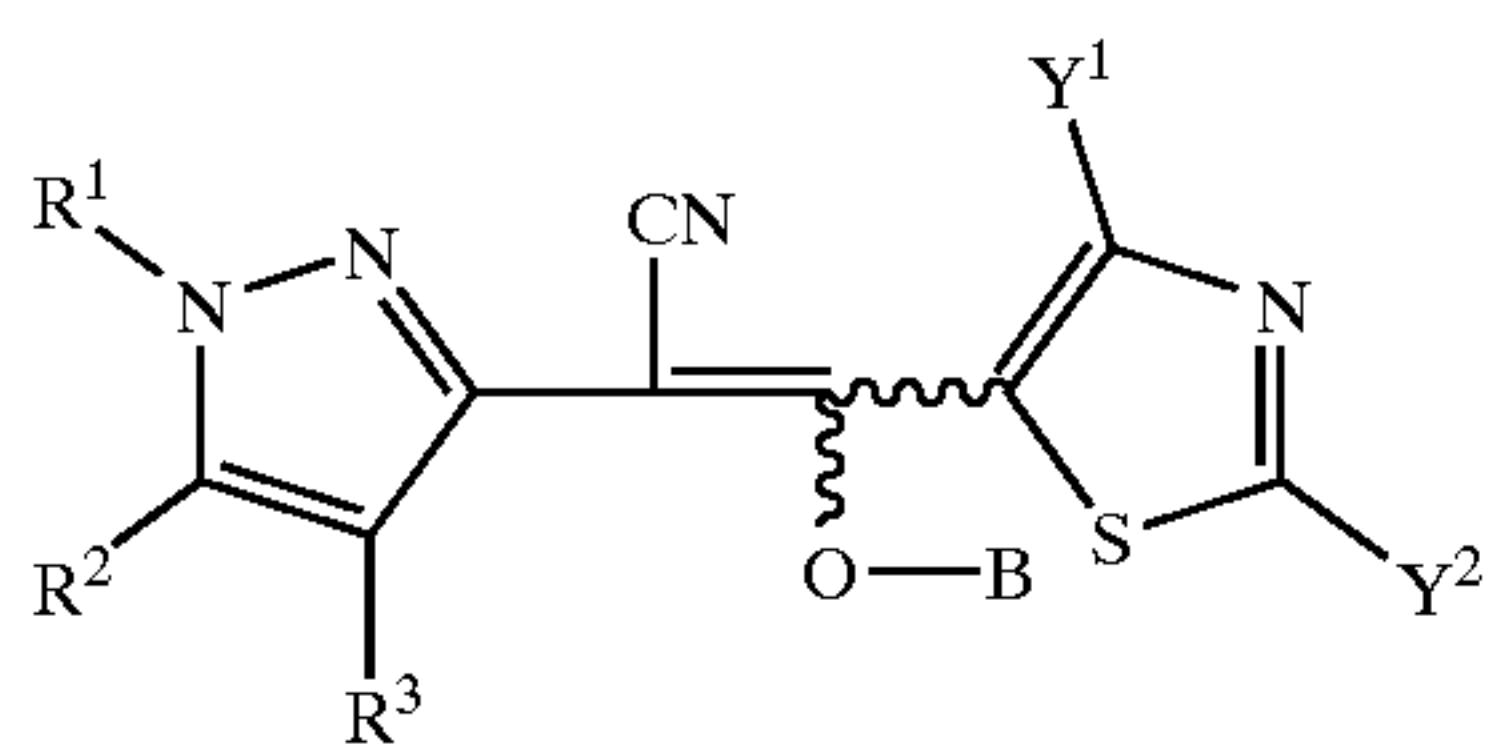
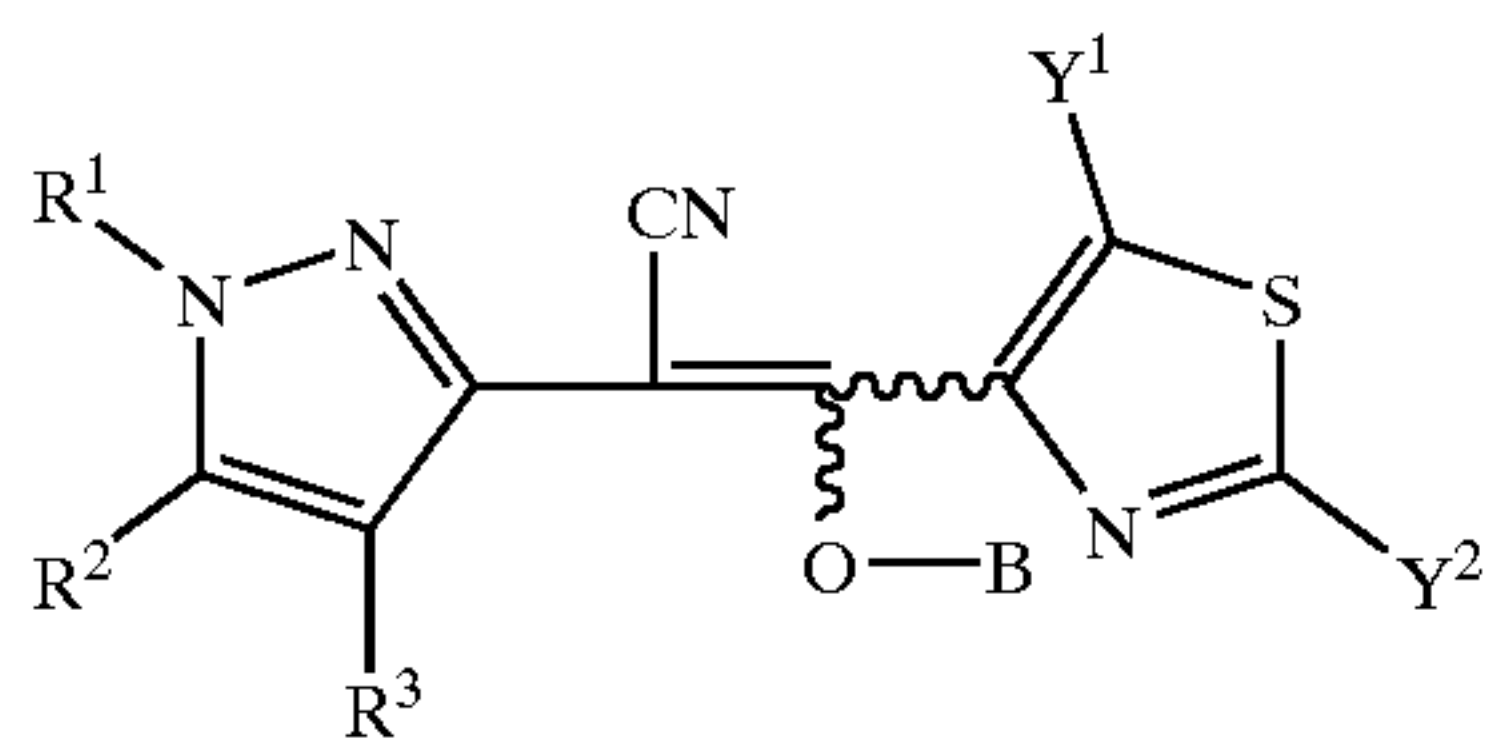
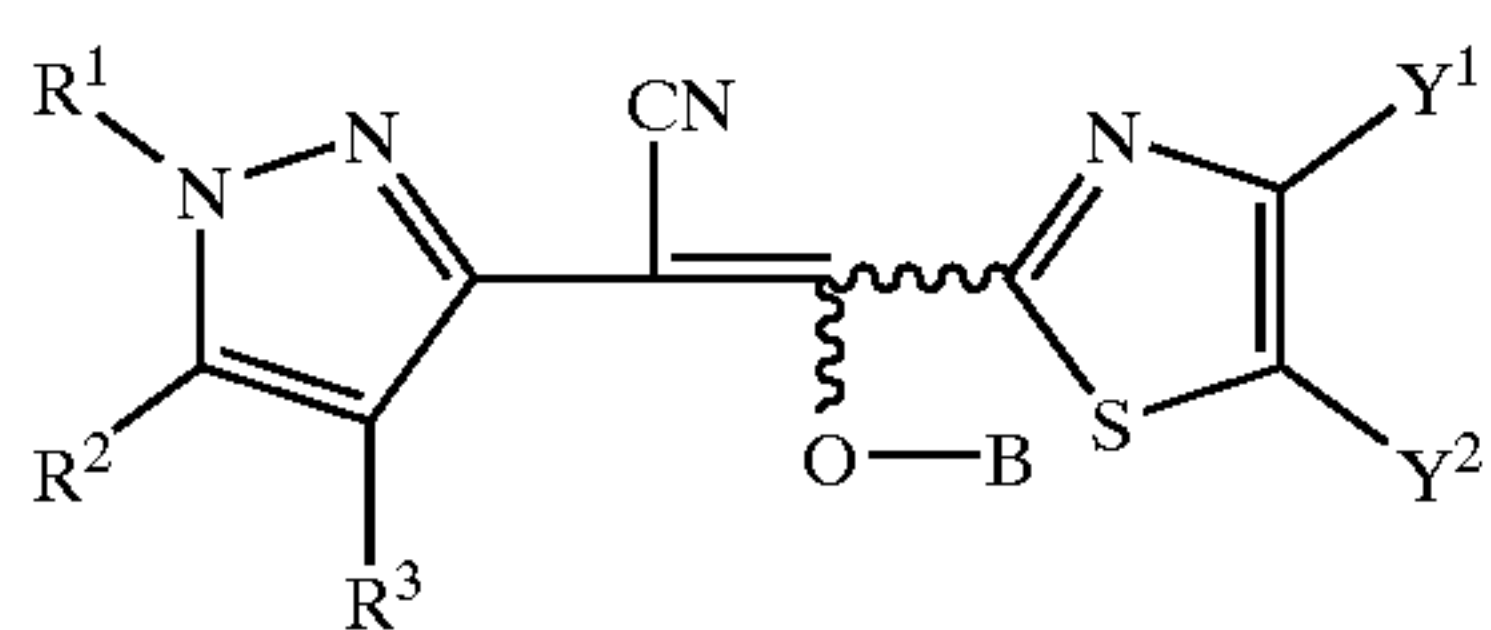

TABLE 3-continued

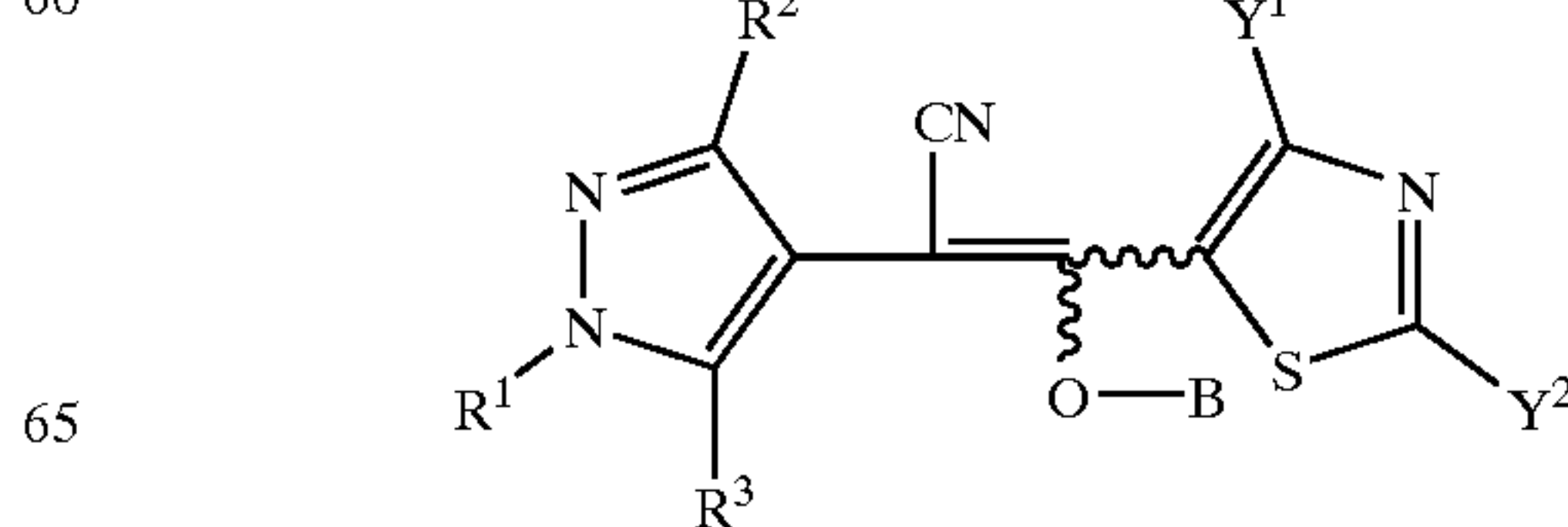
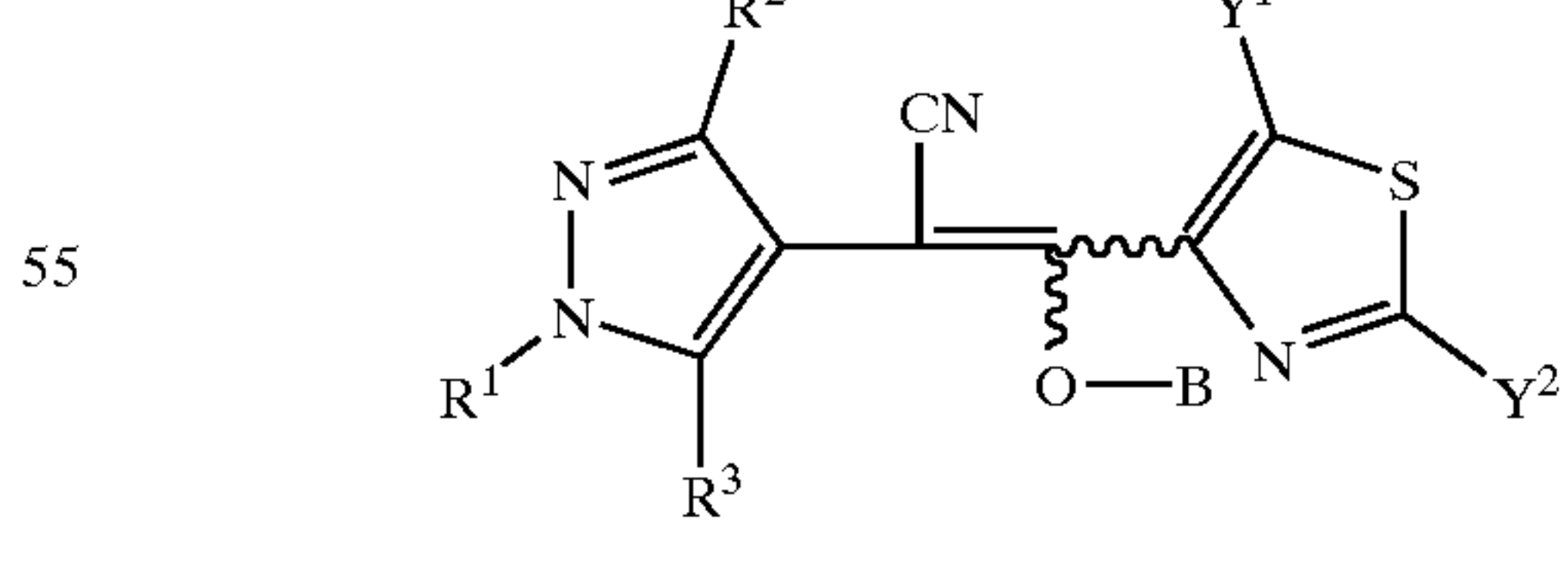
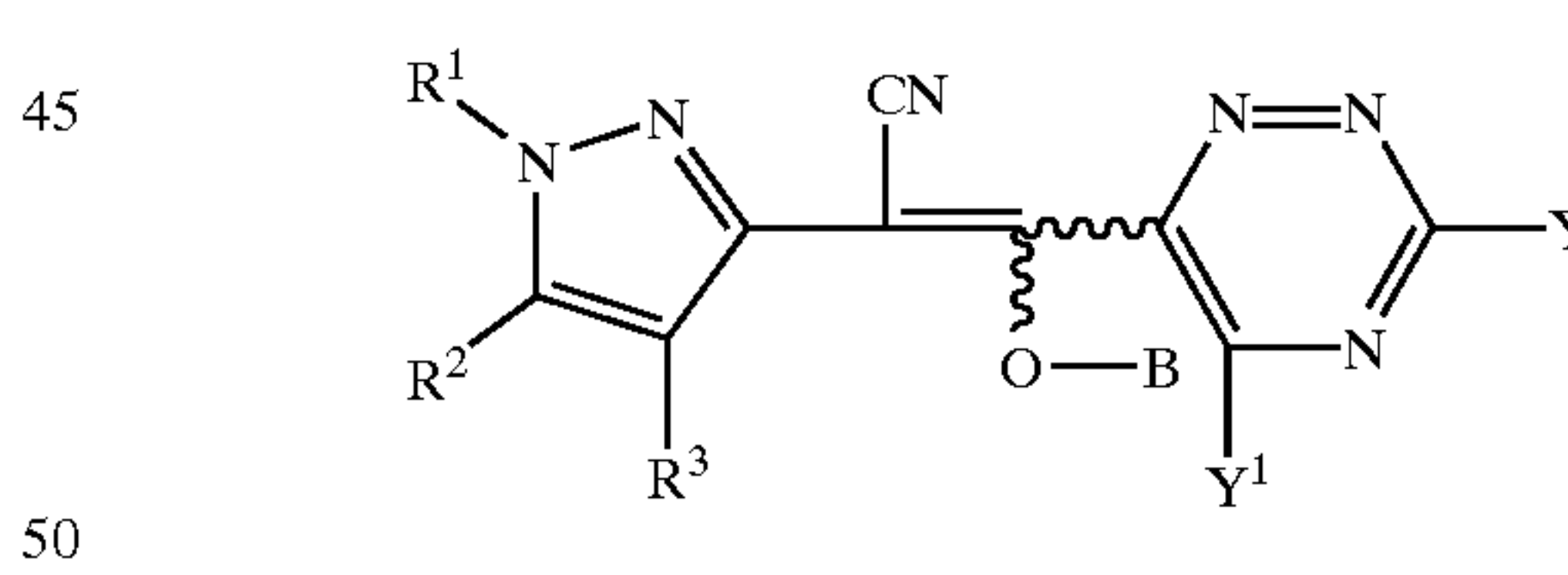
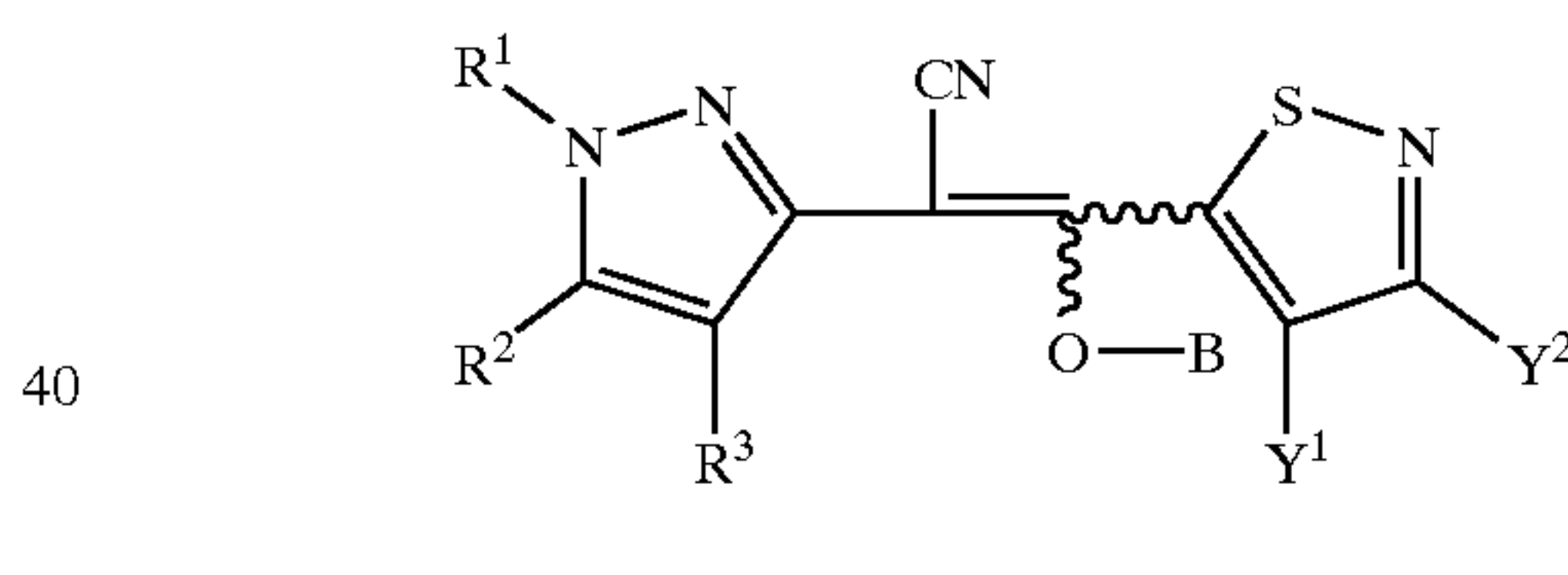
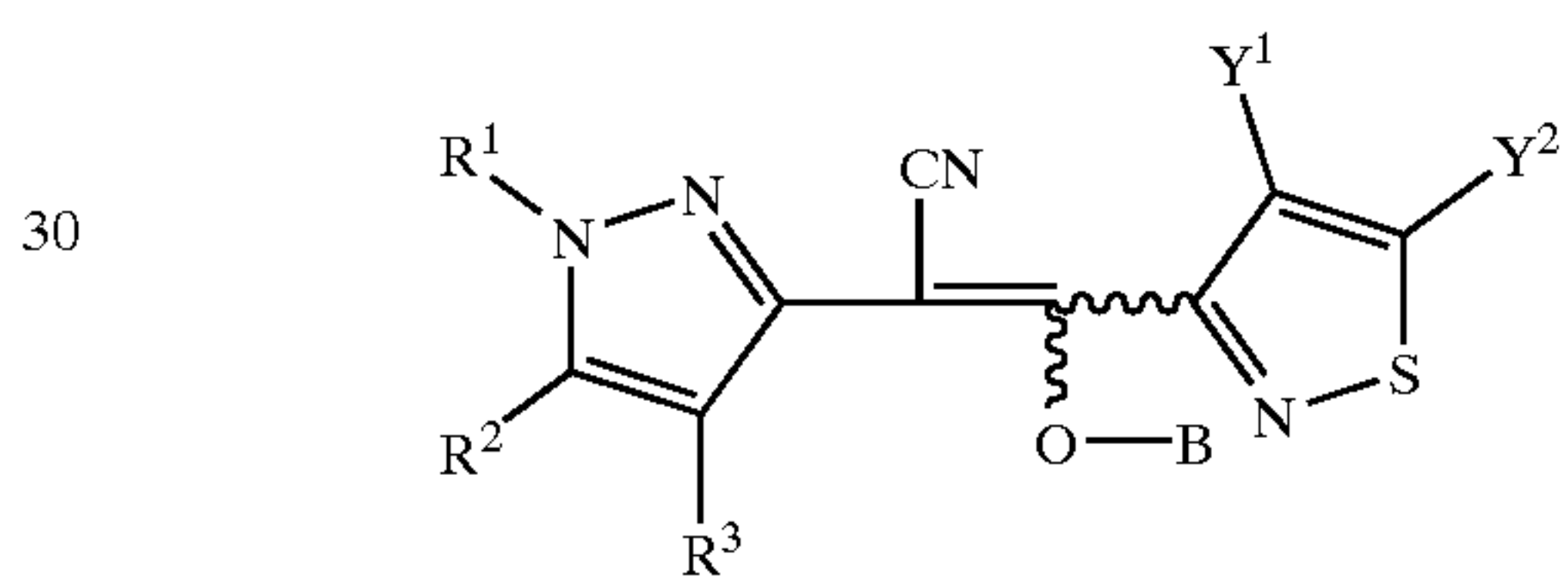
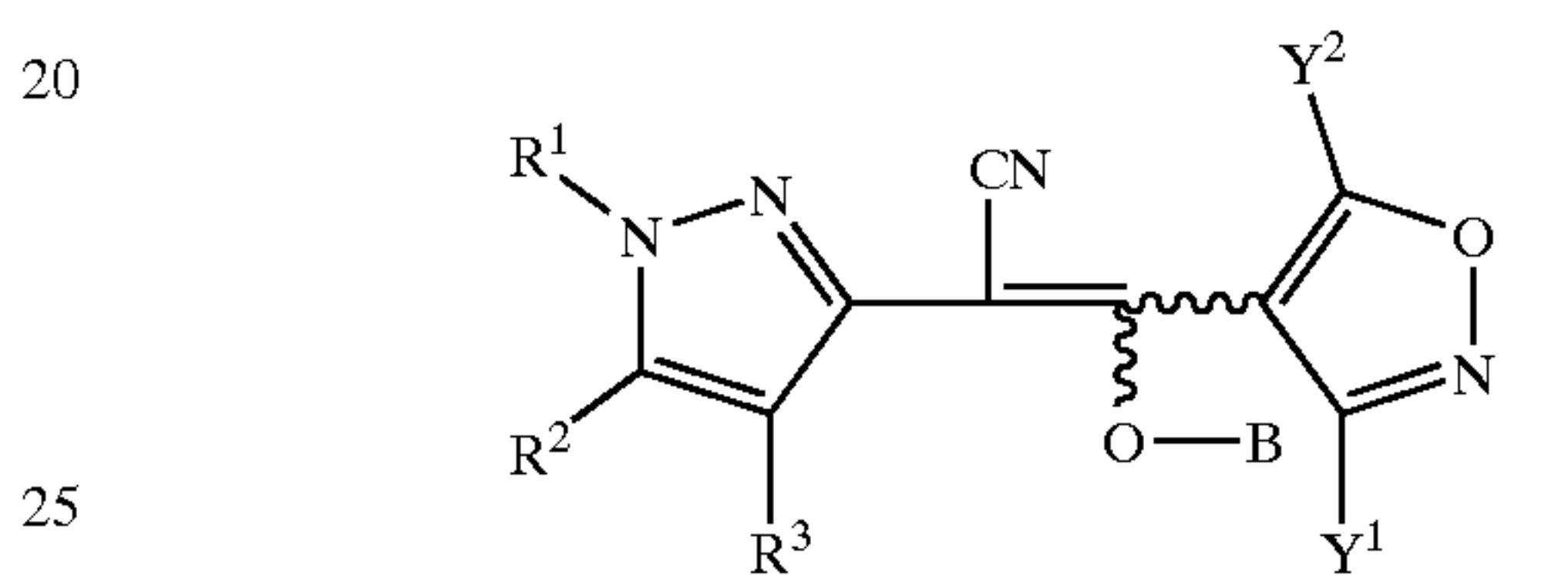
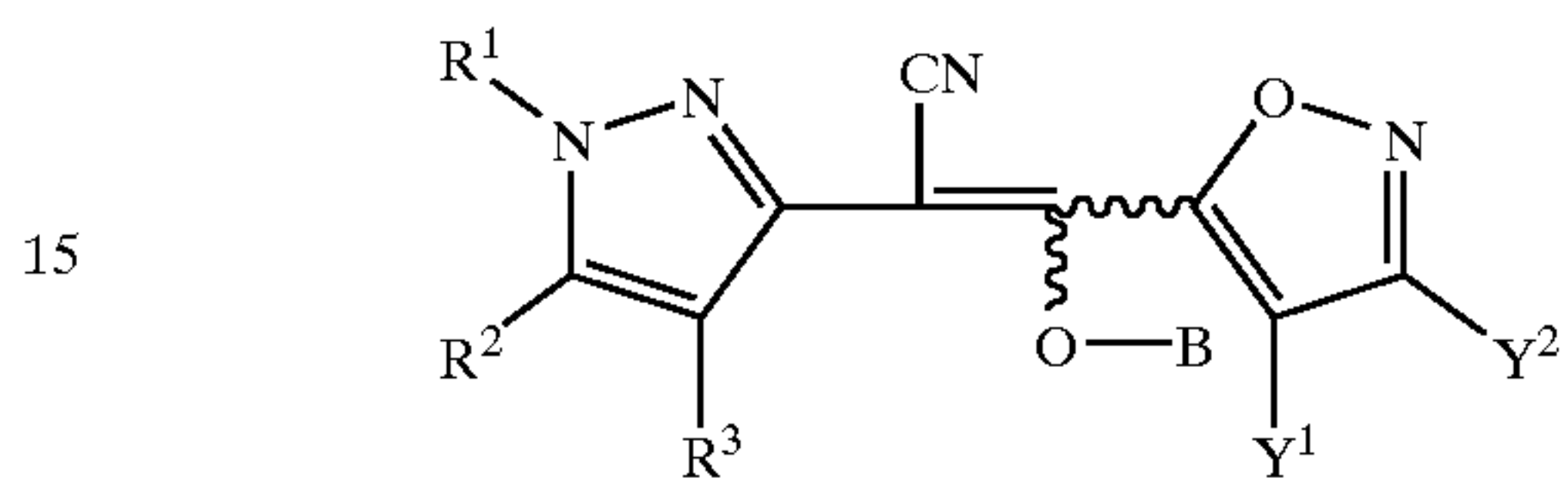
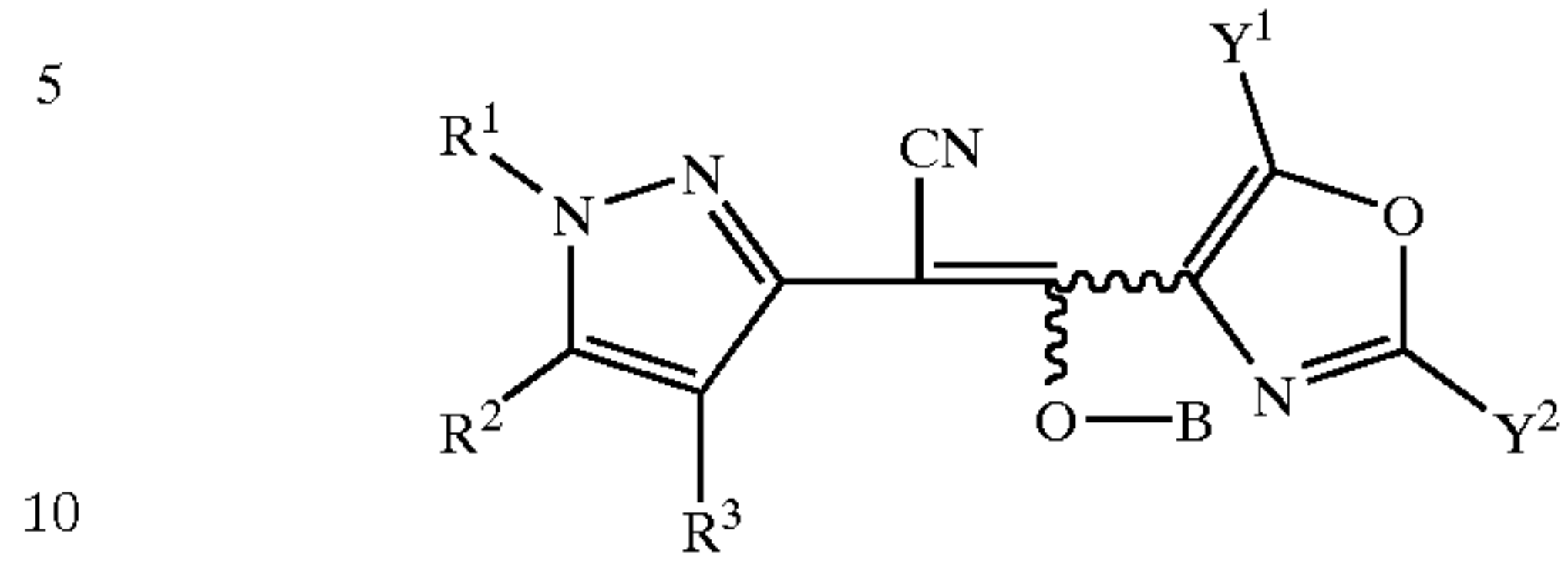

TABLE 3-continued

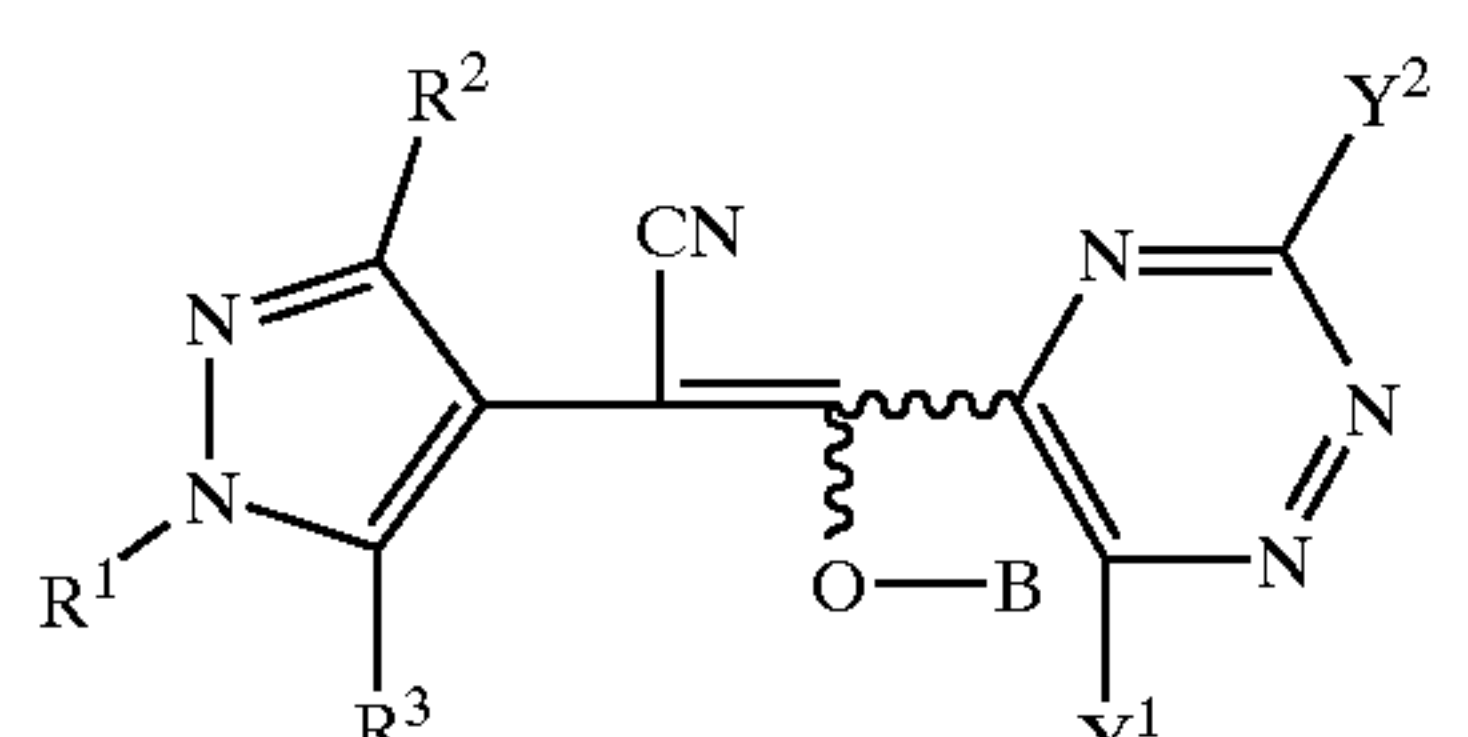
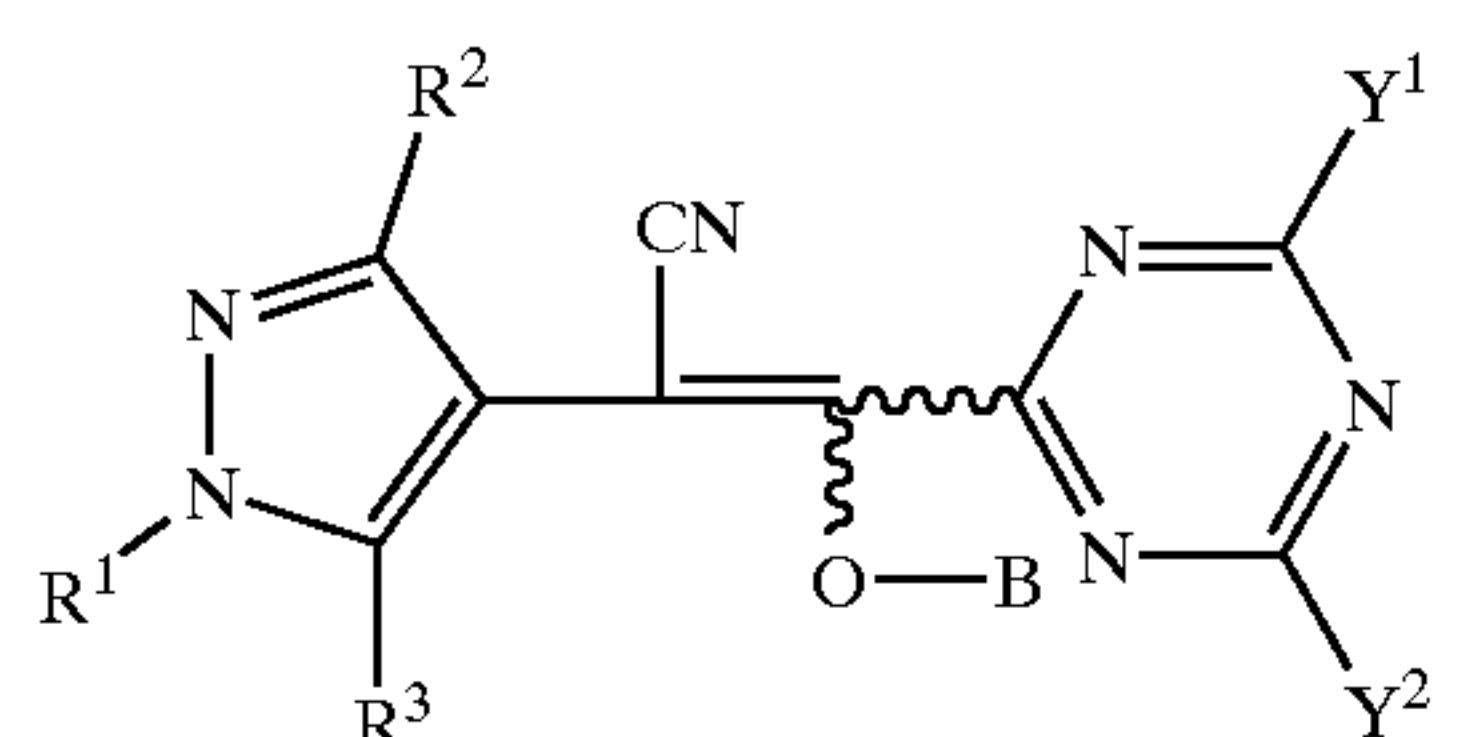
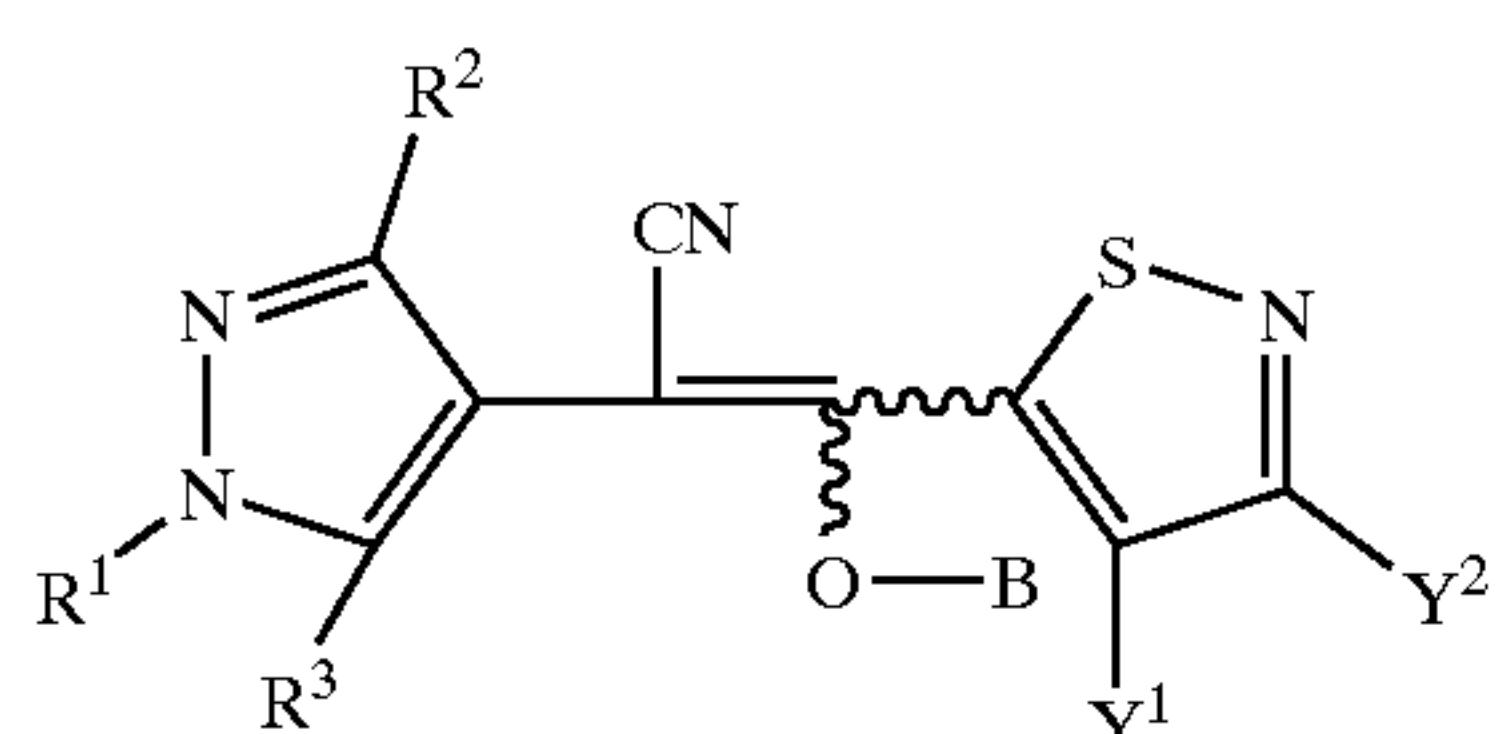
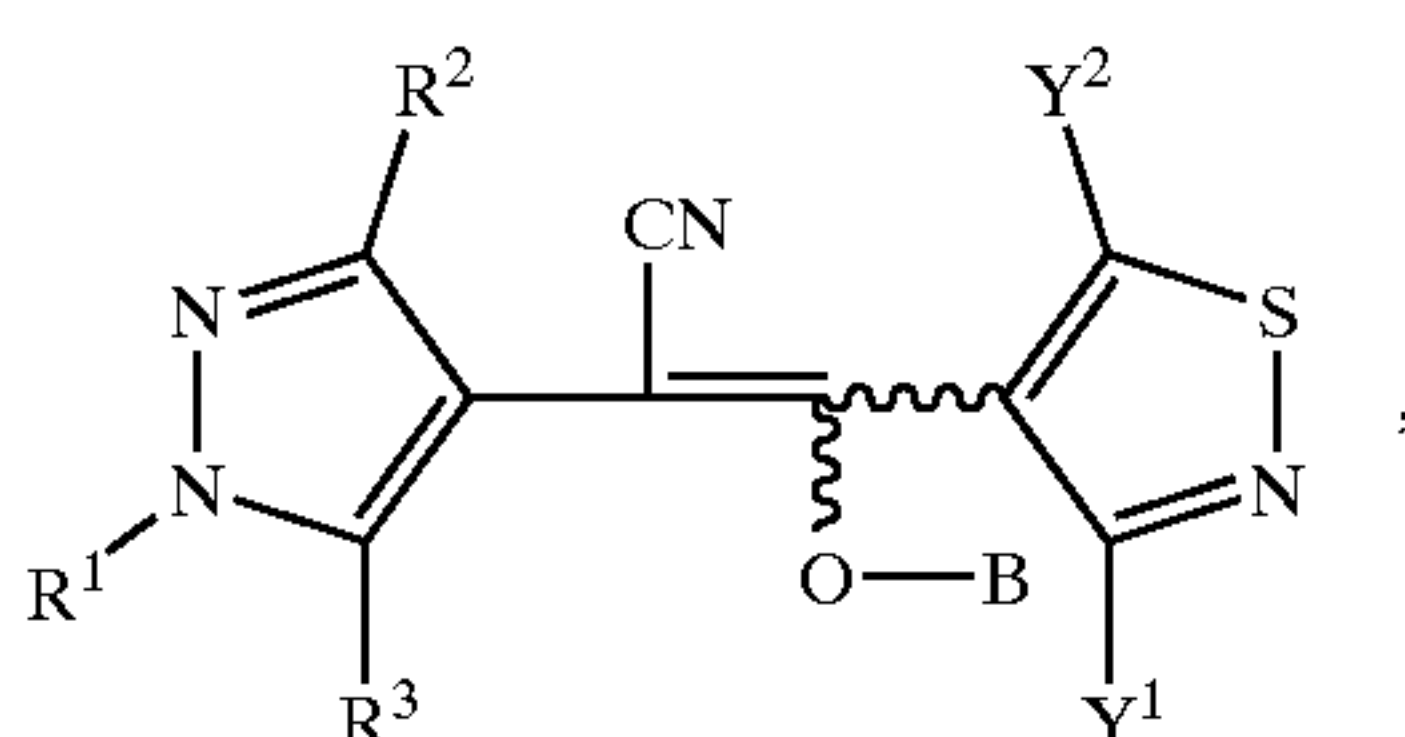
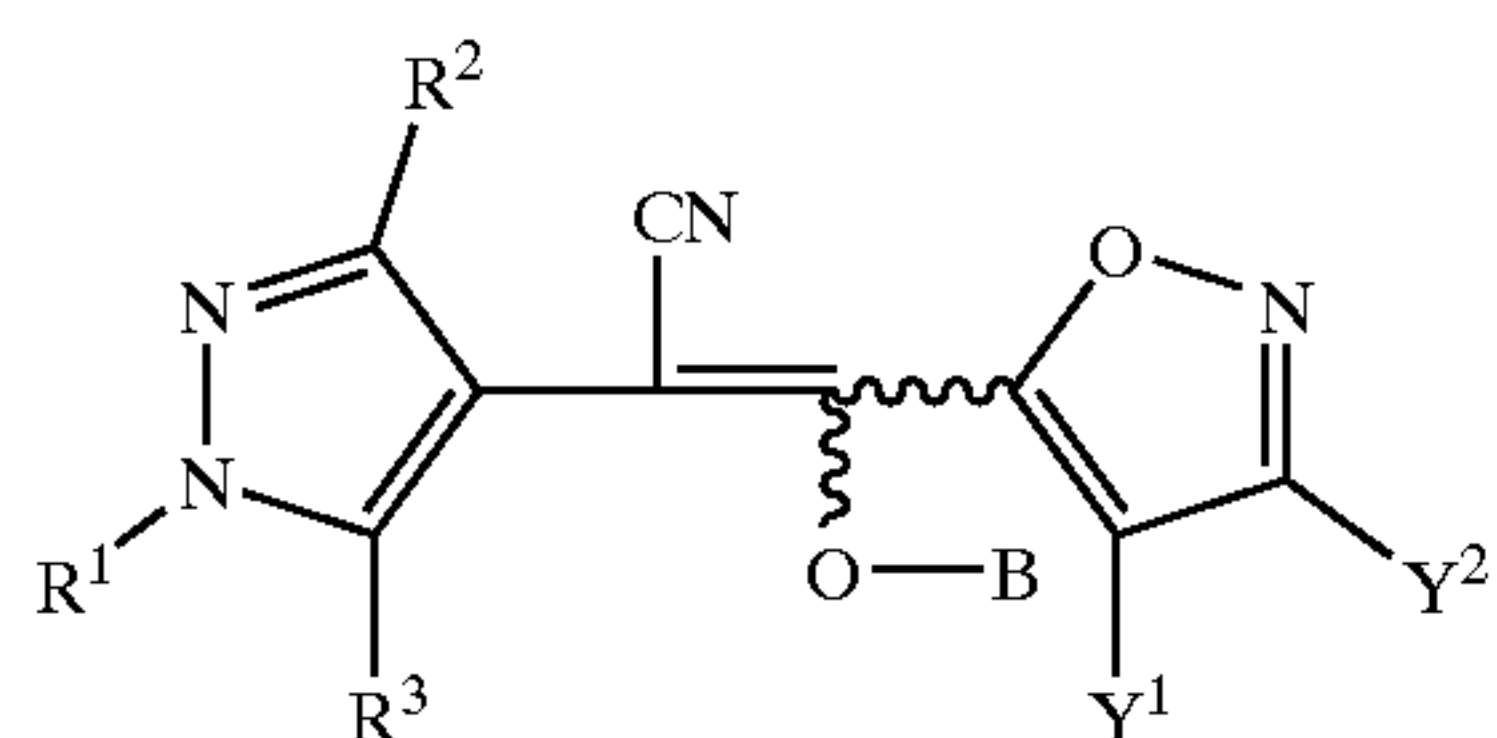
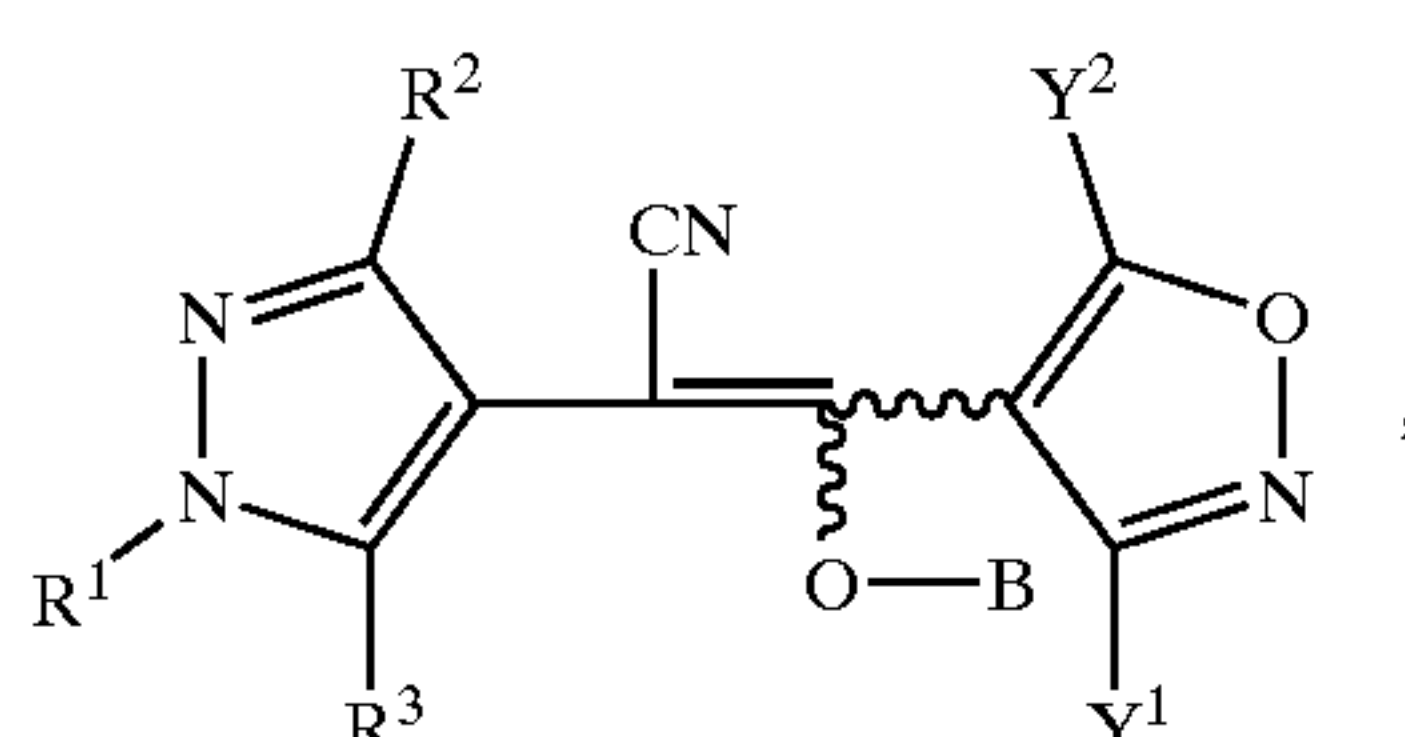
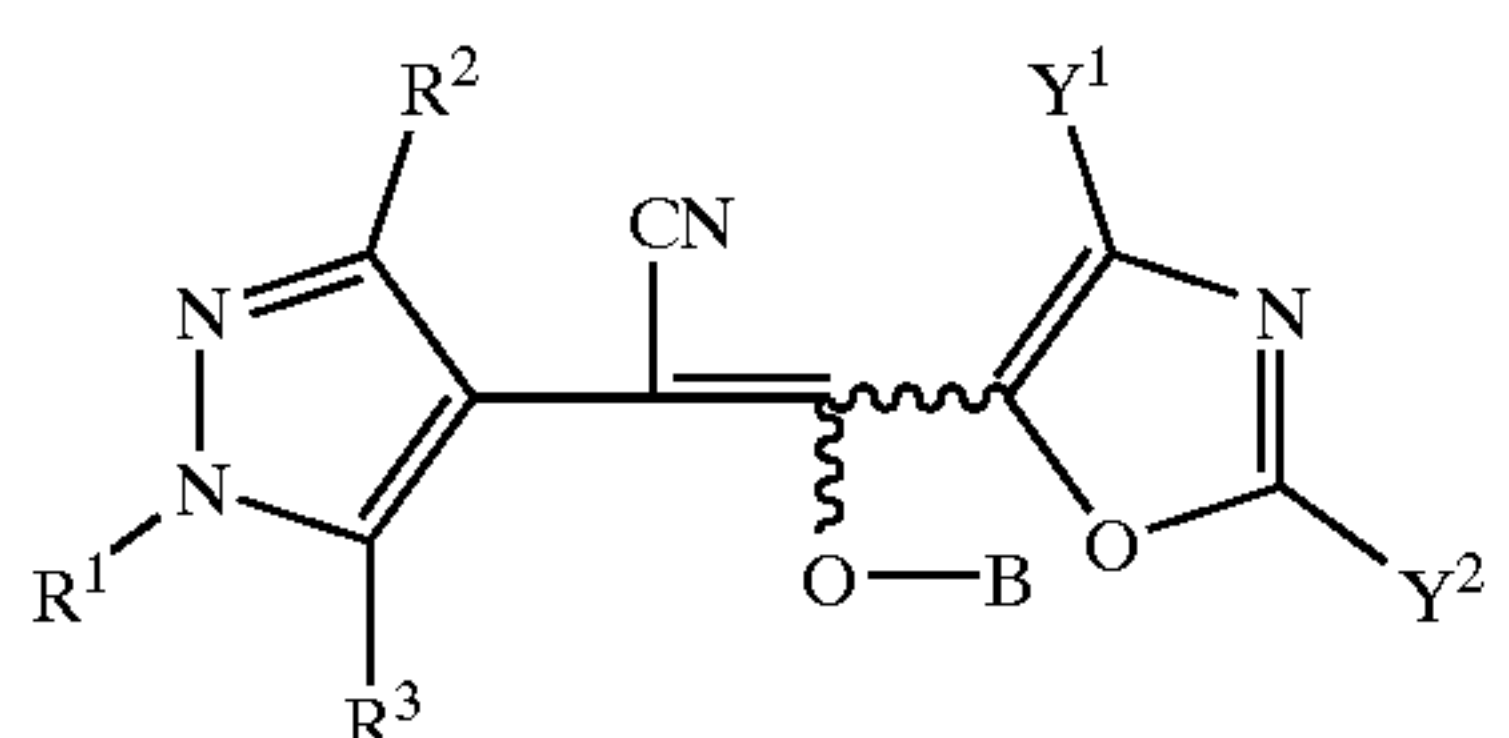
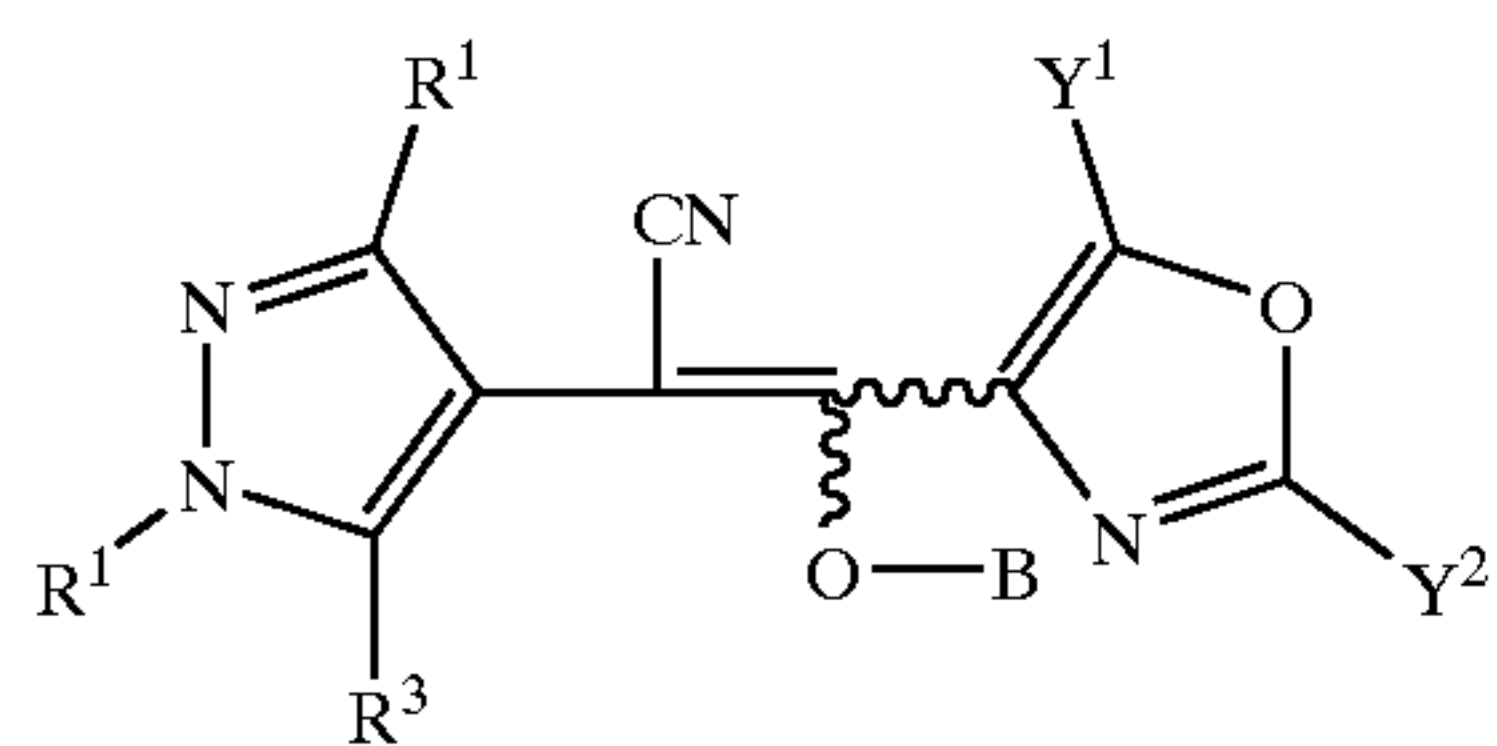
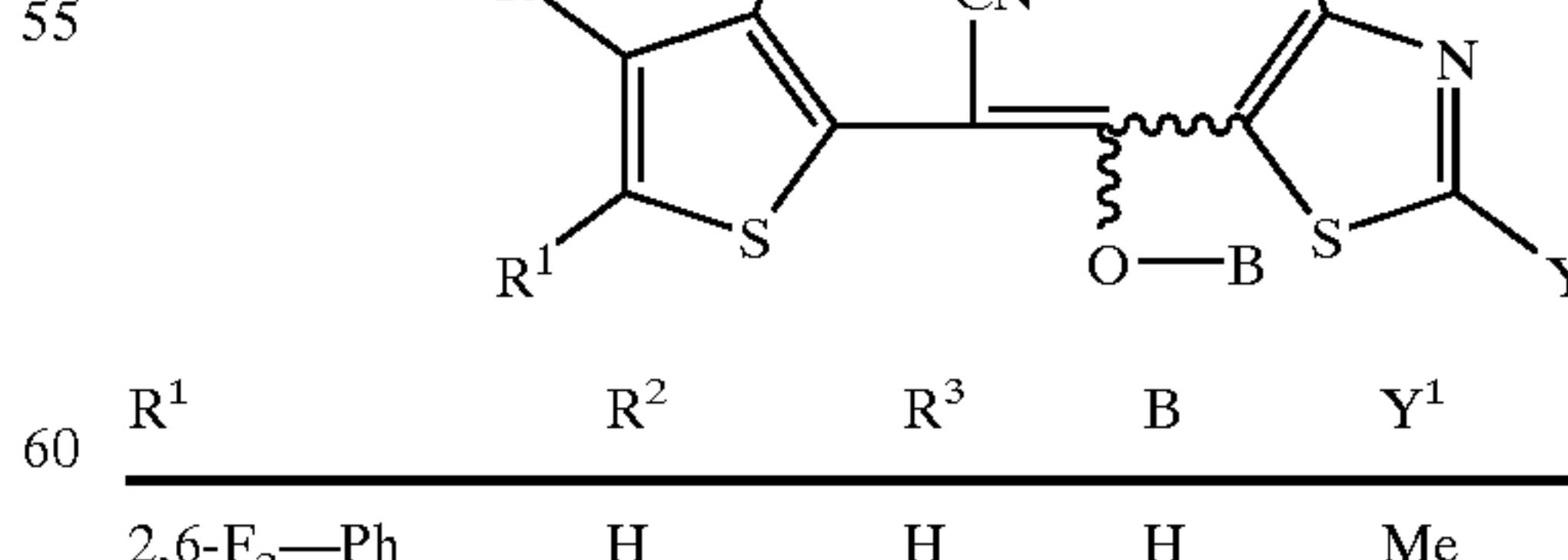
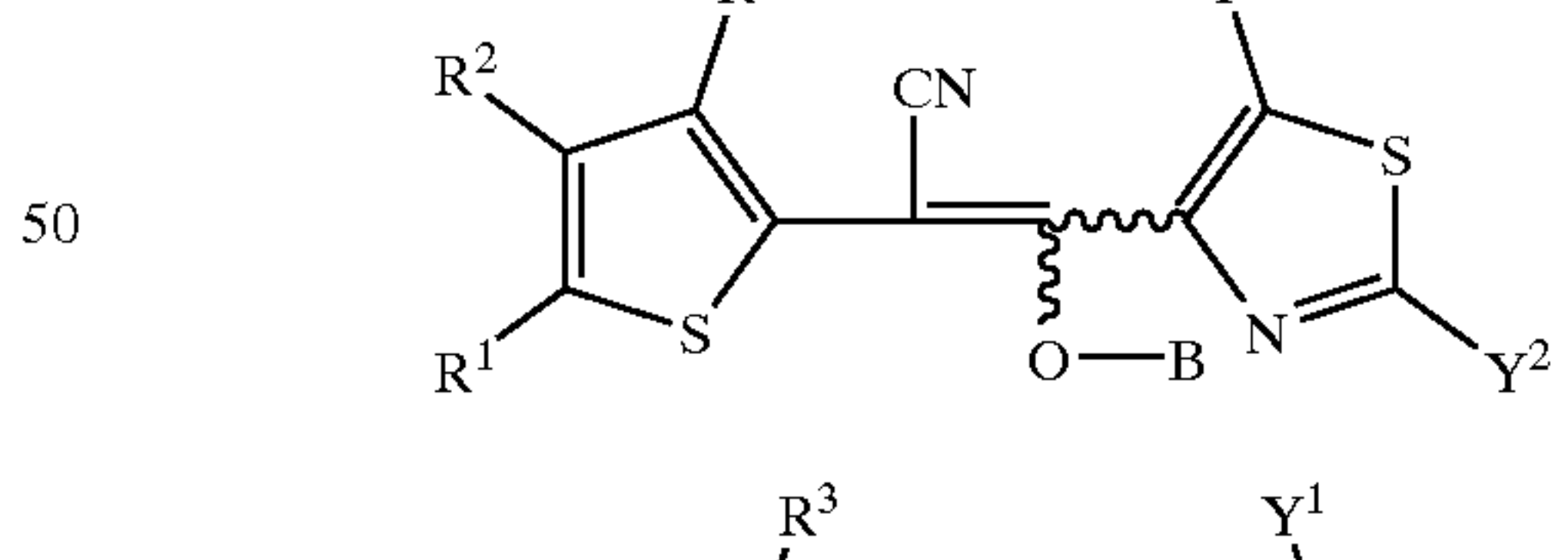
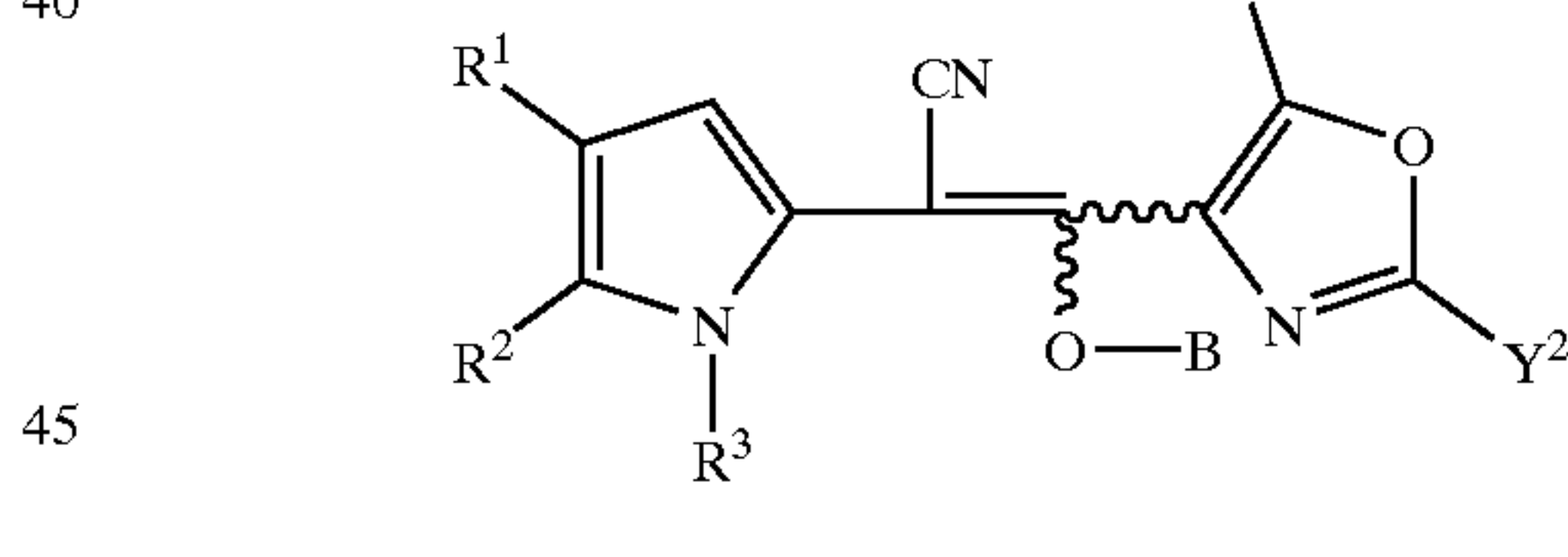
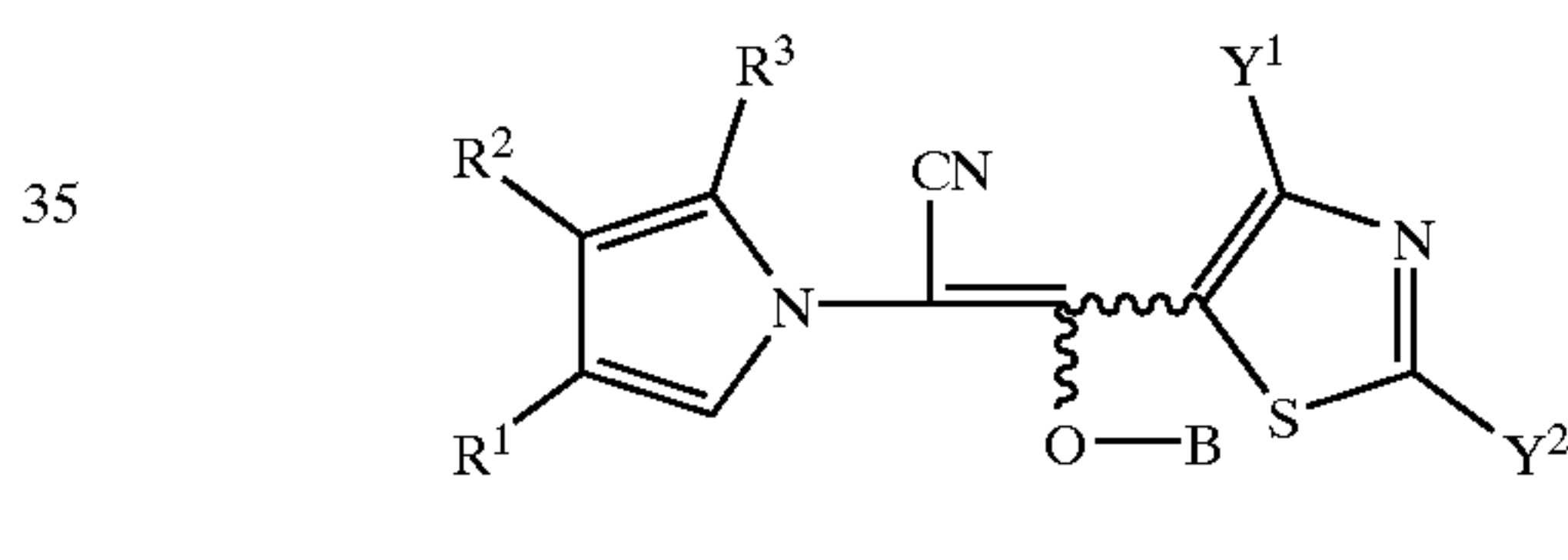
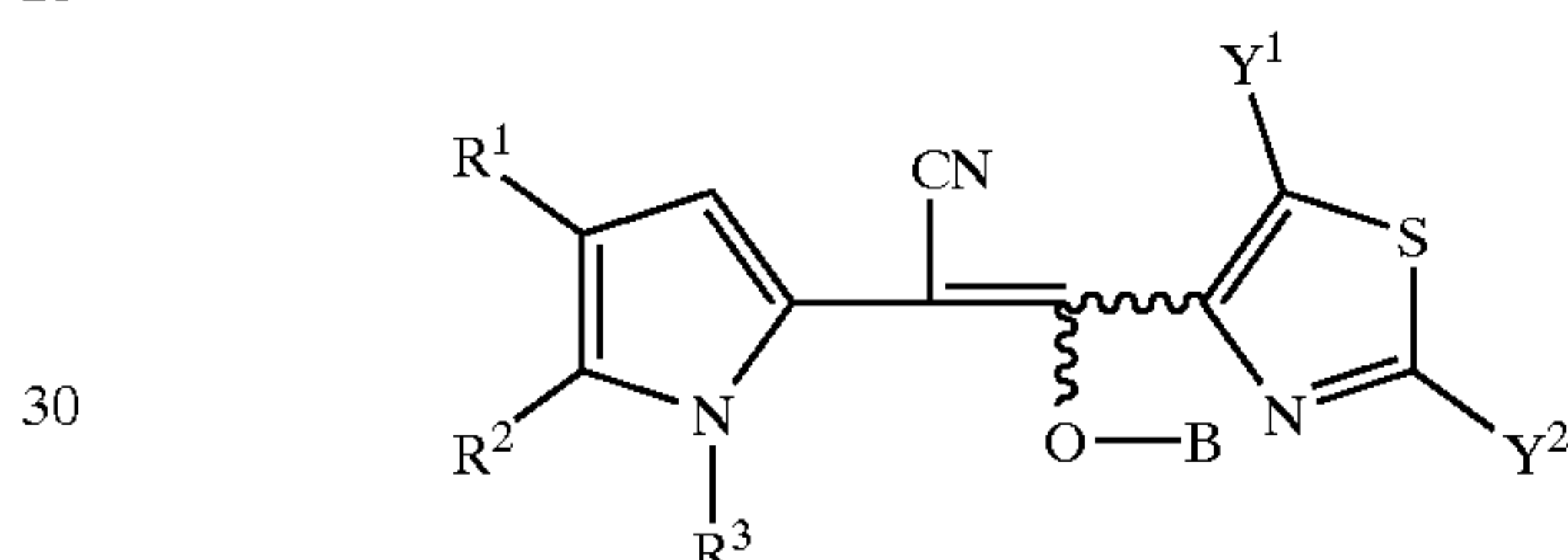
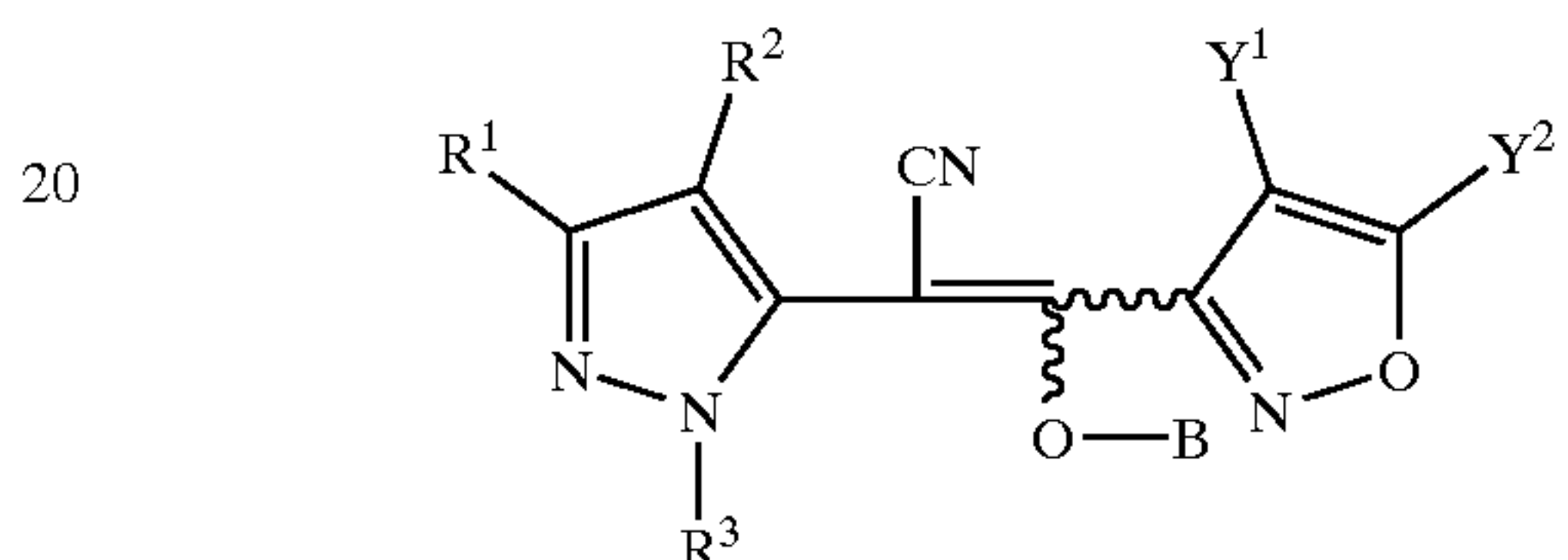
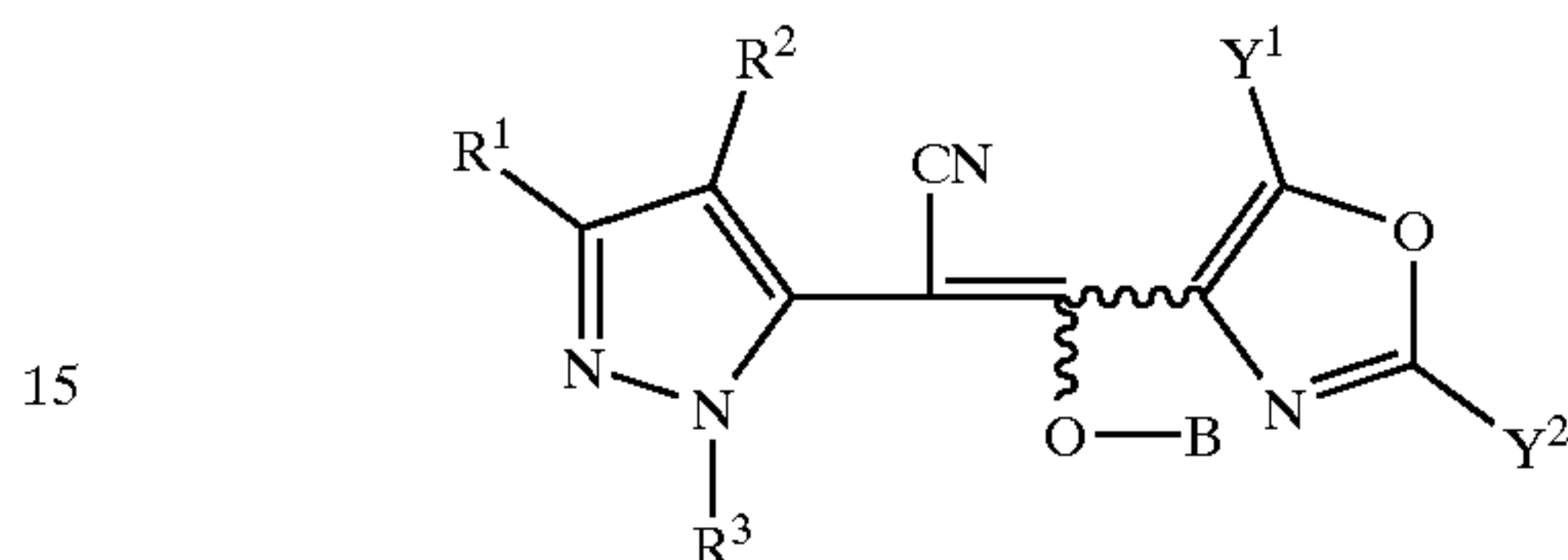
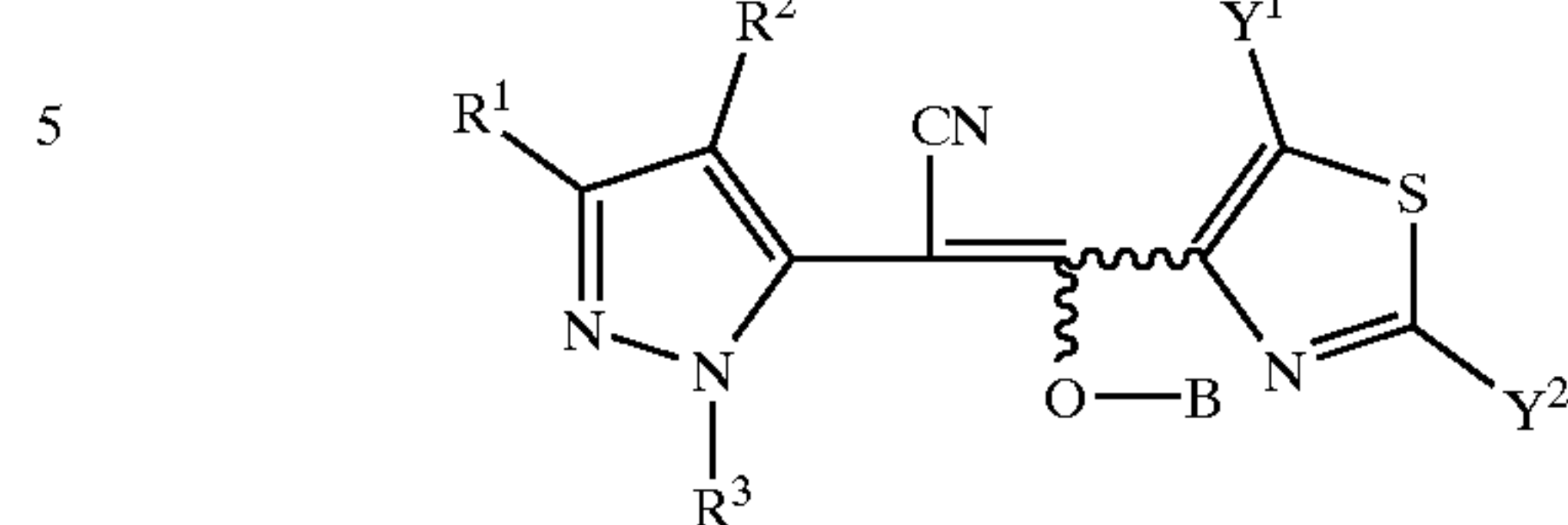

TABLE 3-continued



	R ¹	R ²	R ³	B	Y ¹	Y ²
60	2,6-F ₂ -Ph	H	H	H	Me	Me
	2,6-F ₂ -Ph	H	H	H	Et	Me
	2,6-F ₂ -Ph	Me	H	H	Et	Me
	2,6-F ₂ -Ph	Cl	H	H	Et	Me
	2,6-F ₂ -Ph	H	Cl	H	Et	Me
65	2,6-F ₂ -Ph	H	H	H	Cl	Cl
	2,6-F ₂ -Ph	H	H	H	Cl	Me

TABLE 3-continued

2,6-F ₂ -Ph	H	H	H	Cl	CF ₃
2,6-F ₂ -Ph	H	H	H	Me	Cl
2,6-F ₂ -Ph	H	H	H	Br	Me
2,6-F ₂ -Ph	H	H	H	Me	Br
2,6-F ₂ -Ph	H	H	H	Me	CF ₃
2,6-F ₂ -Ph	H	H	H	OMe	Me
2,6-F ₂ -Ph	H	H	H	OCF ₃	Me
2,6-F ₂ -Ph	H	H	H	SMe	Me
2,6-F ₂ -Ph	H	H	H	CO ₂ Me	Me
2,6-F ₂ -Ph	H	H	H	CO ₂ Et	Me
2,6-F ₂ -Ph	H	H	H	CF ₃	Me
2,6-F ₂ -Ph	H	H	H	CF ₃	H
2,6-F ₂ -Ph	H	H	B3	CF ₃	Me
2,6-F ₂ -Ph	H	H	B6	CF ₃	Me
2,6-F ₂ -Ph	H	H	B7	CF ₃	Me
2,6-F ₂ -Ph	Cl	H	B7	CF ₃	Me
tBu	H	H	H	Me	Me
tBu	H	H	H	Et	Me
tBu	H	H	H	Cl	Cl
tBu	H	H	H	Cl	Me
tBu	H	H	H	Me	Cl
tBu	H	H	H	Cl	CF ₃
tBu	H	H	H	Br	Me
tBu	H	H	H	Me	Br
tBu	H	H	H	Me	CF ₃
tBu	H	H	H	OMe	Me
tBu	H	H	H	OCF ₃	Me
tBu	H	H	H	SMe	Me
tBu	H	H	H	CO ₂ Me	Me
tBu	H	H	H	CO ₂ Et	Me
tBu	H	H	H	CF ₃	Me
tBu	Me	H	H	CF ₃	Me
tBu	Cl	H	H	CF ₃	Me
tBu	Br	H	H	CF ₃	Me
tBu	CF ₃	H	H	CF ₃	Me
tBu	NO ₂	H	H	CF ₃	Me
tBu	CN	H	H	CF ₃	Me
tBu	CO ₂ Me	H	H	CF ₃	Me
tBu	CO ₂ Et	H	H	CF ₃	Me
tBu	H	H	H	CF ₃	H
tBu	H	H	H	CF ₃	Br
tBu	H	H	H	CF ₃	NO ₂
tBu	H	H	H	CF ₃	CN
tBu	H	H	H	CF ₃	NHMe
tBu	H	H	H	CF ₃	NMe ₂
tBu	H	H	H	CF ₃	CO ₂ Me
tBu	H	H	B2	CF ₃	Me
tBu	H	H	B3	CF ₃	Me
tBu	H	H	B4	CF ₃	Me
tBu	H	H	B5	CF ₃	Me
tBu	H	H	B6	CF ₃	Me
tBu	H	H	B7	CF ₃	Me
tBu	Cl	H	B7	CF ₃	Me
tBu	H	H	B8	CF ₃	Me
tBu	H	H	B9	CF ₃	Me
tBu	H	H	B10	CF ₃	Me
tBu	H	H	B11	CF ₃	Me
tBu	H	H	B12	CF ₃	Me
tBu	H	H	B13	CF ₃	Me
tBu	H	H	B14	CF ₃	Me
tBu	H	H	B15	CF ₃	Me
tBu	H	H	B16	CF ₃	Me
tBu	H	H	B17	CF ₃	Me
tBu	H	H	B18	CF ₃	Me
tBu	H	H	B19	CF ₃	Me
tBu	H	H	B20	CF ₃	Me
tBu	H	H	B21	CF ₃	Me
tBu	H	H	B22	CF ₃	Me
tBu	H	H	B23	CF ₃	Me
tBu	H	H	B24	CF ₃	Me
tBu	H	H	B25	CF ₃	Me
tBu	H	H	B26	CF ₃	Me
tBu	H	H	B27	CF ₃	Me
tBu	H	H	B28	CF ₃	Me
tBu	H	H	B29	CF ₃	Me
tBu	H	H	B30	CF ₃	Me
tBu	H	H	B31	CF ₃	Me
tBu	H	H	B32	CF ₃	Me
tBu	H	H	B33	CF ₃	Me

TABLE 3-continued

tBu	H	H	B34	CF ₃	Me
tBu	H	H	Na	CF ₃	Me
tBu	H	H	K	CF ₃	Me
2-pyridyl	H	H	H	Me	Me
2-pyridyl	H	H	H	Et	Me
2-pyridyl	H	H	H	Cl	Cl
2-pyridyl	H	H	H	Cl	Me
2-pyridyl	H	H	H	Cl	CF ₃
2-pyridyl	H	H	H	Me	Cl
2-pyridyl	H	H	H	Br	Me
2-pyridyl	H	H	H	Me	Br
2-pyridyl	H	H	H	Me	CF ₃
2-pyridyl	H	H	H	OMe	Me
2-pyridyl	H	H	H	OCF ₃	Me
2-pyridyl	H	H	H	SMe	Me
2-pyridyl	H	H	H	CO ₂ Me	Me
2-pyridyl	H	H	H	CO ₂ Et	Me
2-pyridyl	H	H	H	CF ₃	Me
2-pyridyl	H	H	H	CF ₃	H
2-pyridyl	H	H	B3	CF ₃	Me
2-pyridyl	H	H	B6	CF ₃	Me
2-pyridyl	H	H	B7	CF ₃	Me
3-pyridyl	H	H	H	CF ₃	Me
4-pyridyl	H	H	H	CF ₃	Me
2-F-Ph	H	H	H	Me	Me
2-F-Ph	H	H	H	Et	Me
2-F-Ph	H	H	H	CF ₃	Me
2-F-Ph	H	H	H	CF ₃	Cl
2-F-Ph	H	H	H	CF ₃	H
2-F-Ph	H	H	B3	CF ₃	Me
2-F-Ph	H	H	B6	CF ₃	Me
2-F-Ph	H	H	B7	CF ₃	Me
3-F-Ph	H	H	H	CF ₃	Me
4-F-Ph	H	H	H	CF ₃	Me
2,3-F ₂ -Ph	H	H	H	CF ₃	Me
2,4-F ₂ -Ph	H	H	H	CF ₃	Me
2,5-F ₂ -Ph	H	H	H	CF ₃	Me
Ph	H	H	H	Me	Me
Ph	H	H	H	Et	Me
Ph	H	H	H	CF ₃	Me
Ph	H	H	H	CF ₃	Cl
Ph	H	H	H	CF ₃	H
Ph	H	H	B3	CF ₃	Me
Ph	H	H	B6	CF ₃	Me
Ph	H	H	B7	CF ₃	Me
3,4-F ₂ -Ph	H	H	H	CF ₃	Me
3,5-F ₂ -Ph	H	H	H	CF ₃	Me
2-Cl-Ph	H	H	H	Me	Me
2-Cl-Ph	H	H	H	Et	Me
2-Cl-Ph	H	H	H	CF ₃	Me
2-Cl-Ph	H	H	H	CF ₃	Cl
2-Cl-Ph	H	H	H	CF ₃	H
2-Cl-Ph	H	H	B3	CF ₃	Me
2-Cl-Ph	H	H	B6	CF ₃	Me
2-Cl-Ph	H	H	B7	CF ₃	Me
3-Cl-Ph	H	H	H	CF ₃	Me
4-Cl-Ph	H	H	H	CF ₃	Me
2,3-Cl ₂ -Ph	H	H	H	CF ₃	Me
2,4-Cl ₂ -Ph	H	H	H	CF ₃	Me
2,5-Cl ₂ -Ph	H	H	H	CF ₃	Me
2,6-Cl ₂ -Ph	H	H	H	Me	Me
2,6-Cl ₂ -Ph	H	H	H	Et	Me
2,6-Cl ₂ -Ph	H	H	H	CF ₃	Me
2,6-Cl ₂ -Ph	H	H	H	CF ₃	Cl
2,6-Cl ₂ -Ph	H	H	H	CF ₃	H
2,6-Cl ₂ -Ph	H	H	B3	CF ₃	Me
2,6-Cl ₂ -Ph	H	H	B6	CF ₃	Me
2,6-Cl ₂ -Ph	H	H	B7	CF ₃	Me
3,4-Cl ₂ -Ph	H	H	H	CF ₃	Me
3,5-Cl ₂ -Ph	H	H	H	CF ₃	Me
2-Me-Ph	H	H	H	CF ₃	Me
2,6-Me ₂ -Ph	H	H	H	CF ₃	Me
2-MeO-Ph	H	H	H	CF ₃	Me
2-CF ₃ O-Ph	H	H	H	CF ₃	Me
2-SMe-Ph	H	H	H	CF ₃	Me
2-SOMe-Ph	H	H	H	CF ₃	Me
2-SO ₂ Me-Ph	H	H	H	CF ₃	Me
2-CF ₃ -Ph	H	H	H	CF ₃	Me
2-NO ₂ -Ph	H	H	H	CF ₃	Me

TABLE 3-continued

2-CN—Ph	H	H	H	CF ₃	Me
2-NHMe—Ph	H	H	H	CF ₃	Me
2-NMe ₂ —Ph	H	H	H	CF ₃	Me
4-benzyl-Ph	H	H	H	Et	Me
4-phenoxy-Ph	H	H	H	CF ₃	Me
2-OH—Ph	H	H	H	CF ₃	Me
2-CO ₂ Me—Ph	H	H	H	CF ₃	Me
2-CO ₂ Et—Ph	H	H	H	CF ₃	Me
H	CO ₂ Et	Ph	H	CF ₃	Me
Me	Ph	H	H	CF ₃	Me
Et	Me	H	H	CF ₃	Me
nPr	H	H	H	CF ₃	Me
iPr	H	H	H	Et	Me
iPr	H	H	H	CF ₃	Me
nBu	H	H	H	Et	Me
nBu	H	H	H	CF ₃	Me
iBu	H	H	H	Et	Me
iBu	H	H	H	CF ₃	Me
iBu	H	H	B7	Et	Me
iBu	H	H	B7	CF ₃	Me
secBu	H	H	H	Et	Me
secBu	H	H	H	CF ₃	Me
2,2-Me ₂ -propyl	H	H	H	CF ₃	Me
nHex	H	H	H	CF ₃	Me
ethenyl	H	H	H	CF ₃	Me
1-propenyl	H	H	H	CF ₃	Me
ethynyl	H	H	H	CF ₃	Me
1-propynyl	H	H	H	CF ₃	Me
CF ₃	H	H	H	CF ₃	Me
CHF ₂	H	H	H	CF ₃	Me
C ₂ F ₅	H	H	H	CF ₃	Me
2,2-Cl ₂ -cPr	H	H	H	Et	Me
2,2-Cl ₂ -cPr	H	H	H	CF ₃	Me
cPr	H	H	H	Et	Me
cPr	H	H	H	CF ₃	Me
1-Me-cPr	H	H	H	Et	Me
1-Me-cPr	H	H	H	CF ₃	Me
cHex	H	H	H	Et	Me
cHex	H	H	H	CF ₃	Me
CH ₂ Ph	H	H	H	CF ₃	Me
naphthyl-1	H	H	H	Et	Me
naphthyl-1	H	H	H	CF ₃	Me
naphthyl-2	H	H	H	CF ₃	Me
CO ₂ Me	H	H	H	CF ₃	Me
CO ₂ Et	H	H	H	CF ₃	Me
2-thienyl	H	H	H	CF ₃	Me
CH ₂ OMe	H	H	H	CF ₃	Me
CH ₂ OEt	H	H	H	CF ₃	Me
COCH ₃	H	H	H	CF ₃	Me
COtBu	H	H	H	CF ₃	Me
COPh	H	H	H	CF ₃	Me

TABLE 4

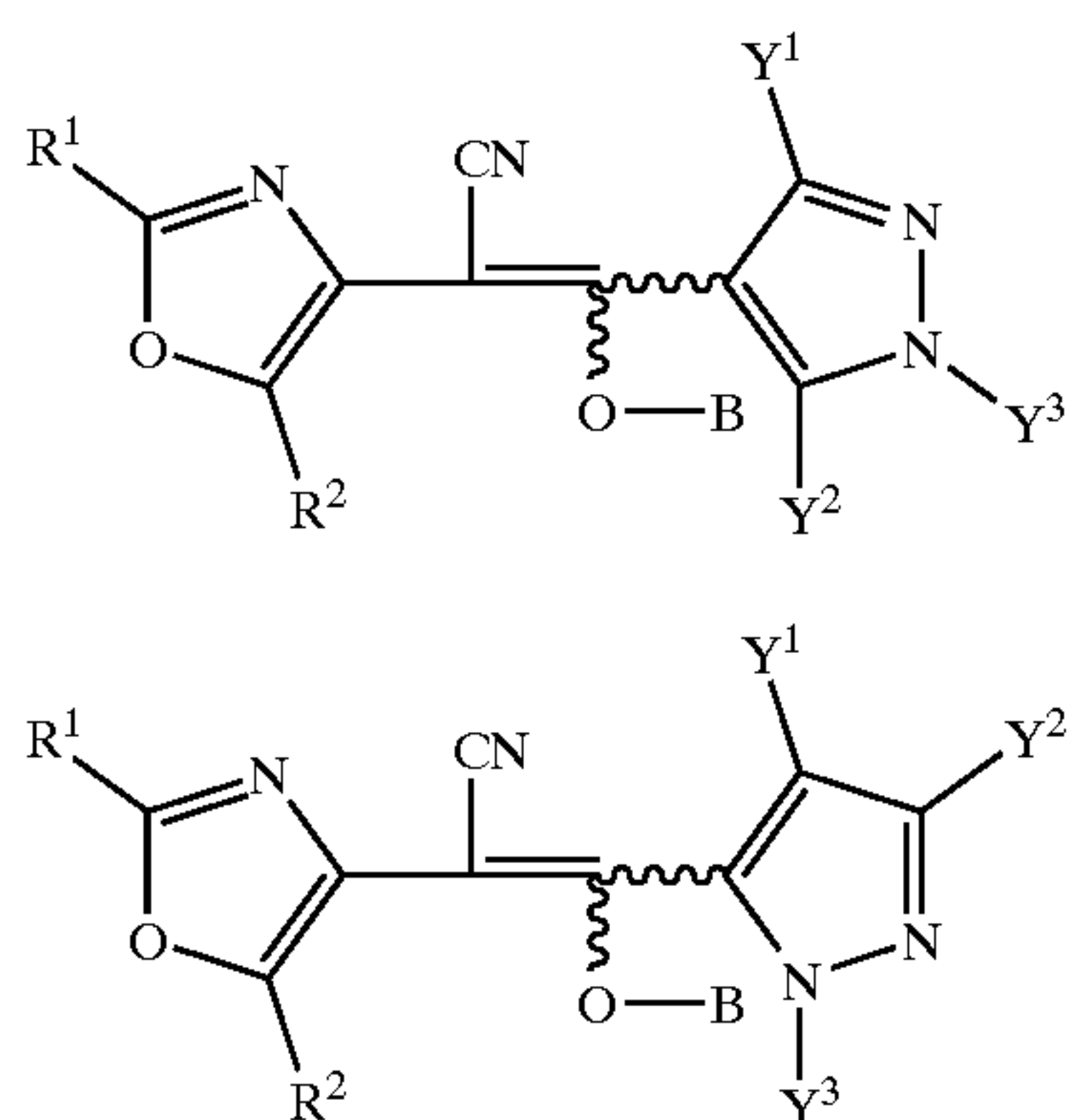

TABLE 4-continued

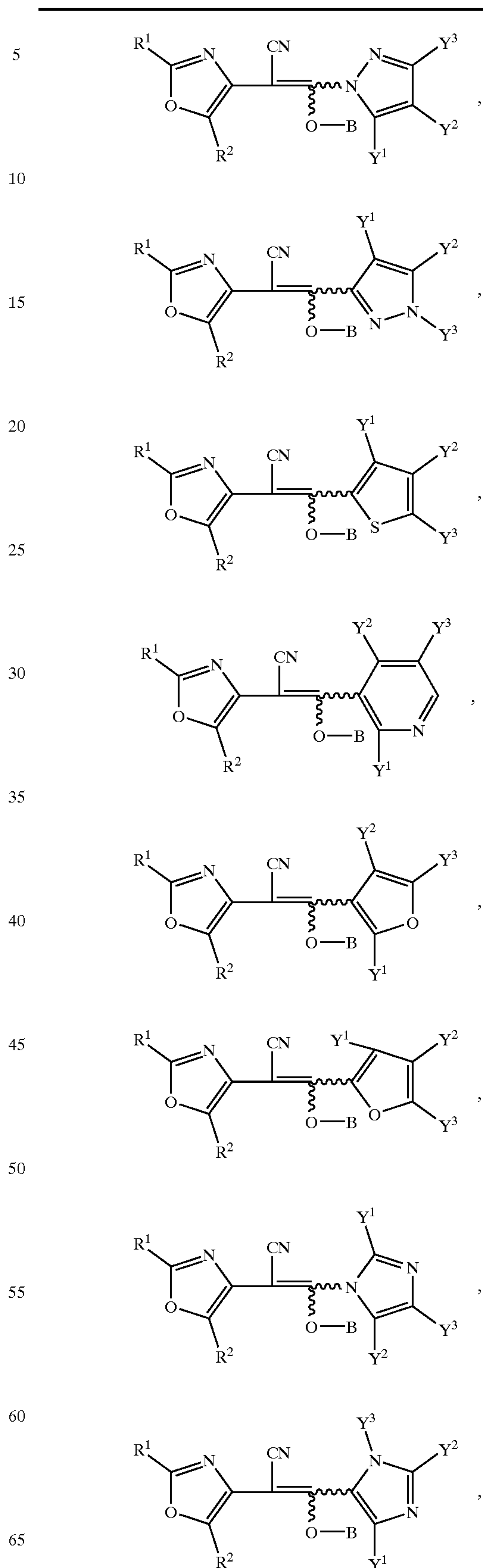

TABLE 4-continued

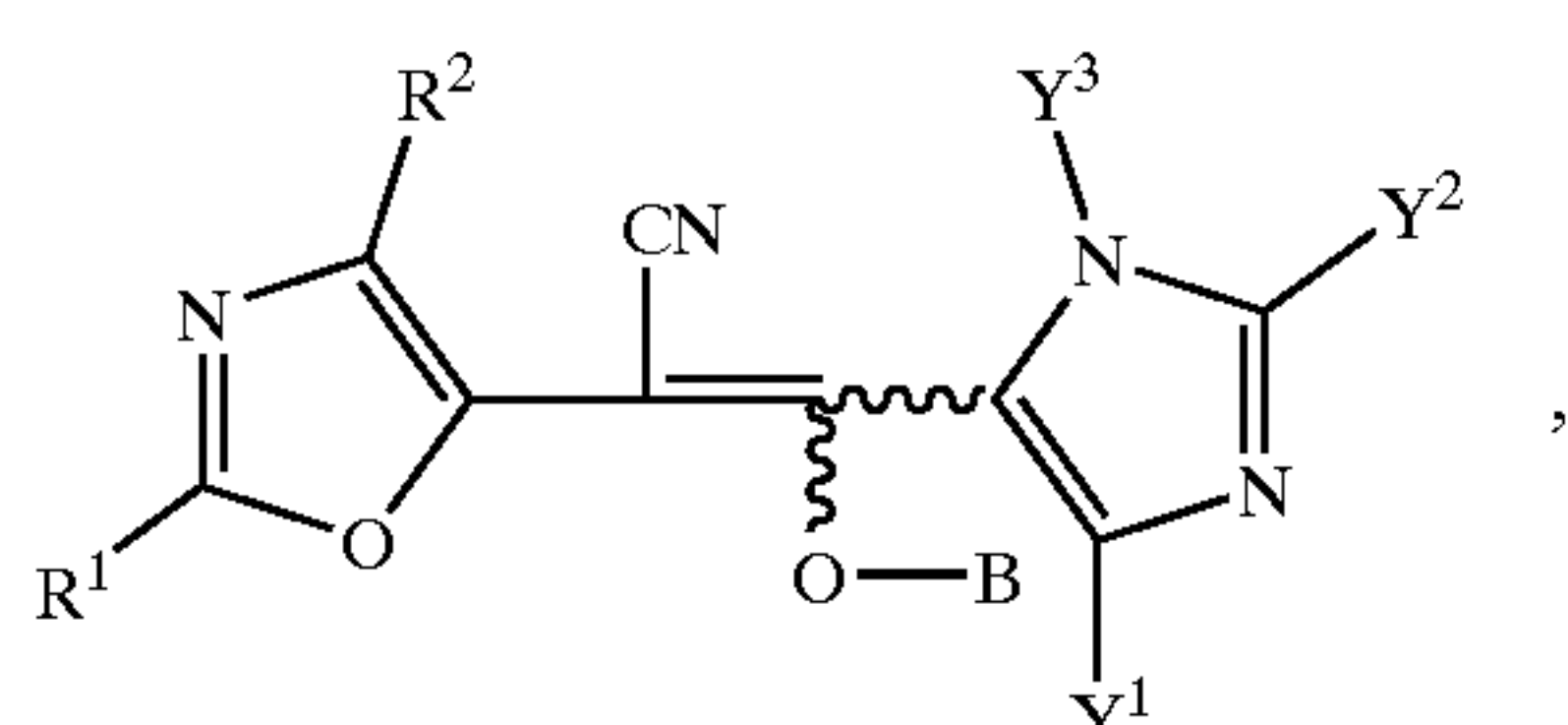
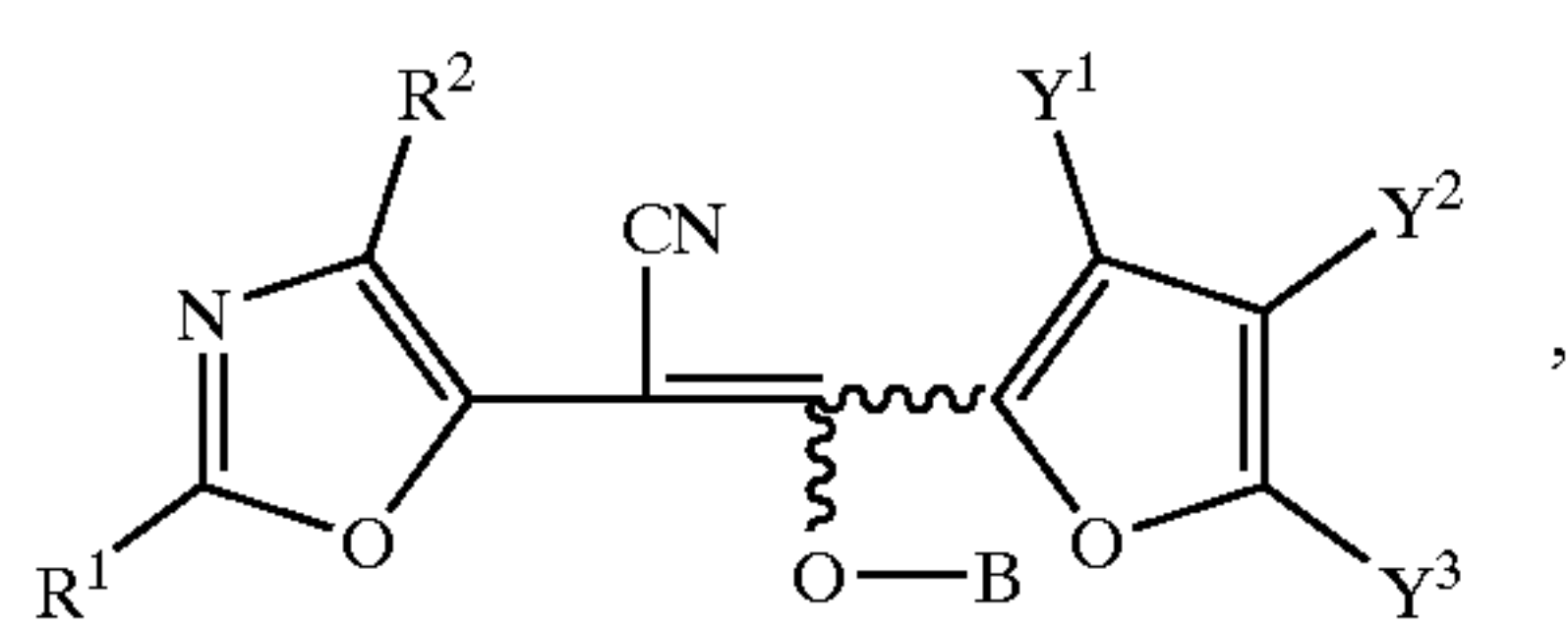
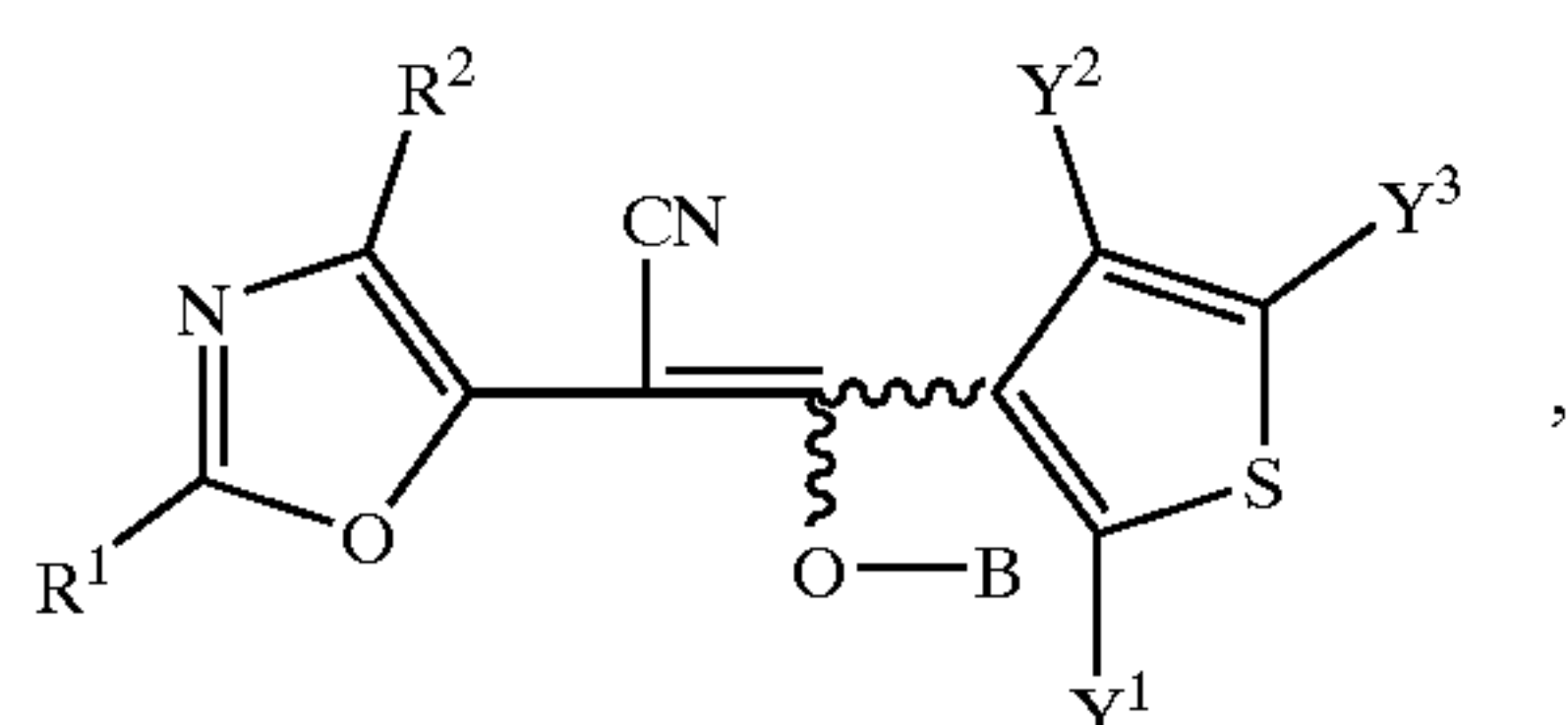
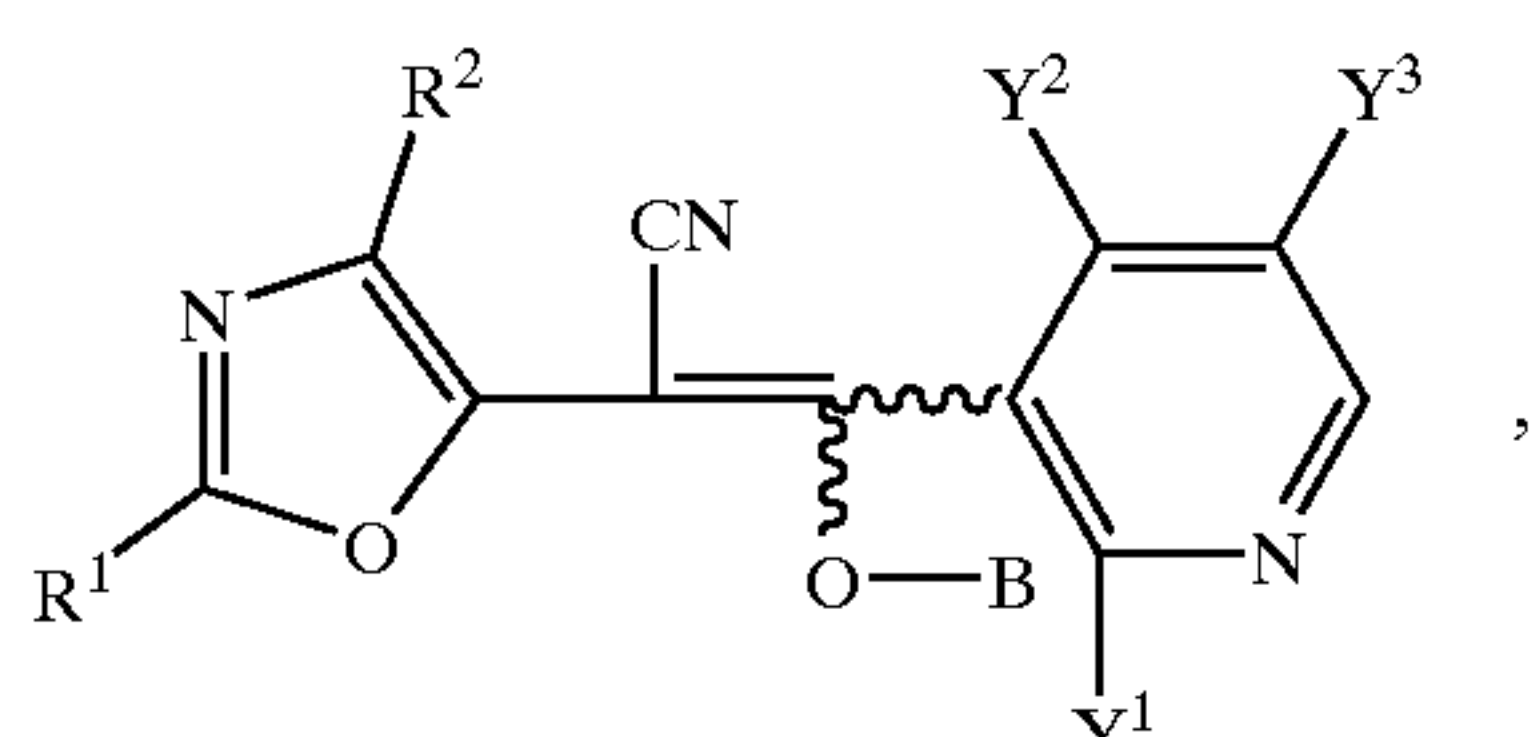
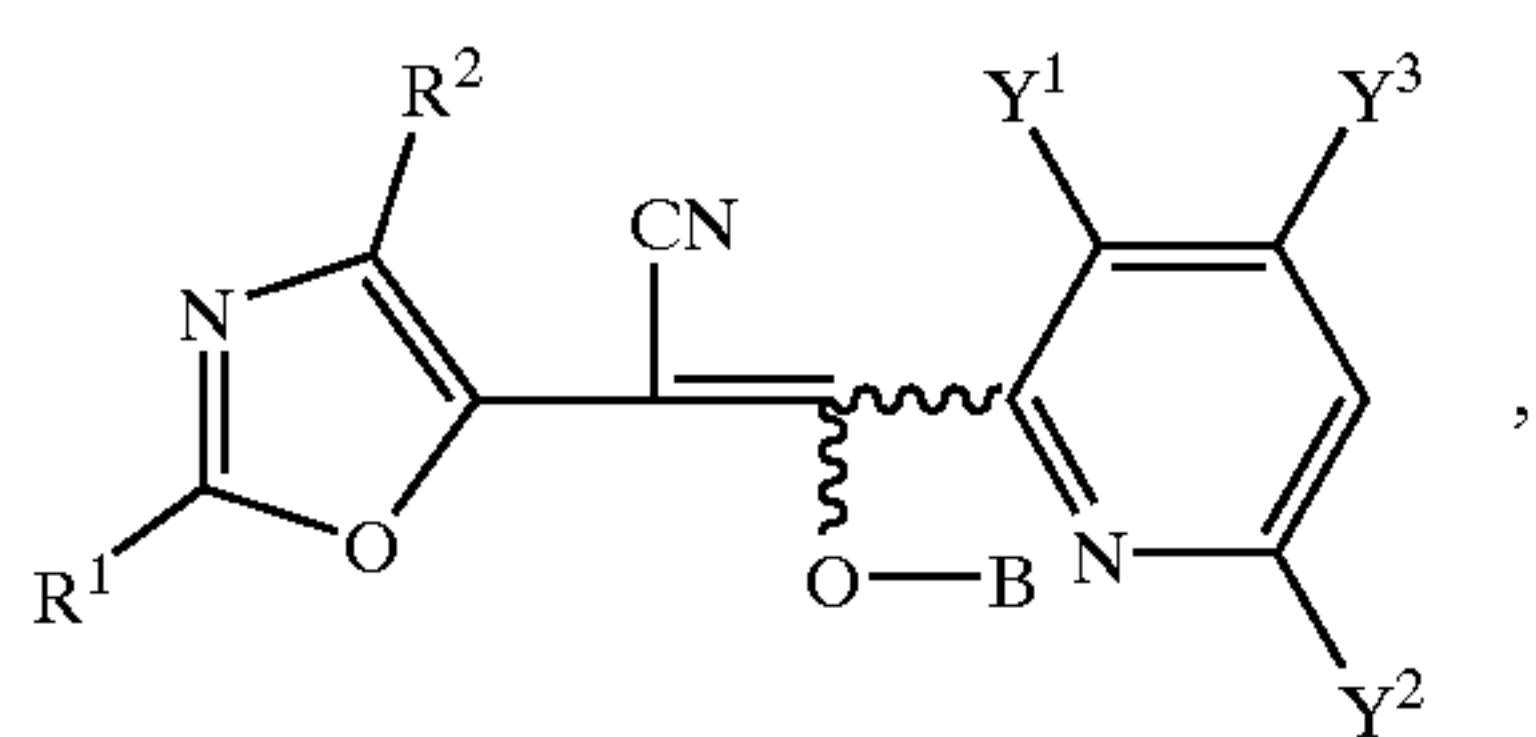
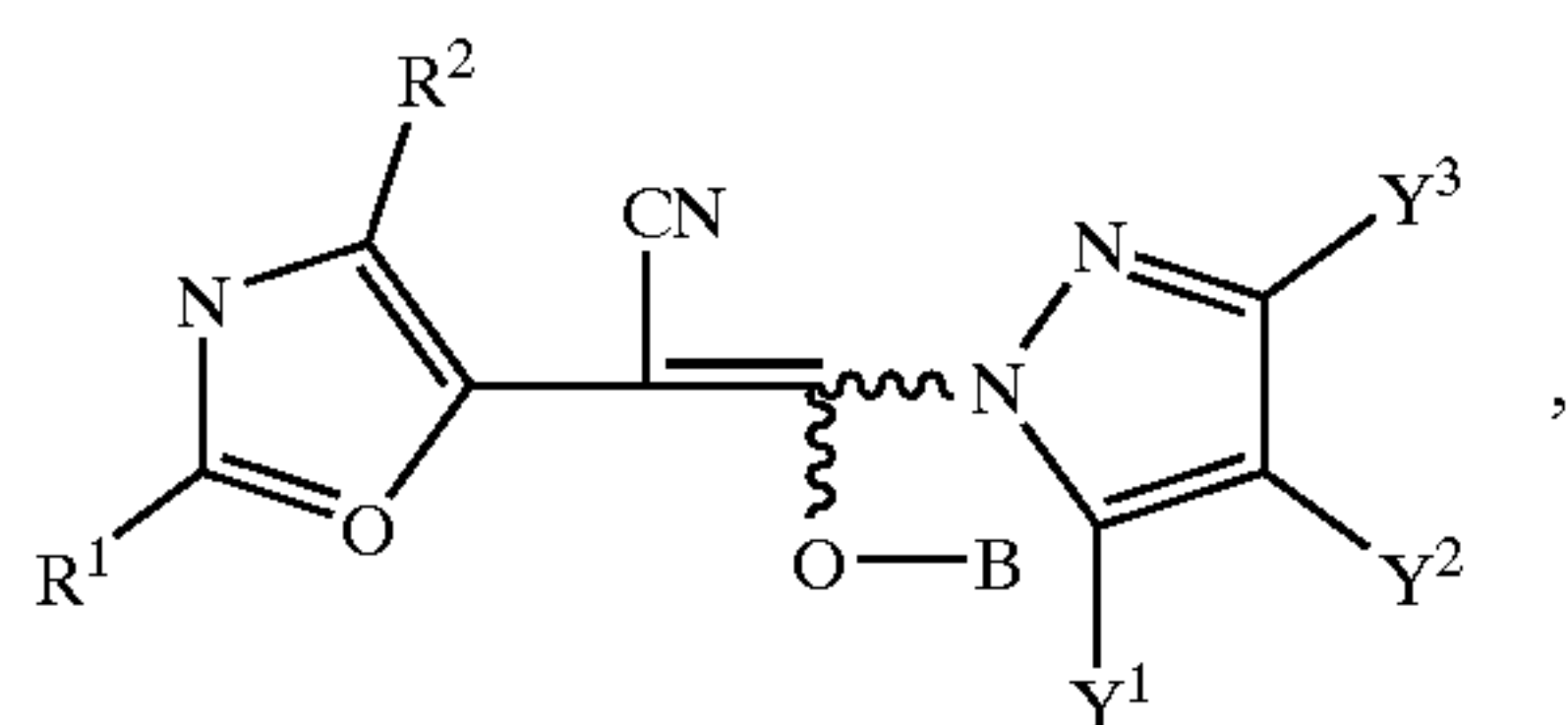
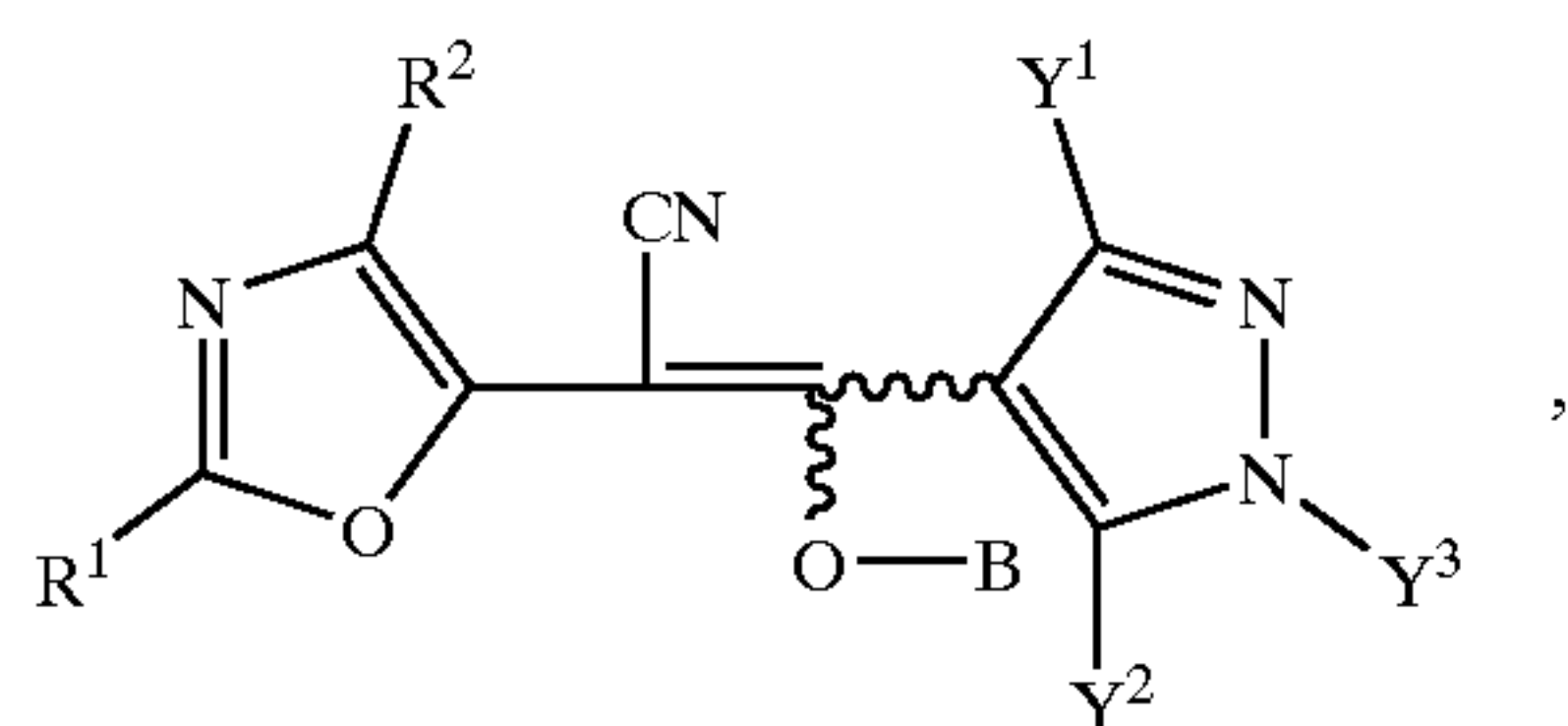
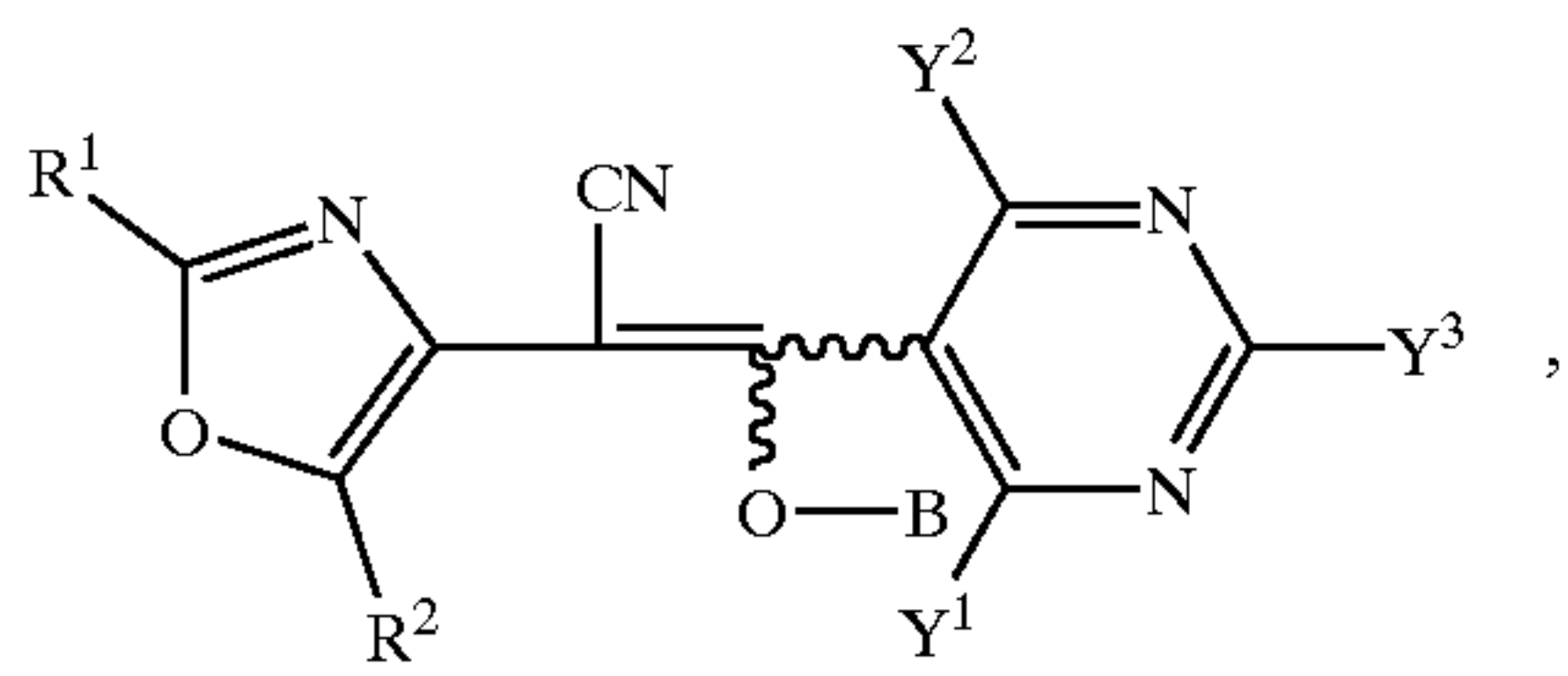

TABLE 4-continued

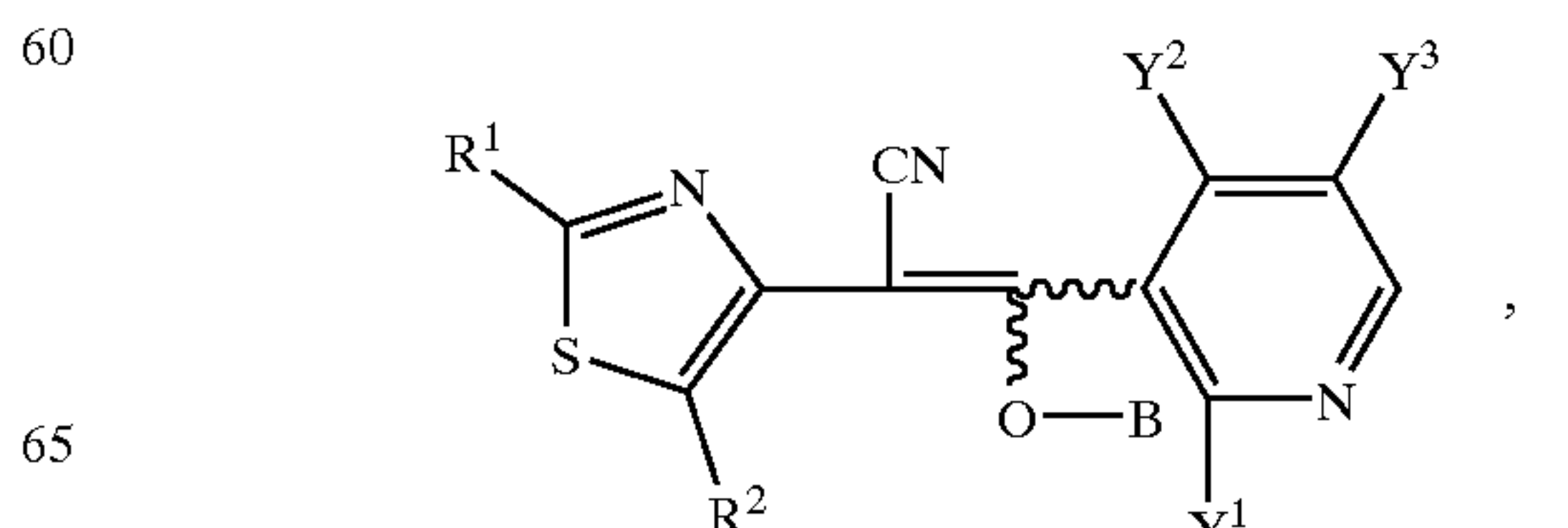
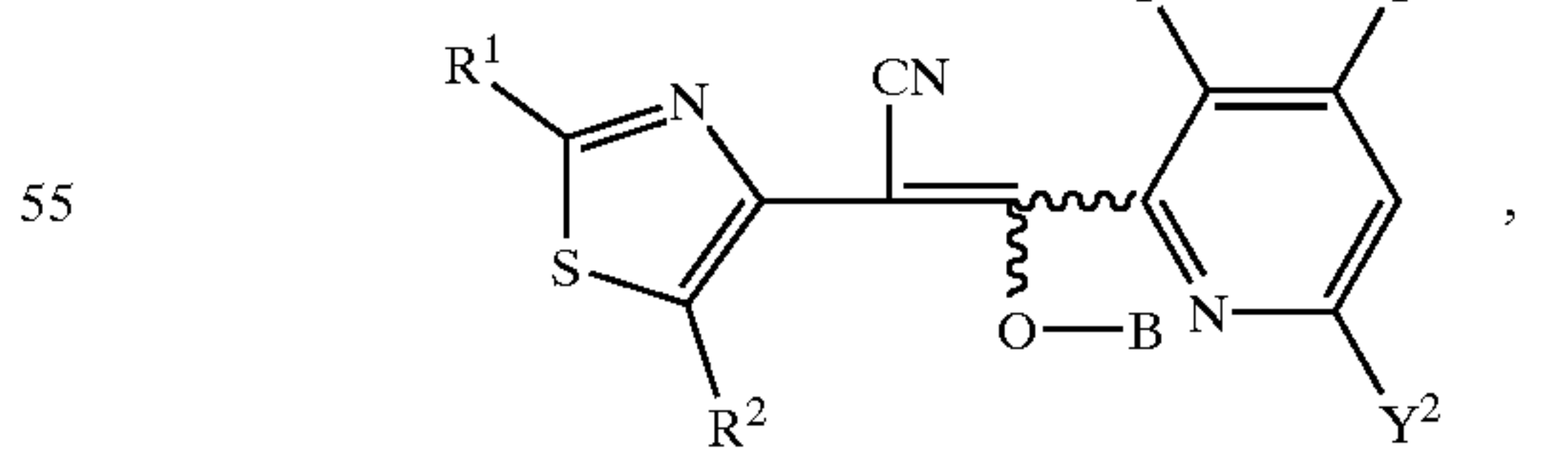
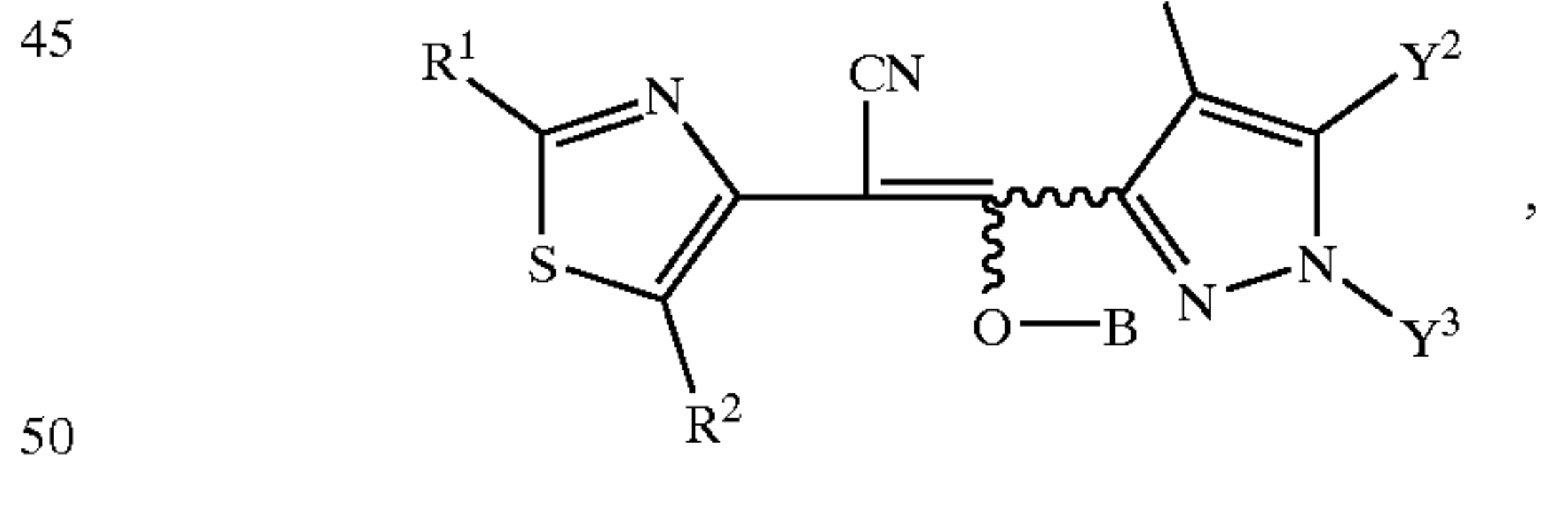
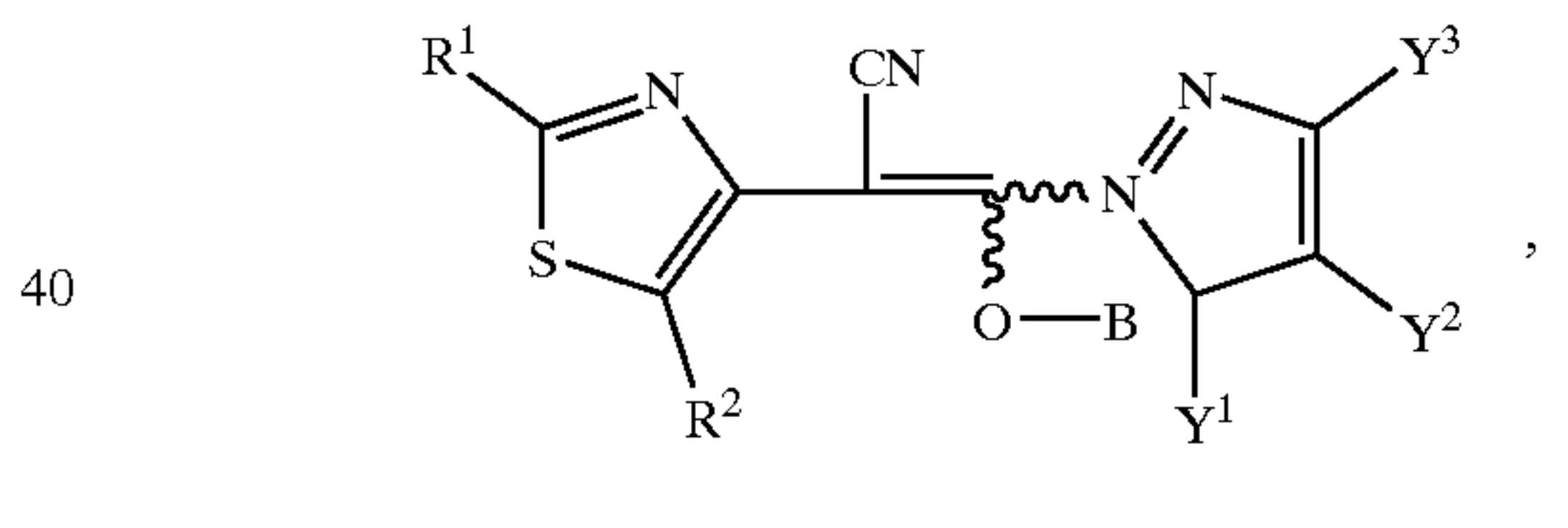
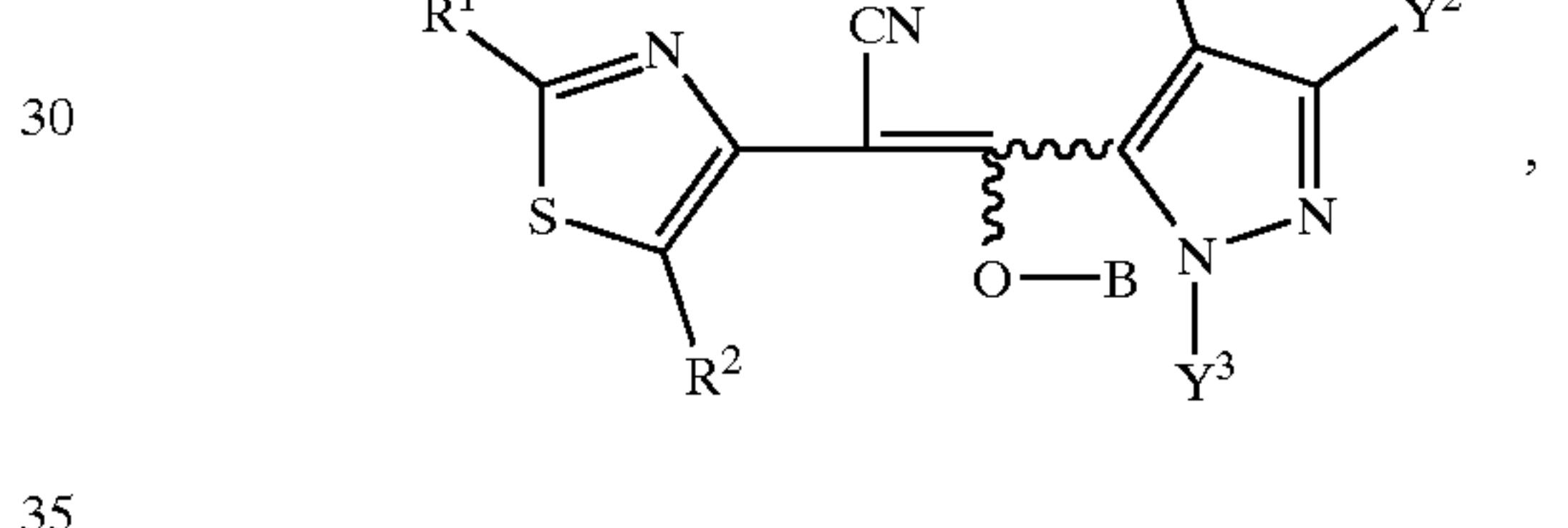
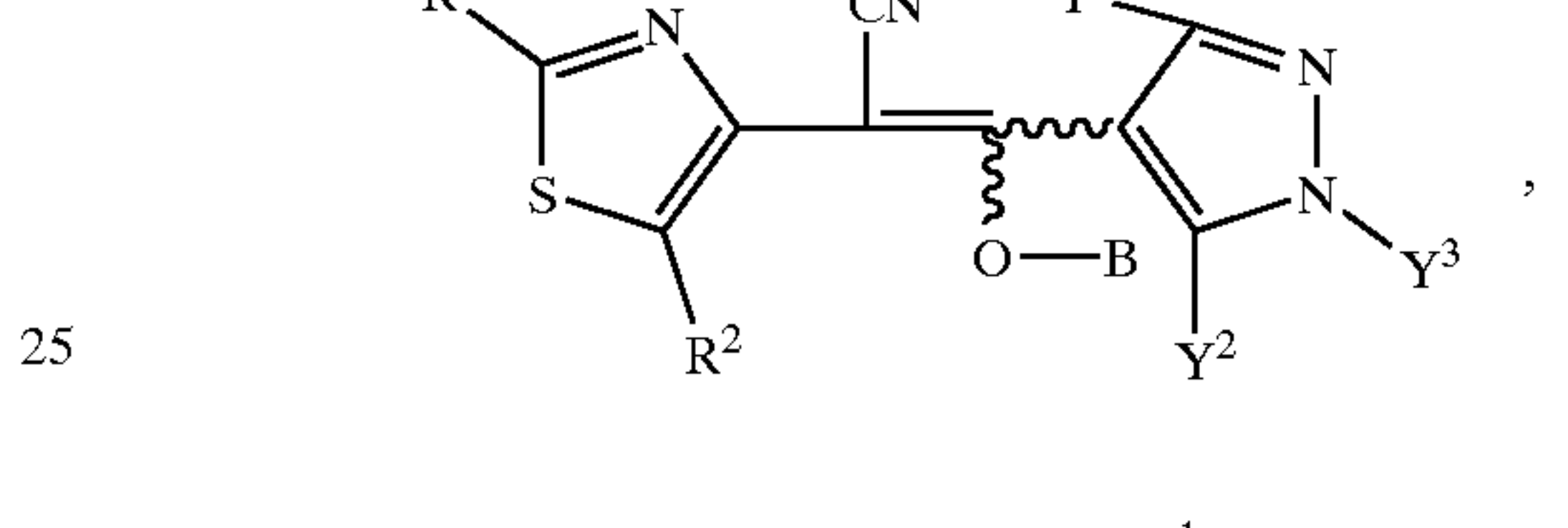
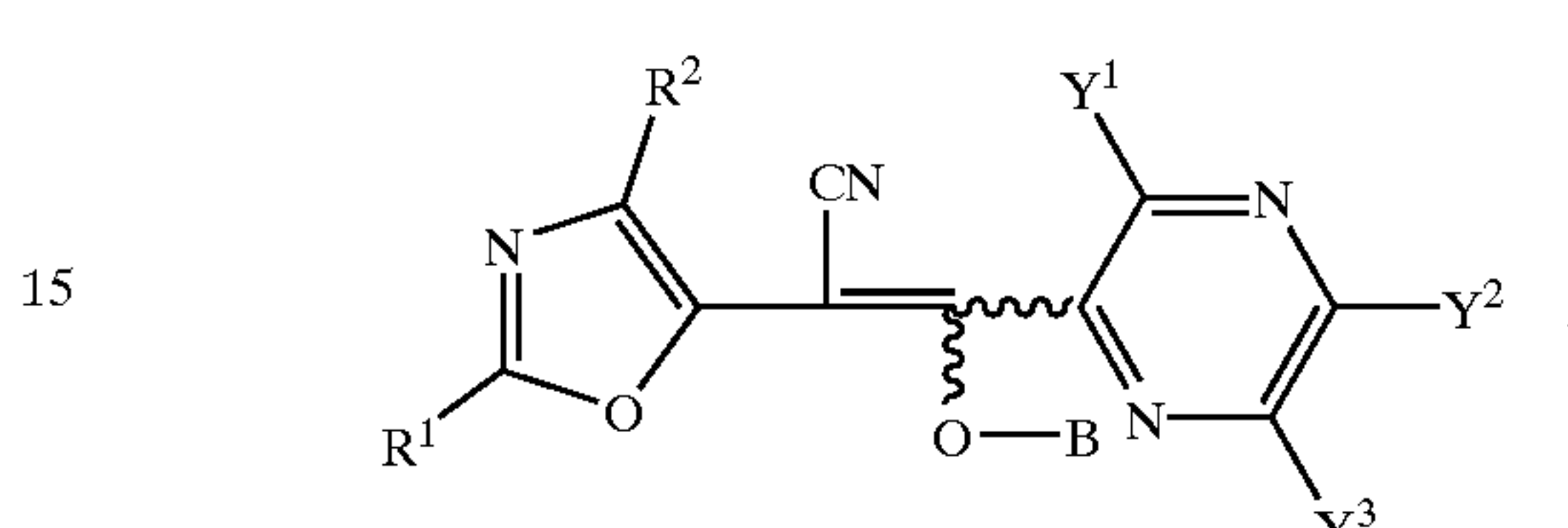
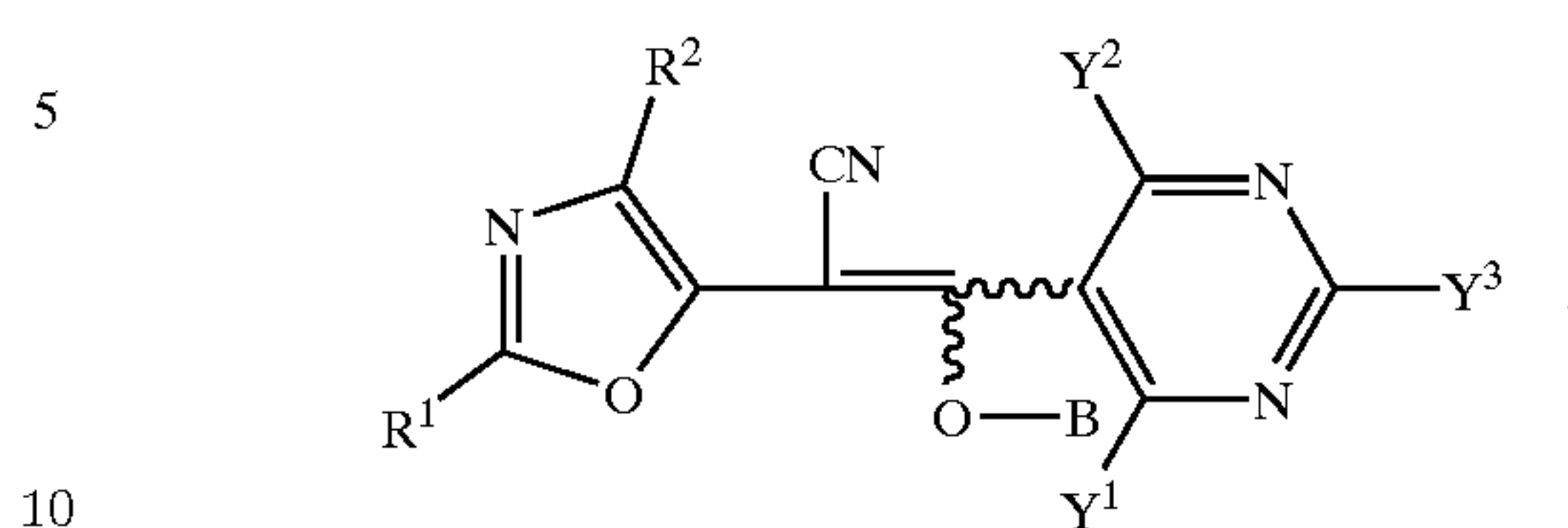

TABLE 4-continued

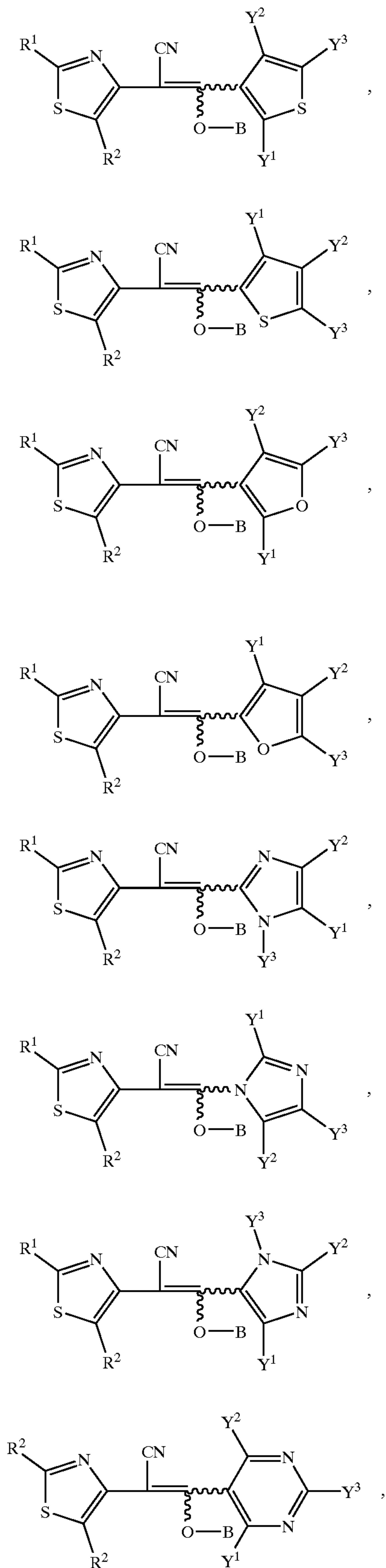

TABLE 4-continued

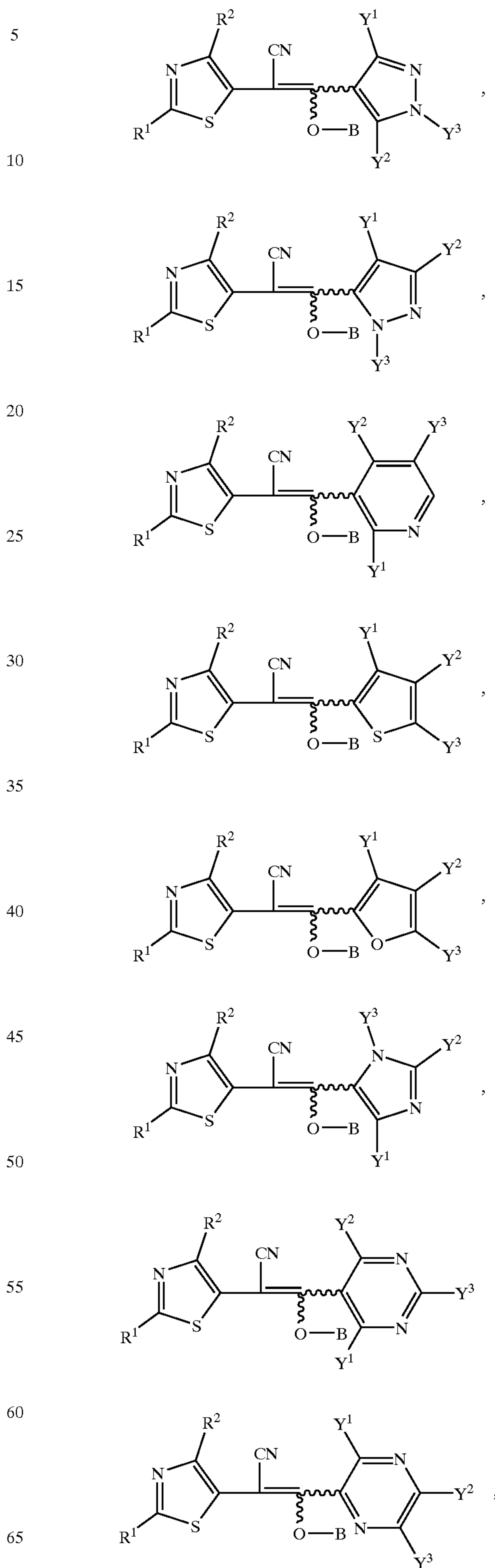

TABLE 4-continued

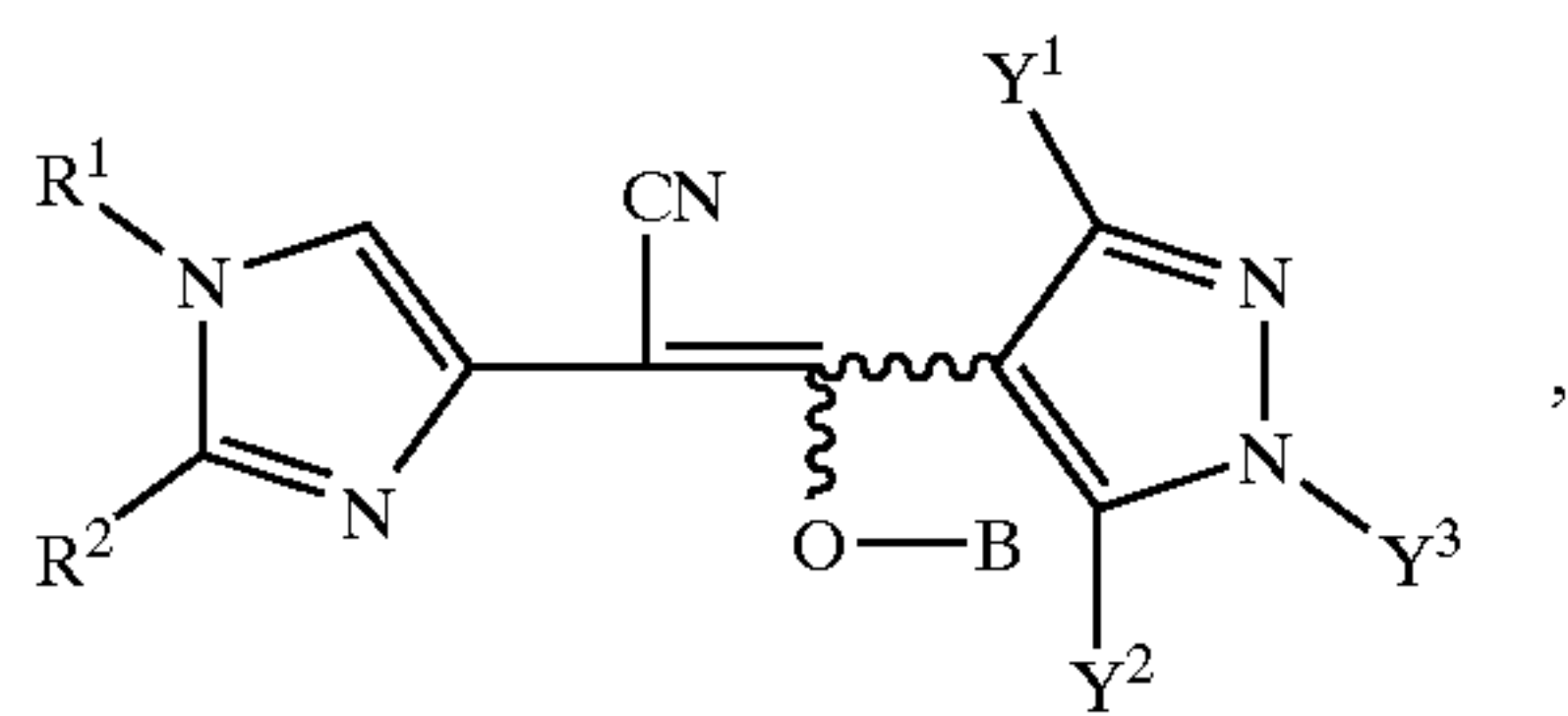
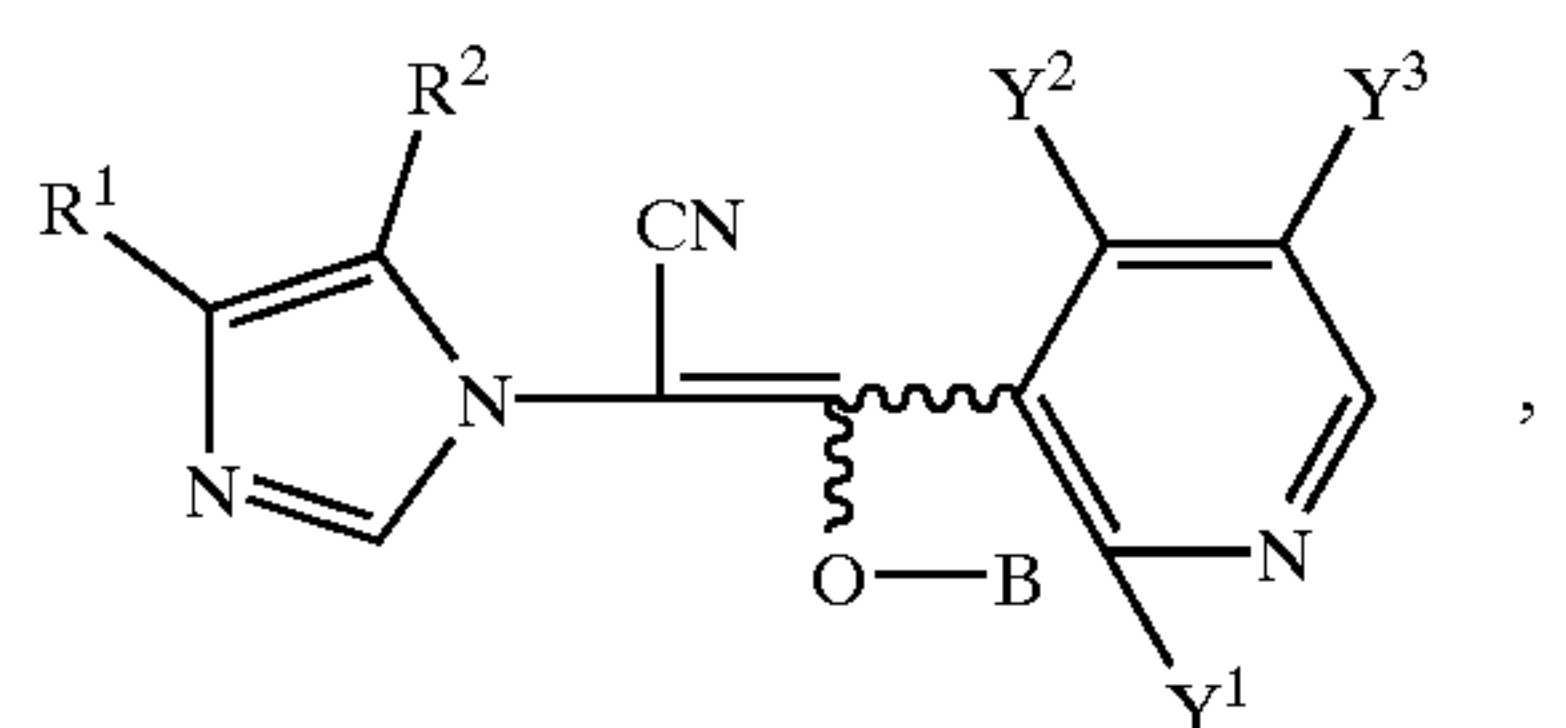
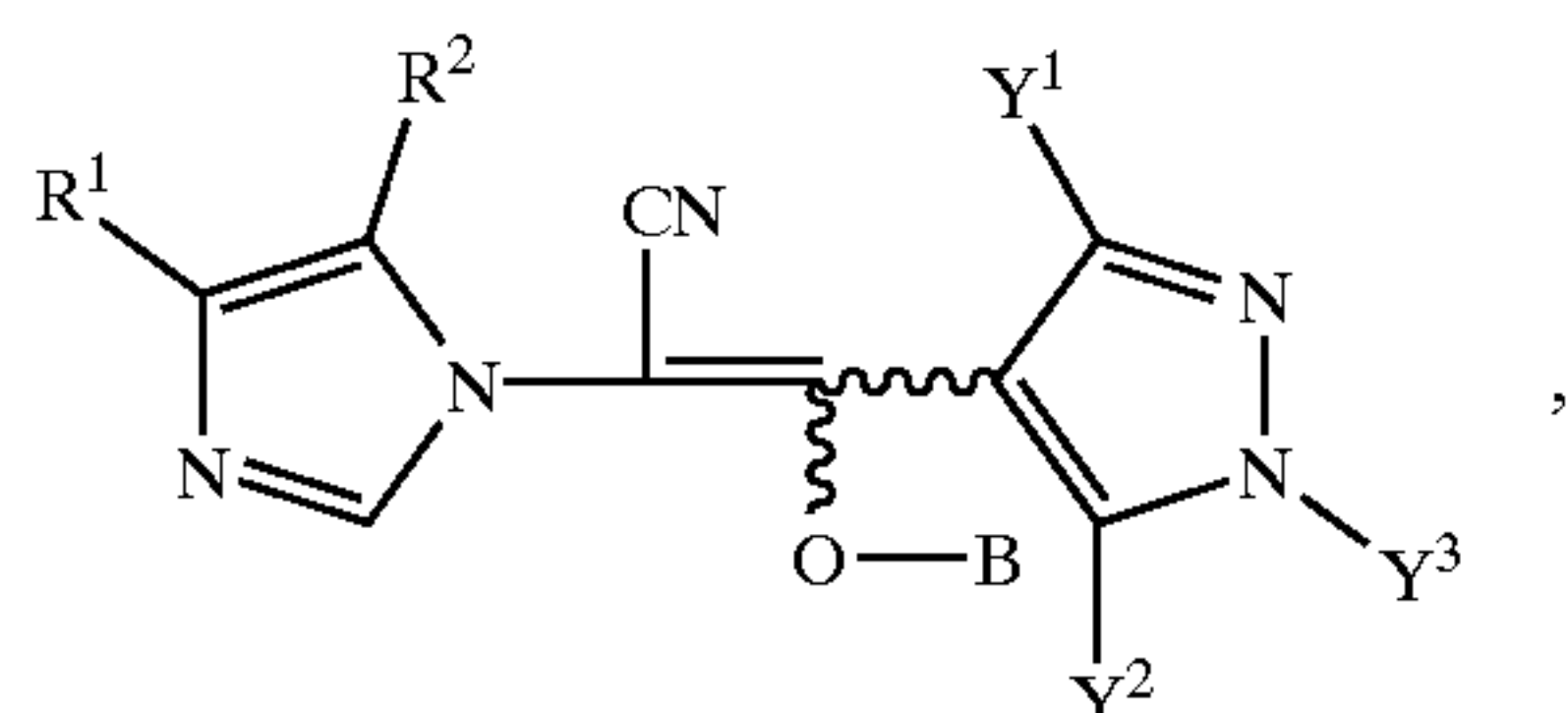
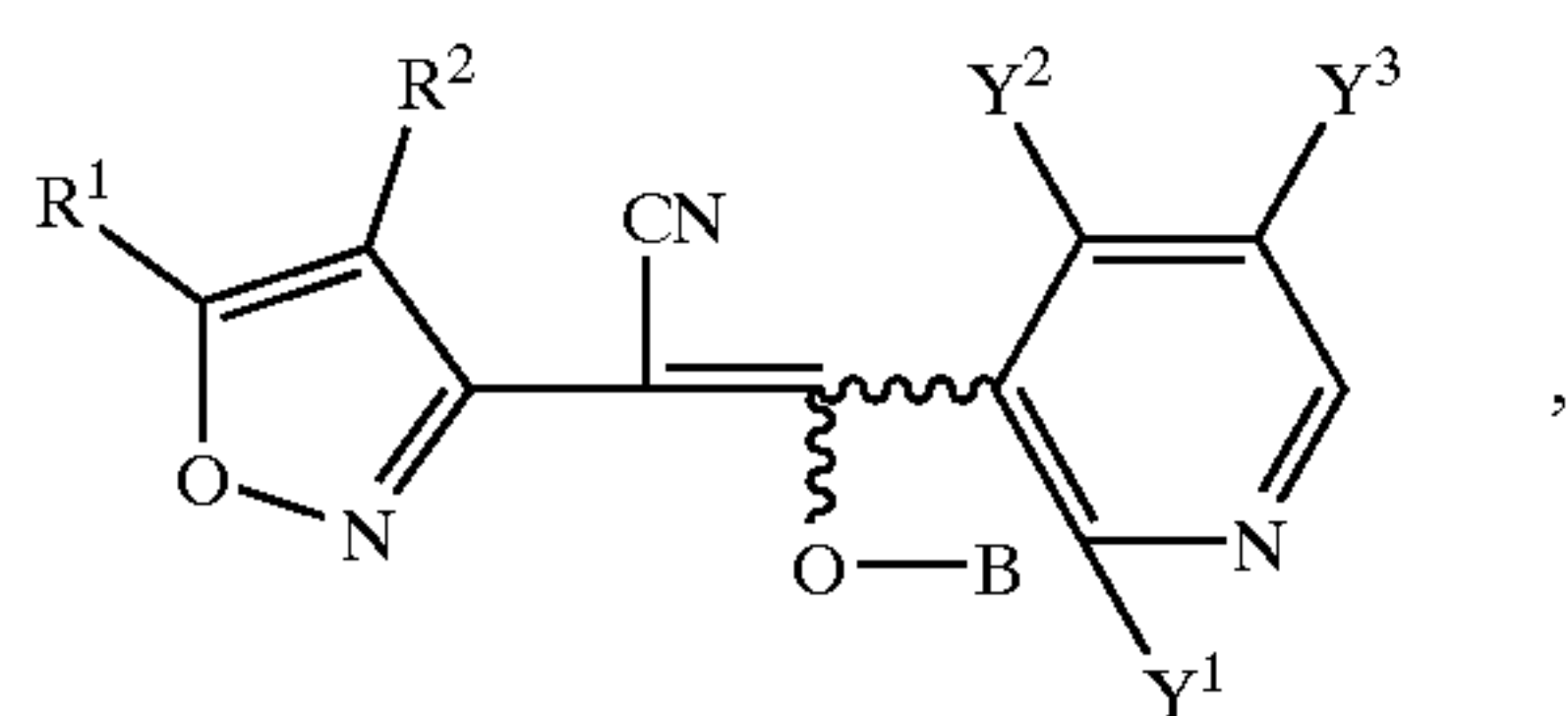
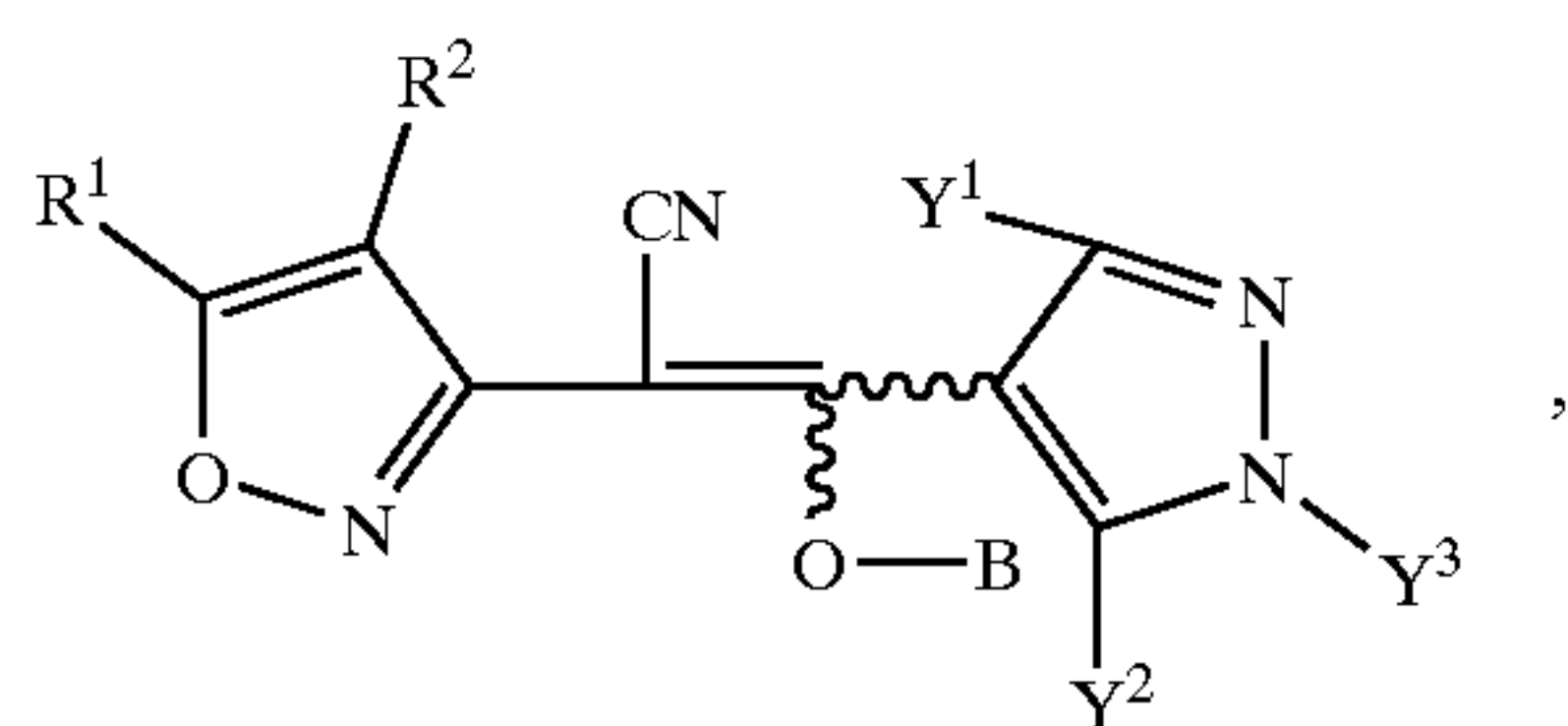
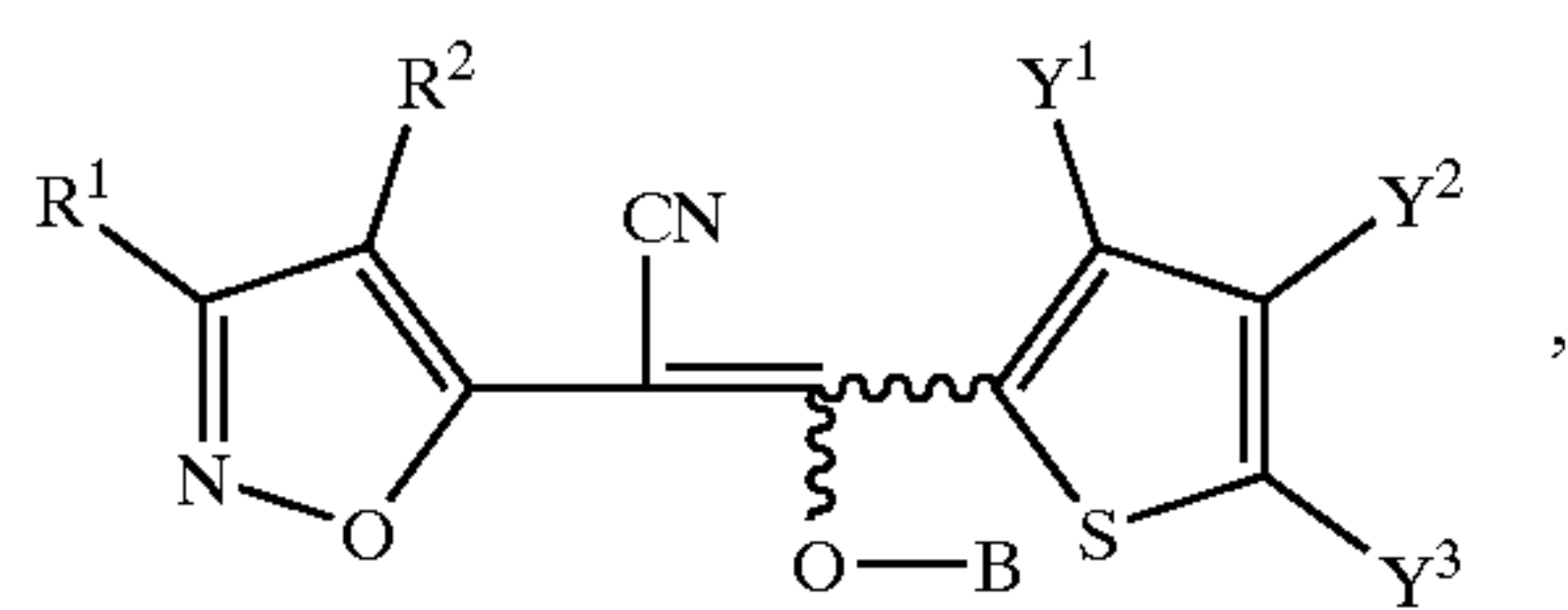
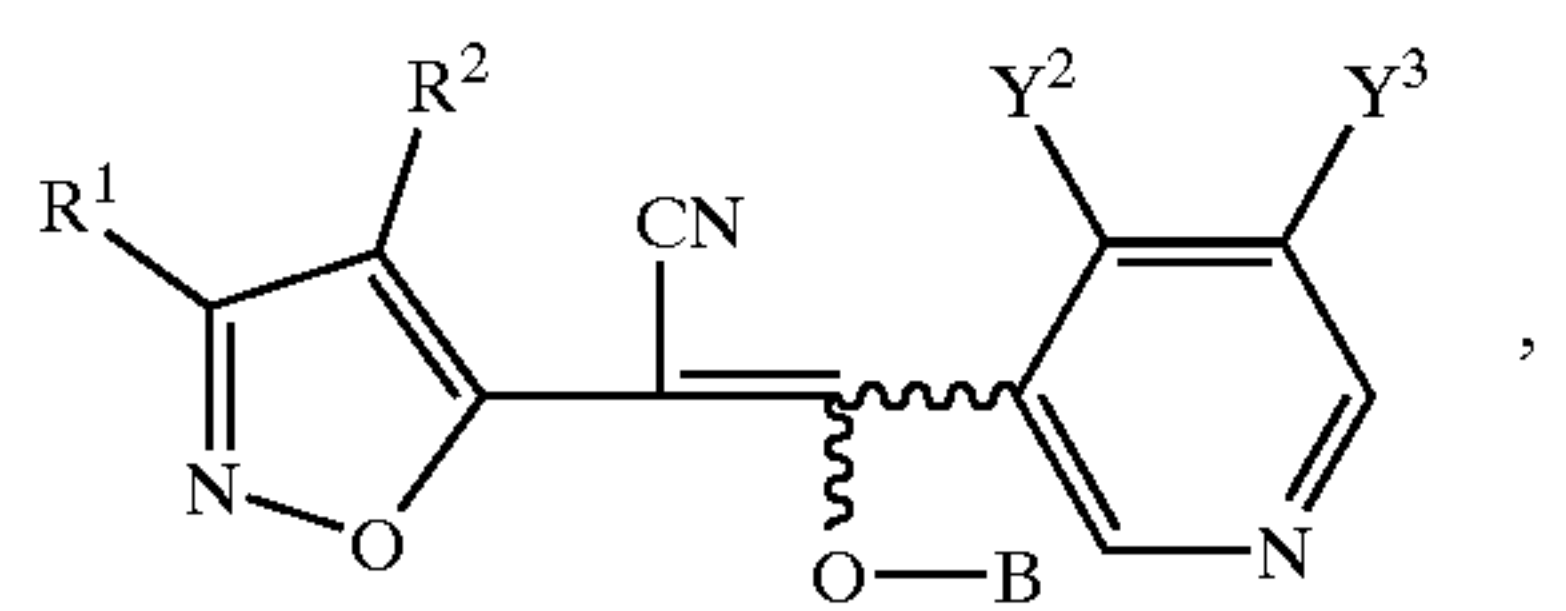
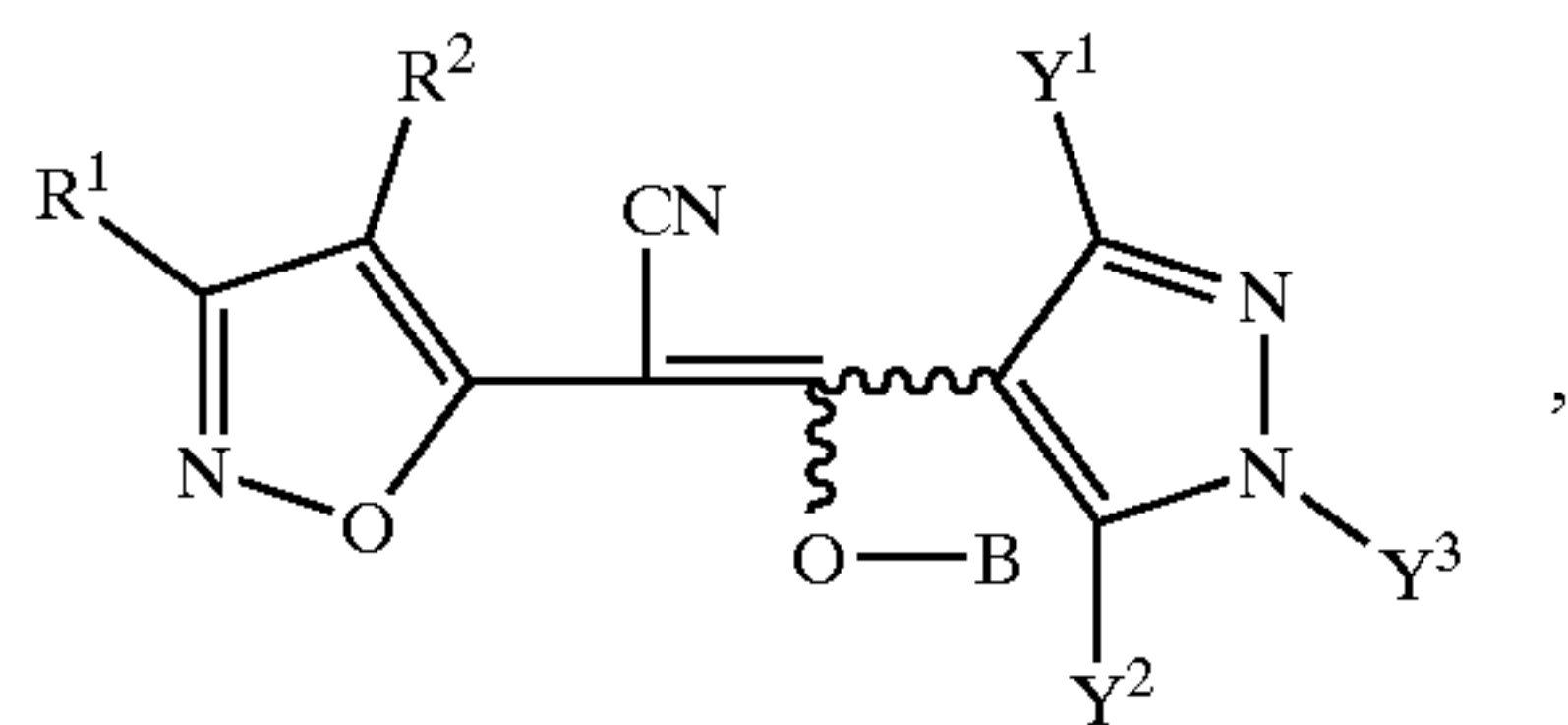
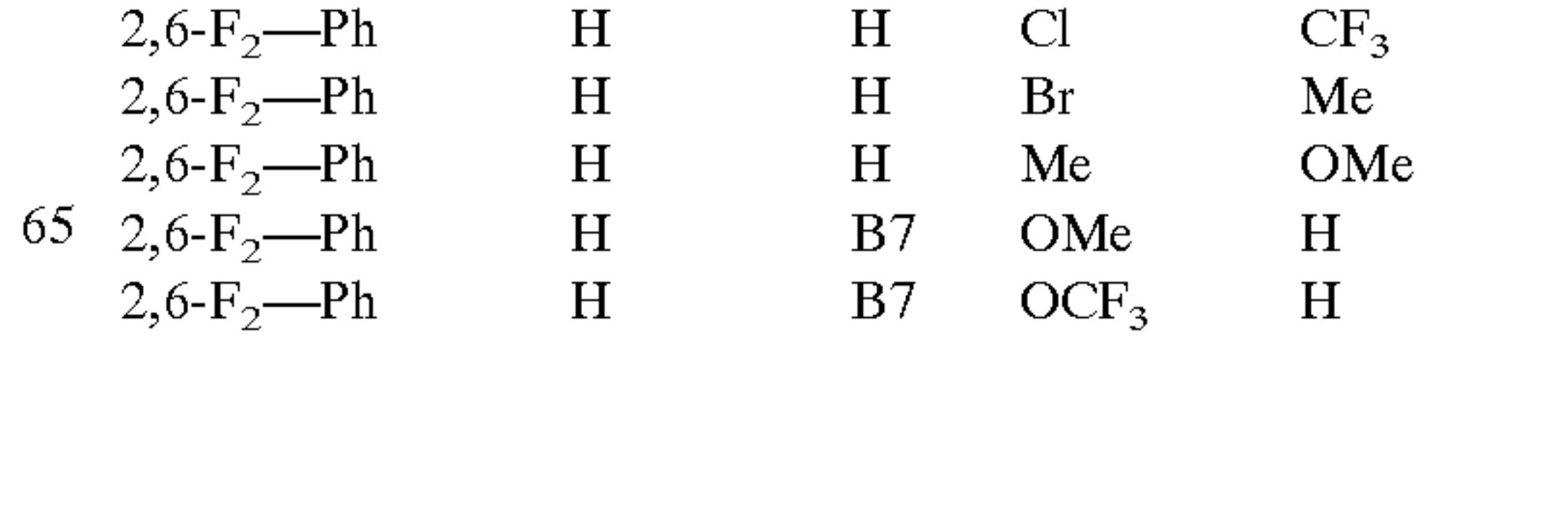
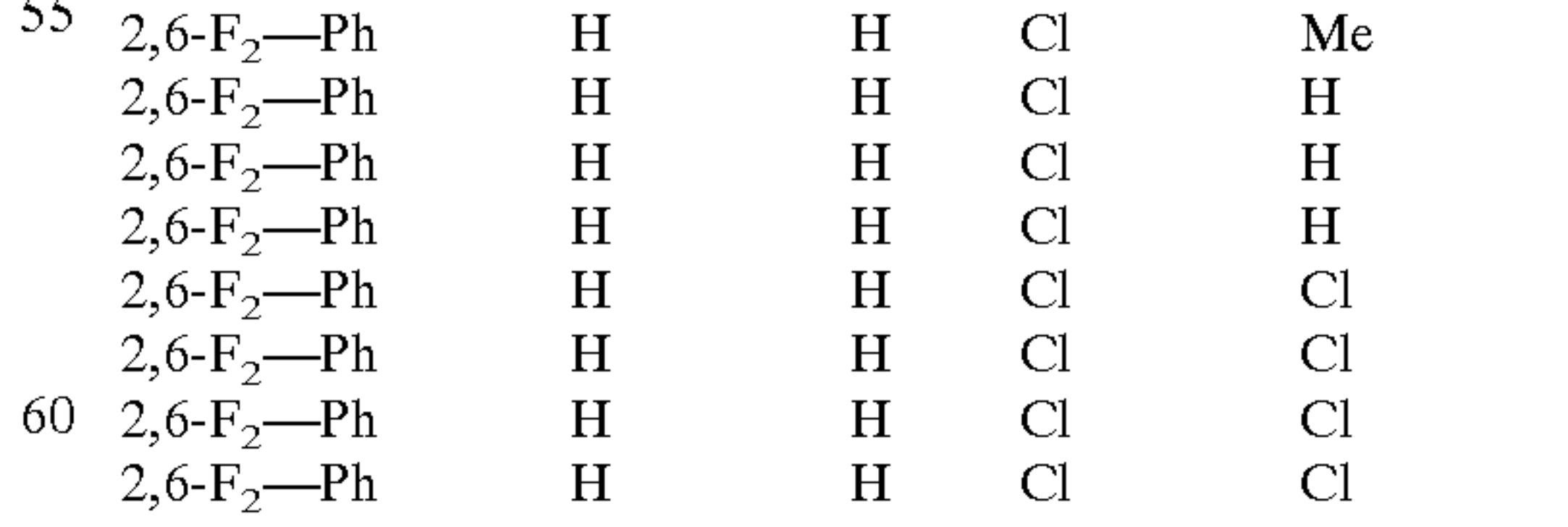
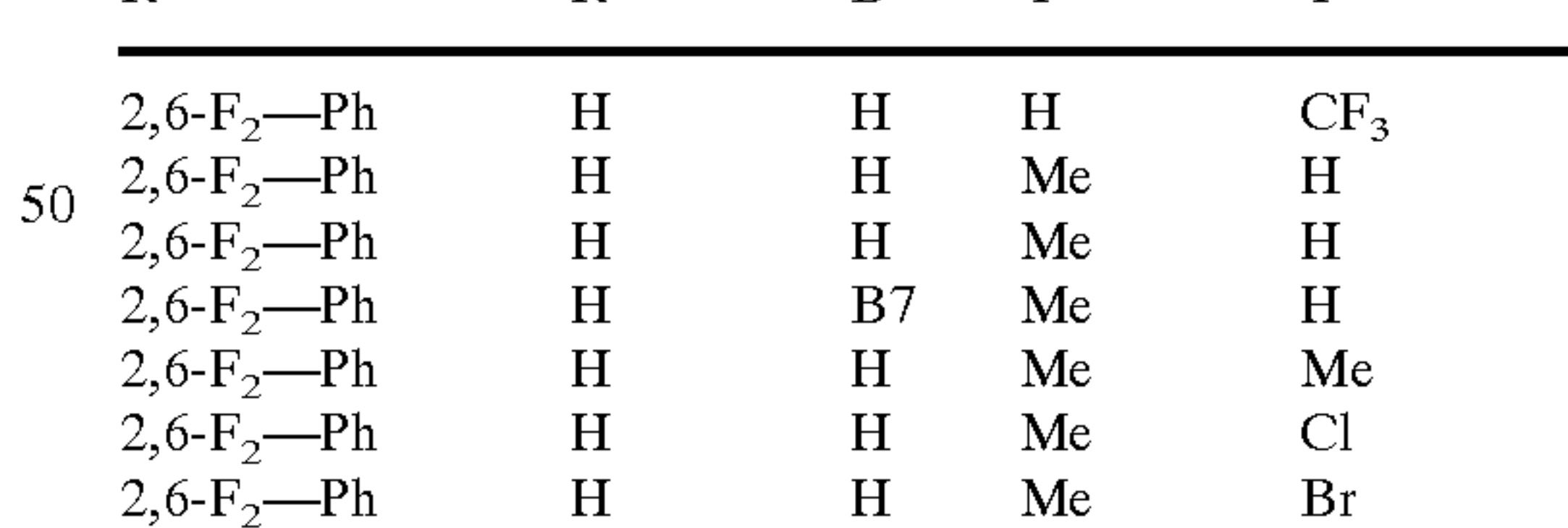
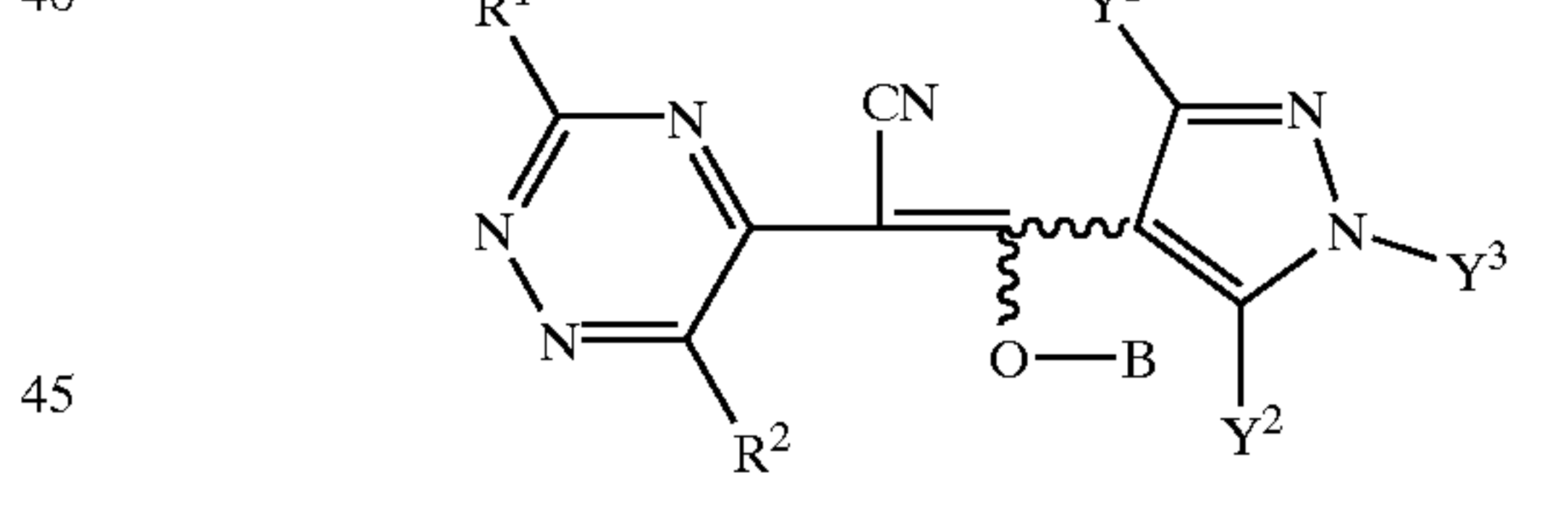
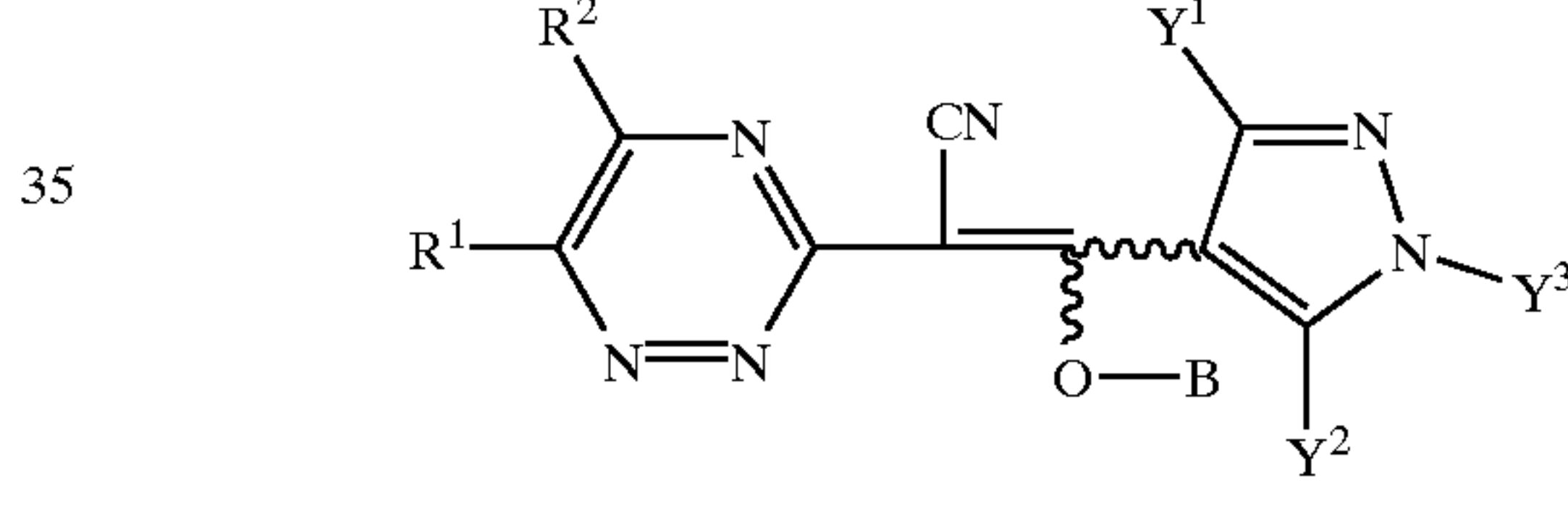
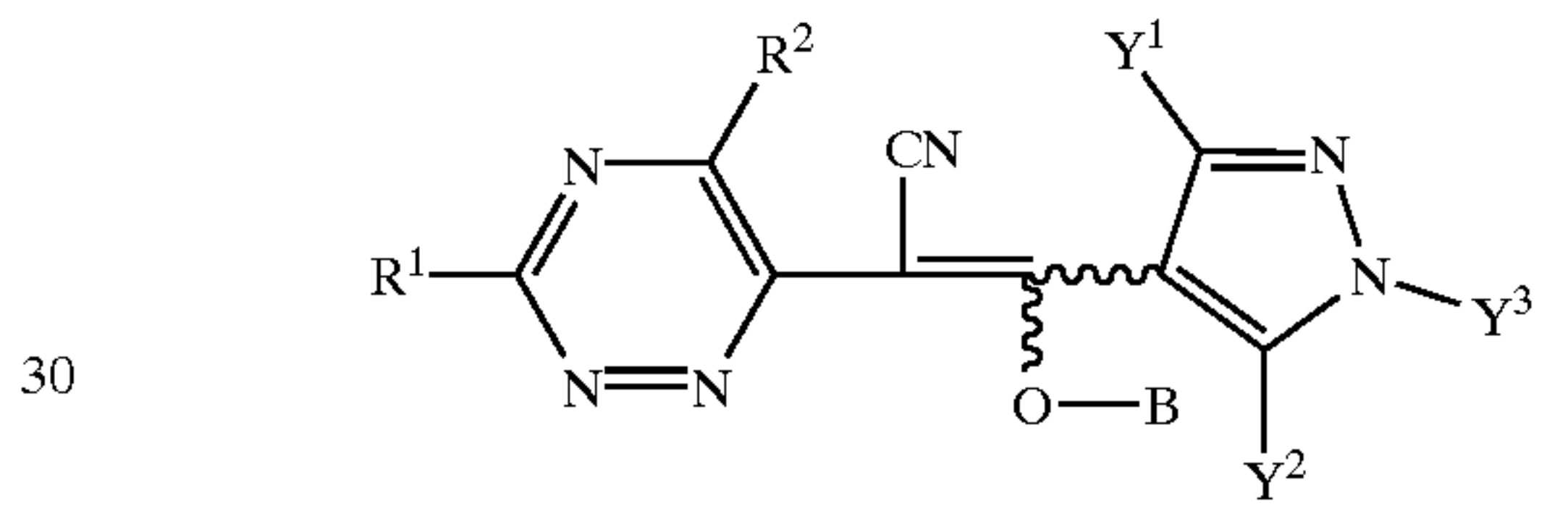
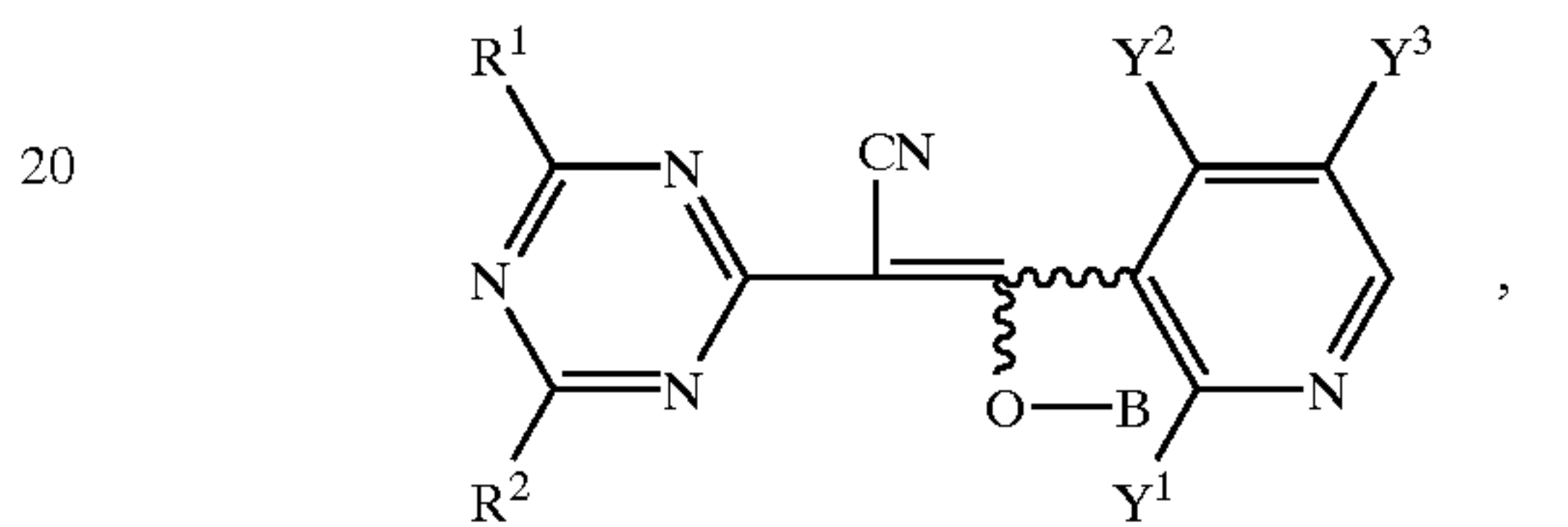
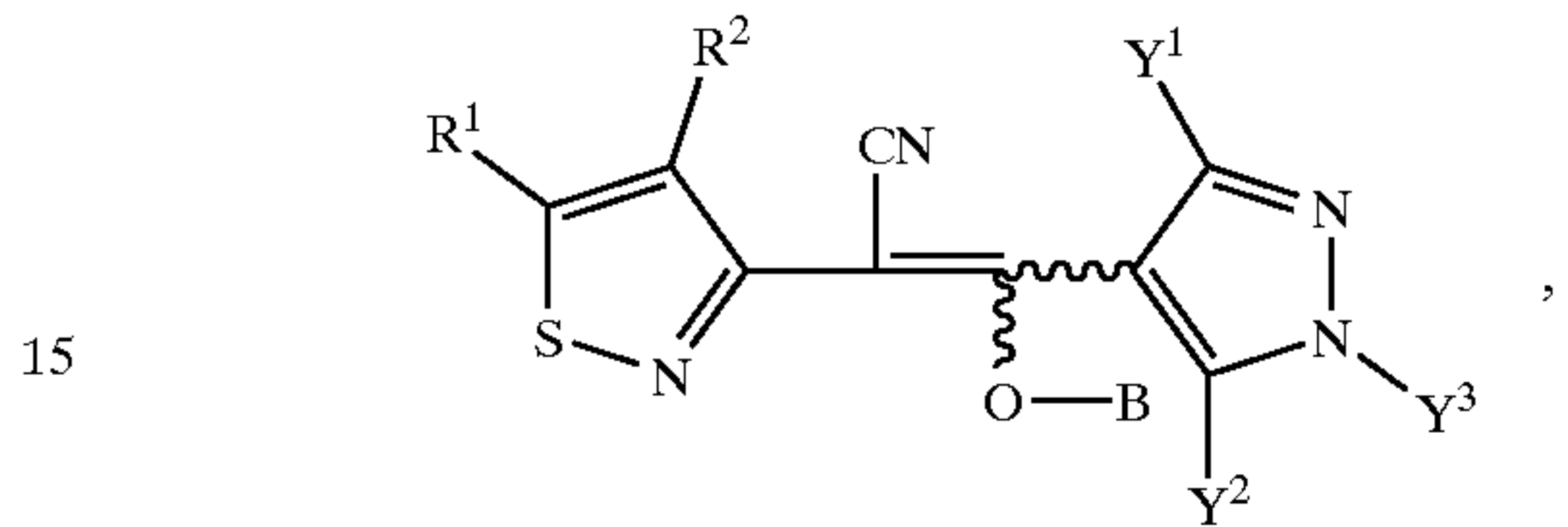
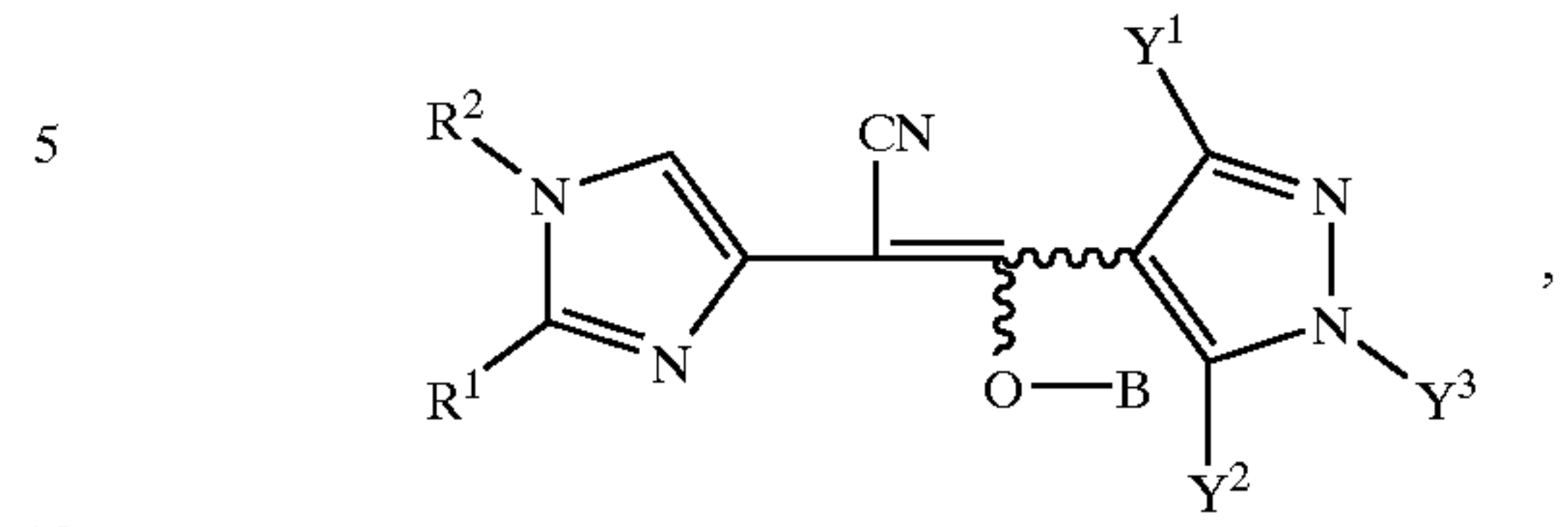

TABLE 4-continued



	R ¹	R ²	B	Y ¹	Y ²	Y ³
50	2,6-F ₂ -Ph	H	H	H	CF ₃	Me
	2,6-F ₂ -Ph	H	H	Me	H	Me
	2,6-F ₂ -Ph	H	H	Me	H	CF ₃
	2,6-F ₂ -Ph	H	B7	Me	H	H
	2,6-F ₂ -Ph	H	H	Me	Me	Me
	2,6-F ₂ -Ph	H	H	Me	Cl	Me
	2,6-F ₂ -Ph	H	H	Me	Br	Me
	2,6-F ₂ -Ph	H	H	Et	Me	Me
	2,6-F ₂ -Ph	H	H	Cl	Me	Me
	2,6-F ₂ -Ph	H	H	Cl	H	Me
55	2,6-F ₂ -Ph	H	H	Cl	H	CF ₃
	2,6-F ₂ -Ph	H	H	Cl	H	H
	2,6-F ₂ -Ph	H	H	Cl	Cl	Me
	2,6-F ₂ -Ph	H	H	Cl	Cl	CF ₃
	2,6-F ₂ -Ph	H	H	Cl	Cl	Me
	2,6-F ₂ -Ph	H	H	Cl	Cl	CF ₃
	2,6-F ₂ -Ph	H	H	Cl	Cl	CF ₂ OMe
	2,6-F ₂ -Ph	H	H	Cl	Cl	COMe
	2,6-F ₂ -Ph	H	H	Cl	Cl	Me
	2,6-F ₂ -Ph	H	H	Cl	CF ₃	Me
60	2,6-F ₂ -Ph	H	H	Br	Me	Me
	2,6-F ₂ -Ph	H	H	Me	OMe	H
	2,6-F ₂ -Ph	H	B7	OMe	H	H
	2,6-F ₂ -Ph	H	B7	OCF ₃	H	H

TABLE 4-continued

2,6-F ₂ -Ph	H	B7	SMe	H	Me		tBu	H	H	Cl	Cl	COMe
2,6-F ₂ -Ph	H	H	CF ₃	Me	Me		tBu	H	H	Cl	CF ₃	Me
2,6-F ₂ -Ph	H	H	CF ₃	Cl	CF ₃	5	tBu	H	H	Br	Me	Me
2,6-F ₂ -Ph	H	H	CF ₃	Cl	CF ₂ H		tBu	H	H	Me	OMe	Me
2,6-F ₂ -Ph	H	H	CF ₃	Cl	CH ₂ OMe		tBu	H	B7	OMe	H	H
2,6-F ₂ -Ph	H	H	CF ₃	Cl	Me		tBu	H	B7	OC ₃	H	H
2,6-F ₂ -Ph	H	H	CF ₃	H	Me		tBu	H	B7	SMe	H	H
2,6-F ₂ -Ph	H	H	CF ₃	Br	Me		tBu	H	H	CF ₃	Me	Me
2,6-F ₂ -Ph	H	H	CF ₃	NO ₂	Me	10	tBu	H	H	CF ₃	Cl	Me
2,6-F ₂ -Ph	H	H	CF ₃	CN	Me		tBu	H	H	CF ₃	Cl	Me
2,6-F ₂ -Ph	H	H	CF ₃	NHMe	Me		tBu	H	H	CF ₃	Cl	Me
2,6-F ₂ -Ph	H	H	CF ₃	NMe	Me		tBu	Br	H	CF ₃	Cl	Me
2,6-F ₂ -Ph	H	H	CF ₃	CO ₂ Me	Me		tBu	CF ₃	H	CF ₃	Cl	Me
2,6-F ₂ -Ph	H	H	CF ₃	OMe	CF ₂ H		tBu	NO ₂	H	CF ₃	Cl	Me
2,6-F ₂ -Ph	H	H	CF ₃	OCF ₂ H	Me	15	tBu	CN	H	CF ₃	Cl	Me
2,6-F ₂ -Ph	H	H	Cl	NO ₂	Me		tBu	CO ₂ Me	H	CF ₃	Cl	CF ₃
2,6-F ₂ -Ph	H	H	Cl	CN	Me		tBu	CO ₂ Et	H	CF ₃	Cl	CF ₂ H
2,6-F ₂ -Ph	H	H	CO ₂ Me	Me	Me		tBu	H	H	CF ₃	Cl	CH ₂ OMe
2,6-F ₂ -Ph	H	B1	Cl	Cl	Me		tBu	H	H	CF ₃	H	Me
2,6-F ₂ -Ph	H	B3	Cl	Cl	Me		tBu	H	H	CF ₃	Br	Me
2,6-F ₂ -Ph	H	B6	Cl	Cl	Me		tBu	H	H	CF ₃	NO ₂	Me
2,6-F ₂ -Ph	H	B7	Cl	Cl	Me	20	tBu	H	H	CF ₃	CN	Me
2,6-F ₂ -Ph	H	B2	CF ₃	Cl	Me		tBu	H	H	CF ₃	NHMe	Me
2,6-F ₂ -Ph	H	B3	CF ₃	Cl	Me		tBu	H	H	CF ₃	NMe ₂	Me
2,6-F ₂ -Ph	H	B4	CF ₃	Cl	Me		tBu	H	H	CF ₃	CO ₂ Me	Me
2,6-F ₂ -Ph	H	B5	CF ₃	Cl	Me		tBu	H	H	CF ₃	OMe	Me
2,6-F ₂ -Ph	H	B6	CF ₃	Cl	Me		tBu	H	H	CF ₃	OCF ₂ H	CF ₂ H
2,6-F ₂ -Ph	H	B7	CF ₃	Cl	Me	25	tBu	H	H	Cl	NO ₂	Me
2,6-F ₂ -Ph	H	B8	CF ₃	Cl	Me		tBu	H	H	Cl	CN	Me
2,6-F ₂ -Ph	H	B9	CF ₃	Cl	Me		tBu	H	H	CO ₂ Me	Me	Me
2,6-F ₂ -Ph	H	B10	CF ₃	Cl	Me		tBu	H	B1	Cl	Cl	Me
2,6-F ₂ -Ph	H	B11	CF ₃	Cl	Me		tBu	H	B2	Cl	Cl	Me
2,6-F ₂ -Ph	H	B12	CF ₃	Cl	Me		tBu	H	B3	Cl	Cl	Me
2,6-F ₂ -Ph	H	B13	CF ₃	Cl	Me	30	tBu	H	B4	Cl	Cl	Me
2,6-F ₂ -Ph	H	B14	CF ₃	Cl	Me		tBu	H	B5	Cl	Cl	Me
2,6-F ₂ -Ph	H	B15	CF ₃	Cl	Me		tBu	H	B6	Cl	Cl	Me
2,6-F ₂ -Ph	H	B16	CF ₃	Cl	Me		tBu	H	B7	Cl	Cl	Me
2,6-F ₂ -Ph	H	B17	CF ₃	Cl	Me		tBu	H	B8	Cl	Cl	Me
2,6-F ₂ -Ph	H	B18	CF ₃	Cl	Me		tBu	H	B9	Cl	Cl	Me
2,6-F ₂ -Ph	H	B19	CF ₃	Cl	Me		tBu	H	B10	Cl	Cl	Me
2,6-F ₂ -Ph	H	B20	CF ₃	Cl	Me	35	tBu	H	B11	Cl	Cl	Me
2,6-F ₂ -Ph	H	B21	CF ₃	Cl	Me		tBu	H	B12	Cl	Cl	Me
2,6-F ₂ -Ph	H	B22	CF ₃	Cl	Me		tBu	H	B13	Cl	Cl	Me
2,6-F ₂ -Ph	H	B23	CF ₃	Cl	Me		tBu	H	B14	Cl	Cl	Me
2,6-F ₂ -Ph	H	B24	CF ₃	Cl	Me		tBu	H	B15	Cl	Cl	Me
2,6-F ₂ -Ph	H	B25	CF ₃	Cl	Me		tBu	H	B16	Cl	Cl	Me
2,6-F ₂ -Ph	H	B26	CF ₃	Cl	Me	40	tBu	H	B17	Cl	Cl	Me
2,6-F ₂ -Ph	H	B27	CF ₃	Cl	Me		tBu	H	B18	Cl	Cl	Me
2,6-F ₂ -Ph	H	B28	CF ₃	Cl	Me		tBu	H	B19	Cl	Cl	Me
2,6-F ₂ -Ph	H	B29	CF ₃	Cl	Me		tBu	H	B20	Cl	Cl	Me
2,6-F ₂ -Ph	H	B30	CF ₃	Cl	Me		tBu	H	B21	Cl	Cl	Me
2,6-F ₂ -Ph	H	B31	CF ₃	Cl	Me		tBu	H	B22	Cl	Cl	Me
2,6-F ₂ -Ph	H	B32	CF ₃	Cl	Me	45	tBu	H	B23	Cl	Cl	Me
2,6-F ₂ -Ph	H	B33	CF ₃	Cl	Me		tBu	H	B24	Cl	Cl	Me
2,6-F ₂ -Ph	H	B34	CF ₃	Cl	Me		tBu	H	B25	Cl	Cl	Me
2,6-F ₂ -Ph	H	Na	CF ₃	Cl	Me		tBu	H	B26	Cl	Cl	Me
2,6-F ₂ -Ph	H	K	CF ₃	Cl	Me		tBu	H	B27	Cl	Cl	Me
2,6-F ₂ -Ph	H	B7	Cl	H	H		tBu	H	B28	Cl	Cl	Me
2,6-F ₂ -Ph	H	B9	Cl	H	H	50	tBu	H	B29	Cl	Cl	Me
2,6-F ₂ -Ph	H	B10	Cl	H	H		tBu	H	B30	Cl	Cl	Me
2,6-F ₂ -Ph	H	B11	Cl	H	H		tBu	H	B31	Cl	Cl	Me
tBu	H	H	H	CF ₃	Me		tBu	H	B32	Cl	Cl	Me
tBu	H	H	Me	H	Me		tBu	H	B33	Cl	Cl	Me
tBu	H	H	Me	H	CF ₃		tBu	H	B34	Cl	Cl	Me
tBu	H	B7	Me	H	H	55	tBu	H	Na	Cl	Cl	Me
tBu	H	H	Me	Me	Me		tBu	H	K	Cl	Cl	Me
tBu	H	H	Me	Cl	Me		tBu	H	B2	CF ₃	Cl	Me
tBu	H	H	Me	Br	Me		tBu	H	B3	CF ₃	Cl	Me
tBu	H	H	Et	Me	Me		tBu	H	B4	CF ₃	Cl	Me
tBu	H	H	Cl	Me	Me		tBu	H	B5	CF ₃	Cl	Me
tBu	H	H	Cl	H	Me		tBu	H	B6	CF ₃	Cl	Me
tBu	H	H	Cl	H	CF ₃	60	tBu	H	B7	CF ₃	Cl	Me
tBu	H	H	Cl	H	H		tBu	H	B8	CF ₃	Cl	Me
tBu	Me	H	Cl	H	H		tBu	H	B9	CF ₃	Cl	Me
tBu	Cl	H	Cl	H	H		tBu	H	B10	CF ₃	Cl	Me
tBu	H	H	Cl	Cl	Me		tBu	H	B11	CF ₃	Cl	Me
tBu	H	H	Cl	Cl	CF ₃		tBu	H	B12	CF ₃	Cl	Me
tBu	H	H	Cl	Cl	CF ₂ H	65	tBu	H	B13	CF ₃	Cl	Me
tBu	H	H	Cl	Cl	CH ₂ OMe		tBu	H	B14	CF ₃	Cl	Me

TABLE 4-continued

tBu	H	H	Cl	Cl	COMe
tBu	H	H	Cl	CF ₃	Me
tBu	H	H	Br	Me	Me
tBu	H	H	Me	OMe	Me
tBu	H	B7	OMe	H	H
tBu	H	B7	OC ₃	H	H
tBu	H	B7	SMe	H	H
tBu	H	H	CF ₃	Me	Me
tBu	H	H	CF ₃	Cl	Me
tBu	H	H	CF ₃	Cl	Me
tBu	H	H	CF ₃	Cl	Me
tBu	Br	H	CF ₃	Cl	Me
tBu	CF ₃	H	CF ₃	Cl	Me
tBu	NO ₂	H	CF ₃	Cl	Me
tBu	CN	H	CF ₃	Cl	Me
tBu	CO ₂ Me	H	CF ₃	Cl	CF ₃
tBu	CO ₂ Et	H	CF ₃	Cl	CF ₂ H
tBu	H	H	CF ₃	Cl	CH ₂ OMe
tBu	H	H	CF ₃	H	Me
tBu	H	H	CF ₃	Br	Me
tBu	H	H	CF ₃	NO ₂	Me
tBu	H	H	CF ₃	CN	Me
tBu	H	H	CF ₃	NHMe	Me
tBu	H	H	CF ₃	NMe ₂	Me
tBu	H	H	CF ₃	CO ₂ Me	Me
tBu	H	H	CF ₃	OMe	Me
tBu	H	H	CF ₃	OCF ₂ H	CF ₂ H
tBu	H	H	Cl	NO ₂	Me
tBu	H	H	Cl	CN	Me
tBu	H	H	CO ₂ Me	Me	Me
tBu	H	B1	Cl	Cl	Me
tBu	H	B2	Cl	Cl	Me
tBu	H	B3	Cl	Cl	Me
tBu	H	B4	Cl	Cl	Me
tBu	H	B5	Cl	Cl	Me
tBu	H	B6	Cl	Cl	Me
tBu	H	B7	Cl	Cl	Me
tBu	H	B8	Cl	Cl	Me
tBu	H	B9	Cl	Cl	Me
tBu	H	B10	Cl	Cl	Me
tBu	H	B11	Cl	Cl	Me
tBu	H	B12	Cl	Cl	Me
tBu	H	B13	Cl	Cl	Me
tBu	H	B14	Cl	Cl	Me
tBu	H	B15	Cl	Cl	Me
tBu	H	B16	Cl	Cl	Me
tBu	H	B17	Cl	Cl	Me
tBu	H	B18	Cl	Cl	Me
tBu	H	B19	Cl	Cl	Me
tBu	H	B20	Cl	Cl	Me
tBu	H	B21	Cl	Cl	Me
tBu	H	B22	Cl	Cl	Me
tBu	H	B23	Cl	Cl	Me
tBu	H	B24	Cl	Cl	Me
tBu	H	B25	Cl	Cl	Me
tBu	H	B26	Cl	Cl	Me
tBu	H	B27	Cl	Cl	Me
tBu	H	B28	Cl	Cl	Me
tBu	H	B29	Cl	Cl	Me
tBu	H	B30	Cl	Cl	Me
tBu	H	B31	Cl	Cl	Me
tBu	H	B32	Cl	Cl	Me
tBu	H	B33	Cl	Cl	Me
tBu	H	B34	Cl	Cl	Me
tBu	H	Na	Cl	Cl	Me
tBu	H	K	Cl	Cl	Me
tBu	H	B2	CF ₃	Cl	Me
tBu	H	B3	CF ₃	Cl	Me
tBu	H	B4	CF ₃	Cl	Me
tBu	H	B5	CF ₃	Cl	Me
tBu	H	B6	CF ₃	Cl	Me
tBu	H	B7	CF ₃	Cl	Me
tBu	H	B8	CF ₃	Cl	Me
tBu	H	B9	CF ₃	Cl	Me
tBu	H	B10	CF ₃	Cl	Me
tBu	H	B11	CF ₃	Cl	Me
tBu	H	B12	CF ₃	Cl	Me
tBu	H	B13	CF ₃	Cl	Me
tBu	H	B14	CF ₃	Cl	Me

TABLE 4-continued

tBu	H	B15	CF ₃	Cl	Me	
tBu	H	B16	CF ₃	Cl	Me	
tBu	H	B17	CF ₃	Cl	Me	5
tBu	H	B18	CF ₃	Cl	Me	
tBu	H	B19	CF ₃	Cl	Me	
tBu	H	B20	CF ₃	Cl	Me	
tBu	H	B21	CF ₃	Cl	Me	
tBu	H	B22	CF ₃	Cl	Me	
tBu	H	B23	CF ₃	Cl	Me	10
tBu	H	B24	CF ₃	Cl	Me	
tBu	H	B25	CF ₃	Cl	Me	
tBu	H	B26	CF ₃	Cl	Me	
tBu	H	B27	CF ₃	Cl	Me	
tBu	H	B28	CF ₃	Cl	Me	
tBu	H	B29	CF ₃	Cl	Me	15
tBu	H	B30	CF ₃	Cl	Me	
tBu	H	B31	CF ₃	Cl	Me	
tBu	H	B32	CF ₃	Cl	Me	
tBu	H	B33	CF ₃	Cl	Me	
tBu	H	B34	CF ₃	Cl	Me	
tBu	H	Na	CF ₃	Cl	Me	20
tBu	H	K	CF ₃	Cl	Me	
tBu	H	B7	Cl	H	H	
tBu	H	B8	Cl	H	H	
tBu	H	B15	Cl	H	H	
tBu	H	B34	Cl	H	H	
2-pyridyl	H	H	H	CF ₃	Me	25
2-pyridyl	H	H	Me	H	Me	
2-pyridyl	H	H	Me	H	CF ₃	
2-pyridyl	H	B7	Me	H	H	
2-pyridyl	H	H	Me	Me	Me	
2-pyridyl	H	H	Me	Cl	Me	
2-pyridyl	H	H	Me	Br	Me	
2-pyridyl	H	H	Et	Me	Me	30
2-pyridyl	H	H	Cl	Me	Me	
2-pyridyl	H	H	Cl	H	Me	
2-pyridyl	H	H	Cl	H	CF ₃	
2-pyridyl	H	H	Cl	H	H	
2-pyridyl	Me	H	Cl	H	H	
2-pyridyl	Cl	H	Cl	H	H	35
2-pyridyl	H	H	Cl	Cl	Me	
2-pyridyl	H	H	Cl	Cl	CF ₃	
2-pyridyl	H	H	Cl	Cl	CF ₂ H	
2-pyridyl	H	H	Cl	Cl	CH ₂ OMe	
2-pyridyl	H	H	Cl	Cl	COMe	
2-pyridyl	H	H	Cl	CF ₃	Me	40
2-pyridyl	H	H	Br	Me	Me	
2-pyridyl	H	H	Me	OMe	Me	
2-pyridyl	H	H	Br	H	H	
2-pyridyl	H	B7	OMe	H	H	
2-pyridyl	H	B7	OCF ₃	H	H	
2-pyridyl	H	B7	SMe	H	H	45
2-pyridyl	H	B7	NH ₂	H	H	
2-pyridyl	H	B7	NHMe	H	H	
2-pyridyl	H	B7	NMe ₂	H	H	
2-pyridyl	H	B7	NO ₂	H	H	
2-pyridyl	H	B7	CN	H	H	
2-pyridyl	H	B7	CO ₂ Me	H	H	
2-pyridyl	H	H	CO ₂ Et	H	H	50
2-pyridyl	H	H	CF ₃	Me	Me	
2-pyridyl	H	H	CF ₃	Cl	Me	
2-pyridyl	H	H	CF ₃	H	Me	
2-pyridyl	H	H	CF ₃	Br	Me	
2-pyridyl	H	H	CF ₃	CO ₂ Me	Me	
2-pyridyl	H	H	Cl	NO ₂	Me	55
2-pyridyl	H	H	Cl	CN	Me	
2-pyridyl	H	H	CO ₂ Me	Me	Me	
2-pyridyl	H	B3	Cl	Cl	Me	
2-pyridyl	H	B6	Cl	Cl	Me	
2-pyridyl	H	B7	Cl	Cl	Me	
2-pyridyl	H	B3	CF ₃	Cl	Me	
2-pyridyl	H	B6	CF ₃	Cl	Me	60
2-pyridyl	H	B7	CF ₃	Cl	Me	
2-pyridyl	H	B2	Cl	H	H	
2-pyridyl	H	B3	Cl	H	H	
2-pyridyl	H	B4	Cl	H	H	
2-pyridyl	H	B5	Cl	H	H	
2-pyridyl	H	B6	Cl	H	H	65
2-pyridyl	H	B7	Cl	H	H	

TABLE 4-continued

2-pyridyl	H	B8	Cl	H	H	
2-pyridyl	H	B9	Cl	H	H	
2-pyridyl	H	B10	Cl	H	H	
2-pyridyl	H	B11	Cl	H	H	
2-pyridyl	H	B12	Cl	H	H	
2-pyridyl	H	B13	Cl	H	H	
2-pyridyl	H	B14	Cl	H	H	
2-pyridyl	H	B15	Cl	H	H	
2-pyridyl	H	B16	Cl	H	H	
2-pyridyl	H	B17	Cl	H	H	
2-pyridyl	H	B18	Cl	H	H	
2-pyridyl	H	B19	Cl	H	H	
2-pyridyl	H	B20	Cl	H	H	
2-pyridyl	H	B21	Cl	H	H	
2-pyridyl	H	B22	Cl	H	H	
2-pyridyl	H	B23	Cl	H	H	
2-pyridyl	H	B24	Cl	H	H	
2-pyridyl	H	B25	Cl	H	H	
2-pyridyl	H	B26	Cl	H	H	
2-pyridyl	H	B27	Cl	H	H	
2-pyridyl	H	B28	Cl	H	H	
2-pyridyl	H	B29	Cl	H	H	
2-pyridyl	H	B30	Cl	H	H	
2-pyridyl	H	B31	Cl	H	H	
2-pyridyl	H	B32	Cl	H	H	
2-pyridyl	H	B33	Cl	H	H	
2-pyridyl	H	B34	Cl	H	H	
2-pyridyl	H	Na	Cl	H	H	
2-pyridyl	H	K	Cl	H	H	
3-pyridyl	H	H	Cl	Cl	Me	
3-pyridyl	H	H	CF ₃	Cl	Me	
3-pyridyl	H	H	Cl	H	H	
4-pyridyl	H	H	Cl	Cl	Me	
4-pyridyl	H	H	CF ₃	Cl	Me	
4-pyridyl	H	H	Cl	H	H	
4-pyridyl	H	H	Cl	H	H	
2-F—Ph	H	H	Me	Me	Me	
2-F—Ph	H	H	Me	Cl	Me	
2-F—Ph	H	H	Cl	H	H	
2-F—Ph	H	H	Cl	Cl	Me	
2-F—Ph	H	B7	OMe	H	H	
2-F—Ph	H	B7	SMe	H	H	
2-F—Ph	H	B7	CF ₃	Cl	Me	
2-F—Ph	H	B7	CF ₃	H	Me	
2-F—Ph	H	B1	Cl	Cl	Me	
2-F—Ph	H	B3	Cl	Cl	Me	
2-F—Ph	H	B6	Cl	Cl	Me	
2-F—Ph	H	B7	Cl	Cl	Me	
2-F—Ph	H	B3	CF ₃	Cl	Me	
2-F—Ph	H	B6	CF ₃	Cl	Me	
2-F—Ph	H	B7	CF ₃	Cl	Me	
3-F—Ph	H	B7	Cl	H	H	
4-F—Ph	H	H	Cl	Cl	Me	
2,3-F ₂ —Ph	H	H	Cl	Cl	Me	
2,4-F ₂ —Ph	H	H	Cl	Cl	Me	
2,5-F ₂ —Ph	H	H	Cl	Cl	Me	
Ph	H	H	Me	Me	Me	
Ph	H	H	Me	Cl	Me	
Ph	H	H	Cl	Me	Me	
Ph	H	H	Cl	H	H	
Ph	H	H	Cl	Cl	Me	
Ph	H	B7	OMe	H	H	
Ph	H	B7	SMe	H	H	
Ph	H	H	CF ₃	Cl	Me	
Ph	H	H	CF ₃	H	Me	
Ph	H	B1	Cl	Cl	Me	
Ph	H	B3	Cl	Cl	Me	
Ph	H	B6	Cl	Cl	Me	
Ph	H	B7	Cl	Cl	Me	
Ph	H	B3	CF ₃	Cl	Me	
Ph	H	B6	CF ₃	Cl	Me	
Ph	H	B7	CF ₃	Cl	Me	
Ph	Me	B7	CF ₃	Cl	Me	
Ph	H	B7	Cl	H	H	
3,4-F ₂ —Ph	H	H	Cl	Cl	Me	
3,5-F ₂ —Ph	H	H	Cl	Cl	Me	
2-Cl—Ph	H	H	Me	Me	Me	
2-Cl—Ph	H	H	Me	Cl	Me	

TABLE 4-continued

2-Cl—Ph	H	H	Cl	Me	Me
2-Cl—Ph	H	H	Cl	H	H
2-Cl—Ph	H	H	Cl	Cl	Me
2-Cl—Ph	H	H	OMe	H	H
2-Cl—Ph	H	H	SMe	H	H
2-Cl—Ph	H	H	CF ₃	Cl	Me
2-Cl—Ph	H	H	CF ₃	H	Me
2-Cl—Ph	H	B1	Cl	Cl	Me
2-Cl—Ph	H	B3	Cl	Cl	Me
2-Cl—Ph	H	B6	Cl	Cl	Me
2-Cl—Ph	H	B7	Cl	Cl	Me
2-Cl—Ph	H	B3	CF ₃	Cl	Me
2-Cl—Ph	H	B6	CF ₃	Cl	Me
2-Cl—Ph	H	B7	CF ₃	Cl	Me
2-Cl—Ph	H	B7	Cl	H	H
3-Cl—Ph	H	H	Cl	Cl	Me
4-Cl—Ph	H	H	Cl	Cl	Me
2,3-Cl ₂ —Ph	H	H	Cl	Cl	Me
2,4-Cl ₂ —Ph	H	H	Cl	Cl	Me
2,5-Cl ₂ —Ph	H	H	Cl	Cl	Me
2,6-Cl ₂ —Ph	H	H	Me	Me	Me
2,6-Cl ₂ —Ph	H	H	Me	Cl	Me
2,6-Cl ₂ —Ph	H	H	Cl	Me	Me
2,6-Cl ₂ —Ph	H	H	Cl	H	H
2,6-Cl ₂ —Ph	H	H	Cl	Cl	Me
2,6-Cl ₂ —Ph	H	B7	OMe	H	H
2,6-Cl ₂ —Ph	H	B7	SMe	H	H
2,6-Cl ₂ —Ph	H	H	CF ₃	Cl	Me
2,6-Cl ₂ —Ph	H	H	CF ₃	H	Me
2,6-Cl ₂ —Ph	H	B1	Cl	Cl	Me
2,6-Cl ₂ —Ph	H	B3	Cl	Cl	Me
2,6-Cl ₂ —Ph	H	B6	Cl	Cl	Me
2,6-Cl ₂ —Ph	Cl	B7	Cl	Cl	Me
2,6-Cl ₂ —Ph	H	B7	Cl	Cl	Me
2,6-Cl ₂ —Ph	H	B3	CF ₃	Cl	Me
2,6-Cl ₂ —Ph	H	B6	CF ₃	Cl	Me
2,6-Cl ₂ —Ph	Cl	B7	CF ₃	Cl	Me
2,6-Cl ₂ —Ph	H	B7	CF ₃	Cl	Me
2,6-Cl ₂ —Ph	H	H	Cl	H	H
3,4-Cl ₂ —Ph	H	H	Cl	Cl	Me
3,5-Cl ₂ —Ph	H	H	Cl	Cl	Me
2-Me—Ph	H	H	Cl	Cl	Me
2-Me—Ph	H	H	CF ₃	Cl	Me
2,6-Me ₂ —Ph	H	H	Cl	Cl	Me
2,6-Me ₂ —Ph	H	H	CF ₃	Cl	Me
2-MeO—Ph	H	H	Cl	Cl	Me
2-MeO—Ph	H	H	CF ₃	Cl	Me
2-CF ₃ O—Ph	H	H	Cl	Cl	Me
2-CF ₃ O—Ph	H	H	CF ₃	Cl	Me
2-SMe—Ph	H	H	Cl	Cl	Me
2-SMe—Ph	H	H	CF ₃	Cl	Me
2-SOMe—Ph	H	H	Cl	Cl	Me
2-SOMe—Ph	H	H	CF ₃	Cl	Me
2-SO ₂ Me—Ph	H	H	Cl	Cl	Me
2-SO ₂ Me—Ph	H	H	CF ₃	Cl	Me
2-CF ₃ —Ph	H	H	Cl	Cl	Me
2-CF ₃ —Ph	H	H	CF ₃	Cl	Me
2-NO ₂ —Ph	H	H	Cl	Cl	Me
2-NO ₂ —Ph	H	H	CF ₃	Cl	Me
2-CN—Ph	H	H	Cl	Cl	Me
2-CN—Ph	H	H	CF ₃	Cl	Me
2-NHMe—Ph	H	H	Cl	Cl	Me
2-NMe ₂ —Ph	H	H	Cl	Cl	Me
4-benzyl-Ph	H	H	Cl	Cl	Me
4-phenoxy-Ph	H	H	Cl	Cl	Me
2-OH—Ph	H	H	Cl	Cl	Me
2-CO ₂ Me—Ph	H	H	Cl	Cl	Me
2-CO ₂ Me—Ph	H	H	CF ₃	Cl	Me
2-CO ₂ Et—Ph	H	H	Cl	Cl	Me
2-CO ₂ Et—Ph	H	H	CF ₃	Cl	Me
H	H	H	Cl	Cl	Me
Me	H	H	Cl	Cl	Me
Et	H	H	Cl	Cl	Me
nPr	H	H	Cl	Cl	Me
iPr	H	H	Cl	Cl	Me
iPr	H	H	CF ₃	Cl	Me
nBu	H	H	Cl	Cl	Me
nBu	H	H	CF ₃	Cl	Me
iBu	H	H	Cl	Cl	Me

TABLE 4-continued

iBu	H	H	CF ₃	Cl	Me
iBu	H	B7	Cl	Cl	Me
5 iBu	H	B7	CF ₃	Cl	Me
iBu	H	H	Cl	H	H
secBu	H	H	Cl	Cl	Me
secBu	H	H	CF ₃	Cl	Me
2,2-Me ₂ -propyl	H	H	Cl	Cl	Me
nHex	H	H	Cl	Cl	Me
10 ethenyl	H	H	Cl	Cl	Me
1-propenyl	H	H	Cl	Cl	Me
1-propenyl	H	H	CF ₃	Cl	Me
ethynyl	H	H	Cl	Cl	Me
1-propynyl	H	H	Cl	Cl	Me
CF ₃	H	H	Cl	Cl	Me
15 CF ₃	H	H	CF ₃	Cl	Me
CHF ₂	H	H	Cl	Cl	Me
C ₂ F ₅	H	H	Cl	Cl	Me
2,2-Cl ₂ -cPr	H	H	Cl	Cl	Me
2,2-Cl ₂ -cPr	H	H	CF ₃	Cl	Me
cPr	H	H	Cl	Cl	Me
20 cPr	H	H	CF ₃	Cl	Me
1-Me-cPr	H	H	Cl	Cl	Me
1-Me-cPr	H	H	CF ₃	Cl	Me
cHex	H	H	Cl	Cl	Me
cHex	H	H	CF ₃	Cl	Me
CH ₂ Ph	H	H	Cl	Cl	Me
25 naphthyl-1	H	H	Cl	Cl	Me
naphthyl-1	H	H	CF ₃	Cl	Me
naphthyl-2	H	H	Cl	Cl	Me
CO ₂ Me	H	H	Cl	Cl	Me
CO ₂ Et	H	H	Cl	Cl	Me
2-thienyl	H	H	Cl	Cl	Me
2-thienyl	H	H	CF ₃	Cl	Me
30 CH ₂ OMe	H	H	Cl	Cl	Me
CH ₂ OEt	H	H	Cl	Cl	Me
COCH ₃	H	H	Cl	Cl	Me
COTBu	H	H	Cl	Cl	Me
COPh	H	H	Cl	Cl	Me
35					

TABLE 5

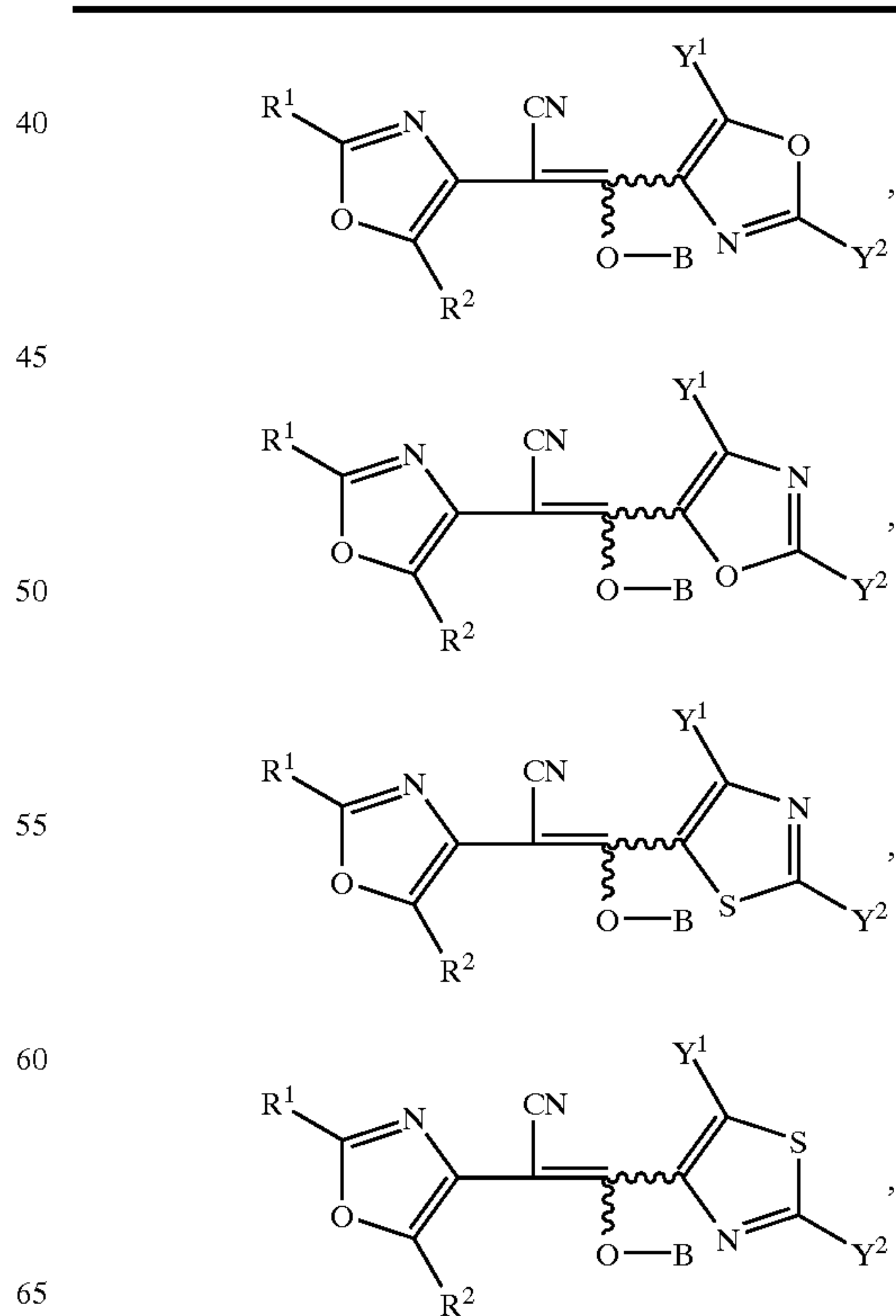

TABLE 5-continued

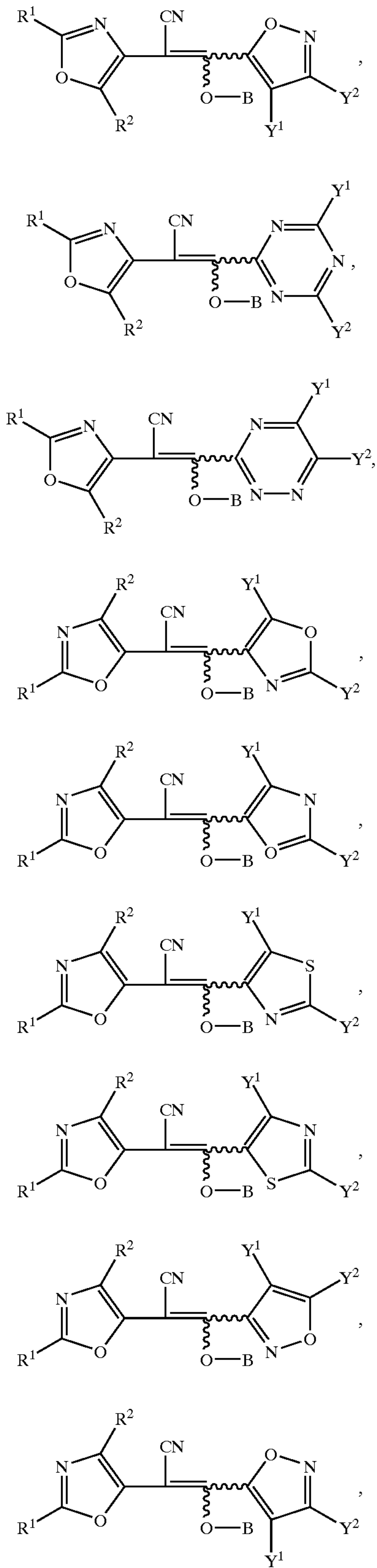

TABLE 5-continued

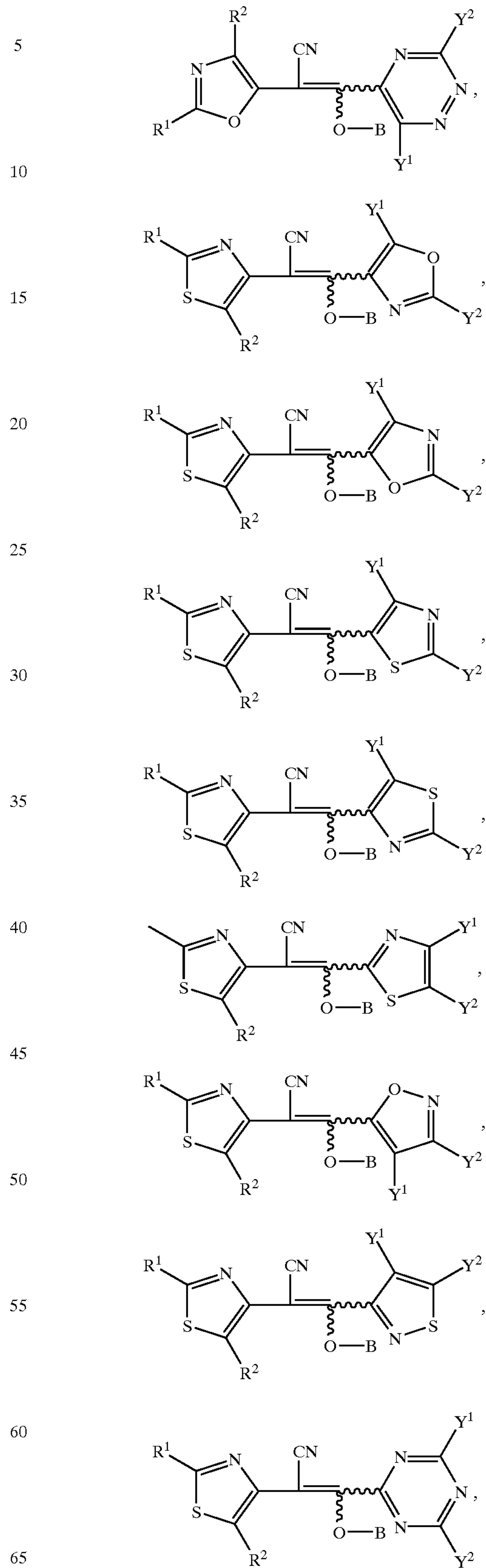

TABLE 5-continued

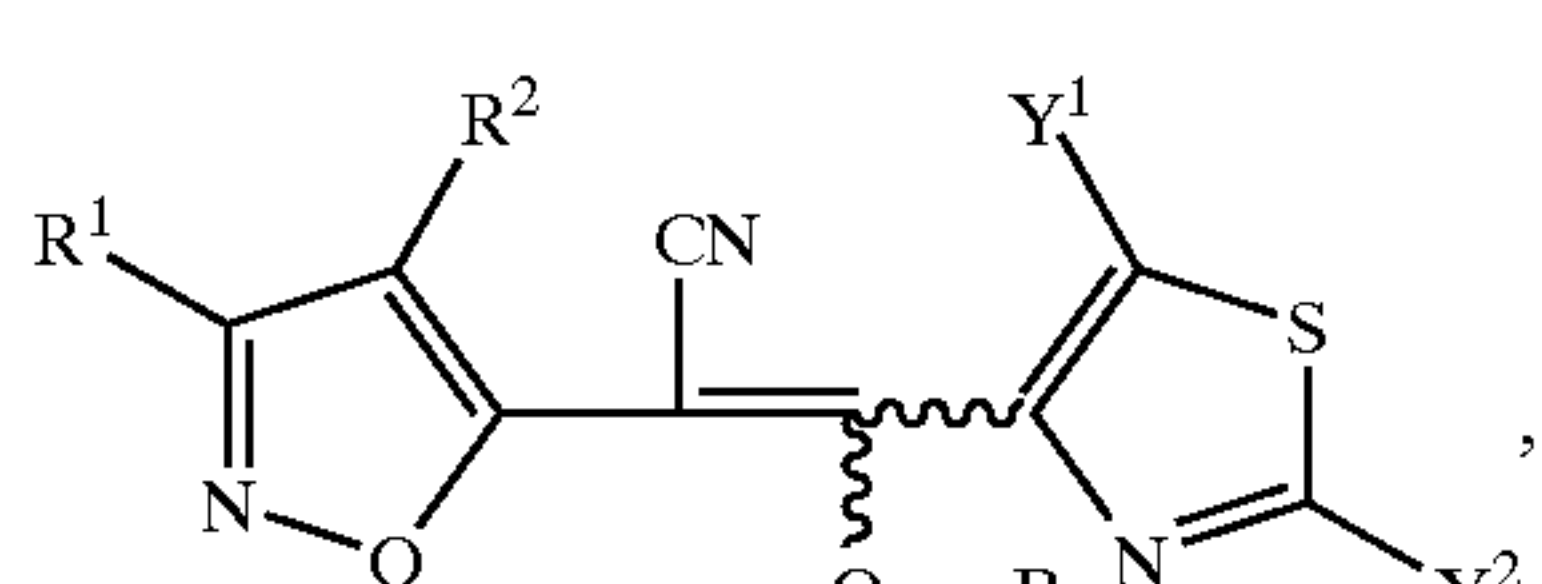
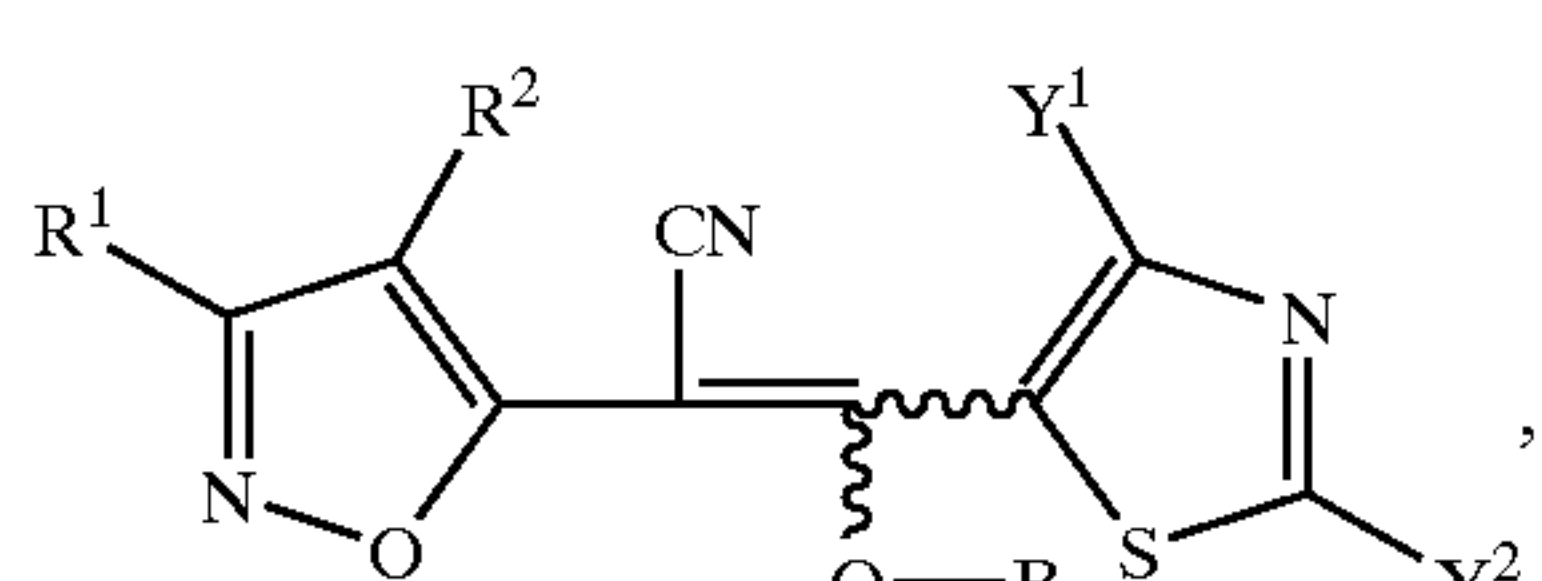
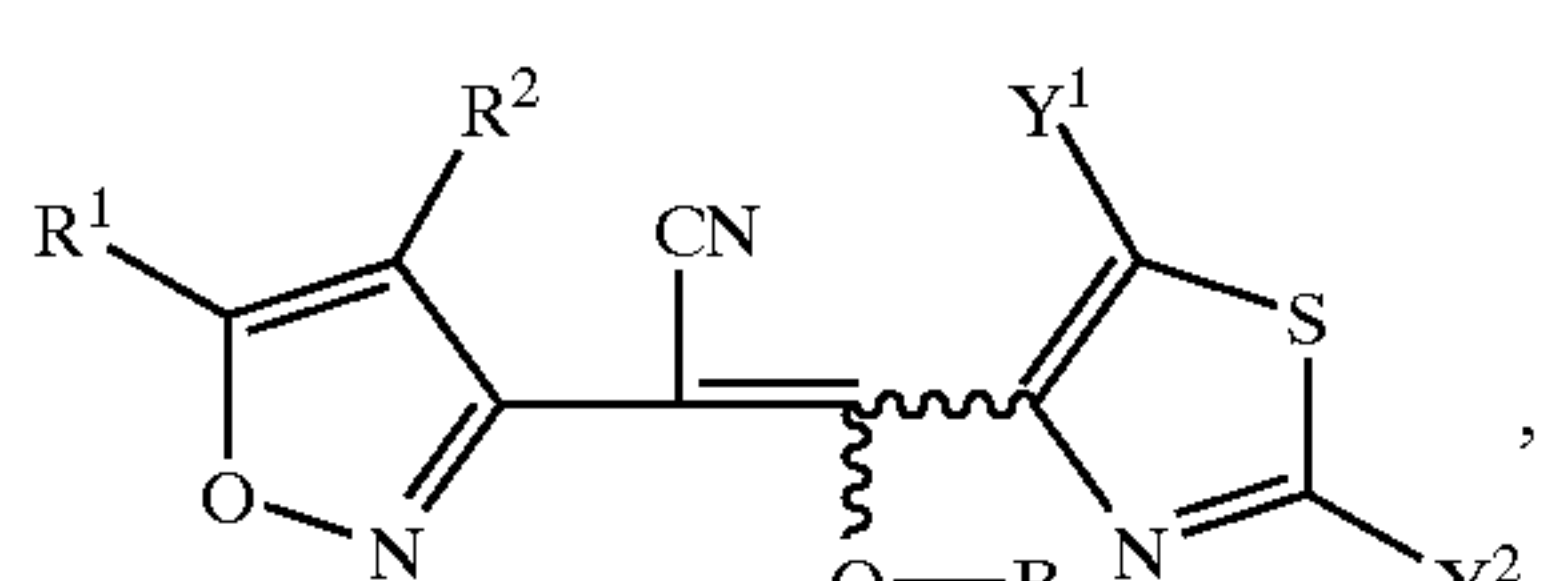
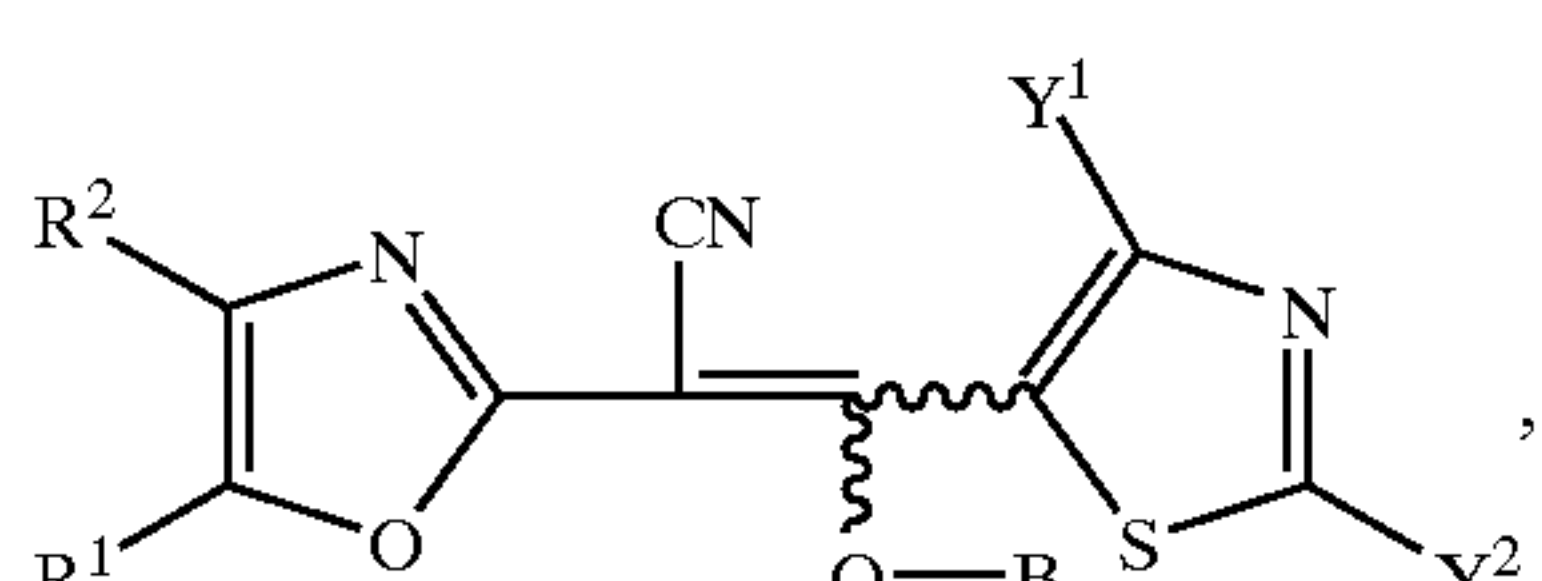
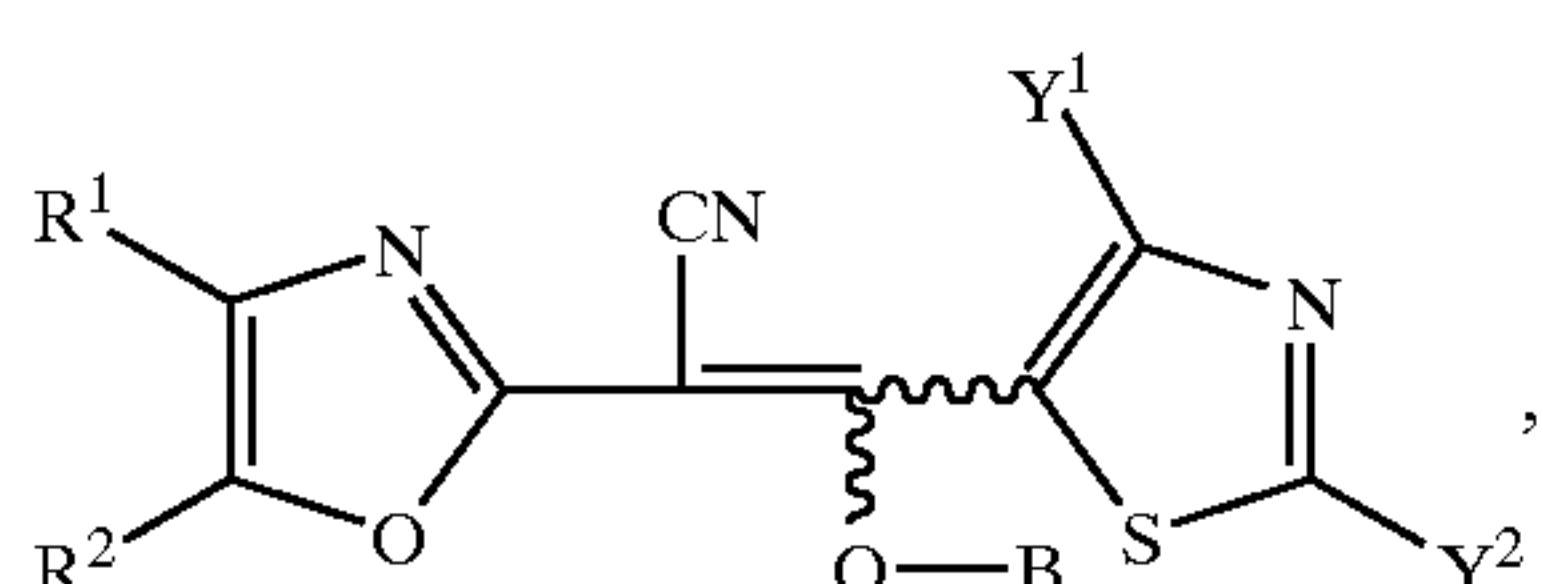
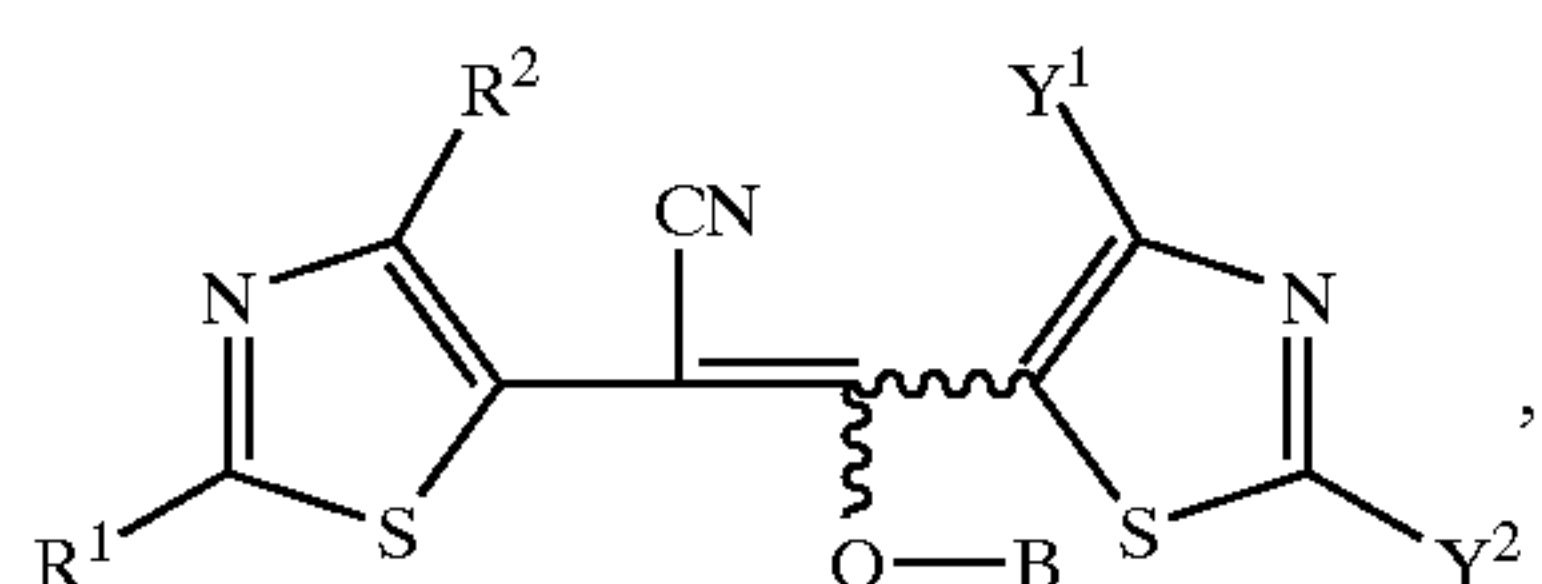
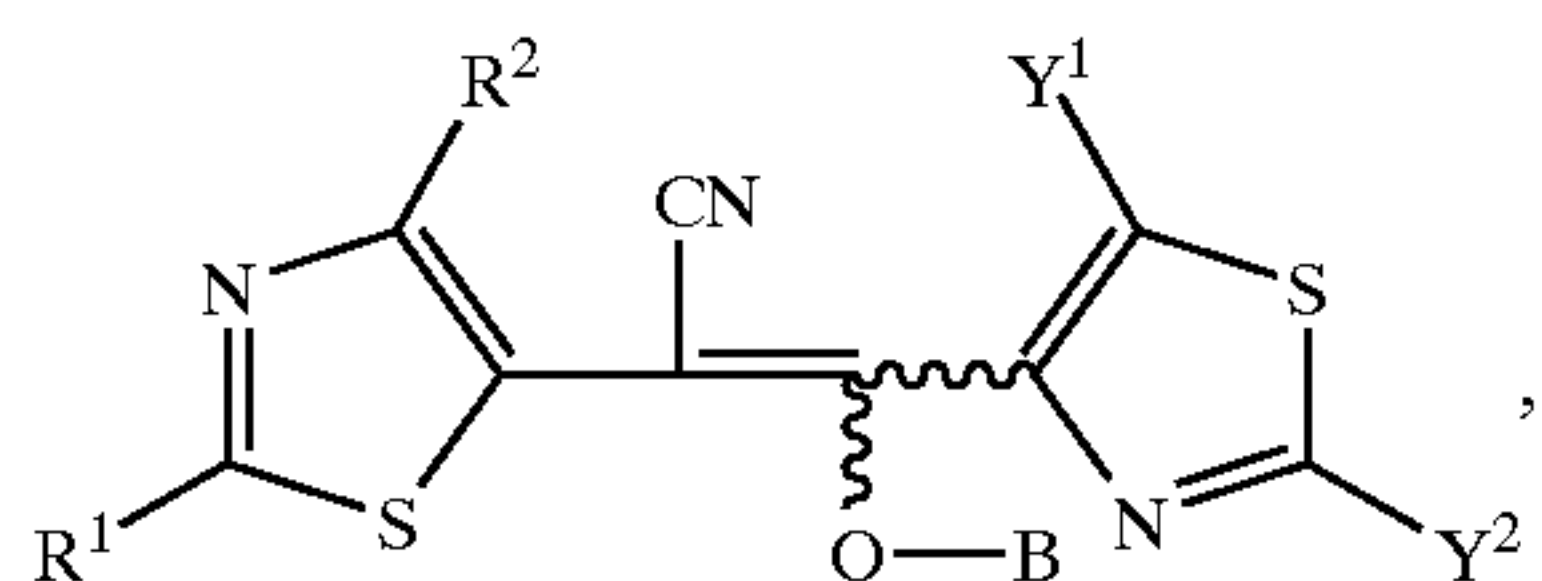
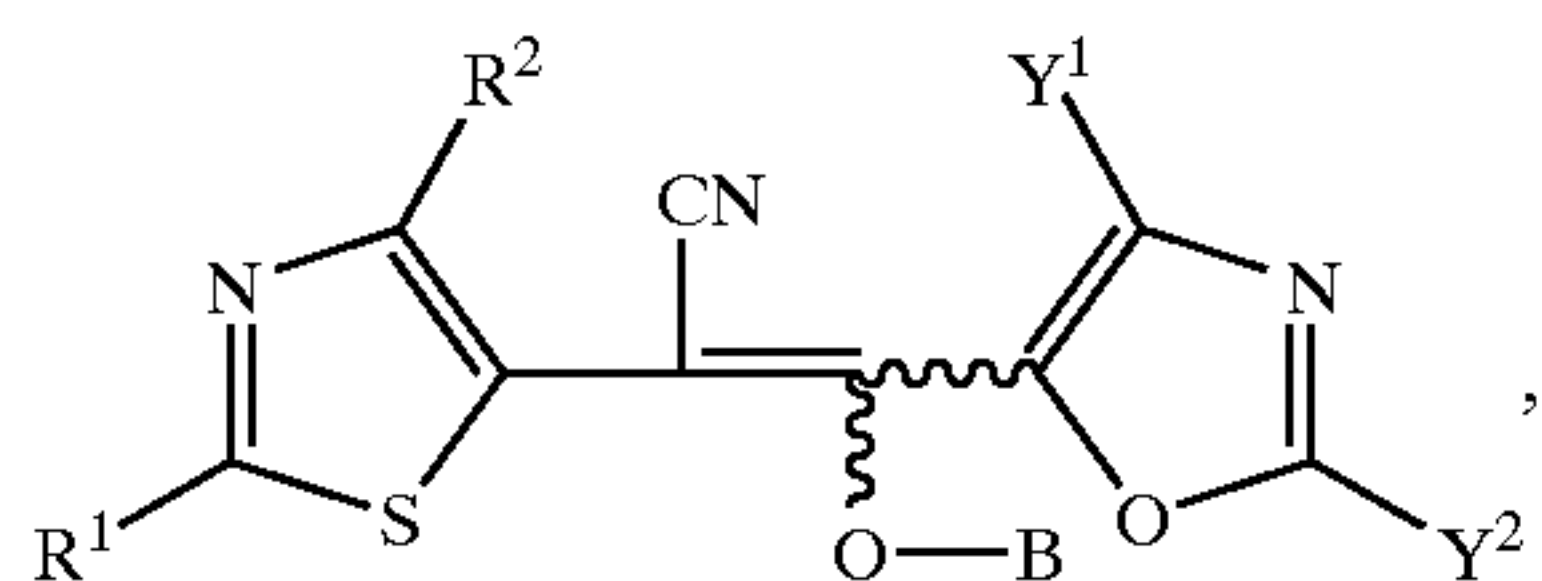
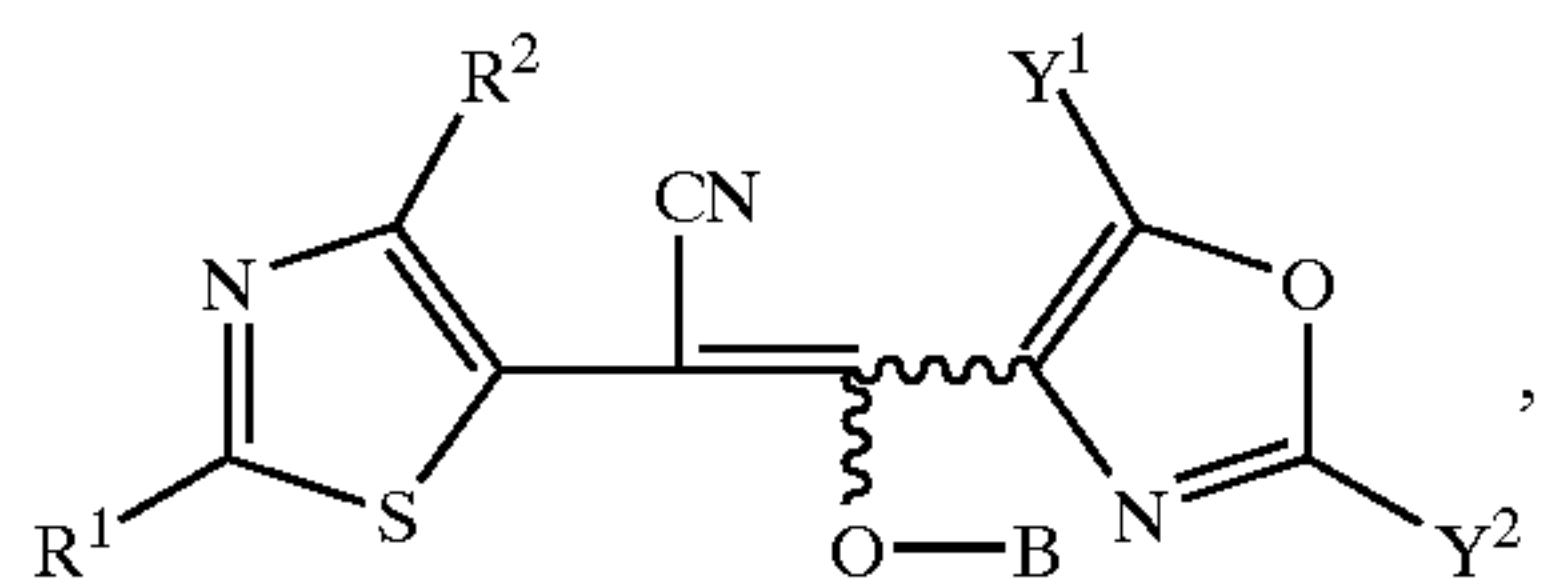
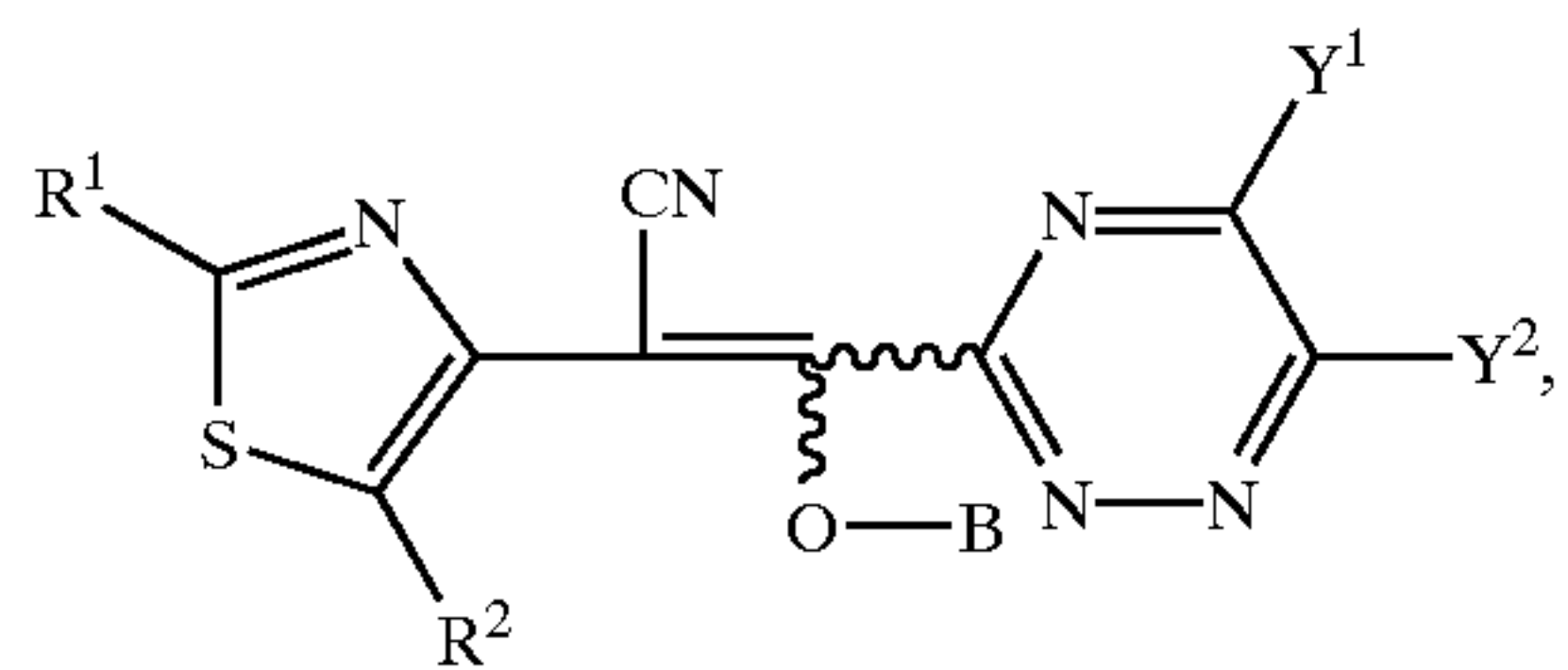

TABLE 5-continued

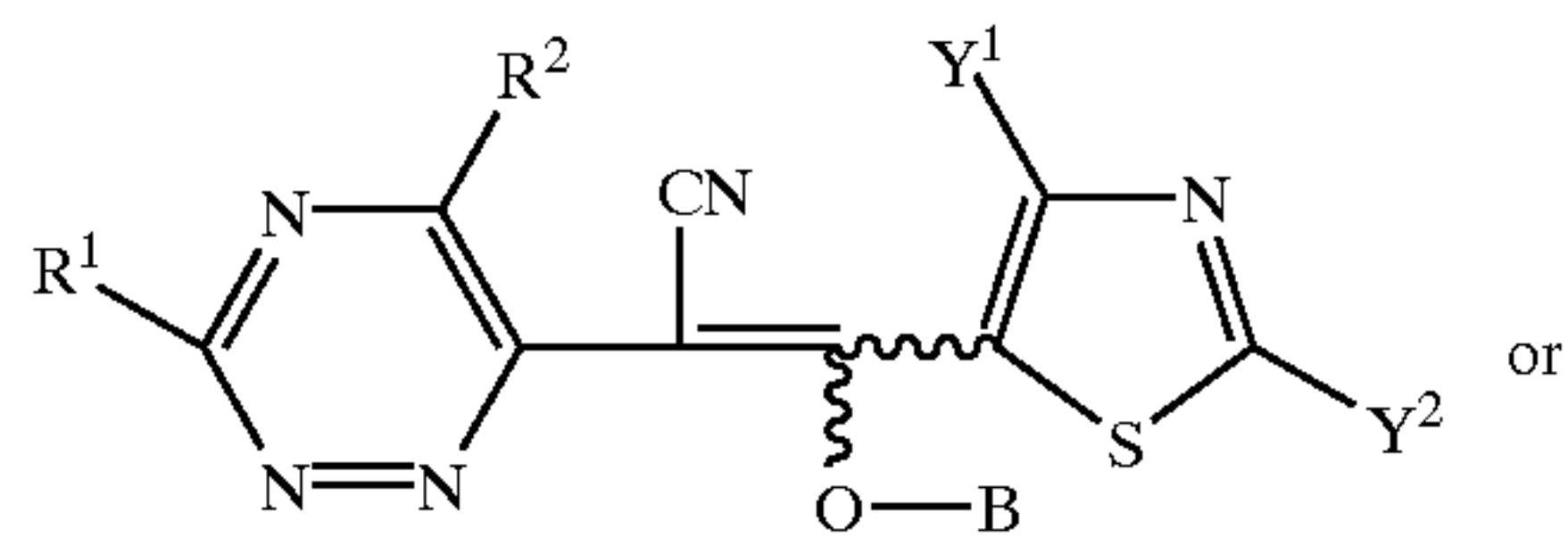
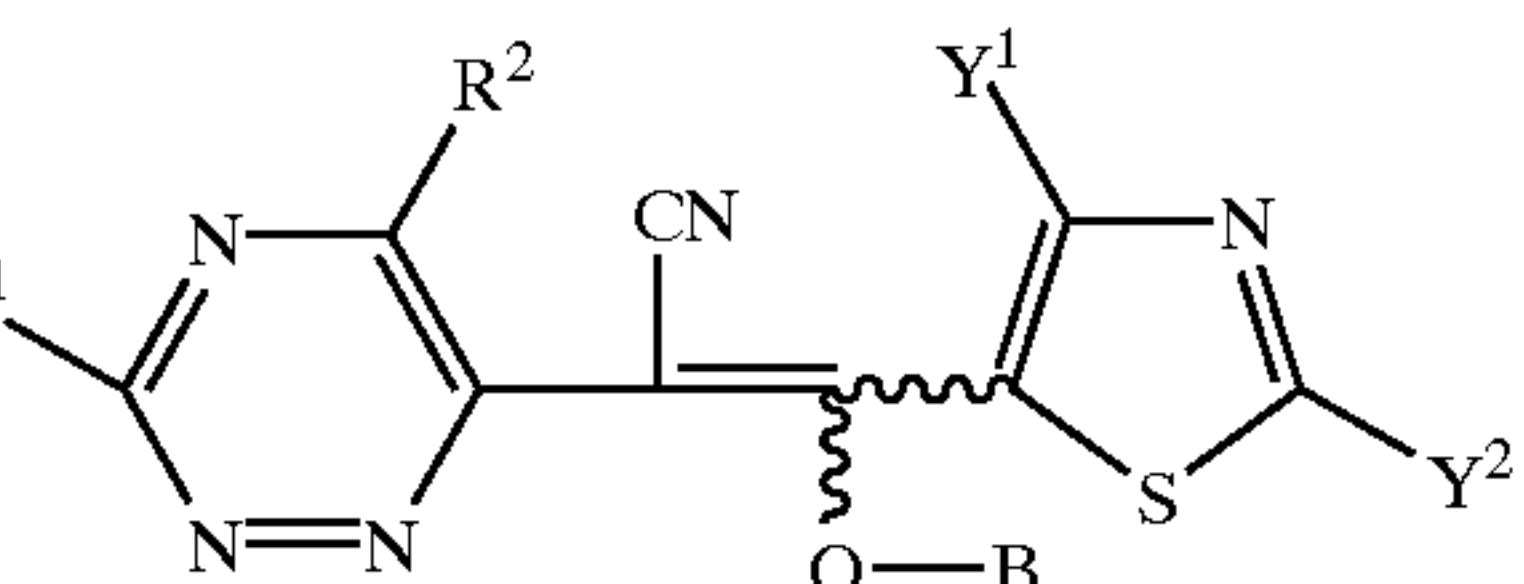
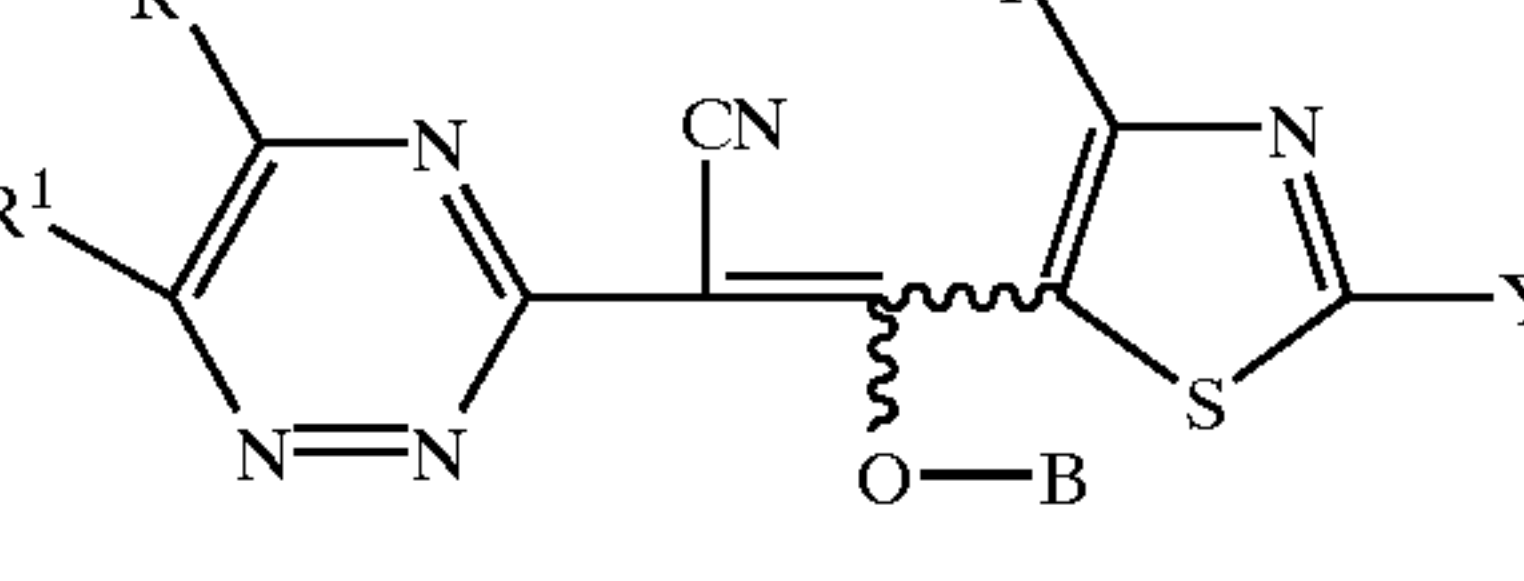
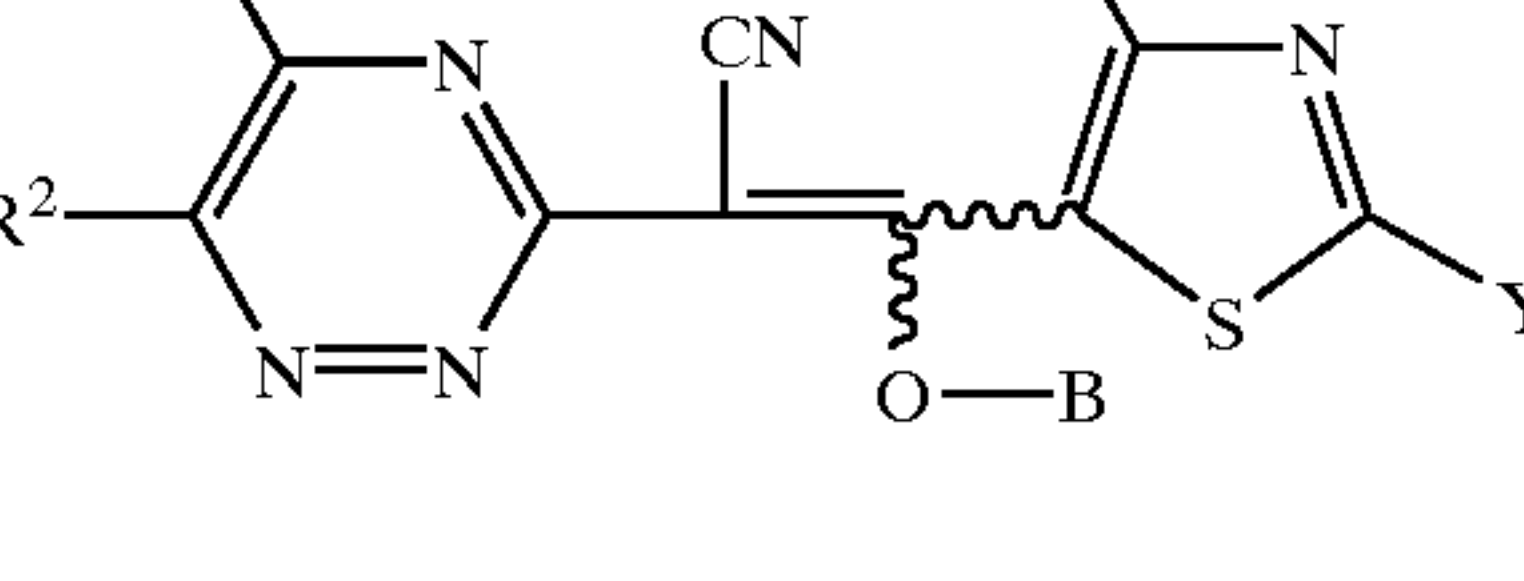
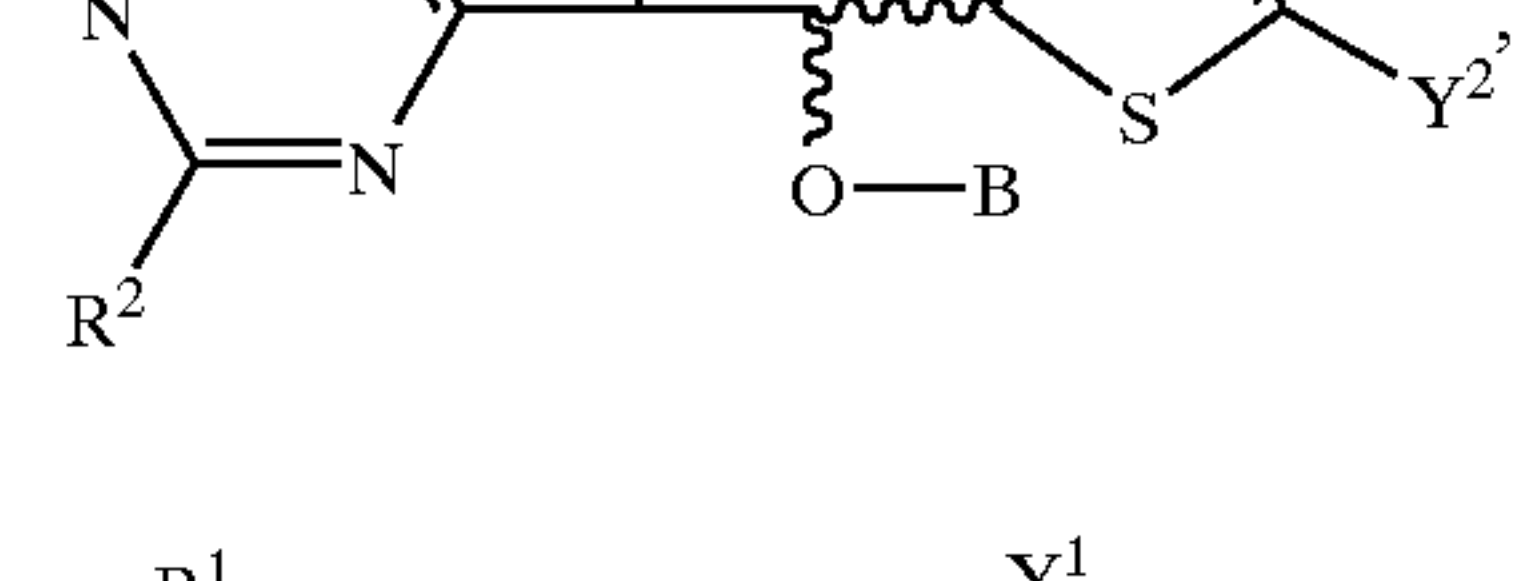
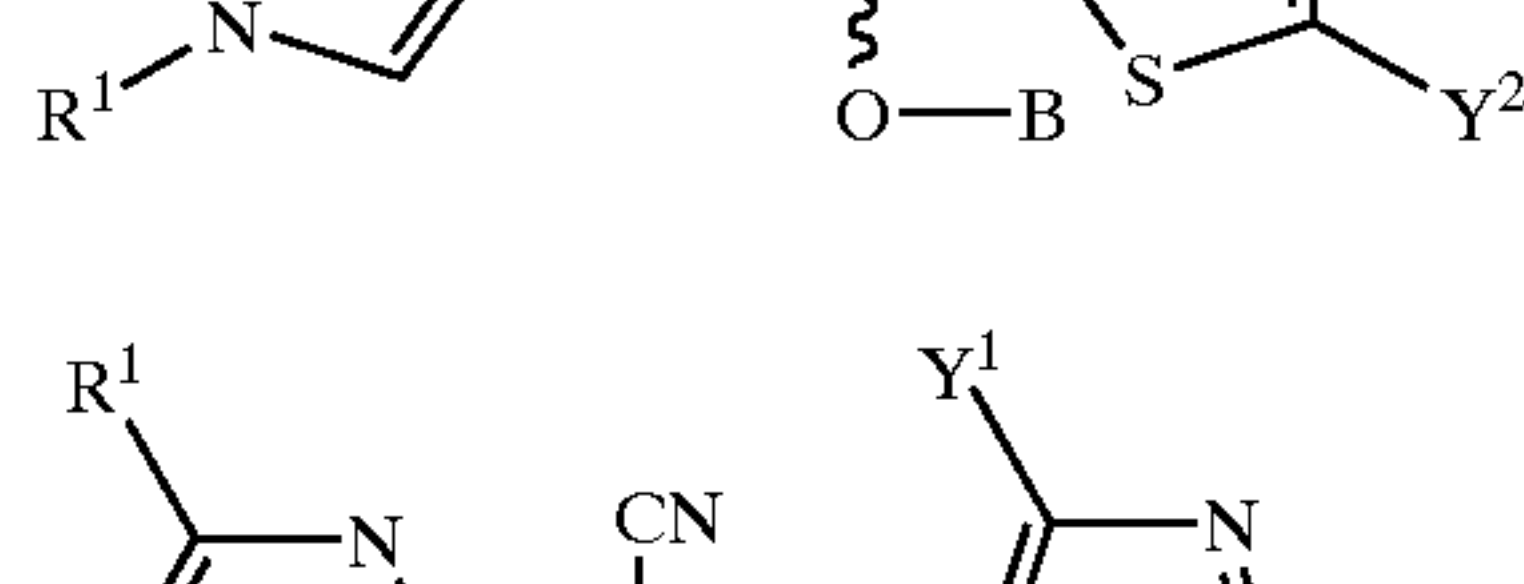
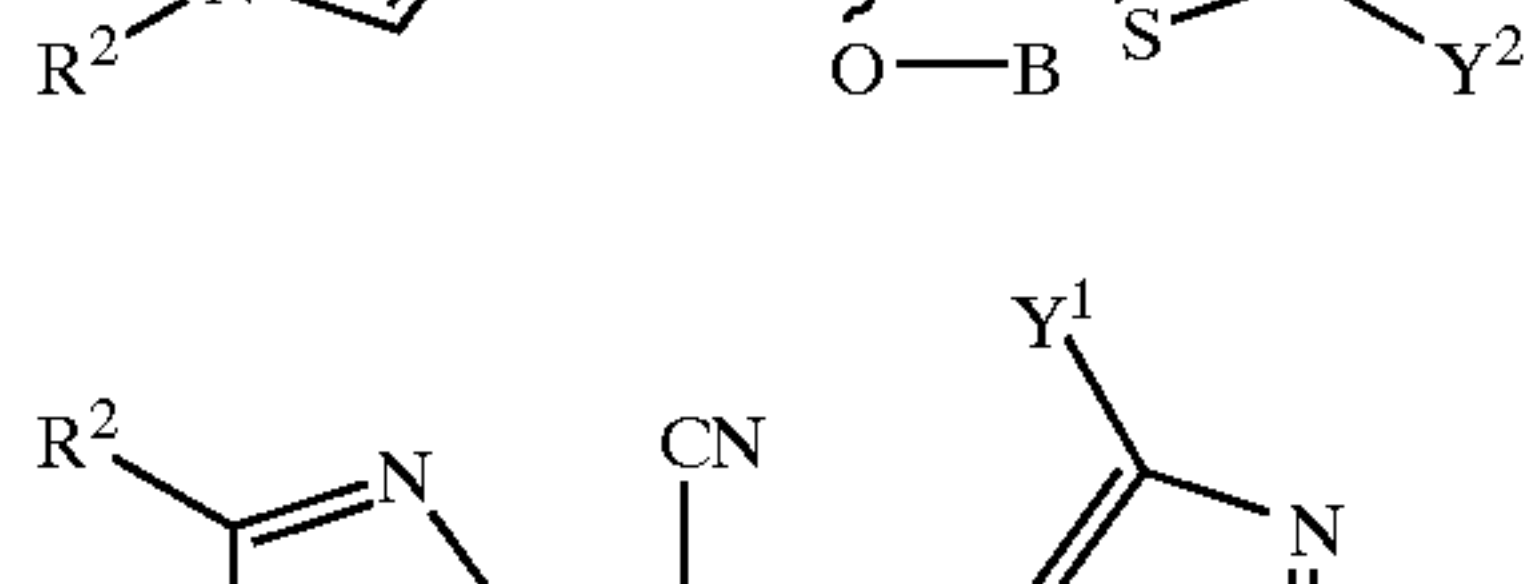
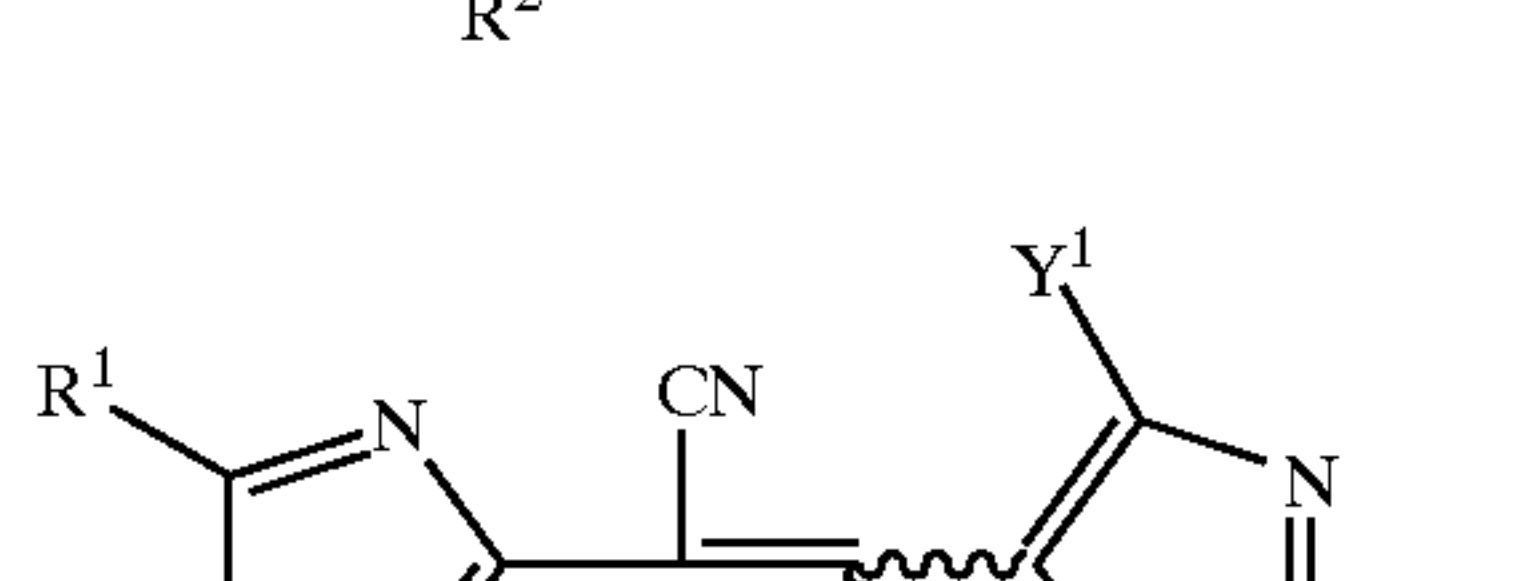
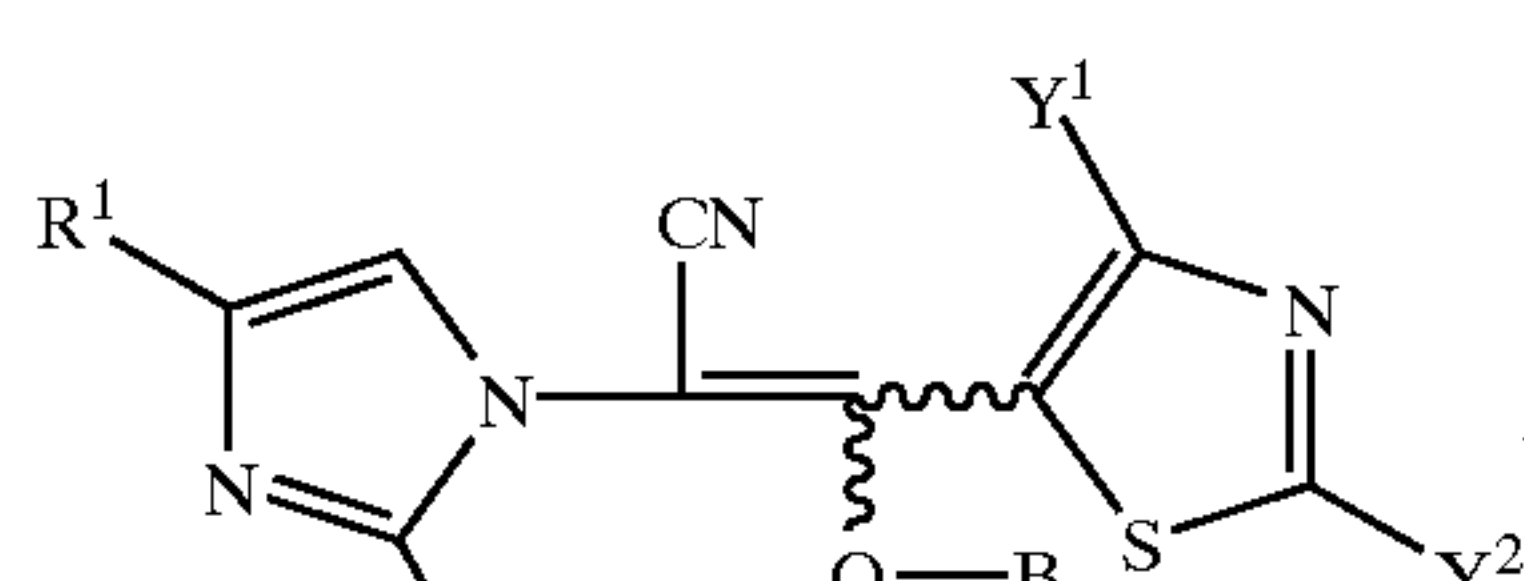
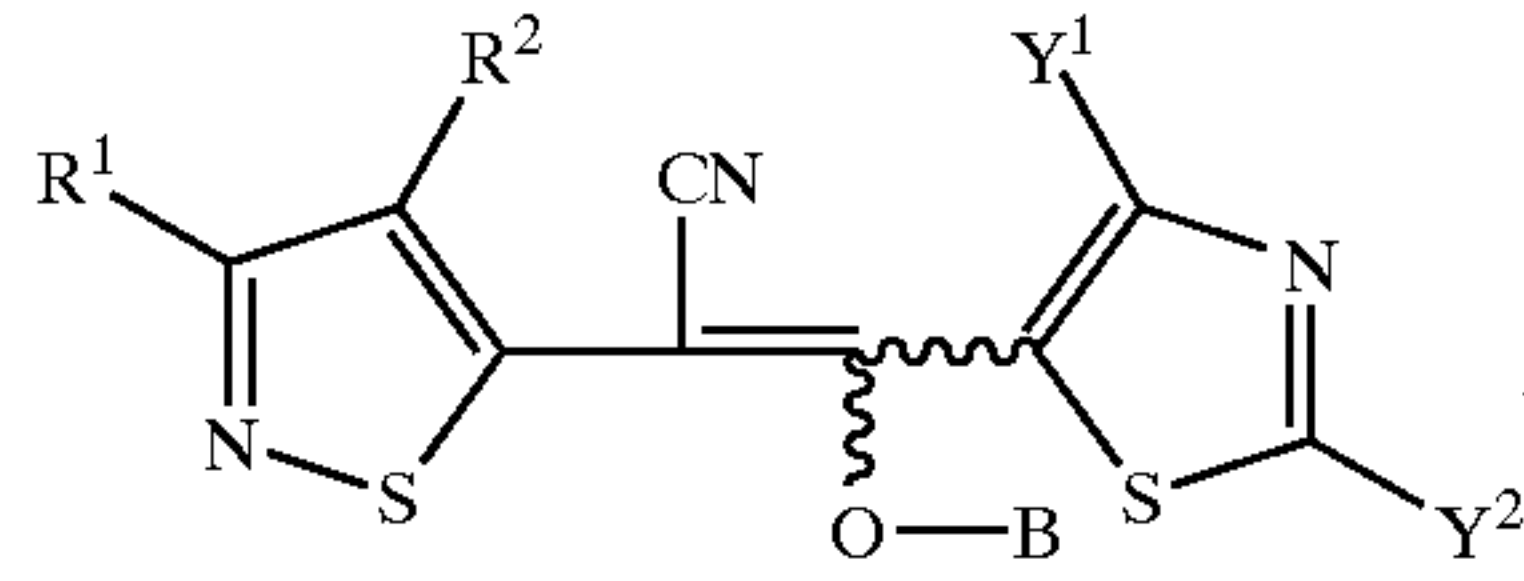
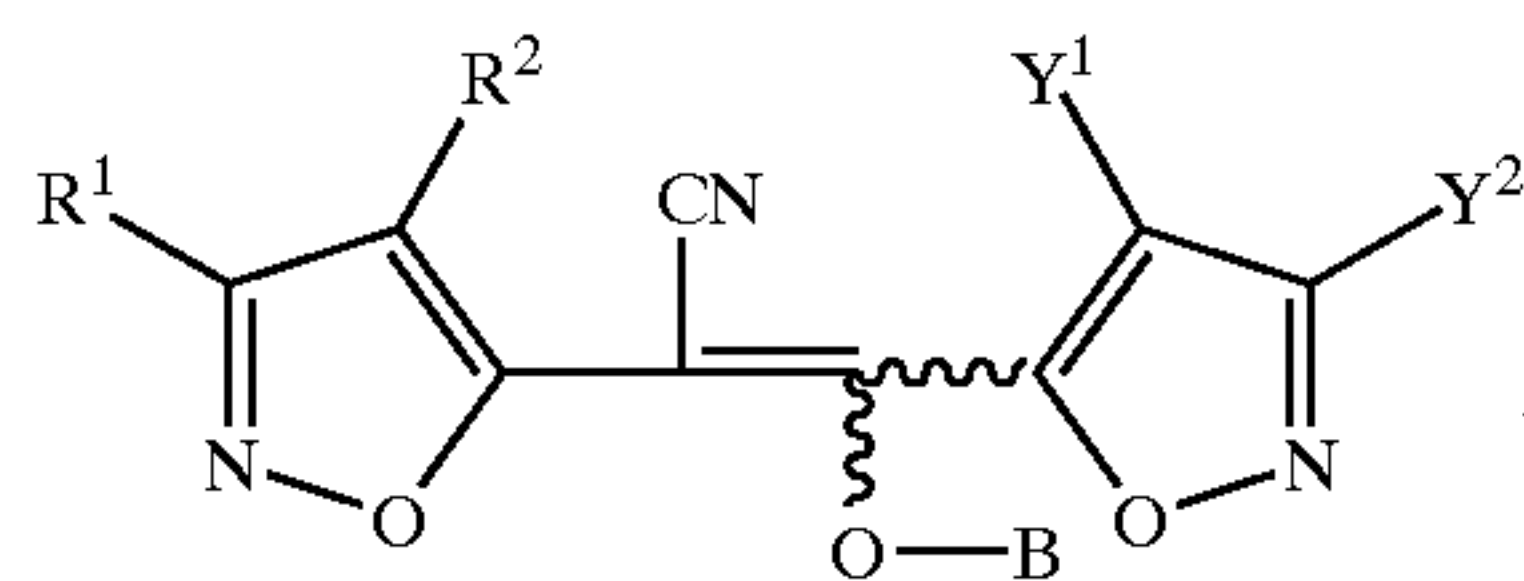

TABLE 5-continued

R ¹	R ²	B	Y ¹	Y ²
2,6-F ₂ -Ph	H	H	Me	H
2,6-F ₂ -Ph	H	H	Me	Me
2,6-F ₂ -Ph	H	H	Et	Me
2,6-F ₂ -Ph	Me	H	Et	Me
2,6-F ₂ -Ph	H	H	Cl	Cl
2,6-F ₂ -Ph	H	H	Cl	Me
2,6-F ₂ -Ph	H	H	Cl	CF ₃
2,6-F ₂ -Ph	H	H	Me	Cl
2,6-F ₂ -Ph	H	H	Br	Me
2,6-F ₂ -Ph	H	H	Me	CF ₃
2,6-F ₂ -Ph	H	H	OMe	Me
2,6-F ₂ -Ph	H	H	OCF ₃	Me
2,6-F ₂ -Ph	H	H	SMe	Me
2,6-F ₂ -Ph	H	H	CO ₂ Me	Me
2,6-F ₂ -Ph	H	H	CO ₂ Et	Me
2,6-F ₂ -Ph	H	H	CF ₃	Me
2,6-F ₂ -Ph	H	H	CF ₃	H
2,6-F ₂ -Ph	H	H	CF ₃	Br
2,6-F ₂ -Ph	H	H	CF ₃	NO ₂
2,6-F ₂ -Ph	H	H	CF ₃	CN
2,6-F ₂ -Ph	H	H	CF ₃	NHMe
2,6-F ₂ -Ph	H	H	CF ₃	NMe ₂
2,6-F ₂ -Ph	H	H	CF ₃	CO ₂ Me
2,6-F ₂ -Ph	H	B3	CF ₃	Me
2,6-F ₂ -Ph	H	B6	CF ₃	Me
2,6-F ₂ -Ph	H	B7	CF ₃	Me
tBu	H	H	Me	Me
tBu	H	H	Et	Me
tBu	H	H	Cl	Cl
tBu	H	H	Cl	Me
tBu	H	H	Me	Cl
tBu	H	H	Cl	CF ₃
tBu	H	H	Br	Me
tBu	H	H	Me	Br
tBu	H	H	Me	CF ₃
tBu	H	H	OMe	Me
tBu	H	H	OCF ₃	Me
tBu	H	H	SMe	Me
tBu	H	H	CO ₂ Me	Me
tBu	H	H	CO ₂ Et	Me
tBu	H	H	CF ₃	Me
tBu	H	H	CF ₃	H
tBu	H	H	CF ₃	Br
tBu	H	H	CF ₃	NO ₂
tBu	H	B2	CF ₃	Me
tBu	H	B3	CF ₃	Me
tBu	H	B4	CF ₃	Me
tBu	H	B5	CF ₃	Me
tBu	H	B6	CF ₃	Me
tBu	H	B7	CF ₃	Me
tBu	H	B8	CF ₃	Me
tBu	H	B9	CF ₃	Me
tBu	H	B10	CF ₃	Me
tBu	H	B11	CF ₃	Me
tBu	H	B14	CF ₃	Me
tBu	H	B20	CF ₃	Me
tBu	H	B23	CF ₃	Me
tBu	H	B24	CF ₃	Me
tBu	H	B25	CF ₃	Me
tBu	H	B26	CF ₃	Me
tBu	H	B28	CF ₃	Me
tBu	H	B30	CF ₃	Me
tBu	H	B31	CF ₃	Me
tBu	H	B32	CF ₃	Me
tBu	H	B33	CF ₃	Me
tBu	H	B34	CF ₃	Me
tBu	H	Na	CF ₃	Me

TABLE 5-continued

5	tBu	H	K	CF ₃	Me
	2-pyridyl	H	H	Me	Me
	2-pyridyl	H	H	Et	Me
	2-pyridyl	H	H	Cl	Cl
	2-pyridyl	H	H	Cl	Me
	2-pyridyl	H	H	Me	Cl
	2-pyridyl	H	H	Br	Me
	2-pyridyl	H	H	Me	CF ₃
10	2-pyridyl	H	H	CO ₂ Me	Me
	2-pyridyl	H	H	CO ₂ Et	Me
	2-pyridyl	H	H	CF ₃	Me
	2-pyridyl	H	H	CF ₃	Br
	2-pyridyl	H	H	CF ₃	NO ₂
	2-pyridyl	H	H	CF ₃	CN
15	2-pyridyl	H	H	CF ₃	NMe ₂
	2-pyridyl	H	B3	CF ₃	Me
	2-pyridyl	H	B6	CF ₃	Me
	2-pyridyl	H	B7	CF ₃	Me
	3-pyridyl	H	H	Et	Me
	3-pyridyl	H	H	CF ₃	Me
20	4-pyridyl	H	H	Et	Me
	4-pyridyl	H	H	CF ₃	Me
	2-F-Ph	H	H	Me	Me
	2-F-Ph	H	H	Et	Me
	2-F-Ph	H	H	CF ₃	Me
	2-F-Ph	H	H	CF ₃	Cl
	2-F-Ph	H	H	CF ₃	H
25	2-F-Ph	H	B3	CF ₃	Me
	2-F-Ph	H	B6	CF ₃	Me
	2-F-Ph	H	B7	CF ₃	Me
	3-F-Ph	H	H	Et	Me
	3-F-Ph	H	H	CF ₃	Me
	4-F-Ph	H	H	Et	Me
30	2,3-F ₂ -Ph	H	H	Et	Me
	2,4-F ₂ -Ph	H	H	Et	Me
	2,5-F ₂ -Ph	H	H	Et	Me
	Ph	H	H	Me	Me
	Ph	H	H	Et	Me
	Ph	H	H	CF ₃	Me
35	Ph	H	H	CF ₃	Cl
	Ph	H	H	CF ₃	H
	Ph	H	B3	CF ₃	Me
	Ph	H	B6	CF ₃	Me
	Ph	H	B7	CF ₃	Me
	3,4-F ₂ -Ph	H	H	Et	Me
40	3,5-F ₂ -Ph	H	H	Et	Me
	2-Cl-Ph	H	R	Me	Me
	2-Cl-Ph	H	H	Et	Me
	2-Cl-Ph	H	H	CF ₃	Me
	2-Cl-Ph	H	H	CF ₃	Cl
	2-Cl-Ph	H	H	CF ₃	H
45	2-Cl-Ph	H	B3	CF ₃	Me
	2-Cl-Ph	H	B6	CF ₃	Me
	2-Cl-Ph	H	B7	CF ₃	Me
	3-Cl-Ph	H	H	CF ₃	Me
	4-Cl-Ph	H	H	CF ₃	Me
	2,3-Cl ₂ -Ph	H	H	CF ₃	Me
	2,4-Cl ₂ -Ph	H	H	CF ₃	Me
50	2,5-Cl ₂ -Ph	H	H	CF ₃	Me
	2,6-Cl ₂ -Ph	H	H	Me	Me
	2,6-Cl ₂ -Ph	H	H	Et	Me
	2,6-Cl ₂ -Ph	H	H	CF ₃	Me
	2,6-Cl ₂ -Ph	H	H	CF ₃	Cl
	2,6-Cl ₂ -Ph	H	H	CF ₃	H
55	2,6-Cl ₂ -Ph	H	B3	CF ₃	Me
	2,6-Cl ₂ -Ph	H	B6	CF ₃	Me
	2,6-Cl ₂ -Ph	H	B7	CF ₃	Me
	3,4-Cl ₂ -Ph	H	H	CF ₃	Me
	3,5-Cl ₂ -Ph	H	H	CF ₃	Me
	2-Me-Ph	H	H	Et	Me
60	2-Me-Ph	H	H	CF ₃	Me
	2,6-Me ₂ -Ph	H	H	Et	Me
	2,6-Me ₂ -Ph	H	H	CF ₃	Me
	2-MeO-Ph	H	H	Et	Me
	2-MeO-Ph	H	H	CF ₃	Me
	2-CF ₃ O-Ph	H	H	Et	Me
65	2-CF ₃ O-Ph	H	H	CF ₃	Me
	2-SMe-Ph	H	H	Et	Me
	2-SMe-Ph	H	H	CF ₃	Me

TABLE 5-continued

2-SOMe—Ph	H	H	Et	Me
2-SOMe—Ph	H	H	CF ₃	Me
2-SO ₂ Me—Ph	H	H	Et	Me
2-SO ₂ Me—Ph	H	H	CF ₃	Me
2-CF ₃ —Ph	H	H	Et	Me
2-CF ₃ —Ph	H	H	CF ₃	Me
2-NO ₂ —Ph	H	H	Et	Me
2-NO ₂ —Ph	H	H	CF ₃	Me
2-CN—Ph	H	H	Et	Me
2-NHMe ₂ —Ph	H	H	CF ₃	Me
2-NMe ₂ —Ph	H	H	Et	Me
2-NMe ₂ —Ph	H	H	CF ₃	Me
4-benzyl—Ph	H	H	CF ₃	Me
4-phenoxy—Ph	H	H	CF ₃	Me
2-OH—Ph	H	H	CF ₃	Me
2-CO ₂ Me—Ph	H	H	Et	Me
2-CO ₂ Me—Ph	H	H	CF ₃	Me
2-CO ₂ Et—Ph	H	H	Et	Me
2-CO ₂ Et—Ph	H	H	CF ₃	Me
H	H	H	CF ₃	Me
Me	H	H	CF ₃	Me
Et	H	H	CF ₃	Me
nPr	H	H	CF ₃	Me
iPr	H	H	Et	Me
iPr	H	H	CF ₃	Me
nBu	H	H	Et	Me
nBu	H	H	CF ₃	Me
iBu	H	H	Et	Me
iBu	H	H	CF ₃	Me
iBu	H	B7	Et	Me
iBu	H	B7	CF ₃	Me
secBu	H	H	Et	Me
secBu	H	H	CF ₃	Me
2,2-Me ₂ -propyl	H	H	CF ₃	Me
nHex	H	H	CF ₃	Me
ethenyl	H	H	CF ₃	Me
1-propenyl	H	H	Et	Me
1-propenyl	H	H	CF ₃	Me
ethynyl	H	H	CF ₃	Me
1-propynyl	H	H	CF ₃	Me
CF ₃	H	H	Et	Me
CF ₃	H	H	CF ₃	Me
CHF ₂	H	H	Et	Me
C ₂ F ₅	H	H	Et	Me
2,2-Cl ₂ -cPr	H	H	Et	Me
2,2-Cl ₂ -cPr	H	H	CF ₃	Me
cPr	H	H	Et	Me
cPr	H	H	CF ₃	Me
1-Me-cPr	H	H	Et	Me
1-Me-cPr	H	H	CF ₃	Me
cHex	H	H	Et	Me
cHex	H	H	CF ₃	Me
CH ₂ Ph	H	H	CF ₃	Me
1-naphthyl	H	H	Et	Me
1-naphthyl	H	H	CF ₃	Me
2-naphthyl	H	H	CF ₃	Me
CO ₂ Me	H	H	CF ₃	Me
CO ₂ Et	H	H	CF ₃	Me
2-thienyl	H	H	CF ₃	Me

TABLE 6

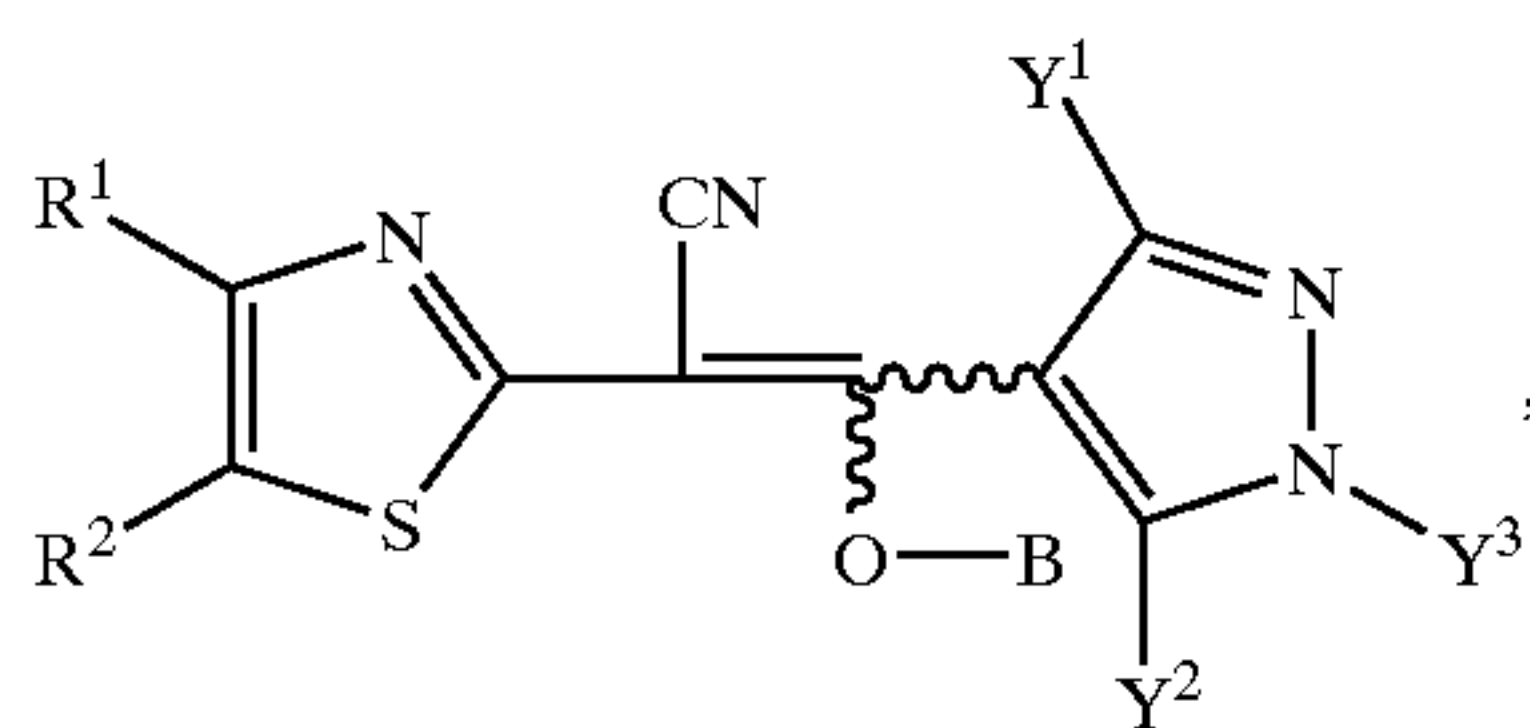

TABLE 6-continued

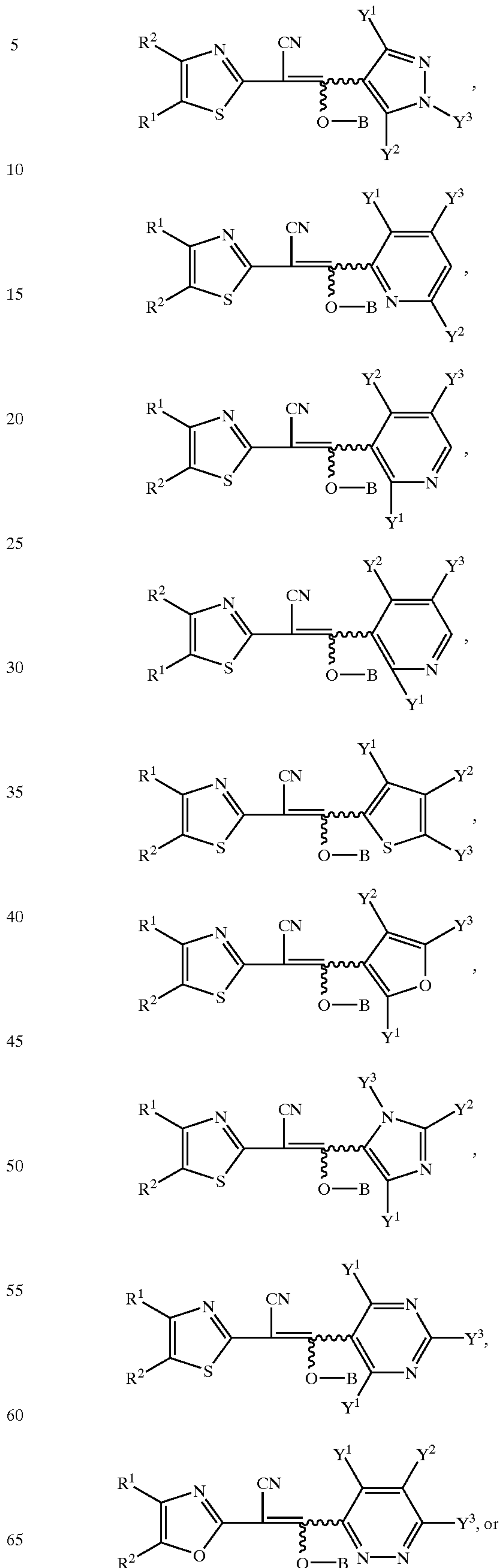

TABLE 6-continued

tBu	H	B14	Cl	Cl	Me
tBu	H	B15	Cl	Cl	Me
tBu	H	B16	Cl	Cl	Me
tBu	H	B17	Cl	Cl	Me
tBu	H	B18	Cl	Cl	Me
tBu	H	B19	Cl	Cl	Me
tBu	H	B20	Cl	Cl	Me
tBu	H	B21	Cl	Cl	Me
tBu	H	B22	Cl	Cl	Me
tBu	H	B23	Cl	Cl	Me
tBu	H	B24	Cl	Cl	Me
tBu	H	B25	Cl	Cl	Me
tBu	H	B26	Cl	Cl	Me
tBu	H	B27	Cl	Cl	Me
tBu	H	B28	Cl	Cl	Me
tBu	H	B29	Cl	Cl	Me
tBu	H	B30	Cl	Cl	Me
tBu	H	B31	Cl	Cl	Me
tBu	H	B32	Cl	Cl	Me
tBu	H	B33	Cl	Cl	Me
tBu	H	B34	Cl	Cl	Me
tBu	H	B45	Cl	Cl	Me
tBu	H	B46	Cl	Cl	Me
tBu	H	B2	CF ₃	Cl	Me
tBu	H	B3	CF ₃	Cl	Me
tBu	H	B4	CF ₃	Cl	Me
tBu	H	B5	CF ₃	Cl	Me
tBu	H	B6	CF ₃	Cl	Me
tBu	H	B7	CF ₃	Cl	Me
tBu	H	B8	CF ₃	Cl	Me
tBu	H	B9	CF ₃	Cl	Me
tBu	H	B10	CF ₃	Cl	Me
tBu	H	B11	CF ₃	Cl	Me
tBu	H	B12	CF ₃	Cl	Me
tBu	H	B13	CF ₃	Cl	Me
tBu	H	B14	CF ₃	Cl	Me
tBu	H	B15	CF ₃	Cl	Me
tBu	H	B16	CF ₃	Cl	Me
tBu	H	B17	CF ₃	Cl	Me
tBu	H	B18	CF ₃	Cl	Me
tBu	H	B19	CF ₃	Cl	Me
tBu	H	B20	CF ₃	Cl	Me
tBu	H	B21	CF ₃	Cl	Me
tBu	H	B22	CF ₃	Cl	Me
tBu	H	B23	CF ₃	Cl	Me
tBu	H	B24	CF ₃	Cl	Me
tBu	H	B25	CF ₃	Cl	Me
tBu	H	B26	CF ₃	Cl	Me
tBu	H	B27	CF ₃	Cl	Me
tBu	H	B28	CF ₃	Cl	Me
tBu	H	B29	CF ₃	Cl	Me
tBu	H	B30	CF ₃	Cl	Me
tBu	H	B31	CF ₃	Cl	Me
tBu	H	B32	CF ₃	Cl	Me
tBu	H	B33	CF ₃	Cl	Me
tBu	H	B34	CF ₃	Cl	Me
tBu	H	B35	CF ₃	Cl	Me
tBu	H	B43	CF ₃	Cl	Me
tBu	H	B7	Cl	H	H
tBu	H	B9	Cl	H	H
tBu	H	B10	Cl	H	H
tBu	H	B11	Cl	H	H
2-pyridyl	H	B7	H	CF ₃	Me
2-pyridyl	H	B7	Me	H	Me
2-pyridyl	H	B7	Me	H	CF ₃
2-pyridyl	H	B7	Me	Me	H
2-pyridyl	H	B7	Me	Cl	Me
2-pyridyl	H	B7	Cl	H	Me
2-pyridyl	H	B7	Cl	H	CF ₃
2-pyridyl	H	B7	OMe	H	H
2-pyridyl	H	B7	OCF ₃	H	H
2-pyridyl	H	B7	SMe	H	H
2-pyridyl	H	B7	NO ₂	H	H
2-pyridyl	H	B7	CO ₂ Me	H	H
2-pyridyl	H	B7	CO ₂ Et	H	H
2-pyridyl	H	B7	CF ₃	Me	Me
2-pyridyl	H	B7	CF ₃	H	Me
2-pyridyl	H	B7	CF ₃	Br	Me

TABLE 6-continued

2-pyridyl	H	B3	Cl	Cl	Me
2-pyridyl	H	B7	Cl	Cl	Me
5 2-pyridyl	H	B3	CF ₃	Cl	Me
2-pyridyl	H	B7	CF ₃	Cl	Me
2-pyridyl	H	B3	Cl	H	H
2-pyridyl	H	B4	Cl	H	H
2-pyridyl	H	B5	Cl	H	H
2-pyridyl	H	B6	Cl	H	H
10 2-pyridyl	H	B7	Cl	H	H
2-pyridyl	H	B8	Cl	H	H
2-pyridyl	H	B9	Cl	H	H
2-pyridyl	H	B10	Cl	H	H
2-pyridyl	H	B11	Cl	H	H
2-pyridyl	H	B20	Cl	H	H
15 2-pyridyl	H	B24	Cl	H	H
2-pyridyl	H	B25	Cl	H	H
2-pyridyl	H	B26	Cl	H	H
2-pyridyl	H	B28	Cl	H	H
2-pyridyl	H	B30	Cl	H	H
2-pyridyl	H	B31	Cl	H	H
2-pyridyl	H	B32	Cl	H	H
20 2-pyridyl	H	B33	Cl	H	H
2-pyridyl	H	B43	Cl	H	H
2-pyridyl	H	B46	Cl	H	H
3-pyridyl	H	B7	Cl	Cl	Me
3-pyridyl	H	B7	Cl	H	H
25 4-pyridyl	H	B7	Cl	H	H
2-F—Ph	H	B7	Me	Me	Me
2-F—Ph	H	B7	Me	Cl	Me
2-F—Ph	H	B7	Cl	Me	Me
2-F—Ph	H	B7	Cl	H	H
2-F—Ph	H	B7	OMe	H	H
30 2-F—Ph	H	B7	SMe	H	H
2-F—Ph	H	B7	CF ₃	H	Me
2-F—Ph	H	B1	Cl	Cl	Me
2-F—Ph	H	B3	Cl	Cl	Me
2-F—Ph	H	B6	Cl	Cl	Me
2-F—Ph	H	B7	Cl	Cl	Me
2-F—Ph	H	B3	CF ₃	Cl	Me
2-F—Ph	H	B6	CF ₃	Cl	Me
2-F—Ph	H	B7	CF ₃	Cl	Me
2-F—Ph	H	B7	Cl	H	H
3-F—Ph	H	B7	Cl	Cl	Me
4-F—Ph	H	B7	Cl	Cl	Me
40 2,3-F ₂ —Ph	H	B7	CF ₃	Cl	Me
2,4-F ₂ —Ph	H	B7	Cl	Cl	Me
2,5-F ₂ —Ph	H	B7	Cl	Cl	Me
Ph	H	B7	Me	Me	Me
Ph	H	B7	Me	Cl	Me
Ph	H	B7	Cl	Me	Me
45 Ph	H	B7	Cl	H	H
Ph	H	B7	OMe	H	H
Ph	H	B7	SMe	H	H
Ph	H	B7	CF ₃	H	Me
Ph	H	B1	Cl	Cl	Me
Ph	H	B3	Cl	Cl	Me
Ph	H	B6	Cl	Cl	Me
50 Ph	H	B7	Cl	Cl	Me
Ph	H	B3	CF ₃	Cl	Me
Ph	H	B6	CF ₃	Cl	Me
Ph	H	B7	CF ₃	Cl	Me
Ph	Me	B7	CF ₃	Cl	Me
Ph	H	B7	Cl	H	H
55 3,4-F ₂ —Ph	H	B7	Cl	Cl	Me
3,5-F ₂ —Ph	H	B7	Cl	Cl	Me
2-Cl—Ph	H	B7	Me	Me	Me
2-Cl—Ph	H	B7	Me	Cl	Me
2-Cl—Ph	H	B7	Cl	Me	Me
2-Cl—Ph	H	B7	Cl	H	H
2-Cl—Ph	H	B7	OMe	H	H
2-Cl—Ph	H	B7	SMe	H	H
2-Cl—Ph	H	B7	CF ₃	H	Me
2-Cl—Ph	H	B6	Cl	Cl	Me
2-Cl—Ph	H	B7	Cl	Cl	Me
2-Cl—Ph	H	B3	CF ₃	Cl	Me
65 2-Cl—Ph	H	B6	CF ₃	Cl	Me
2-Cl—Ph	H	B7	CF ₃	Cl	Me
2-Cl—Ph	H	B7	Cl	H	H

TABLE 6-continued

3-Cl—Ph	H	B7	Cl	Cl	Me
4-Cl—Ph	H	B7	Cl	Cl	Me
2,3-Cl ₂ —Ph	H	B7	Cl	Cl	Me
2,4-Cl ₂ —Ph	H	B7	Cl	Cl	Me
2,5-Cl ₂ —Ph	H	B7	Cl	Cl	Me
2,6-Cl ₂ —Ph	H	B7	Me	Me	Me
2,6-Cl ₂ —Ph	H	B7	Me	Cl	Me
2,6-Cl ₂ —Ph	H	B7	Cl	Me	Me
2,6-Cl ₂ —Ph	H	B7	Cl	H	H
2,6-Cl ₂ —Ph	H	B7	OMe	H	H
2,6-Cl ₂ —Ph	H	B7	SMe	H	H
2,6-Cl ₂ —Ph	H	B7	CF ₃	H	Me
2,6-Cl ₂ —Ph	H	B1	Cl	Cl	Me
2,6-Cl ₂ —Ph	H	B3	Cl	Cl	Me
2,6-Cl ₂ —Ph	H	B6	Cl	Cl	Me
2,6-Cl ₂ —Ph	H	B7	Cl	Cl	Me
2,6-Cl ₂ —Ph	Me	B7	Cl	Cl	Me
2,6-Cl ₂ —Ph	H	B3	CF ₃	Cl	Me
2,6-Cl ₂ —Ph	H	B6	CF ₃	Cl	Me
2,6-Cl ₂ —Ph	H	B7	CF ₃	Cl	Me
2,6-Cl ₂ —Ph	Me	B7	CF ₃	Cl	Me
3,4-Cl ₂ —Ph	H	B7	Cl	Cl	Me
3,5-Cl ₂ —Ph	H	B7	Cl	Cl	Me
2-Me—Ph	H	B7	Cl	Cl	Me
2-Me—Ph	H	B7	CF ₃	Cl	Me
2,6-Me ₂ —Ph	H	B7	Cl	Cl	Me
2,6-Me ₂ —Ph	H	B7	CF ₃	Cl	Me
2-MeO—Ph	H	B7	Cl	Cl	Me
2-MeO—Ph	H	B7	CF ₃	Cl	Me
2-CF ₃ O—Ph	H	B7	Cl	Cl	Me
2-CF ₃ O—Ph	H	B7	CF ₃	Cl	Me
2-SMe—Ph	H	B7	Cl	Cl	Me
2-SOMe—Ph	H	B7	Cl	Cl	Me
2-SO ₂ Me—Ph	H	B7	Cl	Cl	Me
2-CF ₃ —Ph	H	B7	Cl	Cl	Me
2-NO ₂ —Ph	H	B7	Cl	Cl	Me
2-NO ₂ —Ph	H	B9	Cl	Cl	Me
2-CN—Ph	H	B7	Cl	Cl	Me
2-NHMe—Ph	H	B7	Cl	Cl	Me
2-NMe ₂ —Ph	H	B7	Cl	Cl	Me
4-benzyl—Ph	H	B7	Cl	Cl	Me
4-phenoxy—Ph	H	B7	Cl	Cl	Me
4-tBu—Ph	H	B1	Cl	H	Me
2-OH—Ph	H	B7	Cl	Cl	Me
2-CO ₂ Me—Ph	H	B7	Cl	Cl	Me
2-CO ₂ Et—Ph	H	B7	Cl	Cl	Me
H	H	B7	Cl	Cl	Me
Me	H	B7	Cl	Cl	Me
Et	H	B7	Cl	Cl	Me
nPr	H	B7	Cl	Cl	Me
iPr	H	B7	Cl	Cl	Me
iPr	H	B7	CF ₃	Cl	Me
nBu	H	B7	Cl	Cl	Me
nBu	H	B7	CF ₃	Cl	Me
iBu	H	B7	Cl	Cl	Me
iBu	H	B7	CF ₃	Cl	Me
iBu	Me	B7	Cl	Cl	Me
iBu	Me	B7	CF ₃	Cl	Me
iBu	H	B7	Cl	H	H
secBu	H	B7	Cl	Cl	Me
secBu	H	B7	CF ₃	Cl	Me
pentyl-2	H	B1	Cl	Cl	Me
2,2-Me ₂ -propyl	H	B7	Cl	Cl	Me
nHex	H	B7	Cl	Cl	Me
ethenyl	H	B7	Cl	Cl	Me
1-propenyl	H	B7	Cl	Cl	Me
1-propenyl	H	B7	CF ₃	Cl	Me
ethynyl	H	B7	Cl	Cl	Me
1-propynyl	H	B7	Cl	Cl	Me
CF ₃	H	B7	Cl	Cl	Me
CHF ₂	H	B7	Cl	Cl	Me
C ₂ F ₅	H	B7	Cl	Cl	Me
2,2-Cl ₂ -cPr	H	B7	Cl	Cl	Me
2,2-Cl ₂ -cPr	H	B7	CF ₃	Cl	Me
cPr	H	B7	Cl	Cl	Me
cPr	H	B7	CF ₃	Cl	Me
1-Me-cPr	H	B7	Cl	Cl	Me
1-Me-cPr	H	B7	CF ₃	Cl	Me
cHex	H	B7	Cl	Cl	Me

TABLE 6-continued

cHex	H	B7	CF ₃	Cl	Me
5 CH ₂ Ph	H	B7	Cl	Cl	Me
naphthyl-1	H	B7	Cl	Cl	Me
naphthyl-1	H	B7	CF ₃	Cl	Me
naphthyl-2	H	B9	Cl	H	H
10 naphthyl-2	H	B7	Cl	Cl	Me
CO ₂ Me	H	B7	Cl	Cl	Me
CO ₂ Et	H	B7	Cl	Cl	Me
2-thienyl	H	B7	Cl	Cl	Me
2-thienyl	H	B7	CF ₃	Cl	Me
15 CH ₂ OMe	H	B7	Cl	Cl	Me
CH ₂ OEt	H	B7	Cl	Cl	Me
COCH ₃	H	B7	Cl	Cl	Me
COtBu	H	B7	Cl	Cl	Me
20 CPh	H	B7	Cl	Cl	Me

TABLE 7



25	
30	
35	
40	
45	
50	
55	
60	
65	

TABLE 7-continued

TABLE 7-continued

R ¹	R ²	B	Y ¹	Y ²
Ph	H	B7	Me	H
Ph	H	B7	Me	Me
Ph	H	B7	Et	Me
Ph	Me	B7	Et	Me
Ph	H	B7	Me	Cl
Ph	H	B7	Cl	Me
Ph	H	B7	Br	Me
Ph	H	B7	Me	Br
Ph	H	B7	Me	CF ₃
Ph	H	B7	CF ₃	H
Ph	H	B7	CF ₃	Br
Ph	H	B7	CF ₃	NO ₂
Ph	H	B7	CF ₃	CN
Ph	H	B4	CF ₃	Me
Ph	H	B7	CF ₃	Me
Ph	H	B9	CF ₃	Me
tBu	H	B7	Me	Me
tBu	H	B7	Et	Me
tBu	H	B7	Cl	Cl
tBu	H	B7	Cl	Me
tBu	H	B7	Me	Cl
tBu	H	B7	Cl	CF ₃
tBu	H	B7	Br	Me
tBu	H	B7	Me	Br
tBu	H	B7	Me	CF ₃
tBu	H	B7	CF ₃	Me
tBu	H	B7	CF ₃	H
tBu	H	B7	CF ₃	Br
tBu	H	B7	CF ₃	NO ₂

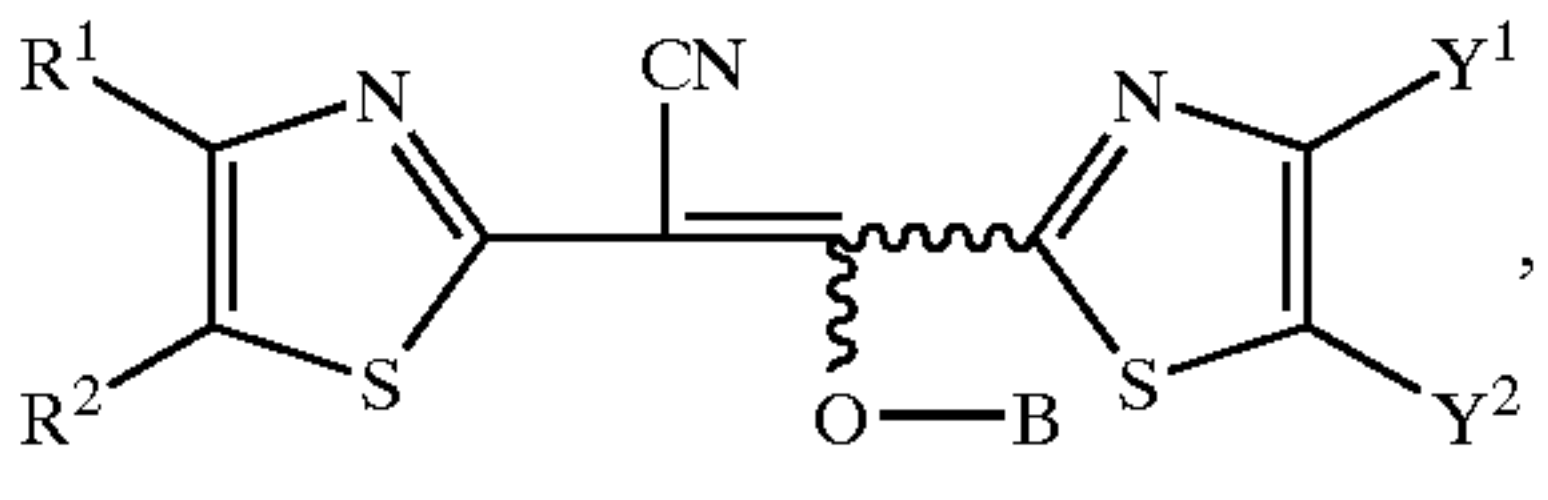
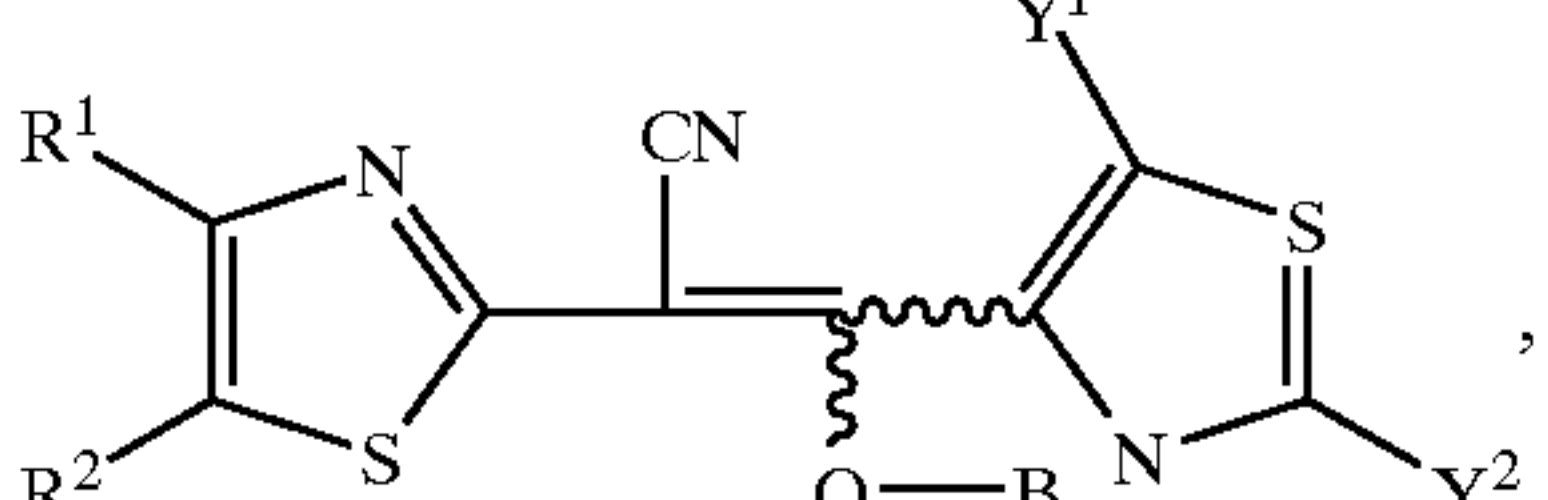
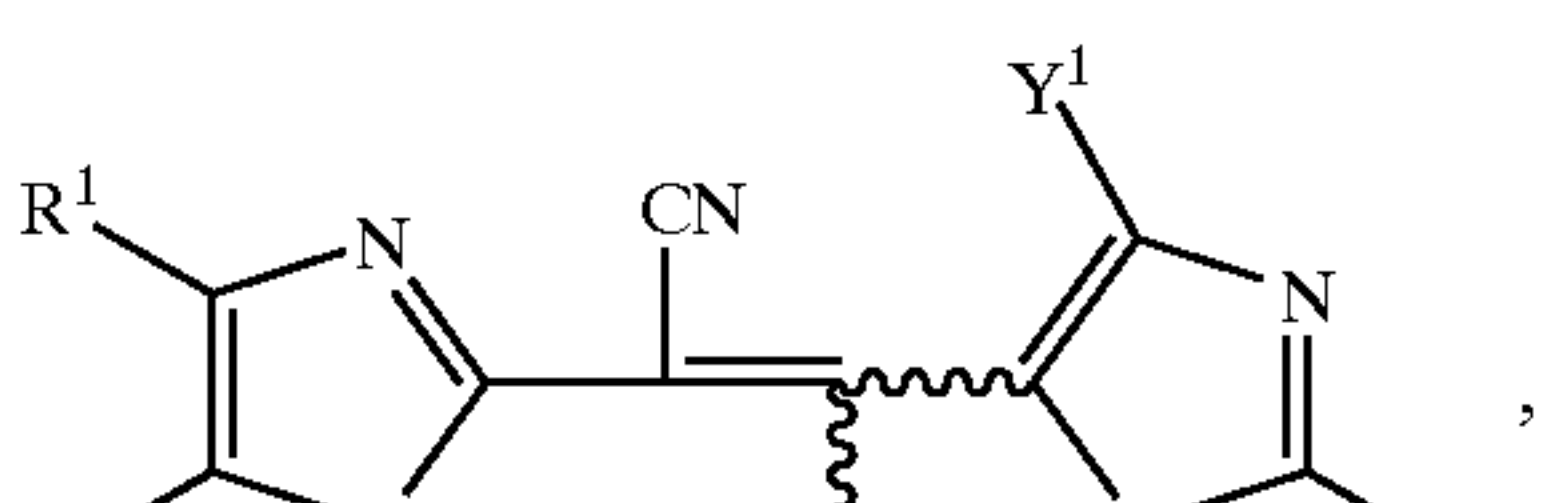
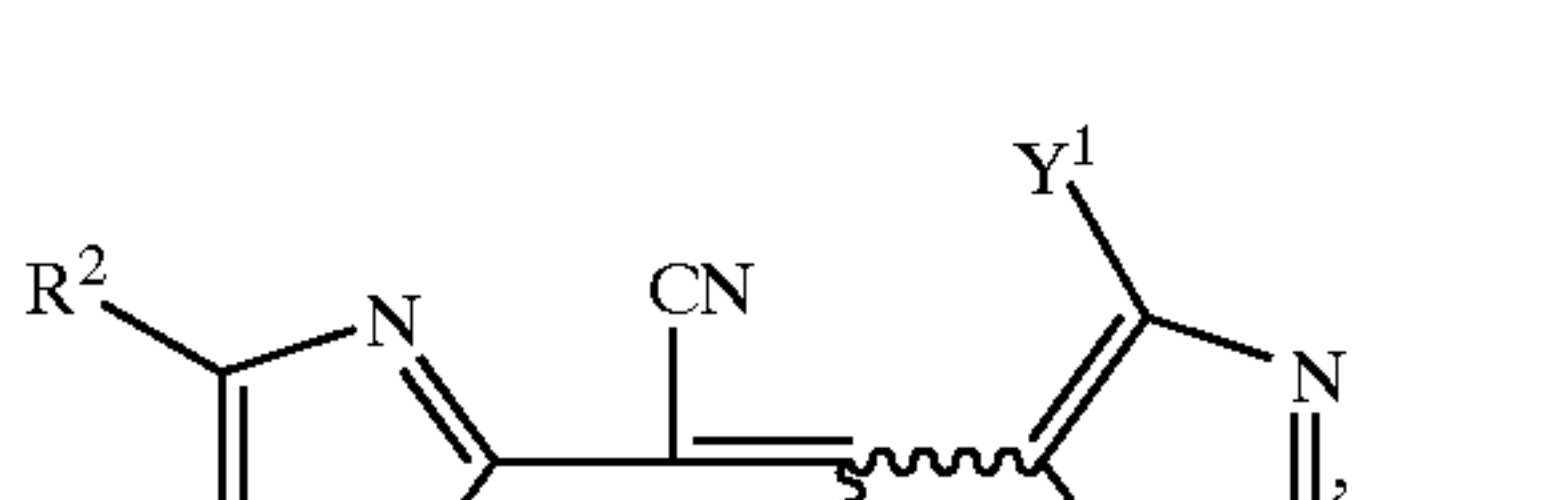
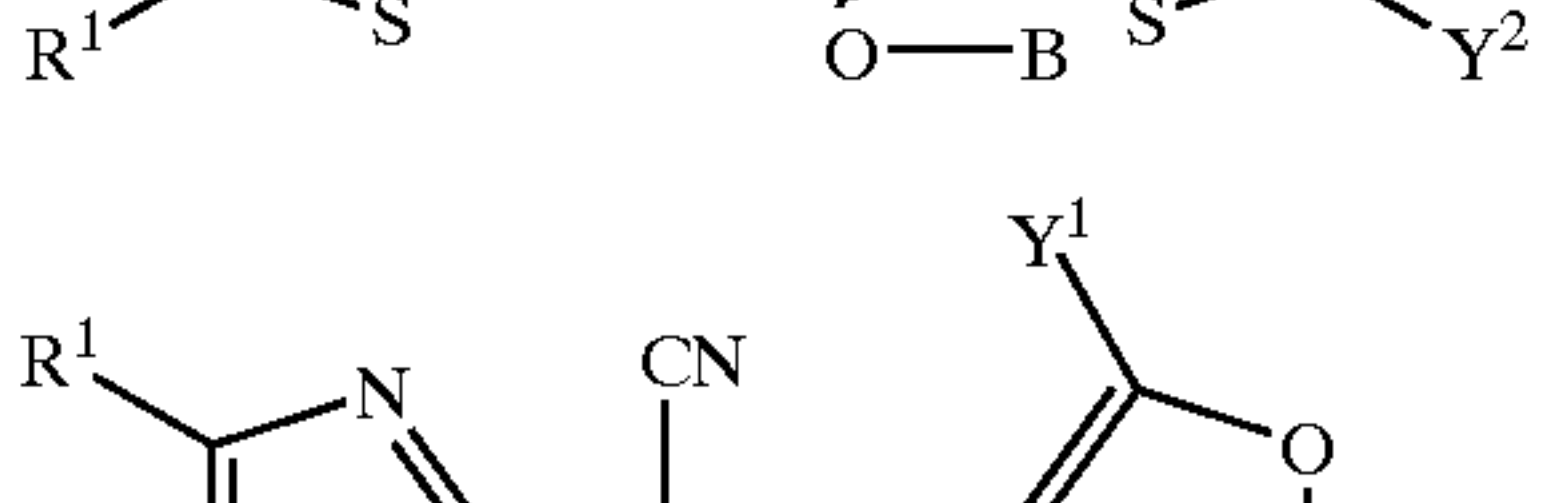
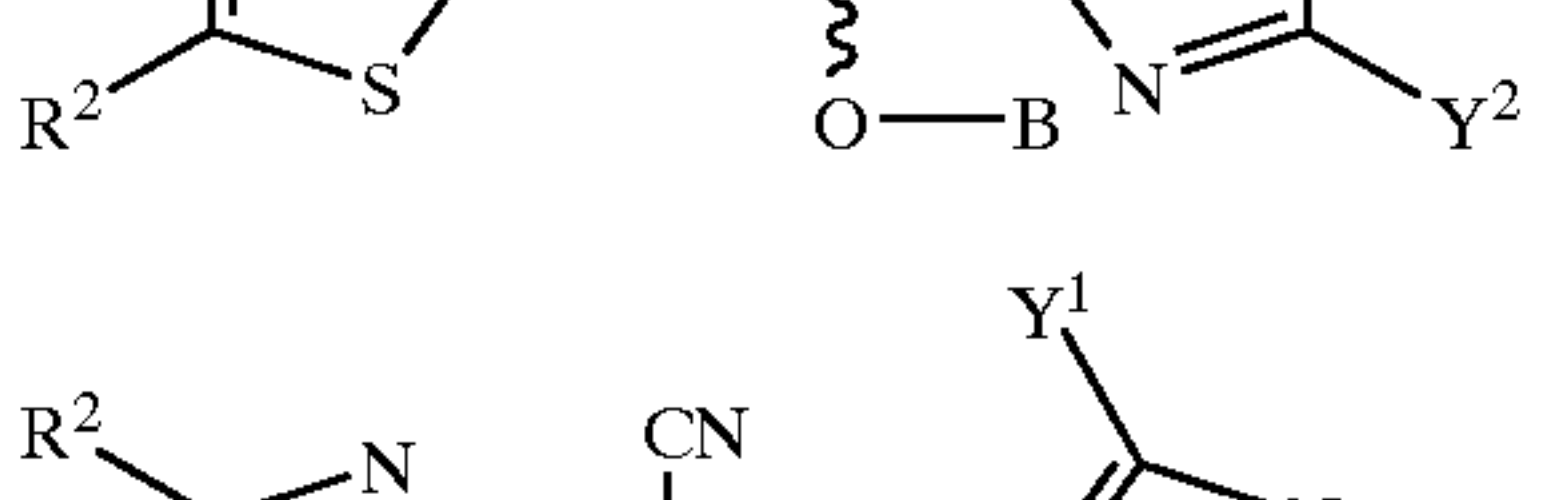
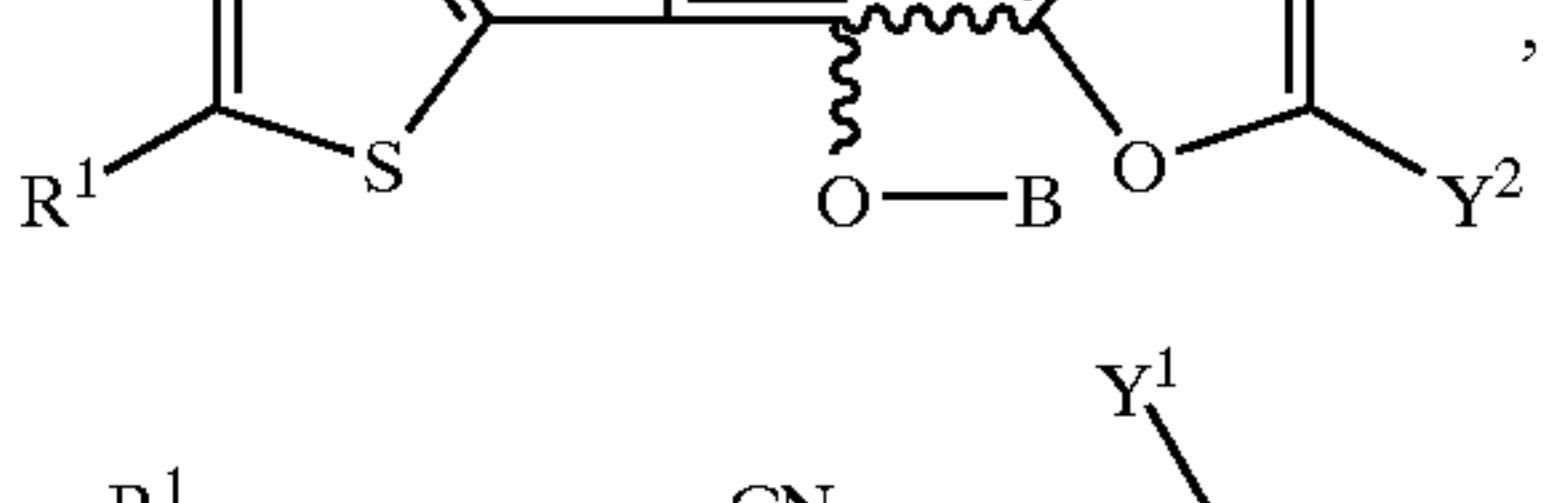
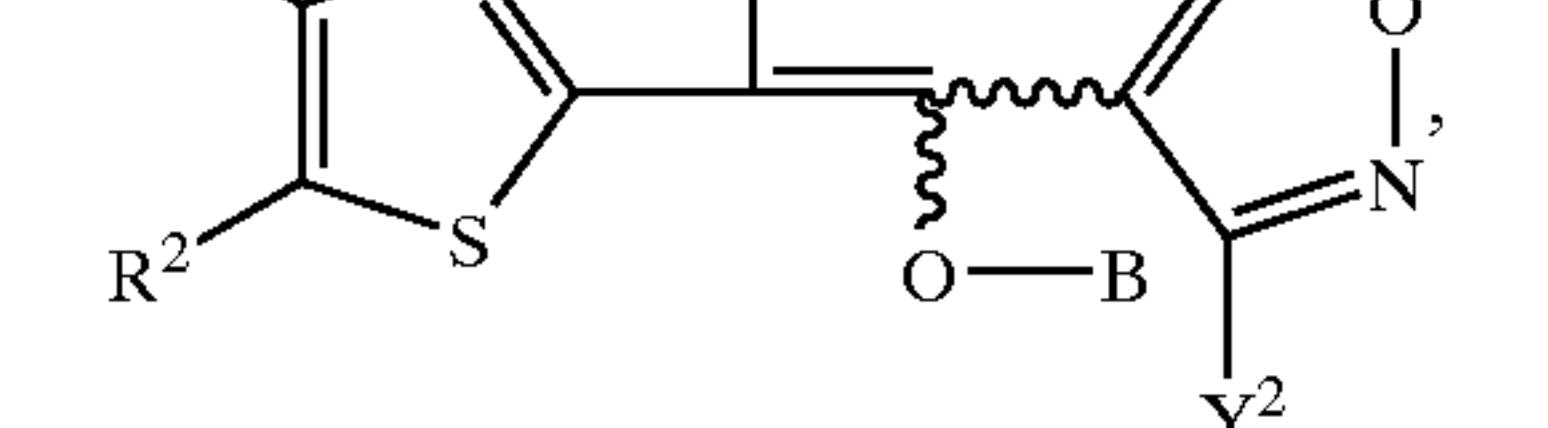
5	tBu	H	B7	CF ₃	CN
	tBu	H	B4	CF ₃	Me
	tBu	H	B5	CF ₃	Me
	tBu	H	B6	CF ₃	Me
	tBu	H	B7	CF ₃	Me
	tBu	H	B9	CF ₃	Me
	tBu	H	B20	CF ₃	Me
	tBu	H	B24	CF ₃	Me
10	tBu	H	B25	CF ₃	Me
	tBu	H	B26	CF ₃	Me
	2-pyridyl	H	B7	Me	Me
	2-pyridyl	H	B7	Et	Me
	2-pyridyl	H	B7	Cl	Cl
	2-pyridyl	H	B7	Cl	Me
15	2-pyridyl	H	B7	Cl	CF ₃
	2-pyridyl	H	B7	Me	Cl
	2-pyridyl	H	B7	Br	Me
	2-thienyl	H	B7	Me	CF ₃
	2-pyridyl	H	B7	CF ₃	H
	2-pyridyl	H	B7	CF ₃	Br
20	2-pyridyl	H	B7	CF ₃	Me
	3-pyridyl	H	B7	Et	Me
	4-pyridyl	H	B7	CF ₃	Me
	2-F—Ph	H	B7	Me	Me
	2-F—Ph	H	B7	Et	Me
	2-F—Ph	H	B7	CF ₃	Cl
25	2-F—Ph	H	B7	CF ₃	H
	2-F—Ph	H	B4	CF ₃	Me
	2-F—Ph	H	B7	CF ₃	Me
	2-F—Ph	H	B9	CF ₃	Me
	3-F—Ph	H	B7	Et	Me
	4-F—Ph	H	B7	Et	Me
	2,3-F ₂ —Ph	H	B7	Et	Me
30	2,4-F ₂ —Ph	H	B7	Et	Me
	2,5-F ₂ —Ph	H	B7	Et	Me
	2,6-F ₂ —Ph	H	B7	Me	Me
	2,6-F ₂ —Ph	H	B7	Et	Me
	2,6-F ₂ —Ph	H	B7	CF ₃	Cl
	2,6-F ₂ —Ph	H	B7	CF ₃	H
35	2,6-F ₂ —Ph	H	B4	CF ₃	Me
	2,6-F ₂ —Ph	H	B7	CF ₃	Me
	2,6-F ₂ —Ph	H	B9	CF ₃	Me
	3,4-F ₂ —Ph	H	B7	Et	Me
	3,5-F ₂ —Ph	H	B7	Et	Me
	2-Cl—Ph	H	B7	Me	Me
40	2-Cl—Ph	H	B7	Et	Me
	2-Cl—Ph	H	B7	CF ₃	Cl
	2-Cl—Ph	H	B7	CF ₃	H
	2-Cl—Ph	H	B4	CF ₃	Me
	2-Cl—Ph	H	B7	CF ₃	Me
	2-Cl—Ph	H	B9	CF ₃	Me
45	3-Cl—Ph	H	B7	CF ₃	Me
	4-Cl—Ph	H	B7	CF ₃	Me
	2,3-Cl ₂ —Ph	H	B7	CF ₃	Me
	2,4-Cl ₂ —Ph	H	B7	CF ₃	Me
	2,5-Cl ₂ —Ph	H	B7	CF ₃	Me
	2,6-Cl ₂ —Ph	H	B7	Me	Me
	2,6-Cl ₂ —Ph	H	B7	Et	Me
50	2,6-Cl ₂ —Ph	H	B7	CF ₃	Cl
	2,6-Cl ₂ —Ph	H	B7	CF ₃	H
	2,6-Cl ₂ —Ph	H	B7	CF ₃	Me
	2,6-Cl ₂ —Ph	H	B4	CF ₃	Me
	2,6-Cl ₂ —Ph	H	B7	CF ₃	Me
	2,6-Cl ₂ —Ph	H	B9	CF ₃	Me
55	3,4-Cl ₂ —Ph	H	B7	CF ₃	Me
	3,5-Cl ₂ —Ph	H	B7	CF ₃	Me
	2-Me—Ph	H	B7	Et	Me
	2-Me—Ph	H	B7	CF ₃	Me
	2,6-Me ₂ —Ph	H	B7	Et	Me
	2,6-Me ₂ —Ph	H	B7	CF ₃	Me
	2-MeO—Ph	H	B7	Et	Me
	2-MeO—Ph	H	B7	CF ₃	Me
60	2-CF ₃ O—Ph	H	B7	CF ₃	Me
	2-SMe—Ph	H	B7	CF ₃	Me
	2-SOMe—Ph	H	B7	CF ₃	Me
	2-SO ₂ Me—Ph	H	B7	CF ₃	Me
	2-CF ₃ —Ph	H	B7	CF ₃	Me
	2-NO ₂ —Ph	H	B7	CF ₃	Me
65	2-CN—Ph	H	B7	CF ₃	Me
	2-NMe ₂ —Ph	H	B7	CF ₃	Me

TABLE 7-continued

4-benzyl-Ph	H	B7	CF ₃	Me
4-phenoxy-Ph	H	B7	CF ₃	Me
2-OH—Ph	H	B7	CF ₃	Me
2-CO ₂ Me—Ph	H	B7	Et	Me
2-CO ₂ Me—Ph	H	B7	CF ₃	Me
2-CO ₂ Et—Ph	H	B7	Et	Me
2-CO ₂ Et—Ph	H	B7	CF ₃	Me
H	H	B7	CF ₃	Me
Me	H	B7	CF ₃	Me
Et	H	B7	CF ₃	Me
nPr	H	B7	CF ₃	Me
iPr	H	B7	Et	Me
iPr	H	B7	CF ₃	Me
nBu	H	B7	Et	Me
nBu	H	B7	CF ₃	Me
iBu	H	B7	Et	Me
iBu	H	B7	CF ₃	Me
secBu	H	B7	Et	Me
secBu	H	B7	CF ₃	Me
2,2-Me ₂ -propyl	H	B7	CF ₃	Me
nHex	H	B7	CF ₃	Me
ethenyl	H	B7	CF ₃	Me
1-propenyl	H	B7	Et	Me
1-propenyl	H	B7	CF ₃	Me
ethynyl	H	B7	CF ₃	Me
1-propynyl	H	B7	CF ₃	Me
CF ₃	H	B7	Et	Me
CHF ₂	H	B7	CF ₃	Me
C ₂ F ₅	H	B7	CF ₃	Me
2,2-Cl ₂ -cPr	H	B7	Et	Me
2,2-Cl ₂ -cPr	H	B7	CF	Me
cPr	H	B7	Et	Me
cPr	H	B7	CF ₃	Me
1-Me-cPr	H	B7	Et	Me
1-Me-cPr	H	B7	CF ₃	Me
cHex	H	B7	Et	Me
cHex	H	B7	CF	Me
CH ₂ Ph	H	B7	CF	Me
naphthyl-1	H	B7	Et	Me
naphthyl-1	H	B7	CF ₃	Me
naphthyl-2	H	B7	CF ₃	Me
CO ₂ Me	H	B7	CF ₃	Me
CO ₂ Et	H	B7	CF ₃	Me
2-thienyl	H	B7	CF ₃	Me

TABLE 8

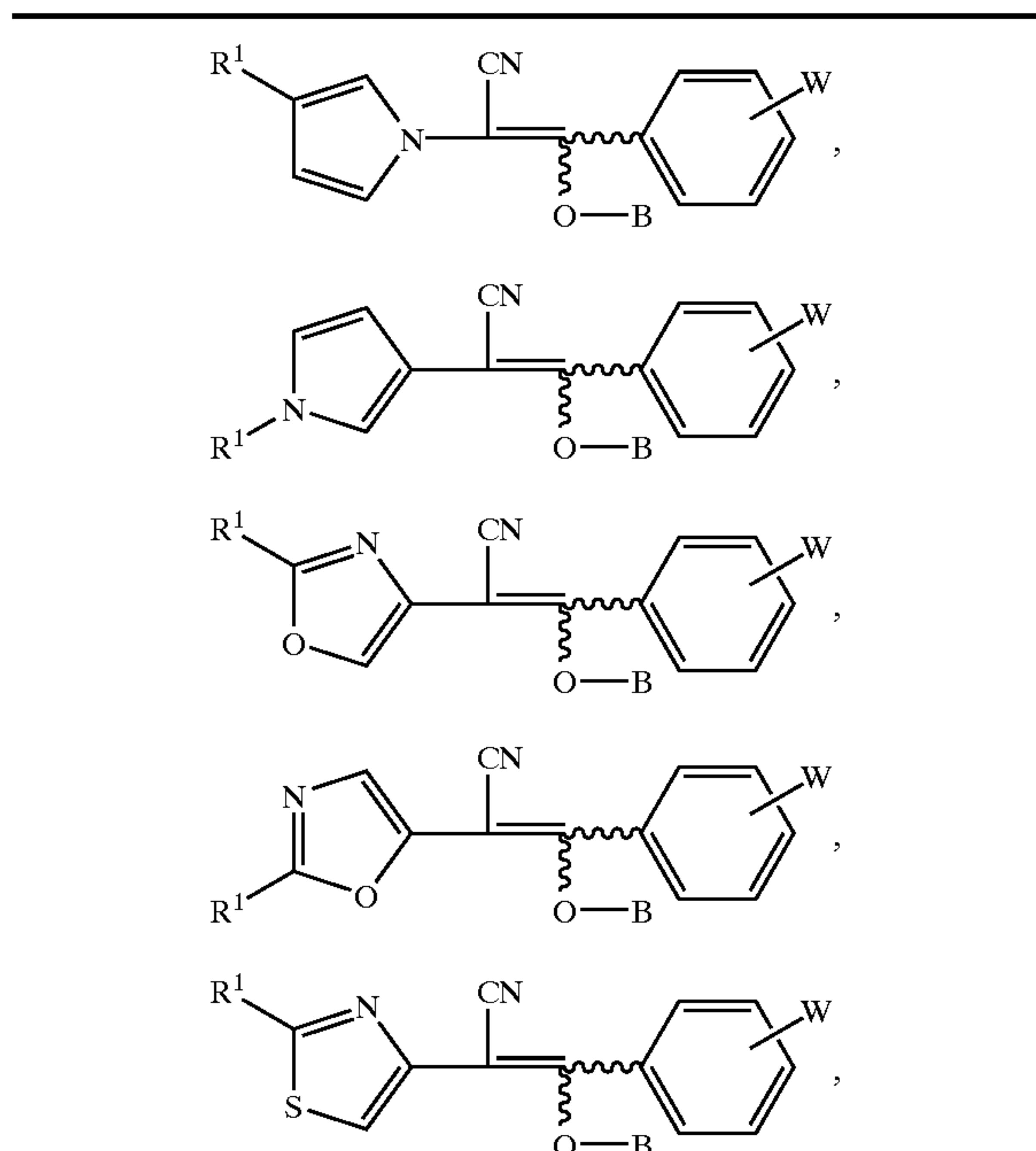

TABLE 8-continued

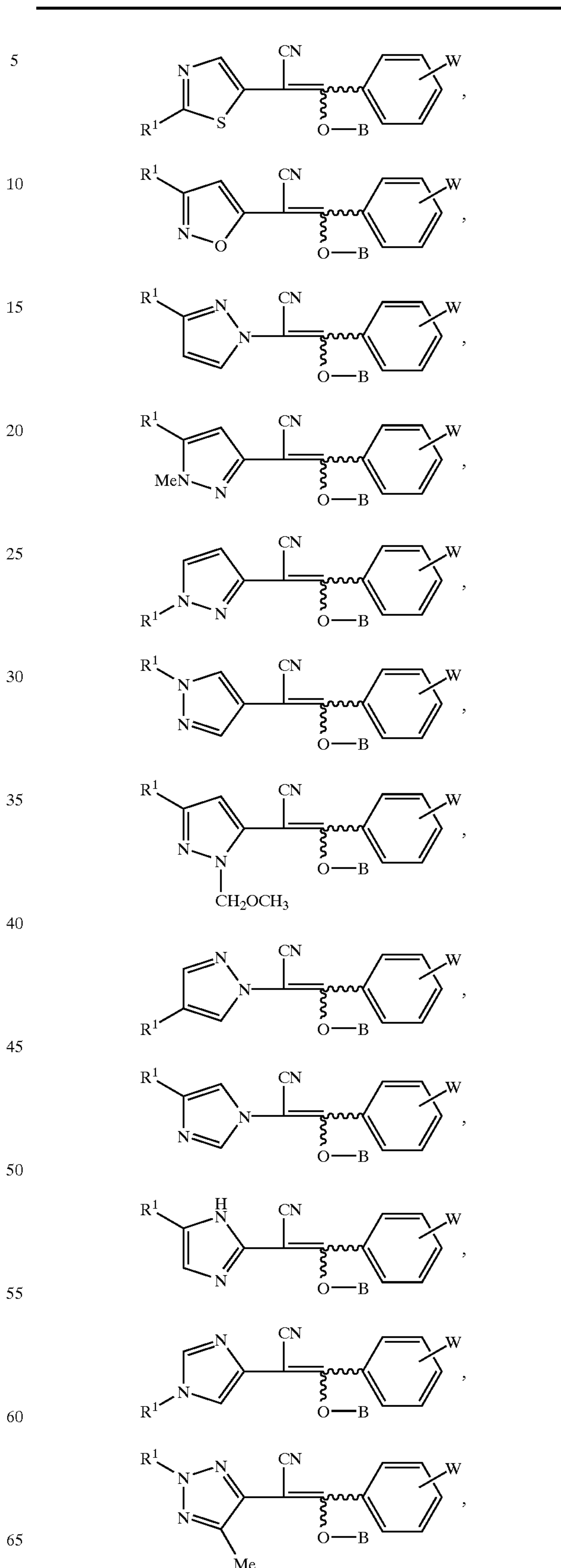

TABLE 8-continued

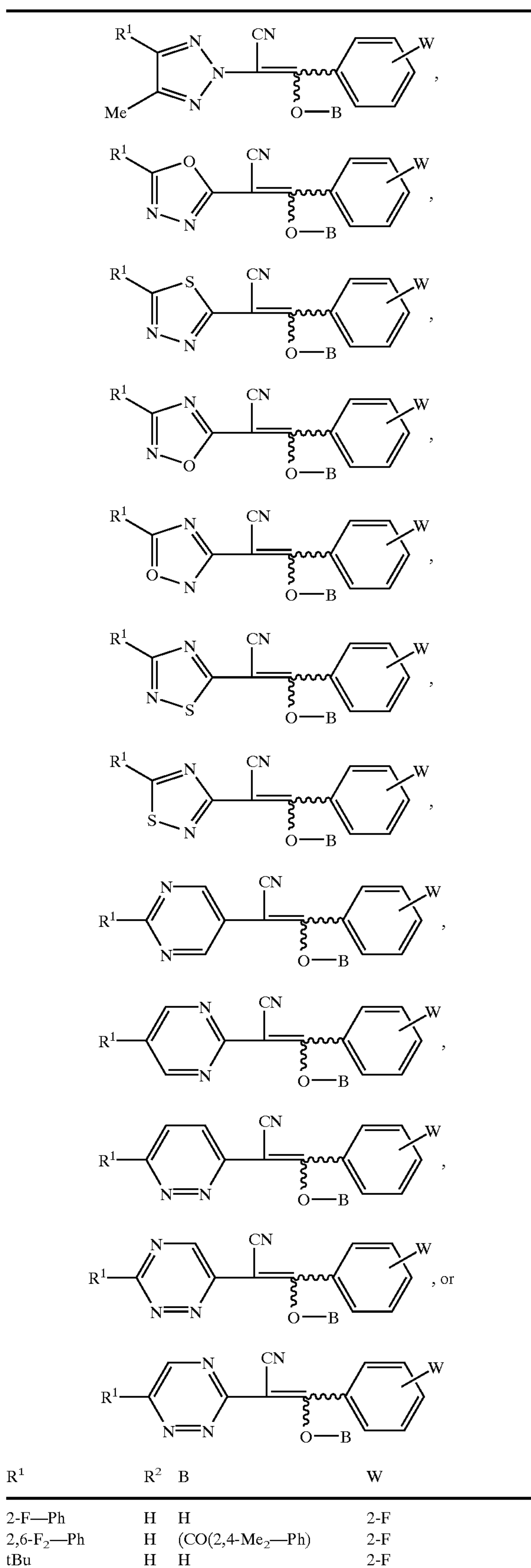

TABLE 8-continued

5	tBu	H	B7	2-F
	tBuCH ₂	H	B6	2-F
	EtMe ₂ C	H	B30	2-F
	cHex	H	B31	2-Cl
	1-Me-cHex	H	B32	2-Br
	Ph	H	B33	2-F
	2-F—Ph	H	B34	2-F
	2-Cl	H	H	2-Me
10	2-Cl—Ph	H	CO ₂ iPr	2-nBu
	2,6-F ₂ —Ph	H	CO(2-MeO—Ph)	2-OMe
	2,6-Cl ₂ —Ph	H	H	2-nBeO
	1-naphthyl	Cl	CO(4-MeO—Ph)	2-CF ₃
	2-naphthyl	Me	CO(2-Me—Ph)	2-OCHF ₂
15	tBu	H	Na	2-CF ₃
	tBu	H	Ca	2-OCH ₂ CH ₂ CHFCHF ₂
	2-pyridyl	H	H	2-OCF ₂ CHF ₂
	3-pyridyl	H	H	2-SMe
	4-pyridyl	H	B7	2-SOMe
	Me ₂ C=N—	H	B10	2-SO ₂ Me
	iPr	H	B13	2-SCBrF ₂
20	tBu	H	B19	2-SCF ₃
	tBuCH ₂	H	B22	2-SOCBrF ₂
	EtMe ₂ C	H	B23	2-SO ₂ CH ₂ F
	cHex	H	B7	2-SCF ₃
	Ph	H	B25	2-SCBrF ₂
	2-F—Ph	H	B26	2-SO ₂ CHF ₂
	2-F—Ph	H	B27	2-SCBrF ₂
25	2-CF ₃ —Ph	H	B28	2-CH=CCl ₂
	2,6-F ₂ —Ph	H	CO(2,6-Me ₂ —Ph)	2-OCH ₂ CH=CH ₂
	1-naphthyl	H	CO(2,6-(MeO) ₂ —Ph)	2-OCH ₂ CH=CCl ₂
	PhCH ₂	H	CO(2-Me-6-NO ₂ —Ph)	2-OCH ₂ CH=CHCl
	2-thienyl	H	CO(3,4,5-(MeO) ₃ —Ph)	2-SCH ₂ CH=CHMe
	4-Cl-2-thienyl	H	SO ₂ (4-Me—Ph)	2-SOCH ₂ CH=CH ₂
30	3-MeO-2-pyridyl	H	CO(2,6-Cl ₂ —Ph)	2-SO ₂ CHMeCH=CH ₂
	2-Cl-3-pyridyl	H	CO(2,5-Me ₂ —Ph)	2-SCH ₂ CMe=CF ₂
	2,6-Cl ₂ -4-pyridyl	H	CO(2,6-F ₂ —Ph)	2-SOCH ₂ CF=CF ₂
	EtMeC=N—	H	B1	2-SO ₂ CH ₂ CH=CF ₂
	Et	H	B2	2-CCH
	tBu	H	B4	2-CCl
35	tBuCH ₂	H	H	2-OCH ₂ CCH
	EtMe ₂ C	H	H	2-OCH ₂ CCCl
	cHex	H	H	2-SCH ₂ CCMe
	Ph	H	H	2-SOCH ₂ CCH
	2-MeO—Ph	H	B5	2-SO ₂ CH ₂ CCMe
	2-F—Ph	H	B6	2-SCH ₂ CBr
40	2,6-F ₂ —Ph	H	B7	2-SOCHMeCCCl
	2,6-Me ₂ —Ph	H	B8	2-SO ₂ CH ₂ CCl
	1-naphthyl	H	Ba	2-NO ₂
	PhCH ₂	H	K	2-CN
	2-naphthyl	H	H	2-CO ₂ Me
	5-Br-3-thienyl	H	B3	2-COMe
	3-MeO-2-pyridyl	H	B14	2-O(CO)Me
45	2-Cl-3-pyridyl	H	B15	2-NHMe
	2,6-Cl ₂ -4-pyridyl	H	B16	2-NMe
	(CH ₂) ₄ C=N—	H	B17	3-F
	tBu	H	H	3-Cl
	tBuCH ₂	H	H	3-nBu
	EtMe ₂ C	H	H	3-OEt
50	2-Me-cHex	H	H	3-CH ₂ CH ₂ CH ₂ CHF ₂
	Ph	H	B22	3-OCH ₂ CH ₂ CHFCHF ₂
	Ph	H	B27	3-S-nBu
	2-CF ₃ —Ph	H	B28	3-SOnPr
	2,6-F ₂ —Ph	H	B30	3-SO ₂ iPr
	2,6-Me ₂ —Ph	H	B31	3-SCF ₃
55	1-naphthyl	H	CO(3,4-(MeO) ₂ —Ph)	3-SCH ₂ CH ₂ CHFCHF ₂
	PhCH ₂	H	CO(2,4-Cl ₂ —Ph)	3-SO ₂ CF ₂ CHF ₂
	2-thienyl	H	CO(3-CF ₃ —Ph)	3-SCH ₂ CMe=CH ₂
	3-Me-2-pyridyl	H	CO(2-Me ₂ N—Ph)	3-SOCH ₂ CH=CH ₂
	3-NO ₂ -2-pyridyl	H	COiPr	3-SO ₂ CHMeCH=CH ₂
	3,6-Cl ₂ -2-pyridyl	H	CO ₂ iPr	3-SCH ₂ CMe=CF ₂
60	2-MeS-3-pyridyl	H	CO ₂ tBu	3-SOCH ₂ CF=CCl ₂
	(CH ₂) ₅ C=N—	H	CONHMe	3-SO ₂ CH ₂ CH=CH ₂ Cl
	sBu	H	CONHEt	3-OCH ₂ CCH
	tBuCH ₂	H	B19	3-SCH ₂ CCMe
	EtMe ₂ C	H	B18	3-SOCH ₂ CCH
	2-Me-cHex	H	SO ₂ (2-Me—Ph)	3-SO ₂ CH ₂ CCMe
	Ph	H	H	3-NO ₂
65	2-CF ₃ O—Ph	H	H	3-CN
	2-MeS—Ph	H	H	3-CO ₂ Et

TABLE 8-continued

2,6-F ₂ -Ph	H	Na	3-COnPr
2,6-Cl ₂ -Ph	H	K	3-O(CO)nPr
1-naphthyl	H	Mg	3-NHBu
3-F-2-pyridyl	H	Ca	3-NEt ₂
6-Me-pyridyl	H	Ba	4-F
4-CF ₃ -3-pyridyl	H	COCEtMe ₂	4-Cl
3-NO ₂ -3-pyridyl	H	CO(3-MeO-Ph)	4-Br
2,4-Me ₂ -3-pyridyl	H	CO-2-naphthyl	4-I
iBuMeC=N-	H	CO(4-EtO-3-MeO-Ph)	4-Me
tBu	H	CO(3-Cl-4-MeO-Ph)	4-tBu
tBu	H	CO(3-F-4-nBuO-Ph)	4-OMe
tBu	H	CH ₂ CO ₂ Me	4-CF ₃
Ph	H	CH(Me)CO ₂ Et	4-OCHF ₂
Ph	H	CMe ₂ CO ₂ nPr	4-SMe
2-pyridyl	H	CH ₂ CN	4-SOMe
sBu	H	CH ₂ CH ₂ CH ₂ CN	4-SO ₂ nBu
tBuCH ₂	H	CH ₂ CO ₂ iPr	4-SCF ₃
EtMe ₂ C	H	H	4-SOCBrF ₂
2-Me-cHex	H	H	4-SO ₂ CH ₂ F
Ph	H	H	4-OCH ₂ CH=CH ₂
2-CF ₃ -Ph	H	H	4-OCH ₂ CH=CCl ₂
2-NO ₂ -Ph	H	B3	4-OCH ₂ CCH
2,6-F ₂ -Ph	H	B4	4-OCH ₂ CCCl
2-Cl-6-F-Ph	H	B5	4-SCH ₂ CCMe
1-naphthyl	H	B6	4-SO ₂ CH ₂ CCMe
2-pyridyl	H	B7	4-NO ₂
3-pyridyl	H	B8	4-CN
PhCH ₂	H	B12	4-CO ₂ nBu
2-thienyl	H	B21	4-COIBu
3-thienyl	H	B28	4-O(CO)nPr
iBuMeC=N-	H	CO(2-MeO-Ph)	4-NHnBu
tBu	H	H	2,3-Cl ₂
tBu	H	H	2,4-Cl ₂
tBu	H	H	3,4-Cl ₂
Ph	H	H	3,5-Cl ₂
Ph	H	H	2,5-Cl ₂
2-pyridyl	H	B7	2,6-Cl ₂
sBu	H	B8	2,6-Cl ₂
tBuCH ₂	H	B12	2,6-Cl ₂
EtMe ₂ C	H	B23	2,3-F ₂
2-Me-cHex	H	B26	2,3-F ₂
Ph	H	B28	2,3-F ₂
2-Me-Ph	H	CONHiPr	2,4-F ₂
2-MeO-Ph	H	Ca	2,4-F ₂
2,6-F ₂ -Ph	H	Ba	2,5-F ₂
2,6-Cl ₂ -Ph	H	H	2,6-F ₂
1-naphthyl	H	H	2,6-F ₂
2-pyridyl	H	H	2,6-F ₂
PhCH ₂	H	CO(2,3-Me ₂ -Ph)	2,6-F ₂
3-pyridyl	H	CO(3,4-Me ₂ -Ph)	2,6-F ₂
4-pyridyl	H	CH ₂ CO ₂ Et	2,6-F ₂
2-thienyl	H	CHMeCO ₂ Me	2,6-F ₂
iBuMeC=N-	H	CH ₂ CN	2,6-F ₂
tBu	H	H	2,6-F ₂
tBu	H	B7	2,6-F ₂
tBu	H	B8	2,6-F ₂
tBu	H	B28	2,6-F ₂
tBu	Me	B31	2,6-F ₂
tBu	H	B34	2,6-F ₂
tBu	H	CO(2-MeO-Ph)	2,6-F ₂
tBu	H	CO(2-Cl-Ph)	2,6-F ₂
tBu	H	CO(2,6-Me ₂ -Ph)	2,6-F ₂
tBuCH ₂	H	CO(2,6-(MeO) ₂ -Ph)	2,6-F ₂
EtMe ₂ C	H	CO(3,4,5-(MeO) ₃ -Ph)	2,6-F ₂
cHex	H	B28	2,6-F ₂
cHex	H	B31	2,6-F ₂
cHex	H	B34	2,6-F ₂
1-Me-cHex	H	SO ₂ (4-Cl-Ph)	2,6-F ₂
Ph	H	H	2,6-F ₂
Ph	H	B5	2,6-F ₂
Ph	H	B6	2,6-F ₂
2-F-Ph	H	B14	2,6-F ₂
3-F-Ph	H	B19	2,6-F ₂
4-F-Ph	H	B23	2,6-F ₂
2-Cl-Ph	H	B24	2,6-F ₂
2,6-F ₂ -Ph	H	H	2,6-F ₂
2,6-F ₂ -Ph	H	Ca	2,6-F ₂
2,6-F ₂ -Ph	Me	B7	2,6-F ₂
2,6-F ₂ -Ph	H	B9	2,6-F ₂

TABLE 8-continued

1-naphthyl	H	B10	2,6-F ₂
2-naphthyl	H	B16	2,6-F ₂
2-thienyl	H	B22	2,6-F ₂
3-thienyl	H	B24	2,6-F ₂
2-pyridyl	Cl	H	3,4-F ₂
3-pyridyl	H	B7	3,5-F ₂
4-pyridyl	H	B18	2,5-(CF ₃) ₂
nPr ₂ C=N-	H	B31	2,6-(CF ₃) ₂
tBu	Et	H	3,5-(CF ₃) ₂
tBu	Br	H	5-Br-2-Cl
tBu	H	SO ₂ (4-Me-Ph)	3-Br-4Me
tBu	H	COHex	2-Cl-4-F
tBu	H	CO(2-Cl-6-F-Ph)	2-Cl-6-F
tBuCH ₂	H	CO(3,5-Cl ₂ -4MeO-Ph)	2-Cl-6-F
EtMe ₂ C	H	CO(3-Br-4-Me-Ph)	2-Cl-6-F
cHex	H	H	2-Cl-6-F
cHex	H	B6	2-Cl-6-F
Ph	H	B7	2-Cl-6-F
Ph	H	B8	2-Cl-6-F
2-F-Ph	H	B34	2-Cl-6-F
3-F-Ph	H	CO ₂ tBu	2-Cl-6-F
2-Cl-Ph	H	CHMeCO ₂ Me	2-Cl-6-F
2,6-F ₂ -Ph	H	B31	3-Cl-4-F
2,6-F ₂ -Ph	H	K	4-Cl-3-F
tBu	H	Ba	2-F-6-I
2,6-F ₂ -Ph	H	CO(4-nBuO-Ph)	2-F-6-I
2,6-F ₂ -Ph	H	CO(4-Et ₂ N-Ph)	2-F-6-I
2,6-F ₂ -Ph	Br	CO(3-Me ₂ N-Ph)	2-Cl-5-SMe
1-naphthyl	H	CO(4-Et-Ph)	2-Cl-5-SCBrF ₂
2-naphthyl	H	CO(3-F-4-Me-Ph)	2-Cl-5-SCF ₃
2-thienyl	H	CO(3-MeO-4-Me-Ph)	2-Cl-5-SOMe
3-thienyl	H	CO(2,3,6-F ₃ -Ph)	2-Cl-5-SO ₂ Me
2-pyridyl	H	CO(2-MeO-5-NO ₂ -Ph)	2-Cl-4-NO ₂
3-pyridyl	H	CO(3,5-Me ₂ -Ph)	2,4-(OMe) ₂
4-pyridyl	H	H	2,6-(OMe) ₂
nPr ₂ C=N-	H	H	2,6-(OMe) ₂
tBu	H	H	2,3-Me ₂
tBu	H	B1	2,4-Me ₂
tBu	H	B2	2,5-Me ₂
tBuCH ₂	H	B3	2,6-Me ₂
EtMe ₂ C	H	B4	2,6-Me ₂
cHex	H	B5	2,6-Me ₂
cHex	H	B6	3,4-Me ₂
1-Me-cHex	H	B7	3,5-Me ₂
Ph	H	B8	2-F-4-Me
Ph	H	B9	2-F-4-Me
Ph	H	B10	2-F-4-Me
2-F-Ph	H	B11	3-F-4-Me
2-F-Ph	H	B12	3-I-4-Me
3-F-Ph	H	B13	2-OMe-4-SMe
4-F-Ph	H	B14	3-OMe-4-NO ₂
2-Cl-Ph	H	CH ₂ CN	2-Me-4-NO ₂
2,6-F ₂ -Ph	H	CMe ₂ CO ₂ Et	2-Me-6-NO ₂
2,6-F ₂ -Ph	H	CONHMe	2,3,6-F ₃
tBu	H	SO ₂ (4-Cl-Ph)	2,3,6-F ₃
cHex	H	CO(2-MeO-Ph)	2,3,6-F ₃
1-naphthyl	H	CO(2-Me-Ph)	2,3,6-F ₃
2-F-Ph	H	CO(2-Cl-Ph)	2,3,6-F ₃
2-pyridyl	H	CO(2,6-(MeO) ₂ -Ph)	2,4,5-F ₃
3-pyridyl	H	CO(3,4-Me ₂ -Ph)	2,4,5-F ₃
4-pyridyl	H	CO(3-MeO-4-EtO-Ph)	2,4,5-F ₃
nPr ₂ C=N-	H	B15	2,3,5-I ₃
tBu	H	B16	2,3,5-I ₃
tBu	H	B17	2,3,4-(OMe) ₃
tBu	H	B18	2,4,5-(OMe) ₃
tBu	H	B19	3,4,5-(OMe) ₃
tBu	H	B20	2,4,6-Me ₃
tBuCH ₂	H	B21	2,3,4,5-F ₄
EtMe ₂ C	H	B24	2,3,4,5-F ₄
cHex	H	B25	2,3,4,5-F ₄
cHex	H	B27	2,3,5,6-F ₄
cHex	H	B28	2,3,5,6-F ₄
1-Me-cHex	H	B29	2,3,5,6-F ₄
Ph	H	B30	2,3,5,6-F ₄
Ph	H	B31	2,3,4,5,6-F ₅
Ph	H	B32	2,3,4,5,6-F ₅
2-F-Ph	H	B33	2,3,4,5,6-F ₅
3-F-Ph	H	B34	2,3,5,6-F ₄ -4-Me
4-F-Ph	H	H	2,3,5,6-F ₄ -4-Me

TABLE 8-continued

2-Cl—Ph	H	H	2,3,5,6-F ₄ -4-Me
2,6-F ₂ —Ph	H	B27	2,3,5,6-F ₄ -4-Me
2,6-F ₂ —Ph	H	Ca	2,3,5,6-F ₄ -4-Me

TABLE 9

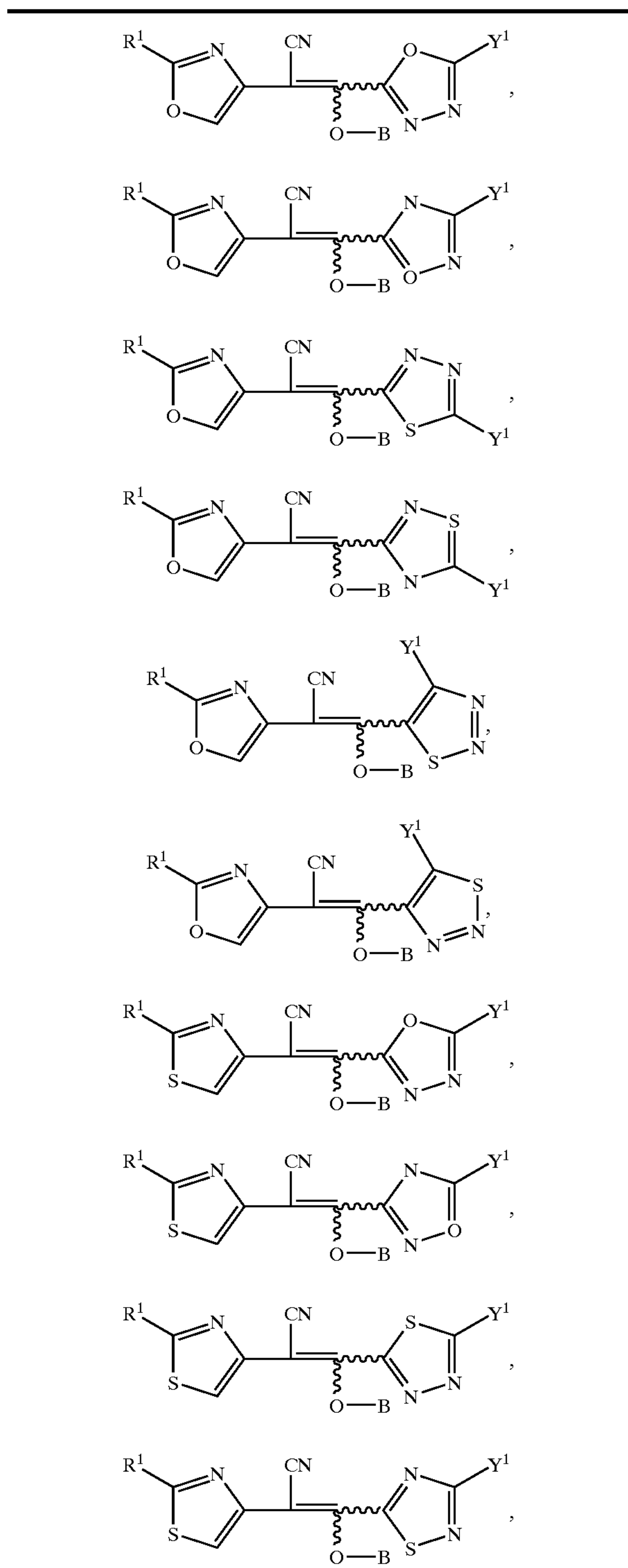

TABLE 9-continued

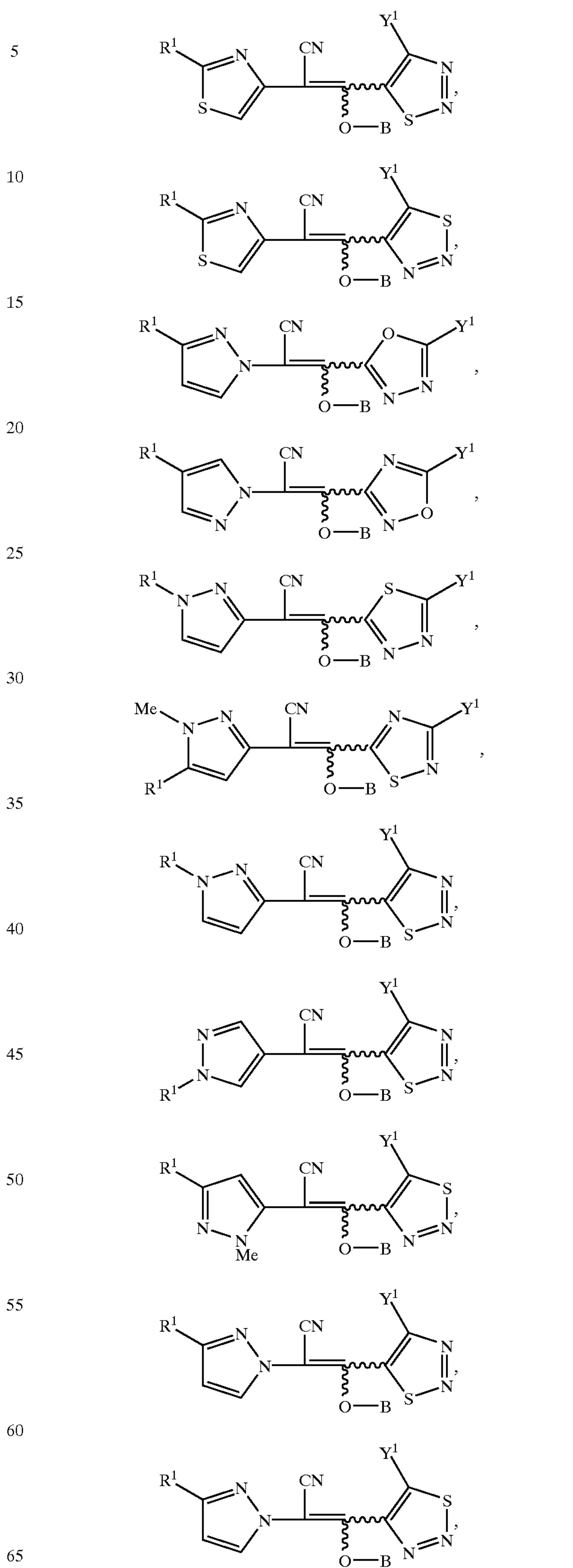

TABLE 9-continued

TABLE 9-continued

R ¹	B	Y ¹
Me	H	H
Et	B1	Me
iPr	B2	Et
nBu	B3	nPr
sBu	B4	iBu
tBu	H	nHex
tBu	B7	Me
tBu	B8	MeO
tBu	B8	MeS
tBu	B7	CF ₃
tBu	B5	CF ₃

5	tBu	B7	CClF ₂
	tBu	B8	CF ₃ CF ₂
	tBu	4-Cl—PhCO ₂	CF ₃ CF ₂ CF ₂
	tPen	B6	MeO
	nHex	B7	EtO
	nHep	B8	iPrO
	nOct	B9	sBuO
	nNon	B10	MeS
	nDec	B11	EtS
	PhCH ₂	B12	nPrS
	Ph(Me)CH	B13	tBuS
	PhMe ₂ C	B14	Ph
	PhMe ₂ C	B7	Me
	PhMe ₂ C	B8	Me
	PhMe ₂ C	B33	Me
	PhMe ₂ C	B34	Me
	PhMe ₂ C	B41	Me
	PhMe ₂ C	B7	CF ₃
	PhMe ₂ C	B8	CF ₃
	PhMe ₂ C	B34	CF ₃
	4-Cl—PhMe ₂ C	B15	Me ₂ N
	3-Br—PhEtMeC	B16	Et ₂ N
	4-Me—Ph(CH ₂) ₃	B17	H
	CH ₂ =CMe	B18	Me
	CF ₃ CF ₂ CF ₂	B19	Et
	cPr	B20	nPr
	cPen	B21	iBu
	cPen	B22	nHex
	cPen	B23	CF ₃
	cHex	B24	CClF ₂
	cHex	B7	CF ₃
	cHex	B8	CF ₃
	cHex	B33	CF ₃
	cHex	B34	CF ₃
	cHex	B7	Me
	cHex	B8	Me
	cHex	B34	Me
	1-Me-cHex	B7	Me
	1-Me-cHex	B8	CF ₃
	1-Me-cHex	B7	CF ₃
	1-Me-cHex	iBuOC(O)	CF ₃
	1-Me-cHex	B28	EtO
	1-Me-cHex	B29	iPrO
	EtO	B30	sBuO
	iPrO	B31	MeS
	CF ₃ O	B32	EtS
	tBuOC(O)	B33	nPrS
	Ph	B34	tBuS
	2-F—Ph	B35	Ph
	2-F—Ph	B36	Me ₂ N
	2-Cl—Ph	B37	Et ₂ N
	2-Cl—Ph	B38	Cl
	2-Br—Ph	B39	Br
	2-I—Ph	B40	I
	2-CF ₃ —Ph	B41	H
	2-MeO—Ph	B42	CF ₃
	3,4-Cl ₂ —Ph	CClF ₂ C(O)	MeO
	2,4-Me ₂ —Ph	PhSC(O)	MeS
	2,6-F ₂ —Ph	B7	Me
	2,6-F ₂ —Ph	B7	CF ₃
	2,6-F ₂ —Ph	B8	Me
	2,6-F ₂ —Ph	B8	CF ₃
	2,6-F ₂ —Ph	EtSC(O)	H
	2,6-F ₂ —Ph	tBuC(S)	Me
	2,6-F ₂ —Ph	cPenOC(O)	Et
	2,6-F ₂ —Ph	cHexOC(O)	nPr
	2-pyridyl	B7	Me
	2-pyridyl	B8	Me
	2-pyridyl	B7	CF ₃
	2-pyridyl	B8	CF ₃
	2-pyridyl	iBuOC(O)	CF ₃
	2-pyridyl	B33	CF ₃
	2-pyridyl	B34	CF ₃
	2-pyridyl	B34	Me
	2-pyridyl	2-pyridyl-C(O)	CClF ₂
	2-pyridyl	2-pyridyl-C(O)	CF ₃ CF ₂
	2-thienyl	3-pyridyl-C(O)	CF ₃ CF ₂ CF ₂
	1-naphthyl	4-pyridyl-C(O)	MeO
	2-naphthyl	H	EtO
60			
65			

TABLE 9-continued

tBu	CClF ₂ C(O)	H
tBu	PhSC(O)	Me
tBu	EtSC(O)	Et
tBu	tBuC(S)	nPr
cPr	cPenOC(O)	iBu
cPen	cHexOC(O)	nHex

TABLE 9-continued

cHex	B7	CF ₃
1-Et-cPr	B8	CClF ₂
1-Me-cPen	iBuOC(O)	CF ₃ CF ₂
1-Me-cPen	2-pyridyl-C(O)	CF ₃ CF ₂ CF ₂
2,6-F ₂ -Ph	2-pyridyl-C(O)	MeO
2,6-F ₂ -Ph	2-pyridyl-C(O)	MeO
2,6-F ₂ -Ph	4-pyridyl-C(O)	Me
2,6-F ₂ -Ph	2-pyridyl-C(O)	CF ₃

TABLE 10

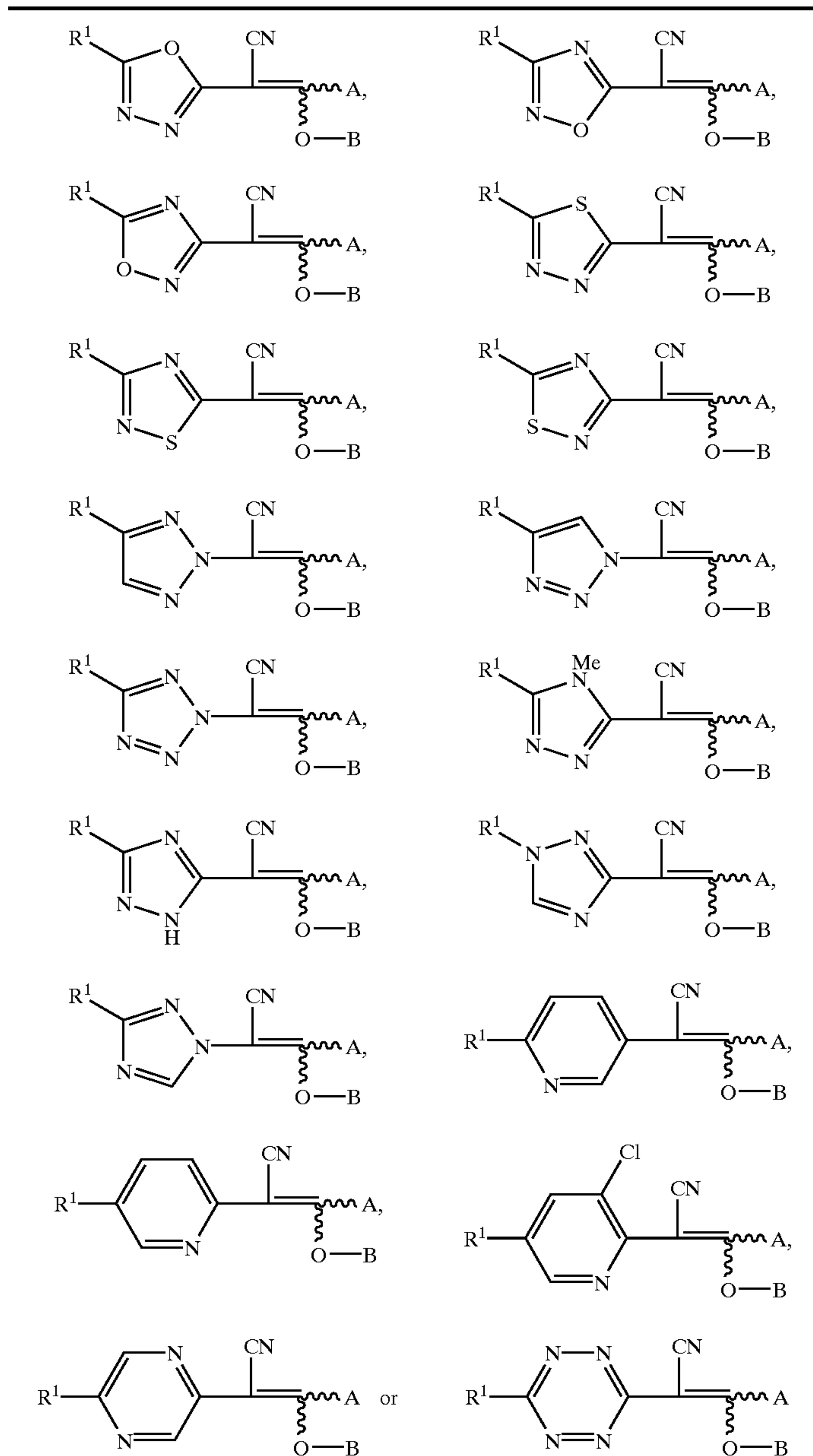

R ¹	B	A	R ¹	B	A
Et	H	A1	tBu	B15	A8
iPr	B7	A2	tBu	B34	A8
iBu	B7	A1	tBu	H	A9
sBu	B7	A2	tBu	B7	A9

TABLE 10-continued

tBu	B7	A1	tBu	B8	A9
tBu	B8	A1	tBu	B15	A9
tBu	B15	A1	tBu	B34	A9
tBu	B34	A1	tBu	CO ₂ -iBu	A9
tBu	B7	A2	tBu	H	A10
tBu	B8	A2	tBu	B7	A10
tBu	B15	A2	tBu	B8	A10
tBu	B34	A2	tBu	B15	A10
tBu	CO ₂ -iBu	A2	tBu	B34	A10
tBu	B7	A3	tBu	CO ₂ -iBu	A10
tBu	B7	A4	tBu	R	A11
tBu	B7	A5	tBu	B7	A11
tBu	B7	A6	tBu	B8	A11
tBu	H	A7	tBu	B15	A11
tBu	B7	A7	tBu	H	A12
tBu	B8	A7	tBu	B7	A12
tBu	B15	A7	tBu	B8	A12
tBu	B34	A7	tBu	B15	A12
tBu	H	A8	tBu	B34	A12
tBu	B7	A8	tBu	CO ₂ -iBu	A12
tBu	B8	A8	tBu	H	A13
tBu	B7	A13	tBu	B17	A27
tBu	B8	A13	tBu	B18	A28
tBu	B15	A13	tBu	B19	A29
tBu	B34	A13	tBu	B7	A30
tBu	CO ₂ -iBu	A13	tBu	B8	A30
tBu	H	A14	tBu	B15	A30
tBu	B7	A14	tBu	B20	A31
tBu	B16	A14	tBu	H	A32
tBu	B27	A14	tBu	B7	A32
tBu	B7	A15	tBu	B8	A32
tBu	B8	A16	tBu	B15	A32
tBu	B9	A17	tBu	B34	A32
tBu	B10	A18	tBu	CO ₂ -iBu	A32
tBu	B11	A19	tBu	B21	A33
tBu	B12	A20	tBu	B22	A34
tBu	B13	A21	tBu	B23	A35
tBu	B7	A22	tBu	B24	A36
tBu	B8	A22	tBuCH ₂	B3	A1
tBu	B7	A23	tBuCH ₂	B7	A2
tBu	B8	A23	tBuCH ₂	B8	A2
tBu	B15	A23	Et(Me) ₂ C	B15	A2
tBu	B34	A23	Et(Me) ₂ C	B16	A2
tBu	B14	A24	Et(Me) ₂ C	B34	A2
tBu	B15	A25	Et(Me) ₂ C	H	A2
tBu	B16	A26	Et(Me) ₂ C	B7	A2
nHex	B7	A1	Ph	B7	A10
nHep	B7	A2	Ph	B7	A13
nOct	B7	A1	Ph	B7	A32
nNon	B7	A2	2-F—Ph	B7	A1
nDec	B7	A7	2-F—Ph	B7	A1
cPr	B7	A8	2-F—Ph	B7	A7
1-Me-cPr	B7	A1	2-F—Ph	B7	A8
1-Me-cPr	B7	A2	2-F—Ph	B7	A9
1-Me-cPr	B8	A2	2-F—Ph	B7	A10
1-Me-cPr	B34	A2	2-F—Ph	B7	A13
1-Me-cPr	H	A2	2-F—Ph	B8	A32
cPen	B7	A2	2-Cl—Ph	B7	A1
cHex	B7	A1	2-Cl—Ph	B7	A2
cHex	B7	A2	2-Cl—Ph	B7	A7
cHex	B8	A2	2-Cl—Ph	B7	A8
cHex	B15	A2	2-Cl—Ph	B7	A9
cHex	B34	A2	2-Cl—Ph	B7	A10
cHex	B35	A2	2-Cl—Ph	B7	A13
cHex	B36	A1	2-Cl—Ph	B8	A30
cHex	B37	A2	2-Cl—Ph	B34	A32
Ph	H	A2	2-Br—Ph	B7	A1
Ph	B7	A2	2-I—Ph	B7	A2
Ph	B7	A7	2-Me—Ph	B7	A7
Ph	B7	A8	2-Me—Ph	B7	A8
Ph	B7	A9	2-Me—Ph	B7	A9
2-Me—Ph	B7	A1	2,6-Cl ₂ —Ph	B7	A1
2-Me—Ph	B7	A2	2,6-Cl ₂ —Ph	B7	A2
2-MeO—Ph	B2	A7	2,6-Cl ₂ —Ph	B7	A7
2-CF ₃ —Ph	B3	A8	2,6-F ₂ —Ph	B7	A1
2-NO ₂ —Ph	B4	A9	2,6-F ₂ —Ph	B7	A2
2-CN—Ph	B5	A10	2,6-F ₂ —Ph	B7	A7
2-CBrF ₂ O—Ph	B6	A11	2,6-F ₂ —Ph	B7	A8
2-CF ₃ O—Ph	B7	A12	2,6-F ₂ —Ph	B7	A9

TABLE 10-continued

2-MeS—Ph	B8	A13	2,6-F ₂ —Ph	B7	A10
2-nBuS—Ph	B9	A14	2,6-F ₂ —Ph	B7	A13
2-MeSO—Ph	B10	A15	2,6-F ₂ —Ph	B7	A21
2-MeSO ₂ —Ph	B11	A16	2,6-F ₂ —Ph	B7	A32
2-CH ₂ =CHCH ₂ S—Ph	B12	A17	2,6-F ₂ —Ph	B3	A2
2-CH ₂ =CHCH ₂ SO—Ph	B13	A18	2,6-F ₂ —Ph	B4	A2
2-CH ₂ =CHCH ₂ SO ₂ —Ph	B14	A19	2,6-F ₂ —Ph	B5	A2
2-CF ₃ S—Ph	B15	A20	2,6-F ₂ —Ph	B8	A2
2-CHF ₂ S—Ph	B16	A21	2,6-F ₂ —Ph	B15	A2
2-CBrF ₂ SO—Ph	B17	A22	2,6-F ₂ —Ph	B19	A2
2-CF ₃ SO ₂ —Ph	B18	A23	2,6-F ₂ —Ph	B32	A2
2-CHO—Ph	B19	A24	2,6-F ₂ —Ph	B33	A2
2-OH—Ph	B20	A25	2,6-F ₂ —Ph	B34	A2
2-Me ₂ N—Ph	B21	A26	2,6-F ₂ —Ph	B35	A2
3-Ph—Ph	B22	A27	2,6-F ₂ —Ph	B37	A2
4-PhO—Ph	B23	A28	2,6-F ₂ —Ph	B40	A2
2-MeOC(O)—Ph	B24	A29	2,6-F ₂ —Ph	B43	A2
Cl	B7	A1	CICC	B3	A23
PhCH ₂	B7	A1	2,2-Cl ₂ -cPr	B4	A23
PhCH ₂	B7	A2	2,2-F ₂ -cBu	B5	A23
PhCH ₂	B8	A2	MeO	B6	A24
PhCH ₂	B34	A2	nHexO	B7	A25
(4-Cl—Ph)CH ₂	B7	A30	CH ₂ =CHCH ₂ O	B8	A26
(4-Me—Ph)CH ₂	B7	A31	CHCCH ₂ O	B9	A27
(3,4-Cl ₂ —Ph)CH ₂	B7	A32	CF ₃ O	B10	A28
(2,4-Me ₂ —Ph)CH ₂	B7	A33	CICH=CHCH ₂ O	B11	A29
PhMeCH	B7	A34	MeS	B12	A30
Ph(Me) ₂ C	B3	A1	MeSO	B13	A30
Ph(Me) ₂ C	B7	A1	MeSO ₂	B14	A30
Ph(Me) ₂ C	B3	A2	Me ₂ C=CHCH ₂ S	B15	A31
Ph(Me) ₂ C	B7	A2	Me ₂ C=CHCH ₂ SO	B16	A32
Ph(Me) ₂ C	B8	A2	Me ₂ C=CHCH ₂ SO ₂	B17	A32
Ph(Me) ₂ C	B33	A2	CHCCH ₂ S	B18	A32
Ph(Me) ₂ C	B34	A2	CHCCH ₂ SO	B19	A1
Ph(Me) ₂ C	B35	A2	CHCCH ₂ SO ₂	B20	A2
Ph(Me) ₂ C	B7	A13	CF ₃ S	B21	A2
Ph(Me) ₂ C	B8	A13	CF ₃ SO	B22	A13
Ph(Me) ₂ C	B34	A13	CF ₃ SO ₂	B23	A13
CF ₃	B15	A35	CICH=CHCH ₂ S	B24	A1
CF ₃ CH ₂	B6	A36	CICH=CHCH ₂ SO	B25	A1
CH ₂ =CMe	B6	A1	CICH=CHCH ₂ SO ₂	B26	A2
Cl ₂ C=CH	B29	A2	CICCCCH ₂ S	B27	A2
BrCCCH ₂ SO	B28	A1	2-pyridyl	H	A7
CICCH ₂ SO ₂	B29	A2	2-pyridyl	B7	A7
1-naphthyl	B30	A2	2-pyridyl	B8	A7
2-naphthyl	B31	A13	2-pyridyl	B15	A7
MeC(O)	B32	A13	2-pyridyl	B34	A7
MeC(O)O	B33	A1	2-pyridyl	H	A8
CF ₃ C(O)O	B34	A1	2-pyridyl	B7	A8
2-thienyl	B35	A2	2-pyridyl	B8	A8
3-thienyl	B36	A2	2-pyridyl	B15	A8
Me ₂ C=N	B37	A1	2-pyridyl	B34	A8
EtMeC=N	B38	A1	2-pyridyl	H	A9
PhCH=N	B39	A2	2-pyridyl	B7	A9
PhMeC=N	B40	A2	2-pyridyl	B8	A9
2-pyridyl	B7	A1	2-pyridyl	B15	A9
2-pyridyl	B8	A1	2-pyridyl	B34	A9
2-pyridyl	B15	A1	2-pyridyl	CO ₂ -iBu	A9
2-pyridyl	B34	A1	2-pyridyl	H	A10
2-pyridyl	B7	A2	2-pyridyl	B7	A10
2-pyridyl	B8	A2	2-pyridyl	B8	A10
2-pyridyl	B15	A2	2-pyridyl	B15	A10
2-pyridyl	B34	A2	2-pyridyl	B34	A10
2-pyridyl	CO ₂ -iBu	A2	2-pyridyl	CO ₂ -tBu	A10
2-pyridyl	B7	A3	2-pyridyl	H	A11
2-pyridyl	B7	A4	2-pyridyl	B7	A11
2-pyridyl	B7	A5	2-pyridyl	B8	A11
2-pyridyl	B7	A6	2-pyridyl	B15	A11
2-pyridyl	H	A12	2-pyridyl	B8	A23
2-pyridyl	B7	A12	2-pyridyl	B15	A23
2-pyridyl	B8	A12	2-pyridyl	B34	A23
2-pyridyl	B15	A12	2-pyridyl	B14	A24
2-pyridyl	B34	A12	2-pyridyl	B15	A25
2-pyridyl	CO ₂ -tBu	A12	2-pyridyl	B16	A26
2-pyridyl	H	A13	2-pyridyl	B17	A27
2-pyridyl	B7	A13	2-pyridyl	B18	A25
2-pyridyl	B8	A13	2-pyridyl	B19	A29
2-pyridyl	B15	A13	2-pyridyl	B7	A30
2-pyridyl	B34	A13	2-pyridyl	B8	A30

TABLE 10-continued

2-pyridyl	CO ₂ -tBu	A13	2-pyridyl	B15	A30
2-pyridyl	H	A14	2-pyridyl	B20	A31
2-pyridyl	B7	A14	2-pyridyl	H	A32
2-pyridyl	B16	A14	2-pyridyl	B7	A32
2-pyridyl	B17	A14	2-pyridyl	B8	A32
2-pyridyl	B7	A15	3-pyridyl	B7	A1
2-pyridyl	B8	A16	3-pyridyl	B34	A2
2-pyridyl	B9	A17	3-pyridyl	CO ₂ -iBu	A2
2-pyridyl	B10	A18	3-pyridyl	B7	A13
2-pyridyl	B11	A19	3-pyridyl	B8	A13
2-pyridyl	B12	A20	4-pyridyl	B7	A1
2-pyridyl	B13	A21	4-pyridyl	B8	A1
2-pyridyl	B7	A22	4-pyridyl	B15	A2
2-pyridyl	B8	A22	4-pyridyl	B34	A2

TABLE 11

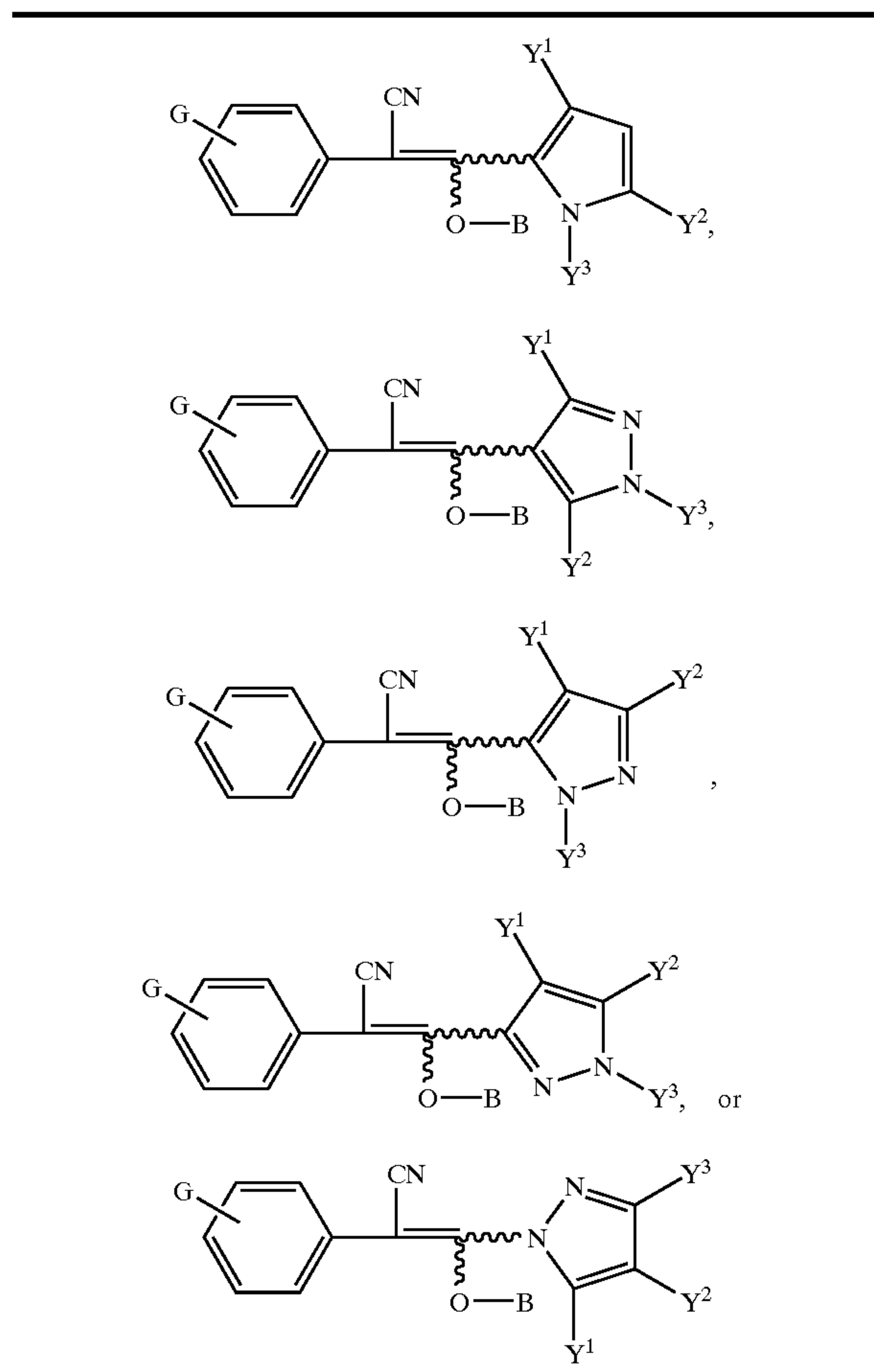

G	B	Y ¹	Y ²	Y ³
2-Cl	H	Me	Me	Me
3-Cl	B1	Me	Cl	Me
4-Cl	B2	Cl	Me	Me
4-Br	B3	Cl	Cl	Me
4-I	B4	CF ₃	Cl	Me
4-F	B5	CF ₃	H	Me
4-Me	B6	H	CF ₃	Me
4-Et	B7	H	Cl	Me
4-iPr	B8	Cl	H	Me
4-nBu	B9	H	H	Me
4-iBu	B10	OMe	Cl	Me
4-sBu	B11	SMe	Cl	Me
4-sBu	H	Me	Me	Me

TABLE 11-continued

20	4-sBu	B16	Me	Me	Me
	4-sBu	B17	Me	Me	Me
	4-sBu	B7	Me	Cl	Me
	4-sBu	B8	Me	Cl	Me
	4-sBu	B16	Me	Cl	Me
	4-sBu	B17	Me	Cl	Me
25	4-sBu	B34	Me	Cl	Me
	4-sBu	B3	CF ₃	Cl	Me
	4-sBu	B7	CF ₃	Cl	Me
	4-sBu	B8	CF ₃	Cl	Me
	4-sBu	B34	CF ₃	Cl	Me
	4-sBu	B7	Cl	Cl	Me
30	4-sBu	B17	Cl	Cl	Me
	4-tBu	B12	SCF ₃	Cl	Me
	4-tBu	H	Me	Me	Me
	4-tBu	B3	Me	Cl	Me
	4-tBu	B7	Cl	Me	Me
	4-tBu	B8	Cl	Cl	Me
35	4-tBu	B15	Cl	Cl	Me
	4-tBu	B16	Cl	Cl	Me
	4-tBu	B28	Cl	Cl	Me
	4-tBu	B30	Cl	Cl	Me
	4-tBu	B34	Cl	Cl	Me
	4-tBu	CO-nC ₈ H ₁₇	Cl	Cl	Me
	4-tBu	CO-nC ₁₅ H ₃₁	Cl	Cl	Me
40	4-tBu	CO ₂ -nHex	Cl	Cl	Me
	4-tBu	CO ₂ -nC ₁₀ H ₂₁	Cl	Cl	Me
	4-tBu	H	CN	Cl	Me
	4-tBu	H	CF ₃	Cl	Me
	4-tBu	B3	CF ₃	Cl	Me
	4-tBu	B7	CF ₃	Cl	Me
45	4-tBu	B8	CF ₃	Cl	Me
	4-tBu	B15	CF ₃	Cl	Me
	4-tBu	B16	CF ₃	Cl	Me
	4-tBu	B28	CF ₃	Cl	Me
	4-tBu	B30	CF ₃	Cl	Me
	4-tBu	B16	Cl	Cl	Me
	4-tBu	B16	CF ₃	Cl	Me
50	4-tBu	B17	CF ₃	Cl	Me
	4-tBu	B17	Cl	Cl	Me
	4-tBu	CO ₂ -nC ₁₀ H ₂₁	CF ₃	Cl	Me
	4-tBu	CH ₂ OEt	CF ₃	Cl	Me
	4-tBu	B7	Me	Cl	Me
55	4-tBu	B7	Me	Me	Me
	4-tBu	B7	CN	Cl	Me
	4-tBu	B16	CN	Cl	Me
	4-tBu	B3	CN	Cl	Me
	4-tBu	2-(4-tBu-Ph)- 3,3-Me ₂ -cPrC(O)	CF ₃	Cl	Me
	4-tBu	B45	CF ₃	Cl	Me
60	4-tBuCH ₂	B3	CF ₃	Cl	Me
	4-tBuCH ₂	B7	Me	Me	Me
	4-tBuCH ₂	B16	Me	Cl	Me
	4-tBuCH ₂	B7	CF ₃	Cl	Me
	4-tBuCH ₂	B8	CF ₃	Cl	Me
	4-tBuCH ₂	B7	Cl	Cl	Me
65	4-Et(Me) ₂ C	H	CF ₃	Cl	Me
	4-Et(Me) ₂ C	B3	CF ₃	Cl	Me

TABLE 11-continued

4-Et(Me) ₂ C	B7	CF ₃	Cl	Me
4-Et(Me) ₂ C	B8	CF ₃	Cl	Me
4-Et(Me) ₂ C	B34	CF ₃	Cl	Me
4-Et(Me) ₂ C	B42	CF ₃	Cl	Me
4-Et(Me) ₂ C	B16	Me	Me	Me
4-Et(Me) ₂ C	B17	Me	Me	Me
4-Et(Me) ₂ C	H	Cl	Me	Me
4-Et(Me) ₂ C	B7	Cl	Cl	Me
4-Et(Me) ₂ C	B8	Cl	Cl	Me
4-Et(Me) ₂ C	B7	CF ₃	Me	Me
4-Et(Me) ₂ C	B7	CN	Cl	Me
4-Et(Me) ₂ C	B4	H	Cl	Me
4-Et(Me) ₂ C	B5	Cl	H	Me
4-Et(Me) ₂ C	B6	H	H	Me
4-Et(Me) ₂ C	B3	Cl	Cl	Me
4-Et(Me) ₂ C	B16	Cl	Cl	Me
4-Et(Me) ₂ C	B17	Cl	Cl	Me
4-Et(Me) ₂ C	B24	Cl	Cl	Me
4-nHex	B34	CF ₃	Cl	Me
4-nHep	B42	CF ₃	Cl	Me
4-nOct	B43	Me	Me	Me
4-nNon	B43	Me	Cl	Me
4-nDec	H	Cl	Me	Me
4-(Me) ₂ (CN)C	B7	Cl	Cl	Me
4-PhCH ₂	B7	CF ₃	Cl	Me
4-Ph(Me) ₂ C	B7	CF ₃	Me	Me
4-(4-F-Ph)(Me) ₂ C	B7	CN	Cl	Me
4-MeCH=CH	B4	H	Cl	Me
4-MeCC	B5	Cl	H	Me
3-CF ₃	B6	H	H	Me
4-CF ₃	B7	OMe	Cl	Me
4-CF ₃	B8	SMe	Cl	Me
4-CF ₃	B9	SCF ₃	Cl	Me
4-CF ₃	B16	Me	Me	Me
4-CF ₃	B17	Me	Me	Me
4-CF ₃	B16	Me	Cl	Me
4-CF ₃	B17	Cl	Me	Me
4-CF ₃	B7	Cl	Cl	Me
4-CF ₃	B7	CF ₃	Cl	Me
4-CF ₃	B7	CN	Cl	Me
4-CF ₃	B3	Cl	Cl	Me
4-CF ₃ CH ₂	B7	Me	Cl	Me
4-Cl ₂ C=CHCH ₂	B8	Cl	Me	Me
4-BrCC	B7	Cl	Cl	Me
4-(2,2-F ₂)cBuCH ₂	B7	CF ₃	Cl	Me
4-(1-Me)cPr	B16	CN	Cl	Me
4-cHex	B7	Cl	Cl	Me
4-(1-Me)cHex	B8	CF ₃	Cl	Me
4-MeO	B7	Cl	H	Me
4-iPrO	B7	Cl	Cl	Me
4-iPrO	B7	CF ₃	Cl	Me
4-iPrO	B15	CF ₃	Cl	Me
4-iPrO	B7	Me	Me	Me
4-iPrO	B16	Me	Me	Me
4-iPrO	B17	Me	Me	Me
4-iPrO	B23	SCF ₃	Cl	Me
4-tBuO	B7	Cl	Cl	Me
4-tBuO	B8	Cl	Cl	Me
4-tBuO	B7	CF ₃	Cl	Me
4-nHexO	B8	CF ₃	Cl	Me
4-nOctO	B34	CF ₃	Cl	Me
4-nDecO	H	CF ₃	Cl	Me
4-CH ₂ =CHCH ₂ O	B7	CF ₃	Cl	Me
4-CHCCH ₂ O	B8	CF ₃	Cl ₃	Me
4-CHF ₂ O	B34	CF ₃	Cl	Me
4-CHF ₂ O	B7	Me	Me	Me
4-CHF ₂ O	B35	Me	Cl	Me
4-CHF ₂ O	B36	Cl	Cl	Me
4-CHF ₂ O	B7	Cl	Cl	Me
4-CBrF ₂ O	B8	Cl	Cl	Me
4-CBrF ₂ O	B34	Cl	Cl	Me
4-CBrF ₂ O	B40	Me	Me	Me
4-CBrF ₂ O	B41	Me	Cl	Me
4-CBrF ₂ O	B42	Cl	Me	Me
4-CBrF ₂ O	B43	Cl	Cl	Me
4-CBrF ₂ O	B44	CF ₃	Cl	Me
4-CBrF ₂ O	COCO ₂ Me	CF ₃	H	Me
4-CBrF ₂ O	H	H	CF ₃	Me
4-CBrF ₂ O	B1	H	Cl	Me

TABLE 11-continued

4-CF ₃ O	B2	Cl	H	Me
4-CF ₃ O	B3	H	H	Me
4-CF ₃ O	B4	OMe	Cl	Me
4-CF ₃ O	B5	SMe	Cl	Me
4-CF ₃ O	B6	SCF ₃	Cl	Me
4-CF ₃ O	B7	Me	Me	Me
4-CF ₃ CH ₂ O	B8	Me	Me	Me
4-CF ₂ =CHCH ₂ CH ₂ O	B9	Me	Cl	Me
4-CCl ₂ =CHCH ₂ O	B10	Cl	Me	Me
4-ClCCCH ₂ O	B11	Cl	Cl	Me
4-MeS	B12	CF ₃	Cl	Me
4-sBuS	H	CF ₃	H	Me
4-EtSO	B3	H	CF ₃	Me
4-MeSO ₂	H	CF ₃	Cl	Me
4-MeSO ₂	B3	CF ₃	Cl	Me
4-MeSO ₂	B32	CF ₃	Cl	Me
4-MeSO ₂	B33	CF ₃	Cl	Me
4-EtSO ₂	H	CF ₃	Cl	Me
4-EtSO ₂	B3	Cl	Cl	Me
4-iPrSO ₂	B32	Cl	Cl	Me
4-iPrSO ₂	B33	Cl	Cl	Me
4-tBuSO ₂	B7	Cl	Cl	Me
4-tBuSO ₂	B33	CF ₃	Cl	Me
4-MeCH=CHCH ₂ S	B15	H	H	Me
4-CH ₂ =CHCH ₂ SO	B16	OMe	Cl	Me
4-CH ₂ =CHCH ₂ SO ₂	B28	SMe	Cl	Me
4-CHCCH ₂ S	B30	SCF ₃	Cl	Me
4-CHCCH ₂ SO	B34	Me	Me	Me
4-CHCCH ₂ SO ₂	CO-nC ₈ H ₁₇	Me	Me	Me
4-CHF ₂ S	H	CF ₃	Cl	Me
4-CHF ₂ S	B7	CF ₃	Cl	Me
4-CHF ₂ S	B8	CF ₃	Cl	Me
4-CHF ₂ S	B15	CF ₃	Cl	Me
4-CHF ₂ S	B29	CF ₃	Cl	Me
4-CHF ₂ S	H	Cl	Cl	Me
4-CHF ₂ S	B7	Cl	Cl	Me
4-CHF ₂ S	B15	Cl	Cl	Me
4-CBrF ₂ S	B7	Cl	Cl	Me
4-CBrF ₂ S	B15	Cl	Cl	Me
4-CBrF ₂ S	B30	Cl	Cl	Me
4-CBrF ₂ S	B43	Cl	Cl	Me
4-CBrF ₂ S	CO-nC ₁₅ H ₃₁	Me	Cl	Me
4-CBrF ₂ S	CO ₂ -nHex	CF ₃	Cl	Me
4-CBrF ₂ S	H	CF ₃	Cl	Me
4-CBrF ₂ S	B7	CF ₃	Cl	Me
4-CBrF ₂ S	B8	CF ₃	Cl	Me
4-CBrF ₂ S	B15	CF ₃	Cl	Me
4-CBrF ₂ S	B28	CF ₃	Cl	Me
4-CBrF ₂ S	B34	CF ₃	Cl	Me
4-CBrF ₂ S	B7	Me	Cl	Me
4-CF ₃ S	CO ₂ -nC ₁₀ H ₂₁	Cl	Cl	Me
4-CF ₃ S	H	Cl	Cl	Me
4-CF ₃ S	B3	Cl	Cl	Me
4-CF ₃ S	B7	Cl	Cl	Me
4-CF ₃ S	B8	Cl	Cl	Me
4-CF ₃ S	B15	Cl	Cl	Me
4-CF ₃ S	H	CF ₃	Cl	Me
4-CF ₃ S	B7	CF ₃	Cl	Me
4-CF ₃ S	B8	CF ₃	Cl	Me
4-CF ₃ S	B15	CF ₃	Cl	Me
4-CF ₃ S	B7	CF ₃	Cl	Me
4-CF ₃ S	B8	CF ₃	Cl	Me
4-CF ₃ S	B34	CF ₃	Cl	Me
4-CF ₃ S	CO ₂ -nC ₁₂ H ₂₅	CF ₃	Cl	Me
4-CF ₃ S	CO-nC ₁₅ H ₃₁	CF ₃	Cl	Me
4-CF ₃ S	CO-nC ₁₆ H ₃₃	Me	Me	Me
4-CF ₃ S	CO-nC ₁₇ H ₃₅	Me	Cl	Me
4-CF ₃ CH ₂ S	CO-nC ₁₈ H ₃₇	CF ₃	Cl	Me
4-CHF ₂ CF ₂ S	CO-nC ₁₉ H ₃₉	CF ₃	H	Me
4-CHF ₂ SO	CO-nC ₂₀ H ₄₁	H	CF ₃	Me
4-CBrF ₂ SO	H	H	Cl	Me
4-CBrF ₂ SO	B3	CF ₃	Cl	Me
4-CBrF ₂ SO	B7	CF ₃	Cl	Me
4-CBrF ₂ SO	B24	CF ₃	Cl	Me
4-CBrF ₂ SO	B32	CF ₃	Cl	Me
4-CBrF ₂ SO	B33	CF ₃	Cl	Me
4-CF ₃ SO	H	Cl	Cl	Me
4-CF ₃ SO	B3	Cl	Cl	Me
4-CF ₃ SO	B7	Cl	Cl	Me
4-CF ₃ SO	B33	Cl	H	Me
4-CF ₃ CH ₂ SO ₂	B15	H	H	Me

TABLE 11-continued

4-CHF ₂ CF ₂ SO ₂	B16	OMe	Cl	Me
4-CHF ₂ SO ₂	B28	SMe	Cl	Me
4-CHF ₂ SO ₂	B7	CF ₃	Cl	Me
4-CHF ₂ SO ₂	B24	CF ₃	Cl	Me
4-CHF ₂ SO ₂	B32	CF ₃	Cl	Me
4-CHF ₂ SO ₂	B33	CF ₃	Cl	Me
4-CHF ₂ SO ₂	H	Cl	Cl	Me
4-CHF ₂ SO ₂	B3	Cl	Cl	Me
4-CHF ₂ SO ₂	B7	Cl	Cl	Me
4-CHF ₂ SO ₂	B33	Cl	H	Me
4-CBrF ₂ SO ₂	H	SCF ₃	Cl	Me
4-CBrF ₂ SO ₂	B2	Cl	Cl	Me
4-CBrF ₂ SO ₂	B3	Cl	Cl	Me
4-CBrF ₂ SO ₂	B18	Cl	Cl	Me
4-CBrF ₂ SO ₂	B19	Cl	Cl	Me
4-CBrF ₂ SO ₂	B33	Cl	Cl	Me
4-CBrF ₂ SO ₂	H	CF ₃	Cl	Me
4-CBrF ₂ SO ₂	B3	CF ₃	Cl	Me
4-CBrF ₂ SO ₂	B7	CF ₃	Cl	Me
4-CBrF ₂ SO ₂	B20	CF ₃	Cl	Me
4-CBrF ₂ SO ₂	B32	CF ₃	Cl	Me
4-CBrF ₂ SO ₂	B33	CF ₃	Cl	Me
4-CBrF ₂ SO ₂	B37	CF ₃	Cl	Me
4-CBrF ₂ SO ₂	B7	Me	Me	Me
4-CBrF ₂ SO ₂	B15	Me	Me	Me
4-CBrF ₂ SO ₂	B17	Me	Me	Me
4-CBrF ₂ SO ₂	B7	Me	Cl	Me
4-CBrF ₂ SO ₂	B16	Me	Cl	Me
4-CF ₃ SO ₂	B16	Me	Me	Me
4-CF ₃ SO ₂	B7	Cl	Cl	Me
4-CF ₃ SO ₂	B15	Cl	Cl	Me
4-CF ₃ SO ₂	B3	CF ₃	Cl	Me
4-CF ₃ SO ₂	B7	CF ₃	Cl	Me
4-CF ₃ SO ₂	B15	Me	Me	Me
4-CF ₃ SO ₂	B7	Me	Cl	Me
4-CF ₃ SO ₂	B8	Me	Cl	Me
4-Cl ₂ C=CHCH ₂ S	B16	Me	Me	Me
4-Cl ₂ C=CHCH ₂ SO	B17	Me	Cl	Me
4-Cl ₂ C=CHCH ₂ SO ₂	B17	Cl	Me	Me
4-CBrCCH ₂ S	CO ₂ -nC ₁₀ H ₂₁	Cl	Cl	Me
4-CBrCCH ₂ SO	B33	CF ₃	Cl	Me
4-CBrCCH ₂ SO ₂	B7	CF ₃	H	Me
4-CHO	B7	H	CF ₃	Me
4-NO ₂	B8	H	Cl	Me
4-CN	B16	Cl	H	Me
4-(Me) ₂ N	B3	H	H	Me
4-Me(MeCO)N	B7	OMe	Cl	Me
4-PhMeN	B8	SMe	Cl	Me
4-PhCH ₂ (MeCO)N	B15	SCF ₃	Cl	Me
4-(1-naphthyl)	B16	Me	Me	Me
4-(2-naphthyl)	B28	Me	Me	Me
4-(2-Cl-Ph)CH ₂ O	B30	Me	Cl	Me
4-(3-Cl-Ph)CH ₂ O	B34	Cl	Me	Me
4-(4-Cl-Ph)CH ₂ O	B7	CF ₃	Cl	Me
4-(4-Cl-Ph)CH ₂ O	B7	Cl	Cl	Me
4-(4-Cl-Ph)CH ₂ O	B37	Cl	Cl	Me
4-(4-F-Ph)CH ₂ O	B42	CF ₃	Cl	Me
4-(2-Me-Ph)CH ₂ O	B43	CF ₃	H	Me
4-(4-Me-Ph)CH ₂ O	B43	H	CF ₃	Me
4-(4-Et-Ph)CH ₂ O	H	H	Cl	Me
3-(2,4-Cl ₂ -Ph)CH ₂ O	B7	Cl	H	Me
4-(3,4-Cl ₂ -Ph)CH ₂ O	B7	H	H	Me
4-(2,5-Me ₂ -Ph)CH ₂ O	B7	OMe	Cl	Me
4-(2,3,4,5,6-F ₅ -Ph)CH ₂ O	B7	SMe	Cl	Me
4-MeOC(O)	B4	SCF ₃	Cl	Me
4-EtOC(O)	B5	Me	Me	Me
4-nPrOC(O)	B6	Me	Me	Me
4-iPrOC(O)	B7	Me	Cl	Me
4-iBuOC(O)	B8	Cl	Me	Me
4-tBuOC(O)	B9	Cl	Cl	Me
4-tBuCH ₂ OC(O)	B7	Cl	Cl	Me
4-tBuCH ₂ OC(O)	B15	Cl	Cl	Me
4-tBuCH ₂ OC(O)	B34	Cl	Cl	Me
4-tBuCH ₂ OC(O)	B7	CF ₃	Cl	Me
4-tBuCH ₂ OC(O)	B15	CF ₃	Cl	Me
4-tBuCH ₂ OC(O)	B34	CF ₃	Cl	Me
4-tBuCH ₂ OC(O)	B10	CF ₃	Cl	Me
4-Et(Me) ₂ COC(O)	B11	CF ₃	H	Me
4-nHexOC(O)	B7	H	CF ₃	Me

TABLE 11-continued

4-MeOCH ₂	B8	H	Cl	Me
4-EtOCH ₂	B7	Cl	H	Me
4-iPrOCH ₂	B7	H	H	Me
4-MeC(O)	B16	OMe	Cl	Me
4-EtC(O)	B7	SMe	Cl	Me
4-iPrC(O)	B8	SCF ₃	Cl	Me
4-tBuC(O)	H	Cl	Cl	Me
4-tBuC(O)	B3	Cl	Cl	Me
4-tBuC(O)	B7	Cl	Cl	Me
4-tBuC(O)	B3	CF ₃	Cl	Me
4-tBuC(O)	B7	CF ₃	Cl	Me
4-tBuC(O)	B15	CF ₃	Cl	Me
4-tBuC(O)	B7	Me	Me	Me
4-tBuC(O)	B17	Me	Me	Me
4-tBuC(O)	B16	Me	Cl	Me
4-CF ₃ C(O)	B7	Me	Me	Me
4-CF ₃ CF ₂ C(O)	B8	Me	Cl	Me
4-CF ₂ CF ₂ CF ₂ C(O)	B22	Cl	Me	Me
4-MeC(O)O	B23	Cl	Cl	Me
4-iPrC(O)O	B7	CF ₃	Cl	Me
4-tBuC(O)O	B8	CF ₃	H	Me
4-CF ₃ C(O)O	B7	H	CF ₃	Me
4-CF ₂ CF ₂ CF ₂ C(O)O	B8	H	Cl	Me
4-Me ₂ NC(O)O	B34	Cl	H	Me
4-Et ₂ NC(O)O	H	H	H	Me
4-(nPr) ₂ NC(O)O	B7	OMe	Cl	Me
3-Ph	B8	SMe	Cl	Me
4-Ph	B34	SCF ₃	Cl	Me
4-(4-F-Ph)	B7	Cl	Cl	Me
4-(4-F-Ph)	B7	CF ₃	Cl	Me
3-PhO	B7	Cl	Cl	Me
3-PhO	B15	CF ₃	Cl	Me
4-PhO	B7	Me	Me	Me
4-(4-F-Ph)O	B35	Me	Cl	Me
4-(4-Cl-Ph)O	B36	Cl	Me	Me
4-(4-Br-Ph)O	B7	Cl	Cl	Me
4-(4-Me-Ph)O	B8	CF ₃	Cl	Me
4-(2-Cl-Ph)O	B34	CF ₃	H	Me
4-(2-F-Ph)O	B40	H	CF ₃	Me
4-(3-Cl-Ph)O	B41	H	Cl	Me
4-(4-Cl-Ph)O	B42	Cl	H	Me
4-(2,4-Cl ₂ -Ph)O	B43	H	H	Me
4-(3,4-Cl ₂ -Ph)O	B44	OMe	Cl	Me
4-(3,4,5-Cl ₃ -Ph)O	COCO ₂ Me	SMe	Cl	Me
4-(2-Me-Ph)O	H	SCF ₃	Cl	Me
4-(4-Me-Ph)O	B1	Me	Me	Me
4-(3-Cl-4-Me-Ph)O	B2	H	CF ₃	Me
4-(2-pyridyl)	B3	H	Cl	Me
4-(5-CF ₃ -pyridin-2-yl)	B4	Cl	H	Me
4-(2-pyridyl)O	B7	Cl	Cl	Me
4-(2-pyridyl)O	B15	Cl	Cl	Me
4-(2-pyridyl)O	B7	CF ₃	Cl	Me
4-(2-pyridyl)O	B8	CF ₃	Cl	Me
4-(2-pyridyl)O	B34	CF ₃	Cl	Me
4-(2-pyridyl)O	B5	Cl	Cl	Me
4-(5-CF ₃ -pyridin-2-yl)O	B7	Cl	Cl	Me
4-(5-CF ₃ -pyridin-2-yl)O	B8	Cl	Cl	Me
4-(5-CF ₃ -pyridin-2-yl)O	B15	CF ₃	Cl	Me
4-(5-CF ₃ -pyridin-2-yl)O	B7	CF ₃	Cl	Me
4-(5-CF ₃ -pyridin-2-yl)O	B15	CF ₃	Cl	Me
4-(5-CF ₃ -pyridin-2-yl)O	B34	Me	Cl	Me
4-(3-Cl-5-CF ₃ -pyridin-2-yl)	B7	Cl	Cl	Me
4-(3-Cl-5-CF ₃ -pyridin-2-yl)	B15	Cl	Cl	Me
4-(3-Cl-5-CF ₃ -pyridin-2-yl)	B34	Cl	Cl	Me
4-(3-Cl-5-CF ₃ -pyridin-2-yl)	B7	CF ₃	Cl	Me
4-(3-Cl-5-CF ₃ -pyridin-2-yl)	B15	CF ₃	Cl	Me
4-(3-Cl-5-CF ₃ -pyridin-2-yl)	B17	CF ₃	Cl	Me
4-(3-Cl-5-CF ₃ -pyridin-2-yl)	H	Cl	Cl	Me
4-(5-Cl-thiophen-2-yl)	B8	Cl	Cl	Me
3-OCH ₂ O-4	B9	Cl	Cl	Me
4-OCF ₂ O-4	B10	CF ₃	Cl	Me
4-MeCH=N	B11	CF ₃	Cl	Me
4-Me ₂ C=N	B12	CF ₃	Cl	Me
4-MeEtC=N	H	Cl	Cl	Me
4-PhCH=N	B3	Cl	Cl	Me
4-PhMeC=N	B7	Cl	Cl	Me
4-PhCH ₂ CH=N	B8	CF ₃	Cl	Me
4-cC ₆ H ₁₀ =N	B15	CF ₃	Cl	Me
3-CH ₂ CH ₂ CH ₂ -4	B16	CF ₃	Cl	Me

TABLE 11-continued

3-CH ₂ CH ₂ CH ₂ CH ₂ -4	B28	Cl	Cl	Me
4-PhC(O)	H	Cl	Cl	Me
4-PhC(O)	B7	Cl	Cl	Me
4-PhC(O)	B7	Cl	Cl	Me
4-PhC(O)	B33	CF ₃	Cl	Me
4-(2-Cl—Ph)C(O)	B7	CF ₃	Cl	Me
4-(4-F—Ph)C(O)	H	CF ₃	Cl	Me
4-(4-Cl—Ph)C(O)	B7	Cl	Cl	Me
4-(4-Cl—Ph)C(O)	B15	Cl	Cl	Me
4-(4-Cl—Ph)C(O)	B34	Cl	Cl	Me
4-(4-Me—Ph)C(O)	B3	CF ₃	Cl	Me
4-(4-Me—Ph)C(O)	B16	CF ₃	Cl	Me
4-(3,4-Cl ₂ —Ph)C(O)	B45	CF ₃	Cl	Me
3,4-Cl ₂	B15	Cl	Cl	Me
3-Cl-4-F	B7	Cl	Cl	Me
2,6-F ₂	B15	CF ₃	Cl	Me
3-Cl-4-CF ₃	B7	CF ₃	Cl	Me
4-tBu-3-Cl	B7	Cl	Cl	Me
4-tBu-3-Cl	B15	CF ₃	Cl	Me
4-tBuCH ₂ -3-Cl	B7	Cl	Cl	Me
4-nHep-3-Cl	B15	CF ₃	Cl	Me
3-Cl-4-iPrO	B7	Cl	Cl	Me
3-Cl-4-iPrO	B7	CF ₃	Cl	Me
3-Cl-4-nHepO	B15	CF ₃	Cl	Me
3-Cl-4-(3,4-Cl ₂ —PhCH ₂)O	H	CF ₃	Cl	Me
3-Cl-4-PhCH ₂ O	B7	CF ₃	Cl	Me
3,4-(MeO) ₂	B16	CF ₃	Cl	Me
4-MeO-3-Me	B17	CF ₃	Cl	Me
4-OH-3,5-(tBu) ₂	B3	CF ₃	Cl	Me
3,4,5-Cl ₃	B15	CF ₃	Cl	Me
2,6-Cl ₂ -4-CF ₃	B7	CF ₃	Cl	Me
2,6-F ₂ -4-CF ₃	B15	Cl	Cl	Me
2,6-F ₂ -4-CF ₃ O	B7	CF ₃	Cl	Me
3,5-Cl ₂ -4-tBu	B7	Cl	Cl	Me
3,5-Cl ₂ -4-tBuCH ₂	B15	CF ₃	Cl	Me
3,5-Cl ₂ -4-nDec	B7	Cl	Cl	Me
3,5-Cl ₂ -4-PhCH ₂ O	B15	CF ₃	Cl	Me
2,3,5,6-F ₄ -4-Me	B3	CF ₃	Cl	Me
2,3,4,5,6-F ₅	B33	CF ₃	Cl	Me

TABLE 12

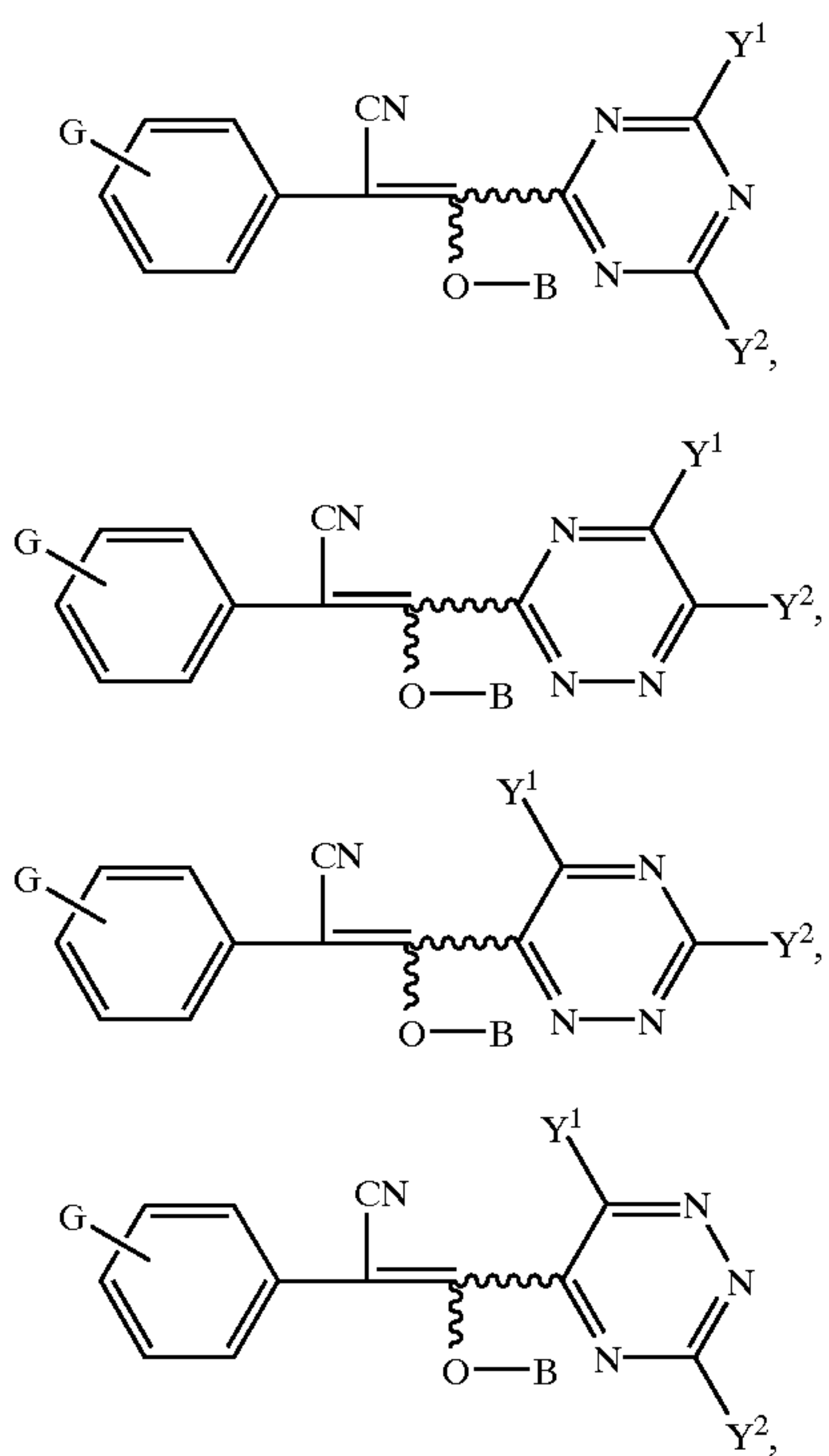
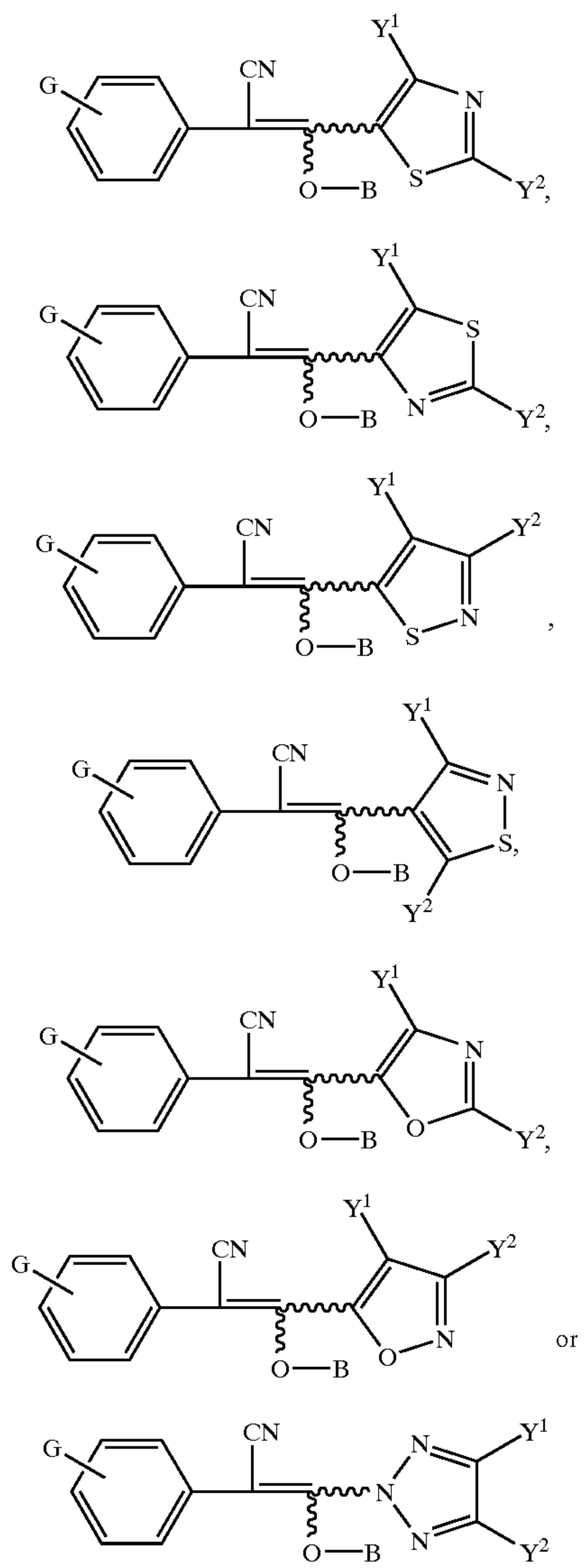

TABLE 12-continued



G	B	Y ¹	Y ²
2-Cl	H	Me	Me
3-Cl	B1	H	H
4-Cl	B2	Me	H
4-Br	B3	H	Me
4-I	B4	Me	Me
4-F	B5	CF ₃	Me
4-Me	B6	Cl	Me
4-Et	B7	H	Me
4-iPr	B8	Cl	Me
4-nBu	B9	H	Me
4-iBu	B10	OMe	Me
4-sBu	B11	SMe	Me
4-sBu	H	Me	Me
4-sBu	B16	Et	Me
4-sBu	B17	Cl	Me
4-sBu	B7	Cl	Cl
4-sBu	B8	CF ₃	Me
4-sBu	B16	Me	CF ₃
4-sBu	B17	Me	Me
4-sBu	B34	CF ₃	Me
4-sBu	B3	CF ₃	Me
4-sBu	B7	CF ₃	Me
4-sBu	B8	Cl	Me
4-sBu	B34	Me	Cl

TABLE 12-continued

4-sBu	B7	H	H
4-sBu	B17	CF ₃	Me
4-tBu	B12	SCF ₃	Me
4-tBu	H	Me	Me
4-tBu	B3	Me	Me
4-tBu	B7	Me	Me
4-tBu	B8	Et	Me
4-tBu	B15	Me	nPr
4-tBu	B16	OMe	OMe
4-tBu	B28	Cl	Cl
4-tBu	B30	OCHF ₂	Me
4-tBu	B34	CF ₃	CF ₃
4-tBu	CO-nC ₈ H ₁₇	H	H
4-tBu	CO-nC ₁₅ H ₃₁	Cl	Cl
4-tBu	CO ₂ -nHex	Me	Me
4-tBu	CO ₂ -nC ₁₀ H ₂₁	Me	Me
4-tBu	H	CN	Me
4-tBu	H	CF ₃	Me
4-tBu	B3	CF ₃	Me
4-tBu	B7	CF ₃	Me
4-tBu	B8	CF ₃	Me
4-tBu	B15	CF ₃	Me
4-tBu	B16	CF ₃	Me
4-tBu	B28	CF ₃	Me
4-tBu	B30	CF ₃	Me
4-tBu	B16	Cl	Cl
4-tBu	B16	CF ₃	Me
4-tBu	B17	CF ₃	Me
4-tBu	B17	Me	Me
4-tBu	CO ₂ -nC ₁₀ H ₂₁	CF ₃	Me
4-tBu	CH ₂ OEt	CF ₃	Me
4-tBu	B7	Me	CF ₃
4-tBu	B7	Cl	Cl
4-tBu	B7	CN	Me
4-tBu	B16	CN	Me
4-tBu	B3	CN	Me
4-tBu	2-(4-tBu-Ph)- 3,3-Me ₂ -cPrC(O)	CF ₃	Me
4-tBu	B45	CF ₃	Me
4-tBuCH ₂	B3	CF ₃	Me
4-tBuCH ₂	B7	Me	Me
4-tBuCH ₂	B16	Me	Me
4-tBuCH ₂	B7	CF ₃	Me
4-tBuCH ₂	B8	CF ₃	Me
4-tBuCH ₂	B7	Cl	Me
4-Et(Me) ₂ C	H	CF ₃	Me
4-Et(Me) ₂ C	B3	CF ₃	Me
4-Et(Me) ₂ C	B7	CF ₃	Me
4-Et(Me) ₂ C	B8	CF ₃	Me
4-Et(Me) ₂ C	B34	CF ₃	Me
4-Et(Me) ₂ C	B42	CF ₃	Me
4-Et(Me) ₂ C	B16	CF ₃	Me
4-Et(Me) ₂ C	B17	CF ₃	Me
4-Et(Me) ₂ C	H	Cl	Me
4-Et(Me) ₂ C	B7	Cl	Me
4-Et(Me) ₂ C	B8	Cl	Me
4-Et(Me) ₂ C	B7	Me	CF ₃
4-Et(Me) ₂ C	B7	CN	Me
4-Et(Me) ₂ C	B4	H	Me
4-Et(Me) ₂ C	B5	Me	Me
4-Et(Me) ₂ C	B6	Me	Me
4-Et(Me) ₂ C	B3	Me	Cl
4-Et(Me) ₂ C	B16	Me	Cl
4-Et(Me) ₂ C	B17	Me	Cl
4-Et(Me) ₂ C	B24	Me	Cl
4-nHex	B34	CF ₃	Me
4-nHep	B42	CF ₃	Me
4-nOct	B43	Me	Me
4-nNon	B43	Me	Me
4-nDec	H	Cl	Me
4-(Me) ₂ (CN)C	B7	Cl	Me
4-PhCH ₂	B7	CF ₃	Me
4-Ph(Me) ₂ C	B7	CF ₃	Me
4-(4-F-Ph)(Me) ₂ C	B7	CN	Me
4-MeCH=CH	B4	H	Me
4-MeCC	B5	Cl	Me
3-CF ₃	B6	H	Me
4-CF ₃	B7	OMe	Me
4-CF ₃	B8	SMe	Me

TABLE 12-continued

4-CF ₃	B9	SCF ₃	Me
4-CF ₃	B16	Me	Me
4-CF ₃	B17	Me	Me
4-CF ₃	B16	Me	Me
4-CF ₃	B17	Cl	Me
4-CF ₃	B7	Cl	Me
4-CF ₃	B7	CF ₃	Me
4-CF ₃	B7	Me	Me
4-CF ₃	B3	Cl	Me
4-CF ₃ CH ₂	B7	Me	Me
4-Cl ₂ C=CHCH ₂	B8	Cl	Me
4-BrCC	B7	Cl	Me
4-(2,2-F ₂)cBuCH ₂	B7	CF ₃	Me
4-(1-Me)cPr	B16	CN	Me
4-cHex	B7	CF ₃	Me
4-(1-Me)cHex	B8	CF ₃	Me
4-MeO	B7	CF ₃	Me
4-iPrO	B7	Cl	Me
4-iPrO	B7	CF ₃	Me
4-iPrO	B15	CF ₃	Me
4-iPrO	B7	Me	Me
4-iPrO	B16	Me	Me
4-iPrO	B17	Me	Me
4-iPrO	B23	SCF ₃	Me
4-tBuO	B7	Me	Me
4-tBuO	B8	CF ₃	Me
4-tBuO	B7	CF ₃	Me
4-nHexO	B8	CF ₃	Me
4-nOctO	B34	CF ₃	Me
4-nDecO	H	CF ₃	Me
4-CH ₂ =CHCH ₂ O	B7	CF ₃	Me
4-CHCCH ₂ O	B8	CF ₃	Me
4-CHF ₂ O	B34	CF ₃	Me
4-CHF ₂ O	B7	Et	Me
4-CHF ₂ O	B35	Me	Me
4-CHF ₂ O	B36	Cl	Me
4-CHF ₂ O	B7	CF ₃	Me
4-CBrF ₂ O	B8	Cl	Me
4-CBrF ₂ O	B34	Cl	Me
4-CBrF ₂ O	B40	Me	Me
4-CBrF ₂ O	B41	Me	Me
4-CBrF ₂ O	B42	Cl	Me
4-CBrF ₂ O	B7	CF ₃	Me
4-CBrF ₂ O	B8	CF ₃	Me
4-CBrF ₂ O	COCO ₂ Me	CF ₃	Me
4-CBrF ₂ O	H	H	Me
4-CBrF ₂ O	B1	CF ₃	Me
4-CF ₃ O	B2	Cl	Me
4-CF ₃ O	B3	H	Me
4-CF ₃ O	B4	OMe	Me
4-CF ₃ O	B5	SMe	Me
4-CF ₃ O	B6	SCF ₃	Me
4-CF ₃ O	B7	CF ₃	Me
4-CF ₃ CH ₂ O	B8	Me	Me
4-CF ₂ =CHCH ₂ CH ₂ O	B9	Me	Me
4-CCl ₂ =CHCH ₂ O	B10	Cl	Me
4-ClCCCH ₂ O	B11	Cl	Me
4-MeS	B12	CF ₃	Me
4-sBuS	H	CF ₃	Me
4-EtSO	B3	H	Me
4-MeSO ₂	H	CF ₃	Me
4-MeSO ₂	B3	CF ₃	Me
4-MeSO ₂	B32	CF ₃	Me
4-MeSO ₂	B33	CF ₃	Me
4-EtSO ₂	H	CF ₃	Me
4-EtSO ₂	B3	Et	Me
4-iPrSO ₂	B32	CF ₃	Me
4-iPrSO ₂	B33	CF ₃	Me
4-tBuSO ₂	B7	CF ₃	Me
4-tBuSO ₂	B33	CF ₃	Me
4-MeCH=CHCH ₂ S	B15	H	Me
4-CH ₂ =CHCH ₂ SO	B16	OMe	Me
4-CH ₂ =CHCH ₂ SO ₂	B28	SMe	Me
4-CHCCH ₂ S	B30	SCF ₃	Me
4-CHCCH ₂ SO	B34	Me	Me
4-CHCCH ₂ SO ₂	CO-nC ₈ H ₁₇	Me	Me
4-CHF ₂ S	H	CF ₃	Me
4-CHF ₂ S	B7	CF ₃	Me
4-CHF ₂ S	B8	CF ₃	Me

TABLE 12-continued

4-CHF ₂ S	B15	CF ₃	Me
4-CHF ₂ S	B29	CF ₃	Me
4-CHF ₂ S	H	Me	Me
4-CHF ₂ S	B7	Me	Me
4-CHF ₂ S	B15	Me	Me
4-CBrF ₂ S	B7	Me	CF ₃
4-CBrF ₂ S	B15	Me	CF ₃
4-CBrF ₂ S	B30	Me	CF ₃
4-CBrF ₂ S	B43	Me	CF ₃
4-CBrF ₂ S	CO-nC ₁₅ H ₃₁	nPr	Me
4-CBrF ₂ S	CO ₂ -nHex	CF ₃	Me
4-CBrF ₂ S	H	CF ₃	Me
4-CBrF ₂ S	B7	CF ₃	Me
4-CBrF ₂ S	B8	CF ₃	Me
4-CBrF ₂ S	B15	CF ₃	Me
4-CBrF ₂ S	B28	CF ₃	Me
4-CBrF ₂ S	B34	CF ₃	Me
4-CBrF ₂ S	B7	Me	Me
4-CF ₃ S	CO ₂ -nC ₁₀ H ₂₁	Cl	Me
4-CF ₃ S	H	Me	Me
4-CF ₃ S	B3	Me	Me
4-CF ₃ S	B7	Me	Me
4-CF ₃ S	B8	Me	Me
4-CF ₃ S	B15	Me	Me
4-CF ₃ S	H	CF ₃	Me
4-CF ₃ S	B7	CF ₃	Me
4-CF ₃ S	B8	CF ₃	Me
4-CF ₃ S	B15	CF ₃	Me
4-CF ₃ S	B34	CF ₃	Me
4-CF ₃ S	CO ₂ -nC ₁₂ H ₂₅	CF ₃	Me
4-CF ₃ S	CO-nC ₁₅ H ₃₁	CF ₃	Me
4-CF ₃ S	CO-nC ₁₆ H ₃₃	Me	Me
4-CF ₃ S	CO-nC ₁₇ H ₃₅	Me	Me
4-CF ₃ S	CO-nC ₁₈ H ₃₇	CF ₃	Me
4-CHF ₂ CF ₂ S	CO-nC ₁₉ H ₃₉	CF ₃	Me
4-CHF ₂ SO	CO-nC ₂₀ H ₄₁	Cl	Cl
4-CBrF ₂ SO	H	H	Me
4-CBrF ₂ SO	B3	CF ₃	Me
4-CBrF ₂ SO	B7	CF ₃	Me
4-CBrF ₂ SO	B24	CF ₃	Me
4-CBrF ₂ SO	B32	CF ₃	Me
4-CBrF ₂ SO	B33	CF ₃	Me
4-CF ₃ SO	H	Me	Me
4-CF ₃ SO	B3	Me	Me
4-CF ₃ SO	B7	Me	Me
4-CF ₃ SO	B33	Me	Me
4-CF ₃ CH ₂ SO ₂	B15	H	Me
4-CHF ₂ CF ₂ SO ₂	B16	OMe	Me
4-CHF ₂ SO ₂	B28	SMe	Me
4-CHF ₂ SO ₂	B7	CF ₃	Me
4-CHF ₂ SO ₂	B24	CF ₃	Me
4-CHF ₂ SO ₂	B32	CF ₃	Me
4-CHF ₂ SO ₂	B33	CF ₃	Me
4-CHF ₂ SO ₂	H	Me	Me
4-CHF ₂ SO ₂	B3	Me	Me
4-CHF ₂ SO ₂	B7	Me	Me
4-CHF ₂ SO ₂	B33	Me	Me
4-CBrF ₂ SO ₂	H	SCF ₃	Me
4-CBrF ₂ SO ₂	B2	Me	Me
4-CBrF ₂ SO ₂	B3	Me	Me
4-CBrF ₂ SO ₂	B18	Me	Me
4-CBrF ₂ SO ₂	B19	Me	Me
4-CBrF ₂ SO ₂	B33	Me	Me
4-CBrF ₂ SO ₂	H	CF ₃	Me
4-CBrF ₂ SO ₂	B3	CF ₃	Me
4-CBrF ₂ SO ₂	B7	CF ₃	Me
4-CBrF ₂ SO ₂	B20	CF ₃	Me
4-CBrF ₂ SO ₂	B32	CF ₃	Me
4-CBrF ₂ SO ₂	B33	CF ₃	Me
4-CBrF ₂ SO ₂	B37	CF ₃	Me
4-CBrF ₂ SO ₂	B7	Me	CF ₃
4-CBrF ₂ SO ₂	B15	Me	CF ₃
4-CBrF ₂ SO ₂	B17	Me	CF ₃
4-CBrF ₂ SO ₂	B7	Me	CF ₃
4-CBrF ₂ SO ₂	B16	Me	CF ₃
4-CF ₃ SO ₂	B16	Me	Me
4-CF ₃ SO ₂	B7	Cl	Me
4-CF ₃ SO ₂	B15	Cl	Cl
4-CF ₃ SO ₂	B3	CF ₃	Me

TABLE 12-continued

4-CF ₃ SO ₂	B7	CF ₃	Me
4-CF ₃ SO ₂	B15	Me	Me
5 4-CF ₃ SO ₂	B7	Me	Me
4-CF ₃ SO ₂	B8	Me	Me
4-Cl ₂ C=CHCH ₂ S	B16	Me	Me
4-Cl ₂ C=CHCH ₂ SO	B17	Me	Me
4-Cl ₂ C=CHCH ₂ SO ₂	B17	Cl	Me
4-CBrCCH ₂ S	CO ₂ -nC ₁₀ H ₂₁	Cl	Me
10 4-CBrCCH ₂ SO	B33	CF ₃	Me
4-CBrCCH ₂ SO ₂	B7	CF ₃	Me
4-CHO	B7	H	Me
4-NO ₂	B8	H	Me
4-CN	B16	Cl	Me
4-(Me) ₂ N	B3	H	Me
15 4-Me(MeCO)N	B7	OMe	Me
4-PhMeN	B8	SMe	Me
4-PhCH ₂ (MeCO)N	B15	SCF ₃	Me
4-(1-naphthyl)	B16	Me	Me
4-(2-naphthyl)	B28	Me	Me
4-(2-Cl-Ph)CH ₂ O	B30	Me	Me
20 4-(3-Cl-Ph)CH ₂ O	B34	Cl	Me
4-(4-Cl-Ph)CH ₂ O	B7	CF ₃	Me
4-(4-Cl-Ph)CH ₂ O	B7	Cl	Me
4-(4-Cl-Ph)CH ₂ O	B37	Cl	Me
4-(4-F-Ph)CH ₂ O	B42	CF ₃	Me
4-(2-Me-Ph)CH ₂ O	B43	CF ₃	Me
4-(4-Me-Ph)CH ₂ O	B43	CF ₃	Me
25 4-(4-Et-Ph)CH ₂ O	H	CF ₃	Me
3-(2,4-Cl ₂ -Ph)CH ₂ O	B7	CF ₃	Me
4-(3,4-Cl ₂ -Ph)CH ₂ O	B7	H	Me
4-(2,5-Me ₂ -Ph)CH ₂ O	B7	OMe	Me
4-(2,3,4,5,6-F ₅ -Ph)CH ₂ O	B7	SMe	Me
4-MeOC(O)	B4	SCF ₃	Me
30 4-EtOC(O)	B5	Me	Me
4-nPrOC(O)	B6	Me	Me
4-iPrOC(O)	B7	Me	Me
4-tBuOC(O)	B7	Me	Me
4-tBuOC(O)	B3	CF ₃	Me
4-tBuOC(O)	B5	CF ₃	Me
35 4-tBuOC(O)	B33	CF ₃	Me
4-tBuOC(O)	H	CF ₃	Me
4-tBuOC(O)	B7	CF ₃	Me
4-tBuOC(O)	B8	CF ₃	Me
4-tBuOC(O)	B34	CF ₃	Me
4-tBuCH ₂ OC(O)	B10	CF ₃	Me
40 4-Et(Me) ₂ COC(O)	B11	CF ₃	Me
4-nHexOC(O)	B7	H	Me
4-MeOCH ₂	B8	H	Me
4-EtOCH ₂	B7	Cl	Me
4-iPrOCH ₂	B7	H	Me
4-MeC(O)	B16	OMe	Me
4-EtC(O)	B7	SMe	Me
45 4-iPrC(O)	B8	SCF ₃	Me
4-tBuC(O)	H	Cl	Cl
4-tBuC(O)	B3	Cl	Cl
4-tBuC(O)	B7	Cl	Cl
4-tBuC(O)	B3	CF ₃	Me
4-tBuC(O)	B7	CF ₃	Me
4-tBuC(O)	B15	CF ₃	Me
4-tBuC(O)	B7	Me	Me
4-tBuC(O)	B17	Me	Me
4-tBuC(O)	B16	Me	Me
4-CF ₃ C(O)	B33	Me	Me
4-CF ₃ CF ₂ C(O)	B8	Me	Me
55 4-CF ₂ CF ₂ CF ₂ C(O)	B22	Cl	Me
4-MeC(O)O	B23	Cl	Me
4-iPrC(O)O	B7	CF ₃	Me
4-tBuC(O)O	B8	CF ₃	Me
4-CF ₃ C(O)O	B7	H	Me
4-CF ₂ CF ₂ CF ₂ C(O)O	B8	H	Me
4-Me ₂ NC(O)O	B34	Cl	Me
60 4-Et ₂ NC(O)O	H	H	Me
4-(nPr) ₂ NC(O)O	B7	OMe	Me
3-Ph	B8	SMe	Me
4-Ph	B34	SCF ₃	Me
4-(4-F-Ph)	B7	Et	Me
4-(4-F-Ph)	B7	CF ₃	Me
65 3-PhO	B7	Me	Me
3-PhO	B15	CF ₃	Me

TABLE 12-continued

4-PhO	B7	Me	Me
4-(4-F—Ph)O	B35	Me	Me
4-(4-Cl—Ph)O	B36	Et	Me
4-(4-Br—Ph)O	B7	CF ₃	Me
4-(4-Me—Ph)	B8	CF ₃	Me
4-(2-Cl—Ph)O	B34	CF ₃	Me
4-(2-F—Ph)O	B40	H	Me
4-(3-Cl—Ph)O	B41	H	Me
4-(4-Cl—Ph)O	B42	Cl	Me
4-(2,4-Cl ₂ —Ph)O	B43	H	Me
4-(3,4-Cl ₂ —Ph)O	B44	OMe	Me
4-(3,4,5-Cl ₃ —Ph)O	COCO ₂ Me	SMe	Me
4-(2-Me—Ph)O	H	SCF ₃	Me
4-(4-Me—Ph)O	B1	Me	Me
4-(3-Cl-4-Me—Ph)O	B2	H	Me
4-(2-pyridyl)	B3	H	Me
4-(5-CF ₃ -pyridin-2-yl)	B4	Cl	Me
4-(2-pyridyl)O	B7	Me	Me
4-(2-pyridyl)O	B15	Me	Me
4-(2-pyridyl)O	B7	CF ₃	Me
4-(2-pyridyl)O	B8	CF ₃	Me
4-(2-pyridyl)O	B34	CF ₃	Me
4-(2-pyridyl)O	B5	CF ₃	Me
4-(5-CF ₃ -pyridin-2-yl)O	B7	Me	Me
4-(5-CF ₃ -pyridin-2-yl)O	B8	Me	Me
4-(5-CF ₃ -pyridin-2-yl)O	B15	CF ₃	Me
4-(5-CF ₃ -pyridin-2-yl)O	B7	CF ₃	Me
4-(5-CF ₃ -pyridin-2-yl)O	B15	CF ₃	Me
4-(5-CF ₃ -pyridin-2-yl)O	B34	CF ₃	Me
4-(3-Cl-5-CF ₃ -pyridin-2-yl)	B7	Me	Me
4-(3-Cl-5-CF ₃ -pyridin-2-yl)	B15	Me	Me
4-(3-Cl-5-CF ₃ -pyridin-2-yl)	B34	Me	Me
4-(3-Cl-5-CF ₃ -pyridin-2-yl)	B7	CF ₃	Me
4-(3-Cl-5-CF ₃ -pyridin-2-yl)	B15	CF ₃	Me
4-(3-Cl-5-CF ₃ -pyridin-2-yl)	B17	CF ₃	Me
4-(3-Cl-5-CF ₃ -pyridin-2-yl)	H	CF ₃	Me
4-(5-Cl-thiophen-2-yl)	B8	Cl	Me
3-OCH ₂ O-4	B9	Cl	Me
4-OCF ₂ O-4	B10	CF ₃	Me
4-MeCH=N	B11	CF ₃	Me
4-Me ₂ C=N	B12	CF ₃	Me
4-MeEtC=N	H	Cl	Me
4-PhCH=N	B3	Cl	Me
4-PhMeC=N	B7	Cl	Me
4-PhCH ₂ CH=N	B8	CF ₃	Me
4-cC ₆ H ₁₀ =N	B15	CF ₃	Me
3-CH ₂ CH ₂ CH ₂ -4	B16	CF ₃	Me
3-CH ₂ CH ₂ CH ₂ CH ₂ -4	B28	Cl	Me
4-PhC(O)	H	CF ₃	Me
4-PhC(O)	B7	Et	Me
4-PhC(O)	B7	CF ₃	Me
4-PhC(O)	B33	CF ₃	Me
4-(2-Cl—Ph)C(O)	B7	CF ₃	Me
4-(4-F—Ph)C(O)	H	CF ₃	Me
4-(4-Cl—Ph)C(O)	B7	CF ₃	Me
4-(4-Cl—Ph)C(O)	B15	CF ₃	Me
4-(4-Cl—Ph)C(O)	B34	CF ₃	Me
4-(4-Me—Ph)C(O)	B3	CF ₃	Me
4-(4-Me—Ph)C(O)	B16	CF ₃	Me
4-(3,4-Cl ₂ —Ph)C(O)	B45	CF ₃	Me
2,4-Cl ₂	B7	CF ₃	Me
3,4-Cl ₂	B7	CF ₃	Me
4-Cl-2-F	B7	CF ₃	Me
3-Cl-4-nHex	B7	CF ₃	Me
4-tBu-3-Cl	B7	CF ₃	Me
4-tBu-3-Cl	B15	CF ₃	Me
3-Cl-4-iPrO	B7	Me	Me
3-Cl-4-iPrO	B7	CF ₃	Me
3-Cl-4-nHepO	B15	CF ₃	Me
3-Cl-4-(3,4-Cl ₂ —PhCH ₂)O	H	CF ₃	Me
3-Cl-4-PhCH ₂ O	B7	CF ₃	Me
3-Cl-4-Me ₃ CCH ₂	B7	CF ₃	Me
3,4-(MeO) ₂	B7	CF ₃	Me
4-MeO-3-Me	B17	CF ₃	Me
4-OH-3,5-(tBu) ₂	B3	CF ₃	Me
3,4,5-Cl ₃	B15	CF ₃	Me
3,5-Cl ₂ -4-F	B7	CF ₃	Me
4-Cl-2,6-F ₂	B7	CF ₃	Me
2,6-F ₂ -4-CF ₃	B7	CF ₃	Me

TABLE 12-continued

2,6-F ₂ -4-CF ₃ O	B7	CF ₃	Me
5 3,5-Cl ₂ -4-nOct	B7	CF ₃	Me
3,5-Cl ₂ -4-PhCH ₂ O	B15	CF ₃	Me
2,3,5,6-F ₄ -4-Me	B3	CF ₃	Me
2,3,4,5,6-F ₅	B33	CF ₃	Me

TABLE 13

15	
20	
25	
30	
35	
40	
45	
50	
55	
60	
65	

TABLE 13-continued

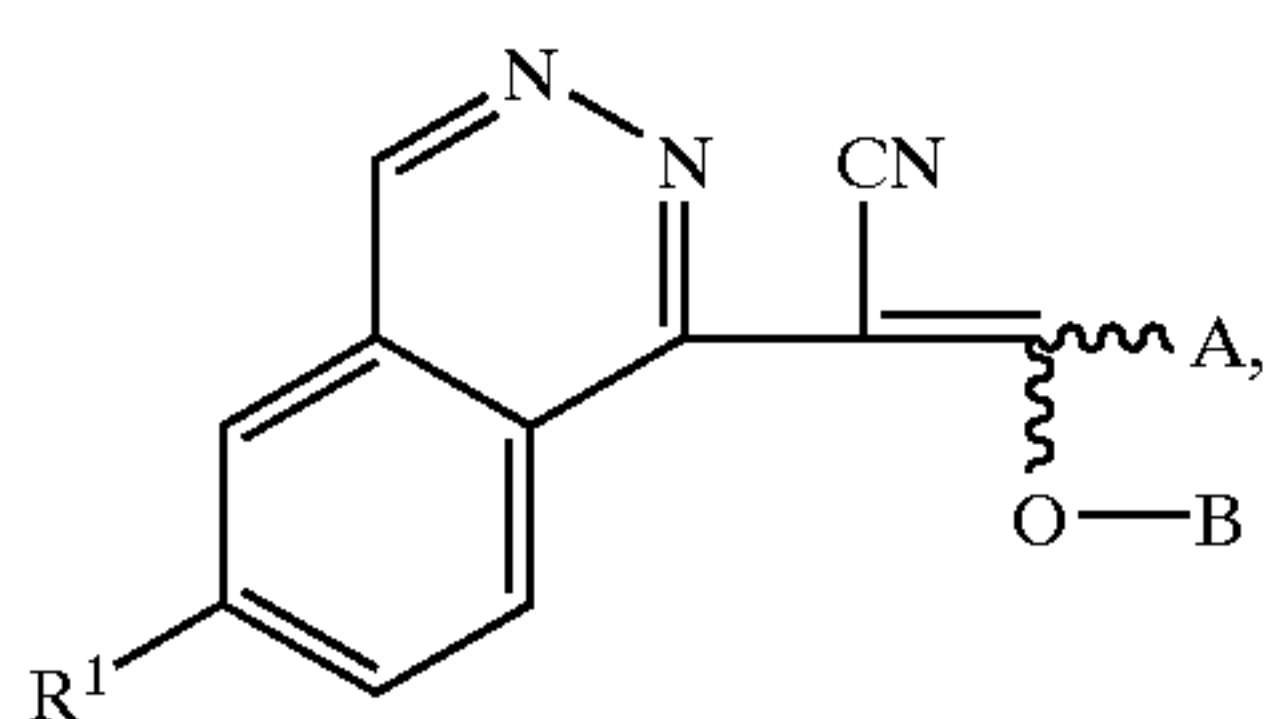
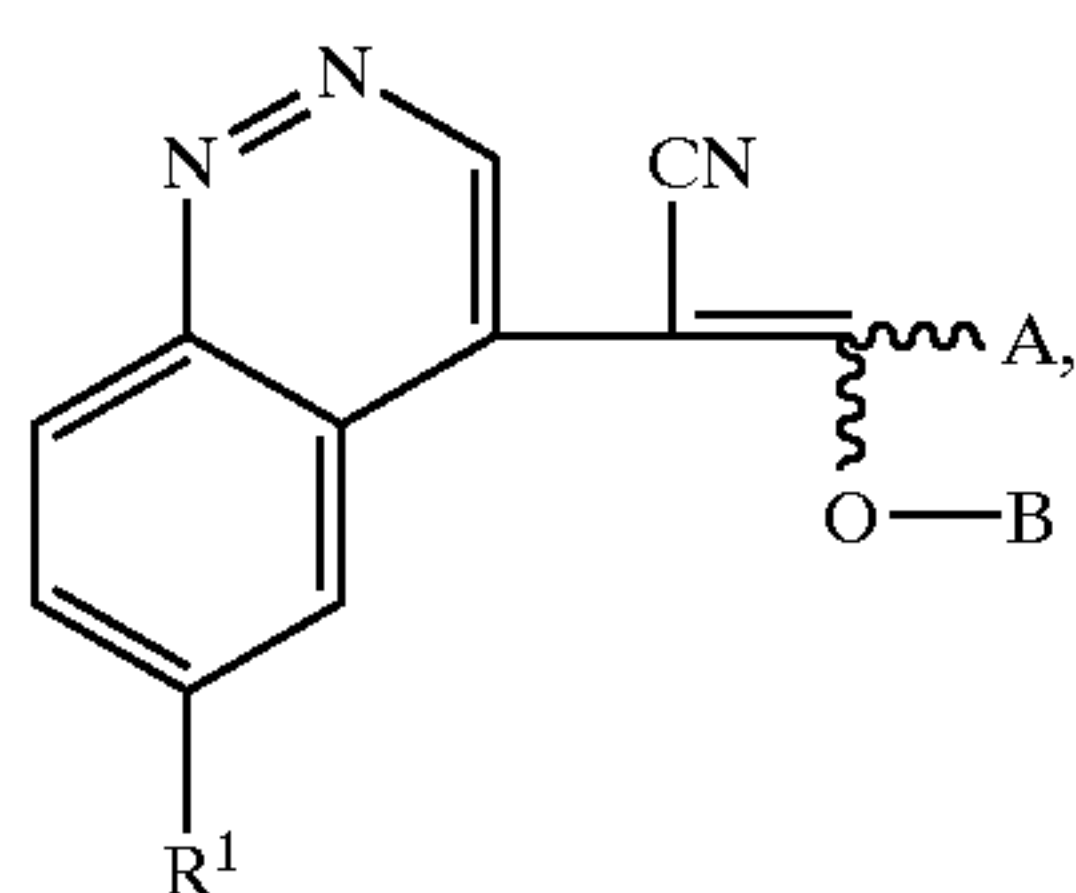
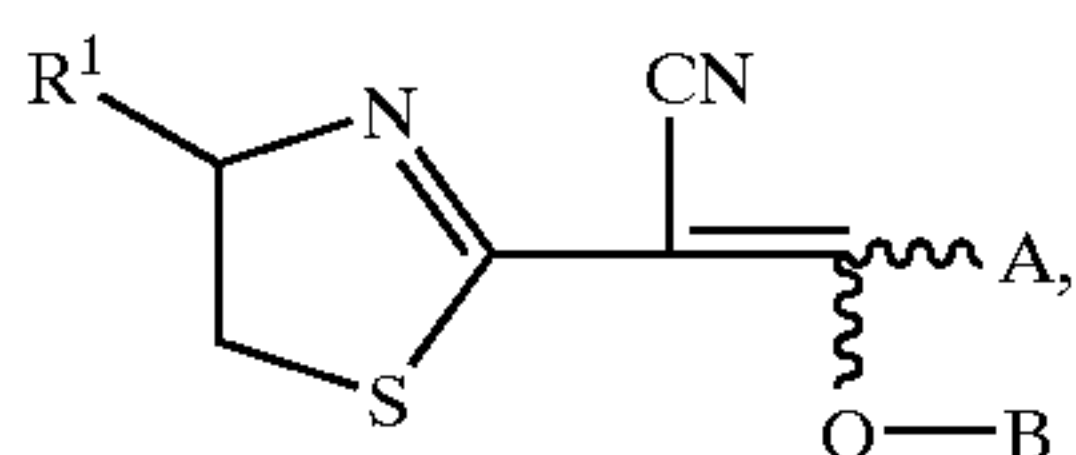
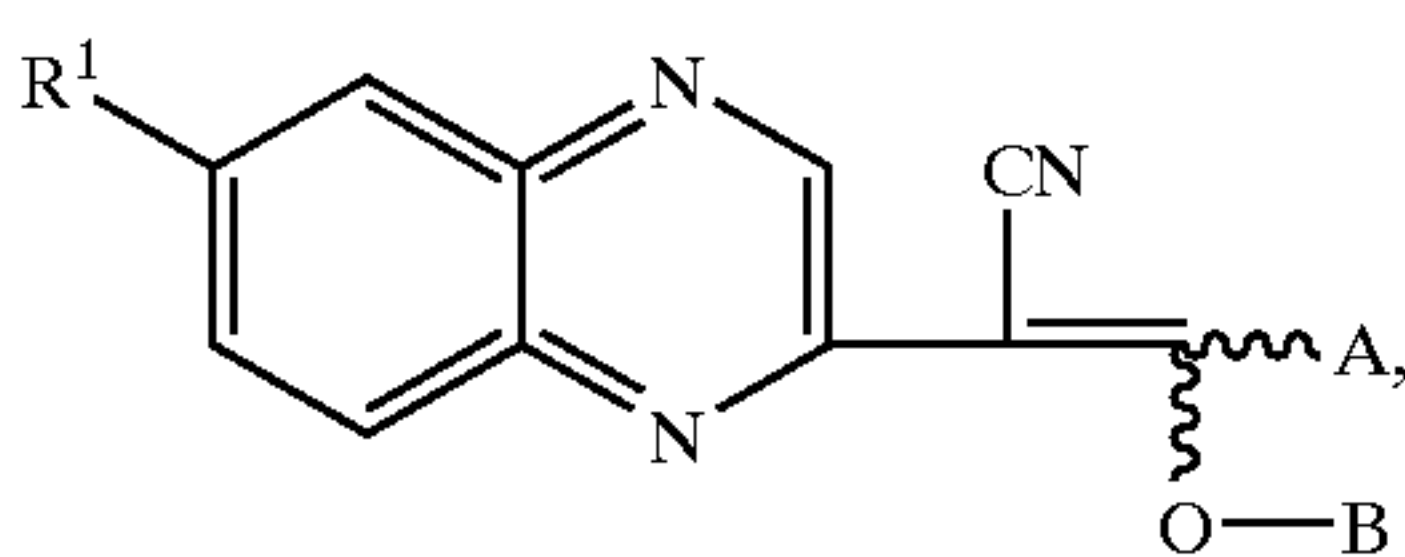
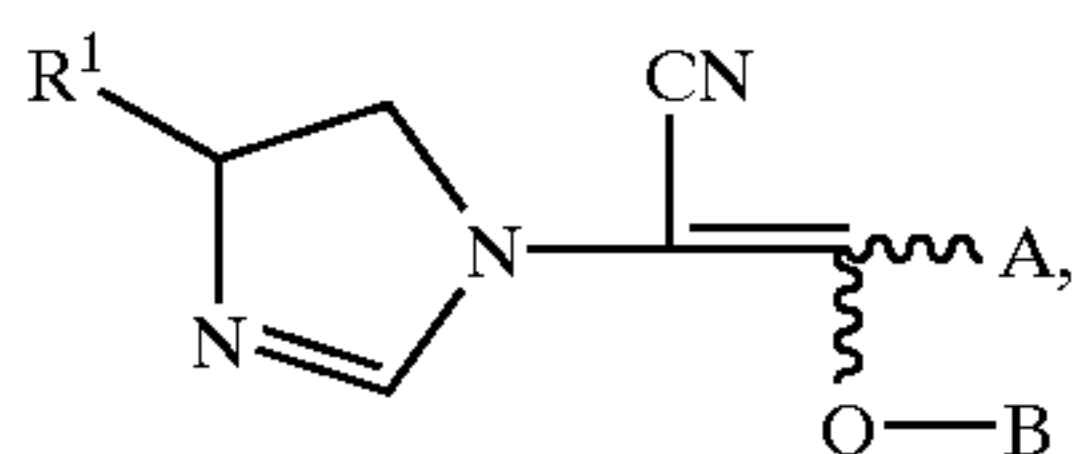
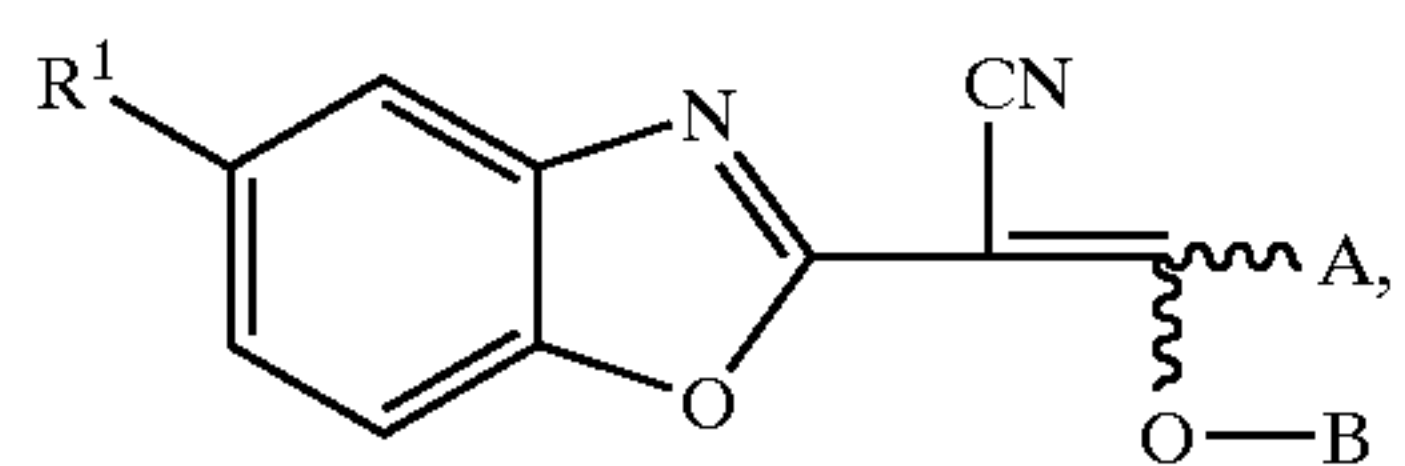
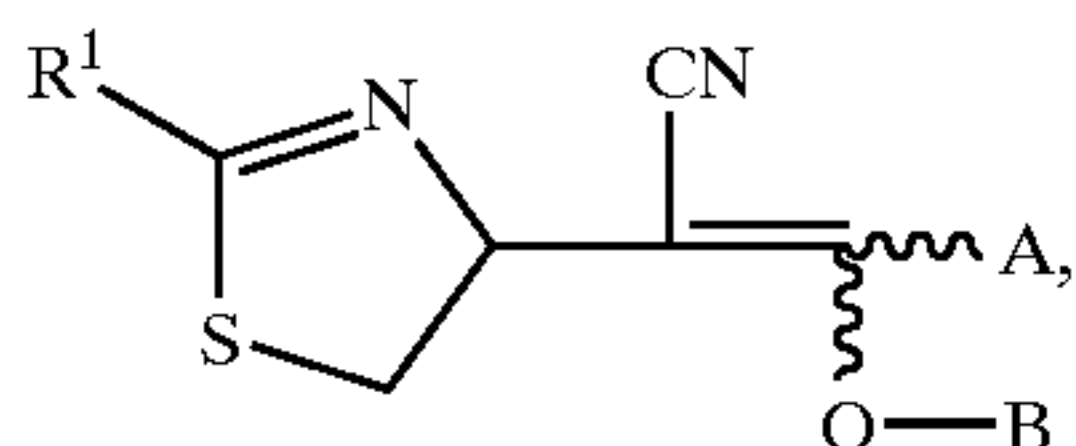
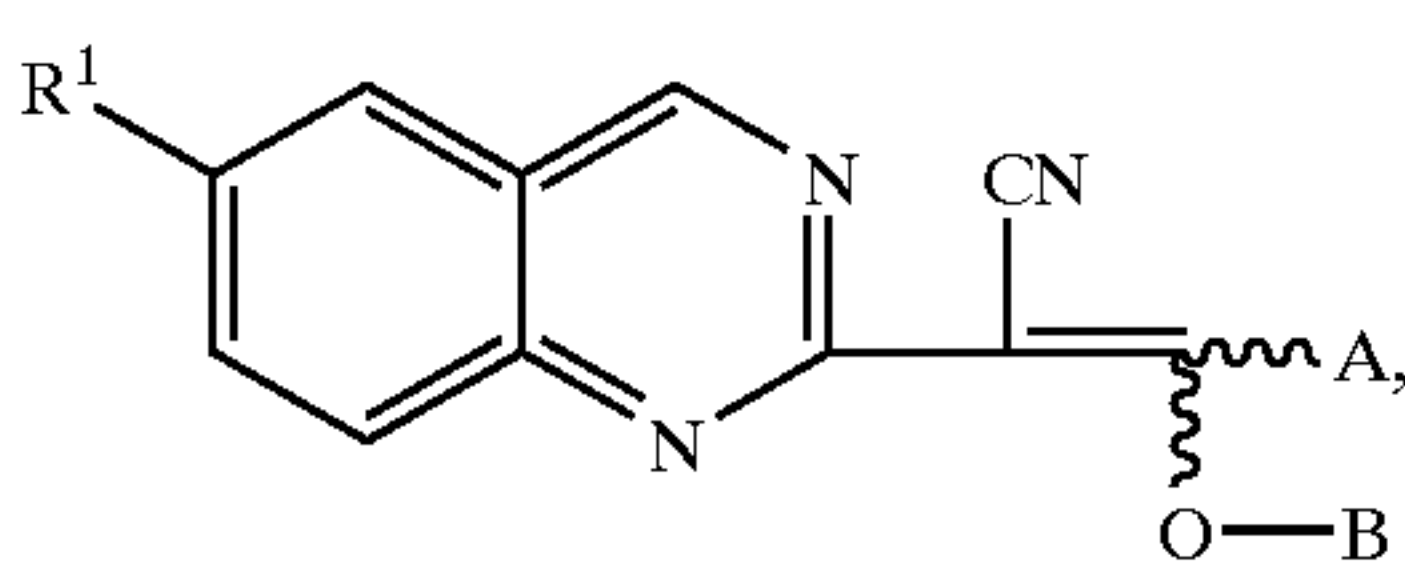
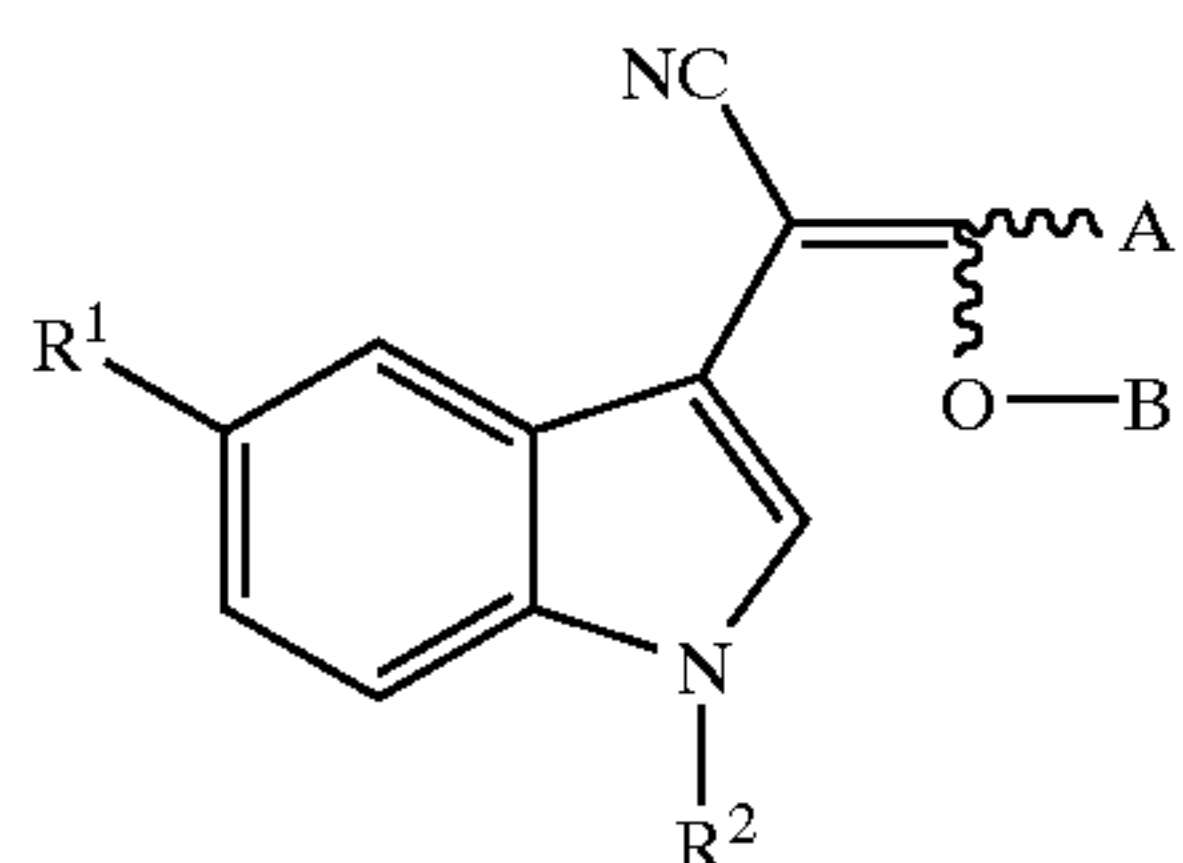
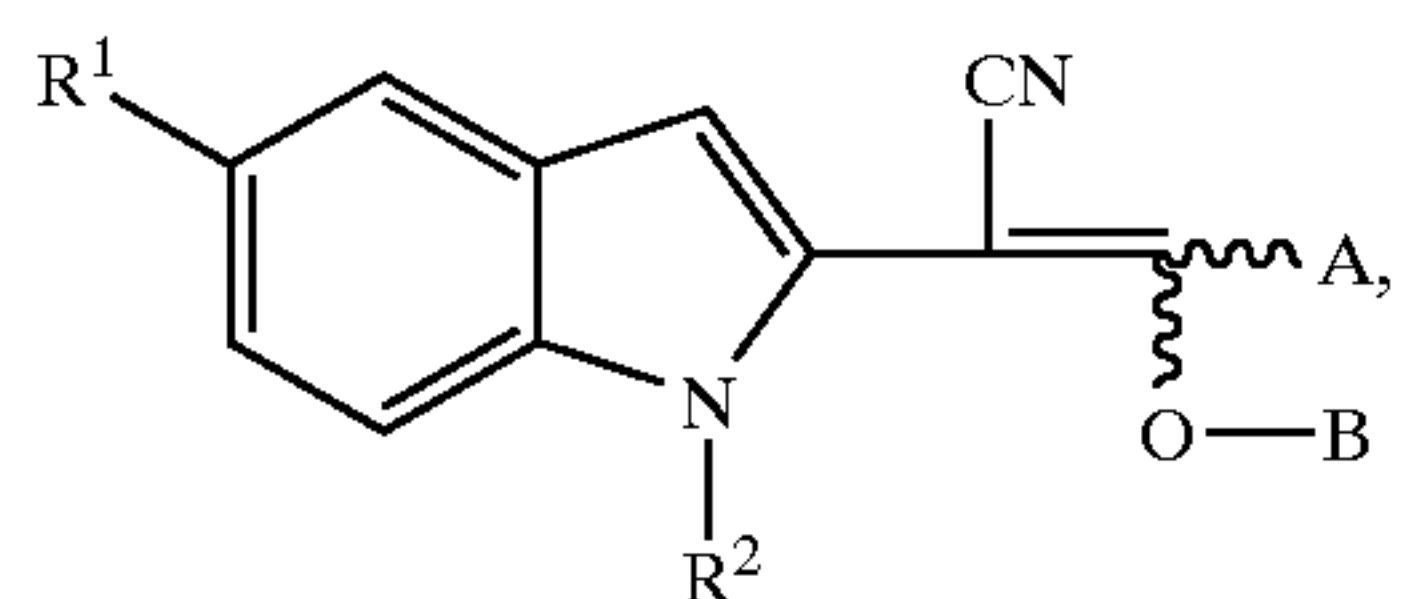
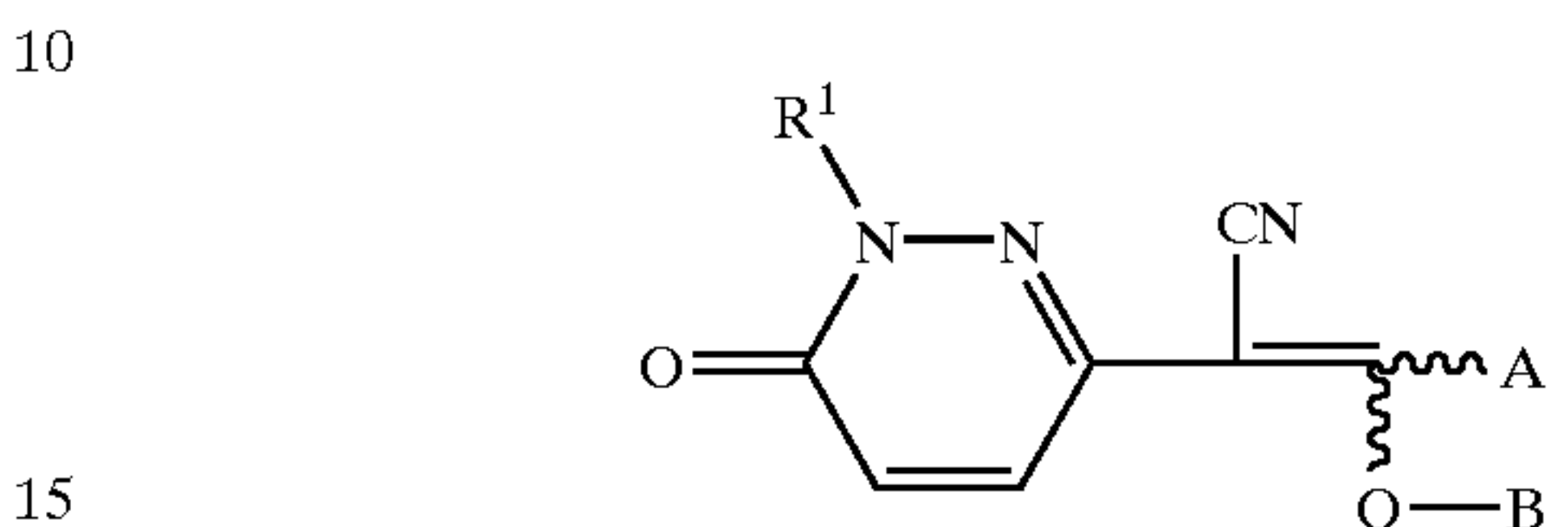
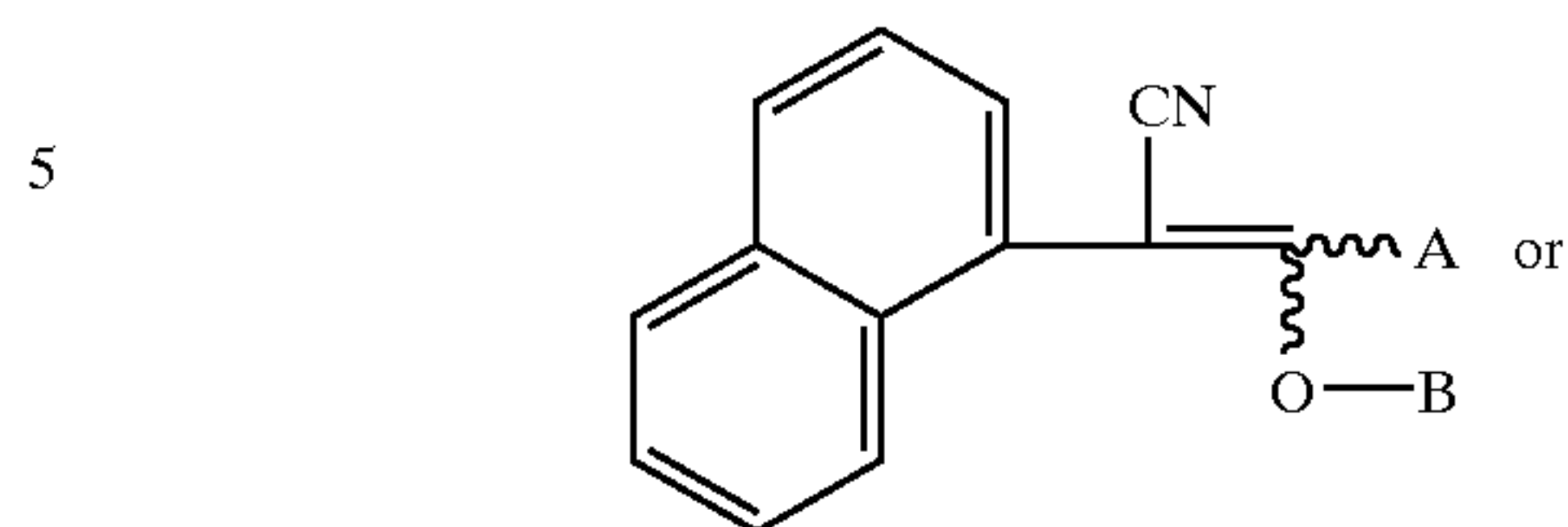

TABLE 13-continued



R ¹	B	A
iPr	H	2,5-Me ₂ -1-pyrrolyl
iPr	B3	1-Me-2-pyrrolyl
20 tBu	B5	3,5-Me ₂ -2-pyrrolyl
tBu	B6	3,4-Me ₂ -2-pyrrolyl
tBu	B7	3,4,5-Me ₃ -2-pyrrolyl
1-Me-cPr	B8	3,5-Me ₂ -4-MeO-2-pyrrolyl
1-Me-cPr	B15	4-MeC(O)-3,5-Me ₂ -2-pyrrolyl
1-Me-cPr	B16	4-NO ₂ -2-pyrrolyl
25 1-Me-cPr	B17	2-Me-3-pyrrolyl
1-Me-cHex	B22	4-Me-3-pyrrolyl
1-Me-cHex	B31	2,4,5-Me ₃ -3-pyrrolyl
1-Me-cHex	B32	2,4-Me ₂ -5-EtO ₂ C-3-pyrrolyl
1-Me-cHex	B33	1,2,3-triazol-4-yl
PhCH ₂	B34	1-Me-1,2,3-triazol-4-yl
30 PhCH ₂	B35	2-Me-1,2,3-triazol-4-yl
PhCH ₂	B36	3-Me-1,2,3-triazol-4-yl
PhMe ₂ C	B40	2-EtO ₂ C-1,2,3-triazol-4-yl
PhMe ₂ C	B41	5-Me-2-Ph-1,2,3-triazol-4-yl
PhMe ₂ C	pyridin-2-yl-C(O)	5-CF ₃ -2-Me-1,2,3-triazol-4-yl
PhMe ₂ C	pyridin-2-yl-C(O)	2,5-Me ₂ -1,2,3-triazol-4-yl
Ph	pyridin-2-yl-C(O)	1-PhCH ₂ -5-Me-1,2,3-triazol-4-yl
35 2-F-Ph	H	1-PhCH ₂ -5-CF ₃ -1,2,3-triazol-4-yl
2-F-Ph	B3	1-PhCH ₂ -5-Cl-1,2,3-triazol-4-yl
2-F-Ph	B5	4-Me-1,2,3-triazol-1-yl
2-F-Ph	B6	5-Me-1,2,3-triazol-2-yl
2-Cl-Ph	B7	4-MeO ₂ C-1,2,3-triazol-1-yl
2-Cl-Ph	B8	4,5-EtO ₂ C-1,2,3-triazol-2-yl
40 2-Cl-Ph	B15	4,5-Me ₂ -1,2,3-triazol-1-yl
2-Me-Ph	B16	4,5-(MeO ₂ C) ₂ -1,2,3-triazol-2-yl
2-Me-Ph	B17	4,5-Me ₂ -1,2,4-triazol-3-yl
2-Me-Ph	B22	2,4-Me ₂ -1,2,4-triazol-3-yl
4-NO ₂ -Ph	B31	1,5-Me ₂ -1,2,4-triazol-3-yl
2,6-F ₂ -Ph	B32	5-Me-3-CF ₃ -1,2,4-triazol-2-yl
45 2,6-F ₂ -Ph	B33	3-Cl-5-CF ₃ -1,2,4-triazol-2-yl
2,6-F ₂ -Ph	B34	5-Cl-3-CF ₃ -1,2,4-triazol-2-yl
2,6-F ₂ -Ph	B35	3,5-Me ₃ -1,2,4-triazol-4-yl
2,6-F ₂ -Ph	B36	3,5-Cl ₂ -1,2,4-triazol-4-yl
2,6-Cl ₂ -Ph	B40	3,5-(CF ₃) ₂ -1,2,4-triazol-4-yl
2,6-Cl ₂ -Ph	B41	5-tetrazolyl
50 2,6-Cl ₂ -Ph	pyridin-2-yl-C(O)	5-Ph-1-tetrazolyl
2-pyridyl	pyridin-2-yl-C(O)	5-Ph-2-tetrazolyl
2-pyridyl	pyridin-2-yl-C(O)	3,4,4,5-Me ₄ -2-pyrazolin-1-yl
2-pyridyl	B8	3-Me-5-CF ₃ -2-pyrazolin-1-yl
2-pyridyl	B15	1,5-Me ₂ -3-CF ₃ -2-pyrazolin-4-yl
2-pyridyl	B16	1,4-Me ₂ -3-Ph-2-pyrazolin-4-yl
2-pyridyl	B17	1,4-Me ₂ -5-Ph-2-pyrazolin-4-yl
55 2-pyridyl	B22	1,3-Me ₂ -2-pyrazolin-5-yl
1-naphthyl	B31	1,5-Me ₂ -2-pyrazolin-3-yl
1-naphthyl	B32	2-Me-2-imizolin-1-yl
1-naphthyl	B33	2-CF ₃ -2-imizolin-1-yl
iPr	B34	2-MeS-2-imizolin-1-yl
iPr	B35	2-MeO-2-imizolin-1-yl
60 tBu	B36	5-Me-2-Ph-2-oxazolin-4-yl
1-Me-cPr	B40	2,5-Me ₂ -2-oxazolin-4-yl
cHex	B41	5-Me-2-CF ₃ -2-oxazolin-4-yl
1-Me-cHex	pyridin-2-yl-C(O)	2-thiazolin-2-yl
PhCH ₂	pyridin-2-yl-C(O)	2-Me ₂ N-2-thiazolin-4-yl
PhMe ₂ C	pyridin-2-yl-C(O)	2,4-Me ₂ -2-thiazolin-5-yl
65 Ph	B8	2-Me-4-CF ₃ -2-thiazolin-5-yl
2-F-Ph	B15	5-Me-2-isoxazolin-3-yl

TABLE 13-continued

2-Cl—Ph	B16	3-Cl-5-Me-2-isoxazolin-4-yl
2-Me—Ph	B17	3,5-(MeS) ₂ -2-isothiazolin-4-yl
4-NO ₂ —Ph	B22	5-Cl-2-Me-3(2H)-pyridazinon-4-yl
2,6-F ₂ —Ph	B31	5,6-Cl ₂ -2-Me-pyridazinon-4-yl
2,6-Cl ₂ —Ph	B32	4-Cl-2-Me-pyridazinon-4-yl
2-pyridyl	B33	4,6-Cl ₂ -2-Me-pyridazinon-4-yl
1-naphthyl	B34	4,5-Cl ₂ -2-Me-pyridazinon-4-yl

TABLE 14

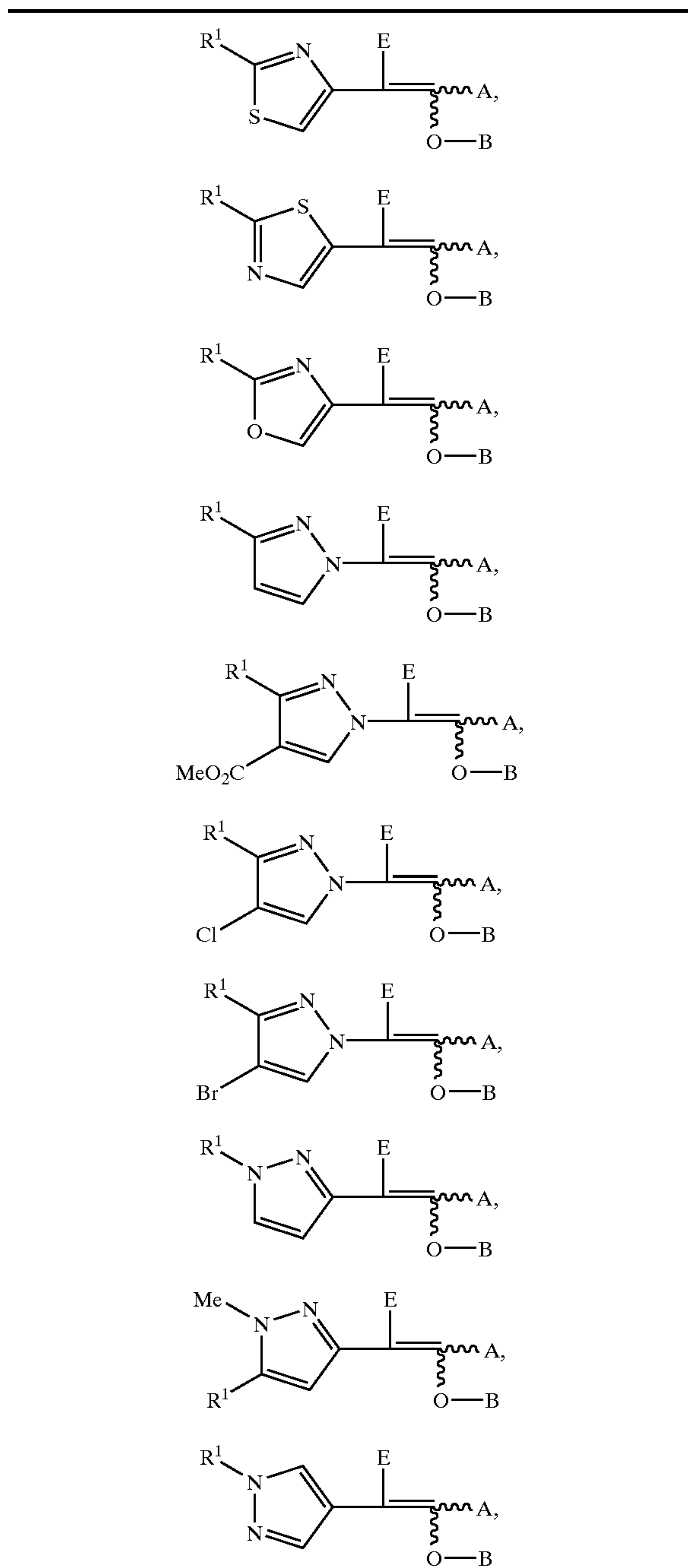

TABLE 14-continued

5		or		
10				
15	R ¹	E	B	A
tBu	oxazol-2-yl	H	A1	
tBu	thiazol-2-yl	B3	A2	
tBu	imidazol-2-yl	B7	A3	
tBu	1,5-Me ₂ -1,2,4-triazol-3-yl	B8	A4	
tBu	5-Me-1,2,4-oxadiazol-3-yl	B15	A5	
20	tBu	5-CF ₃ -1,2,4-thiadiazol-3-yl	B16	A6
tBu	5-Me-1,3,4-oxadiazol-2-yl	B17	A7	
tBu	tetrazol-5-yl	B18	A8	
tBu	2-oxazolin-2-yl	B32	A9	
tBu	1,2,4,5-tetrazin-3-yl	B33	A10	
tBu	F	B34	A11	
25	tBu	Cl	H	A12
tBu	Br	B7	A13	
tBu	I	B8	A14	
tBu	CHC	H	A15	
tBu	CHC	B7	A2	
2,6-F ₂ —Ph	CHC	B7	A2	
30	tBu	MeCC	B7	A16
tBu	EtCC	B7	A17	
tBu	PhCC	B7	A2	
tBu	PhCC	B8	A13	
2,6-F ₂ —Ph	PhCC	H	A2	
2,6-F ₂ —Ph	PhCC	B7	A2	
pyridin-2-yl	PhCC	B7	A2	
35	tBu	(2-Cl—Ph)CC	B15	A19
tBu	(3-Cl—Ph)CC	B15	A20	
2,6-F ₂ —Ph	(4-Cl—Ph)CC	B16	A21	
2,6-F ₂ —Ph	(4-F—Ph)CC	B17	A22	
2,6-F ₂ —Ph	(4-Me—Ph)CC	B18	A23	
2,6-F ₂ —Ph	(4-nHex—Ph)CC	B34	A24	
40	2,6-F ₂ —Ph	(2,6-Cl ₂ —Ph)CC	H	A25
2,6-F ₂ —Ph	(2,4-Cl ₂ —Ph)CC	(EtO) ₂ P(S)	A26	
2,6-F ₂ —Ph	(3,4-Cl ₂ —Ph)CC	B3	A27	
2,6-F ₂ —Ph	(2,4,6-Me ₃ —Ph)CC	B7	A28	
2,6-F ₂ —Ph	(4-CF ₃ —Ph)CC	B15	A29	
2,6-F ₂ —Ph	CF ₃	B7	A2	
45	2,6-F ₂ —Ph	CF ₃ CF ₂	H	A31
2,6-F ₂ —Ph	NO ₂	B3	A32	
2,6-F ₂ —Ph	N ₃	B7	A33	
2,6-F ₂ —Ph	N ₃	H	A2	
2,6-F ₂ —Ph	N ₃	B7	A1	
tBu	N ₃	B7	A2	
50	tBu	N ₃	H	A2
pyridin-2-yl	N ₃	B7	A2	
2,6-F ₂ —Ph	CHO	B8	A34	
2,6-F ₂ —Ph	C(O)Me	B15	A35	
2,6-F ₂ —Ph	C(O)Et	B16	A36	
2,6-F ₂ —Ph	C(O)iPr	B17	A1	
2,6-F ₂ —Ph	C(O)nBu	B18	A2	
55	2,6-F ₂ —Ph	C(O)sBu	B32	A3
2,6-F ₂ —Ph	C(O)tBu	H	A2	
2,6-F ₂ —Ph	C(O)tBu	H	A1	
2,6-F ₂ —Ph	C(O)tBu	B7	A1	
tBu	C(O)tBu	H	A2	
tBu	C(O)tBu	B7	A2	
60	tBu	CO ₂ Me	H	A2
tBu	CO ₂ Me	B7	A2	
tBu	CO ₂ Me	B8	A2	
2,6-F ₂ —Ph	CO ₂ Me	H	A2	
2,6-F ₂ —Ph	CO ₂ Me	B7	A2	
2,6-F ₂ —Ph	CO ₂ Me	B8	A2	
65	pyridin-2-yl	CO ₂ Me	H	A2
pyridin-2-yl	CO ₂ Me	B7	A2	

TABLE 14-continued

pyridin-2-yl	CO ₂ Me	B8	A2
tBu	CO ₂ Me	B34	A5
tBu	CO ₂ Et	H	A2
tBu	CO ₂ Et	B7	A2
tBu	CO ₂ Et	B8	A2
2,6-F ₂ -Ph	CO ₂ Et	H	A2
2,6-F ₂ -Ph	CO ₂ Et	B7	A2
2,6-F ₂ -Ph	CO ₂ Et	B8	A2
pyridin-2-yl	CO ₂ Et	H	A2
pyridin-2-yl	CO ₂ Et	B7	A2
pyridin-2-yl	CO ₂ Et	B8	A2
pyridin-2-yl	CO ₂ Et	H	A6
pyridin-2-yl	CO ₂ nPr	B7	A7
pyridin-2-yl	CO ₂ iPr	B8	A8
pyridin-2-yl	CO ₂ nBu	H	A9
pyridin-2-yl	CO ₂ iBu	B7	A10
pyridin-2-yl	CO ₂ sBu	B7	A11
pyridin-2-yl	CO ₂ tBu	B8	A12
pyridin-2-yl	CO ₂ CH ₂ CH=CH ₂	B15	A13
pyridin-2-yl	CO ₂ CH ₂ CH=CH ₂	B7	A2
tBu	CO ₂ CH ₂ CH=CH ₂	B8	A2
tBu	CO ₂ CH ₂ CH=CH ₂	H	A2
tBu	CO ₂ CH ₂ CH=CH ₂	B7	A2
2,6-F ₂ -Ph	CO ₂ CH ₂ CH=CH ₂	B8	A2
2,6-F ₂ -Ph	CO ₂ CH ₂ CH=CH ₂	H	A2
2,6-F ₂ -Ph	CO ₂ CH ₂ CH=CH ₂	B7	A2
pyridin-2-yl	C(O)NHMe	B8	A2
2,6-F ₂ -Ph	C(O)NHMe	H	A2
tBu	C(O)NHMe	H	A2
pyridin-2-yl	C(O)NHEt	B16	A15
pyridin-2-yl	C(O)NHnPr	B17	A16
tBu	C(O)NHPr	B18	A17
tBu	C(O)NHtBu	B34	A18
tBu	C(O)NHtBu	H	A19
tBu	C(O)NMe ₂	(EtO) ₂ P(S)	A20
tBu	C(O)NMe ₂	H	A2
tBu	C(O)NMe ₂	B7	A2
2,6-F ₂ -Ph	C(O)NMe ₂	B7	A2
pyridin-4-yl	C(O)NMeEt	B3	A21
2,6-F ₂ -Ph	C(O)NEt ₂	B7	A22
tBu	C(O)N(nPr) ₂	B15	A23
tBu	PhC(O)	H	A24
tBu	PhC(O)	H	A2
tBu	PhC(O)	B7	A2
tBu	PhC(O)	B8	A2
2,6-F ₂ -Ph	PhC(O)	H	A2
2,6-F ₂ -Ph	PhC(O)	B7	A2
2,6-F ₂ -Ph	PhC(O)	B8	A2
pyridin-2-yl	PhC(O)	H	A2
pyridin-2-yl	PhC(O)	B7	A2
2,6-F ₂ -Ph	(4-F-Ph)C(O)	B8	A2
2,6-F ₂ -Ph	(3,4-Cl ₂ -Ph)C(O)	H	A6
pyridin-3-yl	(3-Cl-4-F-Ph)C(O)	B8	A27
pyridin-3-yl	(4-Me-Ph)C(O)	B15	A28
tBu	C(S)NH ₂	B16	A29
tBu	C(S)NH ₂	H	A2
tBu	C(S)NH ₂	B7	A2
2,6-F ₂ -Ph	C(S)NH ₂	B8	A2
2,6-F ₂ -Ph	C(S)NH ₂	H	A2
2,6-F ₂ -Ph	C(S)NH ₂	B7	A2
pyridin-2-yl	C(S)NH ₂	B8	A2
pyridin-2-yl	C(S)NH ₂	H	A2
2,6-F ₂ -Ph	MeS	B7	A2
2,6-F ₂ -Ph	EtS	B18	A31
pyridin-2-yl	nPrS	B32	A32
pyridin-2-yl	tBuS	B33	A33
tBu	MeSO	B34	A34
tBu	EtSO	H	A35
tBu	nPrSO	B7	A36
2,6-F ₂ -Ph	tBuSO	B8	A1
2,6-F ₂ -Ph	MeSO ₂	H	A2
2,6-F ₂ -Ph	EtSO ₂	B7	A3
pyridin-2-yl	iPrSO ₂	B7	A4
pyridin-2-yl	nBuSO ₂	B8	A5
tBu	PhS	B15	A6
tBu	PhS	H	A2
tBu	PhS	B7	A2
2,6-F ₂ -Ph	PhS	B8	A2
2,6-F ₂ -Ph	PhS	H	A2

TABLE 14-continued

2,6-F ₂ -Ph	PhS	B7	A2
pyridin-2-yl	PhS	B8	A2
pyridin-2-yl	PhS	H	A2
pyridin-2-yl	PhS	B7	A2
tBu	(4-Me-Ph)S	B8	A2
tBu	(4-Cl-Ph)SO	H	A6
tBu	(2-F-Ph)SO ₂	B17	A9
2,6-F ₂ -Ph	(MeO) ₂ P(O)	B18	A10
2,6-F ₂ -Ph	(EtO) ₂ P(O)	B34	A11
2,6-F ₂ -Ph	(nPrO) ₂ P(O)	H	A12
pyridin-2-yl	(PhO)(MeO)P(O)	(EtO) ₂ P(S)	A13
pyridin-2-yl	(MeO) ₂ P(S)	B3	A14
tBu	(EtO) ₂ P(S)	B7	A15
tBu	(nPrO) ₂ P(S)	B15	A16
15 tBu	(PhO)(MeO)P(S)	B7	A17

Where the compounds of the present invention are used as pesticides, in general, they can be mixed with a suitable carrier, for example a solid carrier, such as clay, talc, bentonite, diatomaceous earth or white carbon, or a liquid carrier such as water, alcohols (e.g., isopropanol, butanol, benzyl alcohol, furfuryl alcohol), aromatic hydrocarbons (e.g., toluene, xylene), ethers (e.g., anisole), ketones (e.g., cyclohexanone, isophorone), esters (e.g., butyl acetate), acid amides (e.g., N-methylpyrrolidone) or halogenated hydrocarbons (e.g., chlorobenzene), optionally along with other additives such as surfactant, emulsifier, dispersing agent, penetrating agent, spreading agent, thickener, anti-freezing agent, anti-caking agent and stabilizer, and can be formulated into any desired forms for practical use, such as liquid preparations, emulsions, wettable powders, dry flowables, flowables, dusts and granules.

Where the compounds of the present invention are used as agricultural chemicals, they can be combined with any other herbicides, various insecticides, acaricides, nematocides, fungicides, plant growth regulators, synergists, fertilizer and soil improvers, when they are formulated into preparations for practical use or while they are actually used through spraying or the like.

In particular, the combination of the compounds of the invention and other agricultural chemicals or plant hormones will be advantageous in that the amount of the chemicals to be used can be reduced thereby resulting in the reduction of the costs for the treatment, and that the mixed chemicals exhibit synergistic effects to broaden the insecticidal spectrum while displaying higher pesticidal activities. If desired, the compounds of the invention can be combined with a plurality of known agricultural chemicals. For the agricultural chemicals capable of being combined with the compounds of the invention, for example, the compounds described in Farm Chemicals Handbook, 1994 are referred.

Their concrete general names are raised below. However, the present invention is not necessarily limited by them.

Fungicide: acibenzolar, ampropyfos, anilazine, azaconazole, azoxystrobin, benalaxyl, benodanil, benomyl, benzamecrid, binapacryl, biphenyl, bitertanol, bethoxazine, Bordeaux mixture, blesticidin-S, bromoconazole, bupirimate, buthiobate, calcium polysulfide, captafol, captan, copper oxychloride, caryopamid, carbendazim, carboxin, chinomethionat, chlornthiazole, chlorfenazol, chloroneb, chlorothalonil, chlozolinete, cufraneb, cymoxanil, cyproconazol, cyprodinil, cyprofuram, debacarb, dichlorophen, diclobutrazol, dichlofluanid, diclomezine, dicloran, diethofencarb, diclocymet, difenoconazole, diflumetorim, dimethirimol, dimethomorph, diniconazole, diniconazole-M, dinocap, diphenylamine, dipyrithione, ditalimfos, dithianon,

dodemorph, dodine, drazoxolon, edifenphos, epoxiconazole, etaconazole, ethirimol, etridiazole, famoxadone, fenarimol, febuconazole, fenfuram, fencpiclonil, fenpropidin, fenpropimorph, fentin, ferbam, ferimzone, fluazinam, fludioxonil, fluoroimide, fluquinconazole, flusilazole, flusulfamide, flutolanil, flutriofol, folpet, fosetyl-aluminium, fuberidazole, furalaxyl, fenamidone, fenhexamid, guazatine, hexachlorobenzene, hexaconazole, hymexazol, imazalil, imibenconazole, iminoctedine, ipconazole, iprobenfos, iprodione, isoprothiolane, iprovalicarb, kasugamycin, kresoxim-methyl, mancopper, mancozeb, maneb, mepanipyrim, mepronil, metalaxyl, metconazole, metiram, metominostrobin, myclobutenil, nabam, nickel bis (dimethyldithiocarbamate), nitrothal-isopropyl, nuarimol, octhilinone, ofurace, oxadixyl, oxycarboxin, oxpoconazole fumarate, pefuaoate, penconazole, pencycuron, phthalide, piperalin, polyoxins, probenazole, prochloraz, procymidone, propamocarb hydrochloride, propiconazole, propineb, pyrazophos, pyrifenox, pyrimethanil, pyroquilon, quinoxifen, quintozone, sulfur, spiroxamine, tebuconazole, tecnazene, tetraconazole, thiabendazole, thifluzamide, thiophanate-methyl, thiram, tolclofos-methyl, tolylfluanid, triadimefon, toriadimenol, triazoxide, tricyclazole, tridemorph, triflumizole, triforine, triticonazole, validamycin, vinclozolin, zineb, ziram.

Bacteriazide: streptomycin, oxytetracycline, oxolinic acid.

Nematicide: aldoxycarb, cadusafos, fosthiazate, fosthietan, oxemyl, fenamiphos.

Acaricide: acequinocyl, acrinathrin, amitraz, bifenazate, bromopropylate, chinomethionat, chlorobezilate, clofentezine, cyhexatine, dicofol, dirnochlor, etoxazole, frnazaquin, fenbutatin oxide, fenpropathrin, fenproximate, halfenprox, hexythiazox, milbemectin, phenisobromolate, polynactins, propargite, pyridaben, pyrimidifen, tebufenpyrad, tetradifon.

Insecticide: abamectin, acephate, ecetamipirid, alanycarb, azinphos-methyl, bendiocarb, benfuracarb, bensultap, bifenthrin, *Batillus thuringiensis*, buprofezin, butocarboxim, carbaryl, carbofuran, carbosulfan, cartap, chlorfenapyr, chlorpyrifos, chlorfenvinphos, chlorfluazuron, clothianidin, chromafenozide, chlorpyrifos-methyl, cyanox, cycloprothrin, cyfluthrin, beta-cyfluthrin, cypermethrin, cyromazine, cyhalothrin, lambda-cyhalothrin, deltamethrin, diafenthiuron, diazinon, diecloden, dichlorvos, diflubenzuron, dimethylvinphos, diofenolan, disulfoton, dimethoate, emamectin-benzoate, EPN, esfenvalerate, ethiofencarb, endosulfan, ethiprole, ethylthiometon, etofenprox, etrimfos, fenitrothion, fenobucarb, fenothiocarb, fenthion, fenoxycarb, fenpropathrin, fenvalerate, fipronil, flucythrinate, flufenoxuron, flufenprox, tau-fluvalinate, fonophos, formetenate, formothion, furathiocarb, halofenozide, hexaflumuron, hydramethylnon, imidacloprid, isofenphos, indoxacarb, isoprocarb, isoxathion, lufenuron, malathion, metaldehyde, methamidophos, methidathion, methacrifos, metalcarb, methomyl, methoprene, methoxychlor, methoxyfenozide, monocrotophos, muscalure, nicotin-sulfate, nitenpyram, omethoate, oxydemeton-methyl, oxamyl, parathion, parathion-methyl, permethrin, phenthoete, phoxim, phorate, phosalone, phosmet, phosphamidon, pirimicarb, pirimiphos-methyl, profenofos, propafos, prothiofos, pymetrozine, pyraclofos, pyridafenthiuron, pyriproxyfen, rotenone, sulprofos, silafluofen, spinosad, sulfotep, tebfenozide, teflubenzuron, tefluthrin, terbufos, tetrachlorvinphos, thiodicarb, thiamethoxam, thiocyclam, thiofanox, thiometon, tolfenpyrad, tralomethrin, trichlorfon, triazuron, triflumuron, vamidothion.

The dose of the compounds of the present invention varies depending on an application place, an application time, an application method, cultivation crops, etc. In general, it may be between approximately 0.005 kg and 50 kg per hectare (ba) in terms of the amount of the active ingredient.

Now, formulation examples comprising the compounds of the invention are mentioned below, which, however, are not intended to restrict the scope of the invention. In the following formulation examples, "part" or "parts" are by weight.

[Wettable Powders]

Compound of the invention	5 to 80 parts
Solid carrier	10 to 85 parts
Surfactant	1 to 10 parts
Others	1 to 5 parts

The others include, for example, anti-caking agent, etc.

[Emulsions]

Compound of the invention	1 to 30 parts
Liquid carrier	30 to 95 parts
Surfactant	5 to 15 parts

[Flowables]

Compound of the invention	5 to 70 parts
Liquid carrier	15 to 65 parts
Surfactant	5 to 12 parts
Others	5 to 30 parts

The others include, for example, anti-freezing agent, thickener, etc.

[Dry Flowables (wetable granules)]

Compound of the invention	20 to 90 parts
Solid carrier	10 to 60 parts
Surfactants	1 to 20 parts

[Granules]

Compound of the invention	0.1 to 10 parts
Solid carrier	90 to 99.99 parts
Others	1 to 5 parts

[Dusts]

Compound of the invention	0.01 to 30 parts
Solid carrier	67 to 99.5 parts
Others	0 to 3 parts

Where the compounds of the present invention are used as an agent for preventing the attachment of aquatic organisms, they may be formulated into various preparations of, for example, coating paints, solutions, emulsions, pellets or flakes to be applicable to various objects. Depending on the application place, the object and the form, the preparations can be used in any ordinary manners of, for example, coating, spraying, dipping, adding to water or installing in water. To prepare such coating paints, solutions, emulsions and others, employable are any ordinary methods. Apart from the above-mentioned preparations and modes of using the compounds of the present invention, the compounds may also be used, for example, by incorporating them into ropes or fiber materials for fishing nets in the stage of preparing the ropes or fiber materials to thereby making them have the ability to prevent the attachment of aquatic organisms

thereto. The agents for preventing the attachment of aquatic organisms according to the present invention can be used either singly or as combined with any other agents for preventing the attachment of aquatic organisms.

Where the aquatic adhesion inhibitors of the invention are used in the form of antifouling coatings, for example, the compounds of the invention may be mixed with film-forming agents to prepare coatings. The film-forming agents include oil varnishes, synthetic resins, artificial rubbers, etc. If desired, solvents, pigments and others can be added to the coatings. To prepare the paints, the uppermost limit of the concentration of the compounds of the invention to be therein is not specifically limited, provided that the resulting coatings can form film, but may be from 1 to 50% by weight, preferably from 5 to 20% by weight, relative to the weight of the antifouling coatings.

Where the agents for preventing the attachment of aquatic organisms of the present invention are used in the form of solutions, for example, the compounds of the invention may be dissolved in solvents along with film-forming agents to prepare solutions. The film-forming agents include synthetic resins, artificial rubbers, natural resins, etc. The solvents include xylene, toluene, cumene, methyl ethyl ketone, methyl isobutyl ketone, acetone, etc. If desired, additives such as plasticizer may be added to the solutions. To prepare the solutions, the uppermost limit of the concentration of the compounds of the invention to be therein is not specifically limited, provided that the compounds are dissolved to give solutions, but may be from 1 to 50% by weight, preferably from 5 to 30% by weight, relative to the weight of the solutions.

Where the agents for preventing the attachment of aquatic organisms of the present invention are used in the form of emulsions, surfactants are added to the compounds of the invention to prepare the intended emulsions according to ordinary methods of preparing general emulsions. In this, the type of the surfactants to be used is not specifically limited. To prepare the emulsions, the uppermost limit of the concentration of the compounds of the invention to be therein is not specifically limited, provided that the compounds are emulsified to give emulsions, but may be from 1 to 50% by weight, preferably from 5 to 30% by weight, relative to the weight of the emulsions.

Where the agents for preventing the attachment of aquatic organisms of the present invention are used in the form of pellets or flakes, for example, the constitutive components of the compounds of the invention and optionally plasticizers, surfactants and others are added to the base of hydrophilic resins which are solid at room temperature, such as polyethylene glycol in a solid form, and the resulting mixtures are shaped into pellets or flakes through melting molding, compression molding or the like. To prepare the pellets or flakes, the uppermost limit of the concentration of the compounds to be therein is not specifically limited, provided that the compounds can be shaped into pellets or flakes, but may be from 20 to 95% by weight, preferably from 30 to 90% by weight, relative to the weight of the pellets or flakes.

EXAMPLES

The present invention is illustrated specifically by referring to the following Synthesis Examples, Formulation Examples and Test Examples, which, however, are not intended to restrict the scope of the invention.

Synthesis Example 1

Synthesis of 2-{3-(2,6-difluorophenyl)pyrazol-1-yl}-3-(1-methyl-3,5-dichloropyrazol-4-yl)-3-hydroxyacrylonitrile

(Compound No. I-40)

1) 3.0 g of 3-(2,6-difluorophenyl)pyrazole was dissolved in 20 ml of acetonitrile, and 2.52 g of chloroacetonitrile and

4.61 g of potassium carbonate were added thereto at room temperature, and heated under reflux for 5 hours. After acetonitrile was distilled off under reduced pressure, ethyl acetate was added to the residue, which was then washed with a small amount of water. The organic layer was dried over sodium sulfate, and the solvent was distilled off under reduced pressure. The residual product was recrystallized from a mixed solvent to isopropylether and diethyl ether to obtain 1.74 g of 1-cyanomethyl-3-(2,6-difluorophenyl)pyrazole.

2) A solution of 0.5 g of 1-cyanomethyl-3-(2,6-difluorophenyl)pyrazole dissolved in 10 ml of THF was dropwise added to a suspension of 0.15 g of 55% sodium hydride in 10 ml of THF, at 50° C. After the resulting product was stirred for 30 minutes, a solution of 0.67 g of 1-(1-methyl-3,5-dichloropyrazole-4-carbonyl)pyrazole dissolved in 10 ml of THF was dropwise added thereto at 50° C. and then stirred overnight at room temperature. The reaction mixture was poured into water, then extracted with ethyl acetate and washed with a small amount of water. The resulting product was dried over sodium sulfate, and the solvent was distilled off under reduced pressure. The residual product was recrystallized from a mixed solvent of isopropyl ether/ethyl acetate=3/1 to obtain 0.52 g of 2-{3-(2,6-difluorophenyl)pyrazol-1-yl}-3-(1-methyl-3,5-dichloropyrazol-4-yl)-3-hydroxyacrylonitrile.

Synthesis Example 2

Synthesis of 3-(1-methyl-3,5-dichloropyrazol-4-yl)-2-(2-phenylthiazol-4-yl)-3-hydroxyacrylonitrile

(Compound No. II-1)

1) 2.33 g of thiobenzamide was dissolved in 20 ml of dry methanol, and 2.16 g of 1,3-dichloroacetone was added thereto at room temperature and then heated under reflux for 1 hour. The solvent was distilled off under reduced pressure, and ice water was added to the remaining product, which was then neutralized with an aqueous solution of sodium hydrogen carbonate. The resulting product was extracted with ethyl acetate, washed with saturated saline, and dried over sodium sulfate, and the solvent was distilled off under reduced pressure. The residual product was purified through silica gel column chromatography to obtain 2.03 g of 4-chloromethyl-2-phenylthiazole was obtained from the fraction eluted with chloroform/n-hexane=1/2.

2) 1.39 g of 4-chloromethyl-2-phenylthiazole was dissolved in 10 ml of acetonitrile, and 0.65 g of potassium cyanide and 0.05 g of dibenzo-18-crown-6-ether were added thereto at room temperature, and then heated under reflux for 10 hours. After the temperature was returned to room temperature, ethyl acetate was added the resulting mixture, and the insoluble solid was removed through filtration. The resulting ethyl acetate solution was washed with saturated saline and water, and dried over sodium sulfate, and the solvent was distilled off under reduced pressure. The residual product was purified through silica gel column chromatography to obtain 0.98 g of 4-cyanomethyl-2-phenylthiazole from the fraction eluted with chloroform.

3) 0.72 g of 4-cyanomethyl-2-phenylthiazole was dissolved in 10 ml of dry THF, and 4.6 ml of n-butyl lithium (1.56 M hexane solution) was dropwise added thereto at -60° C. or lower in an argon atmosphere. After the resulting product was stirred at -60° C. or lower for 20 minutes, 0.84 g of 1-methyl-3,5-dichloropyrazole-4-carbonyl chloride as dissolved in 3 ml of dry THF was dropwise added thereto at -60° C. or lower. Then, the resulting product was gradually

heated, and stirred for 4 hours at room temperature. The reaction mixture was poured into ice water, acidified with diluted hydrochloric acid, extracted with ethyl acetate, and washed with saturated saline. The resulting product was dried over sodium sulfate, and the solvent was distilled off under reduced pressure. The residual product was purified through silica gel column chromatography to obtain the intended product from the fraction eluted with chloroform. The resulting product was crystallized and washed with diethyl ether to obtain 0.86 g of 3-(1-methyl-3,5-dichloropyrazol-4-yl)-2-(2-phenylthiazol-4-yl)-3-hydroxyacrylonitrile.

Synthesis Example 3

Synthesis of 3-(1-methyl-3-trifluoromethyl-5-chloropyrazol-4-yl)-2-(4-tert-butylthiazol-2-yl)-3-pivaloyloxyacrylonitrile

(Compound No. III-6, III-15)

0.5 g of 3-(1-methyl-3-trifluoromethyl-5-chloropyrazol-4-yl)-2-(4-tert-butylthiazol-2-yl)-3-hydroxyacrylonitrile and 0.14 g of triethylamine were added to 15 ml of THF at room temperature and stirred to give a uniform solution. 0.16 g of pivaloyl chloride was dropwise added to the solution with cooling with ice, then gradually heated, and stirred at room temperature for 8 hours. The reaction mixture was poured into ice water, extracted with ethyl acetate, and washed thrice with saturated saline. After having been dried over sodium sulfate, the resulting product was passed through a short column filled with silica gel. The solvent was distilled off under reduced pressure, and the residual product was applied to silica gel thin-layer chromatography (developer solvent: chloroform) to obtain 0.16 g of 3-(1-methyl-3-trifluoromethyl-5-chloropyrazol-4-yl)-2-(4-tert-butylthiazol-2-yl)-3-pivaloyloxyacrylonitrile (III-6) and 0.35 g of its geometric isomer (III-15).

Compound No. III-6

¹H-NMR (CDCl₃, δ ppm); 1.18 (9H, s), 1.32 (9H, s), 3.85 (3H, s), 6.88 (1H, s)

Compound No. III-15

¹H-NMR (CDCl₃, δ ppm); 1.33 (9H, s), 1.39 (9H, s), 3.94 (3H, s), 7.03 (1H, s)

Reference Example

Synthesis of 1-methyl-3-trifluoromethyl-5-chloropyrazole-4-carboxylic acid

1) 21.35 g of phosphorus oxychloride was dropwise added to 4.72 g of DMF at 10° C. or lower. After the temperature of the reaction solution was returned to room temperature, the reaction mixture was stirred for 1 hour, and 10.71 g of 1-methyl-3-trifluoromethyl-5-pyrazolone was added thereto. The resulting mixture was heated up to 110° C., and stirred for 7 hours. After having been left to be at 70° C. the reaction mixture was poured into ice water. After pH of the mixture was made to be about 4 with an aqueous solution of sodium hydroxide added thereto, and precipitated crystals were taken out through filtration and dried to obtain 10.55 g of 1-methyl-3-trifluoromethyl-5-chloropyrazole-4-carbaldehyde.

2) 8.88 g of 1-methyl-3-(2-(tert-trifluoromethyl-5-chloropyrazole-4-carbaldehyde) and 7.24 g of potassium permanganate were added to an aqueous solution of 0.23 g of potassium hydroxide in 85 ml of water, at room temperature. After having been heated up to 60° C., the resulting

mixture was stirred for 2 hours. Next, the temperature of the mixture was return to room temperature, and the solid was removed through filtration. The resulting filtrate was acidified with an aqueous solution of hydrochloric acid, and precipitated crystals were taken out through filtration, washed with water, and dried. The thus-obtained crystals were added to 150 ml of chloroform, and heated under reflux, and the insoluble solid was removed through filtration at a heating time. Chloroform was distilled off under reduced pressure, and 6.24 g of 1-methyl-3-trifluoromethyl-5-chloropyrazole-4-carboxylic acid was obtained.

Synthesis Example 4

Synthesis of 2-(2-tert-butylthiazol-4-yl)-3-(2-methyl-4-trifluoromethylthiazol-5-yl)-3-benzoyloxyacrylonitrile

(Compound No. II-75)

In the same manner as above, the above-mentioned compound was synthesized (viscous liquid, E-Z mixture).

¹H-NMR (CDCl₃, δ ppm); 1.09 (9H, s), 2.75 (3H, s), 7.3-7.6 (4H, m), 8.05-8.25 (2H, m): major 1.19 (9H, s), 2.70 (3H, s), 7.3-7.6 (4H, m), 8.05-8.25 (2H, m): minor

Synthesis Example 5

Synthesis of 2-(4-trifluoromethylphenyl)-3-(1-methyl-3,5-dichloropyrazol-4-yl)-3-(1-methyl-3,5-dichloropyrazole-4-carbonyloxy)acrylonitrile

(Compound No. IV-5)

1.0 g of 4-(trifluoromethyl)phenylacetonitrile and 2.31 g of 1-methyl-3,5-dichloropyrazole-4-carbonyl chloride were dissolved in 30 ml of dry THF, and 0.61 g of potassium t-butoxide was added thereto at room temperature. After having been heated, the resulting product was kept heated under reflux for 3 hours. 0.61 g of potassium t-butoxide was again added thereto and further heated under reflux for 2 hours. THF was distilled off under reduced pressure, and water was added to the residual product, which was then extracted with ethyl acetate. The resulting organic layer was washed with a dilute aqueous solution of sodium hydroxide and then with water. This was dried with sodium sulfate, and the solvent was distilled off under reduced pressure. The residue was purified through silica gel column chromatography to obtain 1.92 g of 2-(4-trifluoromethylphenyl)-3-(1-methyl-3,5-dichloropyrazole-4-carbonyloxy)acrylonitrile from the fraction eluted with n-hexane:ethyl acetate=2:1.

Synthesis Example 6

Synthesis of 2-(4-tert-butylphenyl)-3-(1-methyl-3,5-dichloropyrazol-4-yl)-3-hydroxyacrylonitrile

(Compound No. IV-18)

0.22 g of dibenzo-18-crown-6-ether and 1.57 g of sodium cyanide were suspended in 20 ml of DMSO, and 5.00 g of 4-tert-butylbenzyl bromide was dropwise added thereto with cooling with water. After having been stirred overnight at room temperature, the resulting mixture was further stirred at 50° C. for 5 hours. After this was left to be at room temperature, water was added thereto and extracted with ether. The organic layer was washed with water, and dried over sodium sulfate, and the solvent was distilled off under

reduced pressure. The residual product was purified through silica gel column chromatography to obtain 1.19 g of 4-tert-butylphenylacetonitrile was obtained from the fraction eluted with n-hexane:ethyl acetate 5:1.

1.00 g of 4-tert-butylphenylacetonitrile and 1.23 g of 1-methyl-3,5-dichloropyrazole-4-carbonyl chloride were dissolved in 20 ml of THF, and 1.01 g of potassium t-butoxide was added thereto with cooling with ice. After the resulting mixture was stirred overnight at room temperature, water was added thereto, acidified with diluted hydrochloric acid, and extracted with ethyl acetate. The organic layer was washed with water, and dried with sodium sulfate, and the solvent was distilled off under reduced pressure. The residual product was dissolved in a mixed solvent of 10 ml of water and 10 ml of dioxane, and 0.38 g of potassium hydroxide was added thereto and heated under reflux for 4 hours. After having been left to be at room temperature, this was acidified with diluted hydrochloric acid, and extracted with ethyl acetate. The organic layer was washed with water, and dried over sodium sulfate, and the solvent was distilled off under reduced pressure. The residual product was purified through silica gel column chromatography to obtain 0.64 g of 2-(4-tert-butylphenyl)-3-(1-methyl-3,5-dichloropyrazol-4-yl)-3-hydroxyacrylonitrile from the fraction eluted with n-hexane:ethyl acetate=2:1.

Synthesis Example 7

Synthesis of 2-(4-tert-butylphenyl)-3-(1-methyl-3-trifluoromethyl-5-chloropyrazol-4-yl)-3-pivaloyloxyacrylonitrile

(Compound No. IV-24)

In the same manner as above, the above-mentioned compound was synthesized (viscous liquid).

¹H-NMR (CDCl₃, δ ppm); 1.13 (9H, s), 1.33 (9H, s), 3.98 (3H, s), 7.48 (4H, brs)

Synthesis Example 8

Synthesis of 2-(4-tert-butylphenyl)-3-(3,5-dichloro-1-methylpyrazol-4-yl)-3-methoxycarbonyloxyacrylonitrile

(Compound No. IV-36)

In the same manner as above, the above-mentioned compound was synthesized (vitreous, E-Z mixture).

¹H-NMR (CDCl₃, δ ppm); 1.32 (9H, s), 3.75 (3H, s), 3.87 (3H, s), 7.49 (2H, d, J=8 Hz), 7.58 (2H, d, J=8 Hz): 75% 1.27 (9H, s), 3.88 (3H, s), 3.96 (3H, s), 7.49 (2H, d, J=8 Hz), 7.58(2H, d, J=8 Hz): 25%

Synthesis Example 9

Synthesis of 2-{2-tert-butylloxazol-4-yl}-3-(3,5-dichloro-1-methyl-pyrazol-4-yl)-3-hydroxyacrylonitrile

(Compound No. V-40)

1) 25 g of pivalic acid amide and 25 g of 1,3-dichloro-2-propanone were mixed and heated on an oil bath at 135° C. for 2.5 hours. After having been cooled with ice, the mixture was made alkaline with an aqueous solution of sodium hydroxide added thereto. Then, the resulting product was extracted with ethyl acetate, washed with water, and dried over anhydrous sodium sulfate, and the solvent was

distilled off under reduced pressure. The residual product was purified through column chromatography (silica gel; ethyl acetate n-hexane=1:8) to obtain 17.5 g of 2-tert-butyl-4-chloromethyloxazole.

2) 6.2 g of sodium cyanide was weighed, 50 ml of dimethylsulfoxide was added thereto, and a dimethylsulfoxide solution of 16.9 g of 2-tert-butyl-4-chloromethyloxazole was dropwise added thereto, and heated on an oil bath at 65° C. for 1 hour with stirring. After the resulting product was cooled to room temperature, 150 ml of a dilute aqueous solution of sodium hydroxide was added thereto, and extracted with toluene. The organic layer was fully washed with water, and dried over anhydrous sodium sulfate, and the solvent was distilled off under reduced pressure to obtain 14.8 g of 2-tert-butyl-4-cyanomethyloxazole.

3) 2.87 g of potassium tert-butoxide was suspended in 20 ml of THF, and a solution of 2.00 g of 2-tert-butyl-4-cyanomethyloxazole and 2.37 g of 3,5-dichloro-1-methylpyrazole-4-carbonyl chloride as dissolved in 10 ml of THF was dropwise added thereto with cooling with ice, and then stirred overnight at room temperature. The reaction mixture was poured into ice water, extracted with ethyl acetate, and washed with a small amount of water. After the resulting product was dried with anhydrous sodium sulfate, the solvent was evaporated out under reduced pressure. The residual product was purified through column chromatography (silica gel; n-hexane:ethyl acetate=4:1) to obtain 3.26 g of the intended compound.

Synthesis Example 10

Synthesis of 2-(2-tert-butylloxazol-4-yl)-3-(5-chloro-1-methyl-3-trifluoromethylpyrazol-4-yl)-3-ethoxymethoxyacrylonitrile

(Compound No. V-44)

0.6 g of 2-{2-tert-butylloxazol-4-yl}-3-(5-chloro-3-trifluoromethyl-1-methyl-pyrazol-4-yl)-3-hydroxyacrylonitrile was dissolved in 5 ml of THF, and 0.07 g of 60% sodium hydride was added thereto with cooling with ice, and then stirred for 15 minutes at room temperature. 0.17 g of ethoxymethyl chloride was added thereto and stirred for 6 days at room temperature. The reaction mixture was poured into ice water, extracted with ethyl acetate, and washed with saturated saline. The resulting product was dried over anhydrous sodium sulfate, and the solvent was distilled off under reduced pressure. The resulting residual product was purified through silica gel thin-layer chromatography (ethyl acetate:n-hexane=1:4) to obtain 0.1 g of the intended compound in vitreous state.

¹H-NMR (CDCl₃, δ ppm); 1.17 (3H, t), 1.41 (9H, s), 3.98 (3H, s), 5.03 (2H, s), 8.00 (1H, s)

Synthesis Example 11

Synthesis of ethyl 2-phenyl-3-(3,5-dichloro-1-methylpyrazol-4-yl)-3-hydroxyacrylate

(Compound No. IV-91)

8.2 g (50 mmols) of ethyl phenylacetate and 10.7 g (50 mmols) of 3,5-dichloro-1-methylpyrazole-4-carboxylic acid chloride were dissolved in 100 ml of dry tetrahydrofuran, and 14 g (125 mmols) of potassium tert-butoxide at room temperature. The reaction mixture was stirred at room temperature for 1 hour, and 300 ml of water was added thereto, and extracted with ethyl acetate. The organic layer

187

was washed with water and saturated saline, and dried over anhydrous magnesium sulfate, and the solvent was distilled off under reduced pressure to obtain 17 g of the intended ethyl 2-phenyl-3-(3,5-dichloro-1-methylpyrazol-4-yl)-3-hydroxyacrylate.

¹H-NMR (CDCl₃, δ ppm); 1.1–1.5 (3H, m), 3.59 (1.5H, s), 3.73 (1.5H, s), 3.95–4.45 (2H, m), 5.58 (0.5H, s), 7.0–7.35 (5H, m), 13.21 (0.5H, s)

Synthesis Example 12

Synthesis of 1-(3,5-dichloro-1-methylpyrazol-4-yl)-2-phenyl-2-bromoethanone

(Compound No. IV-90)

1) 17 g (50 mmols) of ethyl 2-phenyl-3-(3,5-dichloro-1-methylpyrazol-4-yl)-3-hydroxyacrylate was dissolved in 50 ml of 6 N HCl and 250 ml of 1,4-dioxane, and heated under reflux for 15 hours. The reaction mixture was poured into 500 ml of ice water, and precipitated crystals were taken out through filtration to obtain 8 g of the intended 1-(3,5-dichloro-1-methylpyrazol-4-yl)-2-phenylethanone as white crystals. m.p.: 94–96° C.

2) 5.38 g (20 mmols) of 1-(3,5-dichloro-1-methylpyrazol-4-yl)-2-phenylethane was dissolved in 50 ml of chloroform, and stirred at room temperature for 1 hour, and the solvent was distilled off under reduced pressure to obtain the intended 1-(3,5-dichloro-1-methylpyrazol-4-yl)-2-phenyl-2-bromoethanone as white crystals. m.p.: 74.5–75.5° C.

Synthesis Example 13

Synthesis of 1-(3,5-dichloro-1-methylpyrazol-4-yl)-1-pivaloyloxy-2-phenyl-2-bromoethylene

(Compound No. IV-92)

0.55 g (1.58 mmols) of 1-(3,5-dichloro-1-methylpyrazol-4-yl)-2-phenyl-bromoethane and 0.18 g (1.74 mmols) of triethylamine were dissolved in 4 ml of dry tetrahydrofuran, and 0.19 g (1.58 mmols) of pivalic acid chloride was added thereto at room temperature. After the reaction mixture was stirred for 16 hours at room temperature, 10 ml of water was added thereto, and extracted with ethyl acetate. The organic layer was washed with water and saturated saline, and dried over anhydrous magnesium sulfate, and the solvent was distilled off under reduced pressure. The obtained residue was purified through silica gel column chromatography to obtain 0.23 g of the intended 1-(3,4-dichloro-1-methylpyrazol-4-yl)-1-pivaloyloxy-2-phenyl-2-bromoethylene as a colorless liquid (E–Z mixture).

¹H-NMR (CDCl₃, δ ppm); 1.05 (9H, s), 3.81 (3H, s), 7.37 (5H, m): major 1.32 (9H, s), 3.62 (3H, s), 7.24 (5H, m): minor

Synthesis Example 14

Synthesis of 1-(3,5-dichloro-1-methylpyrazol-4-yl)-2-{2-(1-methylcyclohexan-1-yl)-thiazol-4-yl}-2-diethylphosphonoethanone

(Compound No. II-156)

1) 4.15 g (18.1 mmols) of 2-(1-methyl-cyclohexan-1-yl)-4-chloromethylthiazole and 3.32 g (20 mmols) of trimethyl phosphate were mixed and heated under reflux for 16 hours. The reaction mixture was cooled to room temperature, and purified through silica gel column chromatography to obtain

188

4.63 g of the intended diethyl {2-(1-methylcyclohexan-1-yl)-thiazol-4-yl}methylphosphonate as a colorless liquid.

¹H-NMR (CDCl₃, δ ppm); 1.25 (3H, t, J=7.2 Hz), 1.31 (3H, s), 1.1–2.3 (10H, m), 3.33 (2H, d, J=20.4 Hz), 4.04 (4H, dd, J=7.2, 7.2 Hz), 7.01 (1H, m)

2) 0.85 g (4 mmols) of 3,5-dichloro-1-methylpyrazole-4-carboxylic acid chloride and 1.32 g (4 mmols) of diethyl {2-(1-methylcyclohexan-1-yl)-thiazol-4-yl}methylphosphonate were dissolved in 15 ml of dry tetrahydrofuran, and 1.12 g (10 mmols) of potassium t-butoxide was added thereto at room temperature. The reaction mixture was stirred for 1 hour at room temperature, and 20 ml of water was added thereto, and extracted with ethyl acetate. The organic layer was washed with water and saturated saline, and dried over anhydrous magnesium sulfate, and the solvent was distilled off under reduced pressure. The obtained residue was purified through silica gel column chromatography to obtain 0.4 g of the intended 1-(3,5-dichloro-1-methylpyrazol-4-yl)-2-{2-(1-methylcyclohexan-1-yl)-thiazol-4-yl}-2-diethylphosphonoethanone.

¹H-NMR (CDCl₃, δ ppm); 1.23 (3H, t, J=7.2 Hz), 1.23 (3H, s), 1.1–2.3 (10H, m), 3.79 (3H, s), 4.09 (2H, dd, J=7.2, 7.2 Hz), 5.90 (1H, d, J=22.8 Hz), 7.43 (1H, m)

Synthesis Example 15

Synthesis of allyl 2-{3-(2,6-difluorophenyl)pyrazol-1-yl}-3-(5-chloro-1-methyl-3-trifluoromethylpyrazol-4-yl)-3-hydroxyacrylate

(Compound No. I-133)

1) Potassium carbonate (1.53 g) was added to an acetonitrile (10 mL) solution of 3-(2,6-difluorophenyl)-pyrazole (1 g) and allyl 2-bromoacetate (1.49 g), and refluxed for 3 hours. The resulting product was extracted with acetate and diluted hydrochloric acid added thereto at room temperature. The organic layer was dried over anhydrous magnesium sulfate and concentrated, and the resulting concentrate was purified through silica gel column chromatography (chloroform) to obtain allyl 2-{3-(2,6-difluorophenyl)pyrazol-1-yl}acetate (1.5 g).

¹H-NMR (CDCl₃, δ ppm); 4.70 (2H, d, J=6.0 Hz), 5.10 (2H, s), 5.30–5.60 (2H, m), 5.70–6.40 (1H, m), 6.50–7.80 (5H, m)

2) Potassium butoxide (0.5 g) was added to a THF (10 mL) solution of allyl 2-{3-(2,6-difluorophenyl)pyrazol-1-yl}acetate (0.5 g) and 5-chloro-1-methyl-3-trifluoromethylpyrazole-4-carbonyl chloride (0.44 g) at 0° C. and stirred for 5 minutes. Water (5 ml) was added thereto, and then extracted with diluted hydrochloric acid and ethyl acetate. After the organic layer was dried over anhydrous magnesium sulfate, and then concentrated, and the resulting concentrate was purified through silica gel column chromatography (chloroform) to obtain the intended product, Compound No. I-133 (0.89 g).

¹H-NMR (CDCl₃, δ ppm): 3.95 (3H, s), 4.80 (2H, d, J=6.0 Hz), 5.20–5.60 (2H, m), 5.60–6.40 (1H, m), 6.45–7.90 (6H, m)

Synthesis Example 16

Synthesis of 2-bromo-2-{3-(2,6-difluorophenyl)pyrazol-1-yl}-1-(5-chloro-1-methyl-3-trifluoromethylpyrazol-4-yl)-1-hydroxyethylene

(Compound No. I-134)

1) Formic acid (60 mg) was added to a THF (1 mL) solution of palladium acetate (7 mg) and triphenylphosphine

(17 mg) and stirred for 5 minutes at room temperature in a nitrogen atmosphere. A THF (5 mL) solution of Compound I-133 (0.32 g) was added thereto and refluxed for 1 hour. The reaction mixture was left to be at room temperature, and concentrated, and the resulting concentrate was purified through silica gel column chromatography (chloroform) and recrystallization (chloroform-diisopropyl ether) to obtain 2-{3-(2,6-difluorophenyl)pyrazol-1-yl}-3-(5-chloro-1-methyl-3-trifluoromethylpyrazol-4-yl)ethan-1-one (0.1 g). m.p.: 152–154° C.

2) A THF solution (0.27 mL) of 1M lithium hexamethyldisilazide was added to a THF solution of 2-{3-(2,6-difluorophenyl)pyrazol-1-yl}-3-(5-chloro-1-methyl-3-trifluoromethylpyrazol-4-yl)ethan-1-one (0.1 g) at -78° C. and stirred at the same temperature in a nitrogen atmosphere. To the resulting solution was added a THF (2 mL) solution of carbon tetrabromide (0.098 g), and then gradually heated up to room temperature. Water (1 mL) was added thereto, and then extracted with diluted hydrochloric acid and ethyl acetate. The organic layer was dried over anhydrous magnesium sulfate, concentrated, and recrystallized from chloroform-diethyl ether) to obtain the intended product, Compound No. I-134 (0.062 g). m.p.: 123–125° C.

Synthesis Example 17

Synthesis of 2-bromo-2-{3-(2,6-difluorophenyl)pyrazol-1-yl}-1-(5-chloro-1-methyl-3-trifluoromethylpyrazol-4-yl)-1-pivaloyloxyethylene

(Compound No. I-135)

Triethylamine (0.3 g) and pivalic acid chloride (0.23 g) were added in that order to a chloroform (25 ml) solution of Compound No. I-134 (0.47 g) at 0° C., and stirred at room temperature for 1 hour. The resulting product was extracted with water and chloroform. The organic layer was dried with anhydrous magnesium sulfate, concentrated, and purified through silica gel column chromatography (chloroform) to obtain the intended product, Compound No. I-135 (0.4 g).

¹H-NMR (CDCl₃, δ ppm); 1.25 (9H, s), 3.90 (3H, s), 6.55–7.80 (5H, m)

In accordance with the above-mentioned reaction schemes or Examples, various compounds of the present invention were produced, of which the structure and the melting point are shown in Table 15 to Table 19 below. Unless otherwise specifically indicated, the compounds shown in these are in the form of a mixture of E-form and Z-form. The abbreviations in these have the same meanings as those mentioned above.

TABLE 15

No.	R ¹	R ²	R ³	E	B	A	m.p. (° C.)
I-1	Ph	H	H	CN	H	A1	144–145
I-2	Ph	Cl	H	CN	H	A1	300<
I-3	Ph	H	Me	CN	H	A1	300<
I-4	Ph	Me	H	CN	H	A1	141–143
I-5	Ph	H	H	CN	B1	A1	75–77*
I-6	Ph	H	H	CN	B2	A1	viscous oil
I-7	Ph	CO ₂ Et	H	CN	H	A1	202–203
I-8	Ph	H	H	CN	H	A2	300<
I-9	Ph	H	H	CN	H	A7	124–125
I-10	Ph	H	H	CN	H	A8	265–267
I-11	2-pyridyl	H	H	CN	H	A1	290<
I-12	2-pyridyl	H	H	CN	H	A2	300<
I-13	2-pyridyl	H	H	CN	H	A3	260–267
I-14	2-pyridyl	H	H	CN	H	A4	300<
I-15	2-pyridyl	H	H	CN	H	A6	297–298
I-16	2-pyridyl	H	H	CN	H	A7	163–165
I-17	2-pyridyl	H	H	CN	H	A8	300<
I-18	2-pyridyl	H	H	CN	H	A9	240–245
I-19	2-pyridyl	H	H	CN	H	A10	261–266
I-20	2-pyridyl	H	H	CN	H	A11	232–234
I-21	2-pyridyl	H	H	CN	H	A12	284–287
I-22	2-pyridyl	H	H	CN	H	A13	300<
I-23	2-pyridyl	H	H	CN	B7	A7	103–110*
I-24	2-pyridyl	H	H	CN	B8	A1	viscous oil
I-25	3-pyridyl	H	H	CN	H	A1	298–300
I-26	3-pyridyl	H	H	CN	H	A2	158–160
I-27	3-pyridyl	H	H	CN	H	A7	168–169
I-28	4-pyridyl	H	H	CN	H	A1	251–253
I-29	2-F—Ph	H	H	CN	H	A1	125–126
I-30	2-F—Ph	H	H	CN	H	A2	281–282
I-31	2-F—Ph	Cl	H	CN	H	A1	281–287
I-32	3-F—Ph	H	H	CN	H	A2	300<
I-33	4-F—Ph	H	H	CN	H	A2	169–173
I-34	2-Cl—Ph	H	H	CN	H	A1	viscous oil
I-35	2-Cl—Ph	H	H	CN	H	A2	viscous oil
I-36	3-Cl—Ph	H	H	CN	H	A1	141–149
I-37	3-Cl—Ph	H	H	CN	H	A7	291–293
I-38	4-Cl—Ph	H	H	CN	H	A1	186–188

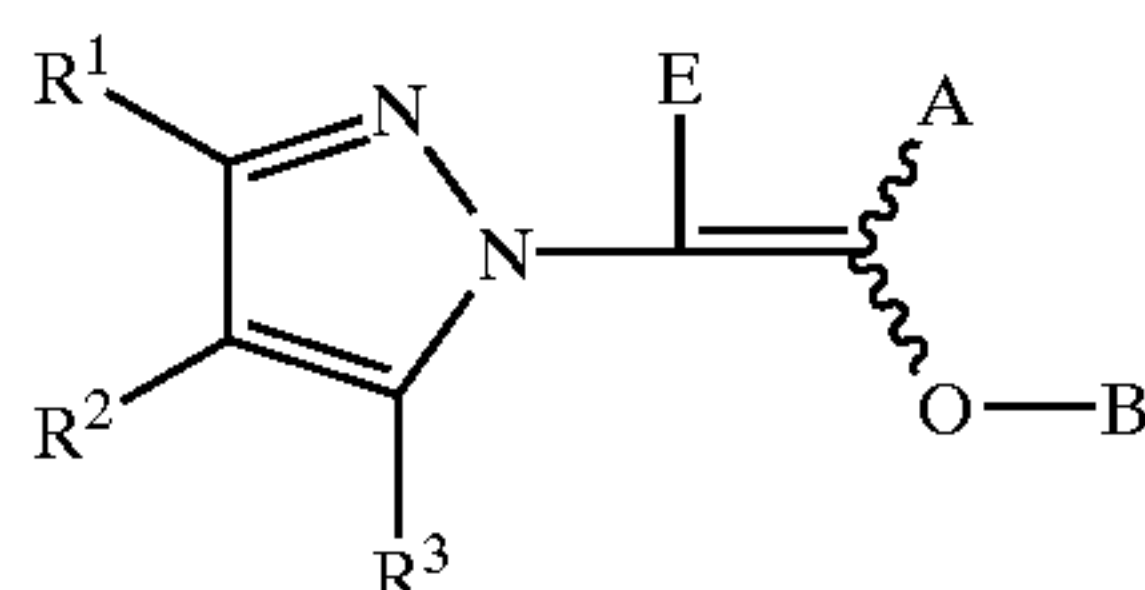
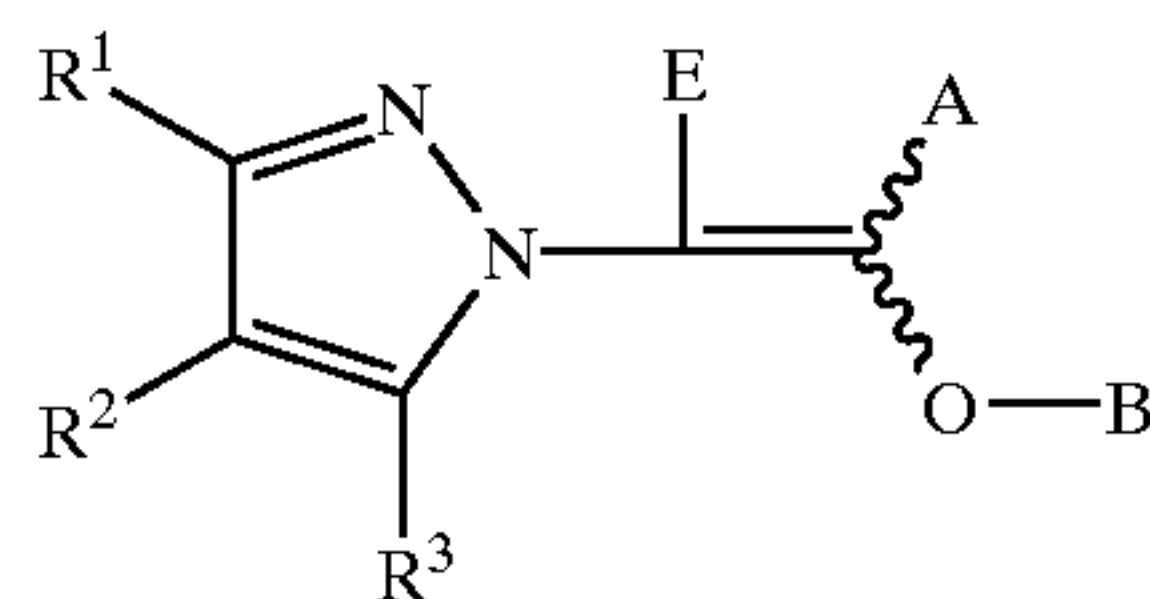
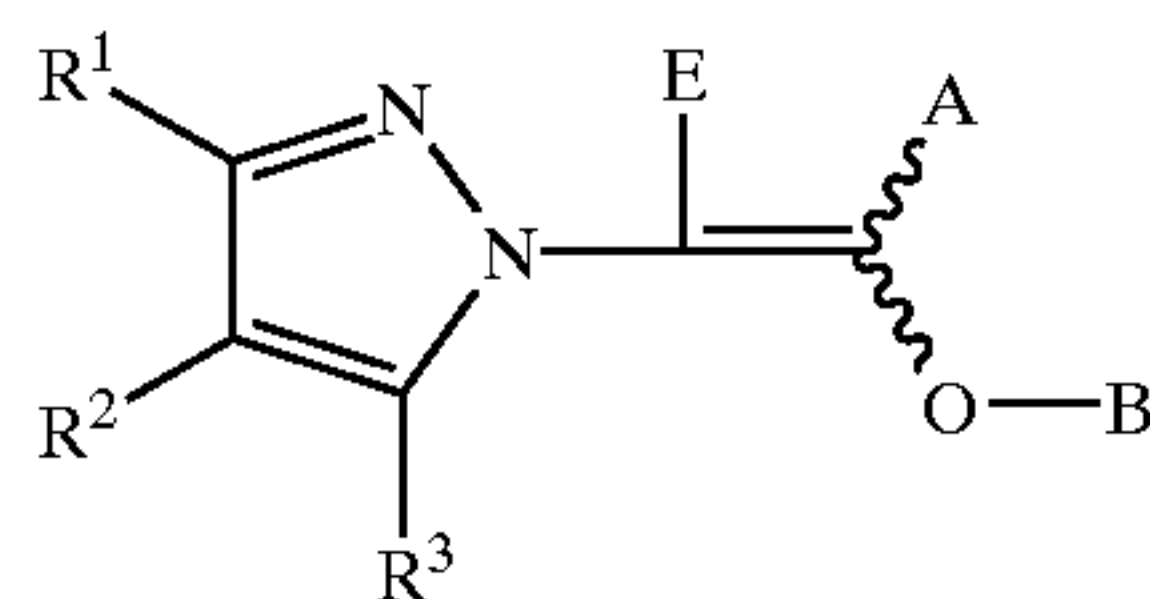

TABLE 15-continued



No.	R ¹	R ²	R ³	E	B	A	m.p. (° C.)
I-39	4-Cl—Ph	H	H	CN	H	A7	300<
I-40	2,6-F ₂ —Ph	H	H	CN	H	A1	267–269
I-41	2,6-F ₂ —Ph	H	H	CN	H	A2	300<
I-42	2,6-F ₂ —Ph	H	H	CN	H	A7	242–243
I-43	2,6-Cl ₂ —Ph	H	H	CN	H	A1	147–148
I-44	2,6-Cl ₂ —Ph	H	H	CN	H	A2	100–102
I-45	tBu	H	H	CN	H	A1	viscous oil
I-46	tBu	H	H	CN	H	A2	65–67
I-47	2-MeO—Ph	H	H	CN	H	A1	300<
I-48	2-MeO—Ph	H	H	CN	H	A2	300<
I-49	H	CO ₂ Et	Ph	CN	H	A1	236–237
I-50	Me	Ph	H	CN	H	A1	viscous oil
I-51	cHex	H	H	CN	H	A1	204–205
I-52	1-naphthyl	H	H	CN	H	A1	225–227
I-53	2-thienyl	H	H	CN	H	A1	146–147
I-54	2-thienyl	H	H	CN	H	A7	271–273
I-55	Ph	H	H	CN	H	A34	173.3–174.1
I-56	Ph	H	H	CN	B1	A34	viscous oil*
I-57	Ph	H	H	CN	B7	A1	140–141*
I-58	Ph	H	H	CN	B8	A1	50–51*
I-59	Ph	H	H	CN	CO ₂ ^t Bu	A1	viscous oil
I-60	tBu	CO ₂ Me	H	CN	H	A1	105–106
I-61	tBu	CO ₂ Me	H	CN	B7	A1	125–126
I-62	Ph	H	H	CN	B7	A2	viscous oil
I-63	2,6-F ₂ —Ph	H	H	CN	B8	A2	200–201
I-64	Ph	H	H	CN	B6	A2	viscous oil
I-65	2,6-F ₂ —Ph	H	H	CN	Na	2,6-(MeO) ₂ —Ph	300<
I-66	2,6-F ₂ —Ph	H	H	CN	Na	2-CF ₃ O—Ph	282.8–287.2
I-67	2,6-F ₂ —Ph	H	H	CN	Na	2-MeO—Ph	300<
I-68	2,6-F ₂ —Ph	H	H	CN	H	2-CF ₃ O—Ph	157.9–160.1
I-69	2-pyridyl	H	H	CN	B8	A7	118–119*
I-70	2,6-F ₂ —Ph	H	H	CN	B7	A2	viscous oil
I-71	Ph	H	H	CN	H	2-Cl—Ph	108–109
I-72	Ph	H	H	CN	H	2,6-F ₂ —Ph	167–168
I-73	Ph	H	H	CN	H	2,6-Cl ₂ —Ph	170–171
I-74	Ph	H	H	CN	H	2-CF ₃ —Ph	viscous oil
I-75	Ph	H	H	CN	H	1-naphthyl	137–138
I-76	Ph	Ph	H	CN	H	A2	145–147
I-77	Ph	H	H	CN	H	2-Cl-4-F—Ph	94–95
I-78	Ph	H	H	CN	B35	A2	164–165
I-79	2,6-F ₂ —Ph	H	H	CN	H	2-Me—Ph	113.1–119.8
I-80	2,6-F ₂ —Ph	H	H	CN	H	2-Cl-6-F—Ph	144–146
I-81	2,6-F ₂ —Ph	H	H	CN	H	2-NO ₂ —Ph	176–179
I-82	2,6-F ₂ —Ph	H	H	CN	H	2-AcO—Ph	vitreous state
I-83	2,6-F ₂ —Ph	H	H	CN	H	2,6-Me—Ph	vitreous state
I-84	2-pyridyl	H	H	CN	H	2,6-F ₂ —Ph	188–189
I-85	2-pyridyl	H	H	CN	H	2,6-Cl ₂ —Ph	278–280
I-86	2-pyridyl	H	H	CN	H	2-NO ₂ —Ph	285–287
I-87	2-pyridyl	H	H	CN	H	2-MeO—Ph	275–276
I-88	2-pyridyl	H	H	CN	H	2-CO ₂ Me—Ph	248–249
I-89	2-pyridyl	H	H	CN	B7	2-Cl—Ph	124–125
I-90	2-pyridyl	H	H	CN	Na	2-Cl—Ph	278–280
I-91	2-pyridyl	H	H	CN	H	pyridin-2-yl	216–217
I-92	2-pyridyl	H	H	CN	CO ⁿ C ₁₇ H ₃₅	A7	58–59
I-93	t-Bu	CO ₂ Me	H	CN	H	2-Cl-4-F—Ph	114–115
I-94	t-Bu	CO ₂ Me	H	CN	B7	A2	105–106
I-95	t-Bu	CO ₂ Me	H	CN	H	A2	102–103
I-96	t-Bu	H	H	CN	B7	A2	viscous oil
I-97	t-Bu	H	H	CN	B7	A2	viscous oil ^{#1}
I-98	t-Bu	NO ₂	H	CN	B7	A2	viscous oil
I-99	t-Bu	Br	H	CN	B7	A2	viscous oil
I-100	t-Bu	CN	H	CN	H	A2	178–180
I-101	t-Bu	CN	H	CN	CO ₂ ^t Bu	A2	vitreous state
I-102	t-Bu	CN	H	CN	CO ₂ ^t Bu	A2	201–202.5 ^{#2}
I-103	t-Bu	CN	H	CN	CO ₂ Ph	A2	vitreous state
I-104	t-Bu	Cl	H	CN	B7	A2	viscous oil
I-105	t-Bu	CO ₂ Me	H	CN	CO ₂ ^t Bu	A2	155.8–156.9
I-106	t-Bu	Cl	H	CN	H	A2	viscous oil

TABLE 15-continued



No.	R ¹	R ²	R ³	E	B	A	m.p. (° C.)
I-107	t-Bu	NO ₂	H	CN	H	A2	87-88
I-108	t-Bu	CO ₂ ⁿ Hex	H	CN	H	A2	vitreous state
I-109	t-Bu	CO ₂ Me	H	CN	B8	A2	152.1-153.5
I-110	t-Bu	Me	H	CN	H	A2	vitreous state
I-111	t-Bu	CO ₂ Me	H	CN	CO ⁿ C ₁₇ H ₃₅	A14	viscous oil
I-112	t-Bu	CO ₂ Me	H	CN	B7	A14	viscous oil
I-113	t-Bu	CO ₂ Me	H	CN	H	A14	101-102
I-114	t-Bu	Me	H	CN	B7	A2	vitreous state
I-115	t-Bu	CO ₂ Me	H	CN	B7	A3	131-132
I-116	t-Bu	CO ₂ Me	H	CN	Me	A2	166-167*
I-117	t-Bu	CO ₂ Me	H	CN	B3	A14	viscous oil
I-118	t-Bu	CO ₂ Me	H	CN	H	A21	152.6-154
I-119	t-Bu	CO ₂ Me	H	CN	CO ⁿ C ₉ H ₁₉	A3	viscous oil
I-120	t-Bu	CO ₂ Me	H	CN	B7	A15	125-127*
I-121	t-Bu	CO ₂ Me	H	CN	H	A15	138-139
I-122	t-Bu	CO ₂ Me	H	CN	B7	A21	viscous oil
I-123	t-Bu	CO ₂ Me	H	CN	CO ⁿ C ₅ H ₁₁	A21	viscous oil
I-124	t-Bu	CO ₂ Me	H	CN	CO ⁿ C ₅ H ₁₁	A21	viscous oil ^{#3}
I-125	H	H	2,6-F ₂ -Ph	CN	H	A2	157.4-162.4
I-126	H	Ph	H	CN	H	A1	vitreous state
I-127	H	t-Bu	H	CN	B7	A2	vitreous state
I-128	H	t-Bu	H	CN	H	A2	vitreous state
I-129	Ph	H	H	CO ₂ Me	H	A1	158-160
I-130	Ph	H	H	CO ₂ Me	B7	A2	viscous oil
I-131	2,6-F ₂ -Ph	H	H	CO ₂ Me	H	A2	248-250
I-132	2,6-F ₂ -Ph	H	H	COMe	H	A2	vitreous state
I-133	2,6-F ₂ -Ph	H	H	CO ₂ CH ₂ CH=CH ₂	H	A2	vitreous state
I-134	2,6-F ₂ -Ph	H	H	Br	H	A2	123-125
I-135	2,6-F ₂ -Ph	H	H	Br	B7	A2	vitreous state
I-136	2-pyridyl	H	H	CN	B7	A37	86-94 ^{#4}
I-137	2-pyridyl	H	H	CN	B7	A10	92-93
I-138	2-pyridyl	Cl	H	CN	B7	A7	viscous oil*

*E-form or Z-form

^{#1}geometric isomer of I-96^{#2}geometric isomer of I-101^{#3}geometric isomer of I-123^{#4}mixture of E/Z = 2/1

TABLE 16

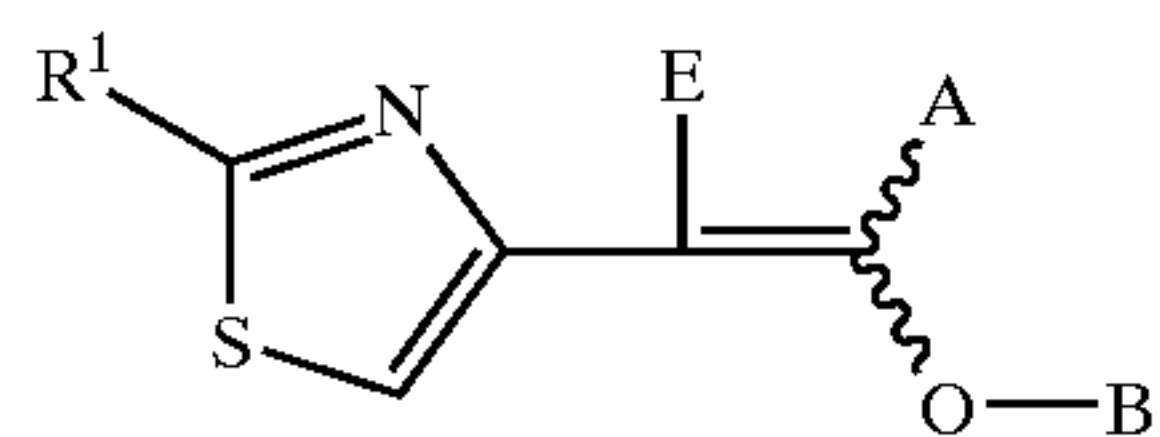

No.	R	E	B	A	m.p. (° C.)
II-1	Ph	CN	H	A1	200-205
II-2	2-Cl-Ph	CN	H	A2	137-138
II-3	t-Bu	CN	H	A2	151-153
II-4	t-Bu	CN	B3	A2	147-150*
II-5	t-Bu	CN	B7	A2	89.5-92*
II-6	t-Bu	CN	H	A1	viscous oil*
II-7	t-Bu	CN	B7	A1	viscous oil*
II-8	t-Bu	CN	H	2,6-F ₂ -Ph	90-92.5
II-9	t-Bu	CN	H	2-Cl-Ph	96.2-98.6
II-10	t-Bu	CN	B6	A2	vitreous state*
II-11	t-Bu	CN	B5	A2	viscous oil
II-12	t-Bu	CN	B8	A2	viscous oil
II-13	t-Bu	CN	SO ₂ (4-Cl-Ph)	A2	vitreous state*
II-14	t-Bu	CN	H	2,6-Cl ₂ -Ph	150.3-151.7
II-15	t-Bu	CN	H	2-CF ₃ -Ph	71.9-79.6
II-16	t-Bu	CN	H	A3	viscous oil
II-17	t-Bu	CN	B7	A3	viscous oil*

TABLE 16-continued

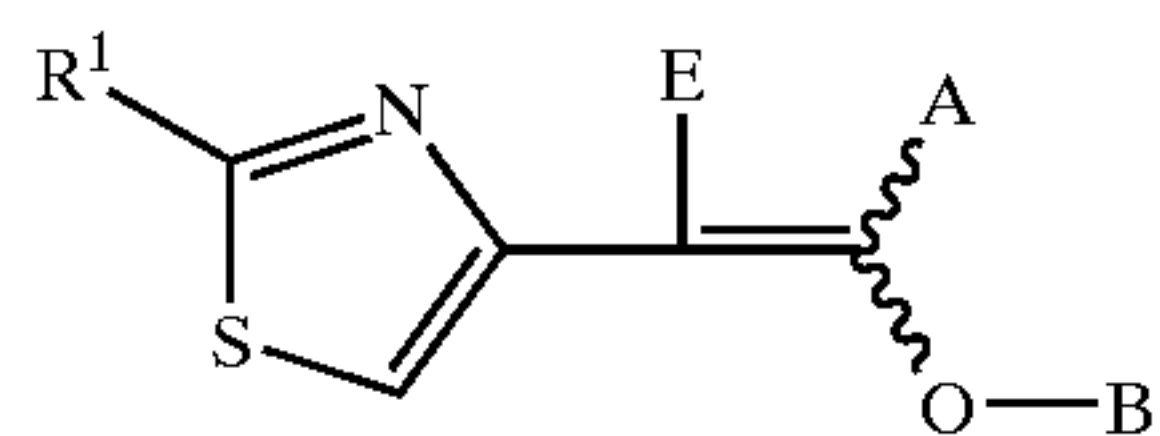

No.	R	E	B	A	m.p. (° C.)
II-18	t-Bu	CN	CO ₂ Et	A2	viscous oil
II-19	t-Bu	CN	CO ₂ CH ₂ Ph	A2	viscous oil
II-20	t-Bu	CN	CONMe ₂	A2	136.7–138.2
II-21	t-Bu	CN	CH ₂ CO ₂ Me	A2	viscous oil
II-22	t-Bu	CN	PO(OEt) ₂	A2	viscous oil
II-23	2-pyridyl	CN	H	A2	184.5–188.5
II-24	2-pyridyl	CN	H	A7	210.3–218.8
II-25	2-pyridyl	CN	B7	A7	162.7–167*
II-26	2-pyridyl	CN	B7	A2	vitreous state*
II-27	2-pyridyl	CN	H	A3	148–151
II-28	2-pyridyl	CN	B7	A3	vitreous state*
II-29	2-pyridyl	CN	H	A35	188–193
II-30	2-pyridyl	CN	B7	A35	200.5–202.5*
II-31	2-pyridyl	CN	H	A36	viscous oil
II-32	2-pyridyl	CN	B7	A36	viscous oil
II-33	c-Hex	CN	H	A2	126.5–128.1
II-34	c-Hex	CN	H	2,6-F ₂ —Ph	110.9–112.7
II-35	c-Hex	CN	B7	2,6-F ₂ —Ph	111.2–117.4*
II-36	c-Hex	CN	B7	A2	viscous oil*
II-37	2,6-F ₂ —Ph	CN	H	A2	176.8–178.2
II-38	2,6-F ₂ —Ph	CN	B7	A2	95.9–98.0*
II-39	2-Cl—Ph	CN	H	A2	172.9–175.2
II-40	t-Bu	CN	B35	A2	vitreous state
II-41	t-Bu	CN	B35	A2	vitreous state ^{#4}
II-42	t-Bu	CN	B36	A2	vitreous state
II-43	t-Bu	CN	H	A13	168–173
II-44	t-Bu	CN	B28	A2	vitreous state
II-45	t-Bu	CN	B30	A2	vitreous state
II-46	t-Bu	CN	B30	A2	vitreous state ^{#5}
II-47	t-Bu	CN	CO(2-Me—Ph)	A2	vitreous state
II-48	t-Bu	CN	B38	A2	vitreous state
II-49	t-Bu	CN	B37	A2	vitreous state
II-50	t-Bu	CN	nicotinoyl	A2	vitreous state
II-51	t-Bu	CN	B40	A2	vitreous state
II-52	t-Bu	CN	CO ₂ ⁱ Bu	A2	viscous oil
II-53	t-Bu	CN	CO ₂ Ph	A2	viscous oil
II-54	t-Bu	CN	B41	A2	viscous oil
II-55	t-Bu	CN	CO ₂ ⁿ Hex	A2	viscous oil
II-56	t-Bu	CN	H	3-Cl—Ph	89.7–91.1
II-57	t-Bu	CN	H	3-F—Ph	63.7–64.4
II-58	t-Bu	CN	H	2-Br—Ph	86–87
II-59	t-Bu	CN	H	2-I—Ph	vitreous state
II-60	t-Bu	CN	H	2-Cl-6-F—Ph	109.6–110.6
II-61	t-Bu	CN	CO(2-MeS—Ph)	A2	vitreous state
II-62	t-Bu	CN	H	2-MeS—Ph	120.6–122.1
II-63	t-Bu	CN	H	A22	113–118
II-64	t-Bu	CN	B7	A22	98–99.5*
II-65	t-Bu	CN	B15	A22	viscous oil
II-66	t-Bu	CN	B38	A13	viscous oil
II-67	t-Bu	CN	B39	A2	vitreous state
II-68	t-Bu	CN	CO(4-Cl—Ph)	A2	vitreous state
II-69	t-Bu	CN	CO(3-Cl—Ph)	A2	vitreous state
II-70	t-Bu	CN	B7	2,6-F ₂ —Ph	viscous oil
II-71	t-Bu	CN	B8	2,6-F ₂ —Ph	viscous oil
II-72	t-Bu	CN	B6	2,6-F ₂ —Ph	150.2–151.3
II-73	t-Bu	CN	CO ₂ ⁿ Pr	A2	viscous oil
II-74	t-Bu	CN	CO ₂ ⁿ Bu	A2	viscous oil
II-75	t-Bu	CN	B6	A13	viscous oil
II-76	t-Bu	CN	CO ₂ CH ₂ CCl ₃	A2	viscous oil
II-77	t-Bu	CN	CO(2-Cl—Ph)	A2	vitreous state
II-78	t-Bu	CN	CO(3-CF ₃ —Ph)	A2	vitreous state
II-79	t-Bu	CN	CO(4-CF ₃ —Ph)	A2	vitreous state
II-80	t-Bu	CN	CO(3-NO ₂ —Ph)	A2	vitreous state
II-81	t-Bu	CN	CO(2-Cl-6-F—Ph)	A2	vitreous state
II-82	t-Bu	CN	CO ₂ ^o Pen	2,6-F ₂ —Ph	vitreous state
II-83	t-Bu	CN	3-Cl-pivaloyl	A2	viscous oil*
II-84	t-Bu	CN	CO ₂ ⁱ Pr	A2	viscous oil
II-85	t-Bu	CN	CO ₂ CH ₂ CH ₂ Cl	A2	viscous oil
II-86	t-Bu	CN	CO ₂ CHClCH ₃	A2	viscous oil
II-87	t-Bu	CN	CO ⁱ Pr	A2	viscous oil

TABLE 16-continued

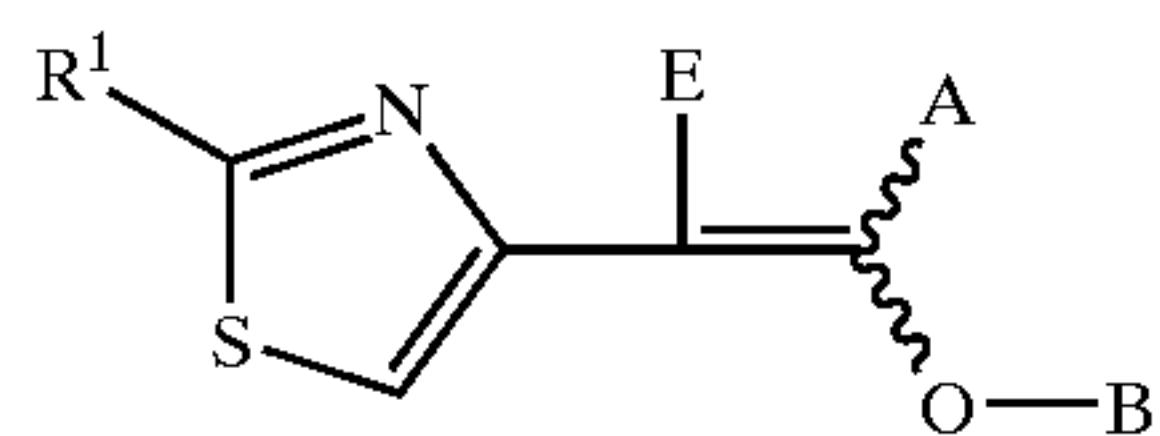

No.	R	E	B	A	m.p. (° C.)
II-88	t-Bu	CN	isonicotinoyl	A2	viscous oil
II-89	t-Bu	CN	picolinoyl	A2	viscous oil
II-90	t-Bu	CN	CO(4-Me—Ph)	A2	viscous oil
II-91	t-Bu	CN	CO(4-NO ₂ —Ph)	A2	viscous oil
II-92	t-Bu	CN	methacryloyl	A2	viscous oil
II-93	t-Bu	CN	B15	A2	vitreous state
II-94	t-Bu	CN	PhCH ₂	A2	viscous oil
II-95	t-Bu	CN	Me	A2	136.5–138
II-96	t-Bu	CN	CBrF ₂	A2	84–86.5
II-97	t-Bu	CN	CO ⁿ Pr	A2	viscous oil
II-98	t-Bu	CN	CO ⁱ Bu	A2	viscous oil
II-99	t-Bu	CN	B43	A2	vitreous state
II-100	t-Bu	CN	PhCOCH ₂	A2	148–152*
II-101	t-Bu	CN	B42	A2	128–129.5*
II-102	t-Bu	CN	H	A14	98–99
II-103	t-Bu	CN	H	A16	viscous oil
II-104	t-Bu	CN	B7	A16	viscous oil*
II-105	t-Bu	CN	cinnamoyl	A2	vitreous state
II-106	t-Bu	CN	H	A23	109–112
II-107	t-Bu	CN	B7	A23	120–122.5
II-108	t-Bu	CN	B7	A14	viscous oil
II-109	t-Bu	CN	B7	A14	viscous oil ^{#6}
II-110	t-Bu	CN	CO ⁿ C ₁₇ H ₃₅	A14	viscous oil
II-111	t-Bu	CN	PhCH ₂ CO	A2	viscous oil
II-112	t-Bu	CN	B7	A17	viscous oil
II-113	t-Bu	CN	H	A17	140–143
II-114	t-Bu	CN	H	A24	115–117
II-115	t-Bu	CN	CO ₂ ⁱ Bu	A24	vitreous state
II-116	t-Bu	CN	B7	A2	69.5–73.5 ^{#7}
II-117	t-Bu	CN	H	A25	107–109
II-118	t-Bu	CN	B7	A25	viscous oil
II-119	t-Bu	CN	H	A31	116–117
II-120	t-Bu	CN	CO ₂ (4-Me—Ph)	A31	92–93
II-121	t-Bu	CN	H	A26	133.2–135.4
II-122	t-Bu	CN	B7	A26	133.9–145
II-123	t-Bu	CN	H	A27	46–47
II-124	t-Bu	CN	H	A28	168–169
II-125	t-Bu	CN	H	A29	94.7–95.4
II-126	t-Bu	CN	B8	A29	viscous oil
II-127	t-Bu	CN	B8	A29	viscous oil ^{#8}
II-128	t-Bu	CN	H	A32	133.9–134.4
II-129	t-Bu	CN	H	A33	220–230
II-130	2,6-F ₂ —Ph	CN	H	2-6-F ₂ —Ph	138–143
II-131	2-pyridyl	CN	B7	A18	115–145
II-132	2-pyridyl	CN	H	A18	176–178
II-133	2-pyridyl	CN	H	A9	191.5–195
II-134	2-pyridyl	CN	B7	A9	101–103
II-135	2-pyridyl	CN	H	A8	211–216
II-136	2-pyridyl	CN	H	A10	189–193
II-137	2-pyridyl	CN	CO ₂ (4-F—Ph)	A10	137–142
II-138	2-pyridyl	CN	H	A24	188–191.5
II-139	2-pyridyl	CN	B7	A24	160–163.5
II-140	2-pyridyl	CN	B7	A30	123–125
II-141	2-pyridyl	CN	H	A30	165–166
II-142	2-pyridyl	CN	H	A13	149.5–151
II-143	NMePh	CN	H	A7	161.5–164
II-144	NMePh	CN	B7	A7	120–123
II-145	NMePh	CN	H	A2	vitreous state
II-146	NMePh	CN	B7	A2	vitreous state
II-147	1-piperidyl	CN	B3	A2	165.5–169
II-148	1-piperidyl	CN	H	A2	151–153
II-149	1-piperidyl	CN	H	A7	187–190
II-150	1-piperidyl	CN	B8	A7	viscous oil
II-151	1-piperidyl	CN	B8	A2	120–121.5
II-152	1-piperidyl	CN	B6	A2	viscous oil
II-153	1-naphthyl	CN	H	A2	161–163
II-154	1-naphthyl	CN	B7	A2	vitreous state
II-155	t-Bu	CO ₂ Me	H	A2	viscous oil
II-156	1-Me-1-°Hex	PO(OEt) ₂	H	A1	vitreous state
II-157	t-Bu	CO ₂ Et	H	A1	viscous oil

TABLE 16-continued

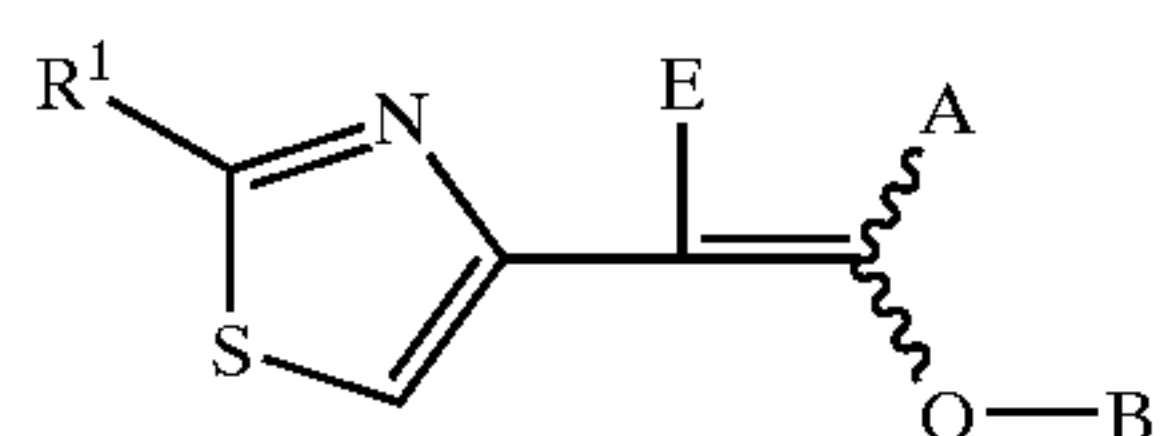

No.	R	E	B	A	m.p. (° C.)
II-158	t-Bu	CO ₂ Et	B7	A1	viscous oil
II-159	1-Me-1- ⁴ Hex	CN	H	A2	vitreous state
II-160	n-Pen	CN	H	A2	73-75
II-161	t-Bu	CN	B8	A32	108-112
II-162	t-Bu	CN	H	A1	viscous oil
II-163	t-Bu	CO ₂ Me	H	A1	89-92
II-164	t-Bu	SO ₂ Ph	H	A1	145-148
II-165	t-Bu	SO ₂ Ph	B7	A1	122-123
II-166	t-Bu	SO ₂ Ph	B7	A1	152-153 ^{#14}
II-167	t-Bu	CO ₂ Me	B7	A1	viscous oil
II-168	t-Bu	CO ₂ Me	B7	A2	76-78
II-169	t-Bu	CO ₂ CH ₂ CH=CH ₂	H	A2	viscous oil
II-170	t-Bu	CO ₂ CH ₂ CH=CH ₂	B7	A2	viscous oil
II-171	1-Me-1- ⁴ Hex	CN	B7	A2	vitreous state
II-172	n-Pen	CN	B7	A2	vitreous state
II-173	1-Me-1- ⁴ Hex	CN	CH ₂ O(CH ₂) ₂ OCH ₃	A2	97-98*
II-174	t-Bu	5-Me-1,3,4-oxadiazol-2-yl	H	A1	vitreous state
II-175	t-Bu	5-Me-1,3,4-oxadiazol-2-yl	H	A1	vitreous state
II-176	t-Bu	Bu	H	A2	viscous oil
II-177	t-Bu	CN	B6	A13	104-107*
II-178	t-Bu	5-Me-1,3,4-oxadiazol-2-yl	B7	A1	134-137
II-179	t-Bu	5-Me-1,3,4-oxadiazol-2-yl	B7	A1	114-116 ^{#15}
II-180	t-Bu	5-Me-1,3,4-thiadiazol-2-yl	B7	A1	86-90*

*E-form or Z-form

^{#4}geometric isomer of II-40^{#5}geometric isomer of II-45^{#6}geometric isomer of II-108^{#7}geometric isomer of II-5^{#8}geometric isomer of II-126^{#14}geometric isomer of II-165^{#15}geometric isomer of II-178

TABLE 17

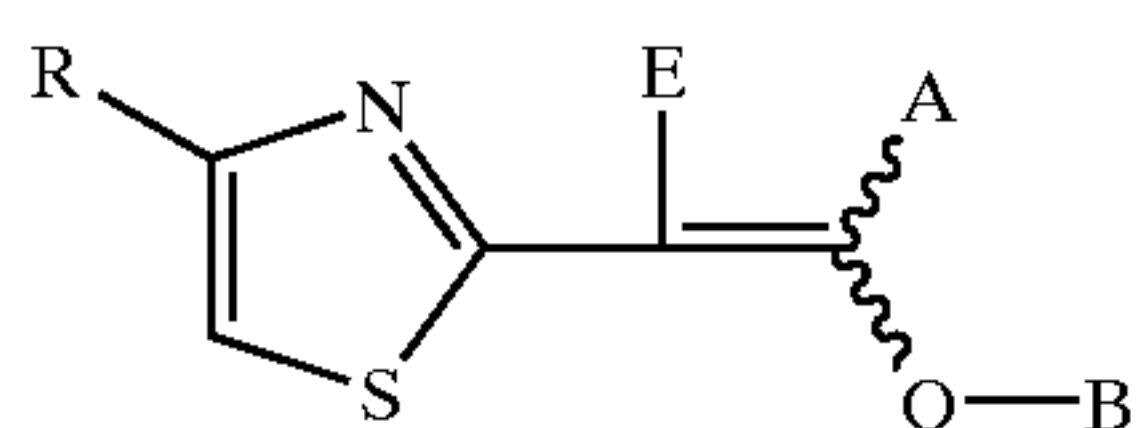

No.	R	E	B	A	m.p. (° C.)
III-1	Ph	CN	B4	A1	viscous oil*
III-2	Ph	CN	B5	A1	40-41*
III-3	t-Bu	CN	B1	A1	151-152*
III-4	t-Bu	CN	B4	A1	77-79*
III-5	t-Bu	CN	B6	A2	55-61*
III-6	t-Bu	CN	B7	A2	viscous oil*
III-7	2-pentyl	CN	B1	A1	viscous oil
III-8	4- ^t Bu-Ph	CN	B1	A5	viscous oil
III-9	t-Bu	CN	Na	A2	165-174
III-10	t-Bu	CN	B9	A2	viscous oil
III-11	t-Bu	CN	B10	A2	185-186*
III-12	t-Bu	CN	B11	A2	viscous oil
III-13	2-NO ₂ -Ph	CN	B9	A1	168-171*
III-14	1-naphthyl	CN	B9	A7	136-138*
III-15	t-Bu	CN	B7	A2	viscous oil ^{#9}
III-16	Ph	CN	B4	A1	solid ^{#10}

TABLE 17-continued

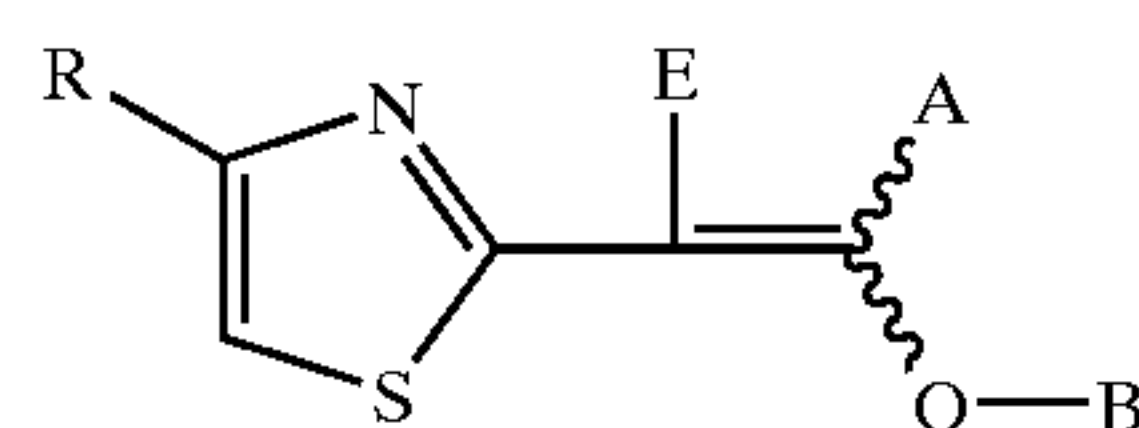

No.	R	E	B	A	m.p. (° C.)	
55	III-17	t-Bu	CN	B4	A1	viscous oil ^{#11}
	III-18	2-Cl-6-F-Ph	CN	B7	A2	152-153
	III-19	2,6-F ₂ -Ph	CN	B7	A2	vitreous state*
	III-20	Ph	CN	B5	A1	105-107 ^{#12}
60	III-21	Ph	CN	B7	A2	viscous oil

*E-form or Z-form,
^{#9}geometric isomer of III-6,
^{#10}geometric isomer of III-1,
^{#11}geometric isomer of III-4,
^{#12}geometric isomer of III-2

TABLE 18

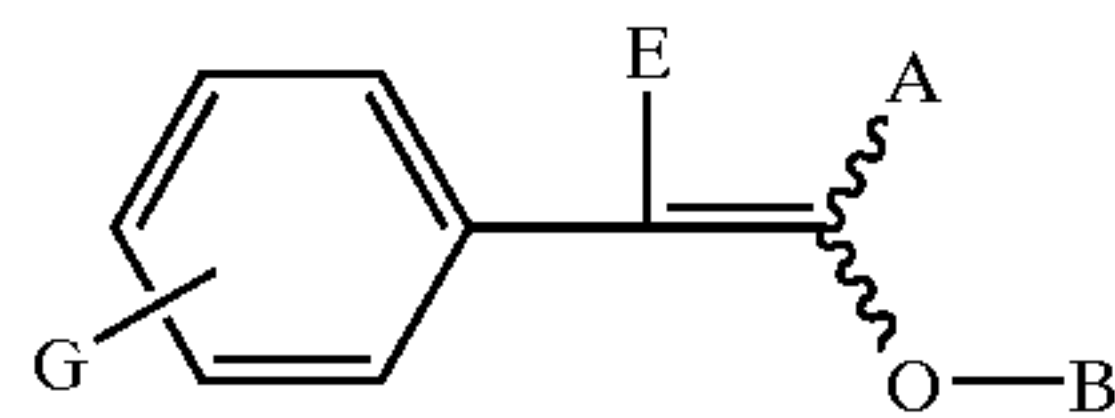

No.	G	E	B	A	m.p. (° C.)
IV-1	2-CF ₃	CN	H	A1	viscous oil
IV-2	3-CF ₃	CN	H	A1	159-163
IV-3	3-CF ₃	CN	B1	A1	174-175
IV-4	4-CF ₃	CN	H	A1	176-179
IV-5	4-CF ₃	CN	B1	A1	viscous oil
IV-6	2-CF ₃	CN	CSNMe ₂	A1	viscous oil
IV-7	3(1-CN-1-Me)—Et	CN	H	A1	viscous oil
IV-8	3(1-CN-1-Me)—Et	CN	B1	A1	148-155
IV-9	3-OPh	CN	H	A1	103-110
IV-10	3-OPh	CN	B7	A1	viscous oil
IV-11	4-OPh	CN	H	A1	148-150
IV-12	4-OPh	CN	B7	A1	viscous oil
IV-13	4-Et	CN	H	A1	148-149
IV-14	4-Et	CN	B7	A1	81-82
IV-15	4-Et	CN	B5	A1	viscous oil
IV-16	4-i-Pr	CN	H	A1	126-127
IV-17	4-i-Pr	CN	B7	A1	105-106
IV-18	4-t-Bu	CN	H	A1	117-118
IV-19	4-t-Bu	CN	B1	A1	viscous oil
IV-20	4-OCF ₃	CN	H	A1	128-129
IV-21	4-OCF ₃	CN	B7	A1	96-99
IV-22	3,4-methylene-dioxy	CN	H	A1	129-131
IV-23	3,4-methylene-dioxy	CN	B7	A1	viscous oil
IV-24	4-t-Bu	CN	B7	A2	viscous oil
IV-25	4-t-Bu	CN	B15	A2	viscous oil
IV-26	4-t-Bu	CN	H	A2	139-140
IV-27	4-t-Bu	CN	B7	A13	87-88
IV-28	4-t-Bu	CN	H	A13	141-142
IV-29	4-t-Bu	CN	B8	A2	vitreous state
IV-30	4-t-Bu	CN	H	A19	169.5-173
IV-31	4-t-Bu	CN	H	A20	vitreous state
IV-32	4-t-Bu	CN	B7	A20	146-148
IV-33	4-t-Bu	CN	B15	A14	viscous oil
IV-34	4-t-Bu	CN	B7	A19	vitreous state
IV-35	4-t-Bu	CN	B7	A1	viscous oil*
IV-36	4-t-Bu	CN	B8	A1	viscous oil
IV-37	4-t-Bu	CN	H	A24	vitreous state
IV-38	4-t-Bu	CN	B8	A24	vitreous state
IV-39	4-t-Bu	CN	CO ₂ Et	A1	viscous oil
IV-40	4-t-Bu	CN	CO ₂ ^t Bu	A1	viscous oil
IV-41	4-t-Bu	CN	COCO ₂ CH ₃	A1	viscous oil
IV-42	4-s-Bu	CN	H	A2	107-108
IV-43	4-s-Bu	CN	B15	A2	77-85
IV-44	4-i-Pr	CN	B15	A1	100-101
IV-45	4-i-Pr	CN	B15	A2	viscous oil
IV-46	4-i-Pr	CN	H	A2	98-99
IV-47	4-i-Pr	CN	B8	A2	viscous oil
IV-48	4-i-Pr	CN	CO(4-NO ₂ —Ph)	A2	vitreous state
IV-49	4-Et	CN	B15	A1	viscous oil
IV-50	4-Ph	CN	H	A1	vitreous state
IV-51	4-Ph	CN	H	A2	vitreous state
IV-52	4-Ph	CN	H	A12	vitreous state
IV-53	4-Ph	CN	H	A13	167-169
IV-54	3,4-Cl ₂	CN	H	A1	vitreous state
IV-55	4-Cl	CN	H	A1	vitreous state
IV-56	2-F-4-CF ₃	CN	H	A2	vitreous state
IV-57	2-F-4-CF ₃	CN	B7	A2	vitreous state
IV-58	2-F-4-CF ₃	CN	B15	A2	vitreous state
IV-59	4-NO ₂	CN	H	A1	186-188
IV-60	4-MeO	CN	H	A1	108-110
IV-61	4-MeO	CN	B15	A1	viscous oil*
IV-62	4-i-PrO	CN	H	A1	127-131
IV-63	4-i-PrO	CN	H	A2	141.4-148.3
IV-64	4-i-PrO	CN	B15	A1	viscous oil
IV-65	4-i-PrO	CN	B15	A2	viscous oil
IV-66	4-i-PrO	CN	B6	A2	viscous oil
IV-67	4-n-BuO	CN	H	A1	101-104
IV-68	4-n-BuO	CN	B15	A1	75-70

TABLE 18-continued

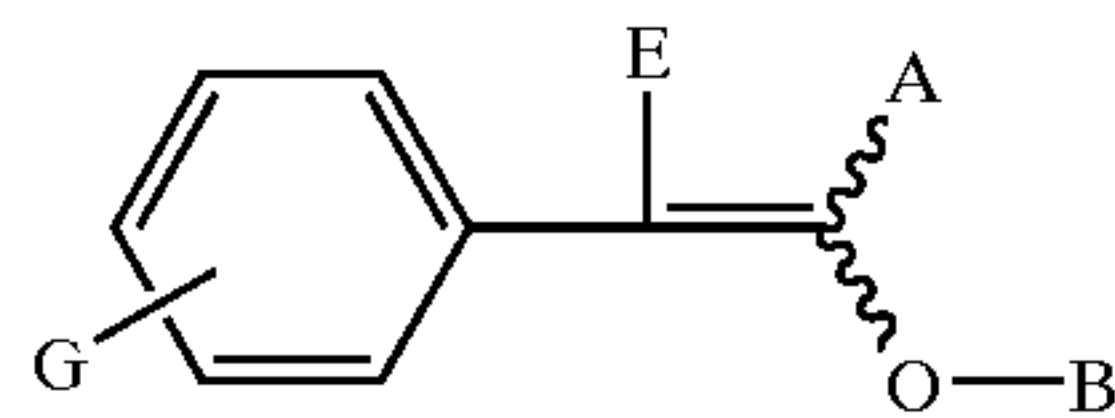

No.	G	E	B	A	m.p. (° C.)
IV-69	4-n-BuO	CN	H	A2	104.6-105.4
IV-70	4-n-BuO	CN	B8	A1	77.1-80.7
IV-71	4-n-BuO	CN	B15	A2	viscous oil
IV-72	4-t-amyl	CN	B15	A2	viscous oil
IV-73	4-allyloxy	CN	H	A1	vitreous state
IV-74	4-allyloxy	CN	B15	A1	vitreous state
IV-75	4-(Cl ₂ C=CHCH ₂ O)	CN	H	A1	vitreous state
IV-76	4-(Cl ₂ C=CHCH ₂ O)	CN	B15	A1	vitreous state
IV-77	4-(ClCCCH ₂ O)	CN	H	A1	vitreous state
IV-78	4-PhCH ₂ O	CN	H	A1	152.9-154.7
IV-79	4-PhCH ₂ O	CN	H	A2	189-190.5
IV-80	4-PhCH ₂ O	CN	B15	A2	123-129
IV-81	4-MeOCH ₂ O	CN	H	A1	130.4-131.7
IV-82	4-CF ₃ CH ₂ O	CN	H	A1	100-103
IV-83	4-pivaloyl	CN	B15	A2	vitreous state
IV-84	4-pivaloyl	CN	H	A2	vitreous state
IV-85	4-Me ₂ NCO ₂	CN	H	A2	vitreous state
IV-86	4-Me ₂ NCO ₂	CN	B15	A2	vitreous state
IV-87	4-Me ₂ NCO ₂	CN	B7	A2	vitreous state
IV-88	4-t-Bu	PO(OEt) ₂	H	A1	87-88
IV-89	4-t-Bu	PO(OEt) ₂	B1	A1	121-124
IV-90	H	Br	H	A1	74.5-75.5
IV-91	H	CO ₂ Et	H	A1	viscous oil
IV-92	H	Br	B7	A1	viscous oil
IV-93	4-t-Bu	PO(OEt) ₂	H	A2	viscous oil
IV-94	4-t-Bu	CN	COCO ₂ Et	A1	viscous oil
IV-95	4-t-Bu	CN	CO ₂ ⁱ Bu	A2	viscous oil
IV-96	4-t-Bu	CN	CO ₂ ⁱ Bu	A13	104-105
IV-97	4-t-Bu	SO ₂ Ph	H	A1	143-145
IV-98	H	CO ₂ Et	B7	A1	viscous oil
IV-99	4-t-Bu	CN	B3	A1	viscous oil
IV-100	4-t-Bu	CN	B19	A1	vitreous state
IV-101	4-t-Bu	CN	CO(4-CO ₂ Me-Ph)	A2	vitreous state
IV-102	4-t-Bu	CN	CO(4-CO ₂ Me-Ph)	A13	vitreous state
IV-103	4-t-Bu	CO ₂ Me	H	A2	88-89
IV-104	4-t-Bu	CO ₂ Me	H	A1	123-124
IV-105	4-t-Bu	CO ₂ Me	B7	A1	77-78
IV-106	4-t-Bu	CO ₂ Me	B7	A2	viscous oil
IV-107	4-t-Bu	SO ₂ Ph	B7	A1	98-99
IV-108	4-t-Bu	SO ₂ Ph	B7	A1	130-131 ^{#13}
IV-109	4-t-Bu	CN	B3	A2	71-72*
IV-110	4-CHF ₂ O	CN	H	A2	vitreous state
IV-111	4-CHF ₂ O	CN	B15	A2	vitreous state
IV-112	4-CHF ₂ O	CN	B7	A2	vitreous state
IV-113	4-CH ₃ CONH	CN	H	A2	247.9-251.9
IV-114	4-CH ₃ CONH	CN	B7	A2	82.1-84.3
IV-115	4-CO ₂ Me	CN	H	A2	151-152
IV-116	4-CO ₂ Me	CN	B7	A2	viscous oil*
IV-117	4-vinyl	CN	H	A2	vitreous state
IV-118	4-t-Bu	CN	B15	A1	78-82
IV-119	4-t-Bu	CN	methacryloyl	A1	viscous oil*
IV-120	4-t-Bu	CN	COCH=(CH ₃) ₂	A1	viscous oil
IV-121	4-t-Bu	CN	B33	A1	viscous oil
IV-122	4-t-Bu	CN	CH ₂ OCH ₂ Ph	A1	viscous oil
IV-123	4-t-Bu	CN	B24	A1	viscous oil
IV-124	H	Cl	H	A1	48-49
IV-125	4-t-Bu	5-Me-1,3,4-oxadiazol-2-yl	H	A1	149-151
IV-126	4-SMe	CN	H	A2	154-156
IV-127	4-SMe	CN	B7	A2	viscous oil*
IV-128	4-SOMe	CN	H	A2	vitreous state
IV-129	4-t-Bu	CN	B33	A2	viscous oil
IV-130	4-t-Bu	CN	B3	A13	111-112*
IV-131	4-t-Bu	CN	B7	A3	viscous oil
IV-132	4-t-Bu	CN	B3	A3	viscous oil
IV-133	4-t-Bu	CN	COCH ₂ (4-OMe-Ph)	A1	117-123
IV-134	4-SO ₂ Me	CN	B7	A2	vitreous state*
IV-135	4-SOMe	CN	B7	A2	vitreous state*
IV-136	4-OCH ₂ Ph-3-Cl	CN	H	A2	vitreous state

TABLE 18-continued

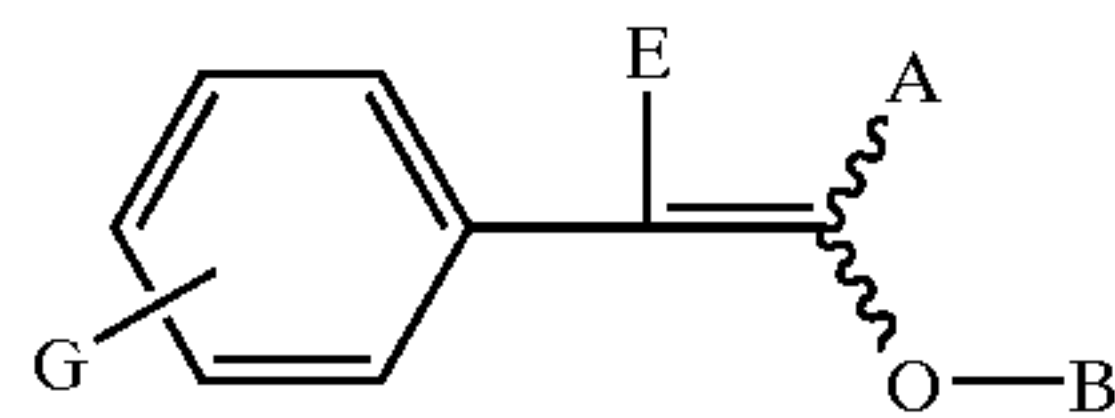

No.	G	E	B	A	m.p. (° C.)
IV-137	4-OPr ⁱ -3-Cl	CN	H	A2	vitreous state
IV-138	4-OBu ⁱ -3-Cl	CN	H	A2	vitreous state
IV-139	4-t-Bu	CN	B8	A3	viscous oil
IV-140	4-t-Bu	CN	B7	2-Cl-4-CF ₃ - thiazol-5-yl	90-91

*E-form or Z-form

#¹³geometric isomer of IV-107

TABLE 19

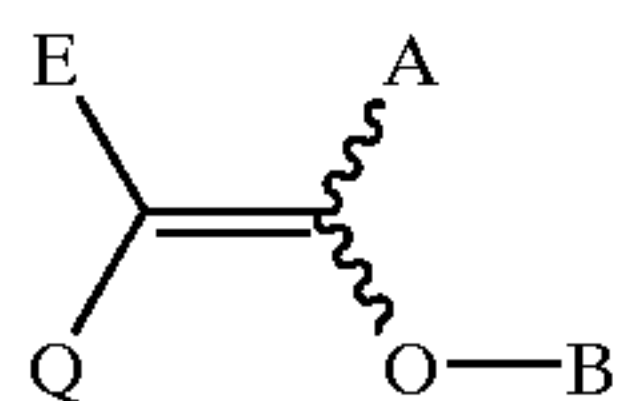

No.	Q	R	E	B	A	m.p. (° C.)
V-1	Q9	1-Ph	CN	H	A1	148.7-151.3
V-2	Q9	1-Ph	CN	H	A2	156-157
V-3	Q9	5-Me-1- ⁱ Pr	CN	H	A2	78-80
V-4	Q9	5-Me-1- ⁱ Bu	CN	B7	A2	84-89*
V-5	Q9	5-Me-1- ^s Bu	CN	B7	A2	99-105
V-6	Q9	5-Me-1- ⁱ Bu	CN	H	A2	113-114
V-7	Q9	5-Me-1- ^s Bu	CN	H	A2	75-80
V-8	Q9	1-t-Bu	CN	B7	A2	vitreous state*
V-9	Q9	1-t-Bu	CN	H	2,6-F ₂ -Ph	111-113
V-10	Q9	1-t-Bu	CN	H	A2	127-129
V-11	Q9	1-pyridin- 2-yl	CN	H	A2	156.4-158.1
V-12	Q9	1-pyridin- 2-yl	CN	B15	A2	vitreous state*
V-13	Q9	1-pyridin- 2-yl	CN	B7	A2	vitreous state*
V-14	Q10	1-Ph	CN	B7	A2	130-131
V-15	Q10	1-Ph	CN	H	A2	207-208
V-16	Q10	1-t-Bu	CN	B7	A2	viscous oil
V-17	Q10	1-t-Bu	CN	H	A2	viscous oil
V-18	Q11	1-Me-3- ^t Bu	CN	H	A2	vitreous state
V-19	Q11	1-Me-3- ^t Bu	CN	B7	A2	119-124
V-20	Q12	Ph	CN	H	A2	247-253
V-21	Q12	Ph	CN	B7	A2	147.5-148.5*
V-22	Q12	Ph	CN	SO ₂ (4- ^t Bu-Ph)	A2	174-176.5
V-23	2-naphthyl	—	CN	B1	A1	viscous oil
V-24	2-naphthyl	—	CN	H	A1	140.1-141.1
V-25	2-naphthyl	—	CN	B7	A1	viscous oil
V-26	Q13	—	CN	H	A2	121-122
V-27	Q1	5-Cl	CN	H	A2	160 (decompo- sition)
V-28	Q1	5-Cl	CN	B7	A2	79.5-81
V-29	Q2	4-Ph	CN	H	A1	231-232
V-30	Q2	4-t-Bu	CN	H	A1	218-219
V-31	Q3	3-Ph	CN	H	A1	243-245
V-32	Q4	Ph	CN	H	A1	255.8-256.8
V-33	Q4	Ph	CN	B1	A1	187-190
V-34	Q5	t-Bu	CN	H	A2	158-160
V-35	Q6	t-Bu	CN	H	A2	215-216
V-36	Q7	5-CF ₃	CN	H	A1	184-185
V-37	Q7	5-CF ₃	CN	H	A2	211-212
V-38	Q7	5-PhCH ₂ O	CN	H	A1	220-221
V-39	Q8	4,6-(MeO) ₂	CN	H	A1	149-155
V-40	Q14	t-Bu	CN	H	A1	137.9-143.7
V-41	Q14	t-Bu	CN	B7	A1	vitreous state
V-42	Q14	t-Bu	CN	H	A2	127.5-128.9
V-43	Q14	t-Bu	CN	B7	A2	vitreous state
V-44	Q14	t-Bu	CN	B33	A2	vitreous state
V-45	Q14	t-Bu	CN	H	2,6-F ₂ -Ph	105.6-108.1
V-46	Q14	t-Bu	CN	B7	2,6-F ₂ -Ph	viscous oil

TABLE 19-continued

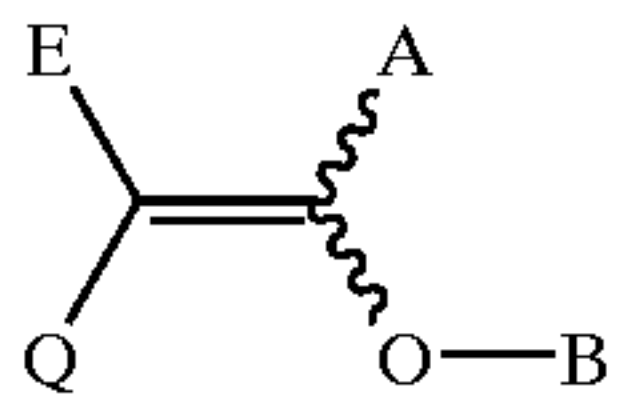

No.	Q	R	E	B	A	m.p. (° C.)
V-47	Q14	Ph	CN	H	A2	113.0-114.9
V-48	Q14	Ph	CN	B7	A2	viscous state
V-49	Q14	Ph	CN	B15	A2	viscous state
V-50	Q14	2-Cl—Ph	CN	H	A1	125.5-127.5
V-51	Q14	2-Cl—Ph	CN	B7	A1	104.0-107.5
V-52	Q14	2-Cl—Ph	CN	H	A2	142.4-143.6
V-53	Q14	2-Cl—Ph	CN	B15	A2	viscous state
V-54	Q14	2-Cl—Ph	CN	B7	A2	viscous state
V-55	Q14	2,6-F ₂ —Ph	CN	H	A2	136.3-164.7
V-56	Q14	2,6-F ₂ —Ph	CN	B15	A2	viscous state
V-57	Q14	2,6-F ₂ —Ph	CN	B7	A2	viscous state
V-58	Q14	PhCH ₂	CN	H	A2	113.2-114.3
V-59	Q14	PhCH ₂	CN	B15	A2	viscous state
V-60	Q14	PhCH ₂	CN	B7	A2	viscous state
V-61	Q14	2-Cl—Ph	CN	H	2-MeO—Ph	131.4-132.8
V-62	Q14	2-Cl—Ph	CN	CO ₂ -2-Oct	2-MeO—Ph	viscous oil
V-63	Q14	2-Cl—Ph	CN	B44	2-MeO—Ph	viscous state
V-64	Q14	2-Cl—Ph	CN	H	2,6-F ₂ —Ph	155.1-157.9
V-65	Q14	2-Cl—Ph	CN	B45	2,6-F ₂ —Ph	159.3-160.3
V-66	Q14	2-Cl—Ph	CN	H	A7	150-152
V-67	Q14	2-Cl—Ph	CN	SO ₂ (3-Cl—Ph)	A7	132-133
V-68	Q14	PhMe ₂ C	CN	H	A2	viscous state
V-69	Q14	PhMe ₂ C	CN	B7	A2	viscous state
V-70	Q14	PhMe ₂ C	CN	COCH ₂ OMe	A2	viscous state
V-71	Q15	Ph	CN	H	A1	151-153
V-72	Q16	3-CN—Ph	CN	H	A1	174-175
V-73	Q17	5-CO ₂ Et	CN	B7	A2	viscous oil
V-74	Q18	3-pyridin-2-yl	CN	H	A2	219 (decomposition)
V-75	Q19	5-Me-2-Ph	CN	H	A2	181-182
V-76	Q19	5-Me-2-Ph	CN	B7	A2	viscous oil
V-77	Q18	3-pyridin-2-yl	CN	B7	A2	viscous state
V-78	Q18	3-pyridin-2-yl	CN	B46	A2	viscous state
V-79	Q18	t-Bu	CN	H	A2	110.4-110.8
V-80	Q20	6-I	CN	H	A2	205-208
V-81	Q20	6-I	CN	B7	A2	137-142
V-82	4-Ph-oxazol-2-yl	—	CN	H	A2	165.9-166.7
V-83	4-Ph-oxazol-2-yl	—	CN	B15	A2	viscous state
V-84	4-Ph-oxazol-2-yl	—	CN	B7	A2	viscous state
V-85	Q19	5-Me-2-Ph	CN	H	A7	117-118
V-86	3-(2-Cl—Ph)imidazolin-2-on-1-yl	—	CN	H	A2	155-156

*E-form or Z-form

50

TABLE 20

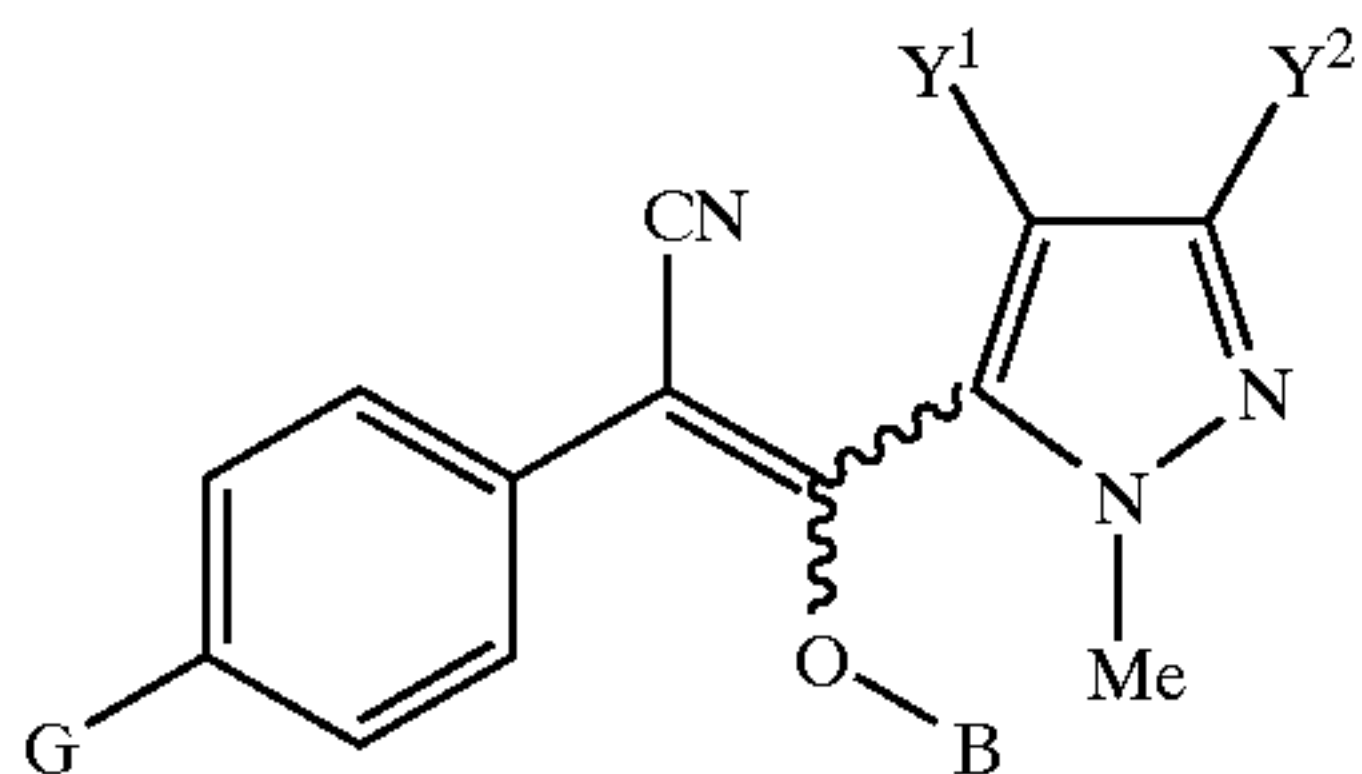

No.	G	B	Y ¹	Y ²	melting point (° C.)
VI-4	tBu	B33	H	Me	93.7-96.6
VI-5	tBu	Et	Me	H	resinous
VI-6	tBu	B33	Me	H	resinous
VI-7	tBu	Me	Me	Me	resinous

TABLE 20-continued

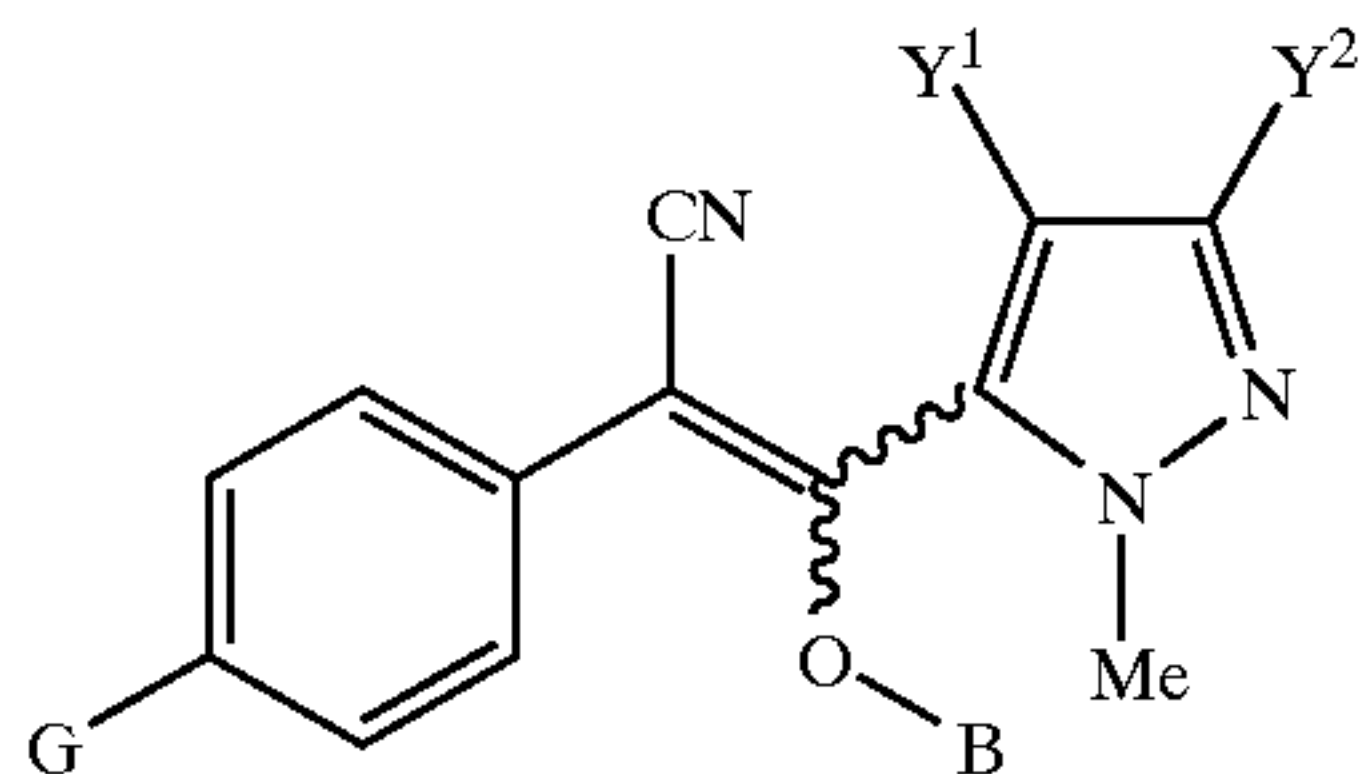

No.	G	B	Y ¹	Y ²	melting point (° C.)
VI-8	tBu	Et	Me	Me	resinous
VI-9	tBu	B3	Me	Me	resinous
65 VI-10	tBu	B3	Me	Me	resinous (isomer of VI-9)

TABLE 20-continued

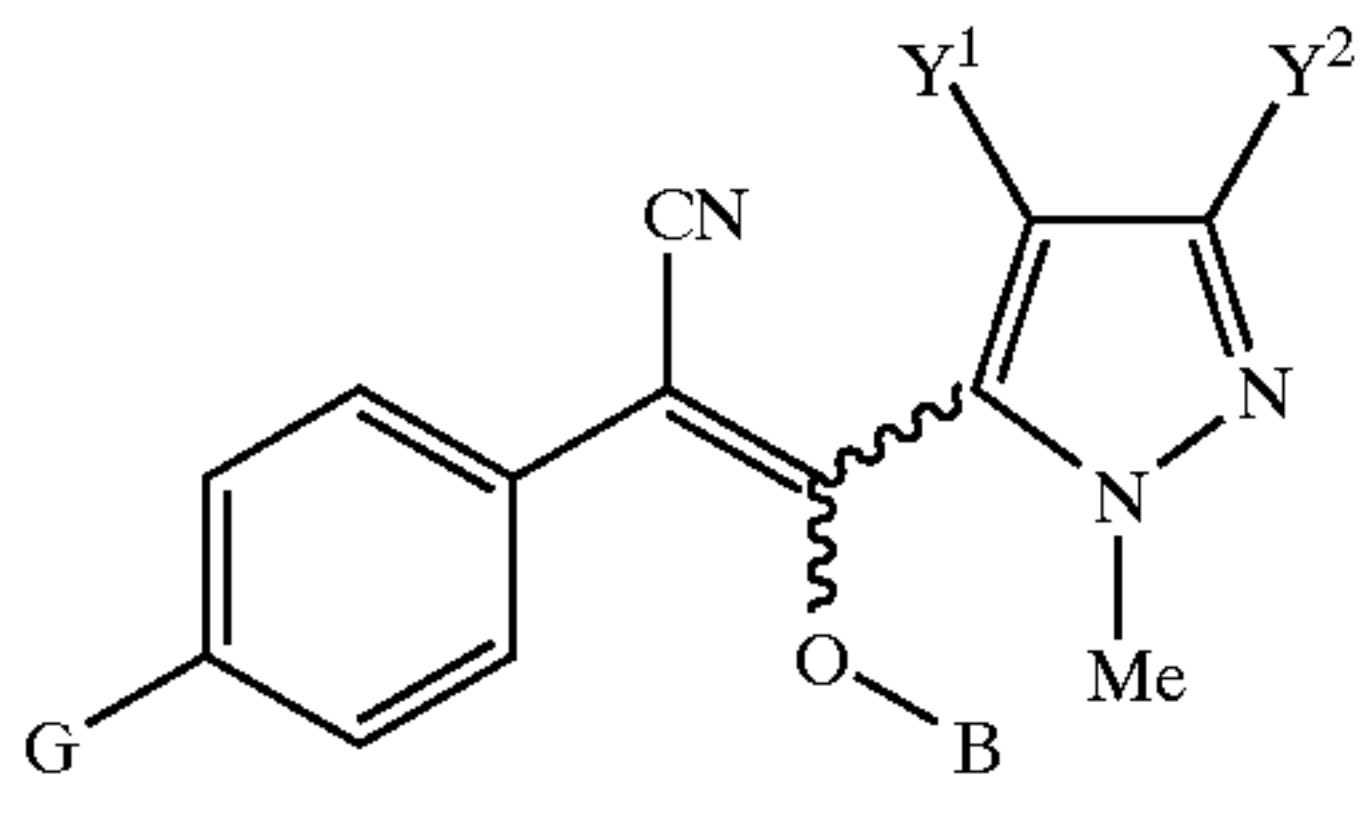

No.	G	B	Y ¹	Y ²	melting point (° C.)
VI-11	tBu	CH ₂ OCH ₂ Ph	Me	Me	resinous
VI-12	tBu	CH ₂ OCH ₂ Ph	Me	Me	resinous (isomer of VI-11)
VI-13	tBu	B24	Me	Me	resinous
VI-14	tBu	B32	Me	Me	resinous
VI-15	tBu	B32	Me	Me	resinous (isomer of VI-14)
VI-16	tBu	B33	Cl	Me	66.5–67.45
VI-17	tBu	B33	Me	Br	94.0–95.0
VI-18	tBu	Et	H	Me	133.0–135.5
VI-19	tBu	B33	Me	Me	resinous (Z-form)
VI-20	tBu	B33	Me	Me	resinous
VI-21	tBu	H	Me	H	resinous
VI-22	tBu	H	H	Me	resinous
VI-23	tBu	H	Me	Me	resinous
VI-24	tBu	H	Cl	Me	68.0–69.0
VI-25	tBu	H	Me	Br	resinous
VI-26	sBu	H	Me	Me	resinous
VI-27	EtMe ₂ C	H	Me	Me	resinous
VI-28	EtMe ₂ C	H	Cl	Me	resinous
VI-29	tBu	B7	Me	Me	102.2–103.8
VI-30	tBu	B6	Me	Me	resinous
VI-31	tBu	CO(2-MeO—Ph)	Me	Me	resinous
VI-32	tBu	B26	Me	Me	resinous
VI-33	tBu	B7	Cl	Me	resinous
VI-34	tBu	COOiBu	Me	Me	resinous
VI-35	EtMe ₂ C	B7	Me	Me	resinous
VI-36	sBu	B7	Me	Me	resinous
VI-37	tBu	CO(2-MeO—Ph)	Cl	Me	181.5–182.5
VI-38	tBu	B7	—(CH ₂) ₃ —	Me	105.3–106.8
VI-39	tBu	B7	MeO	Me	68.1–70.6
VI-40	tBu	B7	Me	H	resinous
VI-41	tBu	CO(2-Me—Ph)	Cl	Me	128.0–130.0
VI-42	tBu	CO(3-pyridyl)	Me	Me	resinous
VI-43	tBu	CO(2-Cl—Ph)	Me	Me	133.0–134.0
VI-44	tBu	CO(2-Cl—Ph)	Me	Me	150.0–151.0 (Isomer of I-43)
VI-45	tBu	B7	Me	Br	118.0–119.0
VI-46	tBu	CO(3-Cl—Ph)	Me	Me	143.0–145.0
VI-47	tBu	CO(4-Cl—Ph)	Me	Me	169.0–170.0
VI-48	tBu	B5	Me	Me	resinous
VI-49	tBu	B2	Me	Me	110.6–111.8
VI-50	tBu	CO(2-Me—Ph)	Me	Me	127.0–128.0
VI-51	tBu	CO(3-Me—Ph)	Me	Me	111.0–112.0
VI-52	tBu	CO(4-Me—Ph)	Me	Me	134.5–136.0

TABLE 21

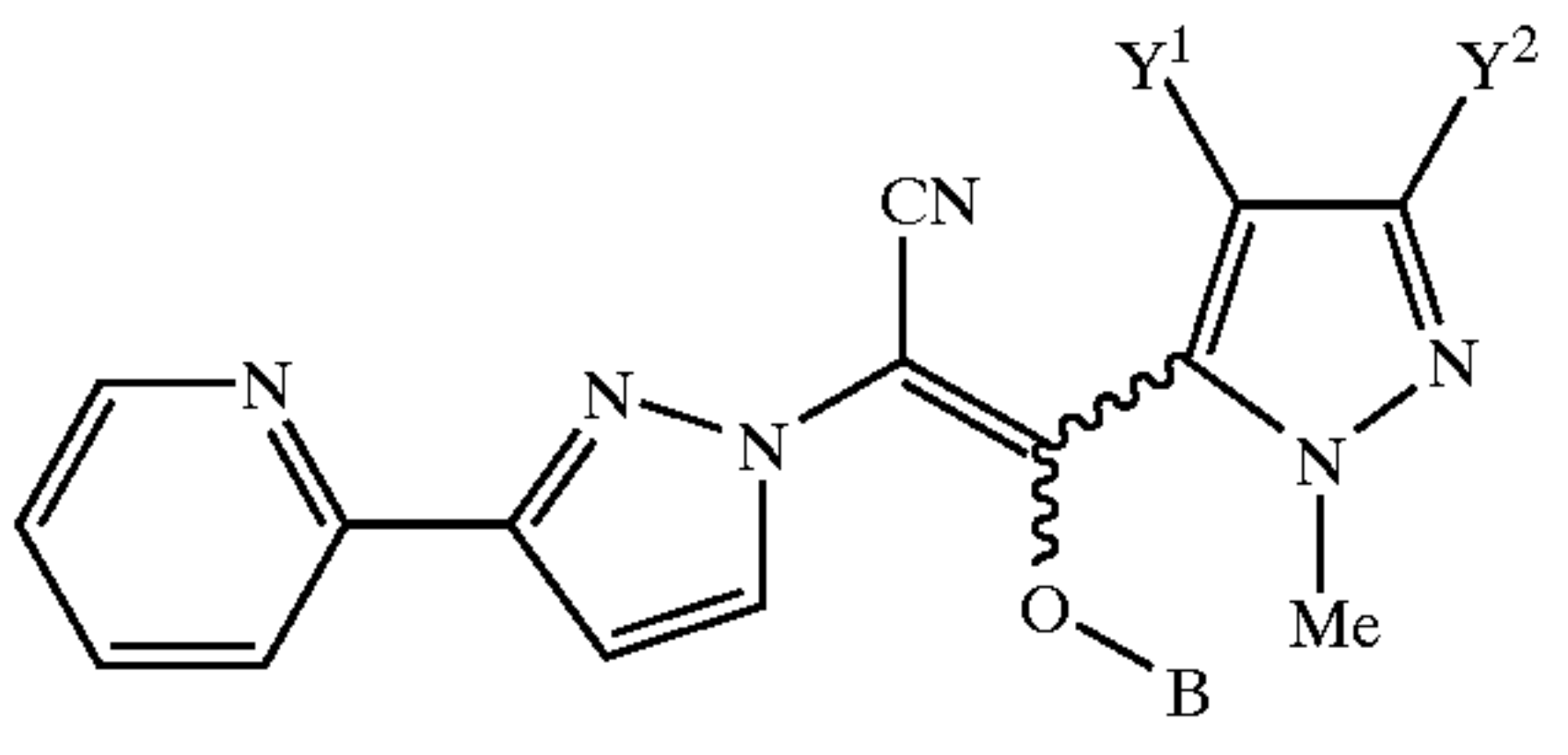

No.	B	Y ¹	Y ²	melting point ° C. (ratio of isomer)
VII-1	H	H	H	pale brown solid

TABLE 21-continued

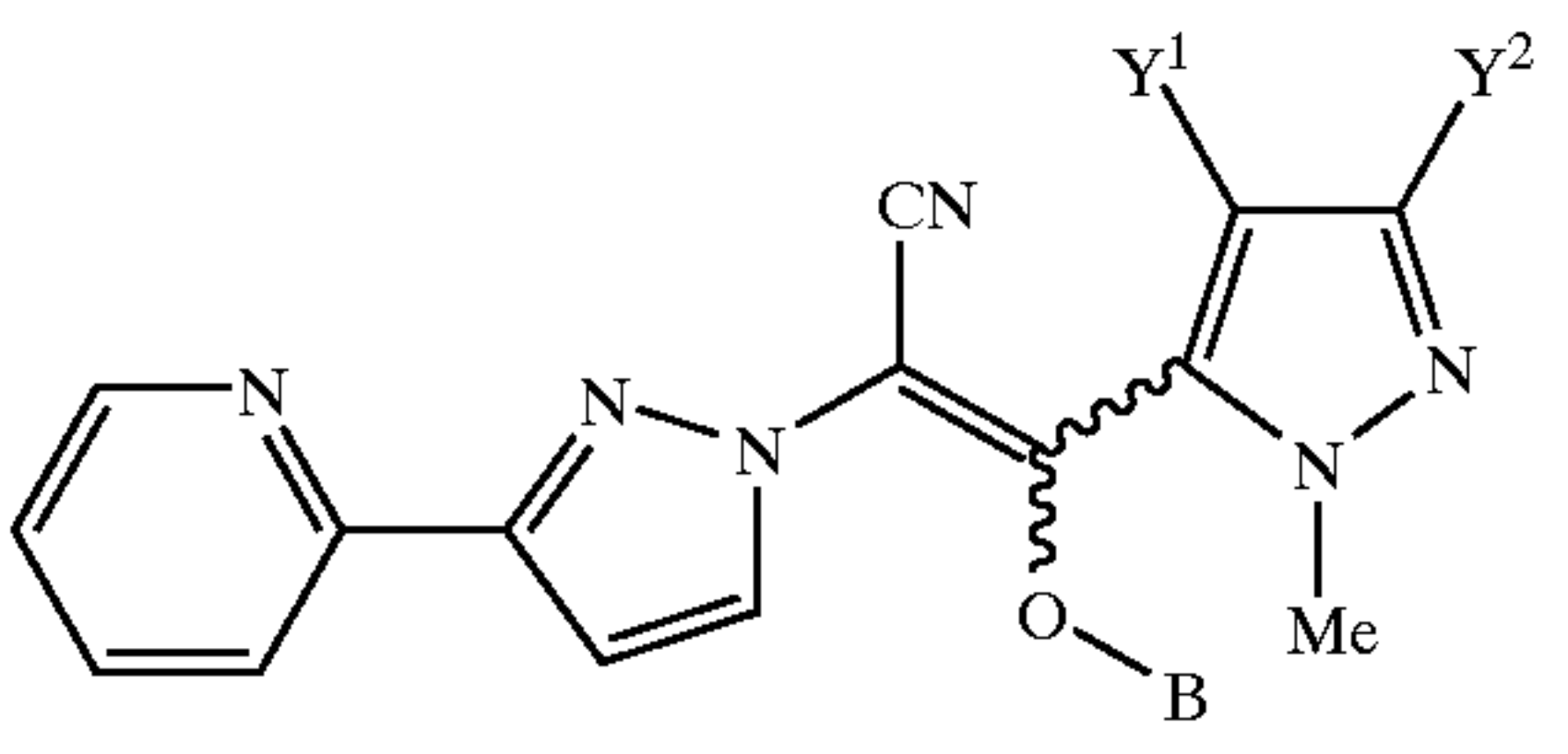

No.	B	Y ¹	Y ²	melting point ° C. (ratio of isomer)
VII-2	H	H	Me	>200 (hydrochloride)
VII-3	H	Me	H	86.2–88.1
VII-4	H	Cl	Me	resinous
VII-5	H	H	Cl	resinous
VII-6	H	Cl	Et	resinous
VII-7	H	Me	Me	207–210
VII-8	H	—(CH ₂) ₃ —		resinous
VII-9	Me	Me	Me	resinous
VII-10	CH ₂ Ph	Me	Me	resinous
VII-11	B7	Me	Me	133.7–134.5 (Z-form)
VII-12	B7	Me	Me	resinous (E-form)
VII-13	B7	H	Me	resinous (3/2)
VII-14	B7	H	Cl	resinous (20/1)
VII-15	B7	Me	H	resinous
VII-16	B7	Cl	Me	resinous (20/1)
VII-17	B7	Cl	Et	resinous (10/1)
VII-18	B6	Cl	Me	resinous (=3/1)
VII-19	B36	Cl	Me	resinous (5/1)
VII-20	B7	—(CH ₂) ₃ —		resinous (5/1)
VII-21	B15	Me	Me	resinous (10/1)
VII-22	CO-cPen	Me	Me	resinous (10/1)
VII-23	B8	Me	Me	resinous (10/1)
VII-24	B6	Me	Me	resinous (10/1)
VII-25	CO(4-Me—Ph)	Me	Me	resinous (10/1)
VII-26	B40	Me	Me	resinous (10/1)
VII-27	CO(2-MeO—Ph)	Me	Me	resinous (10/1)
VII-29	B38	Me	Me	resinous (10/1)
VII-30	B36	Me	Me	resinous (10/1)
VII-31	B35	Me	Me	resinous (10/1)
VII-32	B37	Me	Me	resinous (10/1)
VII-33	B5	Me	Me	resinous (10/1)
VII-34	SO ₂ Ph	Me	Me	resinous (10/1)
VII-35	SO ₂ (4-Me—Ph)	Me	Me	resinous (10/1)
VII-36	SO ₂ (4-CF ₃ —Ph)	Me	Me	resinous (10/1)
VII-37	SO ₂ (2,4,6-Me ₃ —Ph)	Me	Me	resinous (10/1)
VII-38	B23	Me	Me	resinous (10/1)
VII-39	Et	Me	Me	resinous (7/1)
VII-40	B7	H	CF ₃	resinous
VII-41	B7	H	H	resinous (2/1)
VII-42	H	Cl	MeO	149.6–151.2
VII-43	B7	Cl	MeO	resinous
VII-44	H	MeO	Me	resinous
VII-45	H	MeO	Me	resinous

TABLE 22

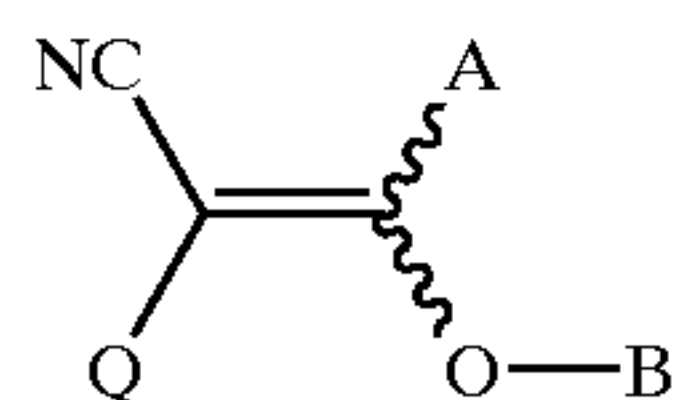

No.	Q	R	B	A	melting point ° C.
VIII-1	Q21	Ph	H	A2	165.9-166.7
VIII-2	Q21	Ph	B15	A2	resinous
VIII-3	4-tBu-Ph	—	CH ₂ O(4-Cl-Ph)	A1	resinous
VIII-4	Q19	5-Me-2-Ph	H	A7	117.0-118.0
VIII-5	Q7	5-CF ₃	H	A38	74.0-77.0
VIII-6	4-tBu-Ph	—	B7	A48	145.0-146.0
VIII-7	Q19	5-Me-2-Ph	B3	A7	117.0-122.0
VIII-8	Q23	cHex	H	A13	resinous
VIII-9	Q23	tBu	SO ₂ (3-Cl-Ph)	A13	resinous
VIII-10	Q23	1-naphthyl	H	A13	145.0-146.0
VIII-11	Q8	4-Cl-Ph	H	A2	212.0-214.0
VIII-12	Q24	2-pyridyl	B7	A2	182.0-183.0
VIII-13	3-Cl-4-CHF ₂ O-Ph	—	B7	A2	resinous
VIII-14	Q22	tBu	CONMe ₂	A13	98.0-100.0
VIII-15	Q24	tBu	B7	A2	80.0-92.0
VIII-16	Q22	2-pyridyl	B7	A2	133.0-134.0
VIII-17	Q19	5-Me-2-Ph	B7	A7	85.0-102.0
VIII-18	Q10	5-Me-1-(2-pyridyl)	H	A2	139.0-142.0
VIII-19	Q22	1-Me-cHex	H	A13	98.0-99.0
VIII-20	Q14	PhMe ₂ C	B6	A13	resinous
VIII-21	Q22	tBu	B2	A13	resinous
VIII-22	Q22	nPen	H	A13	resinous
VIII-23	Q25	4-I	H	A13	177.5-178.2
VIII-24	Q25	4-I	B7	A2	resinous
VIII-25	Q22	tBu	B7	A39	resinous
VIII-26	Q22	nNon	H	A13	resinous
VIII-27	Q22	C ₁₇ H ₃₅	H	A13	resinous
VIII-28	Q22	cPr	H	A13	88.8-89.7
VIII-29	Q22	cPen	B6	A13	resinous
VIII-30	Q22	PhMeCH	H	A13	resinous
VIII-31	Q22	nPrMe ₂ C	H	A13	resinous
VIII-32	Q25	2-pyridyl	H	A41	261.0-262.0
VIII-33	Q25	4-COOMe	B7	A2	97.0-98.0
VIII-34	Q22	CH ₂ =CHCH ₂ CHMe	H	A13	resinous
VIII-35	Q22	3-Me-cHex	H	A13	resinous
VIII-36	Q22	4-Me-cHex	H	A13	resinous
VIII-37	Q22	2-Me-cPr	H	A13	resinous
VIII-38	Q22	sBu	H	A13	resinous
VIII-39	Q26	tBu	H	A13	134.3-135.7
VIII-40	Q22	Et ₂ CH	H	A13	74.0-75.0
VIII-41	Q22	nPr ₂ CH	H	A13	resinous
VIII-42	Q22	2-Me-cHex	B6	A13	resinous
VIII-43	Q22	cHep	H	A13	resinous
VIII-44	Q25	2-pyridyl	H	A42	270.0-272.0
VIII-45	Q22	2,3-(MeO) ₂ -Ph	B7	A13	resinous
VIII-46	Q22	2-EtO-Ph	B7	A13	131.3-132.6
VIII-47	Q25	3-(2-pyridyl)	H	A21	resinous
VIII-48	Q25	3-(2-pyridyl)	B7	A14	84.0-85.0
VIII-49	Q25	3-(2-pyridyl)	H	A43	186.9-188.3
VIII-50	Q25	3-COOEt	B7	A2	resinous
VIII-51	Q22	2,4-Cl ₂ -Ph	H	A13	137.5-138.5
VIII-52	Q22	2-Ph-Ph	H	A13	112.0-113.0
VIII-53	Q19	2-Ph	H	A10	232.5-235.6
VIII-54	Q19	2-Ph	B7	A10	resinous
VIII-55	Q25	5-(2-pyridyl)	B7	A10	resinous
VIII-56	Q25	3-COOiPr	H	A2	130.0-131.0
VIII-57	Q25	3-(2-pyridyl)	H	4-NH ₂ - 2-F-Ph HCl	114.3-117.5
VIII-58	Q25	3-(2-pyridyl)	B7	A22	resinous
VIII-59	Q25	3-(2-pyridyl)	B7	A44	resinous
VIII-60	Q25	3-(2-pyridyl)	H	A18	resinous
VIII-61	Q25	3-(2-pyridyl)	B7	A7	resinous
VIII-62	Q25	3-CN	B7	A45	resinous
VIII-63	Q25	3-(2-pyridyl)	B7	A49	resinous
VIII-64	Q25	3-(2-pyridyl)	H	A50	143.2-147.6
VIII-65	Q25	3-(2-pyridyl)	B7	A30	116.0-117.0
VIII-66	Q25	3-COOiPr	B7	A45	resinous
VIII-67	Q25	3-(4-pyridyl)	H	A45	resinous
VIII-68	Q25	3-(2-pyridyl)	B7	A46	140.7-144.5
VIII-69	4-tBu-Ph	—	B7	A42	resinous

TABLE 22-continued

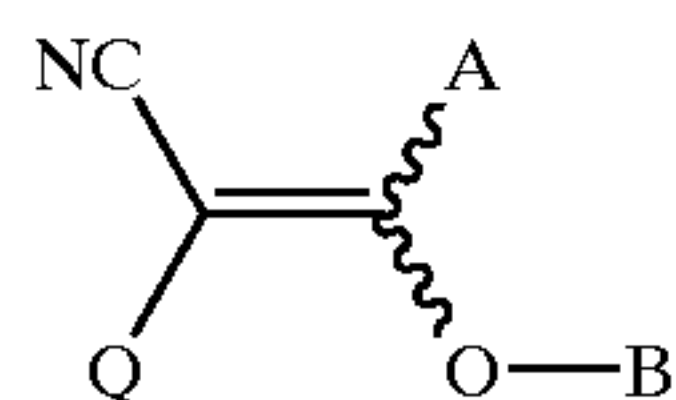

No.	Q	R	B	A	melting point ° C.
VIII-70	Q25	3-(2-thienyl)	H	A47	resinous
VIII-71	Q22	cHep	H	A47	resinous
VIII-72	Q22	cHep	B7	A47	resinous
VIII-73	4-tBu—Ph	—	B6	A42	resinous
VIII-74	4-tBu—Ph	—	B33	A42	62.0–63.0
VIII-75	Q22	tBu	B33	A47	resinous
VIII-76	Q27	2-pyridyl	B7	A45	144.0–145.0
VIII-77	Q27	2-pyridyl	H	A45	170.0–171.0
VIII-78	Q27	2-pyridyl	B7	A42	180.0–181.0
VIII-79	Q28	2-pyridyl	H	A45	resinous
VIII-80	Q28	2-pyridyl	B7	A45	resinous
VIII-81	Q19	5-Me-2-Ph	H	A47	resinous
VIII-82	Q19	5-Me-2-Ph	B7	A47	139.2–141.6
VIII-83	Q25	3-tBu-4-COOMe	B7	A47	115.0–116.0
VIII-84	Q22	EtMe ₂ C	B7	A47	resinous
VIII-85	Q27	2-pyridyl	H	A3	139.0–140.0
VIII-86	4-tBu—Ph	—	B7	A49	93.6–95.2
VIII-87	Q9	1-(2-pyridyl)	H	A47	resinous
VIII-88	Q9	5-MeO-1-(2-pyridyl)	H	A47	resinous
VIII-89	4-tBu—Ph	—	H	A21	123.0–124.0
VIII-90	Q29	tBu	B7	A47	resinous
VIII-91	Q22	iBu	B7	A2	73.0–74.0
VIII-92	Q22	iBu	H	A2	62.0–63.0
VIII-93	4-tBu—Ph	—	B7	A14	98.0–99.0
VIII-94	Q22	tBu	B33	A52	92.0–93.0

Formulation Examples

Now, Formulation Examples of pesticides comprising the compounds of the present invention as the active ingredient are shown below, which, however, are not intended to restrict the scope of the invention. In the following Formulation Examples, "part" or "parts" are by weight.

[Formulation Example 1] Wettable Powder:

Compound No. I-1 of the invention	50 parts
Zeeklite PFP (trade name, kaolin-type clay manufactured by Zeeklite Mining Industries, Co., Ltd.)	43 parts
Solpol 5050 (trade name, anionic surfactant manufactured by Toho Chemical Co., Ltd.)	2 parts
Runox 1000C (trade name, anionic surfactant manufactured by Toho Chemical Co., Ltd.)	3 parts
Carpalex #80 (anti-caking agent, trade name, white carbon manufactured by Shionogi Pharmaceutical Co., Ltd.)	2 parts

The above-mentioned components were homogeneously mixed and ground to form a wettable powder.

[Formulation Example 2] Emulsion:

Compound No. I-1 of the Invention	3 parts
Methylnaphthalene	76 parts
Isophorone	15 parts
Solpol 3005X (trade name, mixture of nonionic surfactant and anionic surfactant manufactured by Toho Chemical Co., Ltd.)	6 parts

The above-mentioned components were homogeneously mixed to form an emulsion.

[Formulation Example 3] Flowable:

Compound No. I-1 of the invention	35 parts
Agrisol S-711 (trade name, nonionic surfactant manufactured by Kao Corp.)	8 parts
Runox 1000C (trade name, anionic surfactant manufactured by Toho Chemical Co., Ltd.)	0.5 part
Aqueous solution of 1% Rhodopol (trade name, thickener manufactured by Rhone-Poulenc)	20 parts
Ethylene glycol (freezing inhibitor)	8 parts
Water	28.5 parts

The above-mentioned components were homogeneously mixed to prepare a flowable.

[Formulation Example 4] Granular wettable powder (Dry flowable):

Compound No. I-1 of the invention	75 parts
Isoban No. 1 (trade name, anionic surfactant manufactured by Kuraray Isoprene Chemical Co., Ltd.)	10 parts
Vanilez N (trade name, anionic surfactant manufactured by Sanyo Kokusaku Pulp Co., Ltd.)	5 parts
Carpalex #80 (trade name, white carbon manufactured by Shionogi Pharmaceutical Co., Ltd.)	10 parts

The above-mentioned components were homogeneously mixed and finely ground to form a dry flowable.

[Formulation Example 5] Granules:

Compound No. I-1 of the invention	0.1 part
Bentonite	55.0 parts
Talc	44.9 parts

The above-mentioned components were homogeneously mixed and ground, to which was added a small amount of water, stirred, mixed and kneaded. The resulting mixture was granulated and dried into granules, using an extrusion granulator.

[Formulation Example 6] Dust:

Compound No. I-1 of the invention	3.0 parts
Carplex #80 (trade name, white carbon manufactured by Shionogi Pharmaceutical Co., Ltd.)	0.5 part
Clay	95 parts
Diisopropyl phosphate	1.5 parts

The above-mentioned components were homogeneously mixed and ground to form a dust.

Upon use, the wettable powder, emulsion, flowable and dry flowable are diluted from 50 to 20000 times with water, and applied in an amount of from 0.005 to 50 kg/ha in terms of the active ingredient.

Now, Formulation Examples of agents for preventing the attachment of aquatic organisms of the present invention are shown below, which, however, are not intended to restrict the scope of the invention.

[Formulation Example 7]

Compound No. II-2 of the invention	8 parts
VYHH (vinyl-type synthetic resin manufactured by UCC Co., Ltd.)	7 parts
Rosin	7 parts
Tricresyl phosphate	3 parts
Talc	20 parts
Barium sulfate	15 parts
Red iron oxide	10 parts
Xylene	20 parts
Methyl isobutyl ketone	10 parts

The above-mentioned components were homogeneously mixed to form an agent for preventing the attachment of aquatic organisms of the invention. This agent can be used as a coating paint.

[Formulation Example 8]

Compound No. II-2 of the invention	5 parts
CR-10 (chlorine rubber resin manufactured by Asahi Denka KK)	13 parts
Zinc flower	20 parts
Talc	20 parts
Plasticizer	2 parts
Red iron oxide	10 parts
Xylene	30 parts

The above-mentioned components were homogeneously mixed to form an agent for preventing the attachment of

aquatic organisms of the invention. This agent can be used as a coating paint.

[Formulation Example 9]

Compound No. II-2 of the invention	8 parts
VYHH (vinyl-type synthetic resin manufactured by UCC Co., Ltd.)	7 parts
Rosin	7 parts
Tricresyl phosphate	3 parts
Talc	20 parts
Barium sulfate	15 parts
Red iron oxide	10 parts
Xylene	20 parts
Methyl isobutyl ketone	10 parts

The above-mentioned components were homogeneously mixed to form an agent for preventing the attachment of aquatic organisms the invention. This agent can be used as a coating paint.

[Formulation Example 10]

Compound No. II-2 of the invention	5 parts
CR-10 (chlorine rubber resin manufactured by Asahi Denka KK)	13 parts
Zinc flower	20 parts
Talc	20 parts
Plasticizer	2 parts
Red iron oxide	10 parts
Xylene	30 parts

The above-mentioned components were homogeneously mixed to form an agent for preventing the attachment of aquatic organisms of the invention. This agent can be used as a coating paint.

TEST EXAMPLES

Now, the following Test Examples are to demonstrate the usefulness of the compounds of the present invention as pesticides.

Test Example 1

Insecticidal Test for Brown Rice Planthopper (*Nilaparvata lugens* Stal)

A 5% emulsion (or 25% wettable powder) of a compound of the present invention was diluted with water containing a spreading agent to give a 500 ppm solution of the compound.

The stems and leaves of rice-plants in 1/20,000 are pot were sufficiently applied with the resulting solution. After the thus-applied chemical solution was dried in air, each pot was covered with a cylindrical cover. Ten (10) second instar nymphae of brown rice planthoppers (*Nilaparvata lugens*) were released in each pot. After having been thus covered, the pots were stored in a thermostatic chamber. After 6 days passed, the insects in each pot were observed, and the mortality thereof was determined according to the following equation. Each compound was tested in that manner for two groups of pots.

$$\text{Mortality (\%)} = \frac{\text{number of insect killed}}{\text{number of insect killed} + \text{number of living insect}} \times 100$$

In this test, the following compounds exhibited mortality of 80% or more.

Compounds of the invention: Nos. I-2, I-18, I-19, I-23, I-30, I-31, I-32, I-35, I-39, I-42, I-44, I-58, I-59, I-62, I-63, I-70, I-72, I-80, I-106, I-114, I-123, I-137, II-1, II-2, II-3, II-5, II-6, II-12, II-15, II-23, II-25, II-26, II-28, II-33, II-34, II-36, II-37, II-38, II-39, II-43, II-44, II-46, II-53, II-54, II-55, II-61, II-66, II-73, II-74, II-75, II-76, II-80, II-83, II-84, II-85, II-86, II-87, II-88, II-89, II-91, II-92, II-93, II-97, II-98, II-111, II-114, II-116, II-134, II-136, II-137, II-154, II-155, II-159, III-1, III-2, III-4, III-6, III-15, III-16, III-17, III-18, III-19, III-21, IV-48, IV-58, V-2, V-12, V-13, V-28, V-48, V-49, V-51, V-53, V-54, V-55, V-56, V-57, V-59, V-60.

Test Example 2

Insecticidal Test for Green Rice Leafhoppers (*Nephotettix cincticeps* Uhler)

The stems and leaves of plants was dipped in a 500 ppm emulsion of a compound of the invention for about 10 seconds. The thus-treated stems and leaves were put into glass cylinders, into which were released adults of green rice leafhoppers (*Nephotettix cincticeps*) that were resistant to organic phosphorous insecticides. Each glass cylinder was covered with a perforated cover, and stored in a thermostatic chamber at 25° C. After 6 days passed, the insects in each cylinder were observed, and the mortality of the insects was determined according to the same equation as in Test Example 1. Each compound was tested in that manner for two groups of cylinders. In this test, the following compounds exhibited mortality of 80% or more.

Compounds of the invention: Nos. I-1, I-2, I-4, I-5, I-8, I-9, I-10, I-19, I-24, I-29, I-30, I-31, I-32, I-33, I-34, I-35, I-36, I-39, I-40, I-41, I-42, I-43, I-44, I-47, I-53, I-54, I-55, I-56, I-57, I-58, I-59, I-62, I-63, I-69, I-70, I-71, I-72, I-74, I-79, I-80, I-81, I-115, I-121, I-125, I-127, I-137, II-1, II-2, II-3, II-5, II-6, II-7, II-9, II-10, II-11, II-12, II-13, II-15, II-23, II-26, II-28, II-33, II-34, II-36, II-38, II-37, II-43, II-46, II-49, II-52, II-54, II-55, II-63, II-64, II-65, II-66, II-67, II-68, II-69, II-73, II-74, II-75, II-76, II-77, II-78, II-79, II-80, II-81, II-83, II-84, II-85, II-86, II-87, II-88, II-89, II-91, II-92, II-93, II-97, II-98, II-99, II-107, II-111, II-116, II-117, II-130, II-131, II-132, II-134, II-136, II-137, II-142, II-145, II-153, II-154, II-1, III-2, III-3, III-4, III-5, III-6, III-13, III-15, III-16, III-17, III-18, III-19, III-20, III-21, IV-32, IV-58, V-2, V-12, V-13, V-14, V-38, V-41, V-43, V-48, V-49, V-51, V-53, V-54, V-55, V-56, V-57, V-59, V-60, V-75.

Test Example 3

Insecticidal Test for Green Peach Aphids (*Myzus persicae* Sulzer)

Moistured filter paper was placed in each laboratory glass dish having an inner diameter of 3 cm, and a leaf cabbage having the same diameter as that of the dish was put on the filter paper. Four female, apterous adults of green peach aphids (*Myzus persicae*) were put on the cabbage leaf. Following day, a chemical sample (2.5 mg/cm²) was sprayed over the dishes, using a rotary sprinkler. The chemical solution herein was prepared by diluting a 5% emulsion (or 25% wettable powder) of a compound of the invention to 500 ppm with water containing a spreading agent. After 6 days passed, the insects in each cylinder were observed, and mortality of the insects (larvae and adults) was determined according to the following equation. Each compound was tested in that manner for two groups of dishes.

$$\text{Mortality (\%)} = \left[\frac{\text{number of insect killed}}{\text{number of insect killed} + \text{number of living insect}} \right] \times 100$$

In this test, the following compounds exhibited mortality of 80% or more.

Compounds of the invention: Nos. I-1, I-2, I-3, I-4, I-5, I-7, I-8, I-10, I-11, I-12, I-13, I-14, I-16, I-17, I-18, I-19, I-21, I-22, I-23, I-24, I-25, I-26, I-27, I-28, I-29, I-30, I-31, I-32, I-33, I-34, I-35, I-36, I-37, I-38, I-40, I-41, I-42, I-43, I-44, I-45, I-46, I-47, I-48, I-51, I-52, I-53, I-54, I-55, I-56, I-57, I-58, I-59, I-62, I-63, I-69, I-70, I-71, I-72, I-73, I-74, I-76, I-77, I-78, I-79, I-80, I-81, I-84, I-85, I-86, I-89, I-90, I-92, I-96, I-97, I-104, I-108, I-125, I-136, I-137, I-138, II-2, II-3, II-5, II-6, II-7, II-8, II-9, II-10, II-11, II-12, II-15, II-16, II-17, II-23, II-24, II-24, II-25, II-26, II-27, II-28, II-33, II-34, II-35, II-36, II-37, II-38, II-39, II-43, II-44, II-50, II-52, II-53, II-54, II-55, II-58, II-60, II-63, II-64, II-65, II-66, II-68, II-69, II-70, II-71, II-73, II-74, II-75, II-76, II-78, II-79, II-83, II-84, II-85, II-86, II-87, II-88, II-89, II-90, II-91, II-92, II-93, II-97, II-98, II-99, II-101, II-102, II-105, II-107, II-111, II-116, II-117, II-118, II-121, II-130, II-131, II-132, II-133, II-134, II-136, II-137, II-138, II-140, II-141, II-142, II-151, II-153, II-154, II-159, II-160, III-1, III-2, III-3, III-4, III-5, III-6, III-15, III-16, III-17, III-18, III-19, III-20, III-21, IV-10, IV-11, IV-21, IV-23, IV-45, V-1, V-2, V-10, V-11, V-12, V-13, V-14, V-28, V-31, V-32, V-41, V-45, V-48, V-49, V-50, V-51, V-52, V-53, V-54, V-55, V-56, V-57, V-59, V-60, V-73, V-75, VII-1, VII-2, VII-3, VII-4, VII-5, VII-6, VII-7, VII-8, VII-9, VII-10, VII-11, VII-12, VII-13, VII-14, VII-15, VII-16, VII-17, VII-18, VII-19, VII-20, VII-21, VII-22, VII-23, VII-24, VII-25, VII-26, VII-27, VII-28, VII-29, VII-30, VII-31, VII-32, VII-33, VII-34, VII-35, VII-36, VII-37, VII-38, VII-39, VII-40, VII-41, VII-42, VII-43, VII-44, VII-45, VIII-12, VIII-32, VIII-42, VIII-47, VIII-49, VIII-55, VIII-57, VIII-58, VIII-61, VIII-64, VIII-65, VIII-67, VIII-85.

Test Example 4

Insecticidal Test for Diamond Back Moth (*Plutella xylostella* Linne)

The leaves of cabbage were dipped in a 500 ppm aqueous emulsion of a compound of the invention for about 10 seconds. After having been dried in air, the thus-treated leaves were put into laboratory dishes. Ten (10) second larvae of diamond back moth (*Plutella xylostella*) were released in each dish. Each dish was covered with a perforated cover, and stored in a thermostatic chamber at 25° C. After 6 days passed, the insects in each dish were observed, and mortality of the insects was obtained according to the same equation as in Test Example 1. Each compound was tested in that manner for two groups of dishes. In this test, the following compounds exhibited mortality of 80% or more.

Compounds of the invention: Nos. I-1, I-2, I-4, I-5, I-6, I-8, I-9, I-10, I-13, I-18, I-19, I-29, I-30, I-31, I-33, I-34, I-35, I-36, I-38, I-39, I-40, I-41, I-43, I-44, I-45, I-46, I-47, I-51, I-52, I-53, I-56, I-57, I-58, I-59, I-62, I-63, I-70, I-71, I-72, I-73, I-74, I-76, I-77, I-78, I-79, I-80, I-81, I-84, I-86, I-89, I-96, I-97, I-99, I-104, I-106, I-114, I-125, I-137, II-1, II-2, II-5, II-6, II-7, II-8, II-9, II-10, II-11, II-12, II-13, II-15, II-17, II-23, II-24, II-25, II-26, II-27, II-28, II-33, II-34, II-35, II-36, II-37, II-38, II-39, II-40, II-41, II-42, II-43, II-54, II-55, II-58, II-60, II-61, II-62, II-63, II-64, II-65, II-66, II-67, II-68, II-69, II-70, II-71, II-72, II-73, II-74, II-75, II-76, II-77, II-78, II-79, II-80, II-81, II-83, II-84, II-85, II-86, II-87, II-88, II-89, II-90, II-91, II-92, II-93, II-94, II-97, II-98, II-99, II-100, II-101, II-105, II-106, II-107, II-108, II-109, II-110, II-111, II-116, II-117, II-118, II-121, II-122, II-155, II-159, II-161, II-1, III-2, III-3, III-4, III-5, III-6, III-7, III-9, III-10, III-11, III-13, III-14, III-15, III-16, III-17, III-18, III-19, III-20, III-21, IV-7, IV-8, IV-29, IV-47, IV-53, IV-58, V-1, V-2, V-11, V-12, V-13, V-29, V-37, V-41, V-43, V-46, V-48, V-50, V-51, V-52, V-53, V-54, V-55, V-56, V-57, V-58, V-59, V-60, V-64, V-75.

Test Example 5

Insecticidal Test for Cucurbit Leaf Beetles (*Aulacophora femoralis* Motschulsky)

A 5% emulsion (or 25% wettable powder) of a compound of the present invention was diluted with water containing a spreading agent to give a 500 ppm solution of the compound. The leaves of cucumbers were dipped in this chemical solution for about 10 seconds, dried in air, and put into a laboratory dish. Ten (10) second instar nymphae of cucurbit leaf beetles (*Aulacophora femoralis*) were released in each dish. Each dish was covered with a cover, and stored in a thermostatic chamber at 25° C. After 6 days passed, the insects in each dish were observed, and mortality of the insects was determined according to the same equation as in Test Example 1. Each compound was tested in that manner for two groups of dishes.

In this test, the following compounds exhibited mortality of 100%.

Compounds of the invention: Nos. I-1, I-2, I-4, I-6, I-8, I-9, I-10, I-11, I-12, I-13, I-29, I-30, I-31, I-32, I-33, I-34, I-35, I-39, I-40, I-41, I-43, I-44, I-46, I-53, I-54, I-55, I-56, I-57, I-58, I-59, I-61, I-62, I-63, I-69, I-70, I-71, I-72, I-74, I-76, IU-77, I-78, I-79, I-80, I-81, I-82, I-83, I-92, I-101, I-103, I-104, I-108, I-109, I-124, I-127, I-128, II-1, II-6, II-7, II-8, II-9, II-10, II-11, II-12, II-13, II-14, II-15, II-16, II-17, II-23, II-24, II-25, II-26, II-27, II-28, II-33, II-34, II-35, II-36, II-37, II-38, II-39, II-41, II-42, II-43, II-47, II-50, II-53, II-54, II-55, II-57, II-58, II-61, II-62, II-63, II-65, II-66, II-99, II-101, II-102, II-104, II-105, II-106, II-107, II-108, II-109, II-110, II-114, II-122, II-124, II-125, II-131, II-132, II-133, II-134, II-136, II-137, II-139, II-140, II-141, II-142, II-153, II-154, III-1, III-2, III-3, II-4, III-5, III-6, III-9, III-10, III-11, III-12, III-14, III-15, III-16, III-17, III-20, IV-6, IV-13, IV-33, IV-39, IV-56, IV-60, IV-61, IV-72, IV-82, V-1, V-2, V-11, V-12, V-13, V-17, V-22, V-26, V-27, V-29, V-37, V-40, V-42, V-48, V-49, V-50, V-51, V-52, V-54, V-55, V-57, V-59, V-60, V-61, V-64, V-75.

Test Example 6

Acaricidal Test for Two-spotted Spider Mites (*Tetranychus urticae* Koch)

The leaves of kidney bean plants were punched into 3 cm-diameter discs, using a leaf punch, and put onto moistured filter paper in a 7 cm-diameter styrol cup. Ten (10) larvae of two-spotted spider mites (*Tetranychus urticae*) were put to each leaf. A 5% emulsion (or 25% wettable powder) of a compound of the invention was diluted with water containing a spreading agent to give a 500 ppm solution of the compound. The solution was sprayed over each cup in an amount of 2 ml/cup, using a rotary sprinkler, and the cups were stored in a thermostatic chamber at 25° C. After 96 hours passed, the mites in each cup were observed, and mortality of the mites was determined according to the same equation as in Test Example 1. Each compound was tested in that manner for two groups of cups.

In this test, the following compounds exhibited the mites at a percentage of 80% or more.

Compounds of the invention: Nos. I-1, I-2, I-3, I-4, I-5, I-7, I-8, I-9, I-10, I-12, I-13, I-19, I-24, I-25, I-26, I-27, I-28, I-29, I-30, I-31, I-32, I-33, I-34, I-35, I-36, I-38, I-40, I-41, I-42, I-43, I-44, I-45, I-46, I-47, I-48, I-50, I-51, I-52, I-55, I-56, I-57, I-58, I-59, I-60, I-61, I-62, I-63, I-70, I-71, I-72, I-74, I-76, I-80, I-94, I-95, I-96, I-97, I-99, I-101, I-102, I-103, I-104, I-105, I-106, I-108, I-109, I-110, I-111, I-112, I-113, I-114, I-115, I-117, I-118, I-119, I-122, I-123, I-124, I-125, I-126, I-127, I-128, I-137, II-2, II-3, II-5, II-6, II-7, II-8, II-9, II-10, II-11, II-12, II-13, II-15, II-16, II-17, II-23, II-25, II-26, II-27, II-28, II-33, II-34, II-35, II-36, II-37,

II-38, II-39, II-40, II-41, II-42, II-43, II-45, II-46, II-47, II-48, II-50, II-52, II-53, II-54, II-55, II-58, II-59, II-60, II-61, II-63, II-64, II-65, II-66, II-67, II-68, II-69, II-70, II-71, II-72, II-73, II-74, II-75, II-76, II-77, II-78, II-79, II-80, II-81, II-83, II-84, II-85, II-86, II-87, II-88, II-89, II-90, II-91, II-92, II-93, II-95, II-97, II-98, II-99, II-101, II-102, II-103, II-105, II-106, II-107, II-108, II-109, II-110, II-111, II-116, II-117, II-118, II-133, II-134, II-136, II-137, II-151, II-153, II-154, II-155, II-159, II-160, II-161, II-173, III-3, III-4, III-5, III-6, III-7, III-9, III-10, III-11, III-12, III-15, III-17, III-18, III-19, III-21, IV-1, IV-2, IV-3, IV-4, IV-5, IV-7, IV-10, IV-11, IV-12, IV-13, IV-14, IV-16, IV-17, IV-18, IV-19, IV-20, IV-21, IV-22, IV-24, IV-25, IV-26, IV-28, IV-29, IV-33, IV-35, IV-36, IV-39, IV-40, IV-41, IV-42, IV-43, IV-44, IV-45, IV-46, IV-47, IV-48, IV-49, IV-50, IV-51, IV-54, IV-55, IV-56, IV-58, IV-59, IV-60, IV-61, IV-62, IV-63, IV-64, IV-65, IV-66, IV-67, IV-68, IV-69, IV-70, IV-71, IV-72, IV-74, IV-75, IV-76, IV-79, IV-80, IV-82, IV-94, IV-95, IV-96, IV-99, IV-100, IV-101, IV-102, IV-109, IV-110, IV-111, IV-112, V-1, V-2, V-3, V-4, V-5, V-6, V-7, V-8, V-10, V-11, V-12, V-13, V-14, V-15, V-16, V-17, V-19, V-23, V-24, V-25, V-26, V-28, V-31, V-36, V-37, V-38, V-40, V-41, V-42, V-43, V-44, V-46, V-47, V-48, V-59, V-60, V-73, V-75, VI-1, VI-2, VI-3, VI-4, VI-5, VI-6, VI-7, VI-87, VI-9, VI-10, VI-11, VI-12, VI-13, VI-14, VI-15, VI-16, VI-17, VI-18, VI-19, VI-20, VI-21, VI-22, VI-23, VI-24, VI-25, VI-29, VI-30, VI-31, VI-32, VI-33, VI-34, VI-35, VI-36, VI-37, VI-38, VI-39, VI-40, VI-41, VI-42, VI-43, VI-44, VI-45, VI-46, VI-47, VI-48, VI-49, VI-50, VI-51, VI-52, VII-1, VIII-2, VIII-4, VIII-6, VIII-7, VIII-8, VIII-9, VIII-10, VIII-13, VIII-14, VIII-15, VIII-16, VIII-17, VIII-18, VIII-19, VIII-20, VIII-21, VIII-22, VIII-23, VIII-24, VIII-26, VIII-27, VIII-28, VIII-29, VIII-30, VIII-31, VIII-33, VIII-34, VIII-35, VIII-36, VIII-37, VIII-38, VIII-39, VIII-40, VIII-41, VIII-43, VIII-44, VIII-45, VIII-46, VIII-48, VIII-50, VIII-51, VIII-52, VIII-53, VIII-54, VIII-56, VIII-59, VIII-60, VIII-63, VIII-66, VIII-69, VIII-70, VIII-71, VIII-72, VIII-73, VIII-74, VIII-75, VIII-76, VIII-77, VIII-78, VIII-81, VIII-82, VIII-83, VIII-84, VIII-86, VIII-87, VIII-89, VIII-90, VIII-91, VIII-92, VIII-93.

Test Example 7

Test for Preventing Leaf Rust, Brown Rust (*Puccinia recondita* ex Desmazière)

A chemical solution obtained by diluting an emulsion of a compound of the invention to 500 ppm with water was sprayed on wheat plants (Norin No. 61) grown to 1.5- to 2.0-leaf in a pot having a diameter of 5.5 cm-diameter at a dose of 20 ml/pot using a spraygun.

The following day, a spore suspension (2×10^5 spore/ml) of leaf rust (brown rust) (*Puccinia recondite*) was sprayed over the plant-pots were placed overnight in an inoculation box having a temperature of 25° C. and a humidity of 95% or more. Then, the pots were put in a green house. After 7 days of the inoculation, a ratio of an infected and spored area formed to the leaf inoculated was measured, and a preventive value was calculated according to the following equation.

$$\text{Preventive value} = [1 - (\text{infected and spotted area ratio in treated region} / \text{infected and spotted area ratio in untreated region})] \times 100$$

In this test, the following compounds had an protective value of from 70 to 100.

Compounds of the invention: Nos. I-9, I-108, I-127, I-128, II-14, II-15, IV-2, IV-7, V-15, V-10.

With the long-term use of insecticides and microbicides, recently, some pests have become resistant to chemicals and

are often difficult to exterminate with conventional insecticides and microbicides. In addition, some insecticides are highly toxic and are prone to remain long, without being decomposed, to destroy the ecosystem. Accordingly, the present invention provides novel, non-toxic and non-persistent insecticides and fungicides, and provides agents for preventing the attachment of aquatic organisms having few influences on the ecosystem and causing little secondary pollution.

We claim:

1. Ethylene derivatives of a formula:

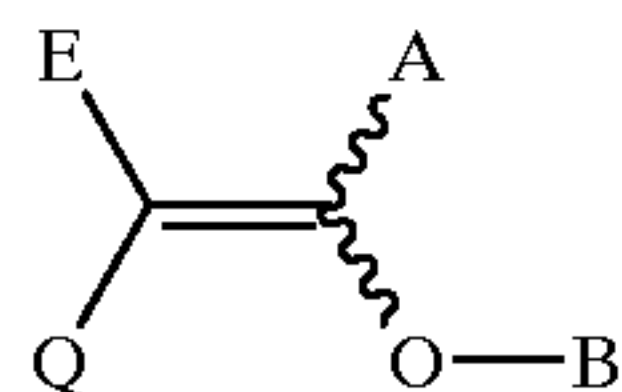

wherein:

Q represents a 1,2,3-triazolyl group optionally substituted by R;

A represents a phenyl group optionally substituted by W, a naphthyl group optionally substituted by W, or a heterocyclic group optionally substituted by Y, wherein said heterocyclic group is selected from the group consisting of a thienyl, furyl, pyrrolyl, oxazolyl, isoxazolyl, thiazolyl, isothiazolyl, pyrazolyl, imidazolyl, 1,3,4-oxadiazolyl, 1,2,4-oxadiazolyl, 1,3,4-thiadiazolyl, 1,2,4-thiadiazolyl, 1,2,3-thiadiazolyl, 1,2,4-triazolyl, 1,2,3-triazolyl, 1,2,3,4-tetrazolyl, pyridinyl, pyrimidinyl, pyrazinyl, pyridazinyl, 1,3,5-triazinyl, 1,2,4-triazinyl, pyrazolinyl, imidazolinyl, oxazolinyl, isoxazolinyl, thiazolinyl, 3(2H)-pyridazinone, benzothiazolyl, benzimidazolyl, indazolyl, benzoxazolyl, quinolyl, isoquinolyl, quinoxalinyl, phthalazinyl, cinnolinyl, and quinazolinyl groups;

B represents H, a C₁-C₄ alkyl group, a C₁-C₄ haloalkyl group, a C₂-C₄ alkoxyalkyl group, CH₃SCH₂, CH₃OC₂H₄OCH₂, a C₁-C₄ alkyl group substituted by a phenyl group optionally substituted by a halogen or a C₁-C₄ alkyl group, a C₁-C₄ alkyl group substituted by a benzoyl group optionally substituted by a halogen or a C₁-C₄ alkyl group, a tetrahydropyranyl group, (CH₃)₂Si, a C₁-C₄ alkylsulfonyl group, a phenylsulfonyl group optionally substituted by a halogen or a C₁-C₄ alkyl group, —SO₂CF₃, a C₁-C₄ monoalkylaminosulfonyl group, a C₂-C₈ dialkylaminosulfonyl group, a phenylaminosulfonyl group, a C₂-C₅ monoalkylaminothiocarbonyl group, a C₃-C₉ dialkylaminothiocarbonyl group, a C₂-C₅ cyanoalkyl group, a C₃-C₉ alkoxy-carbonylalkyl group, —C(=O)T¹, —P(=O)T²T³, —P(=S)T²T³, an alkali metal atom, an alkaline earth metal atom, or NHT⁴T⁵T⁶;

E represents CN;

R is a substituent selected from the group consisting of a halogen atom, a C₁-C₁₀ alkyl group, a C₁-C₄ alkyl group substituted by a phenyl group optionally substituted by a halogen or a C₁-C₄ alkyl group, a C₂-C₆ alkenyl group, a C₂-C₆ alkynyl group, a C₁-C₆ haloalkyl group, a C₂-C₆ haloalkenyl group, a C₂-C₆ haloalkynyl group, a C₃-C₆ halocycloalkyl group, a C₃-C₆ cycloalkyl group optionally substituted by a C₁-C₃ alkyl group, a C₁-C₆ alkoxy group, a C₂-C₆ alkenyloxy group, a C₂-C₆ alkynyloxy group, a C₁-C₄ haloalkoxy group, a C₂-C₆ haloalkenyloxy group, a C₂-C₆ haloalkynyloxy group, a C₁-C₄ alkylsulfenyl group, a C₁-C₄ alkylsulfinyl group, a C₁-C₄ alkylsul-

fonyl group, a C₂-C₆ alkenylsulfenyl group, a C₂-C₆ alkenylsulfinyl group, a C₂-C₆ alkenylsulfonyl group, a C₂-C₆ alkynylsulfenyl group, a C₂-C₆ alkynylsulfinyl group, a C₂-C₆ alkynylsulfonyl group, a C₁-C₄ haloalkylsulfenyl group, a C₁-C₄ haloalkylsulfinyl group, a C₁-C₄ haloalkylsulfonyl group, a C₂-C₆ haloalkenylsulfenyl group, a C₂-C₆ haloalkenylsulfinyl group, a C₂-C₆ haloalkenylsulfonyl group, a C₂-C₆ haloalkynylsulfenyl group, a C₂-C₆ haloalkynylsulfinyl group, a C₂-C₆ haloalkynylsulfonyl group, NO₂, CN, —NU¹U², a phenoxy group, OH, a naphthyl group, a C₂-C₇ alkoxy-carbonyl group, a C₂-C₄ alkoxy-alkyl group, a C₂-C₄ alkylcarbonyl group, a C₂-C₅ alkylcarbonyloxy group, a C₂-C₅ haloalkylcarbonyloxy group, a benzoyl group optionally substituted by X, a phenyl group optionally substituted by X, a pyridyl group optionally substituted by X, a thienyl group optionally substituted by X, and —N=CT⁷T⁸, provided that when the substituent is two or more, then said substituents may be the same or different, and the number of the substituent, R, is 1 or 2, or R is an alkylene group as bonded to the adjacent substituting positions to form a 5-, 6-, 7- or 8-membered ring;

Y is a substituent selected from the group consisting of a halogen atom, a C₁-C₁₀ alkyl group, a C₁-C₆ haloalkyl group, a C₁-C₆ alkoxy group, a C₂-C₆ alkenyloxy group, a C₂-C₆ alkynyloxy group, a C₁-C₄ haloalkoxy group, a C₂-C₆ haloalkenyloxy group, a C₂-C₆ haloalkynyloxy group, a C₁-C₄ alkylsulfenyl group, a C₁-C₄ alkylsulfinyl group, a C₁-C₄ alkylsulfonyl group, a C₂-C₆ alkenylsulfenyl group, a C₂-C₆ alkenylsulfinyl group, a C₂-C₆ alkenylsulfonyl group, a C₂-C₆ alkynylsulfenyl group, a C₂-C₆ alkynylsulfinyl group, a C₂-C₆ alkynylsulfonyl group, a C₁-C₄ haloalkylsulfenyl group, a C₁-C₄ haloalkylsulfinyl group, a C₁-C₄ haloalkylsulfonyl group, a C₂-C₆ haloalkenylsulfenyl group, a C₂-C₆ haloalkenylsulfinyl group, a C₂-C₆ haloalkenylsulfonyl group, a C₂-C₆ haloalkynylsulfenyl group, a C₂-C₆ haloalkynylsulfinyl group, a C₂-C₆ haloalkynylsulfonyl group, NO₂, CN, —NU¹U², OH, a C₂-C₇ alkoxy-carbonyl group, a C₂-C₄ alkoxyalkyl group, a C₂-C₅ alkylcarbonyloxy group, a C₃-C₇ dialkylaminocarbonyloxy group, a phenyl group optionally substituted by X, and —N=CT⁷T⁸, provided that when the substituent is two or more, then said substituents may be the same or different, and the number of the substituent, Y, is 1, 2, 3 or 4, or Y is an alkylene group as bonded to the adjacent substituting positions to form a 5-, 6-, 7- or 8-membered ring;

W is a substituent selected from the group consisting of a halogen atom, a C₁-C₆ alkyl group, a C₁-C₄ haloalkyl group, a C₁-C₄ alkoxy group, a C₁-C₄ haloalkoxy group, a C₁-C₄ alkylsulfenyl group, a C₁-C₄ alkylsulfinyl group, a C₁-C₄ alkylsulfonyl group, a C₁-C₄ haloalkylsulfenyl group, a C₁-C₄ haloalkylsulfinyl group, a C₁-C₄ haloalkylsulfonyl group, a C₂-C₄ alkenyl group, a C₂-C₄ haloalkenyl group, a C₂-C₄ alkenyloxy group, a C₂-C₄ haloalkenyloxy group, a C₂-C₄ alkenylsulfenyl group, a C₂-C₄ alkenylsulfinyl group, a C₂-C₄ alkenylsulfonyl group, a C₂-C₄ haloalkenylsulfenyl group, a C₂-C₄ haloalkenylsulfinyl group, a C₂-C₄ haloalkenylsulfonyl group, a C₂-C₄ alkynyl group, a C₂-C₄ haloalkynyl group, a C₂-C₄ alkynyloxy group, a C₂-C₄ haloalkynyloxy group, a C₂-C₄ alkynylsulfenyl group, a C₂-C₄ alkynylsulfinyl group, a C₂-C₄ alkynylsulfonyl group, a C₂-C₄ alkynylsul-

haloalkynylsulfenyl group, a C₂-C₄ haloalkynylsulfenyl group, a C₂-C₄ haloalkynylsulfonyl group, NO₂, CN, a formyl group, a C₂-C₆ alkoxy carbonyl group, a C₂-C₆ alkyl carbonyl group, a C₂-C₆ haloalkyl carbonyl group, a C₂-C₆ alkyl carbonyloxy group, and —NU¹U², provided that when the substituent is two or more, then said substituents may be the same or different, and the number of the substituent, W, is 1, 2, 3 and 4;

T¹ represents a C₁-C₂₀ alkyl group, a C₂-C₆ alkenyl group, a C₁-C₆ haloalkyl group, a C₁-C₄ alkoxy-C₁-C₄ alkyl group, a C₃-C₆ halocycloalkyl group, a C₁-C₄ alkyl group substituted by a phenyl group optionally substituted by a halogen or a C₁-C₄ alkyl group, a C₃-C₆ cycloalkyl group optionally substituted by a C₁-C₃ alkyl group, a cycloalkyl group substituted by a phenyl group optionally substituted by a halogen or a C₁-C₄ alkyl group, a cyclopropyl group substituted by both a phenyl group optionally substituted by a halogen or a C₁-C₄ alkyl group and a C₁-C₄ alkyl group, a C₃-C₄ cycloalkyl group substituted by both a phenyl group optionally substituted by a halogen or a C₁-C₄ alkoxy group and a halogen, a cyclopropyl group substituted by both a C₂-C₄ alkenyl group optionally substituted by a halogen and a C₁-C₄ alkyl group, a C₂-C₄ alkenyl group substituted by a phenyl group optionally substituted by a halogen or a C₁-C₄ alkyl group, a C₁-C₁₂ alkoxy group, a C₁-C₄ haloalkoxy group, a C₂-C₅ alkenyloxy group, a C₃-C₆ cycloalkoxy group optionally substituted by a C₁-C₃ alkyl group, a benzyloxy group, a C₂-C₅ alkoxy carbonyl group, —NU¹U², a phenylamino group, a phenyl group optionally substituted by Z, a phenoxy group optionally substituted by Z, a phenylthio group optionally substituted by Z, a naphthyl group optionally substituted by Z, or a 5-membered or 6-membered heterocyclic group optionally substituted by Z wherein said heterocyclic group is selected from the group consisting of a thienyl, furyl, pyrrolyl, oxazolyl, isoxazolyl, thiazolyl, isothiazolyl, pyrazolyl, imidazolyl, 1,3,4-oxadiazolyl, 1,2,4-oxadiazolyl, 1,3,4-thiadiazolyl, 1,2,4-thiadiazolyl, 1,2,3-thiadiazolyl, 1,2,4-triazolyl, 1,2,3-triazolyl, 1,2,3,4-tetrazolyl, pyridinyl, pyrimidinyl, pyrazinyl, pyridazinyl, 1,3,5-triazinyl, 1,2,4-triazinyl, pyrazolinyl, imidazolinyl, oxazolinyl, isoxazolinyl, thiazolinyl, and 3(2H)-pyridazinone groups;

T² and T³ each independently represent OH, a phenyl, a C₁-C₆ alkyl group, a C₁-C₆ alkoxy group, or a C₁-C₄ alkylsulfenyl group;

T⁴, T⁵ and T⁶ each independently represent H, a C₁-C₆ alkyl group, a C₁-C₆ alkenyl group, a C₃-C₆ cycloalkyl group optionally substituted by a C₁-C₃ alkyl group, or a benzyl group; or any two of T⁴, T⁵ and T⁶ may form, together with the nitrogen atom to which they are bonded, a 5-, 6-, 7- or 8-membered cyclic group optionally containing oxygen, nitrogen and/or sulfur atoms;

X and Z are independently substituents selected from the group consisting of a halogen atom, a C₁-C₄ alkyl group, a C₁-C₄ haloalkyl group, a C₁-C₄ alkoxy group, a C₁-C₄ haloalkoxy group, a C₁-C₄ alkylsulfenyl group, a C₁-C₄ alkylsulfinyl group, a C₁-C₄ alkylsulfonyl group, a C₂-C₅ alkenylsulfenyl group, a C₂-C₅ alkenylsulfinyl group, a C₂-C₅ alkenylsulfonyl group, a C₁-C₄ haloalkylsulfenyl group, a C₁-C₄ haloalkylsulfinyl group, a C₁-C₄ haloalkylsulfonyl group, NO₂,

CN, CHO, OH, —NU¹U², a phenyl group, a phenoxy group, and a C₂-C₅ alkoxy carbonyl group, provided that when the substituent is two or more, then said substituents may be the same or different, and the number of the substituent, X and Z, is 1, 2, 3, 4 or 5 each;

T⁷ and T⁸ each independently represent H, or a phenyl, benzyl, or a C₁-C₆ alkyl group, or T⁷ and T⁸ may, together with the carbon atom to which they are bonded, form a 5-, 6-, 7-, or 8-membered ring;

U¹ and U² each independently represent H, a C₁-C₆ alkyl, a C₂-C₅ alkyl carbonyl, phenyl or benzyl group, or U¹ and U² may, together with the nitrogen atom to which they are bonded, form a 5-, 6-, 7-, or 8-membered ring.

2. Ethylene derivatives as claimed in claim 1, wherein:

A represents a phenyl group optionally substituted by W, or a heterocyclic group optionally substituted by Y, wherein said heterocyclic group is selected from the group consisting of a thienyl, furyl, pyrrolyl, oxazolyl, isoxazolyl, thiazolyl, isothiazolyl, pyrazolyl, imidazolyl, 1,3,4-oxadiazolyl, 1,2,4-oxadiazolyl, 1,3,4-thiadiazolyl, 1,2,4-thiadiazolyl, 1,2,3-thiadiazolyl, 1,2,4-triazolyl, 1,2,3-triazolyl, 1,2,3,4-tetrazolyl, pyridinyl, pyrimidinyl, pyrazinyl, pyridazinyl, 1,3,5-triazinyl, 1,2,4-triazinyl, pyrazolinyl, and imidazolinyl groups and a naphthyl group optionally substituted by W;

B represents H, a C₁-C₄ alkyl group, a C₁-C₄ haloalkyl group, a C₂-C₄ alkoxyalkyl group, CH₃OC₂H₄OCH₂, a C₁-C₄ alkylsulfenyl group, a phenylsulfenyl group optionally substituted by a halogen or a C₁-C₄ alkyl group, —SO₂CF₃, a C₂-C₈ dialkylaminosulfonyl group, a C₃-C₉ dialkylaminothiocarbonyl group, a C₃-C₉ alkoxy carbonylalkyl group, —C(=O)T¹, —P(=O)T²T³, —P(=S)T²T³, an alkali metal atom, an alkaline earth metal atom, or NHT⁴T⁵T⁶; and

T¹ represents a C₁-C₂₀ alkyl group, a C₂-C₆ alkenyl group, a C₁-C₆ haloalkyl group, a C₁-C₄ alkoxy-C₁-C₄ alkyl group, a C₃-C₆ halocycloalkyl group, a C₁-C₄ alkyl group substituted by a phenyl group optionally substituted by a halogen or a C₁-C₄ alkyl group, a C₃-C₆ cycloalkyl group optionally substituted by a C₁-C₃ alkyl group, a cycloalkyl group substituted by a phenyl group optionally substituted by a halogen or a C₁-C₄ alkyl group, a cyclopropyl group substituted by both a phenyl group optionally substituted by a halogen or a C₁-C₄ alkyl group and a C₁-C₄ alkyl group, a C₃-C₄ cycloalkyl group substituted by both a phenyl group optionally substituted by a halogen or a C₁-C₄ alkoxy group and a halogen, a cyclopropyl group substituted by both a C₂-C₄ alkenyl group optionally substituted by a halogen and a C₁-C₄ alkyl group, a C₂-C₄ alkenyl group substituted by a phenyl group optionally substituted by a halogen or a C₁-C₄ alkyl group, a C₁-C₁₂ alkoxy group, a C₁-C₄ haloalkoxy group, a C₂-C₅ alkenyloxy group, a C₃-C₆ cycloalkoxy group optionally substituted by a C₁-C₃ alkyl group, a benzyloxy group, a C₂-C₅ alkoxy carbonyl group, a phenyl group optionally substituted by Z, a phenoxy group optionally substituted by Z, a phenylthio group, a naphthyl group, or a 5-membered or 6-membered heterocyclic group optionally substituted by Z wherein said heterocyclic group is selected from the group consisting of a thienyl, furyl, oxazolyl, thiazolyl, pyrazolyl, and pyridinyl groups.

3. Ethylene derivatives as claimed in claim 2, wherein A represents a phenyl group optionally substituted by W, a thiazolyl group optionally substituted by Y, a pyrazolyl

group optionally substituted by Y, a pyridinyl group optionally substituted by Y, or a pyrimidinyl group optionally substituted by Y; and

Q is represented by the following formula:

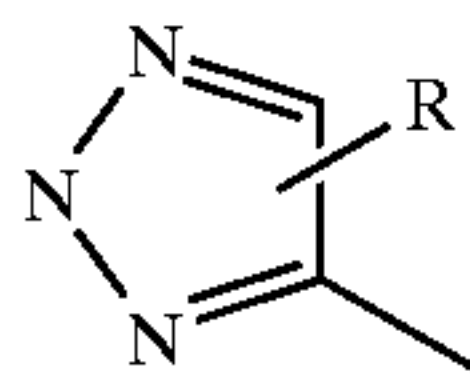

4. Ethylene derivatives as claimed in claim 2, wherein:

B represents H, a C₁-C₄ alkyl group, a C₁-C₄ haloalkyl group, a C₂-C₄ alkoxyalkyl group, CH₃OC₂H₄OCH₂, a C₁-C₄ alkyl sulfonyl group, a phenylsulfonyl group optionally substituted by a halogen or a C₁-C₄ alkyl group, or -C(=O)T¹; and

Q is represented by the following formula:

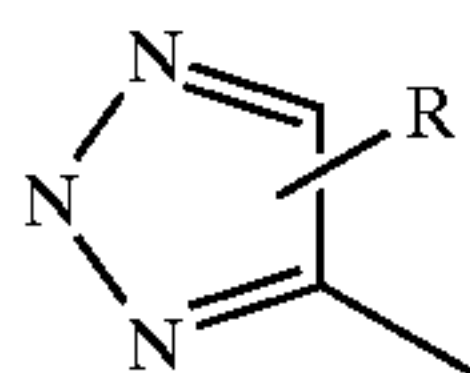

5. Ethylene derivatives as claimed in claim 4, wherein:

B represents H, a C₁-C₄ alkyl group, a C₁-C₄ haloalkyl group, a C₂-C₄ alkoxyalkyl group, CH₃OC₂H₄OCH₂, a C₁-C₄ alkylsulfonyl group, or -C(=O)T¹; and

T¹ represents a C₁-C₂₀ alkyl group, a C₂-C₆ alkenyl group, a C₁-C₄ haloalkyl group, a C₁-C₄ alkoxy-C₁-C₄ alkyl group, a C₁-C₁₂ alkoxy group, a C₁-C₄ haloalkoxy group, a phenyl group optionally substituted by Z, or a pyridinyl group optionally substituted by Z.

6. Ethylene derivatives as claimed in claim 4, wherein R is a substituent selected from the group consisting of a halogen atom, a C₁-C₁₀ alkyl group, a C₁-C₄ alkyl group substituted by a phenyl group optionally substituted by a halogen or a C₁-C₄ alkyl group, a C₁-C₆ haloalkyl group, a C₃-C₆ cycloalkyl group optionally substituted by a C₁-C₃ alkyl group, a C₁-C₆ alkoxy group, CN, a naphthyl group, a C₂-C₇ alkoxy carbonyl group, a C₂-C₄ alkoxyalkyl group, a C₂-C₄ alkyl carbonyl group, a phenyl group optionally substituted by X, a pyridyl group optionally substituted by X, and a thienyl group optionally substituted by X, and the number of the substituent, R, is 1 or 2.

7. Ethylene derivatives as claimed in claim 6, wherein:

B represents H, a C₁-C₄ alkyl group, a C₁-C₄ haloalkyl group, a C₂-C₄ alkoxyalkyl group, CH₃OC₂H₄OCH₂, a C₁-C₄ alkylsulfonyl group, or -C(=O)T¹; and

T¹ represents a C₁-C₂₀ alkyl group, a C₂-C₆ alkenyl group, a C₁-C₄ haloalkyl group, a C₁-C₄ alkoxy-C₁-C₄ alkyl group, a C₁-C₁₂ alkoxy group, a C₁-C₄ haloalkoxy group, a phenyl group optionally substituted by Z, or a pyridinyl group optionally substituted by Z.

8. Ethylene derivatives as claimed in claim 3, wherein R is a substituent selected from the group consisting of a halogen atom, a C₁-C₁₀ alkyl group, a C₁-C₄ alkyl group substituted by a phenyl group optionally substituted by a halogen or a C₁-C₄ alkyl group, a C₁-C₆ haloalkyl group, a C₃-C₆ cycloalkyl group optionally substituted by a C₁-C₃ alkyl group, a C₁-C₆ alkoxy group, CN, a naphthyl group, a C₂-C₇ alkoxy carbonyl group, a C₂-C₄ alkoxyalkyl group, a C₂-C₄ alkyl carbonyl group, a phenyl group optionally substituted by X, a pyridyl group optionally substituted by X, and a thienyl group optionally substituted by X, and the number of the substituent, R, is 1 or 2.

9. Ethylene derivatives as claimed in claim 8, wherein:

B represents H, a C₁-C₄ alkyl group, a C₁-C₄ haloalkyl group, a C₂-C₄ alkoxyalkyl group, CH₃OC₂H₄OCH₂, a C₁-C₄ alkylsulfonyl group, or -C(=O)T¹; and

T¹ represents a C₁-C₂₀ alkyl group, a C₂-C₆ alkenyl group, a C₁-C₄ haloalkyl group, a C₁-C₄ alkoxy-C₁-C₄ alkyl group, a C₁-C₁₂ alkoxy group, a C₁-C₄ haloalkoxy group, a phenyl group optionally substituted by Z, or a pyridinyl group optionally substituted by Z.

10. Ethylene derivatives as claimed in claim 6, wherein R is a substituent selected from the group consisting of a C₁-C₁₀ alkyl group, a C₃-C₆ cycloalkyl group optionally substituted by a C₁-C₃ alkyl group, CN, a naphthyl group, a C₂-C₇ alkoxy carbonyl group, a C₂-C₄ alkoxyalkyl group, a phenyl group optionally substituted by X, a pyridyl group optionally substituted by X, and a thienyl group optionally substituted by X, and the number of the substituent, R, is 1 or 2.

11. Ethylene derivatives as claimed in claim 10, wherein:

B represents H, a C₁-C₄ alkyl group, a C₁-C₄ haloalkyl group, a C₂-C₄ alkoxyalkyl group, CH₃OC₂H₄OCH₂, a C₁-C₄ alkylsulfonyl group, or -C(=O)T¹; and

T¹ represents a C₁-C₂₀ alkyl group, a C₂-C₆ alkenyl group, a C₁-C₄ haloalkyl group, a C₁-C₄ alkoxy-C₁-C₄ alkyl group, a C₁-C₁₂ alkoxy group, a C₁-C₄ haloalkoxy group, a phenyl group optionally substituted by Z, or a pyridinyl group optionally substituted by Z.

12. Ethylene derivatives as claimed in claim 10, wherein

A represents a phenyl group optionally substituted by W, a thiazolyl group optionally substituted by Y, a pyrazolyl group optionally substituted by Y, a pyridinyl group optionally substituted by Y, or a pyrimidinyl group optionally substituted by Y.

13. Ethylene derivatives as claimed in claim 12, wherein:

B represents H, a C₁-C₄ alkyl group, a C₁-C₄ haloalkyl group, a C₂-C₄ alkoxyalkyl group, CH₃OC₂H₄OCH₂, a C₁-C₄ alkylsulfonyl group, or -C(=O)T¹; and

T¹ represents a C₁-C₂₀ alkyl group, a C₂-C₆ alkenyl group, a C₁-C₄ haloalkyl group, a C₁-C₄ alkoxy-C₁-C₄ alkyl group, a C₁-C₁₂ alkoxy group, a C₁-C₄ haloalkoxy group, a phenyl group optionally substituted by Z, or a pyridinyl group optionally substituted by Z.

14. Ethylene derivatives as claimed in claim 10, wherein

R is a substituent selected from the group consisting of a C₁-C₁₀ alkyl group, a C₃-C₆ cycloalkyl group optionally substituted by a C₁-C₃ alkyl group, a C₂-C₄ alkoxyalkyl group, a phenyl group optionally substituted by X, and a pyridyl group optionally substituted by X, and the number of the substituent, R, is 1 or 2.

15. Ethylene derivatives as claimed in claim 14, wherein:

B represents H, a C₁-C₄ alkyl group, a C₁-C₄ haloalkyl group, a C₂-C₄ alkoxyalkyl group, CH₃OC₂H₄OCH₂, a C₁-C₄ alkylsulfonyl group, or -C(=O)T¹; and

T¹ represents a C₁-C₂₀ alkyl group, a C₂-C₆ alkenyl group, a C₁-C₄ haloalkyl group, a C₁-C₄ alkoxy-C₁-C₄ alkyl group, a C₁-C₁₂ alkoxy group, a C₁-C₄ haloalkoxy group, a phenyl group optionally substituted by Z, or a pyridinyl group optionally substituted by Z.

16. Ethylene derivatives as claimed in claim 14, wherein

A represents a phenyl group optionally substituted by W, a thiazolyl group optionally substituted by Y, a pyra-

zoyl group optionally substituted by Y, a pyridinyl group optionally substituted by Y, or a pyrimidinyl group optionally substituted by Y.

17. Ethylene derivatives as claimed in claim 16, wherein:

B represents H, a C₁-C₄ alkyl group, a C₁-C₄ haloalkyl group, a C₂-C₄ alkoxyalkyl group, CH₃OC₂H₄OCH₂, a C₁-C₄ alkylsulfonyl group, or —C(=O)T¹; and

T¹ represents a C₁-C₂₀ alkyl group, a C₂-C₆ alkenyl group, a C₁-C₄ haloalkyl group, a C₁-C₄ alkoxy-C₁-C₄ alkyl group, a C₁-C₁₂ alkoxy group, a C₁-C₄ haloalkoxy group, a phenyl group optionally substituted by Z, or a pyridinyl group optionally substituted by Z.

18. Ethylene derivatives as claimed in claim 17, wherein A represents a pyrazolyl group optionally substituted by Y, or a pyridinyl group optionally substituted by Y.

19. Ethylene derivatives as claimed in claim 14, wherein R is a substituent selected from the group consisting of a C₁-C₁₀ alkyl group, and a phenyl group, and the number of the substituent, R, is 1 or 2.

20. Ethylene derivatives as claimed in claim 19, wherein: B represents H, a C₁-C₄ alkyl group, a C₁-C₄ haloalkyl group, a C₂-C₄ alkoxyalkyl group, CH₃OC₂H₄OCH₂, a C₁-C₄ alkylsulfonyl group, or —C(=O)T¹; and

T¹ represents a C₁-C₂₀ alkyl group, a C₂-C₆ alkenyl group, a C₁-C₄ haloalkyl group, a C₁-C₄ alkoxy-C₁-C₄ alkyl group, a C₁-C₁₂ alkoxy group, a C₁-C₄ haloalkoxy group, a phenyl group optionally substituted by Z, or a pyridinyl group optionally substituted by Z.

21. Ethylene derivatives as claimed in claim 19, wherein A represents a phenyl group optionally substituted by W, a thiazolyl group optionally substituted by Y, a pyrazolyl group optionally substituted by Y, a pyridinyl group optionally substituted by Y, or a pyrimidinyl group optionally substituted by Y.

22. Ethylene derivatives as claimed in claim 21, wherein: B represents H, a C₁-C₄ alkyl group, a C₁-C₄ haloalkyl group, a C₂-C₄ alkoxyalkyl group, CH₃OC₂H₄OCH₂, a C₁-C₄ alkylsulfonyl group, or —C(=O)T¹; and

T¹ represents a C₁-C₂₀ alkyl group, a C₂-C₆ alkenyl group, a C₁-C₄ haloalkyl group, a C₁-C₄ alkoxy-C₁-C₄ alkyl group, a C₁-C₁₂ alkoxy group, a C₁-C₄ haloalkoxy group, a phenyl group optionally substituted by Z, or a pyridinyl group optionally substituted by Z.

23. Ethylene derivatives as claimed in claim 21, wherein A represents a pyrazolyl group optionally substituted by Y or a pyridinyl group optionally substituted by Y.

24. Ethylene derivatives as claimed in claim 23, wherein: B represents H, a C₁-C₄ alkyl group, a C₁-C₄ haloalkyl group, a C₂-C₄ alkoxyalkyl group, CH₃OC₂H₄OCH₂, a C₁-C₄ alkylsulfonyl group, or —C(=O)T¹; and

T¹ represents a C₁-C₂₀ alkyl group, a C₂-C₆ alkenyl group, a C₁-C₄ haloalkyl group, a C₁-C₄ alkoxy-C₁-C₄ alkyl group, a C₁-C₁₂ alkoxy group, or a C₁-C₄ haloalkoxy group.

25. Ethylene derivatives as claimed in claim 24, wherein: A is a heterocyclic group optionally substituted by Y, said heterocyclic group being a pyrazolyl or pyridinyl group;

B is H, a C₂-C₄ alkoxyalkyl group, or —C(=O)T¹;

Y is a substituent selected from the group consisting of a halogen atom, a C₁-C₁₀ alkyl group, and a C₁-C₆

haloalkyl group, and the number of the substituent, Y, is 1, 2, or 3;

T¹ is a C₁-C₂₀ alkyl group.

26. Ethylene derivatives as claimed in claim 1, wherein Q is represented by the following formula:

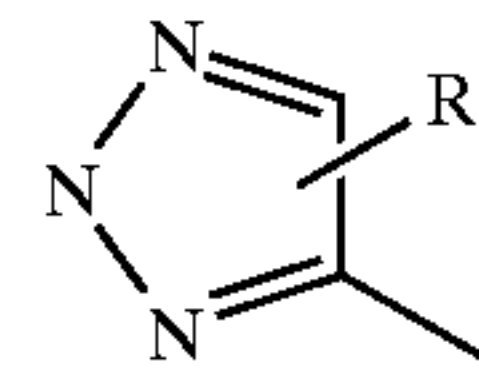

27. Ethylene derivatives as claimed in claim 26, wherein the ethylene derivative is represented by the following formula:

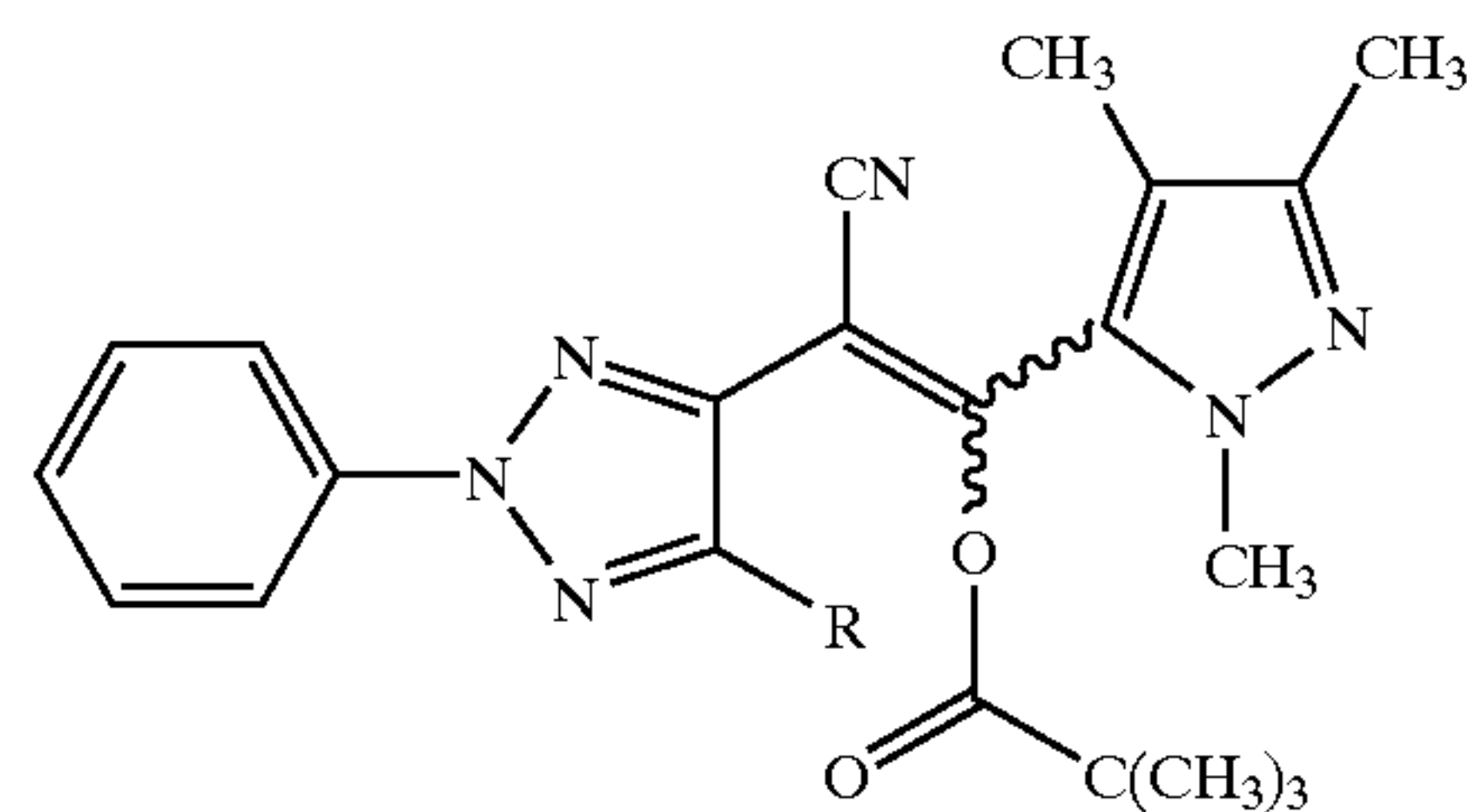

wherein R represents a C₁-C₆ alkyl group.

28. Ethylene derivatives as claimed in claim 26, wherein R is selected from the group consisting of 5-methyl-2-phenyl, 5-ethyl-2-phenyl, and 5-isopropyl-2-phenyl.

29. Ethylene derivatives as claimed in claim 1, wherein A is selected from the group consisting of:

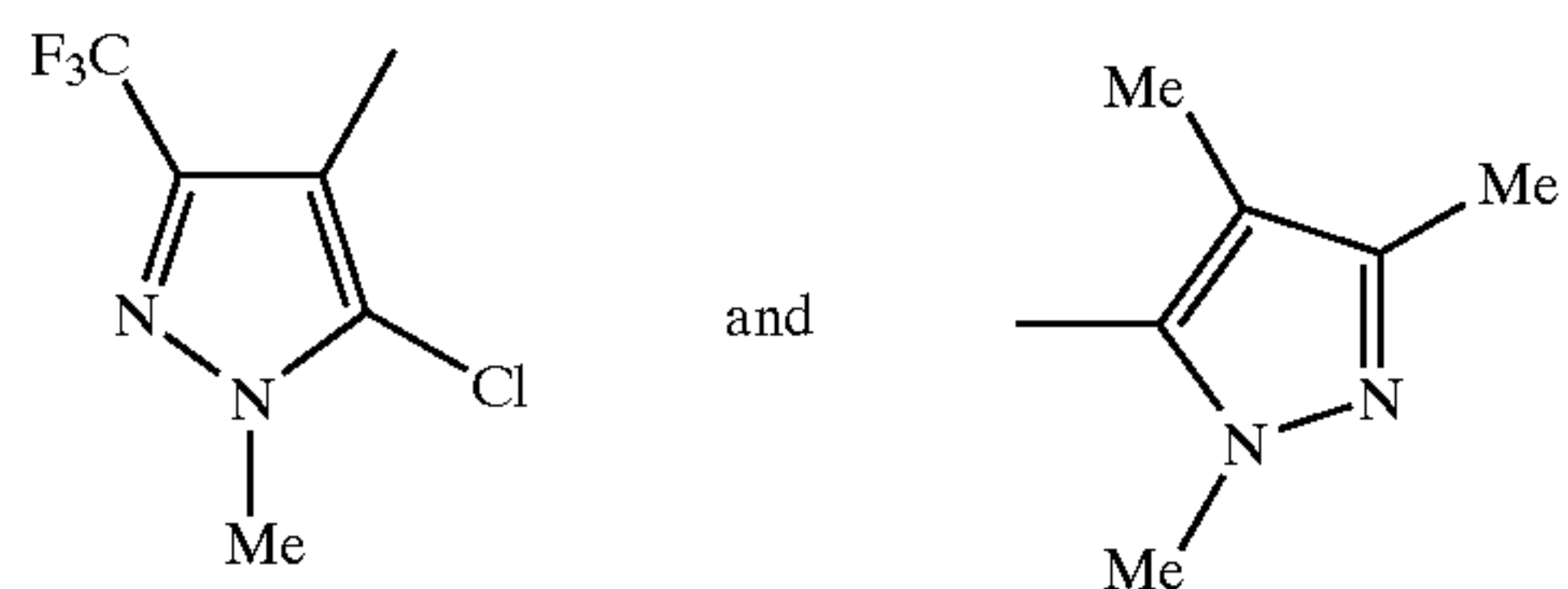

30. Ethylene derivatives as claimed in claim 1, wherein B is

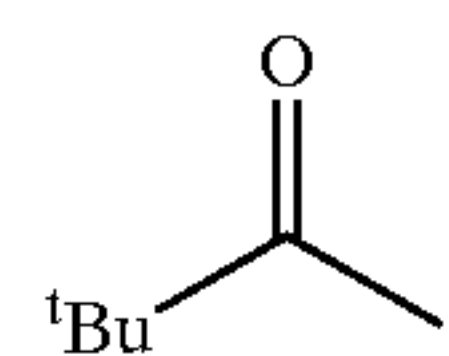

31. Ethylene derivatives as claimed in claim 1, wherein Q is represented by the following formula:

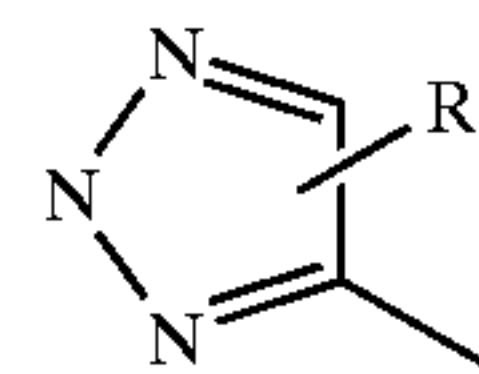

R is 5-methyl-2-phenyl;

A is represented by the following formula:

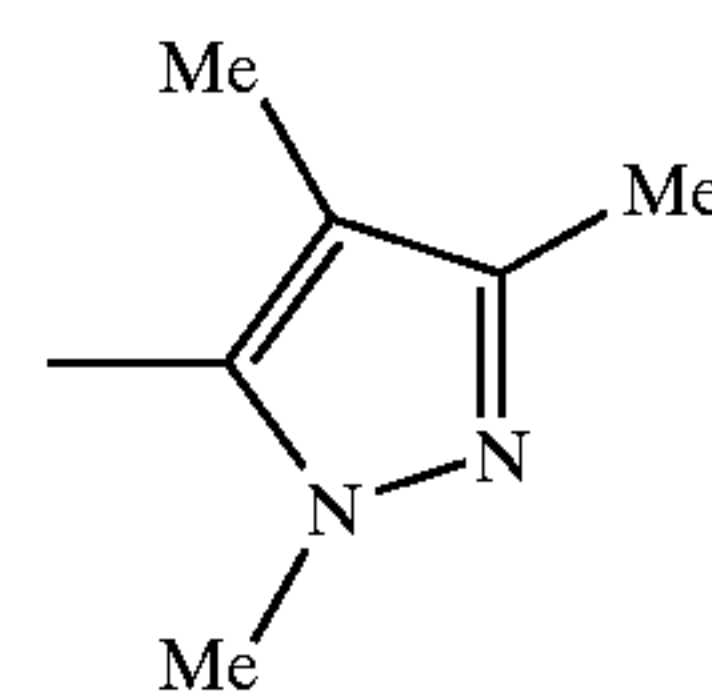

and

229

B is represented by the following formula:

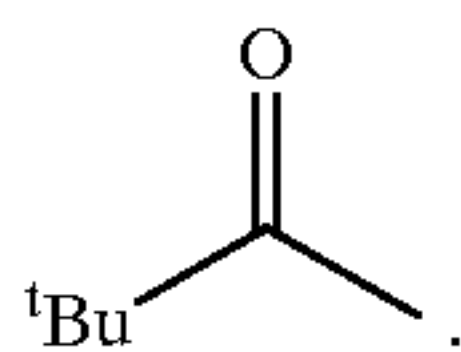

32. Ethylene derivatives as claimed in claim 1, wherein Q is represented by the following formula:

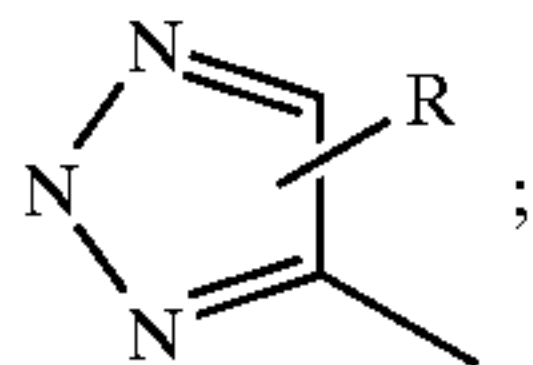

R is 5-ethyl-2-phenyl;

A is represented by the following formula:

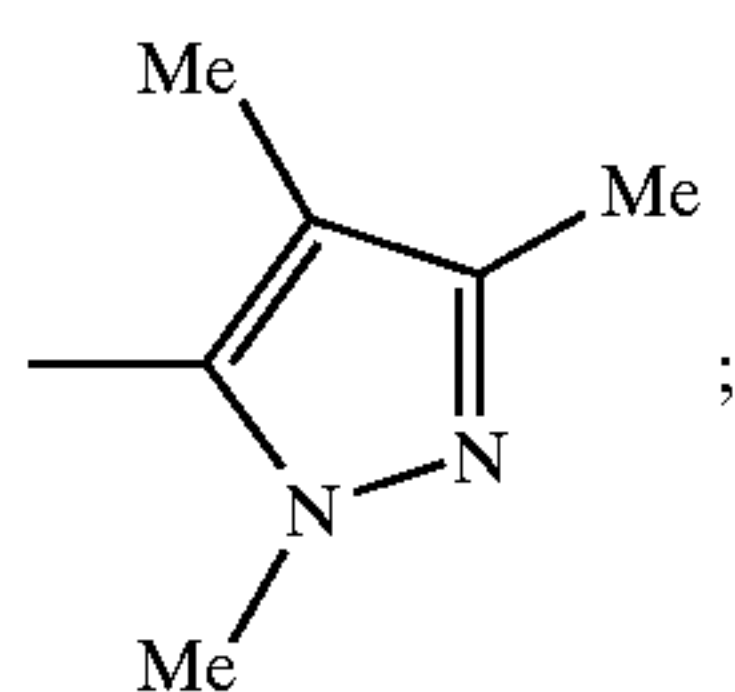

and

B is represented by the following formula:

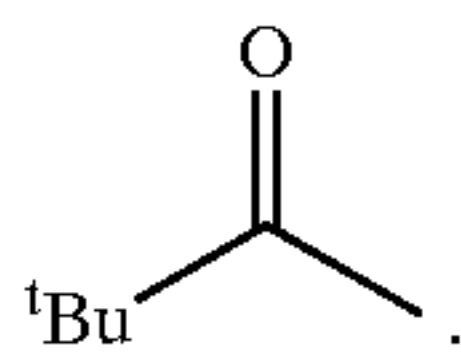

33. Ethylene derivatives as claimed in claim 1, wherein Q is represented by the following formula:

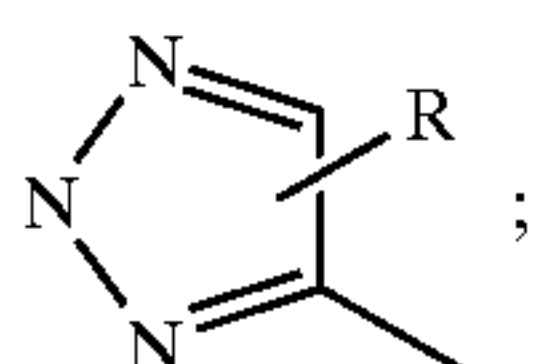

R is 5-isopropyl-2-phenyl;

230

A is represented by the following formula:

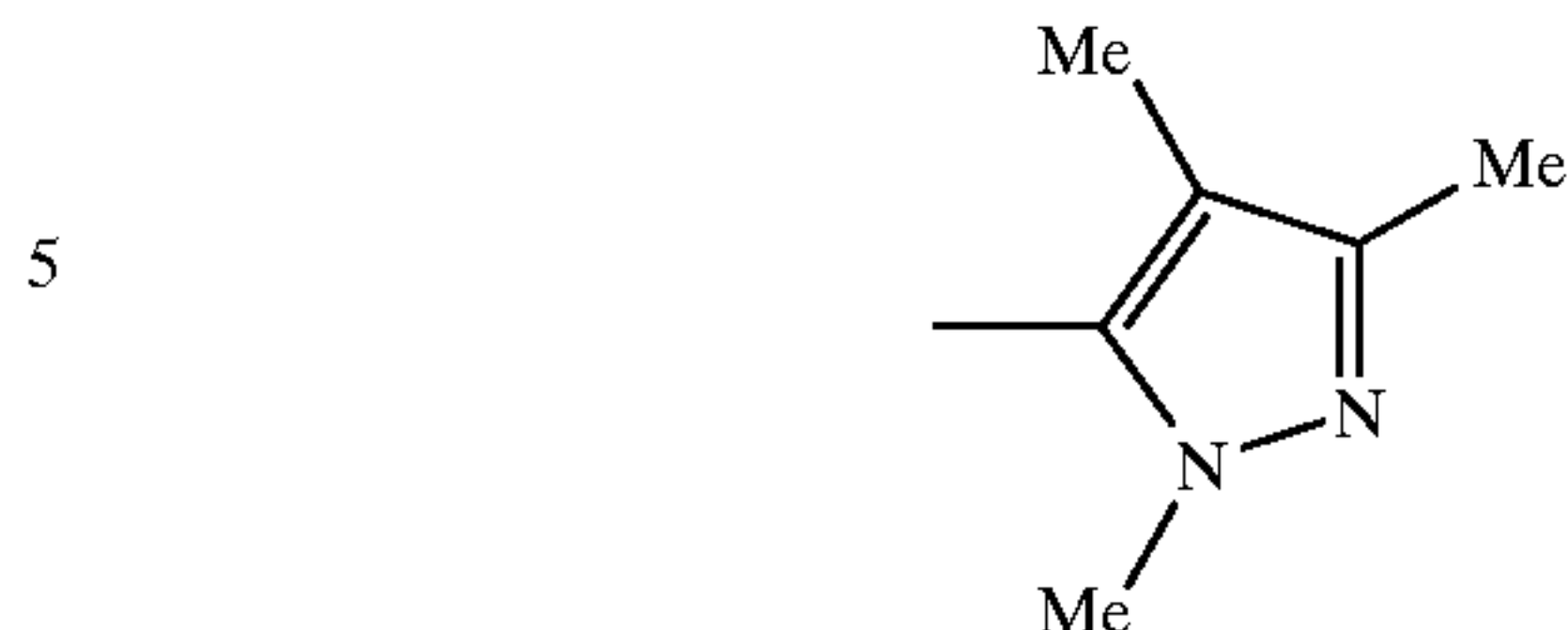

10

and

15

B is represented by the following formula:

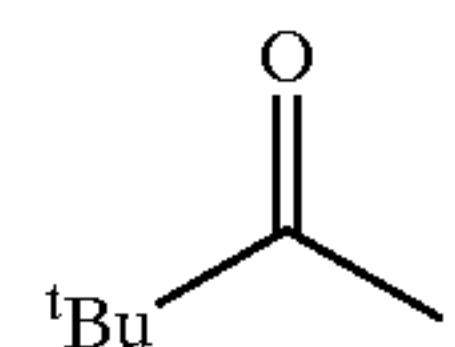

20

34. An agricultural chemical comprising, as an active ingredient, one or more ethylene derivatives of claim 1.

35. An insecticidal or acaricidal agent comprising, as an active ingredient, one or more ethylene derivatives of claim 1.

36. An agent for preventing the attachment of aquatic organisms to a substrate, the agent comprising, as an active ingredient, one or more ethylene derivatives of claim 1.

37. A method for controlling insects, acari, nematodes, herbs or fungi, comprising applying an agricultural chemical comprising, as an active ingredient, one or more compounds of claim 1.

38. A method for controlling insects or acari comprising applying an insecticidal or acaricidal agent comprising, as an active ingredient, one or more compounds of claim 1.

39. A method for preventing the attachment of aquatic organisms to a substrate, comprising applying to said substrate an agent comprising, as an active ingredient, one or more compounds of claim 1.

* * * * *