

[54] **REAR VIEW MIRROR**

[75] Inventor: **Alberto Vitaloni, Turin, Italy**  
[73] Assignee: **Vitaloni S.p.A., Beinasco, Italy**  
[21] Appl. No.: **32,726**  
[22] Filed: **Apr. 1, 1987**

**DESCRIPTION**

**Related U.S. Patent Documents**

Reissue of:

[64] Patent No.: **Des. 287,000**  
Issued: **Dec. 2, 1986**  
Appl. No.: **582,780**  
Filed: **Feb. 23, 1984**

[30] **Foreign Application Priority Data**

Sep. 12, 1983 [IT] Italy ..... 53708[U]  
[52] U.S. Cl. .... **D12/187**  
[58] Field of Search ..... **D12/187; 350/600, 631-636**

[56] **References Cited**

**U.S. PATENT DOCUMENTS**

D. 261,754 11/1981 Vitaloni ..... D12/187  
D. 271,480 11/1983 Vitaloni ..... D12/187  
D. 279,666 7/1985 Tanaka ..... D12/187  
D. 282,537 2/1986 Vitaloni ..... D12/187

*Primary Examiner*—James M. Gandy  
*Attorney, Agent, or Firm*—Robbins & Laramie

[57] **CLAIM**

The ornamental design for a rear view mirror, as shown and described.

FIG. 1 is a perspective view of the front, top and one side of a rear view mirror showing my new design which is mountable on the left side of a motor vehicle;  
FIG. 2 is a front elevational view thereof;  
FIG. 3 is a top plan view thereof;  
FIG. 4 is a rear elevational view thereof in inverted condition;  
FIG. 5 is a bottom plan view thereof;  
FIG. 6 is an elevational view of one side thereof;  
FIG. 7 is an elevational view of the other side thereof;  
FIG. 8 is a perspective view of the front, top and one side or a rear view mirror showing a second embodiment of my new design, the sole difference being that it is mountable on the left side of a motor vehicle;  
FIG. 9 is a front elevational view of the embodiment of FIG. 8;  
FIG. 10 is a top plan view of the embodiment of FIG. 8;  
FIG. 11 is a rear elevational view of the embodiment of FIG. 8 in inverted condition;  
FIG. 12 is a bottom plan view of the embodiment of FIG. 8;  
FIG. 13 is an elevational view of one side of the embodiment of FIG. 8;  
FIG. 14 is an elevational view of the other side of the embodiment of FIG. 8.

**1 Claim, 6 Drawing Sheets**

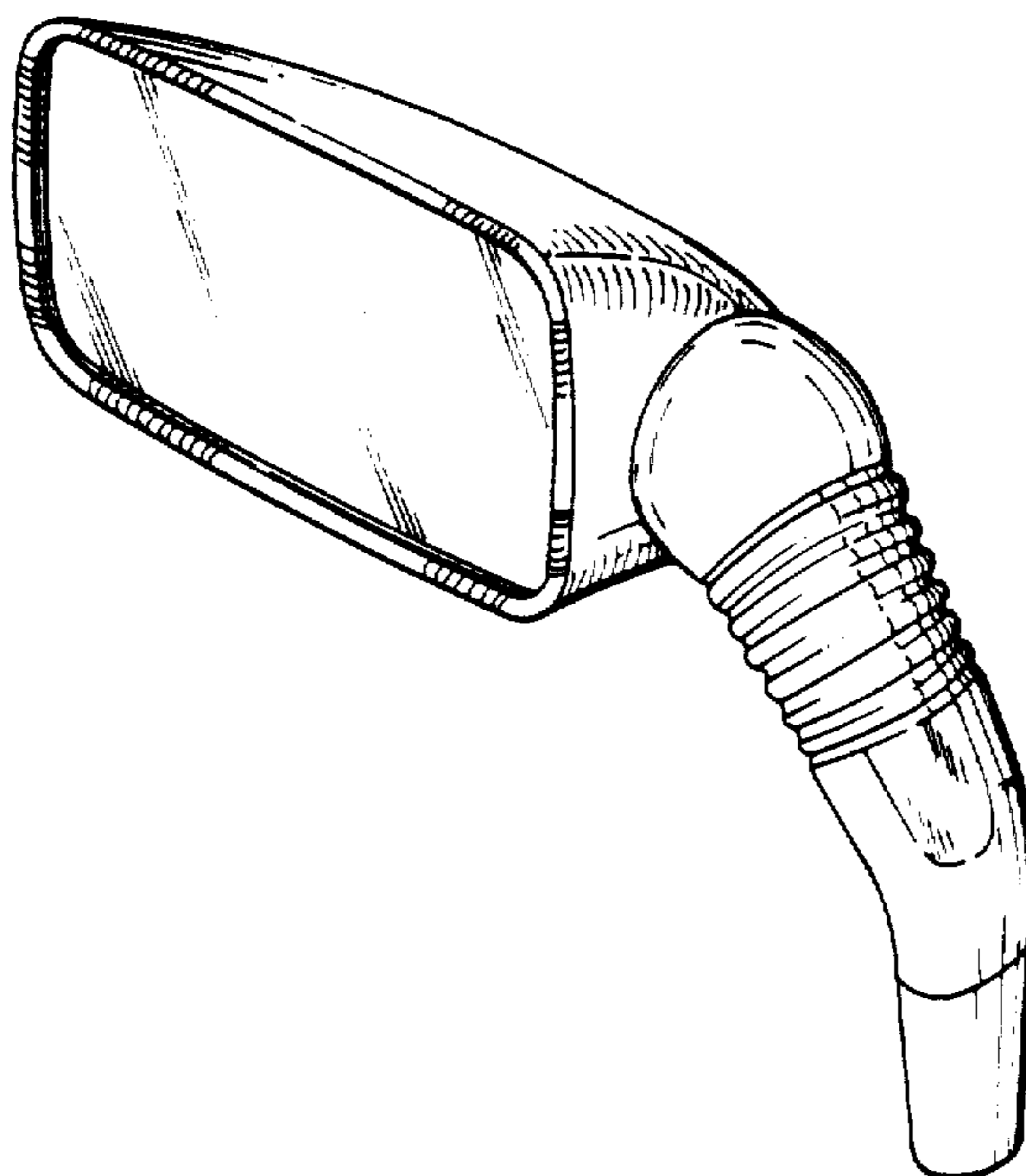
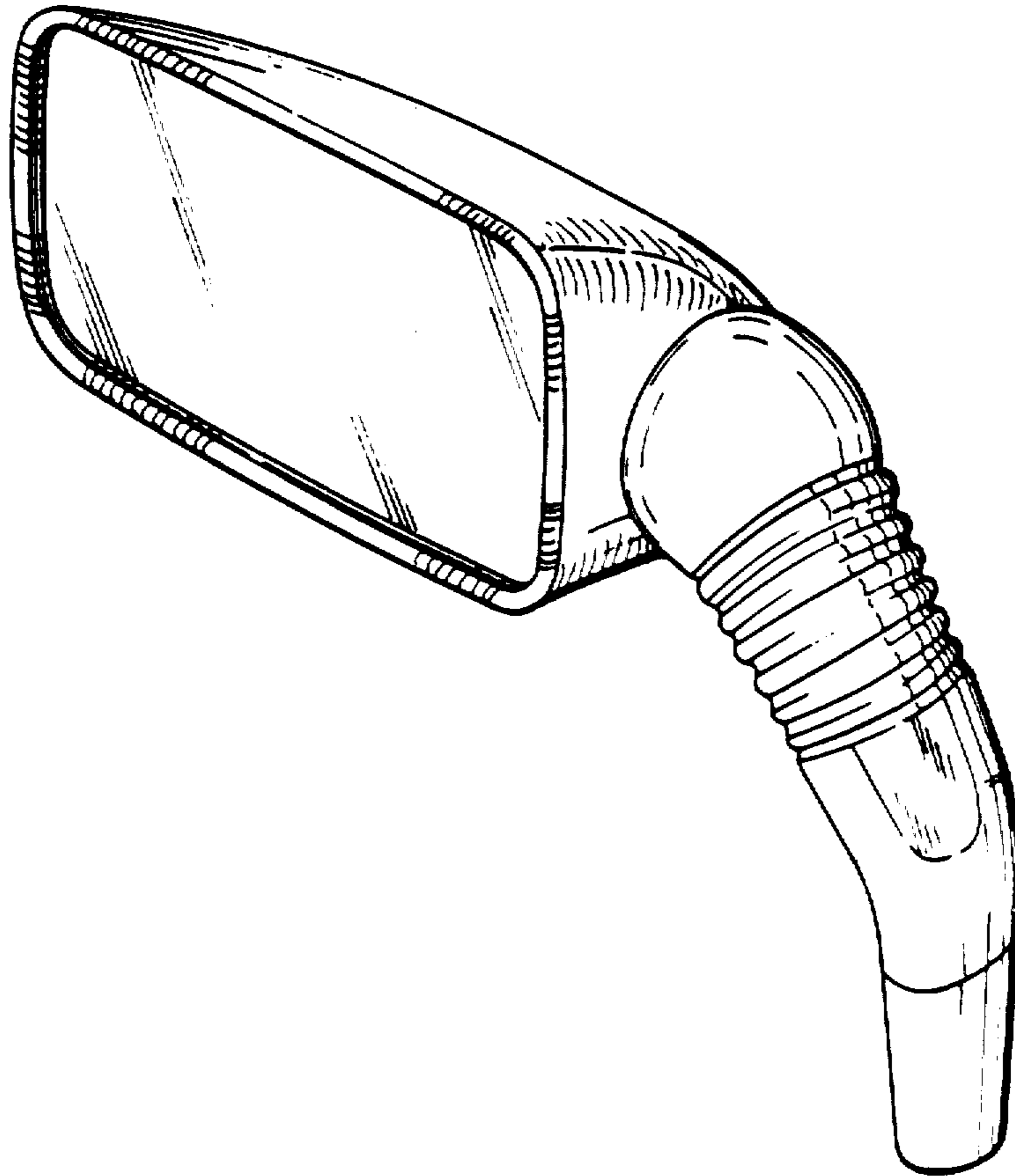

FIG. 1



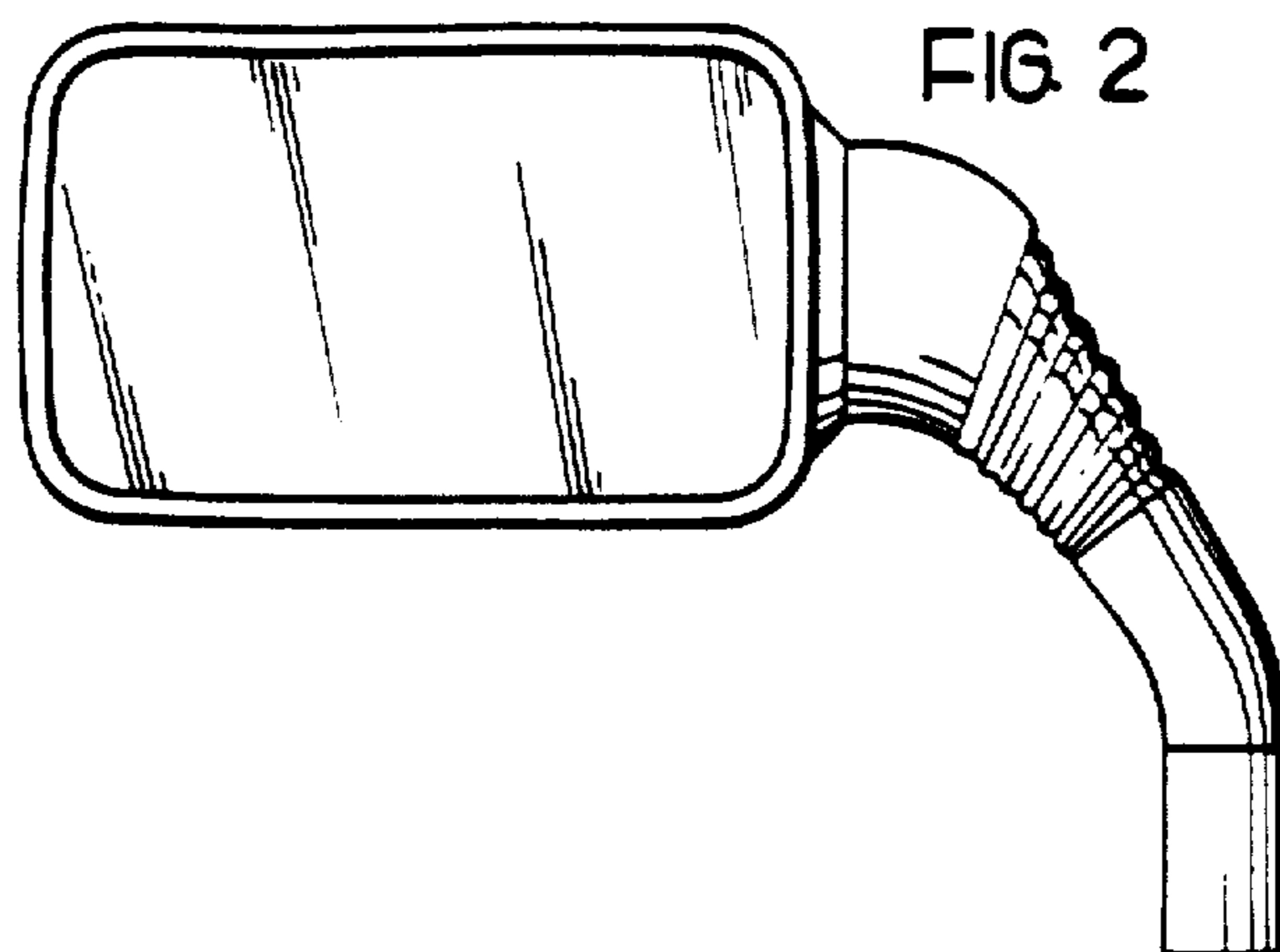

FIG. 3

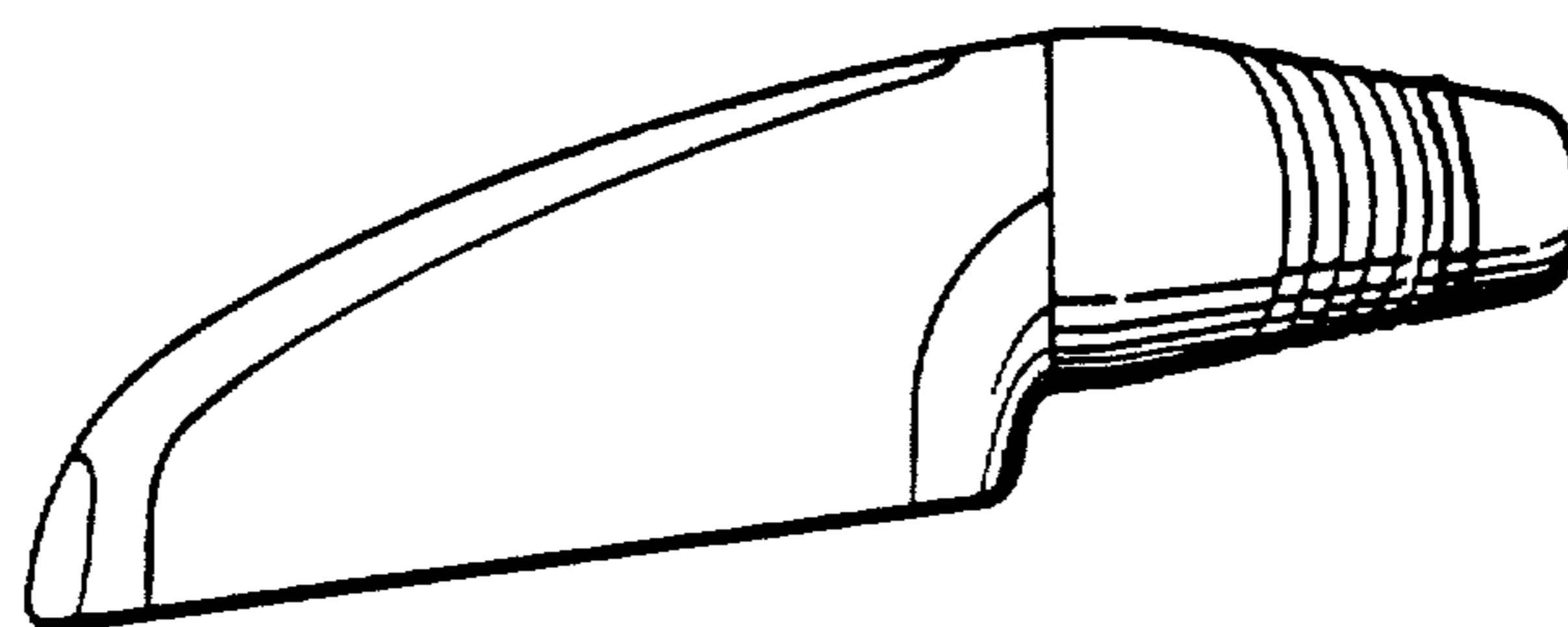

FIG. 4

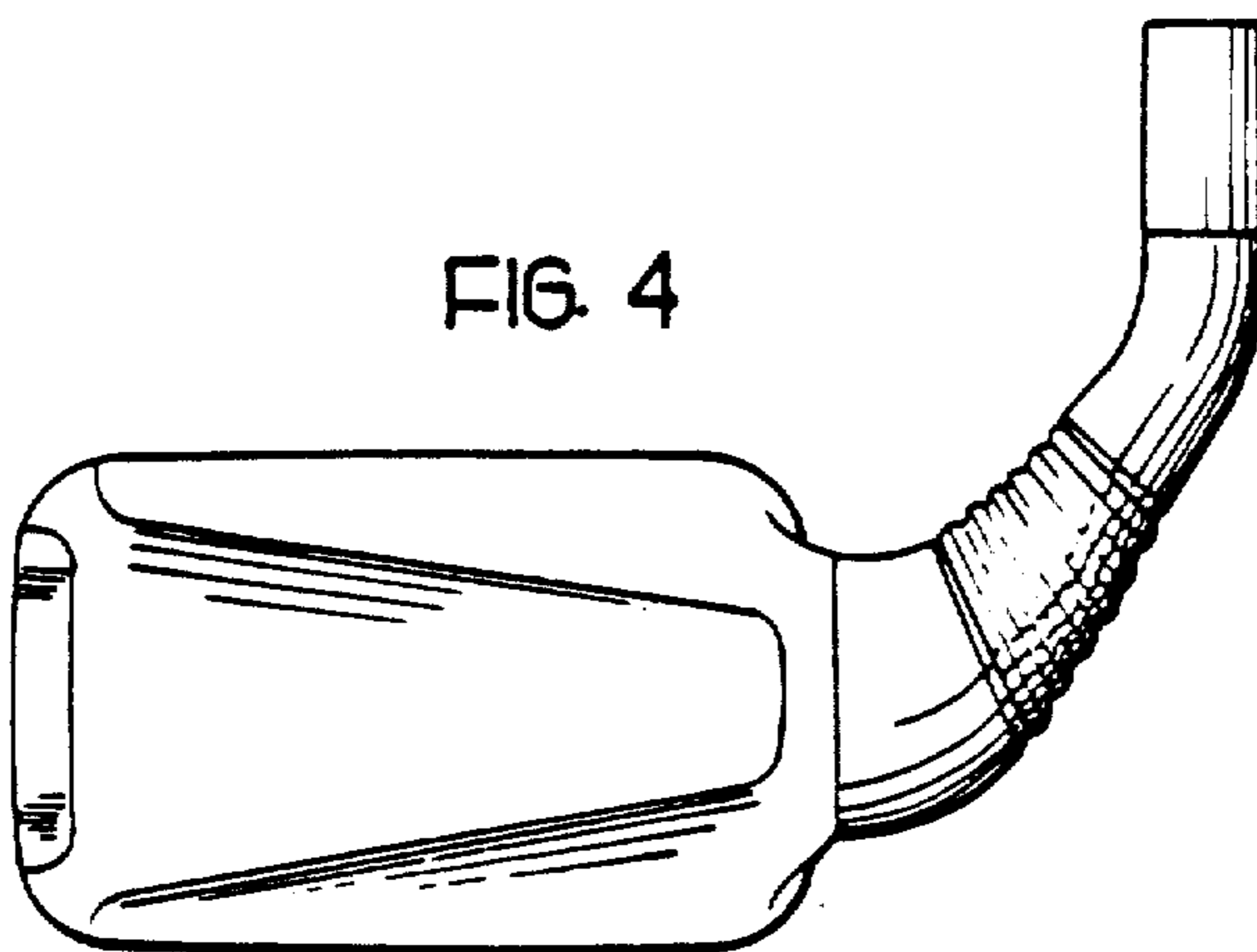

FIG. 5

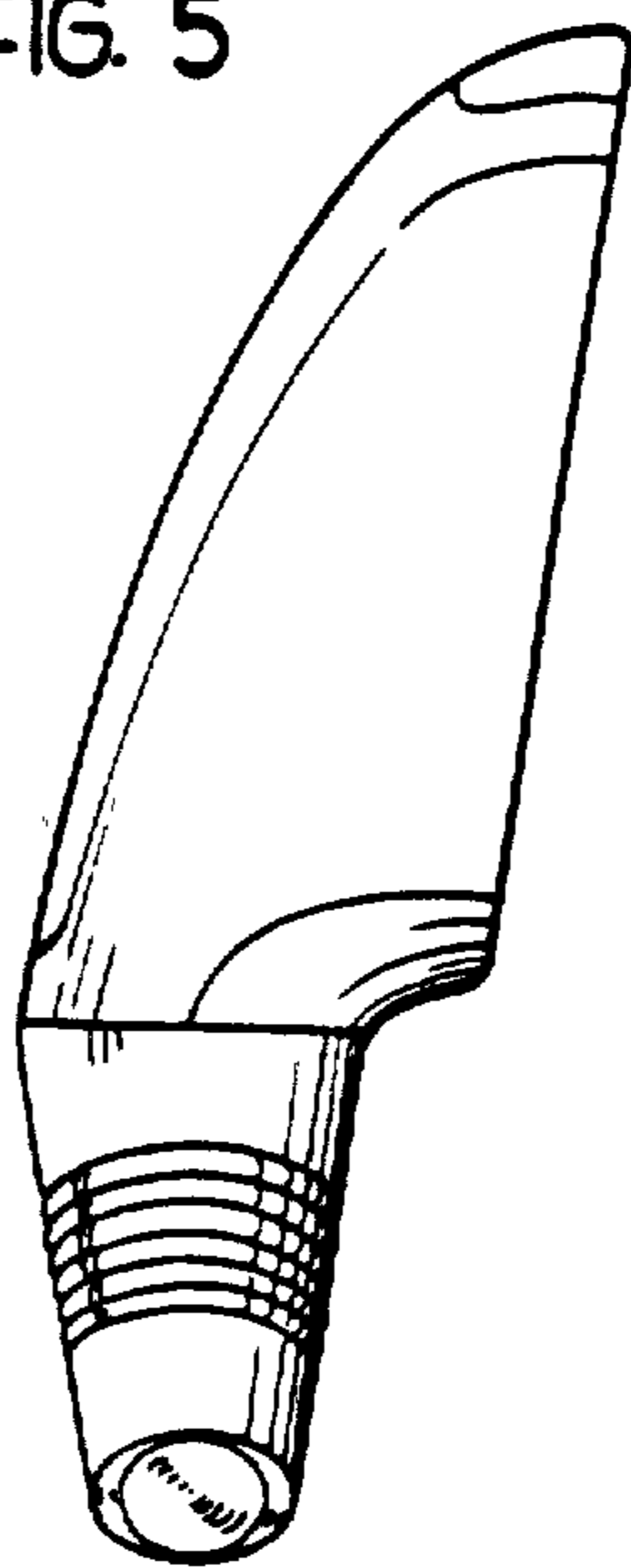

FIG. 6

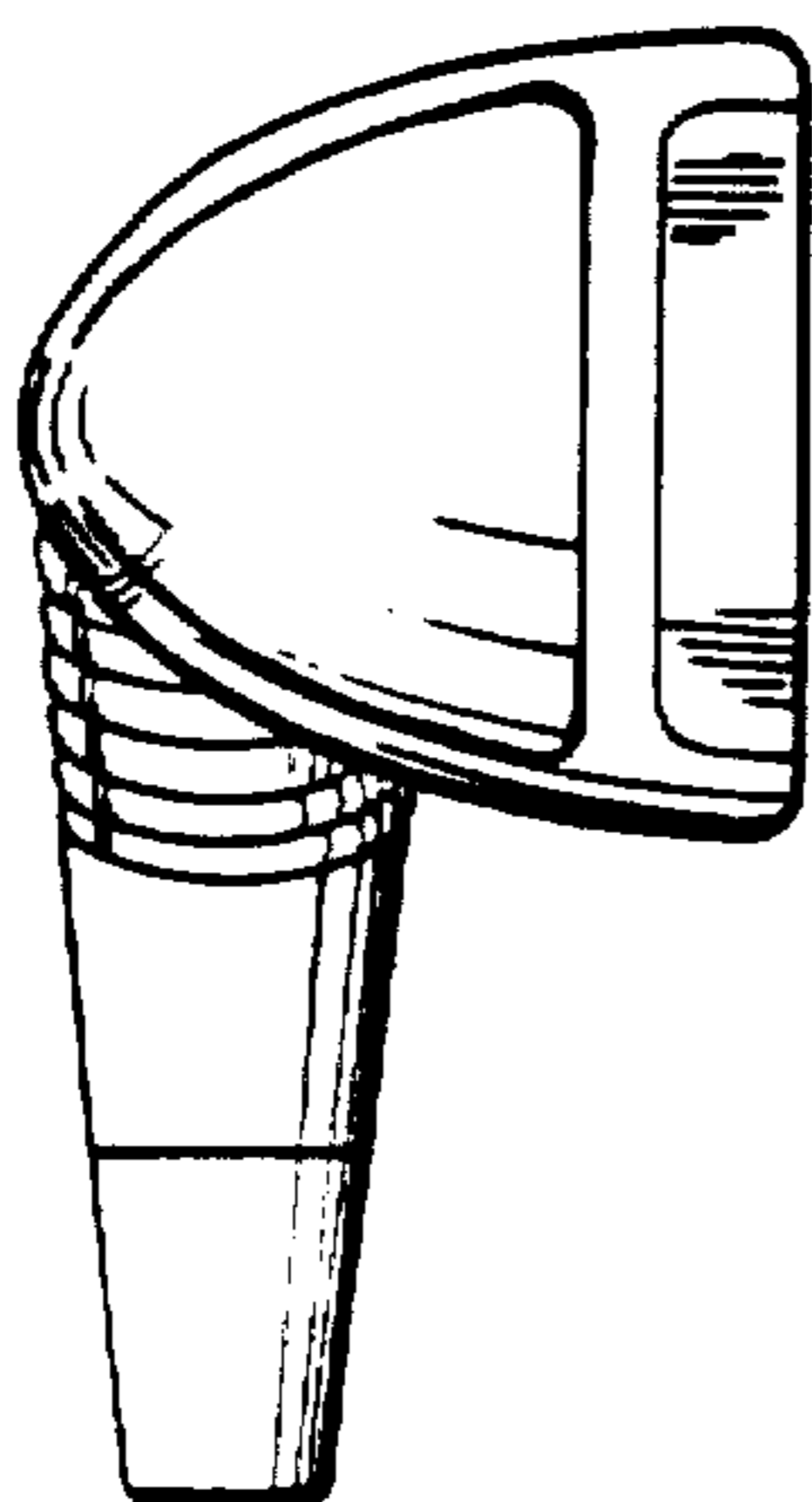

FIG. 7

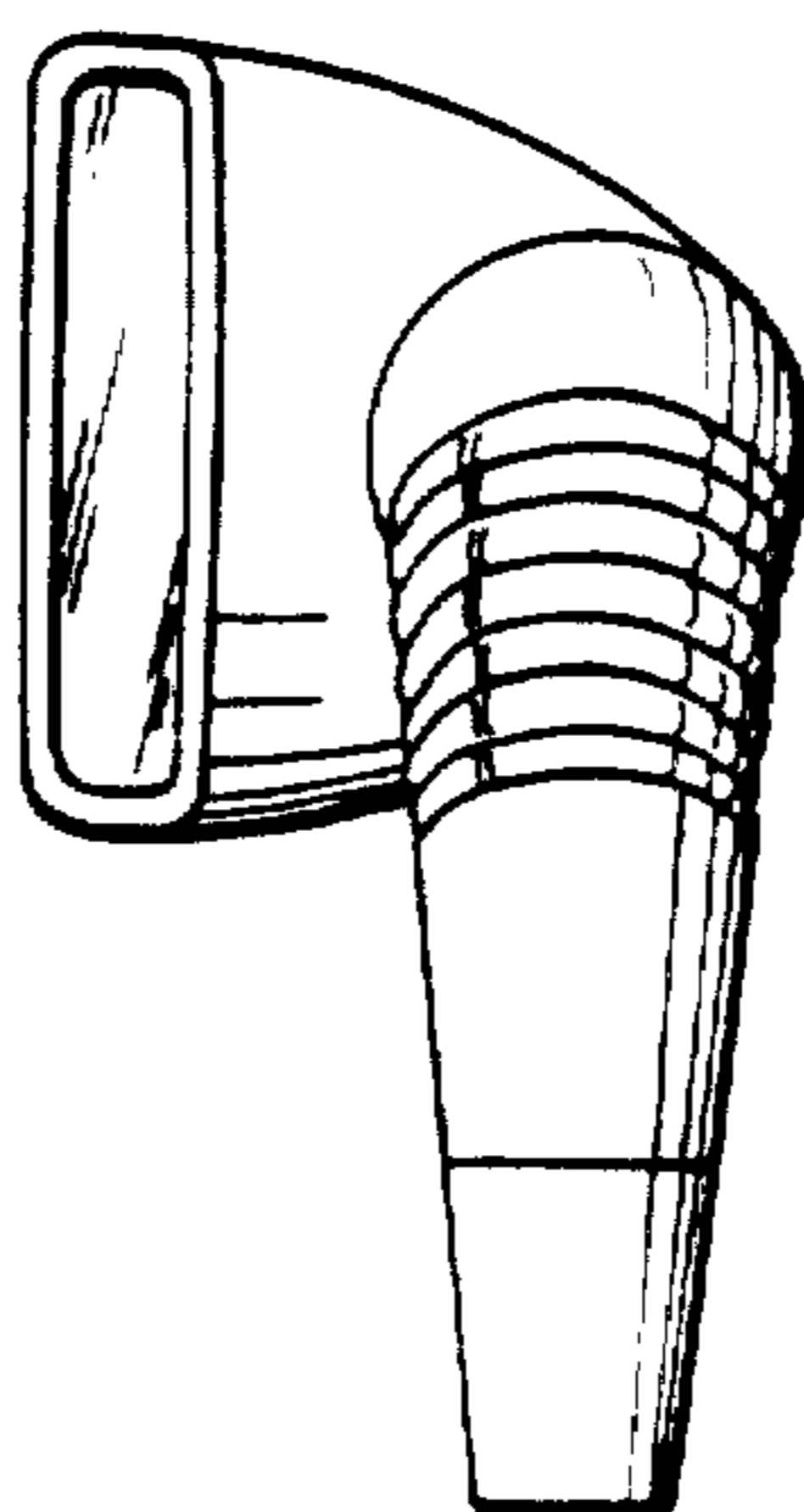

FIG. 8

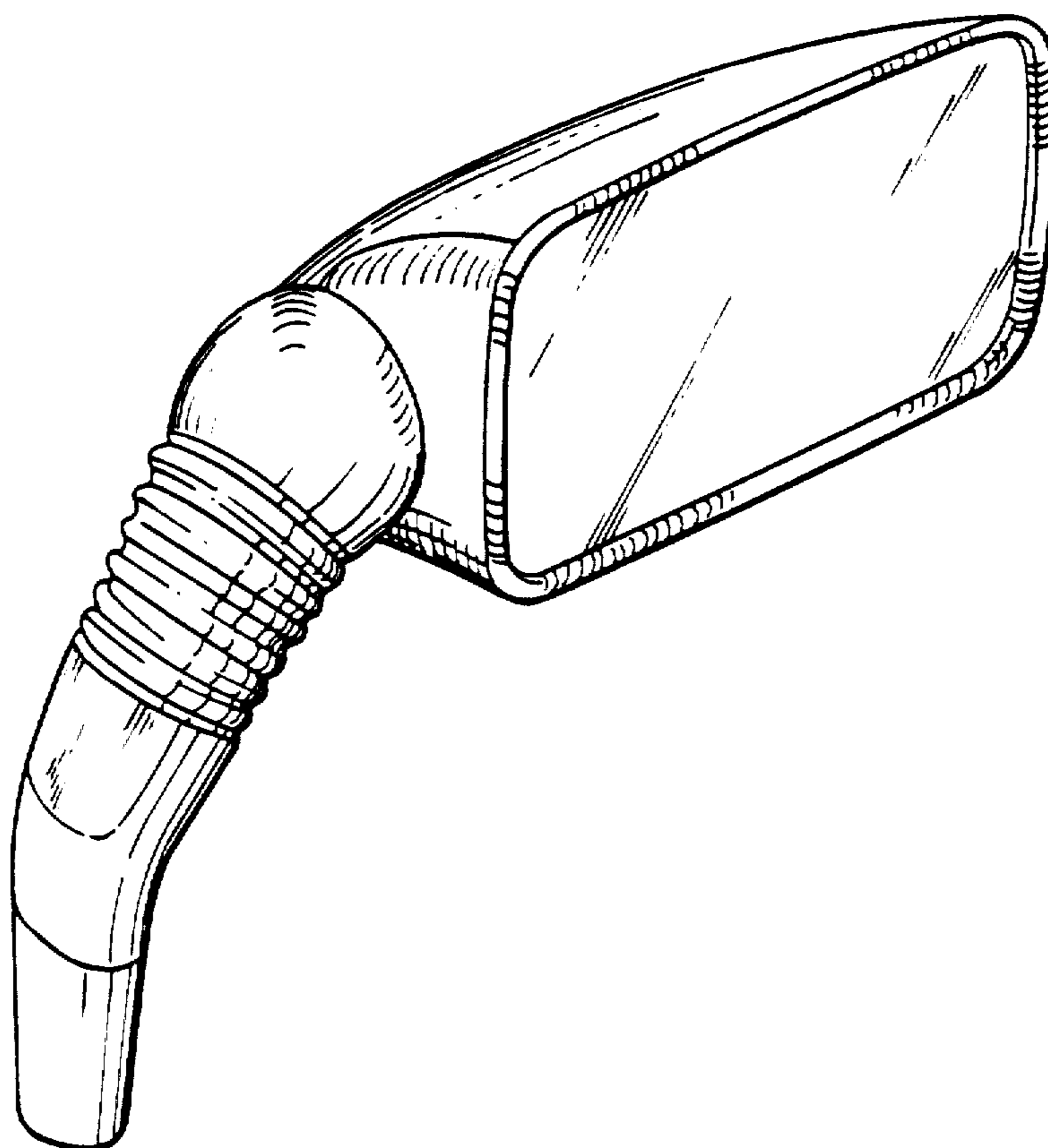

FIG. 9

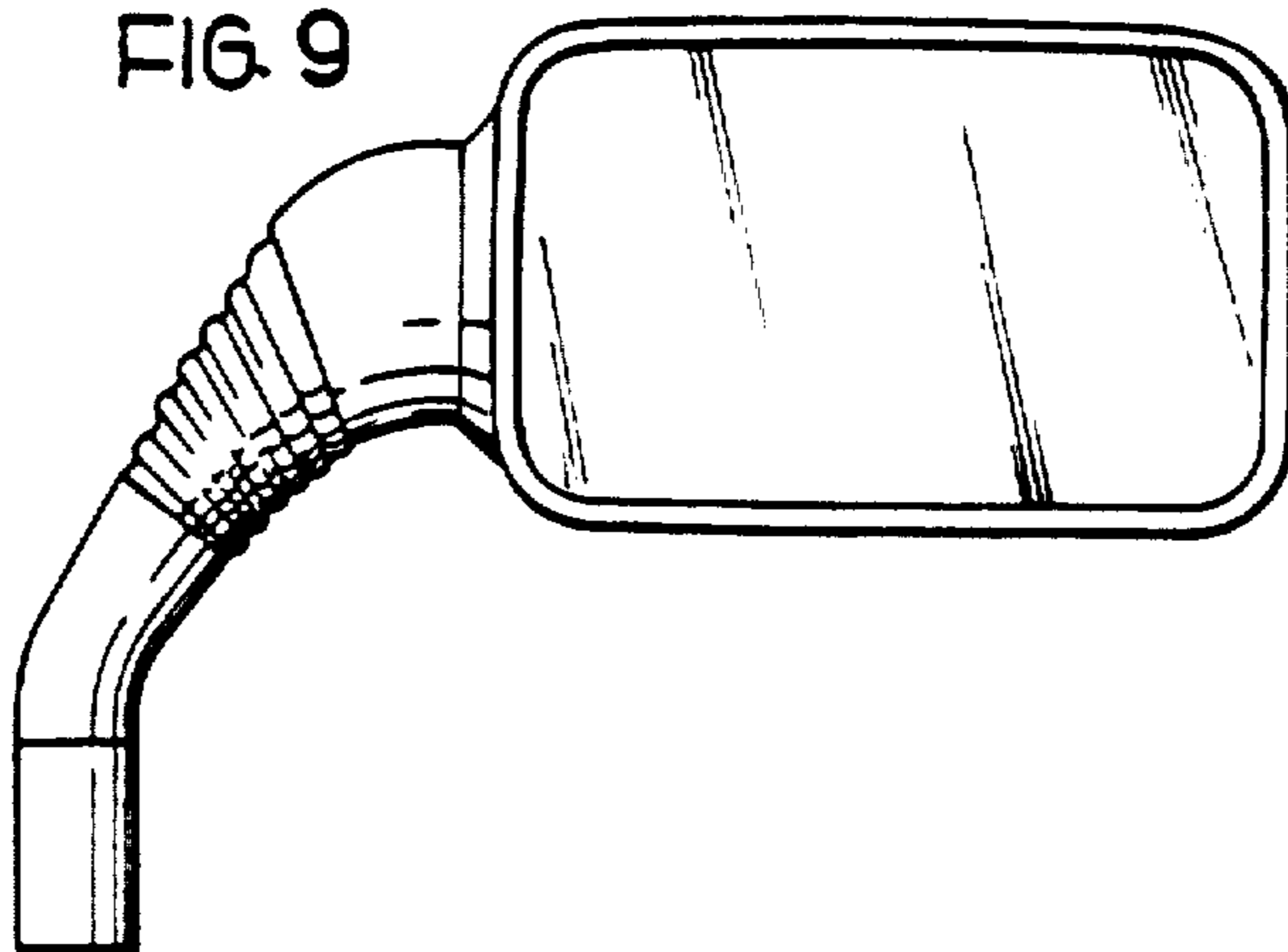

FIG. 10

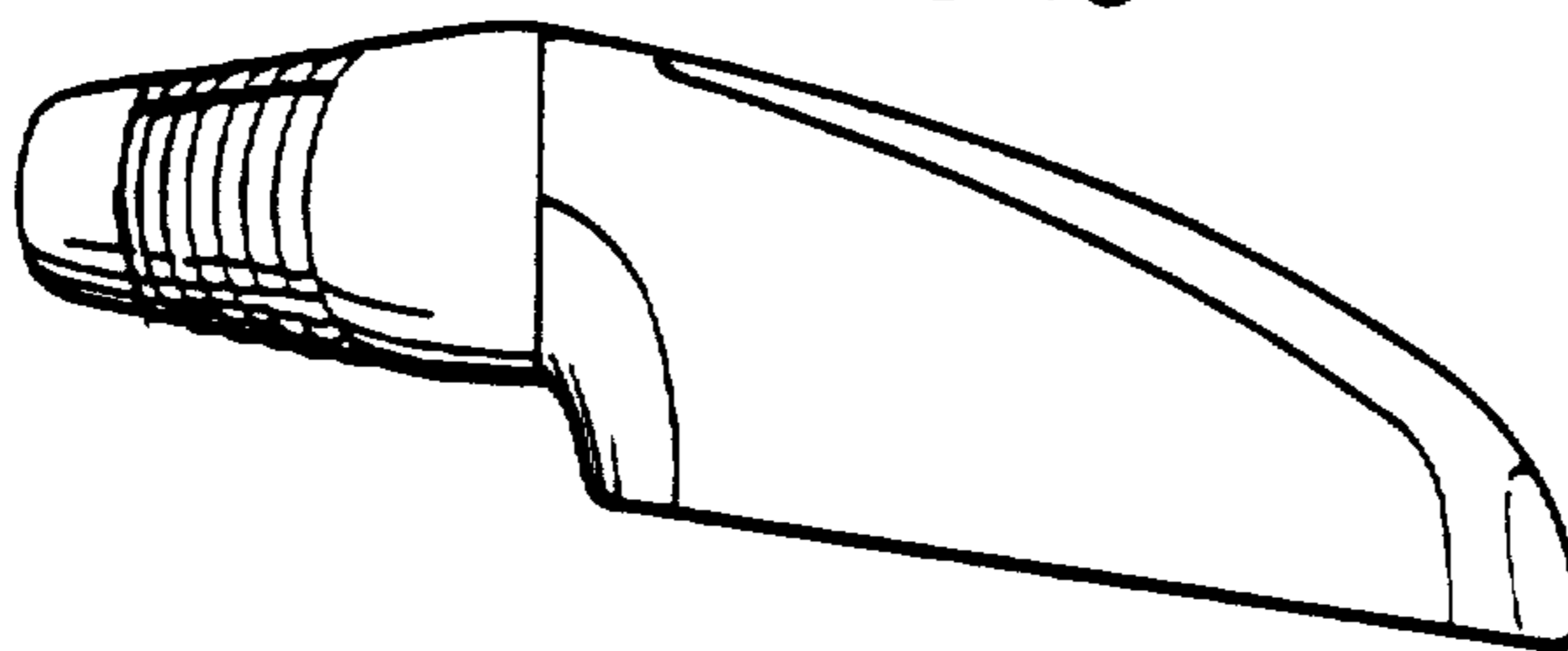

FIG. 11

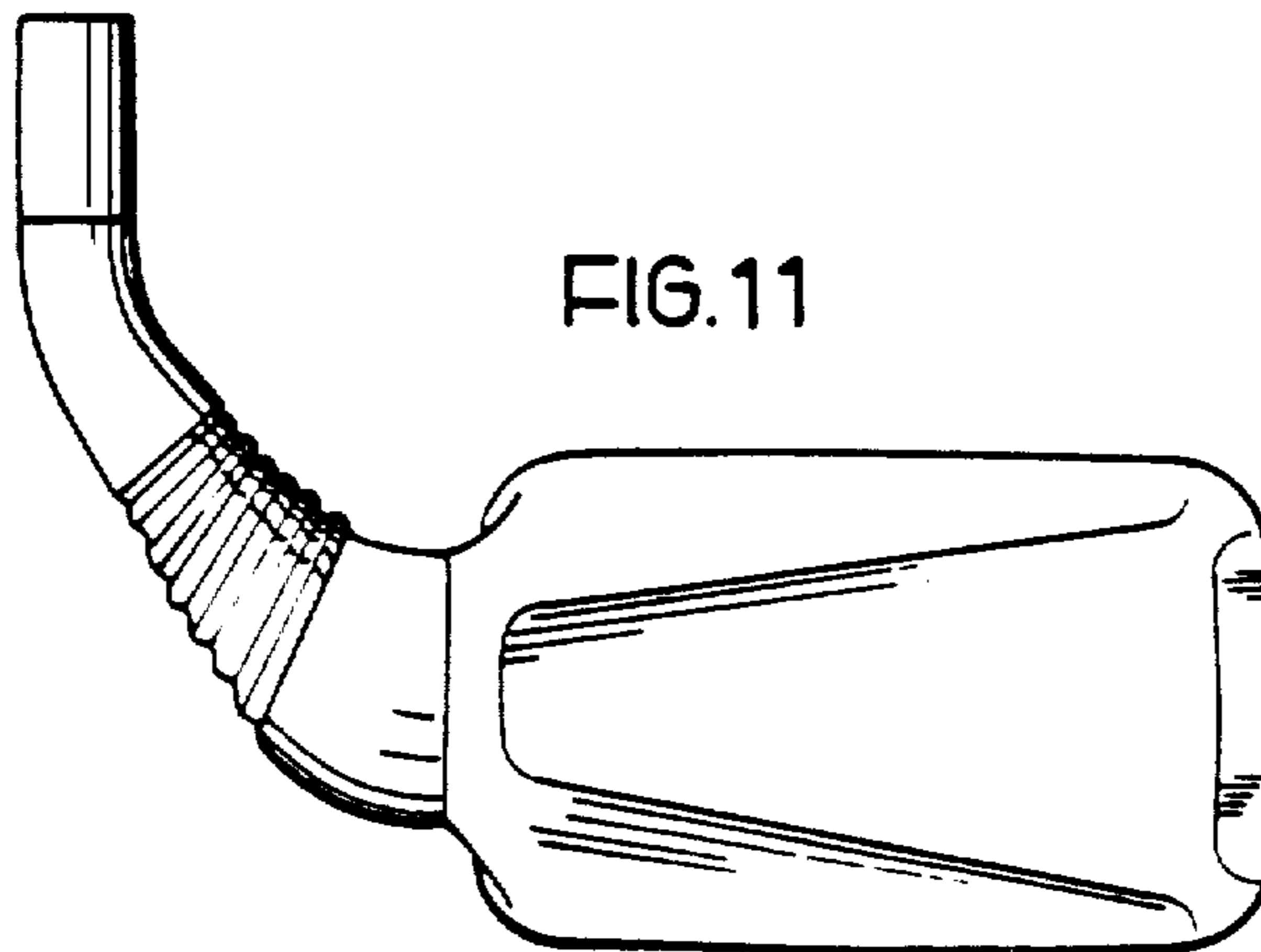

FIG. 12

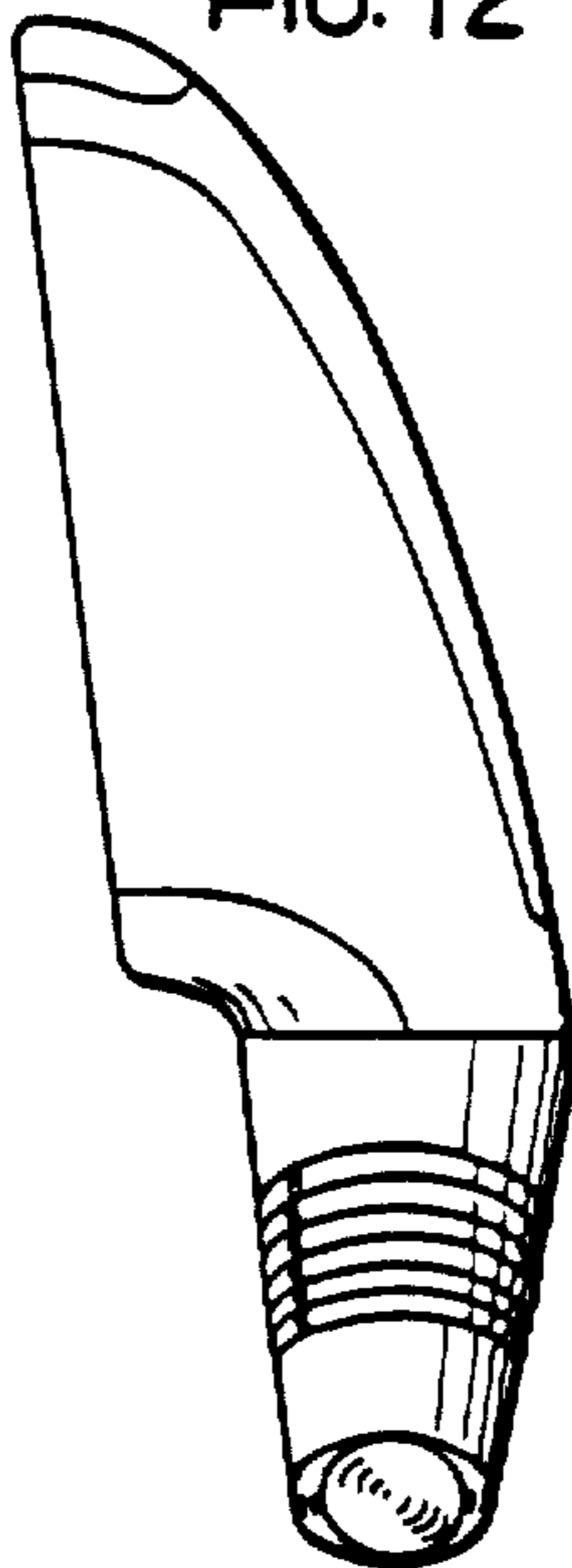

FIG. 14

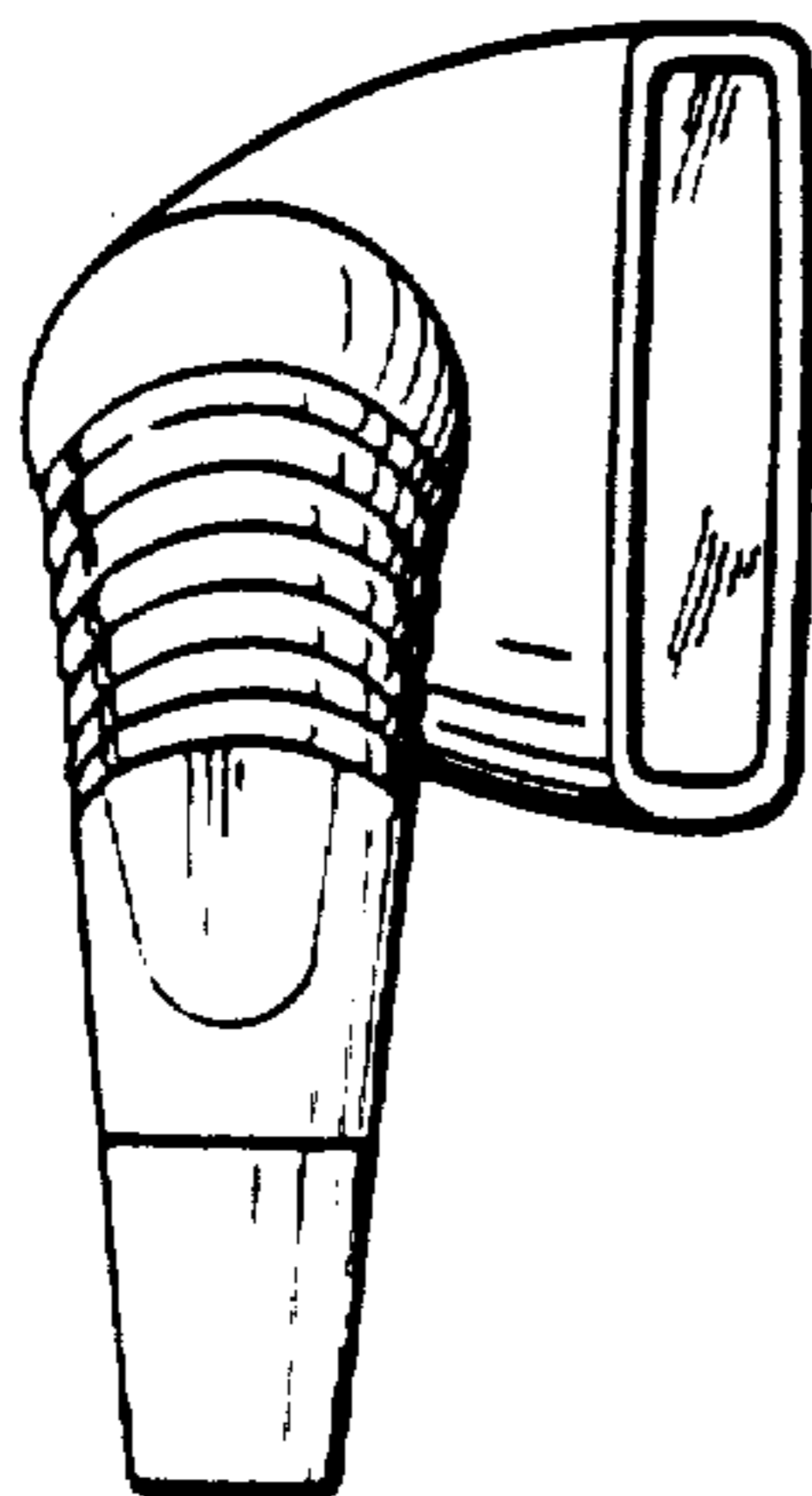

FIG. 13

