



US00D999596S

(12) **United States Design Patent**
DeFrancia

(10) **Patent No.:** **US D999,596 S**

(45) **Date of Patent:** **** Sep. 26, 2023**

- (54) **CONTAINER**
- (71) Applicant: **Ice Rover, Inc.**, Boulder, CO (US)
- (72) Inventor: **Tomas A. DeFrancia**, Boulder, CO (US)
- (73) Assignee: **Ice Rover, Inc.**, Boulder, CO (US)
- (**) Term: **15 Years**
- (21) Appl. No.: **29/721,432**
- (22) Filed: **Jan. 21, 2020**

4,873,841	A	10/1989	Bradshaw et al.
4,932,677	A	6/1990	Shustack
4,976,448	A	12/1990	Wickersham et al.
4,987,639	A	1/1991	Baiuley et al.
5,044,513	A	9/1991	Van Berne
5,193,706	A	3/1993	Hanna et al.
5,228,706	A	7/1993	Boville
5,249,438	A	10/1993	Rhaney et al.
D340,620	S	10/1993	Peters
5,269,157	A	12/1993	Ciminelli et al.

(Continued)

Related U.S. Application Data

- (63) Continuation of application No. 29/641,695, filed on Mar. 23, 2018, now Pat. No. Des. 873,085, which is a continuation of application No. 29/571,422, filed on Jul. 18, 2016, now Pat. No. Des. 815,919.

(51) **LOC (14) Cl.** **07-01**

(52) **U.S. Cl.**
USPC **D7/387**; D3/318; D7/605

(58) **Field of Classification Search**
USPC .. D3/273, 276, 278, 281, 283, 289, 293, 294, D3/303, 321, 323, 905, 271.4, 271.3, 318; D7/605, 387
CPC B25H 3/02; A45C 3/004; A45C 13/002
See application file for complete search history.

(56) **References Cited**

U.S. PATENT DOCUMENTS

1,469,196	A	9/1923	Strange
3,591,194	A	7/1971	Vega
3,666,134	A	5/1972	Rauch
4,035,009	A	7/1977	Jacobs
4,724,681	A	2/1988	Bartholomew et al.
4,759,560	A	7/1988	Virgulti
4,846,493	A	7/1989	Mason

OTHER PUBLICATIONS

Amazon, "Tactix 320314 Mobile Tool Chest, 29", Black/Orange", First on sale Dec. 18, 2013. (<https://www.amazon.com/dp/B0094D41VI>) (Year: 2013).*

(Continued)

Primary Examiner — April Rivas
(74) *Attorney, Agent, or Firm* — Lieberman & Brandsdorfer, LLC

(57) **CLAIM**

The ornamental design for a Container as shown and described.

DESCRIPTION

FIG. 1 is a front perspective view of a container showing my new design;
FIG. 2 is a front view thereof;
FIG. 3 is a rear view thereof;
FIG. 4 is a left side view thereof;
FIG. 5 is a right side view thereof;
FIG. 6 is a top plan view thereof; and
FIG. 7 is a bottom plan view thereof.
The broken lines are included for the purpose of illustrating portions of the container that form no part of the claimed design.

1 Claim, 7 Drawing Sheets

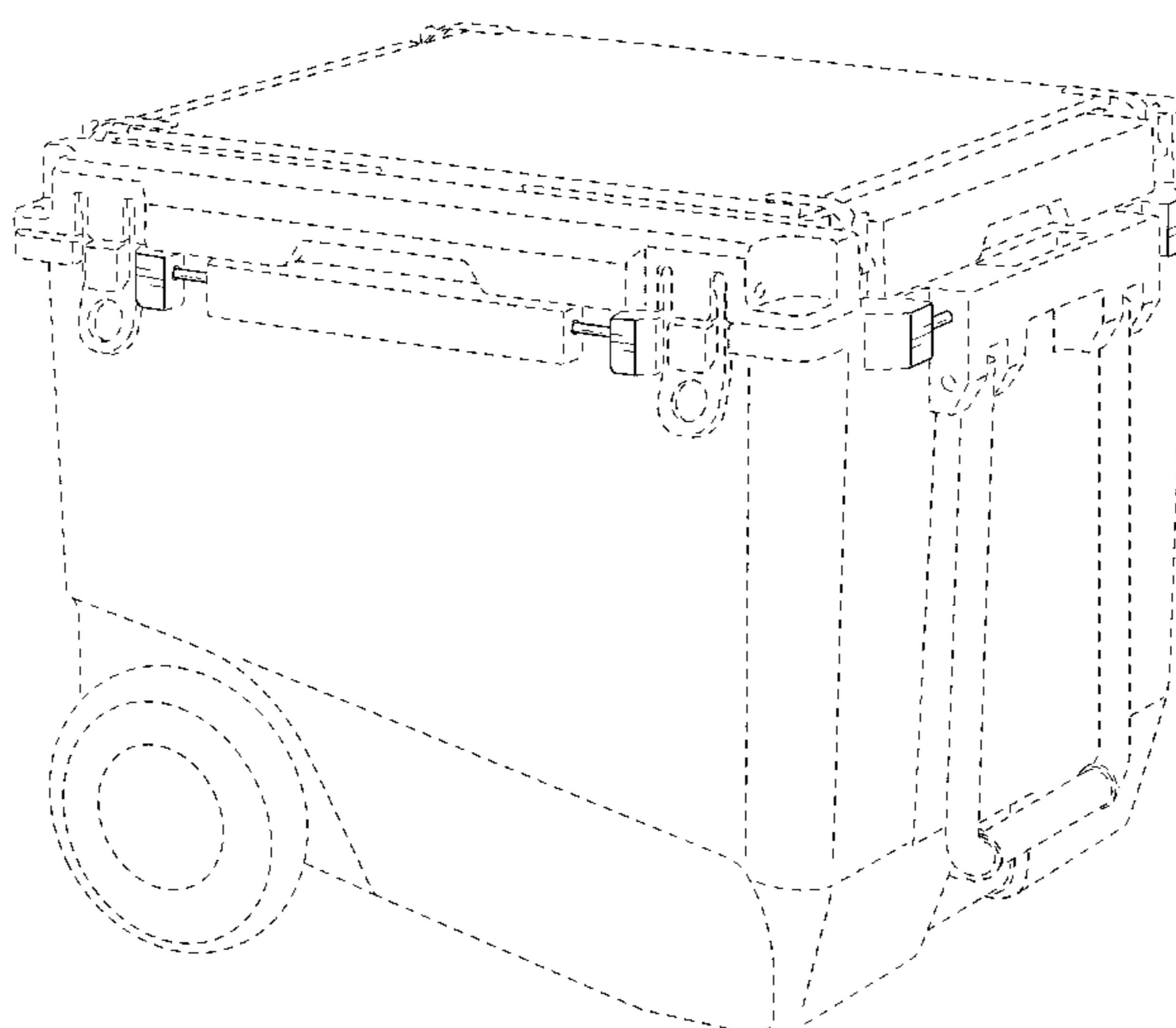

(56)

References Cited

U.S. PATENT DOCUMENTS

5,285,656 A 2/1994 Peters
 5,285,936 A 2/1994 Matricardi
 5,306,029 A 4/1994 Kaiser, II
 5,313,817 A 5/1994 Meinders
 D353,304 S 12/1994 Friedrich
 5,423,195 A 6/1995 Peters
 5,465,985 A 11/1995 Devan et al.
 5,479,866 A 1/1996 Rae
 5,484,046 A 1/1996 Alper et al.
 5,490,606 A 2/1996 Lombardo
 5,595,429 A 1/1997 Kennedy
 5,803,472 A 9/1998 Lien
 5,953,931 A 9/1999 Brittain
 D415,658 S 10/1999 Frehse
 5,988,658 A 11/1999 Ritchie et al.
 D429,606 S 8/2000 Israel et al.
 6,153,857 A 11/2000 Gunnels
 6,305,185 B1 10/2001 Sloan
 6,311,991 B1 11/2001 Conrado et al.
 6,318,713 B1 11/2001 Levi
 6,318,740 B1 11/2001 Nappo
 6,347,419 B1 2/2002 Kurtz
 6,364,329 B1 4/2002 Holub et al.
 6,394,325 B1 5/2002 Taylor
 6,446,988 B1 9/2002 Kho
 6,474,097 B2 11/2002 Treppedi et al.
 6,497,424 B2 12/2002 Gartner et al.
 6,558,301 B1 5/2003 Jackson
 6,634,659 B2 10/2003 Sanskrit
 D480,276 S 10/2003 Duarte et al.
 D493,456 S 7/2004 Ogasawara
 6,895,778 B1 5/2005 Ackerman
 6,908,417 B2 6/2005 Jackson
 D514,891 S 2/2006 Garcia et al.
 7,140,507 B2 11/2006 Maldonado et al.
 7,155,859 B1 1/2007 Brooks
 7,175,040 B2 2/2007 Lorenz et al.
 7,252,295 B2 8/2007 Bludworth
 7,284,763 B1 10/2007 King
 7,306,243 B2 12/2007 Van Horn et al.
 7,334,802 B2 2/2008 Kaplan
 7,360,380 B2 4/2008 Van Handel
 7,588,156 B2 9/2009 Lorenz et al.
 7,601,101 B2 10/2009 Jackson et al.
 D609,911 S 2/2010 Twig
 D613,560 S 4/2010 Robichaud et al.
 7,714,708 B2 5/2010 Brackmann et al.
 7,717,440 B1 5/2010 Baba
 7,854,321 B2 12/2010 Twig et al.
 7,891,678 B2 2/2011 Anderson et al.
 7,909,148 B1 3/2011 Miller et al.
 D649,783 S 12/2011 Brunner
 8,256,242 B1 9/2012 Evans
 9,132,598 B2 9/2015 Ernst
 9,199,657 B2 12/2015 Martin
 9,199,782 B1 12/2015 Cliatt
 9,310,118 B2 4/2016 Zavitsanos
 D753,394 S * 4/2016 Brunner D3/276
 D767,277 S * 9/2016 Faibish D3/905
 D770,179 S 11/2016 Menirom
 D771,381 S * 11/2016 Sosnovsky et al. D3/905
 9,550,605 B1 1/2017 Summers
 D781,772 S * 3/2017 Sanz et al. D12/345
 9,700,110 B2 7/2017 Lee et al.

9,835,367 B2 12/2017 Vanderberg et al.
 D806,483 S 1/2018 Stanford et al.
 D807,123 S 1/2018 Carey et al.
 D811,171 S 2/2018 Golic et al.
 D815,919 S * 4/2018 DeFrancia D3/905
 D815,921 S 4/2018 Moffett, III et al.
 D816,423 S 5/2018 DeFrancia
 10,022,856 B2 7/2018 Bensman et al.
 D836,402 S 12/2018 Jacobsen
 D836,995 S 1/2019 Carey et al.
 D840,150 S 2/2019 Seiders et al.
 10,272,934 B2 4/2019 DeFrancia
 D845,082 S 4/2019 Jacobsen
 D850,217 S 6/2019 Kittel, III
 D873,085 S * 1/2020 DeFrancia D3/294
 D873,086 S 1/2020 DeFrancia
 D896,517 S * 9/2020 Brunner et al. D3/294
 D946,894 S * 3/2022 Seiders et al. D3/312
 2002/0096844 A1 7/2002 Clegg
 2003/0168371 A1 9/2003 Weimer
 2004/0002411 A1 1/2004 Jackson
 2004/0238400 A1 12/2004 Knutsson et al.
 2005/0232747 A1 10/2005 Brackmann et al.
 2006/0052220 A1 3/2006 Jackson et al.
 2006/0060580 A1 3/2006 Lorenz et al.
 2006/0162403 A1 7/2006 Handel
 2007/0001409 A1 1/2007 Kaplan
 2008/0156671 A1 7/2008 Jansson
 2008/0179847 A1 7/2008 DeFrancia
 2008/0245095 A1 10/2008 Schlipman et al.
 2009/0127807 A1 5/2009 Cornwell
 2010/0000890 A1 1/2010 Belden
 2010/0000893 A1 1/2010 Twig et al.
 2010/0275641 A1 11/2010 Manner et al.
 2011/0197625 A1 8/2011 Urban et al.
 2011/0226003 A1 9/2011 Chaney et al.
 2012/0013091 A1 1/2012 Giese
 2012/0104013 A1 5/2012 Cowie
 2012/0292121 A1 11/2012 Murray
 2012/0292213 A1 11/2012 Brunner
 2013/0056478 A1 3/2013 Canales, Jr.
 2014/0197059 A1 7/2014 Evans et al.
 2015/0203141 A1 7/2015 Martin
 2015/0369529 A1 12/2015 Monroe
 2015/0375917 A1 12/2015 Lee et al.
 2016/0082891 A9 3/2016 Parks
 2016/0166070 A1 6/2016 Golic et al.
 2017/0113856 A1 4/2017 Hollis et al.
 2017/0129097 A1 5/2017 Engvall et al.
 2017/0370629 A1 12/2017 Fire
 2018/0015938 A1 1/2018 DeFrancia
 2018/0127007 A1 5/2018 Kravchenko
 2018/0141718 A1 5/2018 Ahlström et al.
 2018/0141739 A1 5/2018 Hengen
 2018/0274837 A1 9/2018 Christensen
 2018/0312294 A1 11/2018 Wang et al.

OTHER PUBLICATIONS

Igloo, All Terrain Cooler, 100 quart, Jun. 2015.
 Pelican, Progear 45-Quart Elite Wheeled Cooler, Oct. 2015.
 Amazon, "RovR 80 Quart Wheeled Camping Cooler", First reviewed on Jan. 9, 2017. (<https://www.amazon.com/RovR-Quart-Wheeled-Camping-Cooler/dp/B01M0SKHGH>).

* cited by examiner

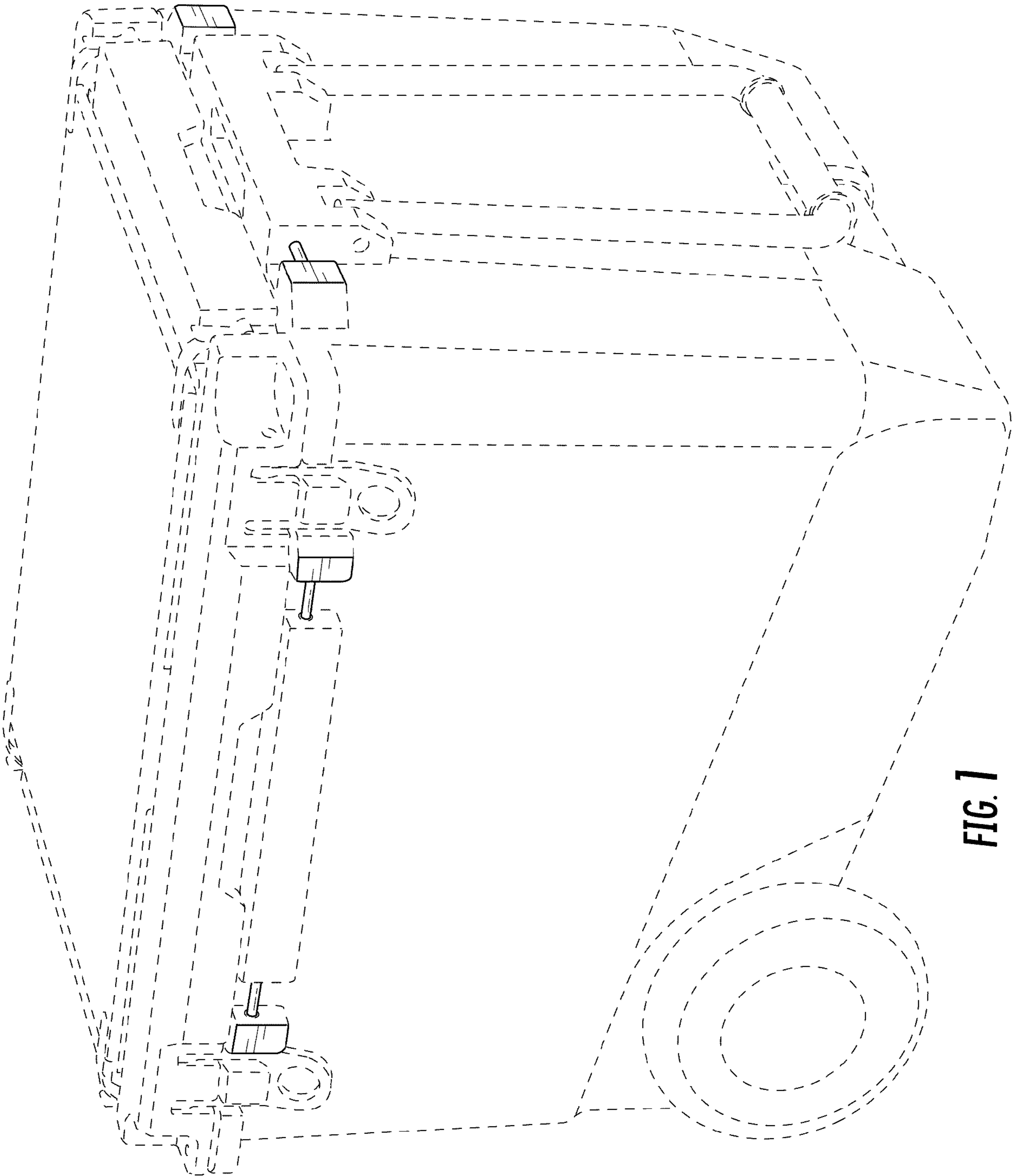

FIG. 1

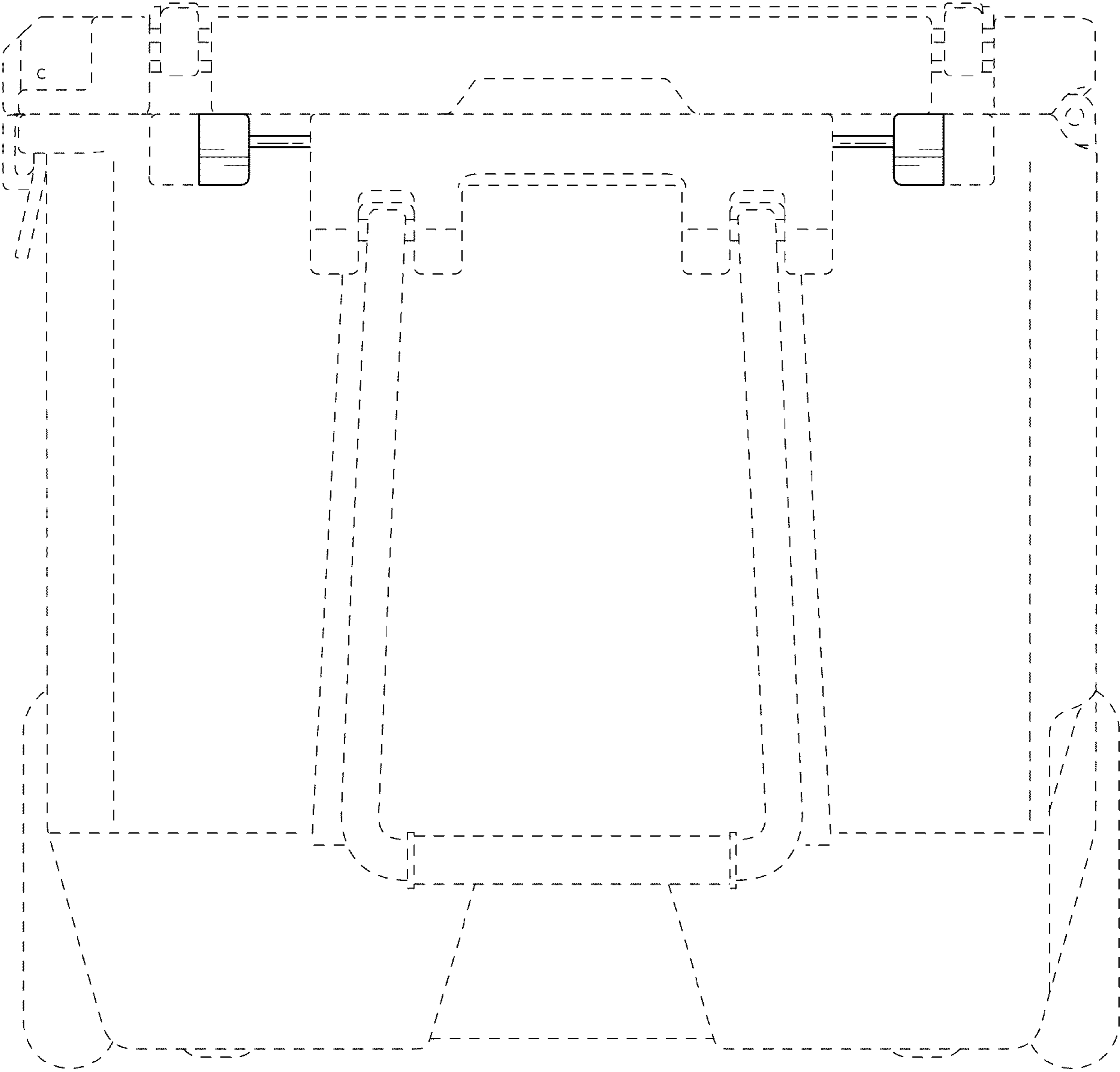

FIG. 2

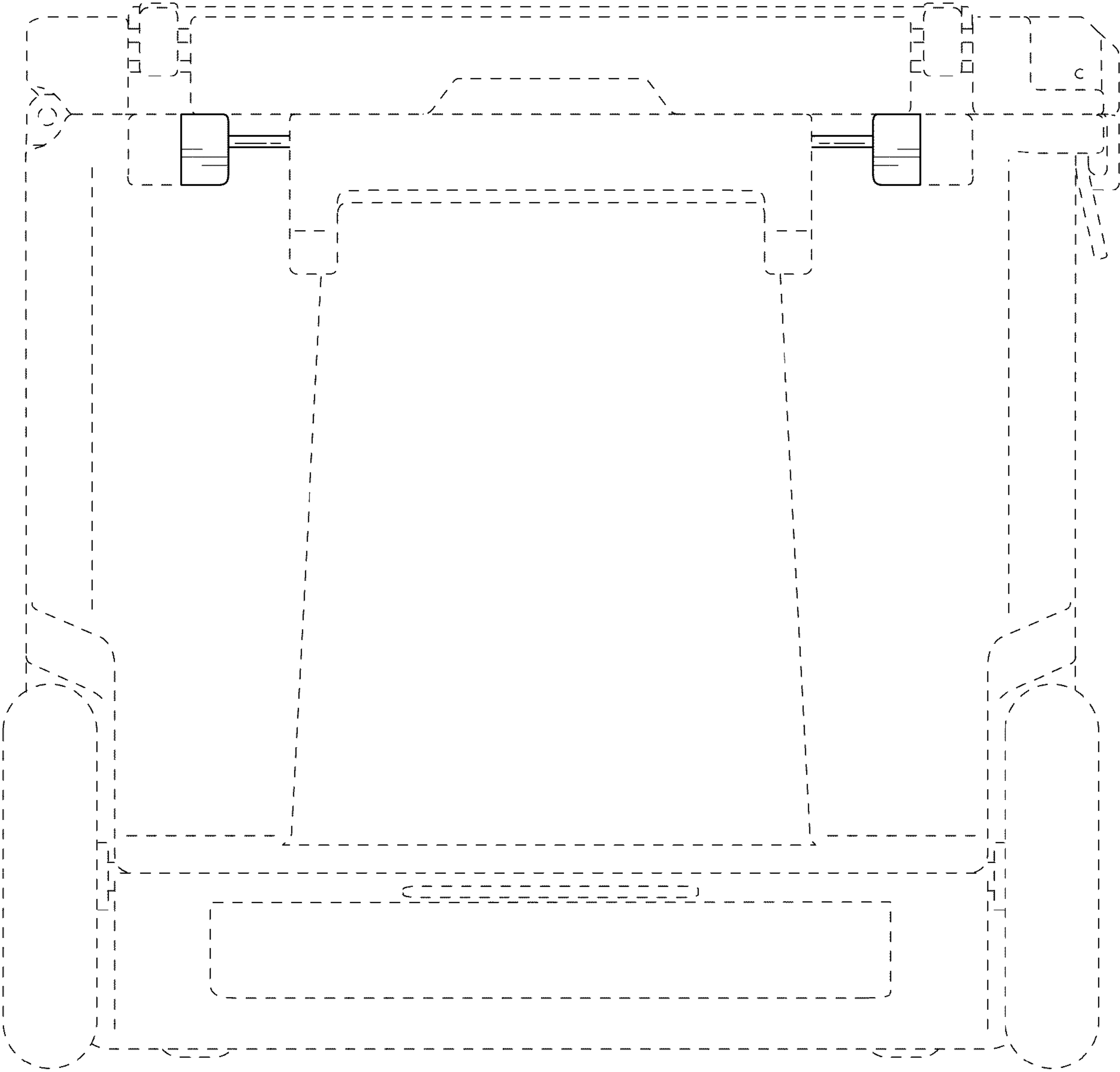

FIG. 3

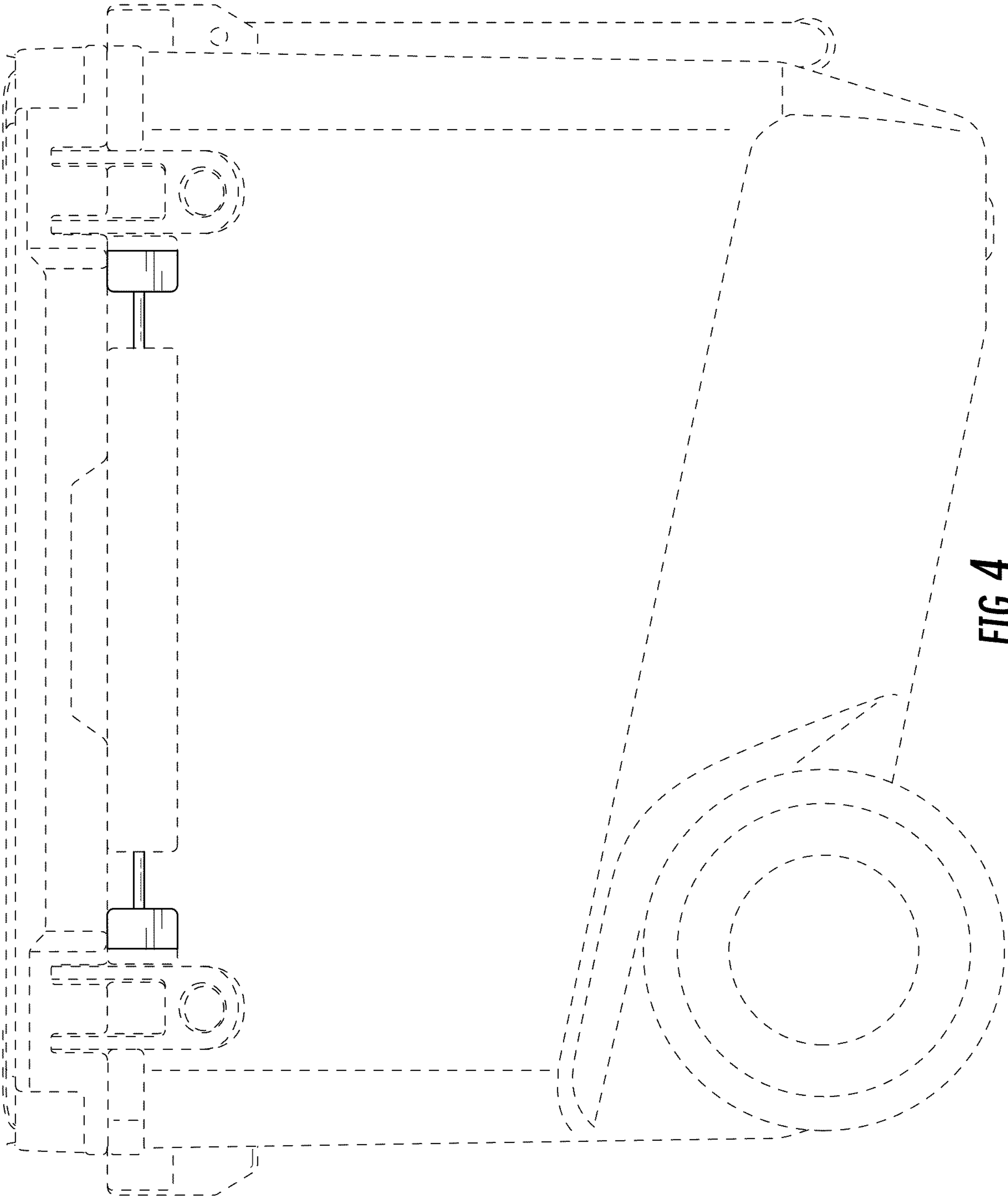

FIG. 4

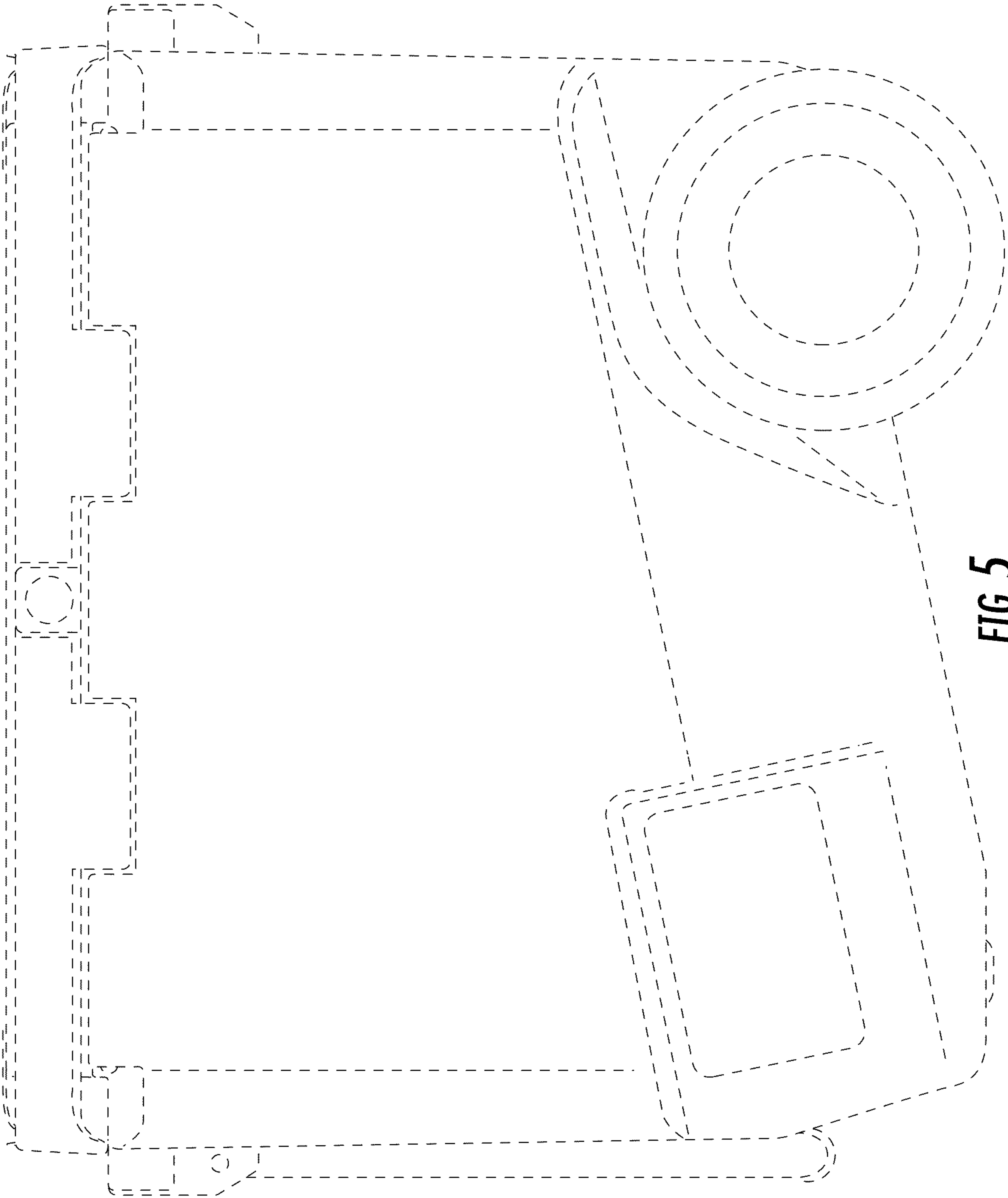

FIG. 5

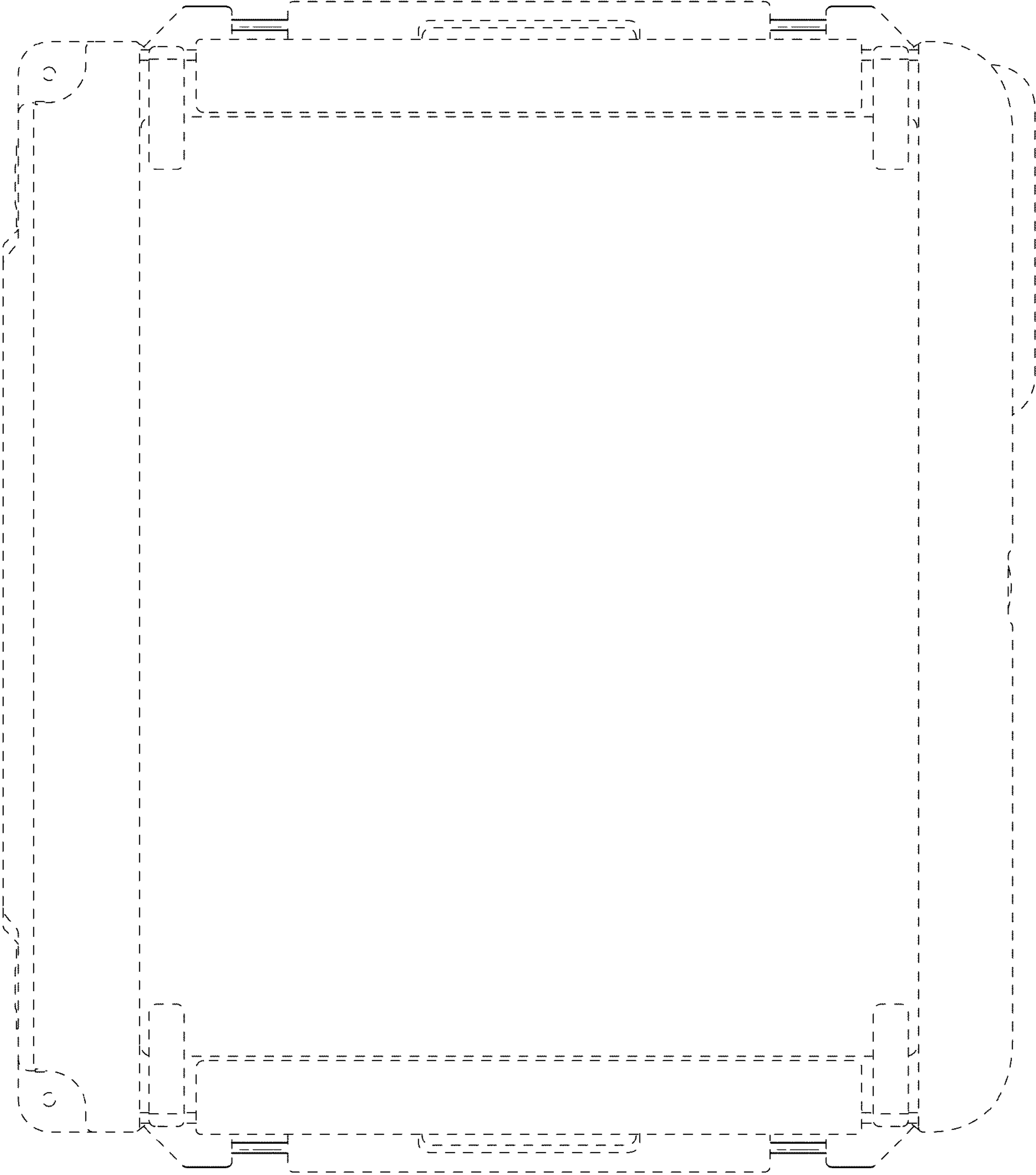

FIG. 6

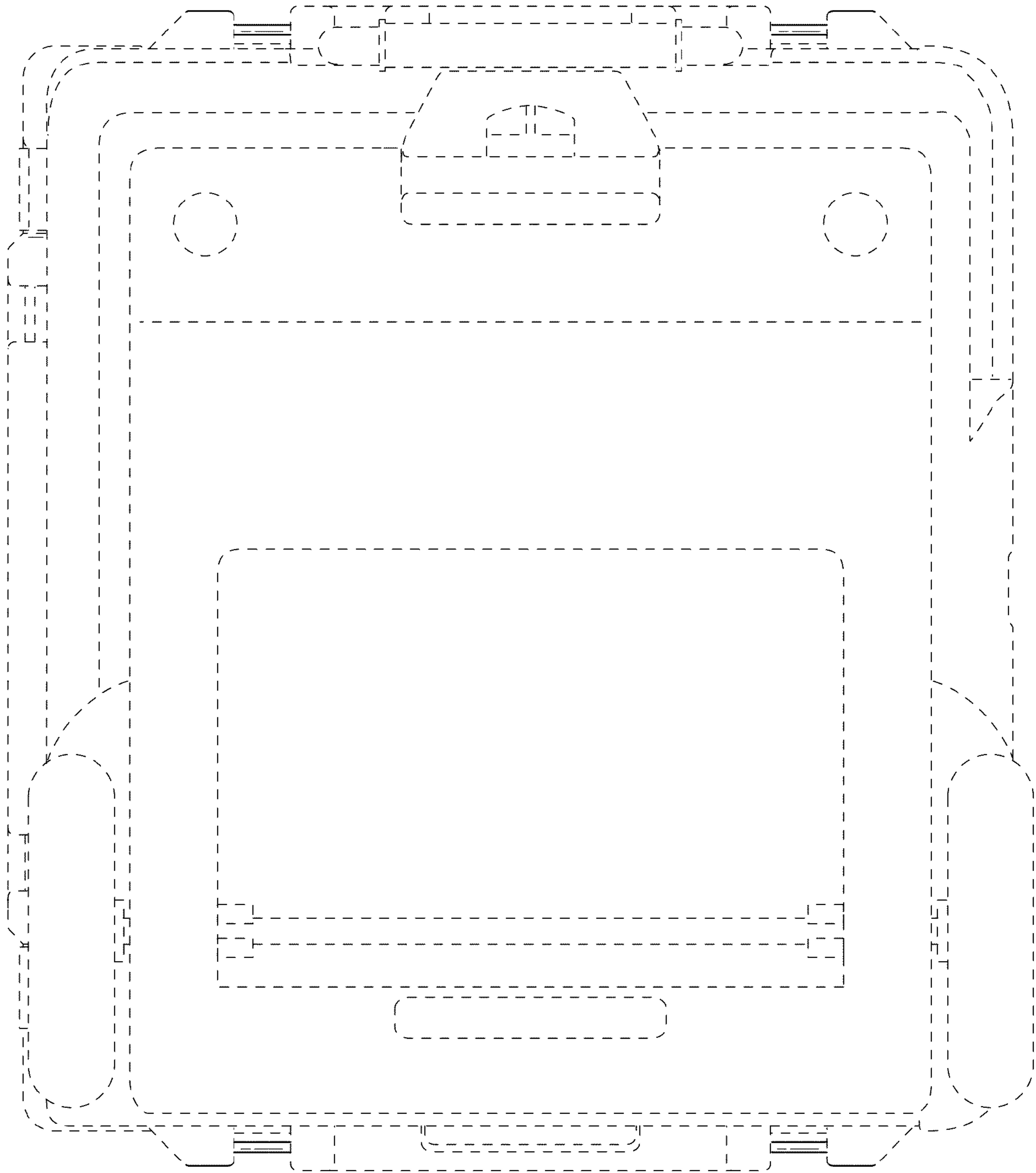

FIG. 7