



US00D998384S

(12) **United States Design Patent** (10) **Patent No.:** **US D998,384 S**
Polupanova (45) **Date of Patent:** **** Sep. 12, 2023**

(54) **MULTI LAYER PILLOW**

FOREIGN PATENT DOCUMENTS

(71) Applicant: **Anna Grigoryevna Polupanova**,
Barcelona (ES)

CA 2324818 5/2002
CA 2897584 1/2017

(Continued)

(72) Inventor: **Anna Grigoryevna Polupanova**,
Barcelona (ES)

OTHER PUBLICATIONS

(**) Term: **15 Years**

Google search: "multi layer pillow" [site visited Sep. 27, 2021]:
https://www.google.com/search?q=foam+cushion&sxsrf=AJOqlzURyOUg2T_IYQYUP2n2yyYGvwUy_Q:1677273163378&source=lnms&tbm=isch&sa=X&ved=2ahUKEwiNpeC4ia_9AhWhF1kFHVrsCCEQ_AUoAnoECAIQBA&biw=1920&bih=937&dpr=1 (Year: 2023).*

(Continued)

(21) Appl. No.: **35/513,635**

(22) Filed: **Apr. 8, 2021**

Primary Examiner — Sanjeev Paul

(80) **Hague Agreement Data**

Int. Filing Date: **Apr. 8, 2021**

Int. Reg. No.: **DM/218799**

Int. Reg. Date: **Apr. 8, 2021**

Int. Reg. Pub. Date: **Feb. 11, 2022**

(57) **CLAIM**

(51) **LOC (14) Cl.** **06-09**

The ornamental design for a multi layer pillow, as shown and described.

(52) **U.S. Cl.**

USPC **D6/601**

DESCRIPTION

(58) **Field of Classification Search**

USPC D6/595, 596, 597, 601, 604, 716, 716.1,
D6/374, 334

CPC A47C 19/00; A47C 23/00; A47C 21/026;
A47C 27/00; A47C 27/06; A47C 27/08;
A47C 27/081; A47C 27/082; A47G 9/10;
A47G 9/1009; A47G 9/1027; A47G
9/1045; A47G 9/1063; A47G 9/1072;
A47G 9/1081

See application file for complete search history.

The patent or application file contains at least one drawing executed in color. Copies of this patent or patent application publication with color drawing(s) will be provided by the Office upon request and payment of the necessary fee.

1. Multi layer pillow

3. Multi layer pillow

1.1 : Bottom Layer

1.2 : Front

1.3 : Layer 1

1.4 : Layer 2

1.5 : Perspective

3.1 : Perspective

3.2 : Front

3.3 : Intermediate Layer

3.4 : Bottom Layer

A multi layer pillow comprised of four layers: a top layer, two intermediate layers and a bottom layer.

(56) **References Cited**

U.S. PATENT DOCUMENTS

D246,816 S * 1/1978 Tam D6/596
6,018,831 A 2/2000 Loomos
6,345,401 B1 * 2/2002 Frydman A47G 9/109
5/636
D475,880 S * 6/2003 Albright D6/601
7,469,437 B2 12/2008 Mikkelsen et al.
7,624,465 B2 12/2009 Oh

(Continued)

1 Claim, 9 Drawing Sheets
(5 of 9 Drawing Sheet(s) Filed in Color)

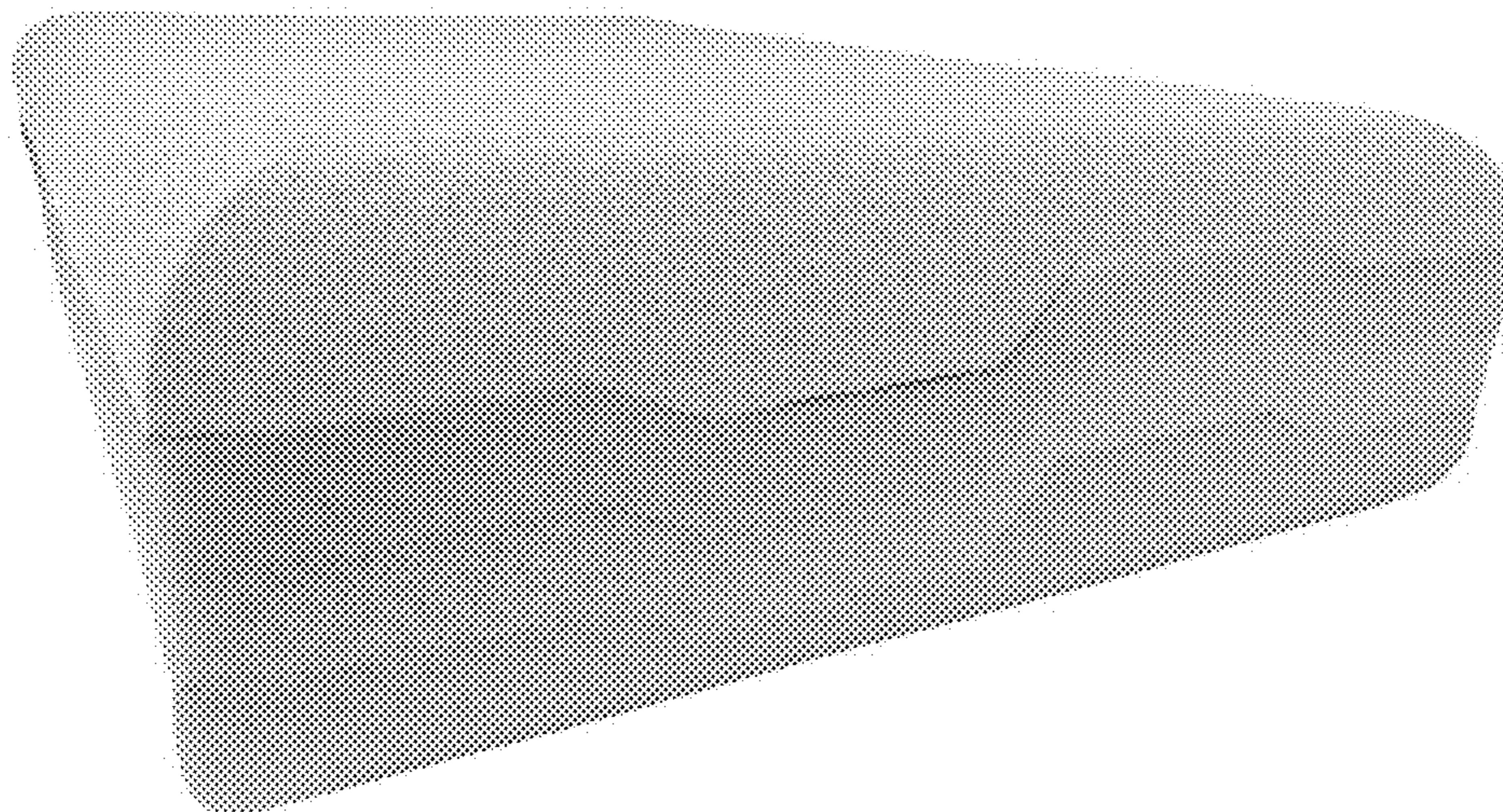

(56)

References Cited

U.S. PATENT DOCUMENTS

8,065,766	B1	11/2011	Fierro	
8,418,297	B2	4/2013	Mikkelsen et al.	
8,973,190	B2	3/2015	Oh et al.	
9,357,851	B2	6/2016	Oh	
9,775,444	B2	10/2017	Oh	
10,383,454	B2	8/2019	Romero et al.	
D887,175	S	6/2020	Loos	
D909,792	S *	2/2021	Pound	D6/601
D934,595	S *	11/2021	King	D6/604
D942,178	S *	2/2022	Chen	D6/596
D944,032	S *	2/2022	Yang	D6/601
D948,243	S *	4/2022	Choi	D6/596
D948,244	S *	4/2022	Choi	D6/596
D968,851	S *	11/2022	Deng	D6/604
2010/0048746	A1	2/2010	Oh	
2011/0094033	A1	4/2011	Lee	
2011/0162146	A1	7/2011	Frydman	
2012/0079659	A1	4/2012	Loos	
2013/0263377	A1	10/2013	Wootten, Jr.	
2013/0263386	A1	10/2013	Romero et al.	
2014/0283305	A1	9/2014	Zysman	
2014/0304921	A1	10/2014	Chandler et al.	

FOREIGN PATENT DOCUMENTS

CN	306852074	*	9/2021
DE	29923217	U1	9/2000
DE	202016003299		8/2016
EP	3395208		10/2018
RU	00128322	*	11/2021
RU	00132317	*	7/2022
WO	WO10019237		2/2010
WO	D218799-001	*	4/2021

OTHER PUBLICATIONS

Google search: "multi layer pillow" [site visited Sep. 27, 2021]:
https://www.google.com/search?q=multi+layer+pillow&sxsrf=AJOqlzUXR7pOTVUDBwxuqNjfTccwRymGHw:1677273038996&source=lnms&tbm=isch&sa=X&ved=2ahUKewifzrj9iK_9AhVILVkfHFaSIASoQ_AUoAnoECAMQBA&biw=1920&bih=937&dpr=1 (Year: 2023).*

* cited by examiner

1.1

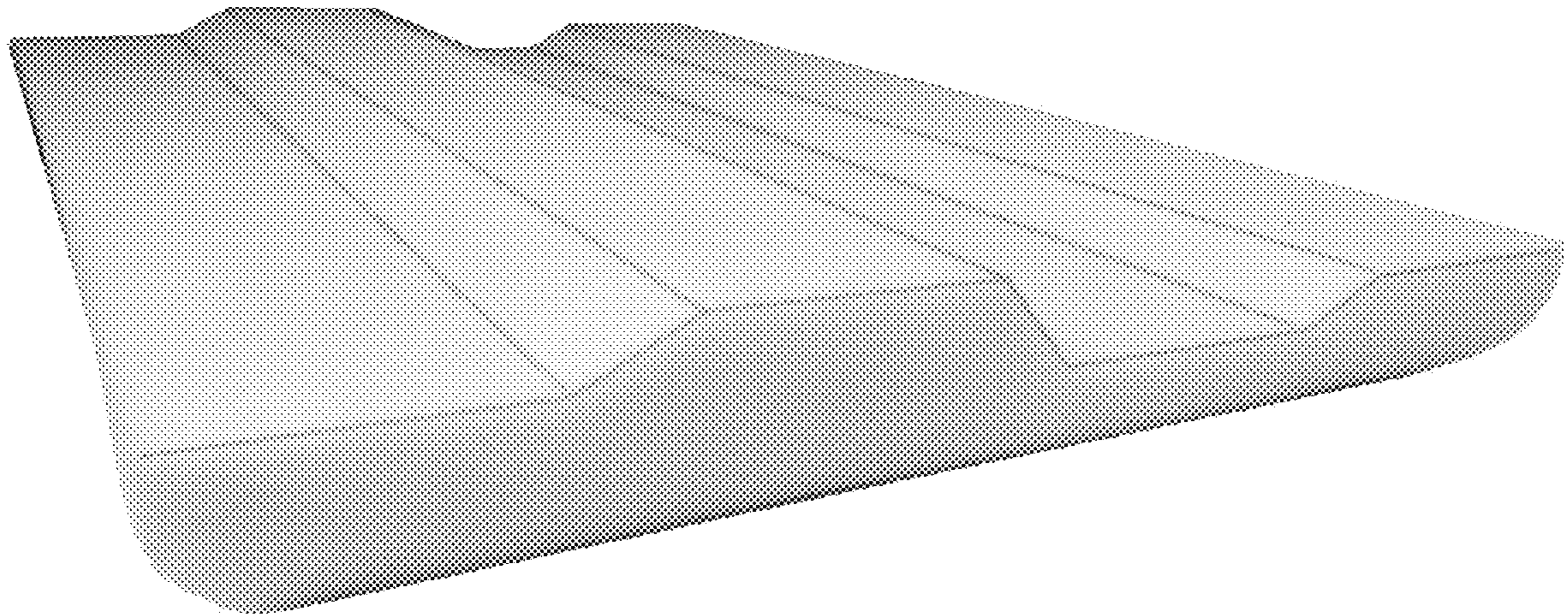

1.2

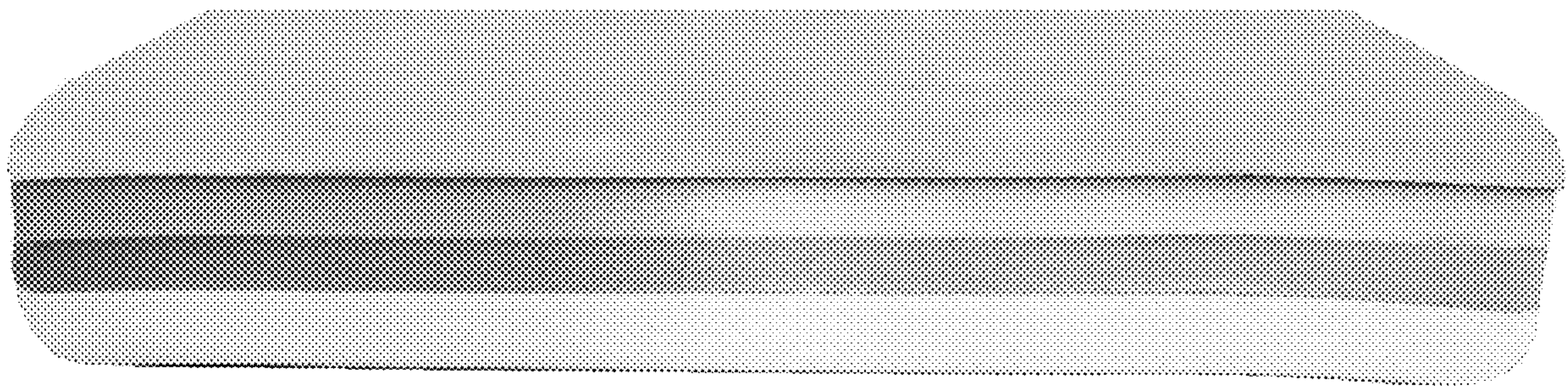

1.3

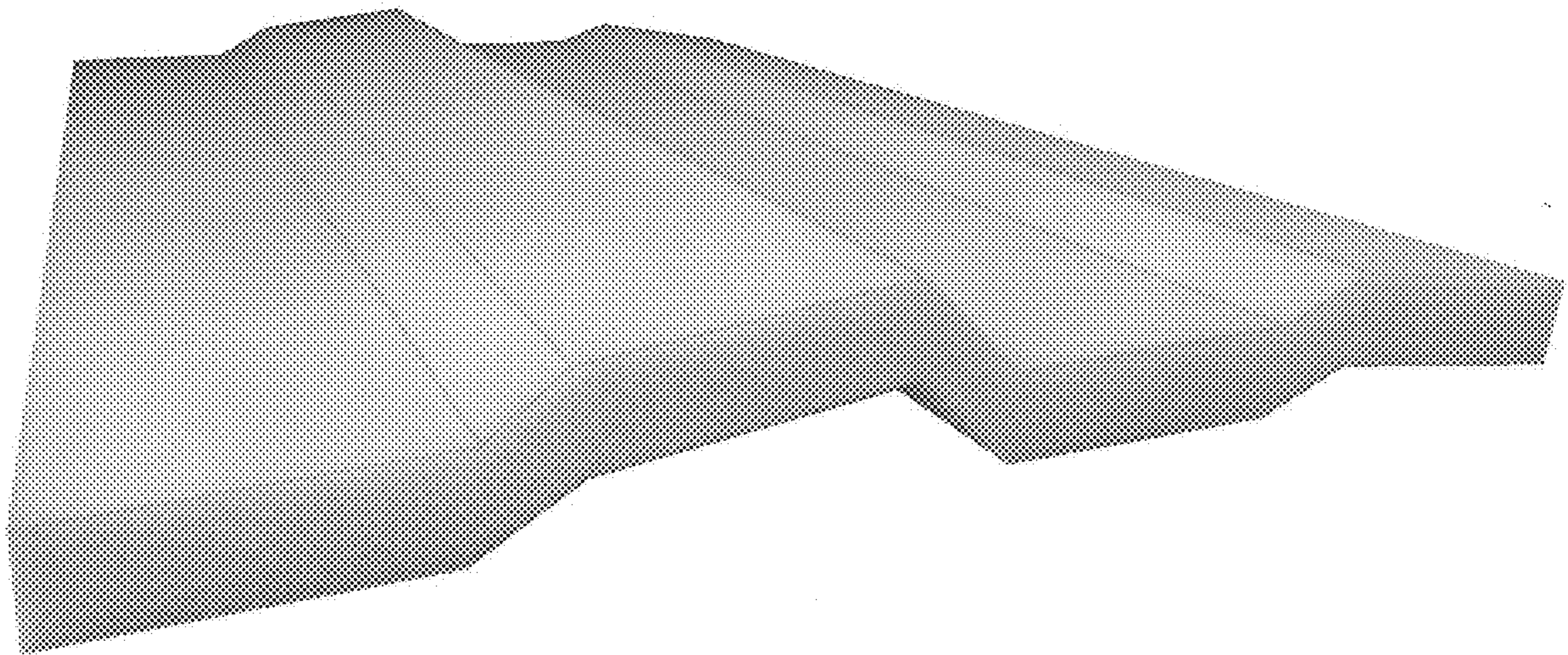

1.4

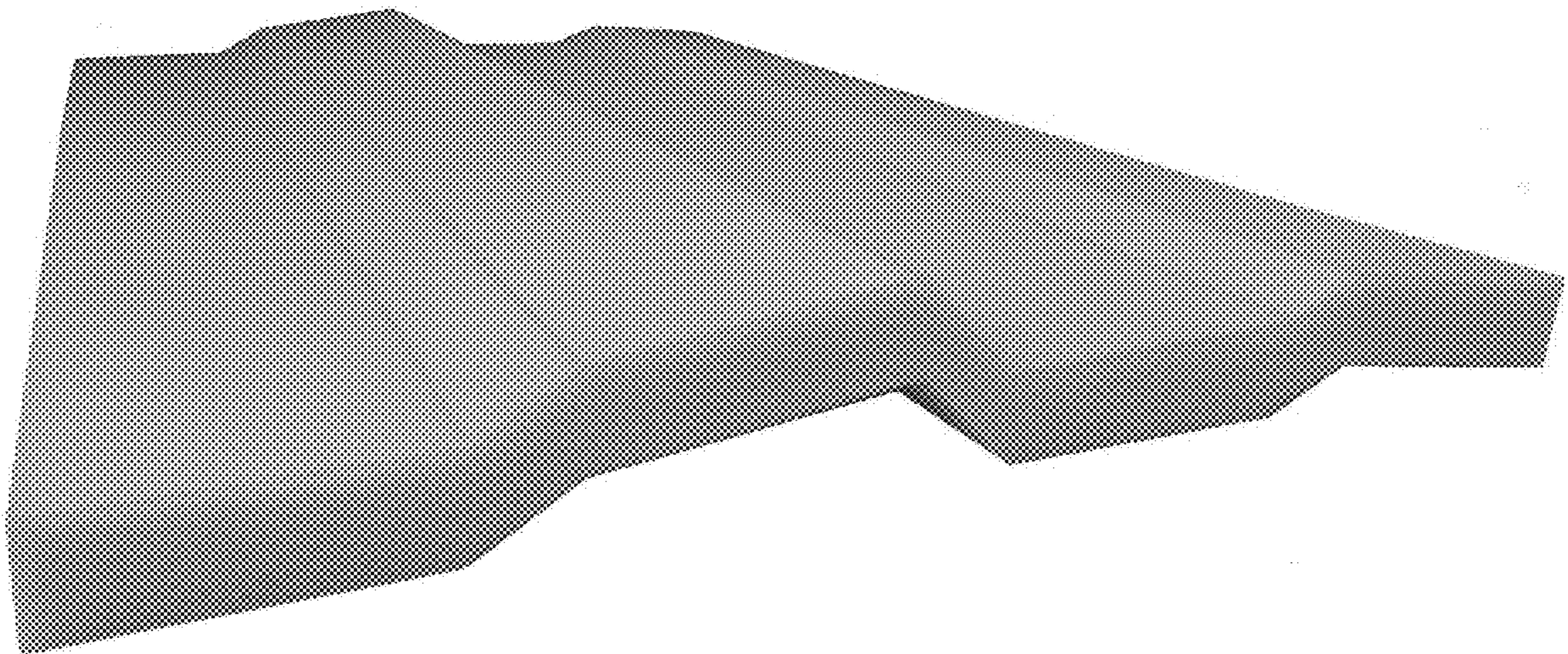

1.5

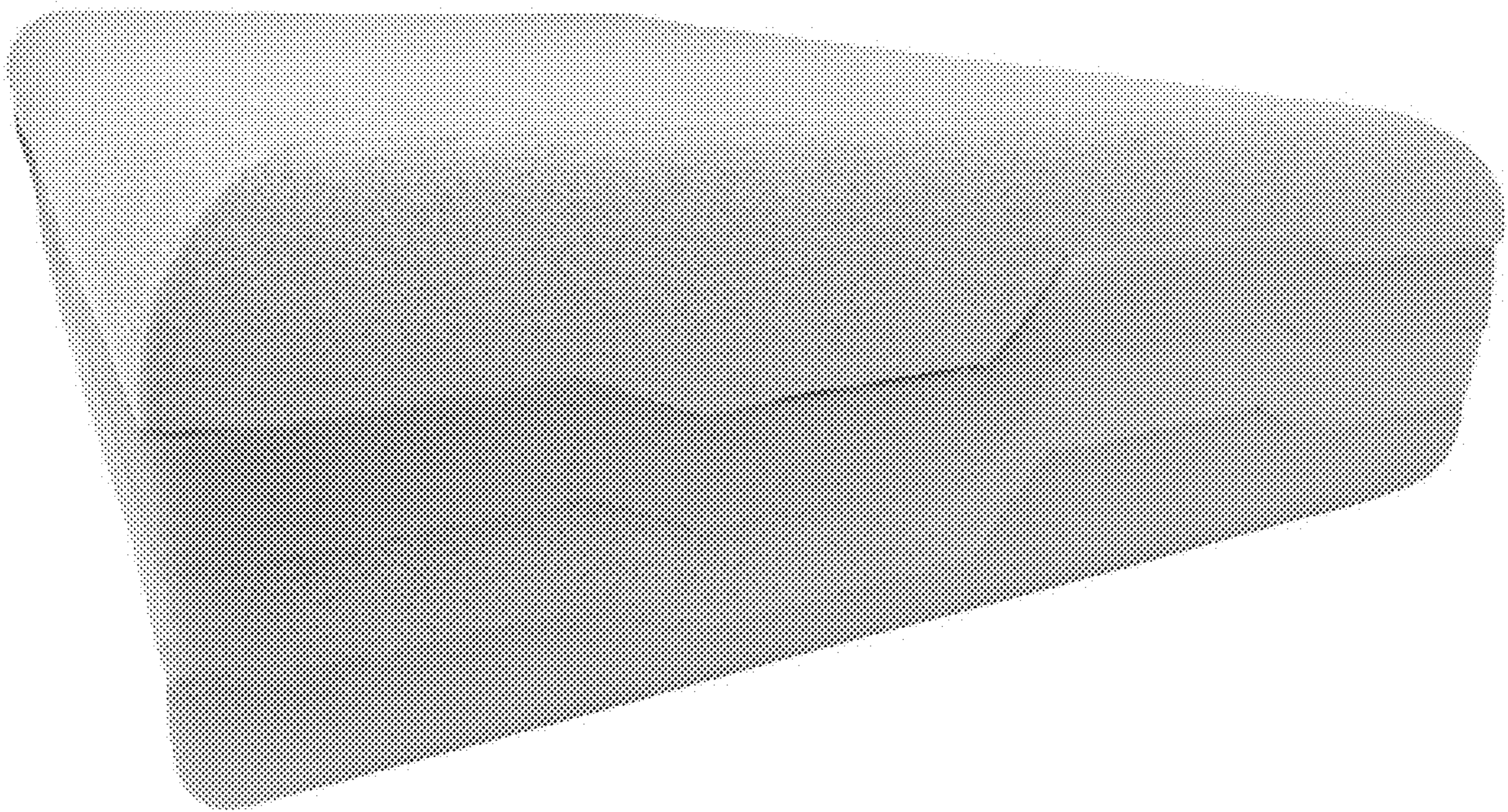

3.1

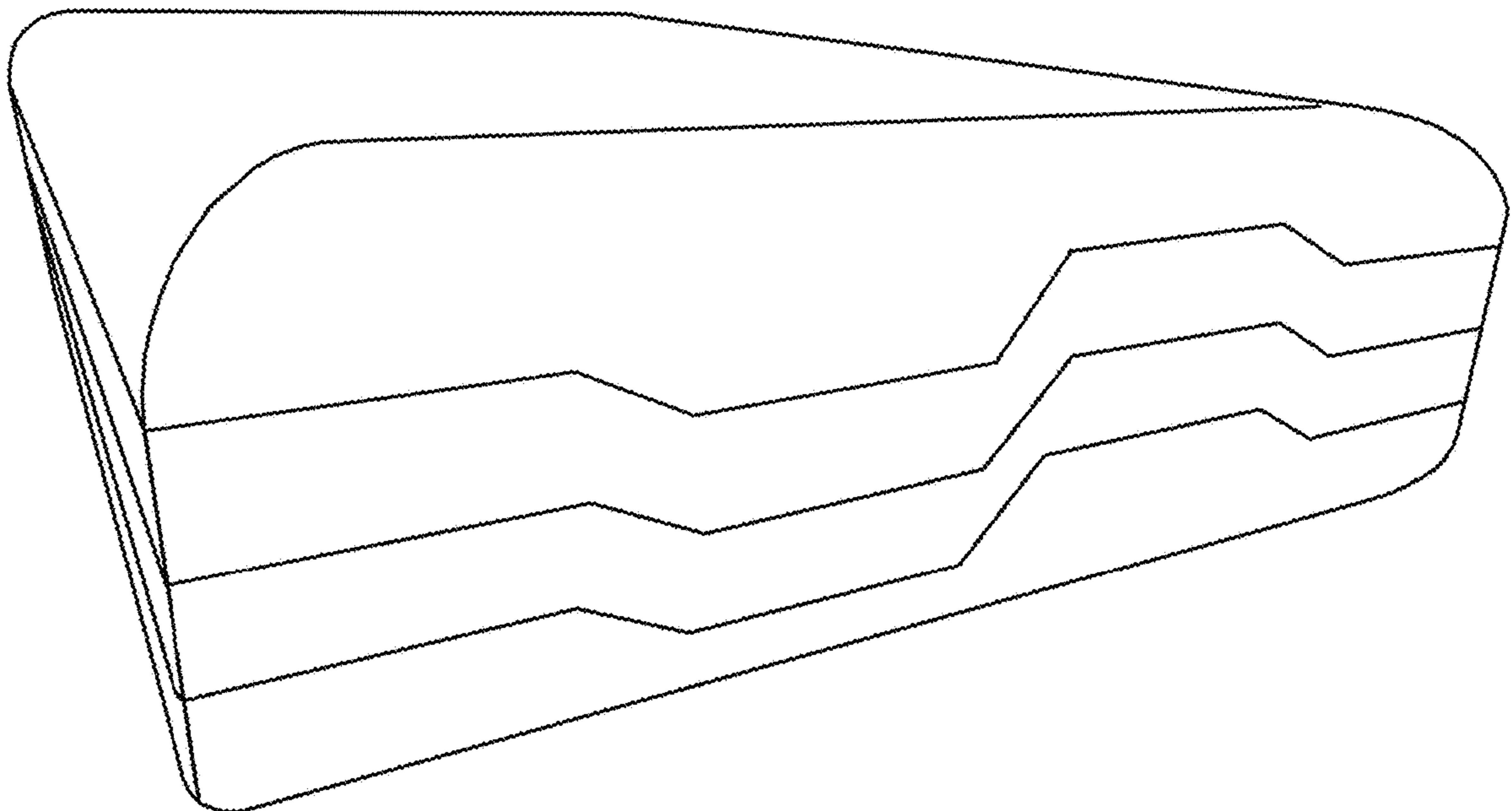

3.2

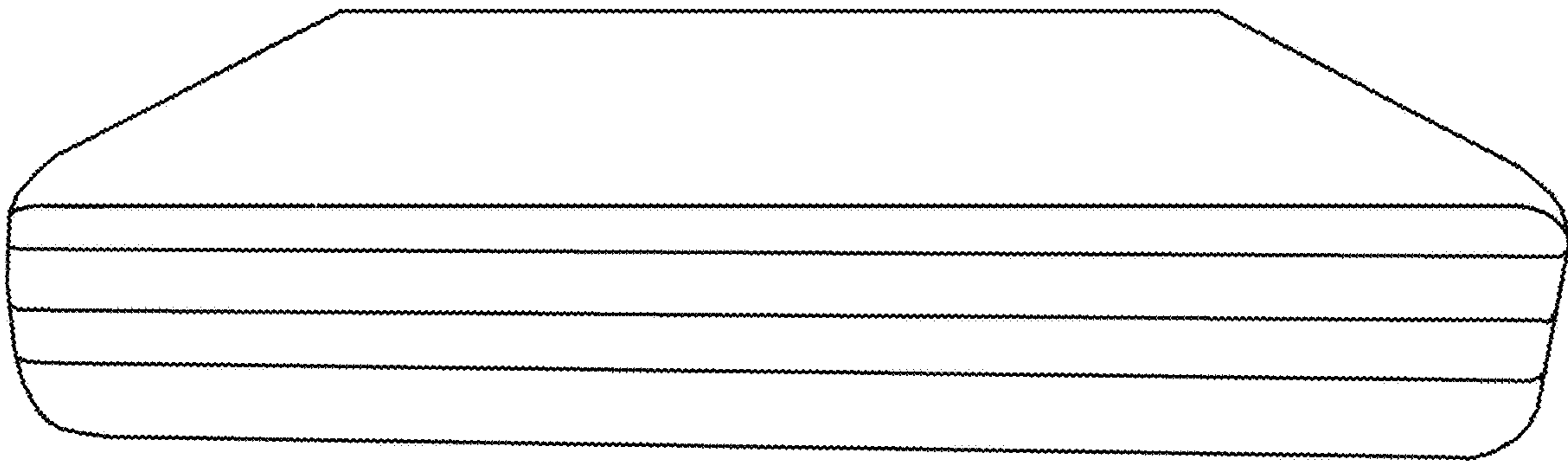

3.3

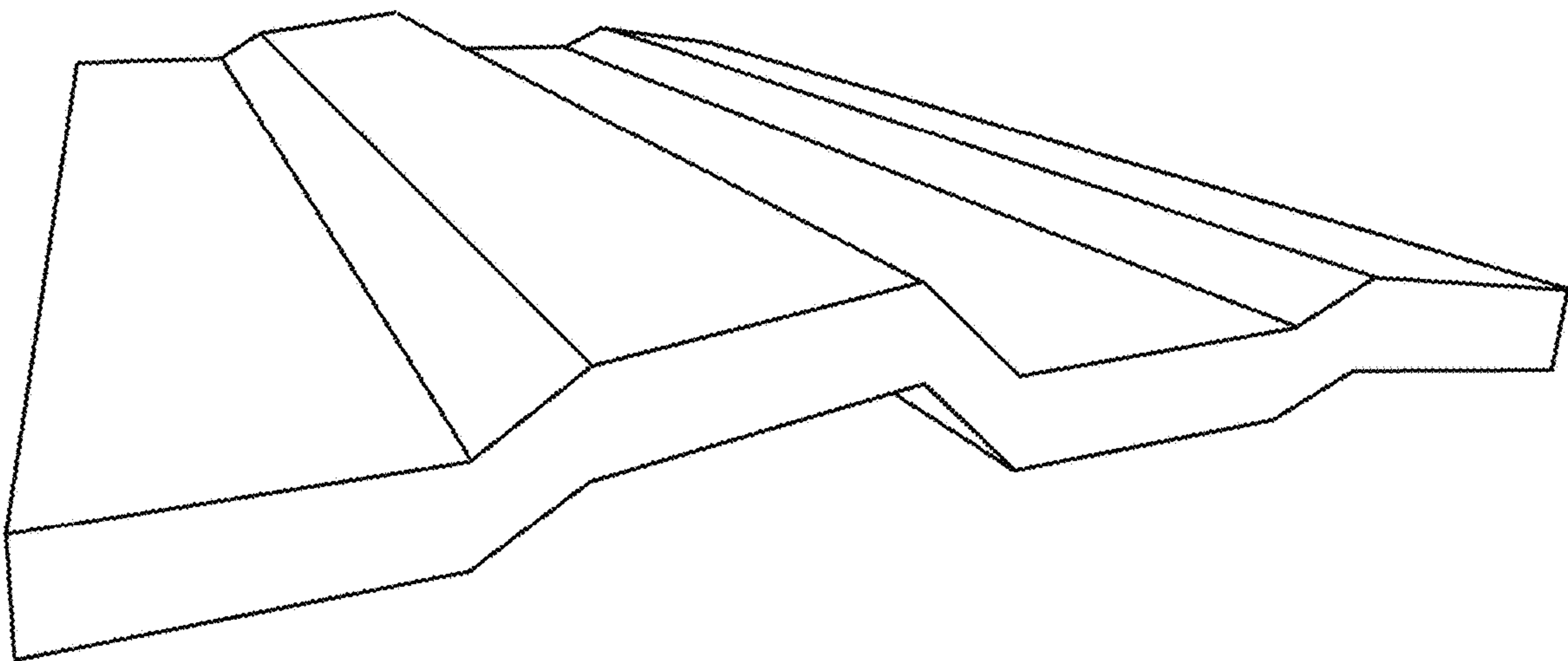

3.4

