



US00D992380S

(12) **United States Design Patent** (10) **Patent No.:** **US D992,380 S**
Giese et al. (45) **Date of Patent:** **** Jul. 18, 2023**

(54) **KNIFE**
(71) Applicants: **Joshua Giese**, Chicago, IL (US);
Sandra Giese, Mason, OH (US)
(72) Inventors: **Joshua Giese**, Chicago, IL (US);
Sandra Giese, Mason, OH (US)
(**) Term: **15 Years**

D615,608 S * 5/2010 Moore D22/118
D643,260 S * 8/2011 Spiegel D7/649
D643,261 S * 8/2011 Spiegel D7/649
D693,186 S * 11/2013 Hollinger D7/649
D696,083 S * 12/2013 Hollinger D7/649
D719,405 S 12/2014 Miller
9,132,559 B2 9/2015 Hatch et al.
D774,354 S * 12/2016 Scobey, Jr. D7/649
D790,287 S * 6/2017 Singer D7/649
D790,288 S * 6/2017 Singer D7/649

(Continued)

(21) Appl. No.: **29/866,955**
(22) Filed: **Oct. 3, 2022**
(51) **LOC (14) Cl.** **07-03**
(52) **U.S. Cl.**
USPC **D7/649**
(58) **Field of Classification Search**
USPC D7/649, 650, 651, 652, 693, 393, 394,
D7/395, 387; D8/93, 98, 99, 100, 101;
D22/118
CPC .. B26B 9/00; B26B 9/02; B26B 5/007; B26B
3/02; B26B 3/03; B26B 3/00; B26B
29/02; A47J 17/02
See application file for complete search history.

FOREIGN PATENT DOCUMENTS

CN 3241826 * 6/2002
GB 9004591725-0001 * 1/2018

(Continued)

Primary Examiner — Sandra Snapp
Assistant Examiner — Ieisha N Price
(74) *Attorney, Agent, or Firm* — Jenei LLC

(57) **CLAIM**

The ornamental design for a knife, as shown and described.

DESCRIPTION

FIG. 1 is a bottom, left side perspective view of a knife;
FIG. 2 is a front view of FIG. 1;
FIG. 3 is a rear view of FIG. 1;
FIG. 4 is a left side view of FIG. 1;
FIG. 5 is a right side view of FIG. 1;
FIG. 6 is a top view of FIG. 1;
FIG. 7 is a bottom view of FIG. 1; and,
FIG. 8 is an enlarged view taken from indication circle 8 of
FIG. 1.

The broken lines showing of the knife illustrates the envi-
ronment of the claimed design and forms no part thereof.
The dot-dot-dash broken lines rendered in FIGS. 1 and 8
form no part of the claimed design.

1 Claim, 7 Drawing Sheets

(56) **References Cited**
U.S. PATENT DOCUMENTS
108,141 A * 10/1870 Houseman B26B 29/02
30/340
492,409 A * 2/1893 May B26B 29/02
30/295
D295,011 S * 4/1988 Herron D7/649
D445,643 S * 7/2001 Kazaklaris D7/401.2
D461,681 S * 8/2002 Lothe D7/649
D461,688 S * 8/2002 Lothe D7/649
D538,591 S * 3/2007 Aston, III 8/107
D539,085 S * 3/2007 Aston, III 8/107
D539,086 S * 3/2007 Aston, III D8/107
7,302,760 B2 * 12/2007 Lake B26B 1/046
30/159
D610,399 S * 2/2010 Hamlin D7/387

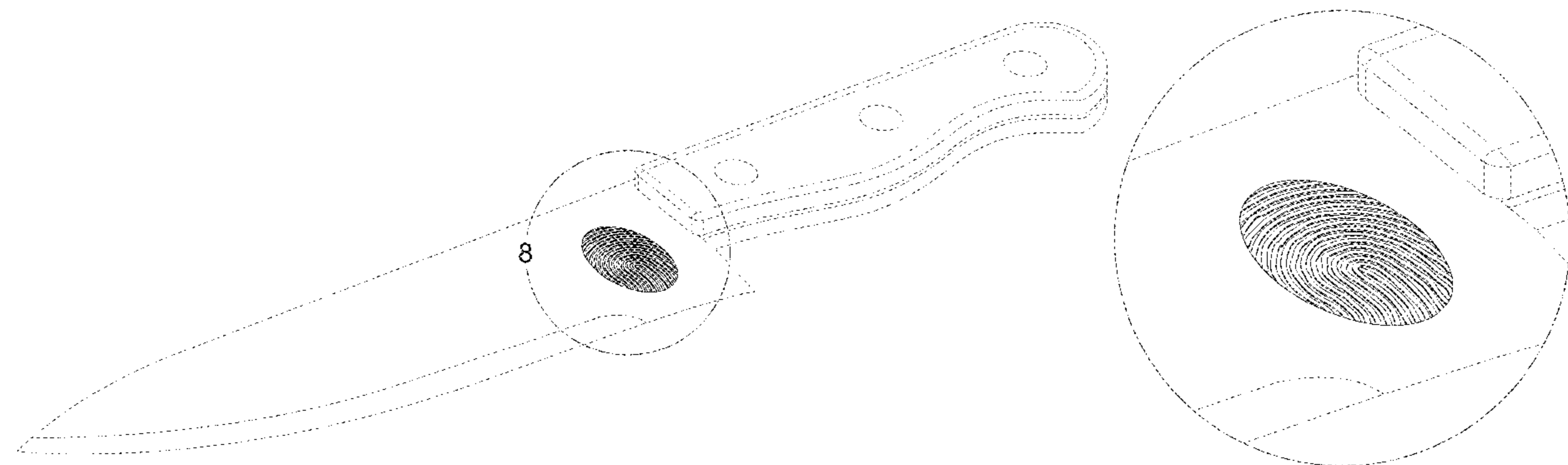

(56)

References Cited

U.S. PATENT DOCUMENTS

D790,289	S	*	6/2017	Singer	D7/649
D795,639	S	*	8/2017	Singer	D7/649
D810,517	S	*	2/2018	Singer	D7/649
D812,435	S	*	3/2018	Singer	D7/649
D815,897	S	*	4/2018	Insler	D7/649
D819,399	S		6/2018	Hamlin		
D852,591	S	*	7/2019	Hernandez	D7/649
D896,594	S		9/2020	Tarrerias		
D950,329	S	*	5/2022	Schwartz	D7/693
D953,819	S		6/2022	Liu		
D960,665	S		8/2022	Gu		
D962,722	S	*	9/2022	Huang	D7/649
D964,115	S		9/2022	Chen		
2002/0170184	A1		11/2002	Lothe		
2006/0179665	A1	*	8/2006	Aston, III	B26B 3/00 30/296.1
2010/0212166	A1	*	8/2010	Visnack	B26B 9/00 30/346
2010/0325901	A1	*	12/2010	Catalano	B26B 9/00 30/340
2015/0040404	A1		2/2015	Rigas		
2016/0375598	A1		12/2016	Singer		
2017/0210021	A1	*	7/2017	Lee	B26B 29/02
2020/0030998	A1	*	1/2020	Dawes, III	B26B 9/00
2020/0246992	A1	*	8/2020	Ritter	B26B 29/02

FOREIGN PATENT DOCUMENTS

GB	6112840	*	1/2021
JP	D1104290	*	3/2001
JP	D1178163	*	2/2002
JP	D1322754	*	2/2008

* cited by examiner

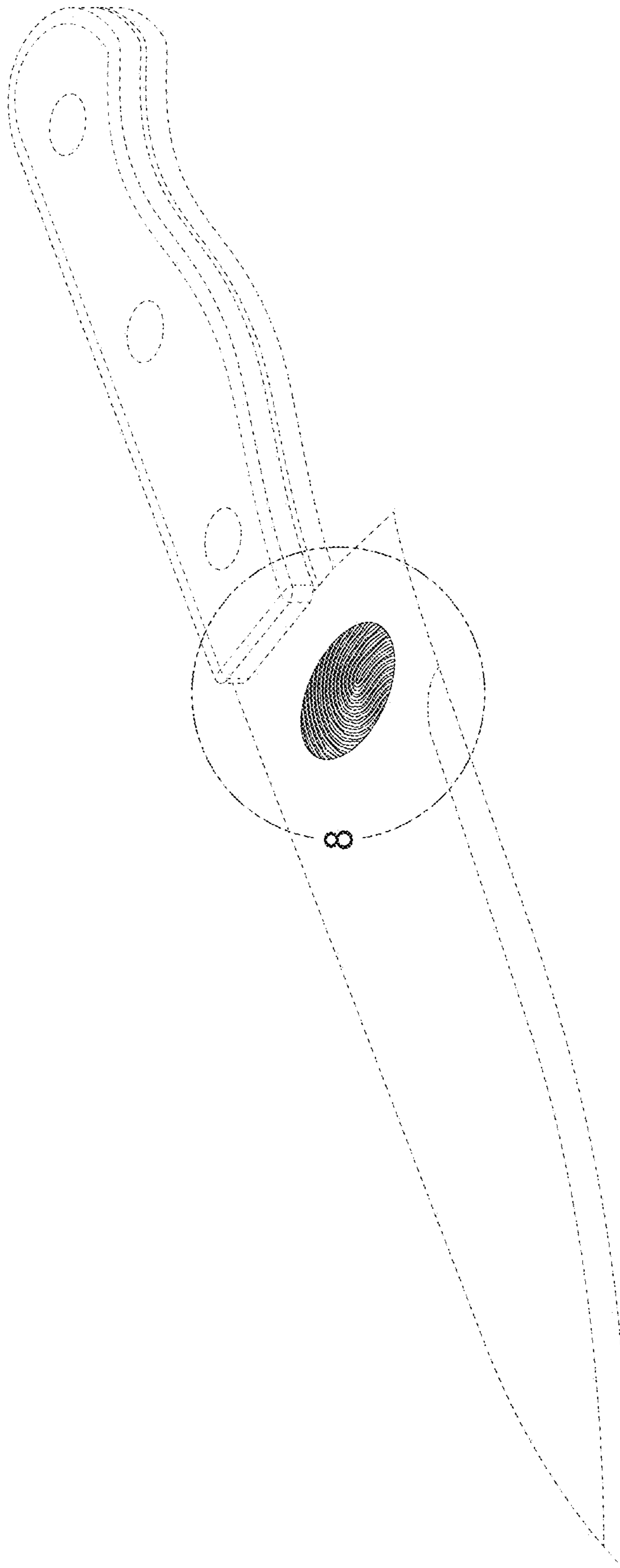

FIG. 1

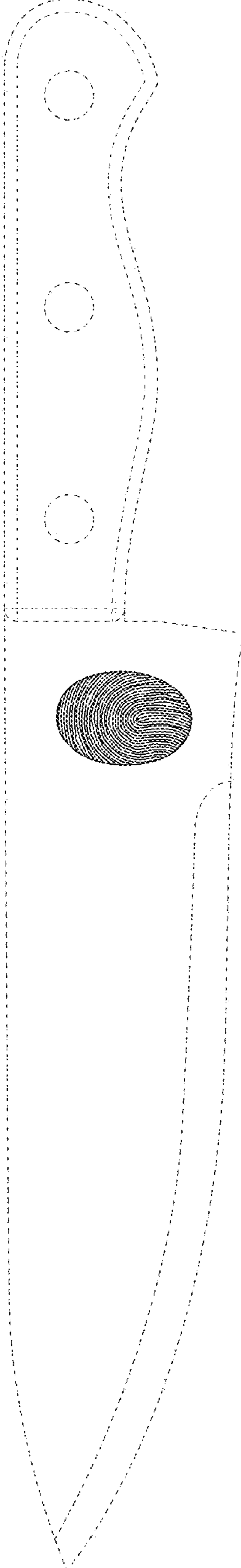

FIG. 2

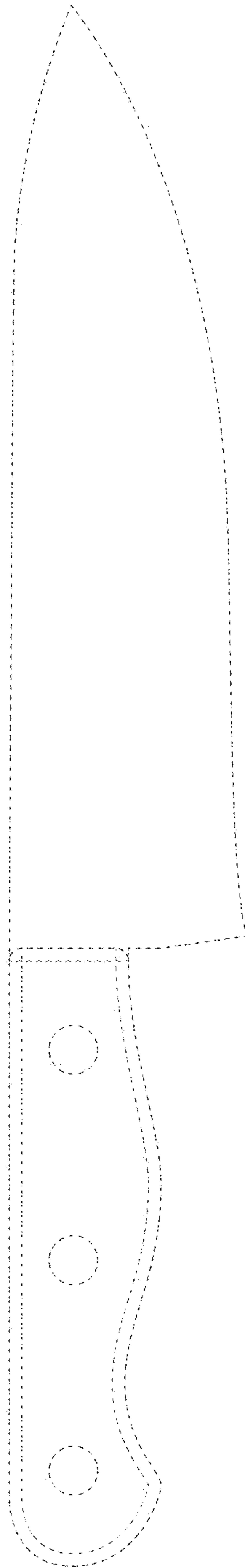

FIG. 3

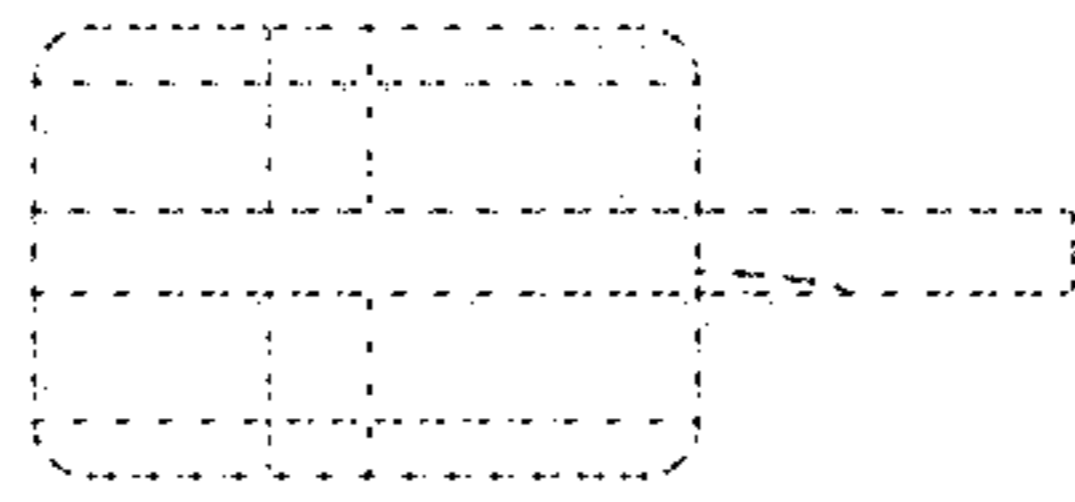

FIG. 5

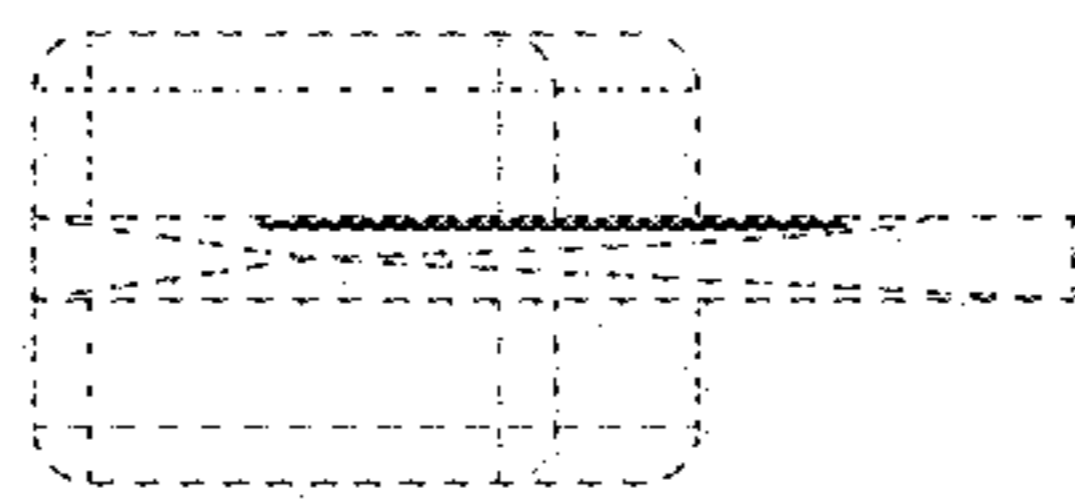

FIG. 4

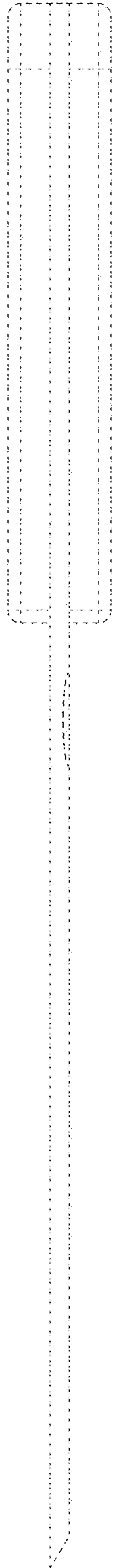

FIG. 6

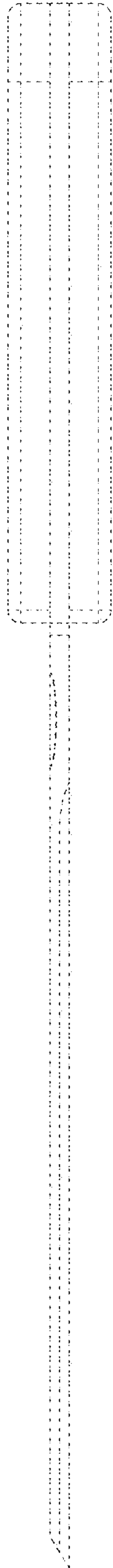

FIG. 7

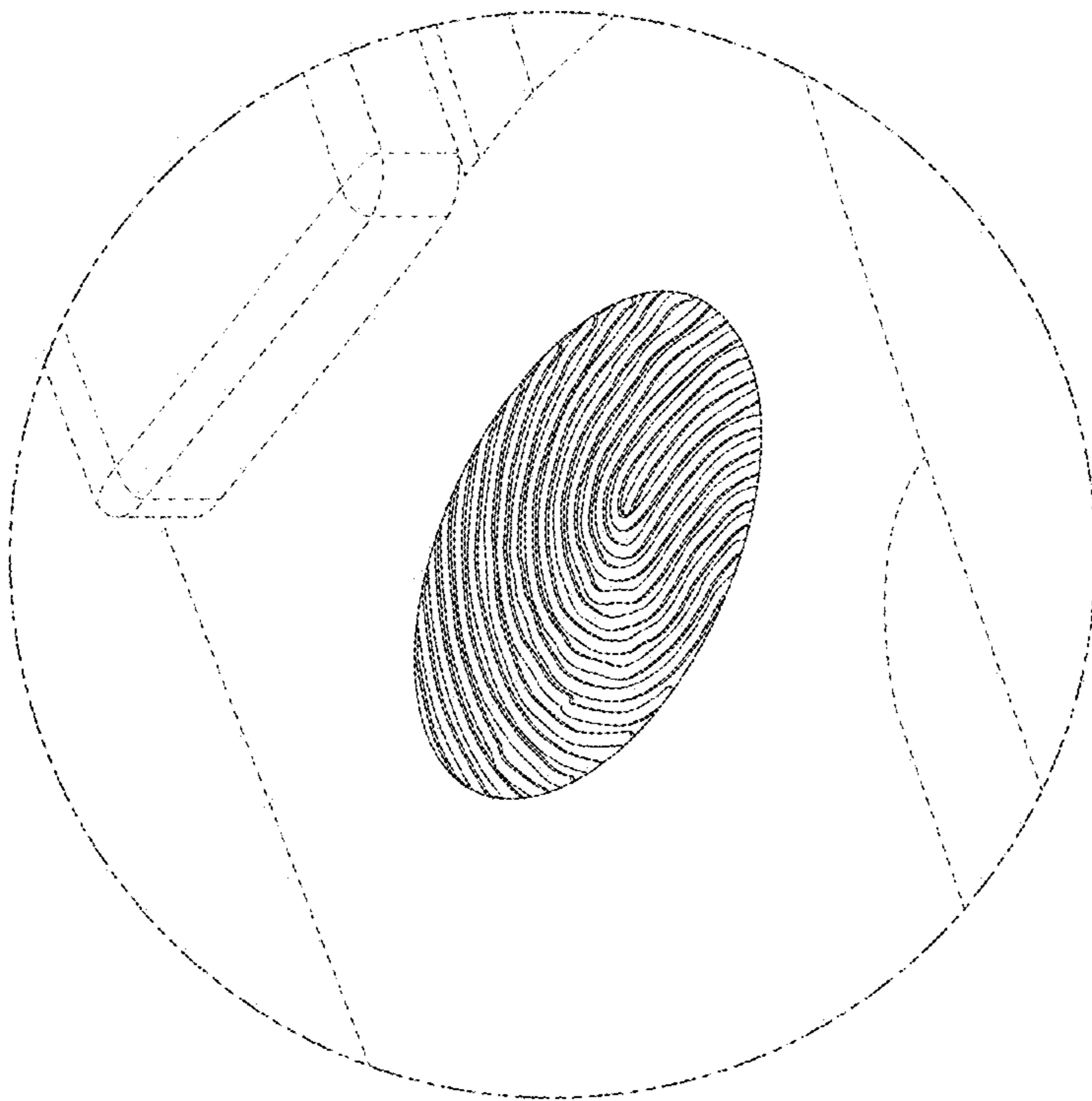

FIG. 8