



US00D990848S

(12) **United States Design Patent** (10) **Patent No.:** **US D990,848 S**
Dorn (45) **Date of Patent:** **** Jul. 4, 2023**

- (54) **SHOE MIDSOLE PERIPHERY**
- (71) Applicant: **Skechers U.S.A., Inc. II**, Manhattan Beach, CA (US)
- (72) Inventor: **Tobin Randall Dorn**, Manhattan Beach, CA (US)
- (73) Assignee: **Skechers U.S.A., Inc. II**, Manhattan Beach, CA (US)

D671,723 S * 12/2012 Teteriatnikov D2/947
 D677,451 S 3/2013 Amphyon
 D679,485 S 4/2013 Raysse
 (Continued)

FOREIGN PATENT DOCUMENTS

CN 306910981 * 3/2021
 GB 6169830 * 10/2021

OTHER PUBLICATIONS

[Skechers GOrun AltitudeTrail Running], available on Amazon.com, date first available Mar. 28, 2018 [site visited Apr. 20, 2023], Available from the internet URL: <https://a.co/d/3EGDVWb> (Year: 2018).*

(Continued)

Primary Examiner — Jennifer L Rempfer
Assistant Examiner — Adrienne Corna
 (74) *Attorney, Agent, or Firm* — Marshall A. Lerner; Steven J. Kim; Kleinberg & Lerner, LLP

(57) **CLAIM**

The ornamental design for a shoe midsole periphery, as shown and described.

DESCRIPTION

FIG. 1 is a perspective view of a shoe midsole periphery in accordance with my new design;
 FIG. 2 is a right side elevation view thereof;
 FIG. 3 is a left side elevation view thereof;
 FIG. 4 is a front elevation view thereof;
 FIG. 5 is a rear elevation view thereof;
 FIG. 6 is a top plan view thereof; and,
 FIG. 7 is a bottom plan view thereof.
 The broken lines shown in the drawings represent portions of the shoe midsole periphery and environmental structure in the form of a shoe upper and outsole that form no part of the claimed design. The surfaces devoid of shading lines form no part of the claimed design.

1 Claim, 6 Drawing Sheets

- (**) Term: **15 Years**
- (21) Appl. No.: **29/873,803**
- (22) Filed: **Apr. 7, 2023**
- (51) **LOC (14) Cl.** **02-04**
- (52) **U.S. Cl.**
USPC **D2/957; D2/947**
- (58) **Field of Classification Search**
USPC D2/908, 947, 951–960, 972, 977
CPC A43B 13/00; A43B 13/02; A43B 13/023;
A43B 13/026; A43B 13/04; A43B 13/08;
A43B 13/10; A43B 13/12; A43B 13/14;
A43B 13/141; A43B 13/143; A43B
13/16; A43B 13/18; A43B 13/181; A43B
13/189

See application file for complete search history.

(56) **References Cited**

U.S. PATENT DOCUMENTS

- D319,336 S 8/1991 Mitsui
- D522,231 S 6/2006 Dojan et al.
- D522,739 S 6/2006 Dojan et al.
- D522,740 S 6/2006 Dojan et al.
- D523,233 S 6/2006 Dojan et al.
- D532,599 S 11/2006 Dojan et al.
- D544,702 S 6/2007 Link
- D570,078 S 6/2008 Davis
- D575,944 S 9/2008 Pauk
- D661,880 S 6/2012 Raysse
- D663,108 S 7/2012 Pulli
- D669,254 S 10/2012 Vestuti et al.

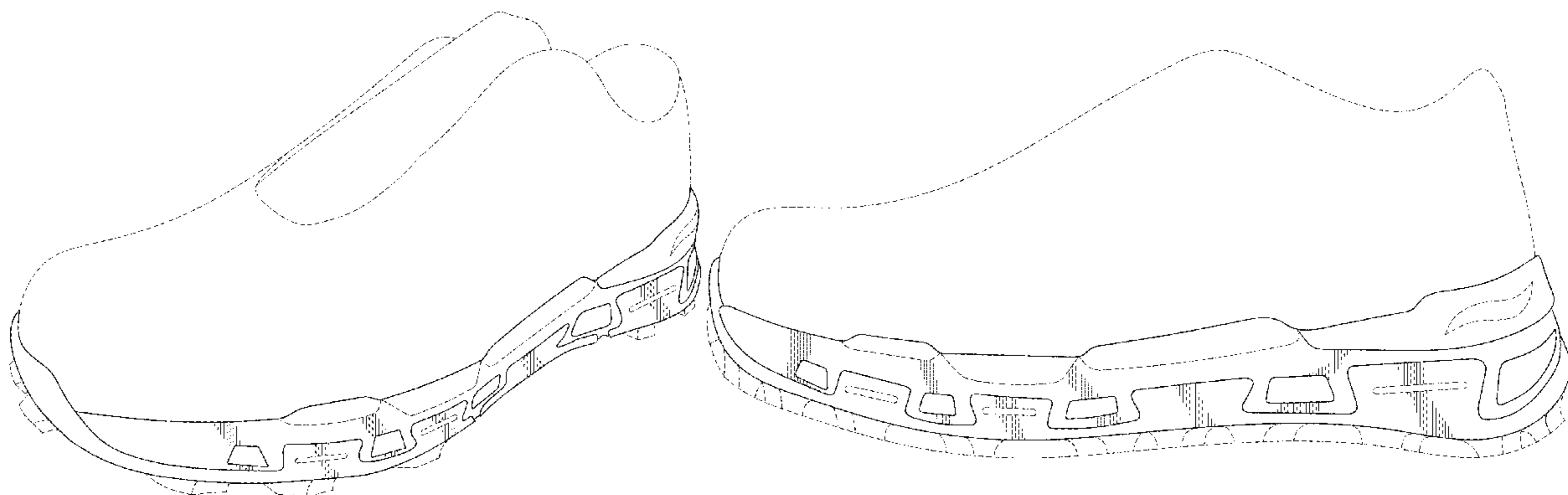

(56)

References Cited

U.S. PATENT DOCUMENTS

D679,486 S 4/2013 Raysse
 D680,309 S * 4/2013 Raysse D2/947
 D692,218 S 10/2013 Anceresi et al.
 D692,219 S 10/2013 Anceresi et al.
 D695,510 S 12/2013 Earle
 D696,501 S 12/2013 Miner
 D712,123 S * 9/2014 Goldman D2/954
 D733,411 S 7/2015 Lonigan
 D733,413 S 7/2015 Joseph
 D734,006 S 7/2015 Portzline
 D737,557 S 9/2015 Miner
 D741,582 S 10/2015 Miner
 D741,583 S 10/2015 Miner
 D754,956 S 5/2016 McCourt
 D759,359 S * 6/2016 Dombrow D2/951
 D767,862 S 10/2016 Hurayt
 D788,415 S 6/2017 Caron et al.
 D804,789 S 12/2017 Fecchio
 D822,964 S 7/2018 Hui
 D833,124 S 11/2018 Laska
 D850,083 S 6/2019 Jenkins et al.
 D861,308 S * 10/2019 Chang D2/947
 D862,060 S * 10/2019 Weeks D2/951
 D874,814 S 2/2020 Howe
 D876,768 S * 3/2020 Aden D2/947

D876,770 S 3/2020 Aden
 D887,689 S * 6/2020 Bove D2/947
 D895,949 S 9/2020 Simone
 D896,492 S * 9/2020 Dombrow D2/947
 D903,254 S 12/2020 Simone et al.
 D910,987 S 2/2021 Durflinger
 D915,745 S 4/2021 Little
 D936,345 S * 11/2021 Chang D2/947
 D936,346 S * 11/2021 Chang D2/947
 D946,253 S * 3/2022 Weeks D2/947
 D948,184 S 4/2022 Uzzeni
 D954,408 S 6/2022 Dieudonné
 D970,168 S 11/2022 Sagat
 D978,499 S 2/2023 Eldem et al.
 D978,500 S 2/2023 Eldem et al.
 D978,501 S 2/2023 Eldem et al.
 2005/0132608 A1 * 6/2005 Dojan A43B 13/20
 36/28

OTHER PUBLICATIONS

[Men's Greetah Construction Shoe], available on Amazon.com, date first available date [Dec. 12, 2019], [site visited Apr. 20, 2023], Available from the internet URL: <https://a.co/d/e7i8Twi> (Year: 2019).*

* cited by examiner

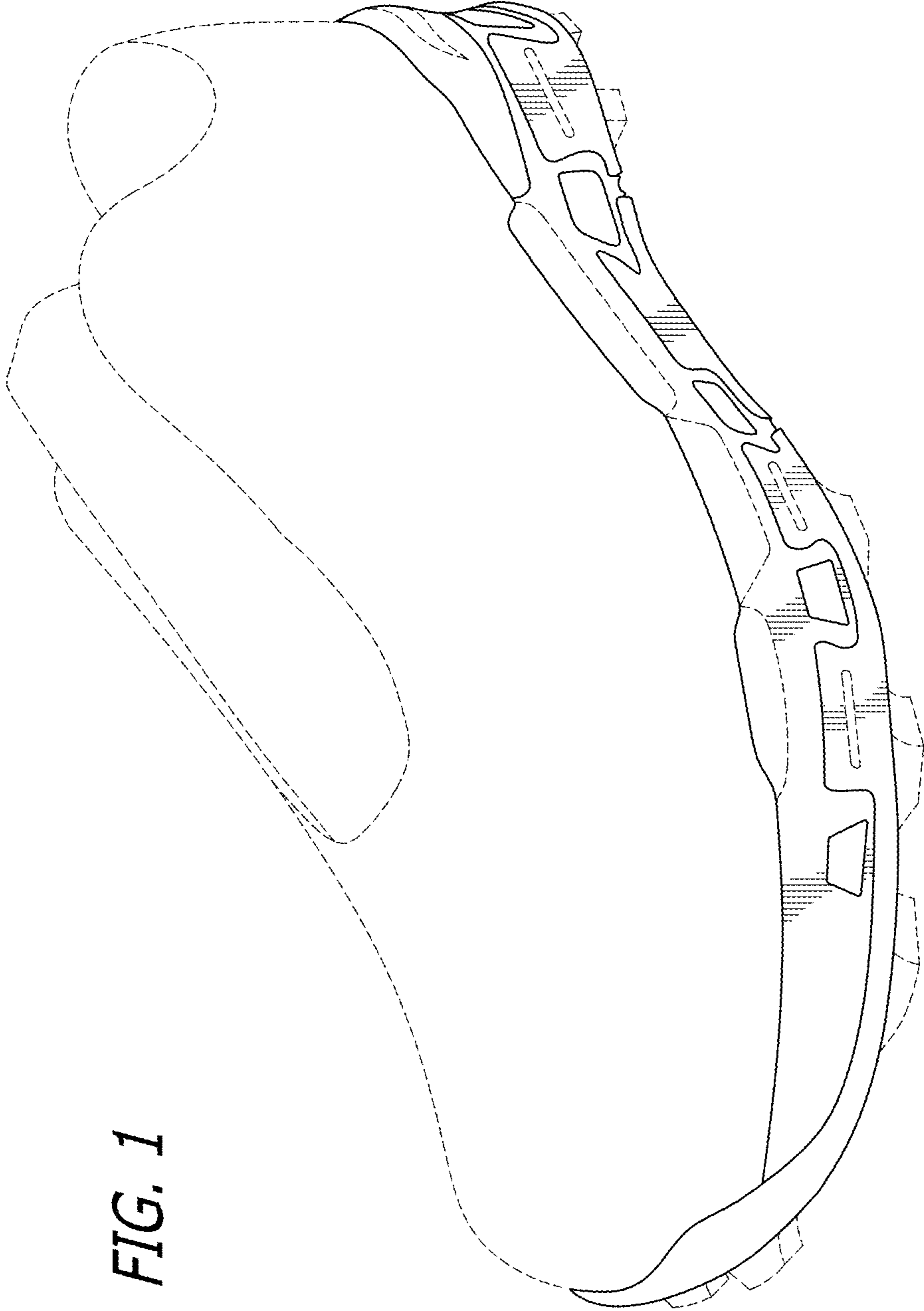

FIG. 1

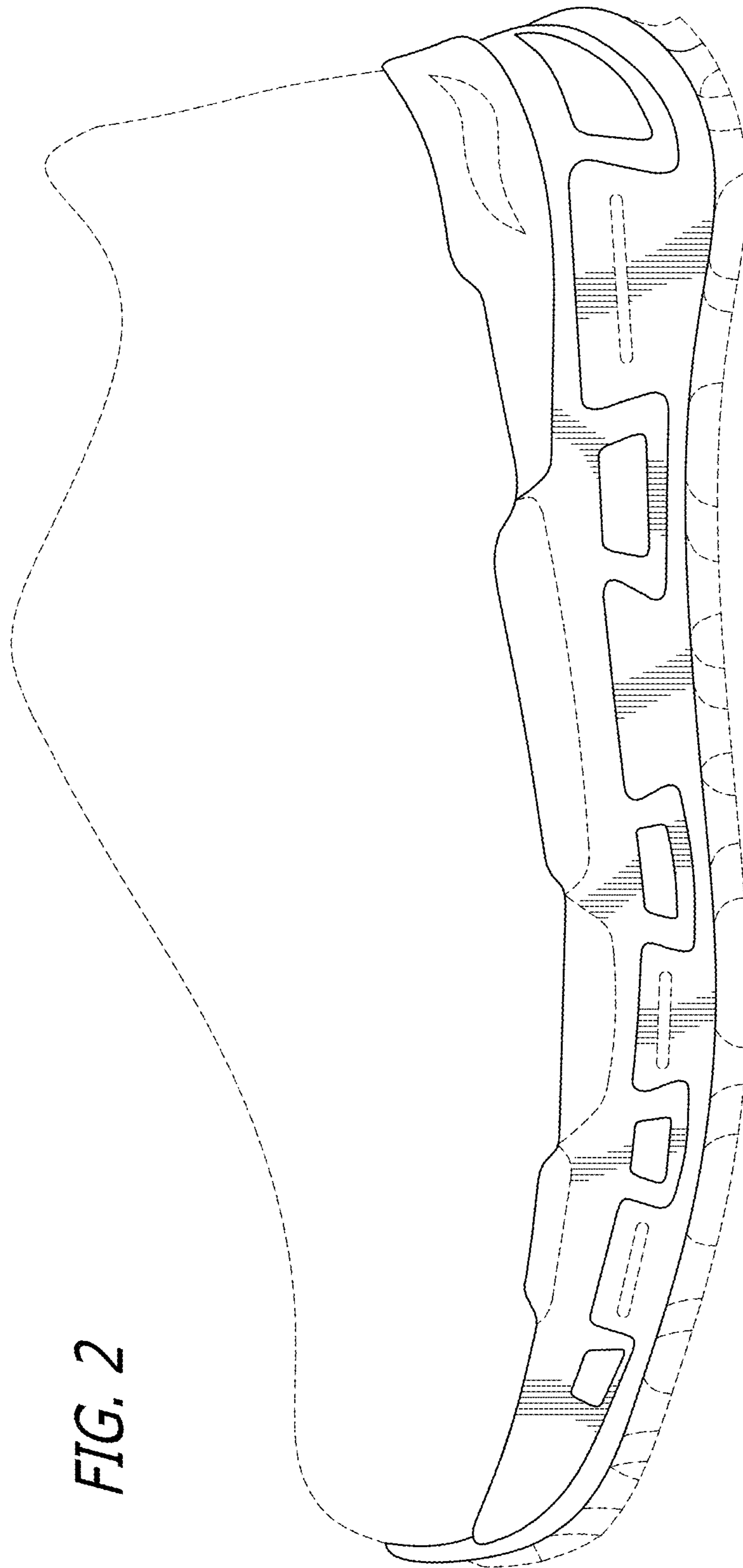

FIG. 2

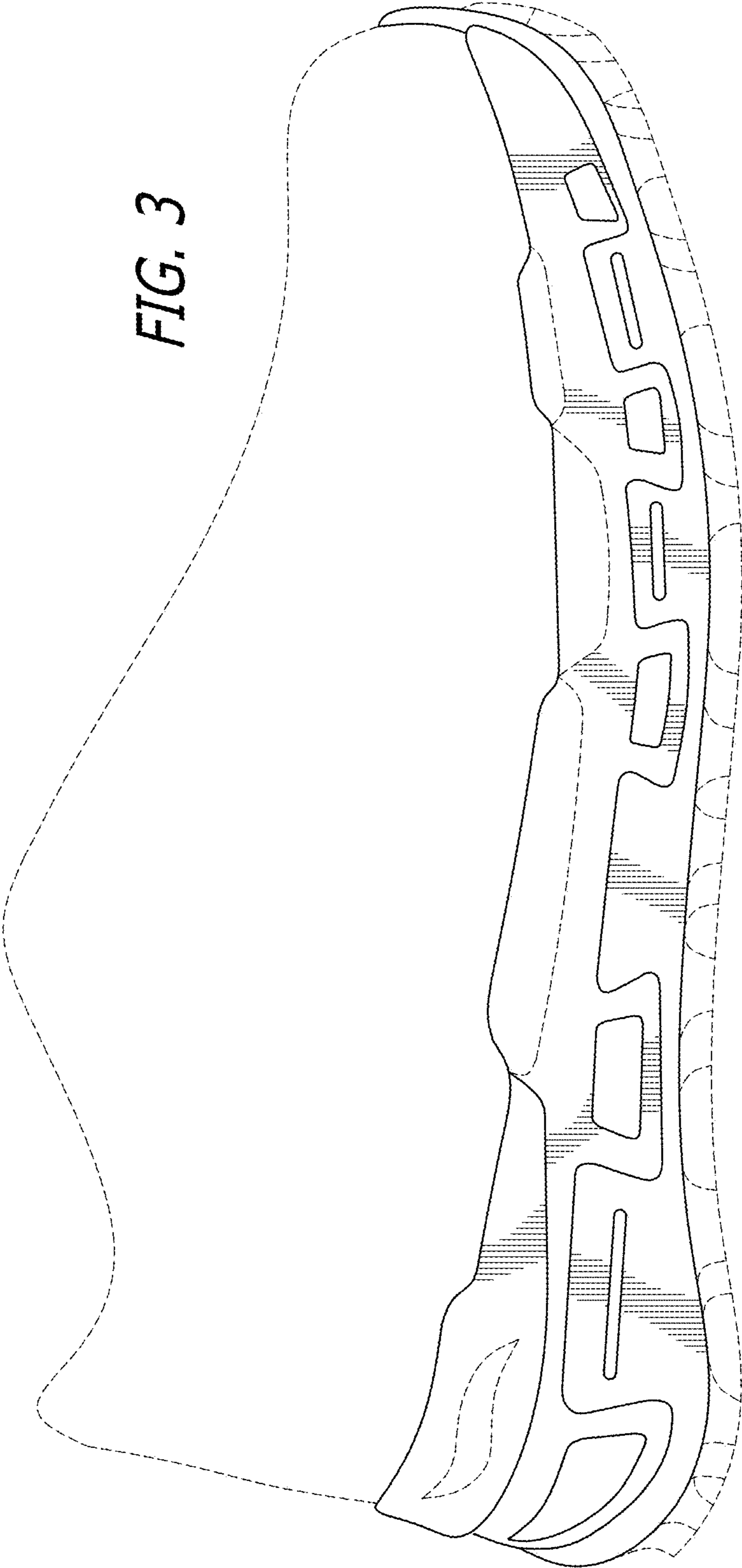

FIG. 3

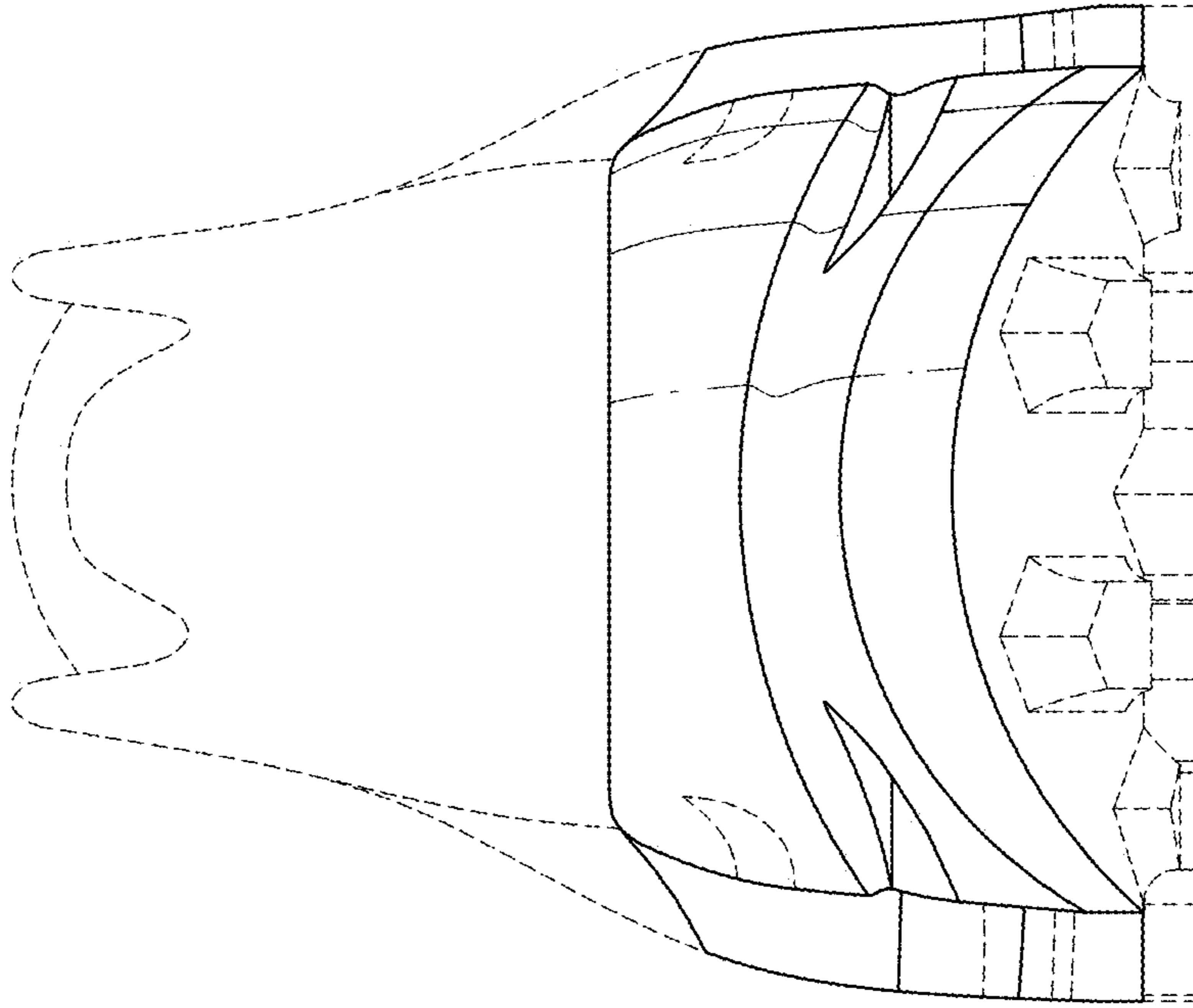

FIG. 5

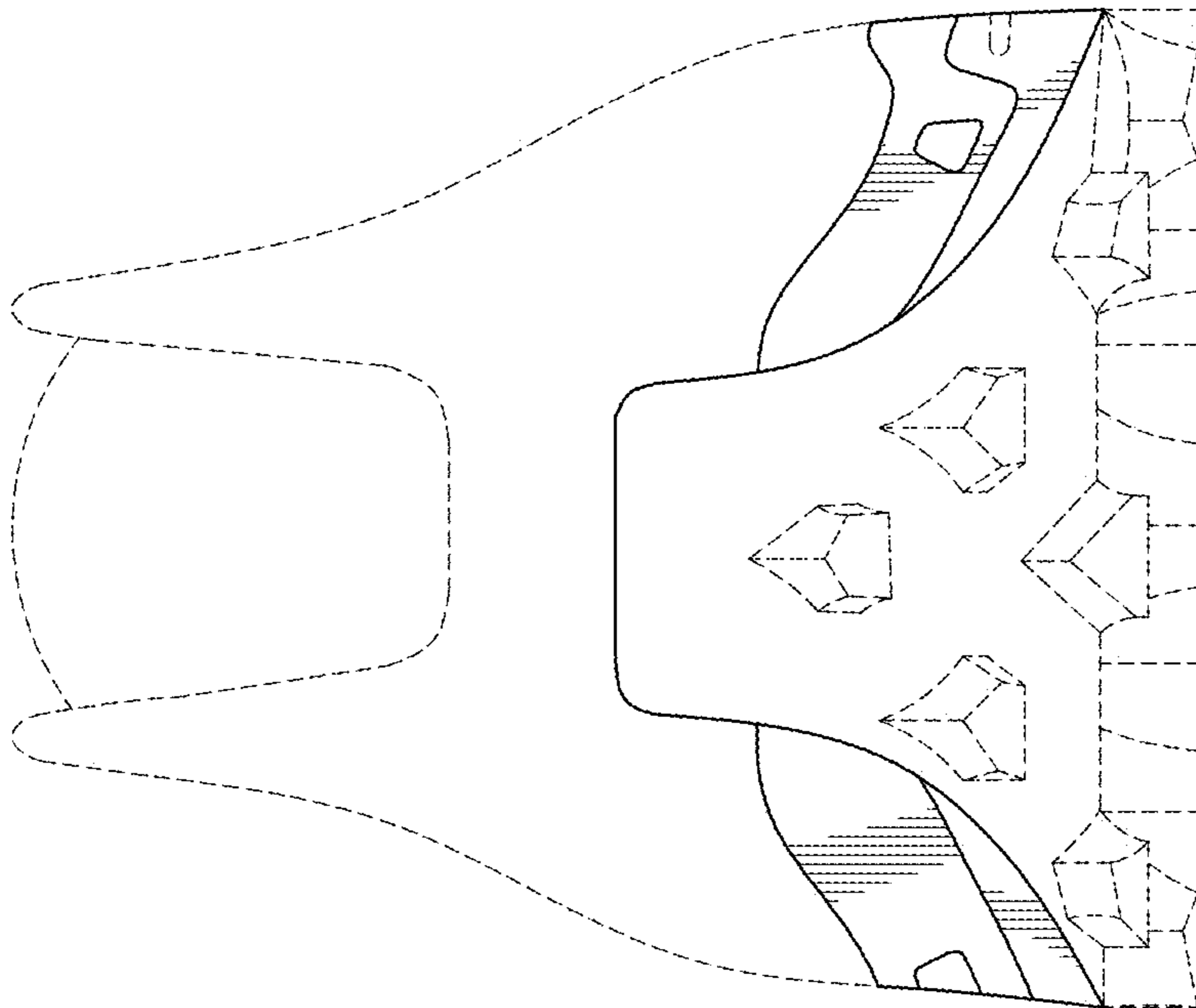

FIG. 4

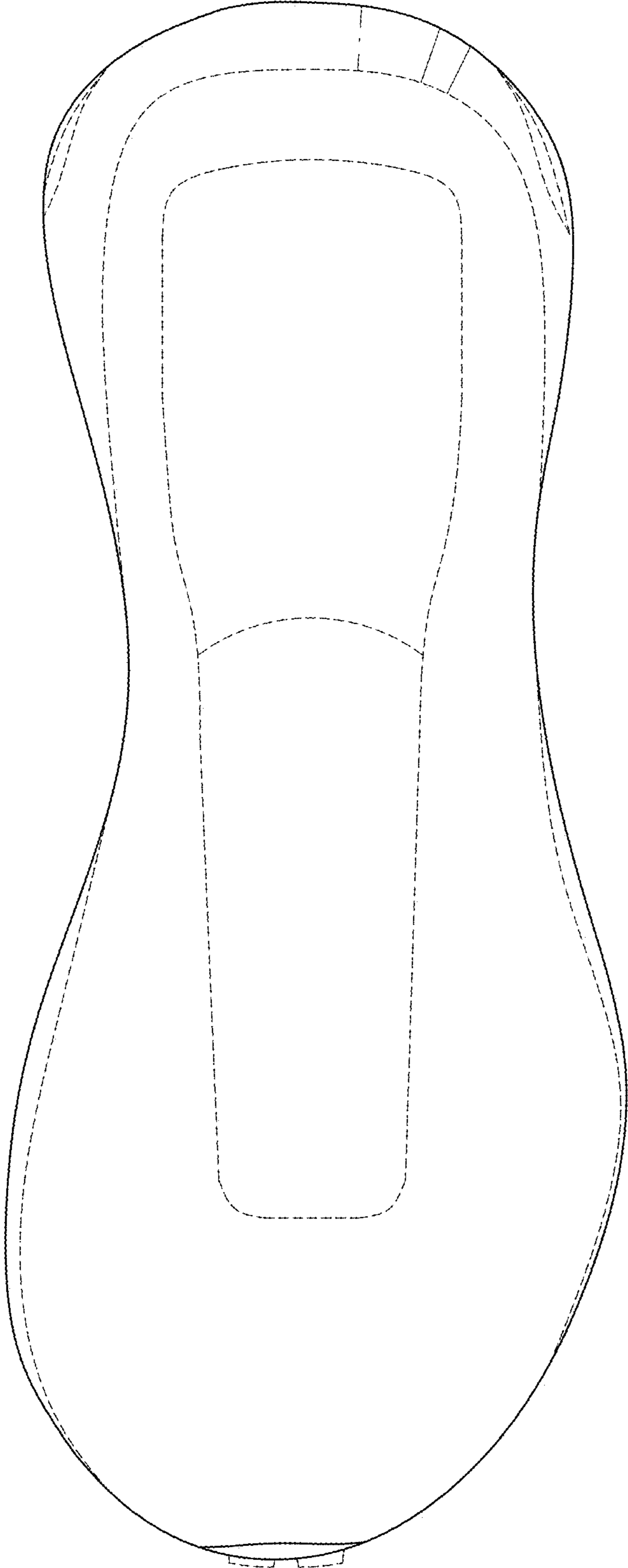

FIG. 6

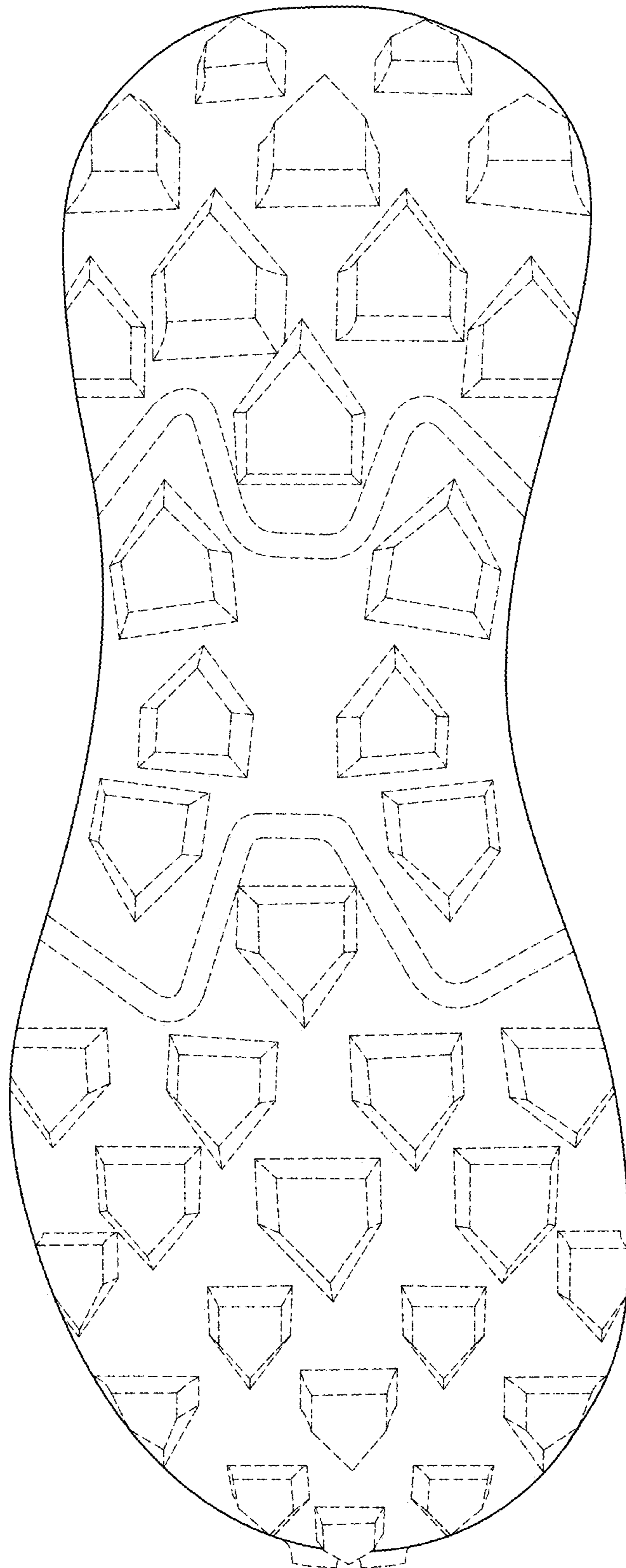

FIG. 7