



US00D989926S

(12) **United States Design Patent**
Bucher

(10) **Patent No.:** **US D989,926 S**
(45) **Date of Patent:** **** Jun. 20, 2023**

(54) **SHOWER BASE**
(71) Applicant: **AS America, Inc.**, Piscataway, NJ (US)
(72) Inventor: **Christophe Bucher**, Hillsborough, NJ (US)

D603,490 S * 11/2009 Stanchak D23/304
D626,252 S * 10/2010 Bouthillier D25/48.3
10,070,757 B2 * 9/2018 Jacob E05D 15/0656
D914,855 S * 3/2021 Yin D23/305

* cited by examiner

(73) Assignee: **AS America, Inc.**, Piscataway, NJ (US)
(**) Term: **15 Years**

Primary Examiner — Robert A Delehanty
(74) *Attorney, Agent, or Firm* — Tyler A. Stevenson;
Anna-lisa L. Gallo

(21) Appl. No.: **29/772,684**

(57) **CLAIM**

(22) Filed: **Mar. 3, 2021**

I claim the ornamental design for a shower base, as shown and described.

(51) **LOC (14) Cl.** **23-02**

(52) **U.S. Cl.**
USPC **D23/304**

DESCRIPTION

(58) **Field of Classification Search**
USPC D23/275, 283, 303–304; D6/584, 586
See application file for complete search history.

FIG. 1 is a top, left side perspective view of a shower base showing my new design;
FIG. 2 is a front view thereof;
FIG. 3 is a rear view thereof;
FIG. 4 is a left side view thereof;
FIG. 5 is a right side view thereof;
FIG. 6 is a top view thereof;
FIG. 7 is a bottom view thereof; and,
FIG. 8 is a bottom, left side perspective view thereof.
Broken lines represent portions of the shower base that form no part of the claimed design.

(56) **References Cited**

U.S. PATENT DOCUMENTS

D208,967 S * 10/1967 Wolske D23/283
D230,807 S * 3/1974 Penson D6/584
3,942,199 A * 3/1976 Kollsman A47K 3/002
D6/584
D363,342 S * 10/1995 Dannenberg D23/283
5,778,464 A * 7/1998 Chapple A47K 3/008
4/584

1 Claim, 6 Drawing Sheets

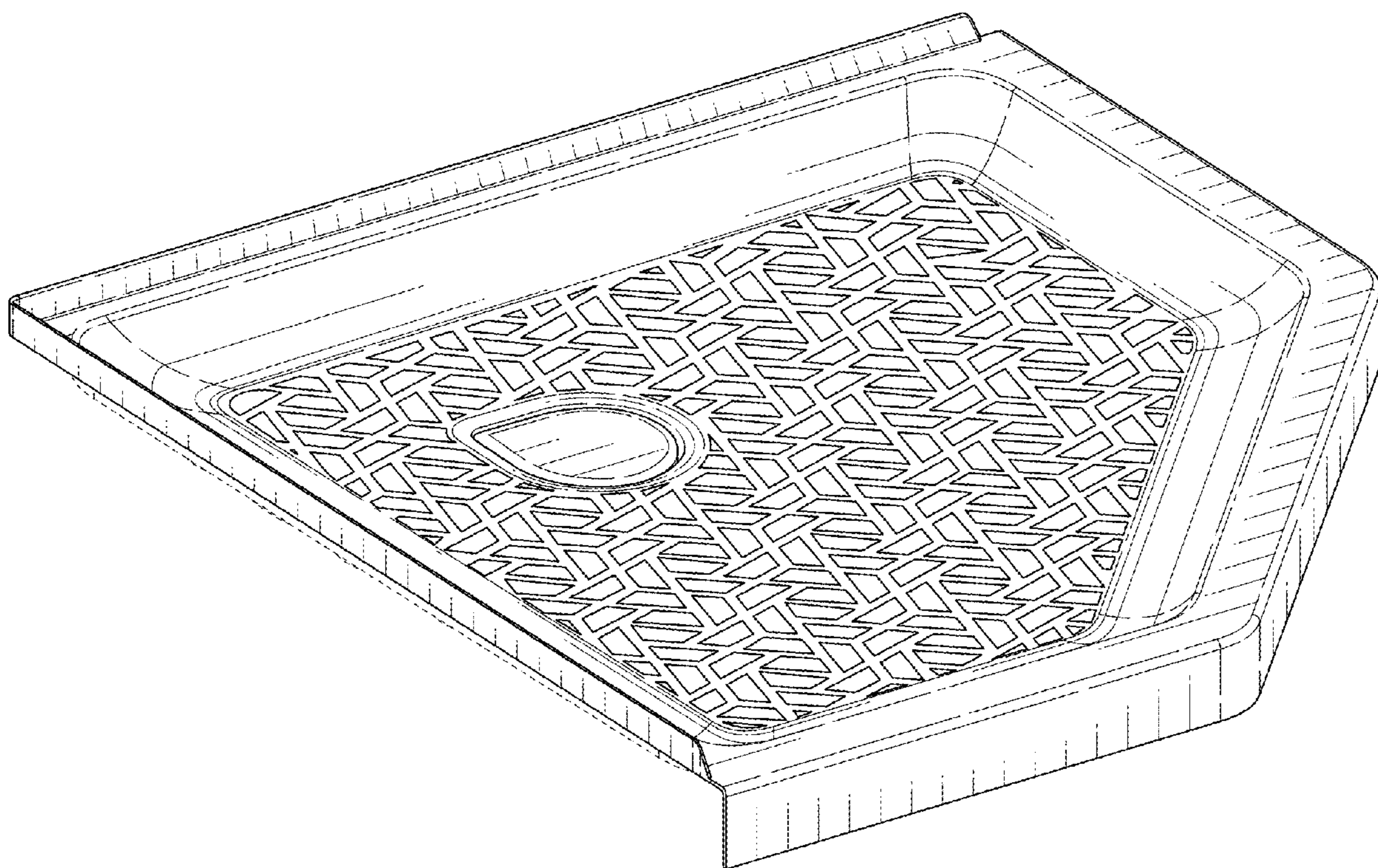

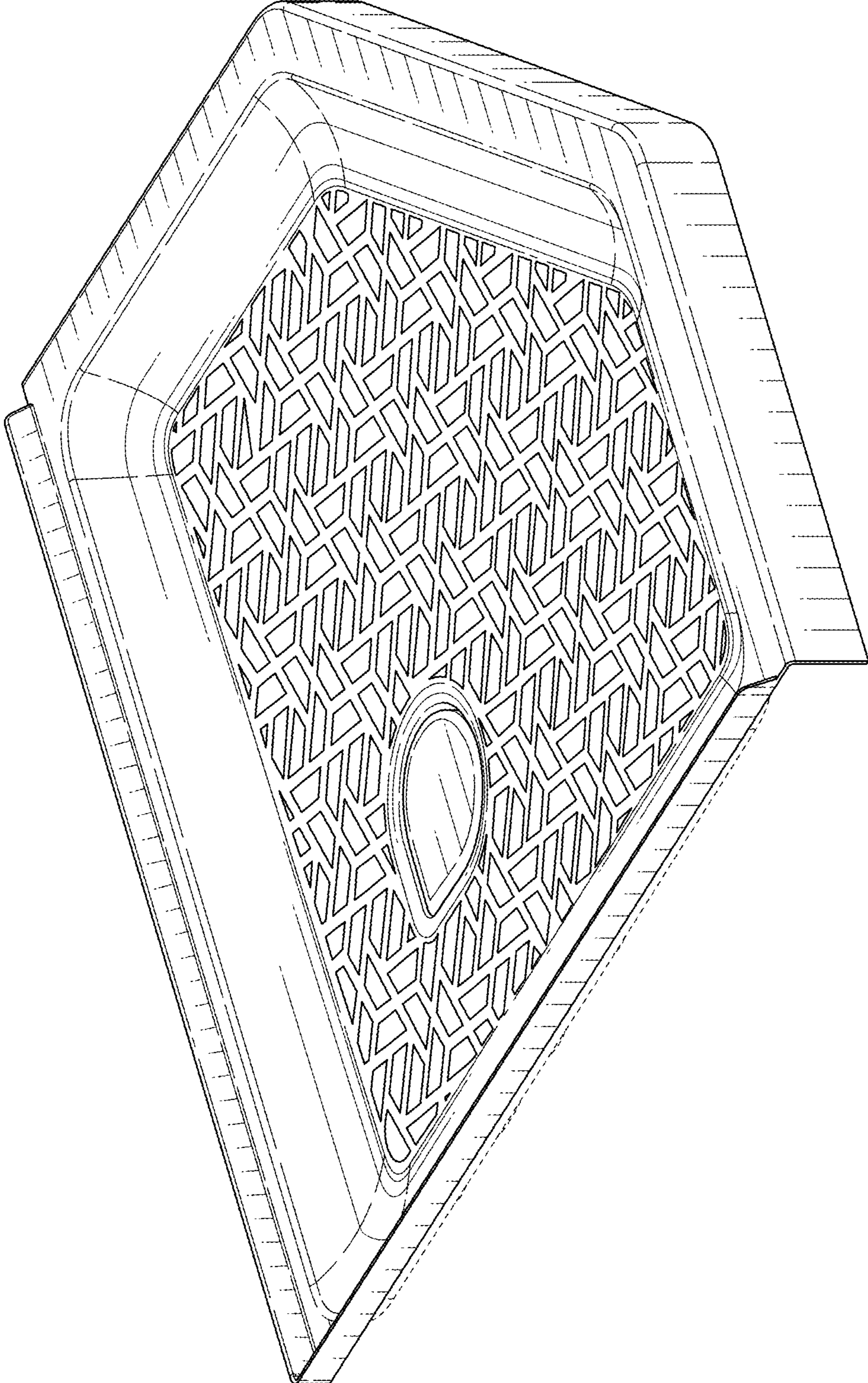

FIG. 1

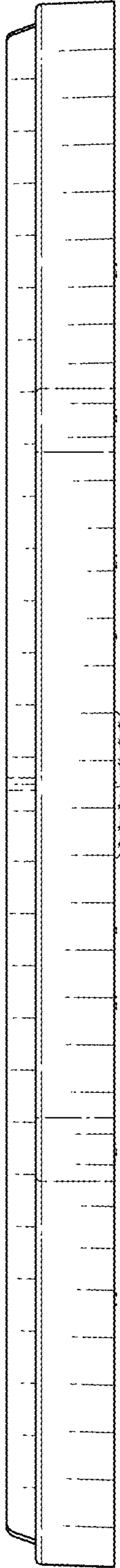

FIG. 2

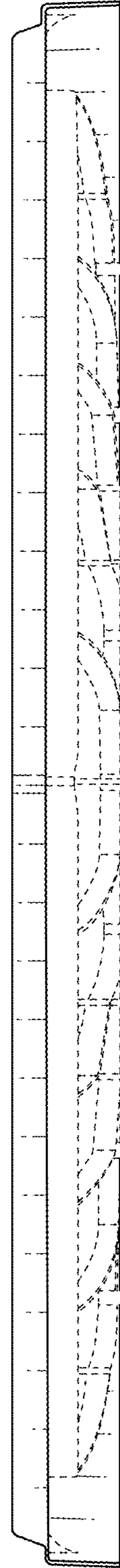

FIG. 3

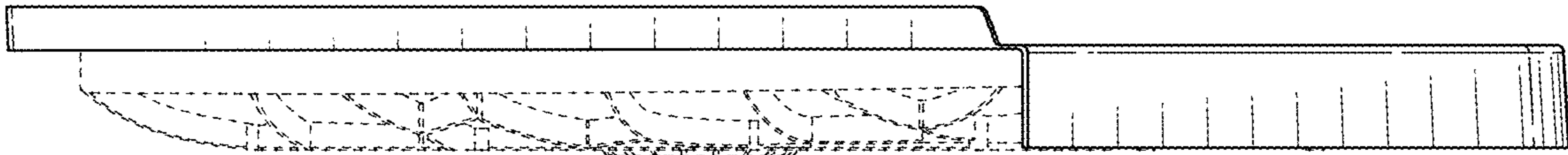

FIG. 4

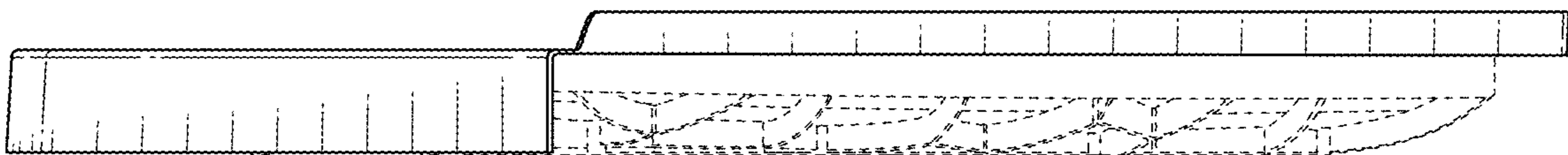

FIG. 5

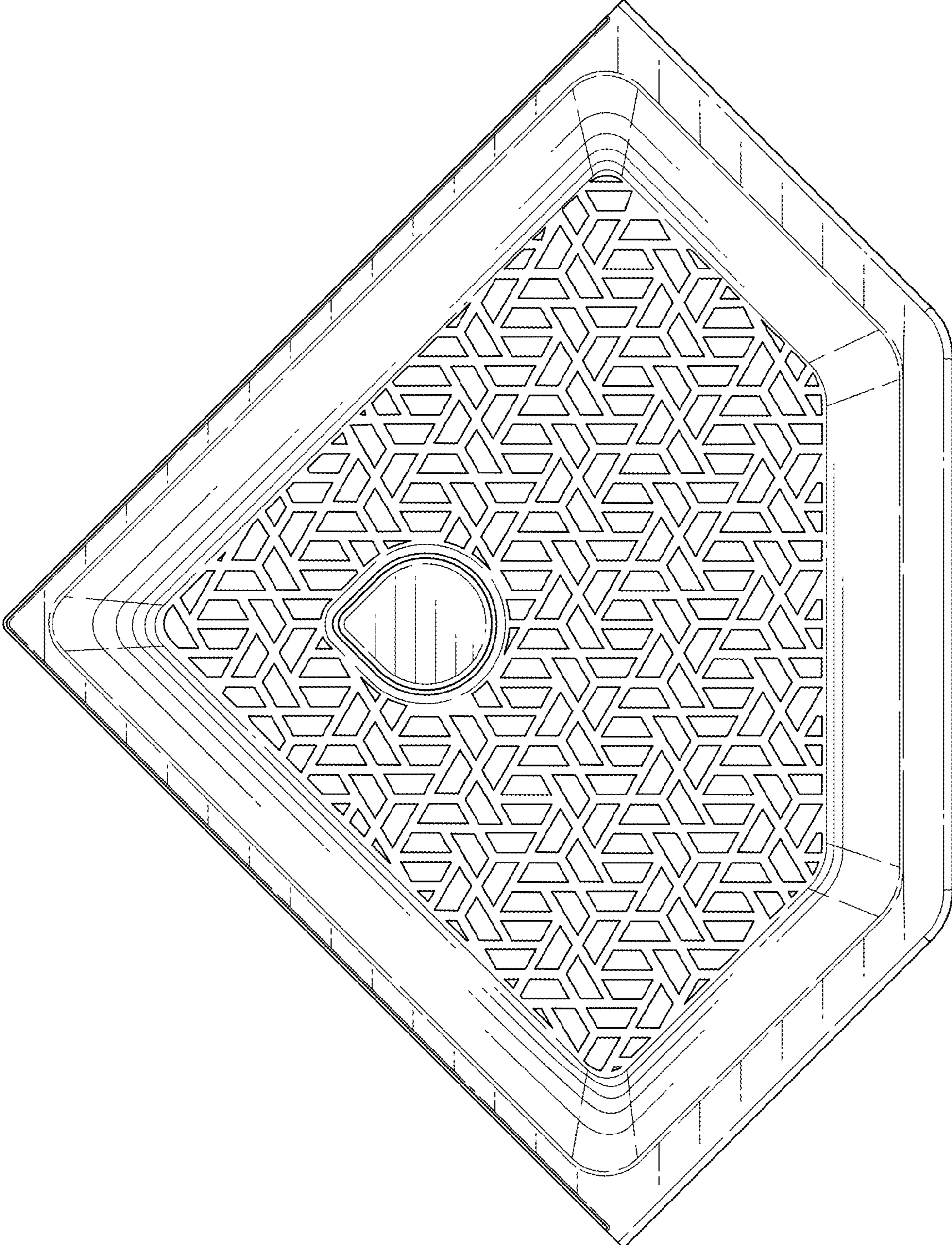

FIG. 6

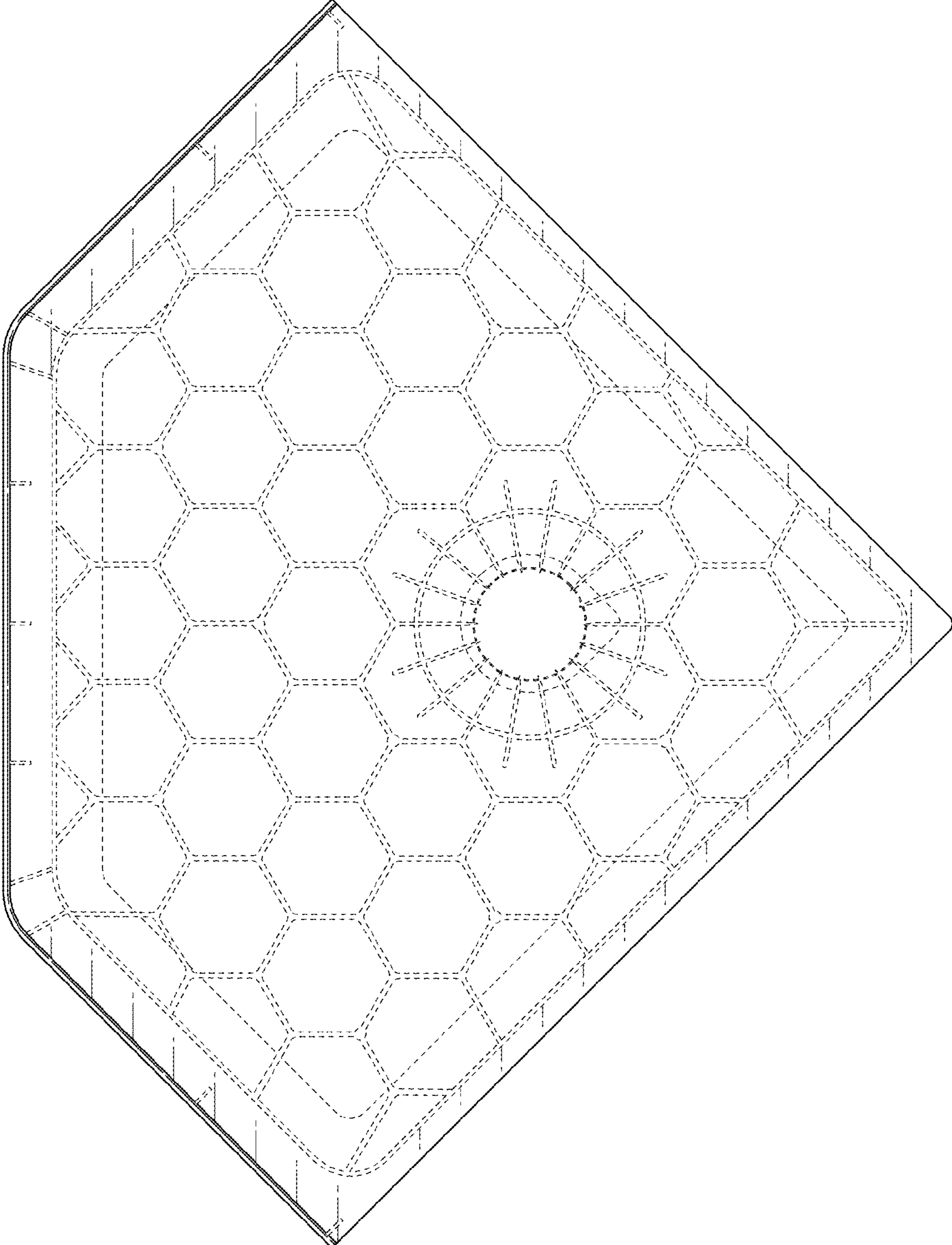

FIG. 7

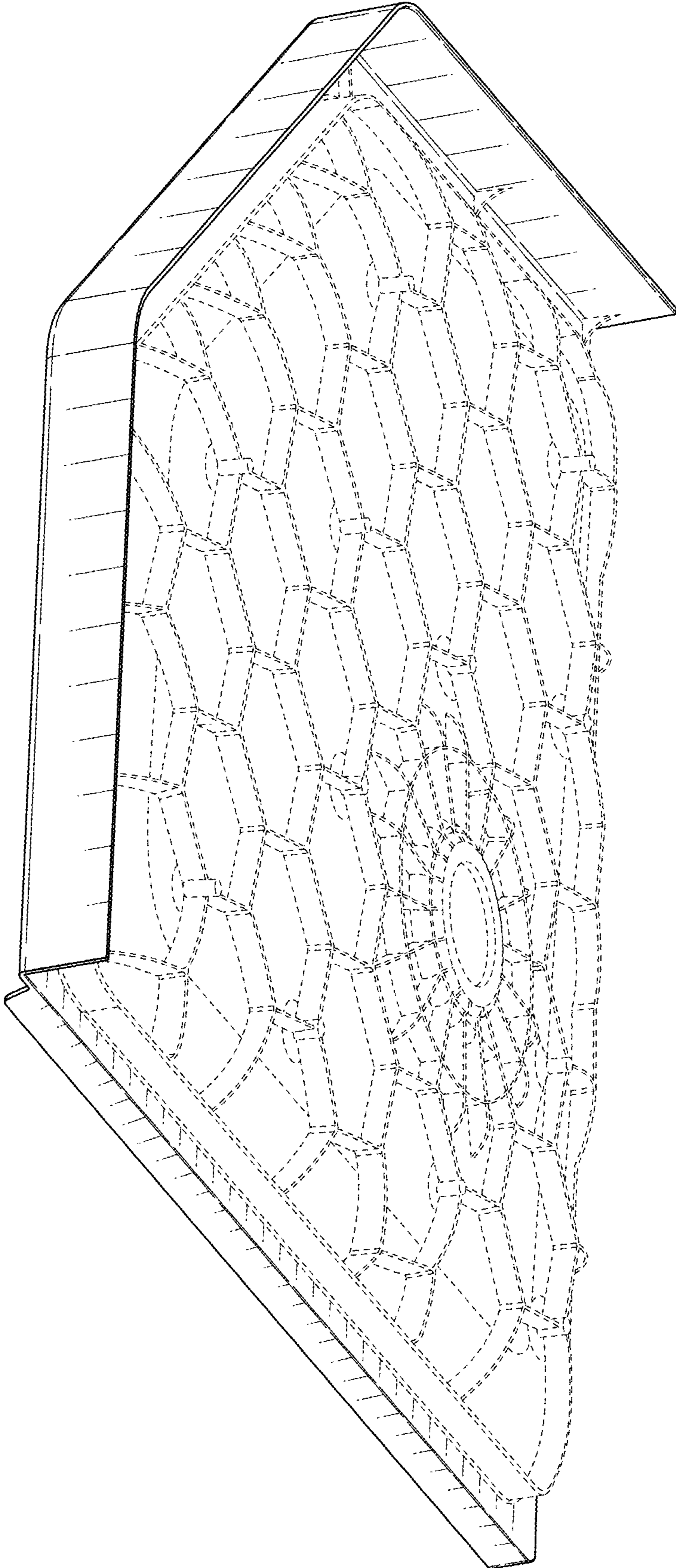

FIG. 8