



US00D989902S

(12) **United States Design Patent**  
**He**

(10) **Patent No.:** **US D989,902 S**  
(45) **Date of Patent:** **\*\* Jun. 20, 2023**

(54) **INFLATABLE SPRINKLER POOL**  
(71) Applicant: **ANBEL PLASTIC**  
**MANUFACTURING LTD**, Zhongshan  
(CN)

D951,382 S \* 5/2022 Zhou ..... D21/815  
D960,260 S \* 8/2022 Engler ..... D21/616  
2016/0088953 A1\* 3/2016 Benezri ..... A45F 4/00  
5/655

(72) Inventor: **Wu He**, Zhongshan (CN)  
(\*\*) Term: **15 Years**

**FOREIGN PATENT DOCUMENTS**

EM 008317416-0021 \* 1/2021

(21) Appl. No.: **29/769,381**  
(22) Filed: **Feb. 4, 2021**

**OTHER PUBLICATIONS**

3-in-1 Splash Pad Sprinkler for Kids Out, mercari.com, first available date Aug. 13, 2021 [online], [site visited Jan. 9, 2023], Available from internet, URL: <https://www.mercari.com/us/item/m58839248885> (Year: 2021).\*

(30) **Foreign Application Priority Data**

Oct. 13, 2020 (CN) ..... 202030608494.8

(51) **LOC (14) Cl.** ..... **21-03**

(52) **U.S. Cl.**  
USPC ..... **D21/815**

(58) **Field of Classification Search**  
USPC ..... D21/811, 815, 801, 803, 804, 805, 809,  
D21/816; D25/2; D6/604  
CPC ..... E04H 4/00; E04H 4/0025; E04H 4/0018;  
E04H 4/0031; E04H 4/0037  
See application file for complete search history.

(Continued)

*Primary Examiner* — Samantha Q Lawrence  
*Assistant Examiner* — Thanh Luu Wong  
(74) *Attorney, Agent, or Firm* — Daniel M. Cohn;  
Howard M. Cohn

(56) **References Cited**

**U.S. PATENT DOCUMENTS**

D259,356 S \* 5/1981 Ferretti ..... D21/816  
7,818,842 B2 \* 10/2010 Marciano ..... A47C 27/081  
441/131  
D690,377 S \* 9/2013 Cranke ..... D21/713  
D816,179 S \* 4/2018 de Grasse ..... D21/803  
D873,361 S \* 1/2020 Hsu ..... D21/808  
D915,539 S \* 4/2021 Zhang ..... D21/803  
D919,731 S \* 5/2021 Han ..... D21/816  
D928,268 S \* 8/2021 Pan ..... D21/815

(57) **CLAIM**  
The ornamental design for an inflatable sprinkler pool, as shown and described.

**DESCRIPTION**

FIG. 1 is a perspective view of an inflatable sprinkler pool showing my new design;  
FIG. 2 is another perspective view thereof;  
FIG. 3 is a front elevational view thereof;  
FIG. 4 is a rear elevational view thereof;  
FIG. 5 is a left side elevational view thereof;  
FIG. 6 is a right side elevational view thereof;  
FIG. 7 is a top plan view thereof;  
FIG. 8 is a bottom plan view thereof;  
FIG. 9 is an enlarged view of portion 9 shown in FIG. 1; and,  
FIG. 10 is an enlarged view of portion 10 shown in FIG. 3.

**1 Claim, 10 Drawing Sheets**

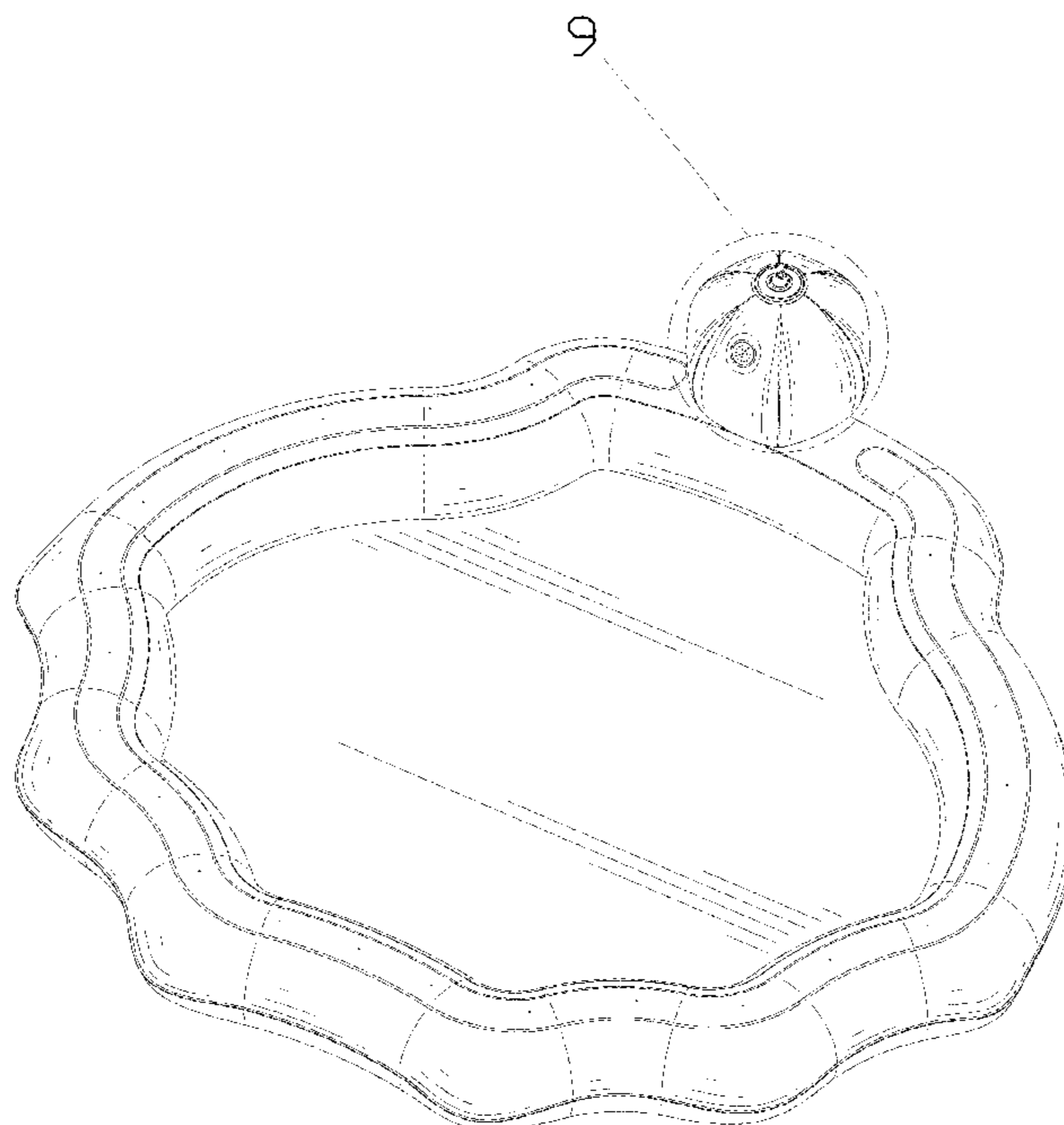

(56)

**References Cited**

## OTHER PUBLICATIONS

WOT | 3-in-1 Splash Pad Sprinkler for Kids, amazon.com, customer review oldest date Sep. 20, 2022 [online], [site visited Jan. 9, 2023], Available from internet, URL: <https://www.amazon.com/WOT-Sprinkler-Toddlers-Swimming-Backyard/dp/B0B4S39BCB> (Year: 2022).\*

Obo kids pool sprinkler splash pool, facebook.com, [online], [site visited Jan. 9, 2023], Available from internet, URL: <https://www.facebook.com/marketplace/item/855374225542648> (Year: 2023).\*

Wilbest Store 2022 Splash Pad Sprinkler, amazon.com, customer review oldest date Apr. 20, 2021 [online], [site visited Jan. 8, 2023], Available from internet, URL: <https://www.amazon.com/Splash-Outdoor-Sprinkler-Mermaid-Children/dp/B08Q7D3M5V> (Year: 2021).\*

Banzai Jr. Tidepool Discovery Sprinkling Mat, jcpenny.com, [online], [site visited Jan. 8, 2023], Available from internet, URL: <https://www.jcpenny.com/p/banzai-jr-tidepool-discovery-sprinkling-mat-18-months-up-pool-toy/ppr5008225672> (Year: 2023).\*

Inflatable Seashell Swimming Tool, walmart.com, [online], [site visited Jan. 8, 2023], Available from internet, URL: <https://www.walmart.com/ip/Inflatable-Seashell-Swimming-Tool-for-Adults-Shell-Pool-Pearl-Giant-Bed-Floating-Float-with-Row-Clam-Floating/1131161041> (Year: 2023).\*

Jasonwell Inflatable Pool Float Seashell, amazon.com, first available date Dec. 24, 2019 [online], [site visited Jan. 8, 2023], Available from internet, URL: <https://www.amazon.com/Jasonwell-Inflatable-Seashell-Seashell-Inflatables/dp/B0832DY9FD> (Year: 2019).\*

Swimline Seashell Island Extra Large Swimming Pool Float, amazon.com, first available date Jun. 9, 2019 [online], [site visited Jan. 8, 2023], Available from internet, URL: <https://www.amazon.com/Swimline-Seashell-Island-Extra-Swimming/dp/B0090S4NE2?th=1> (Year: 2019).\*

Kids (and Adults) Will Enjoy This \$27 Splash Pad, [online], wideopencountry.com, Jun. 23, 2021 [retrieved on Jan. 8, 2023]. Retrieved from the Internet, URL <<https://www.wideopencountry.com/best-splash-pad/>> (Year: 2021).\*

CestMall Inflatable Water Ball, amazon.com, first available date May 11, 2020 [online], [site visited Jan. 9, 2023], Available from internet, URL: <https://www.amazon.co.uk/CestMall-Inflatable-Rainbow-Sprinkler-Balloon/dp/B088GT3FGJ> (Year: 2020).\*

Swimline 24" Inflatable Classic Swimming Pool Beach Ball Toy, target.com, [online], [site visited Jan. 9, 2023], Available from internet, URL: <https://www.target.com/p/swimline-24-inflatable-classic-swimming-pool-beach-ball-toy-vibrantly-colored/-/A-76413289> (Year: 2023).\*

\* cited by examiner

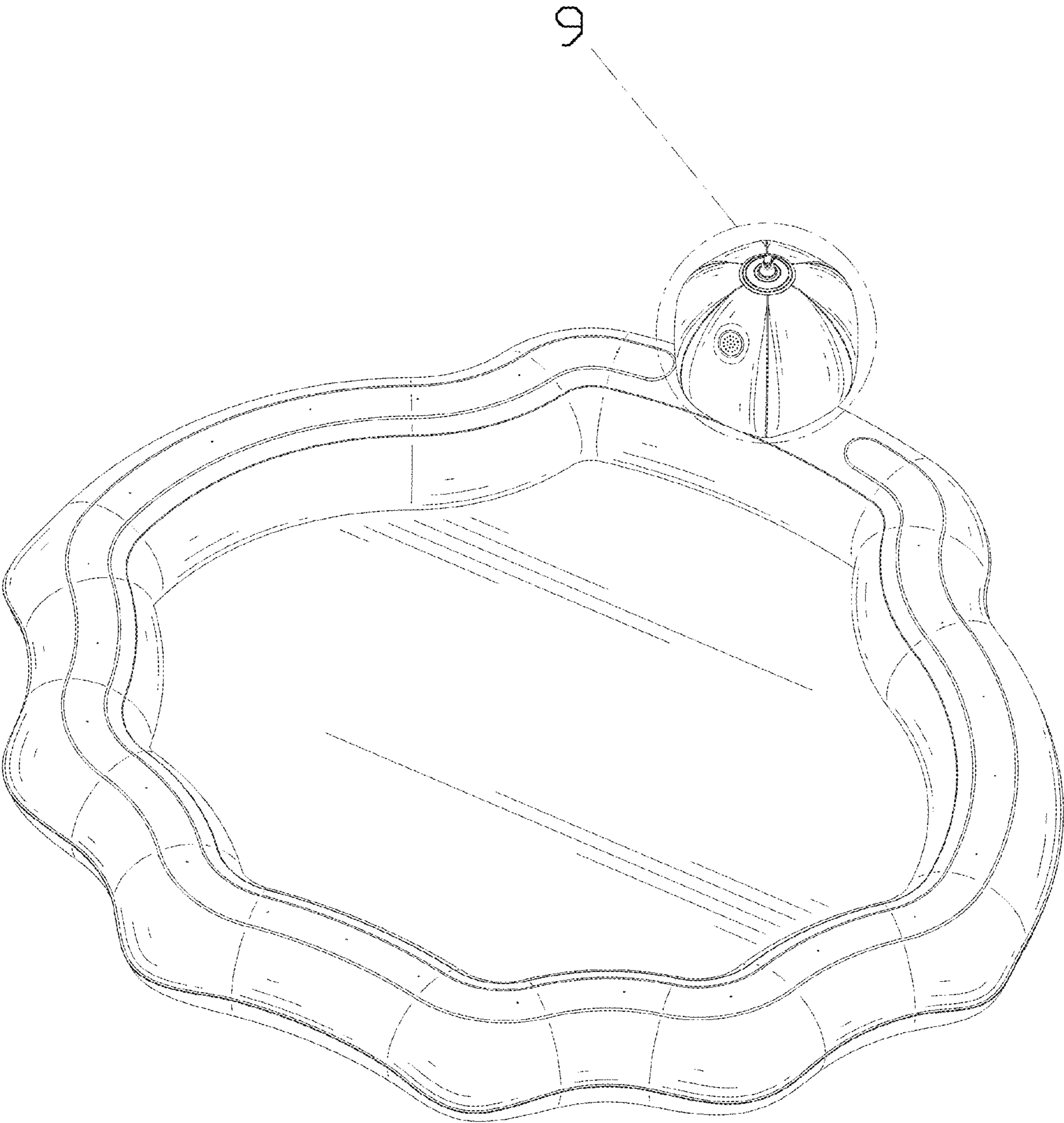

FIG. 1



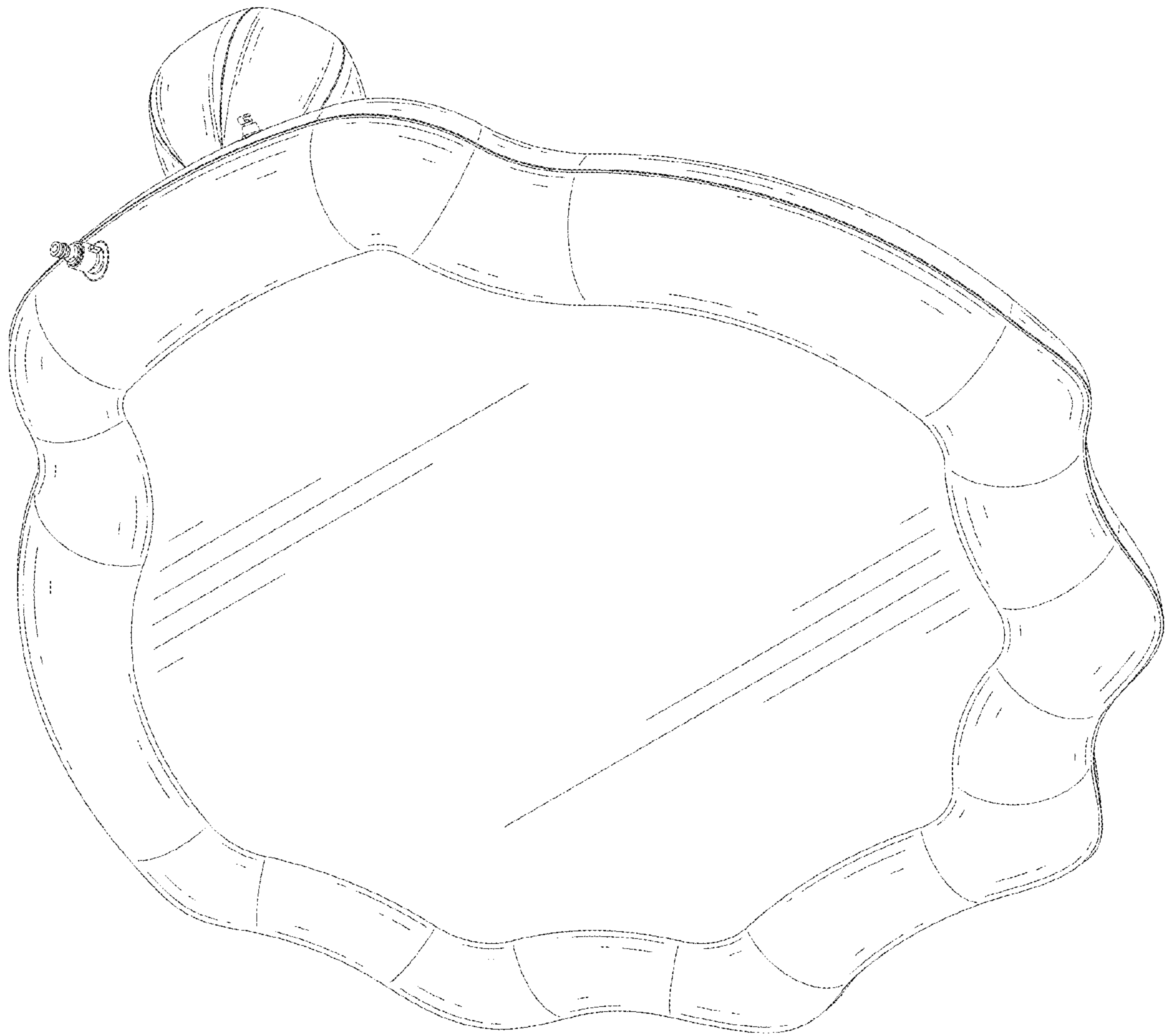

FIG. 2

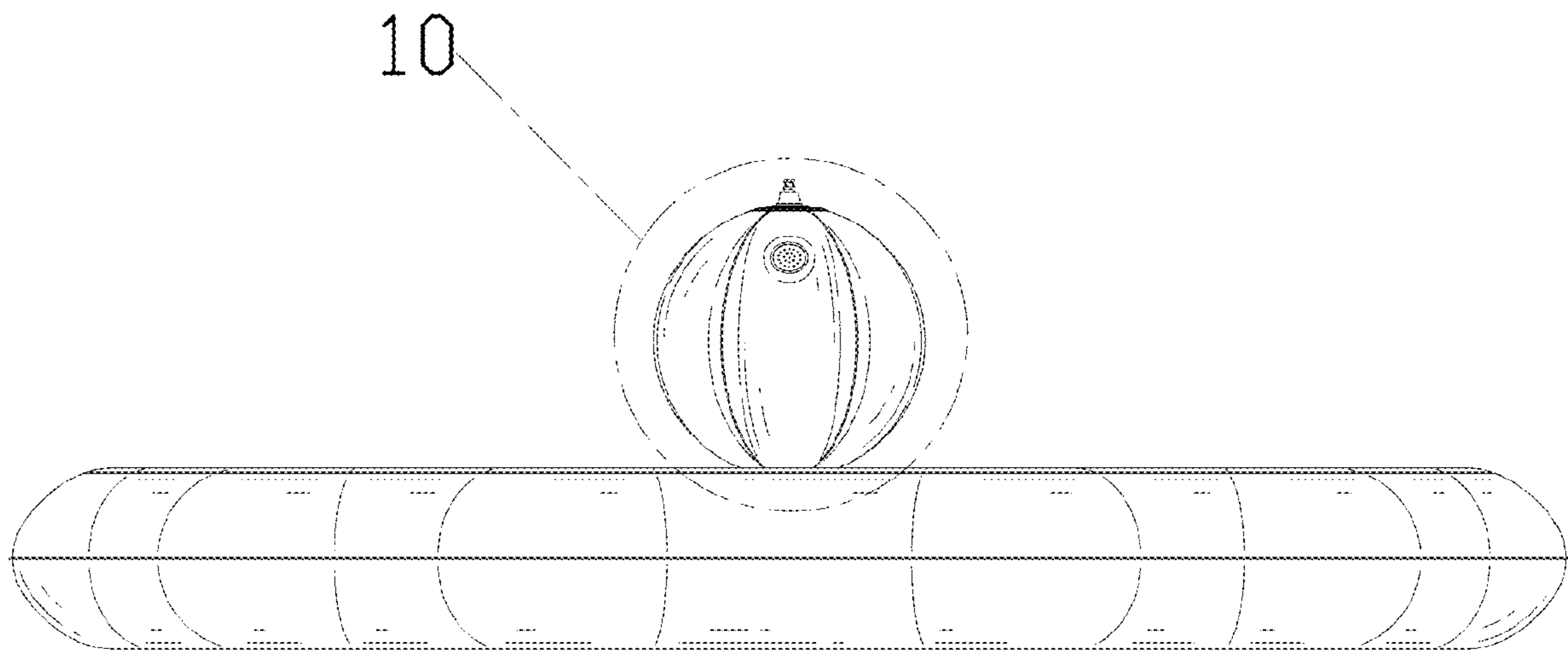

FIG. 3

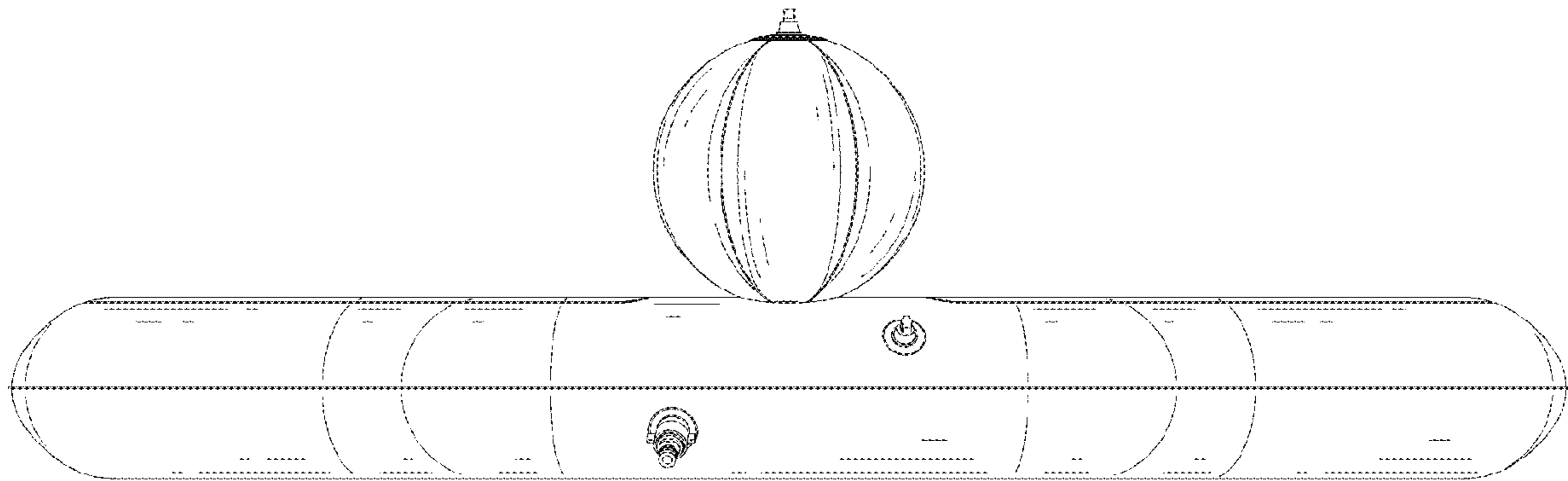

FIG. 4

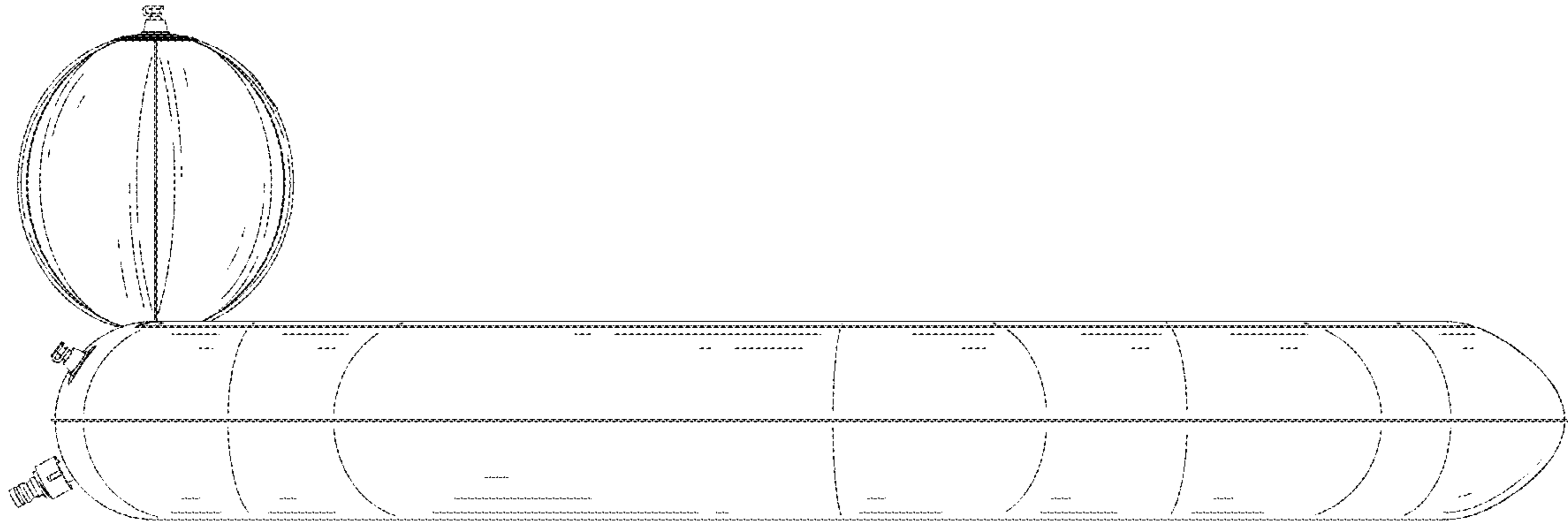

FIG. 5

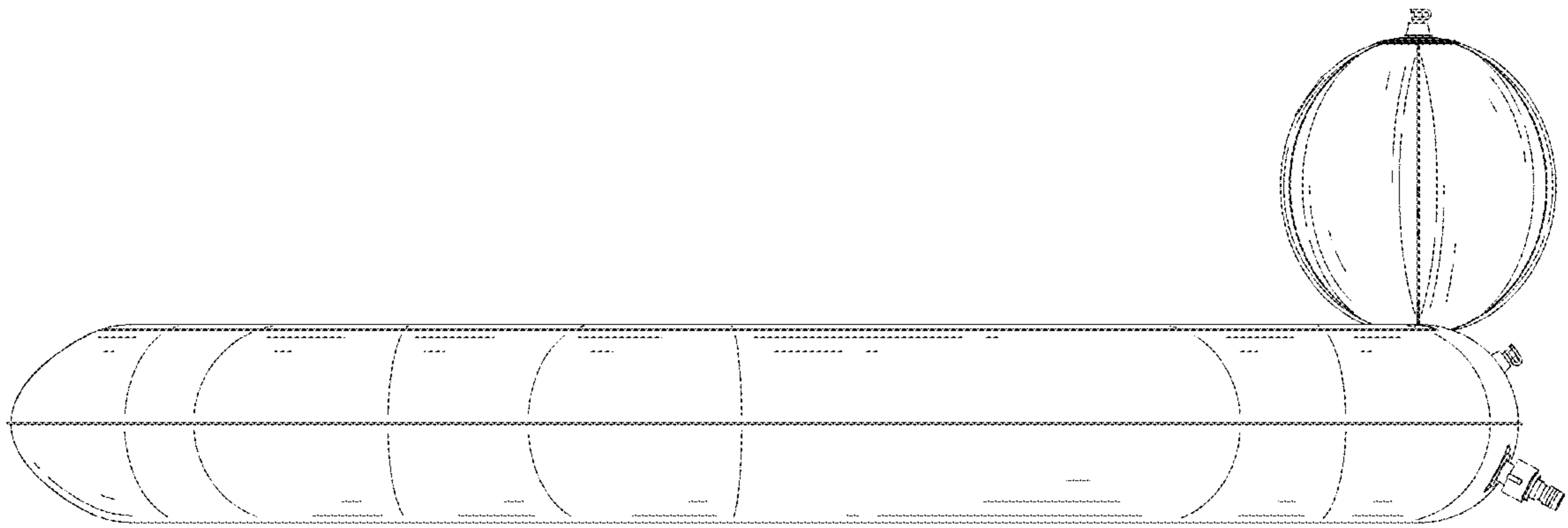

FIG. 6



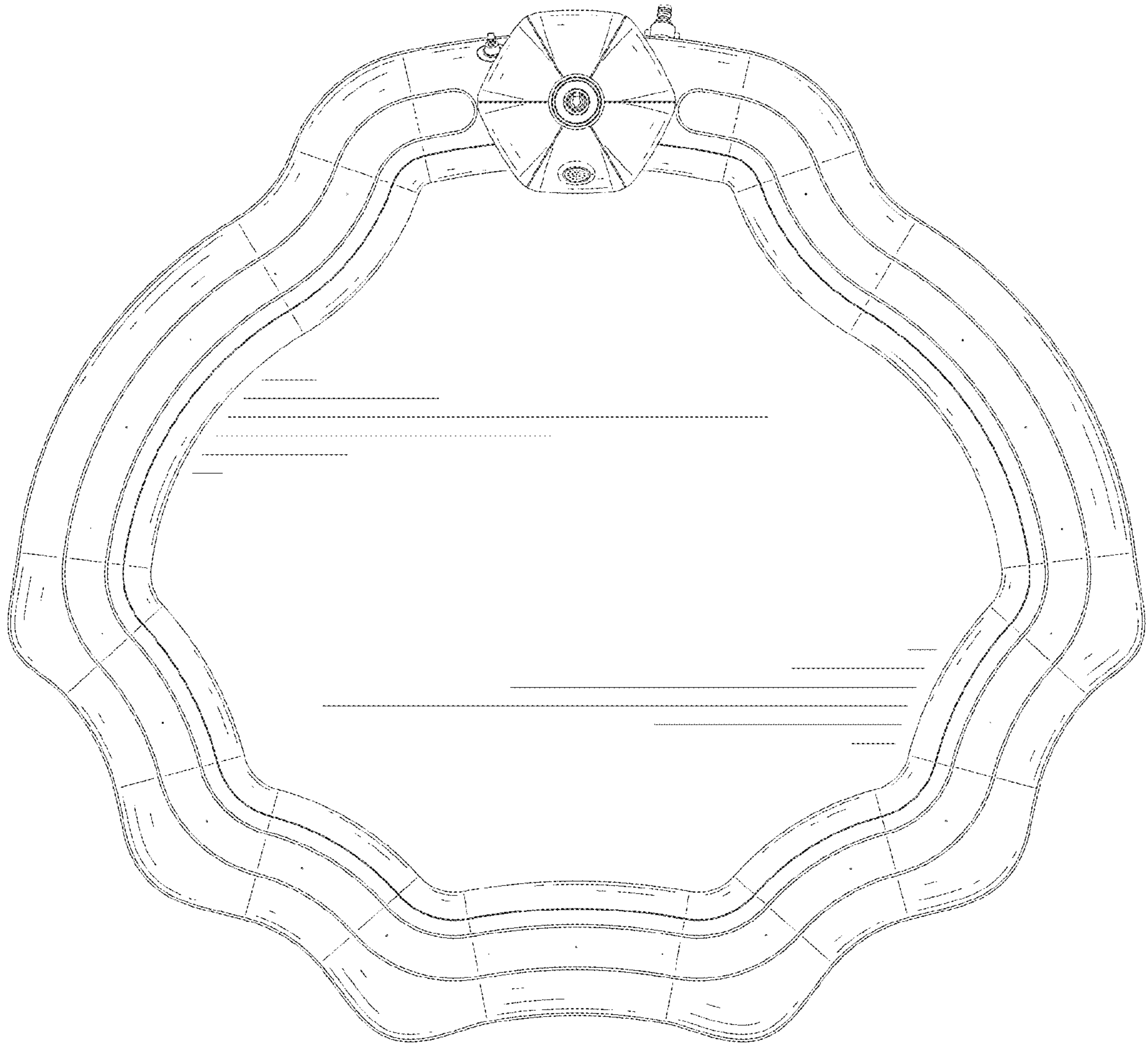

FIG. 7

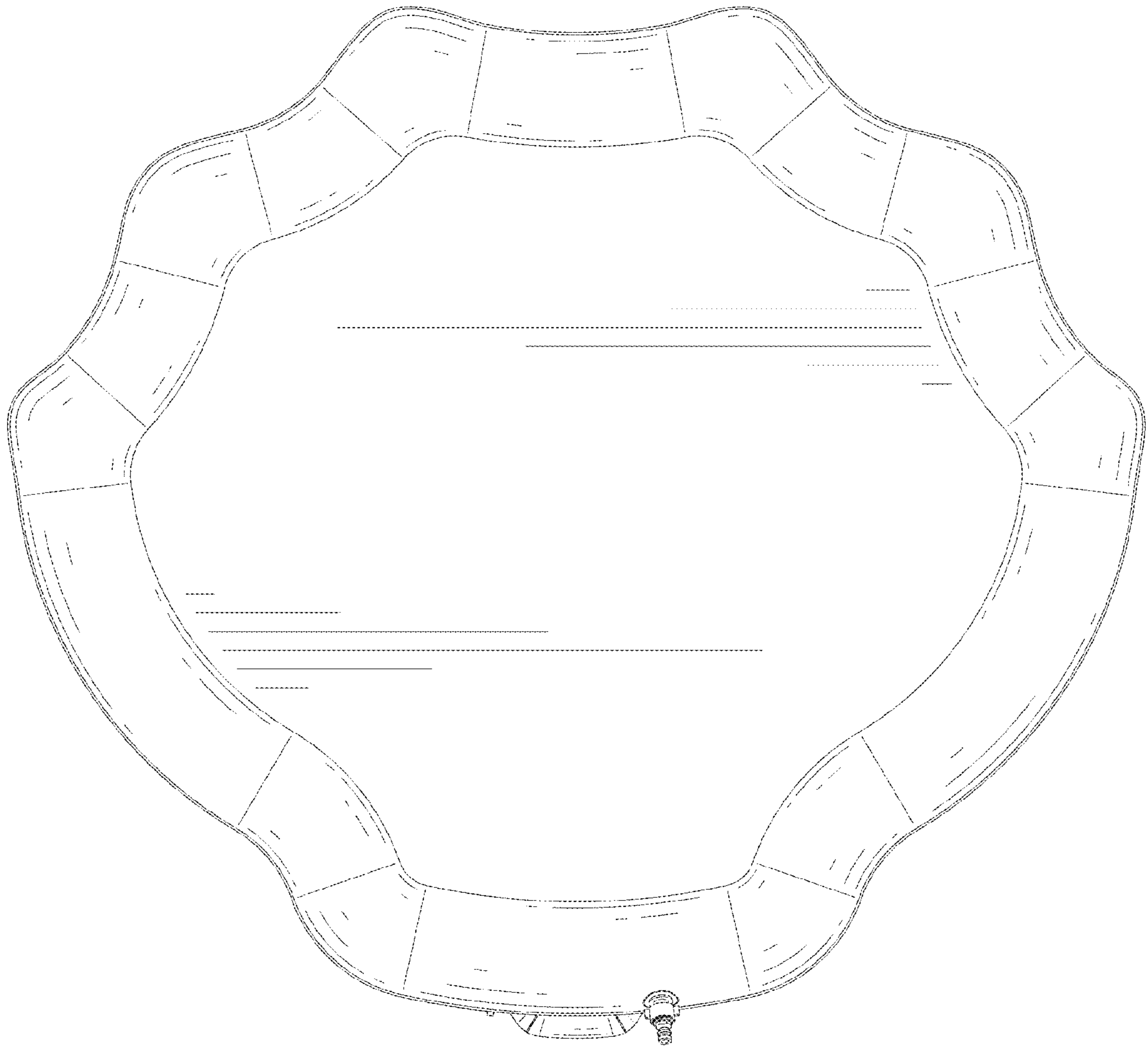

FIG. 8

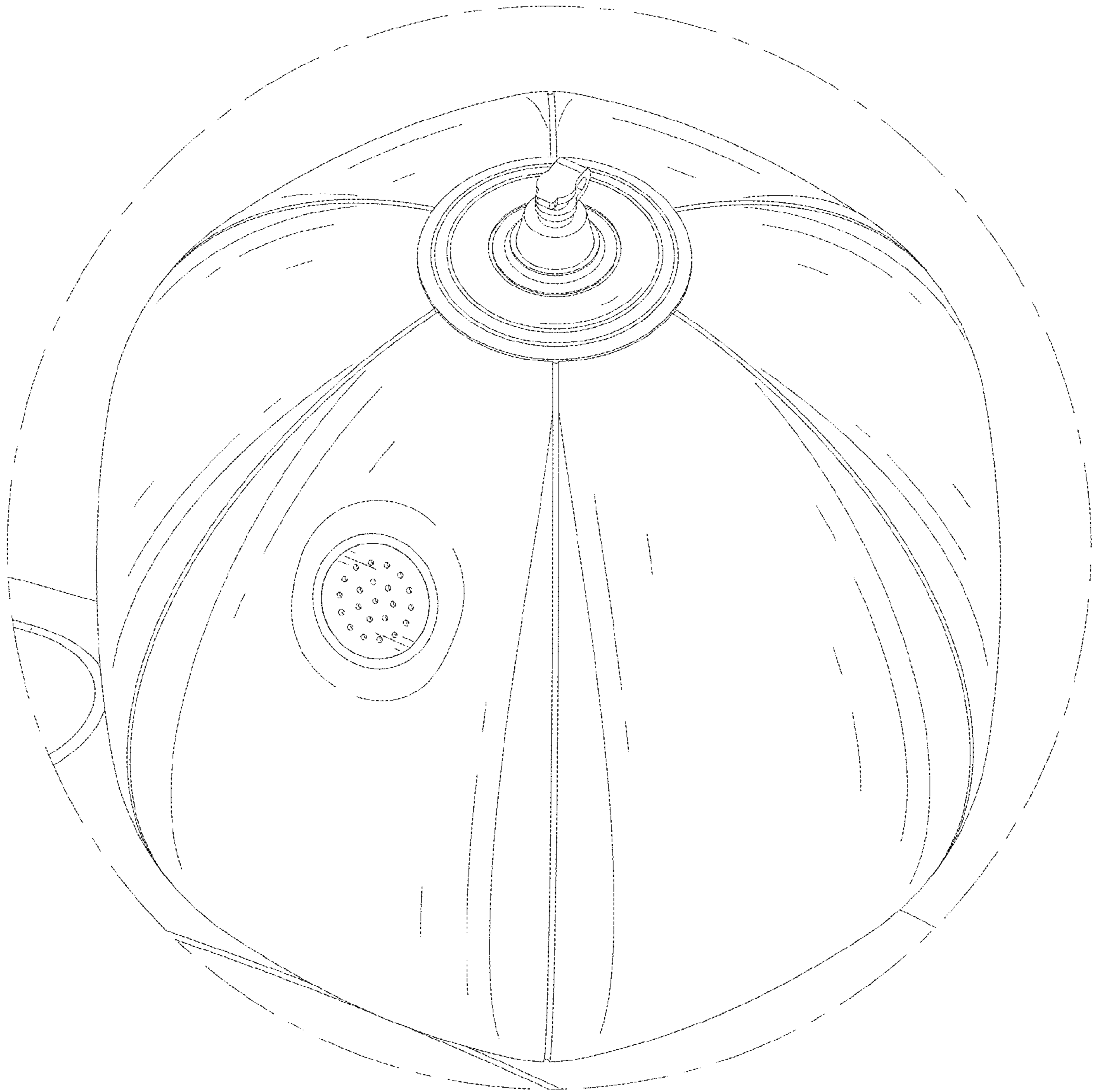

FIG. 9

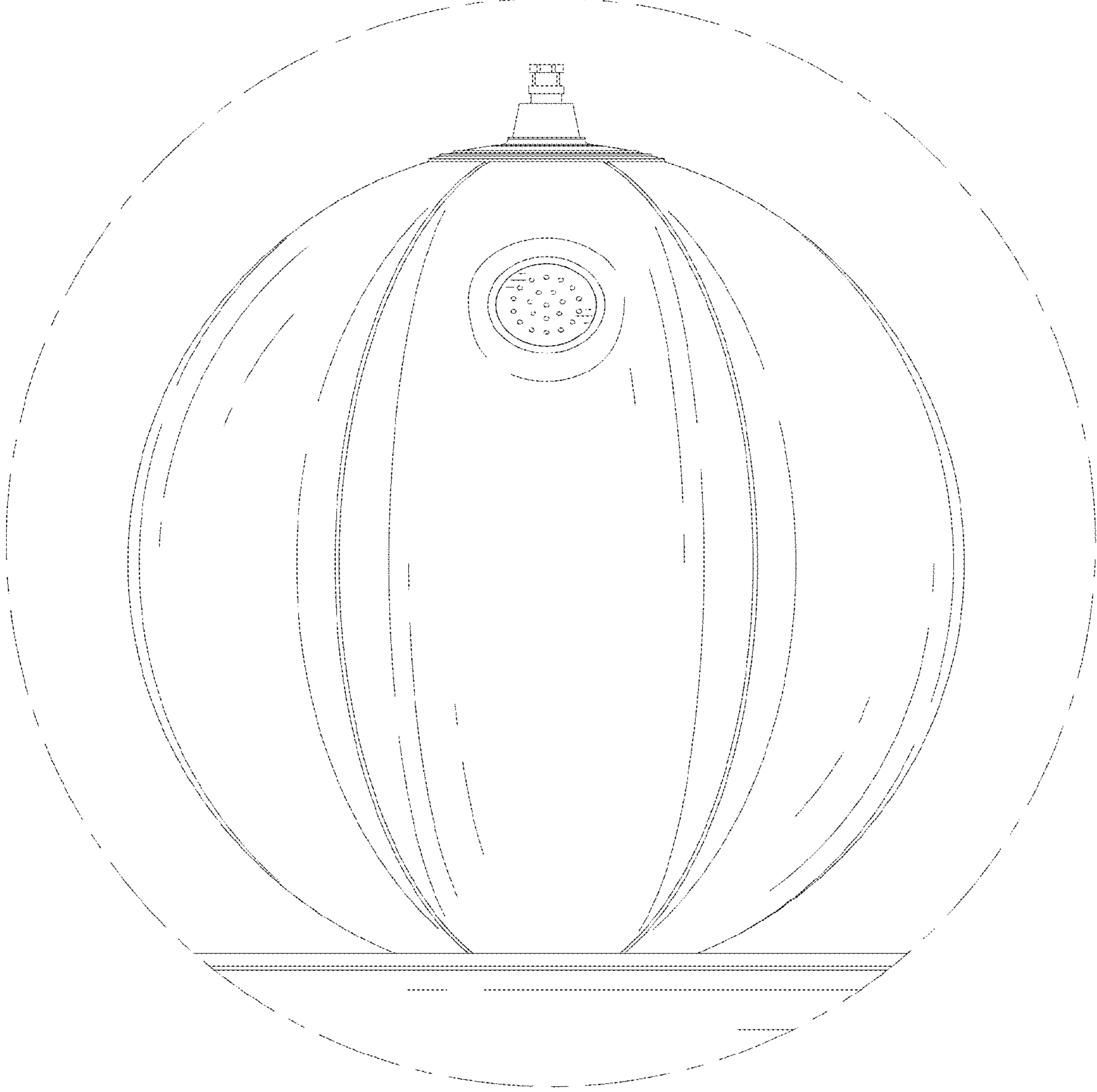

FIG. 10