



US00D989823S

(12) **United States Design Patent**
Morris et al.

(10) **Patent No.:** **US D989,823 S**
(45) **Date of Patent:** **** Jun. 20, 2023**

(54) **ICE PACK**

FOREIGN PATENT DOCUMENTS

(71) Applicant: **YETI Coolers, LLC**, Austin, TX (US)

CA 172680 S 12/2017
CN 305119716 S 4/2019

(72) Inventors: **Liza Morris**, Austin, TX (US); **Max Burtner**, Austin, TX (US)

(Continued)

(73) Assignee: **YETI Coolers, LLC**, Austin, TX (US)

OTHER PUBLICATIONS

(**) Term: **15 Years**

Feb. 22, 2022—(JP) Office Action—App. No. 2021-026388.

(21) Appl. No.: **29/787,011**

(Continued)

(22) Filed: **Jun. 3, 2021**

Primary Examiner — Khawaja Anwar

(51) **LOC (14) Cl.** **15-07**

(74) *Attorney, Agent, or Firm* — Banner & Witcoff, Ltd.

(52) **U.S. Cl.**

(57) **CLAIM**

USPC **D15/90**

The ornamental design for an ice pack, as shown and described.

(58) **Field of Classification Search**

DESCRIPTION

USPC D15/79–91
CPC .. F25D 3/08; F25D 11/006; F25D 2303/0845;
F25D 11/003; F25D 11/025; F25D 16/00;
F25D 17/042; F25D 2303/0822; F25D
2303/0832; F25D 2303/0841; F25D
2303/0843; F25D 2303/0844; F25D
2317/043; F25D 2331/803; F25D
2331/804; F25D 2331/805; F25D
2331/808; F25D 2331/809; F25D
2331/81; F25D 23/00; F25D 23/06; F25D
23/12; F25D 2400/10; F25D 2400/16;
F25D 2400/38; F25D 25/025; F25D
31/008; F25D 3/06

FIG. 1 is a front perspective view of an ice pack showing our new design;
FIG. 2 is a top view thereof;
FIG. 3 is a bottom view thereof;
FIG. 4 is a right side view thereof;
FIG. 5 is a left side view thereof;
FIG. 6 is a front view thereof;
FIG. 7 is a rear view thereof;
FIG. 8 is a front perspective view of a second embodiment of an ice pack showing our new design;
FIG. 9 is a top view thereof;
FIG. 10 is a bottom view thereof;
FIG. 11 is a right side view thereof;
FIG. 12 is a left side view thereof;
FIG. 13 is a front view thereof; and,
FIG. 14 is a rear view thereof.

See application file for complete search history.

The uneven-length broken lines immediately adjacent to the shaded area represent the bounds of the claimed design and form no part thereof. The even-length broken lines depicting the remainder of the ice pack form no part of the claimed design.

(56) **References Cited**

U.S. PATENT DOCUMENTS

4,656,840 A 4/1987 Loofbourrow et al.
D473,572 S * 4/2003 Linberg D15/90
D520,534 S 5/2006 Nicholson
D537,851 S 3/2007 Mount
D538,309 S 3/2007 Mount

(Continued)

1 Claim, 10 Drawing Sheets

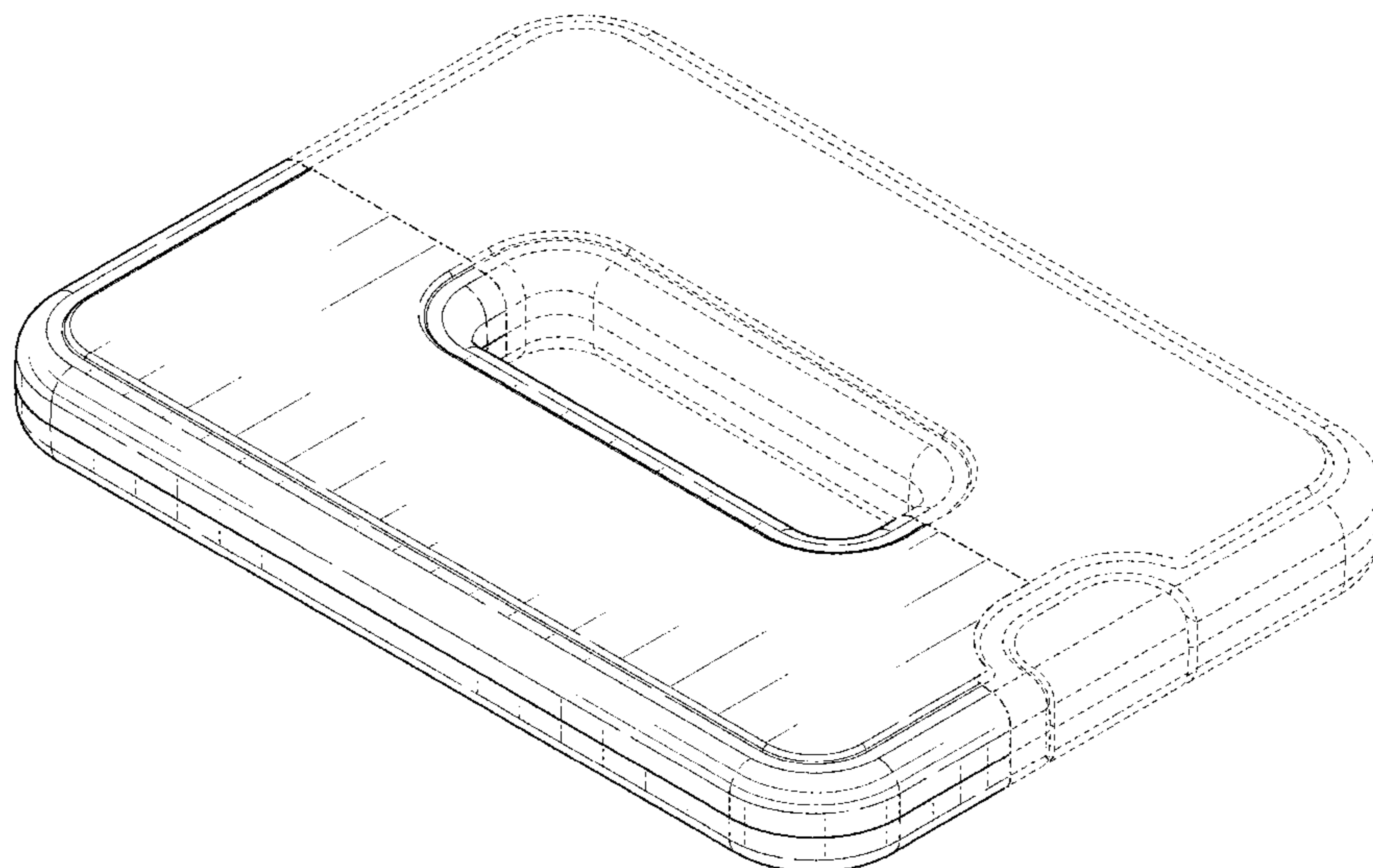

(56)

References Cited

U.S. PATENT DOCUMENTS

D700,637	S	3/2014	Maggioni	
D711,439	S *	8/2014	Garg	D15/90
D711,945	S	8/2014	Garg	
D712,442	S	9/2014	Garg	
D714,438	S	9/2014	Quaye	
D714,439	S	9/2014	Huang	
D733,195	S	6/2015	Lum	
D741,919	S *	10/2015	Seiders	D15/90
D741,920	S *	10/2015	Seiders	D15/90
D746,343	S *	12/2015	Mount	D15/90
D791,201	S *	7/2017	Kim	D15/90
D803,066	S *	11/2017	Rudolf	D9/569
D804,543	S *	12/2017	Carvajal	D15/90
D847,221	S	4/2019	Coulombe et al.	
D851,691	S	6/2019	Dai	
D905,131	S *	12/2020	Dai	D15/90
D907,506	S *	1/2021	Xoy	D9/542
D908,010	S *	1/2021	Demarest	D9/542
D911,845	S *	3/2021	Huang	D3/202
D914,068	S *	3/2021	Chen	D15/90
D923,480	S *	6/2021	Xoy	D9/542
D923,481	S *	6/2021	Demarest	D9/542

FOREIGN PATENT DOCUMENTS

DK	9014717	U1	4/1991
EM	000766738-0004		8/2007
EM	000766738-0027		8/2007
EM	000766738-0035		8/2007
EP	0765819	B1	7/2002
IN	264760-0001		3/2015
IN	265855-0001		7/2015
IN	265856-0001		7/2015
IN	284119-0001		6/2017
JP	D1505230		8/2014
JP	D1643485		10/2019
JP	D1643486		10/2019
JP	D1643487		10/2019
KR	300597188.0000		4/2011
KR	20120007666	A	1/2012
KR	301006148.0000		5/2019
KR	301021543.0000		9/2019
MY	13-152-0101-0001		3/2014
SG	2011596J-0001		6/2011
WO	12117575	A1	9/2012
WO	D091314-001		7/2016

OTHER PUBLICATIONS

Mar. 15, 2022—(JP) Office Action—App. No. 2021-026391.
 Mar. 15, 2022—(JP) Office Action—App. No. 2021-026390.
 Mar. 15, 2022—(JP) Office Action—App. No. 2021.026387.
 Mar. 15, 2022—(JP) Office Action—App. No. 2021-026389.
 Amazon.com, Inc., “Yeti Thin Ice Refreezable Reusable Cooler Ice Pack”, published May 6, 2021, retrieved from <<https://www.amazon.com/YETI-Thin-Refreezable-Reusable-Cooler/dp/B08ZQ8V133?th=1&psc=1>>, Apr. 20, 2022, 6 pgs.
 “Hydro Flask Unbound Ice Pack”; Hydro Flask; retrieved Jun. 3, 2021; disclosure date unknown but prior to the filing date of the present application; URL:<<https://www.rei.com/product/134143/hydro-flask-unbound-ice-pack>>.
 “Healthy Packers Blue Gel Slim Long-Lasting Ice Packs for Lunch Box or Cooler Bag (4, 6, 8, or 10 pack)”; “Healthy Packers”; retrieved Jun. 3, 2021; disclosure date unknown but prior to the filing date of the present application; URL: <<https://healthypackers.com/products/cool-pack-slim-long-lasting-ice-packs-great-for-coolers-or-lunch-box>>.
 “Cooling Cold Plate Cooler Brick for Frozen Food”; Jisill; retrieved Jun. 3, 2021; disclosure date unknown but prior to the filing date of the present application; URL:<<https://www.cooler-boxs.com/big-large-ice-pack/57402134.html>>.
 “Plastic Eutectic Plate Reusable Gel Ice Pack Cooler”; Jisill; retrieved Jun. 3, 2021; disclosure date unknown but prior to the filing date of the present application; URL: <<https://www.cooler-boxs.com/big-large-ice-pack/57165589.html>>.
 “1600ml large cooling eutectic freezer can ice pack”; Jisill; retrieved Jun. 3, 2021; disclosure date unknown but prior to the filing date of the present application; URL:<<https://www.cooler-boxs.com/big-large-ice-pack/57165077.html>>.
 “Large high quality nontoxic cold plate ice pack”; Jisill; retrieved Jun. 3, 2021; disclosure date unknown but prior to the filing date of the present application; URL: <<https://www.cooler-boxs.com/big-large-ice-pack/57165060.html>>.
 “Top 5 Best Ice Packs for Coolers and How to Maximize Ice Retention”; Best Cooler; retrieved Jun. 3, 2021; disclosure date unknown but prior to the filing date of the present application; URL: <<https://bestcooler.reviews/best-ice-packs-for-coolers-reviews/>>.
 “Ice Pack”; Hydro Flask; retrieved Jun. 3, 2021; disclosure date unknown but prior to the filing date of the present application; URL: <<https://www.hydroflask.com/ice-pack?color=pacific>>.

* cited by examiner

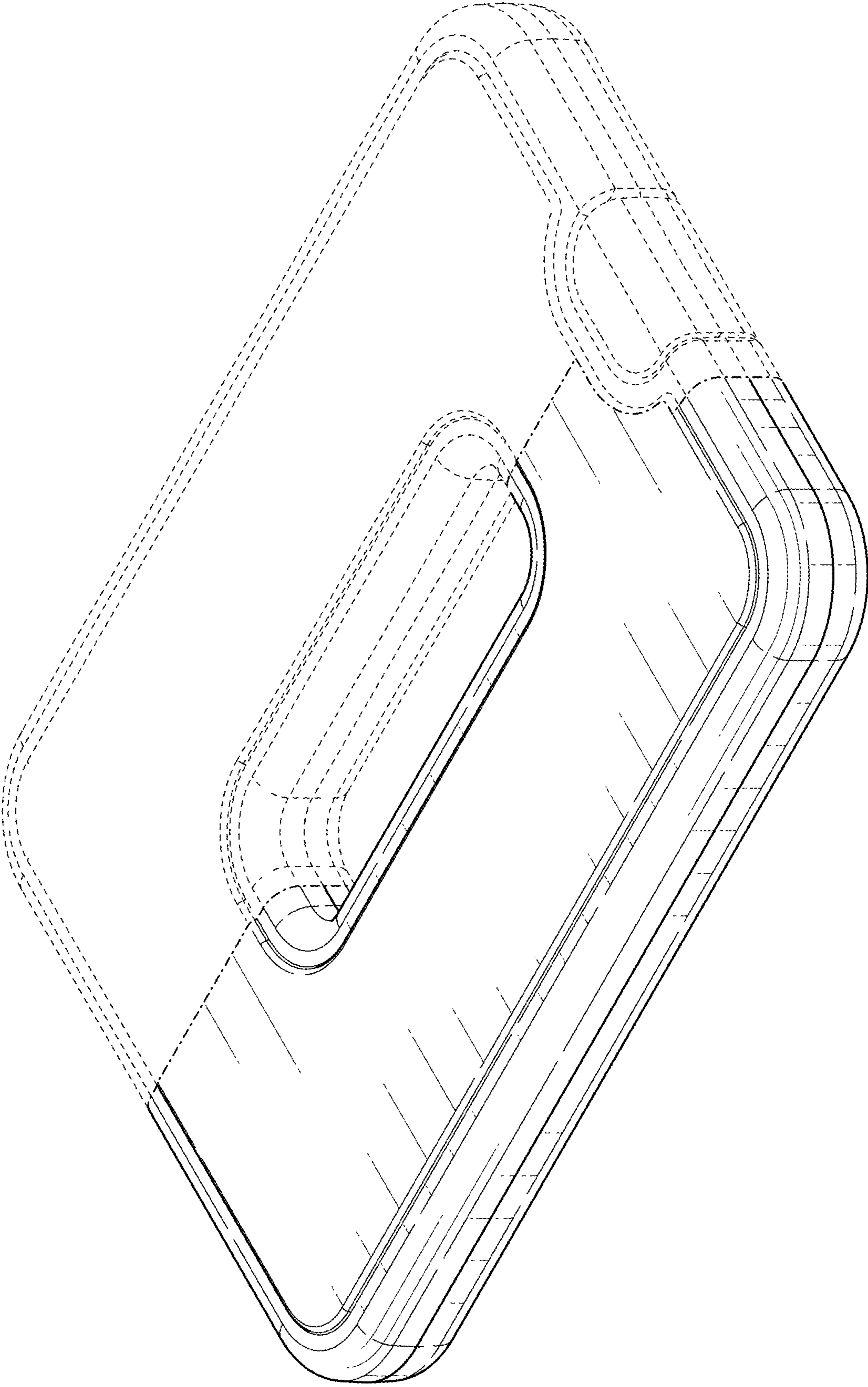

FIG. 1

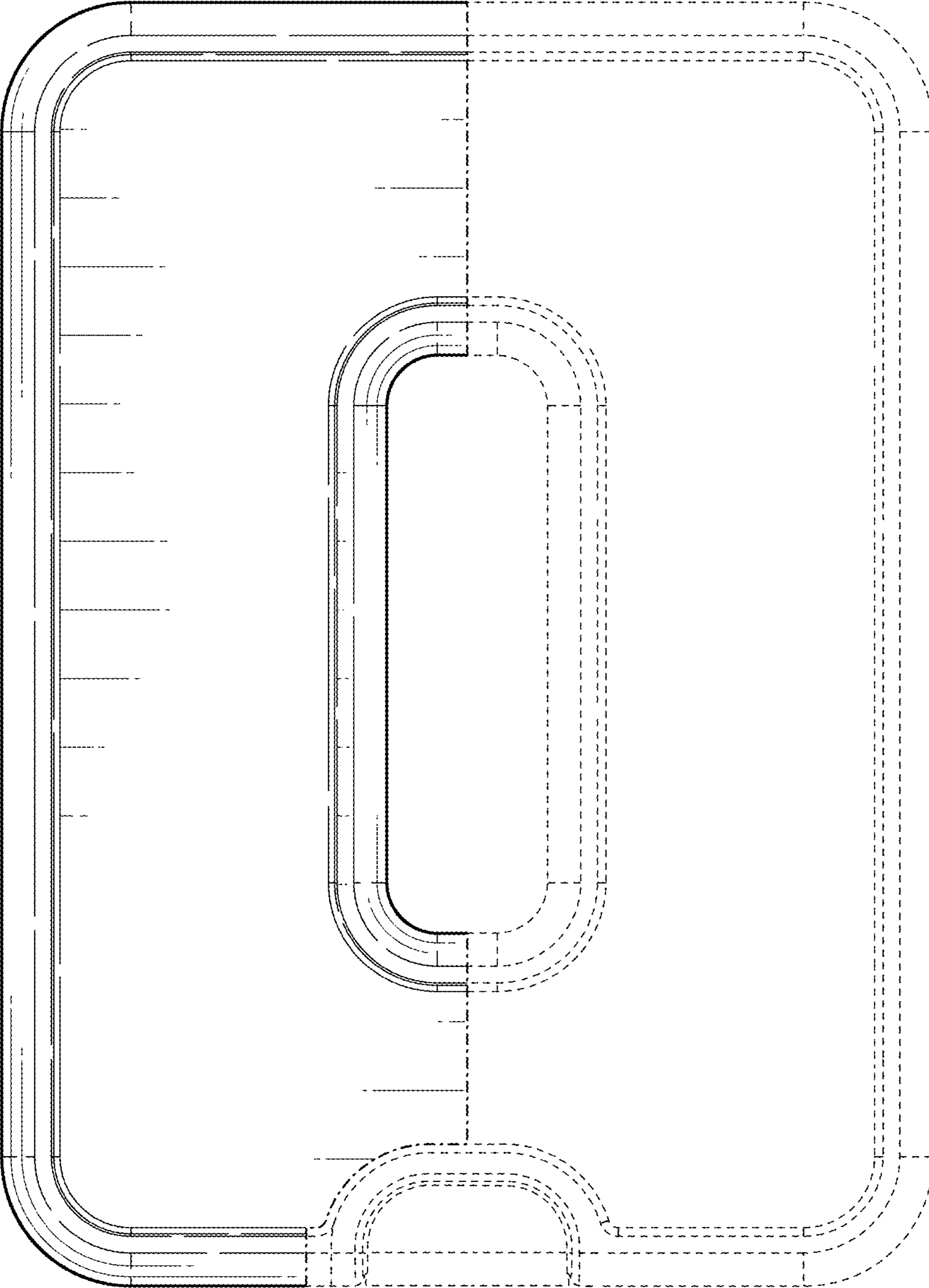

FIG. 2

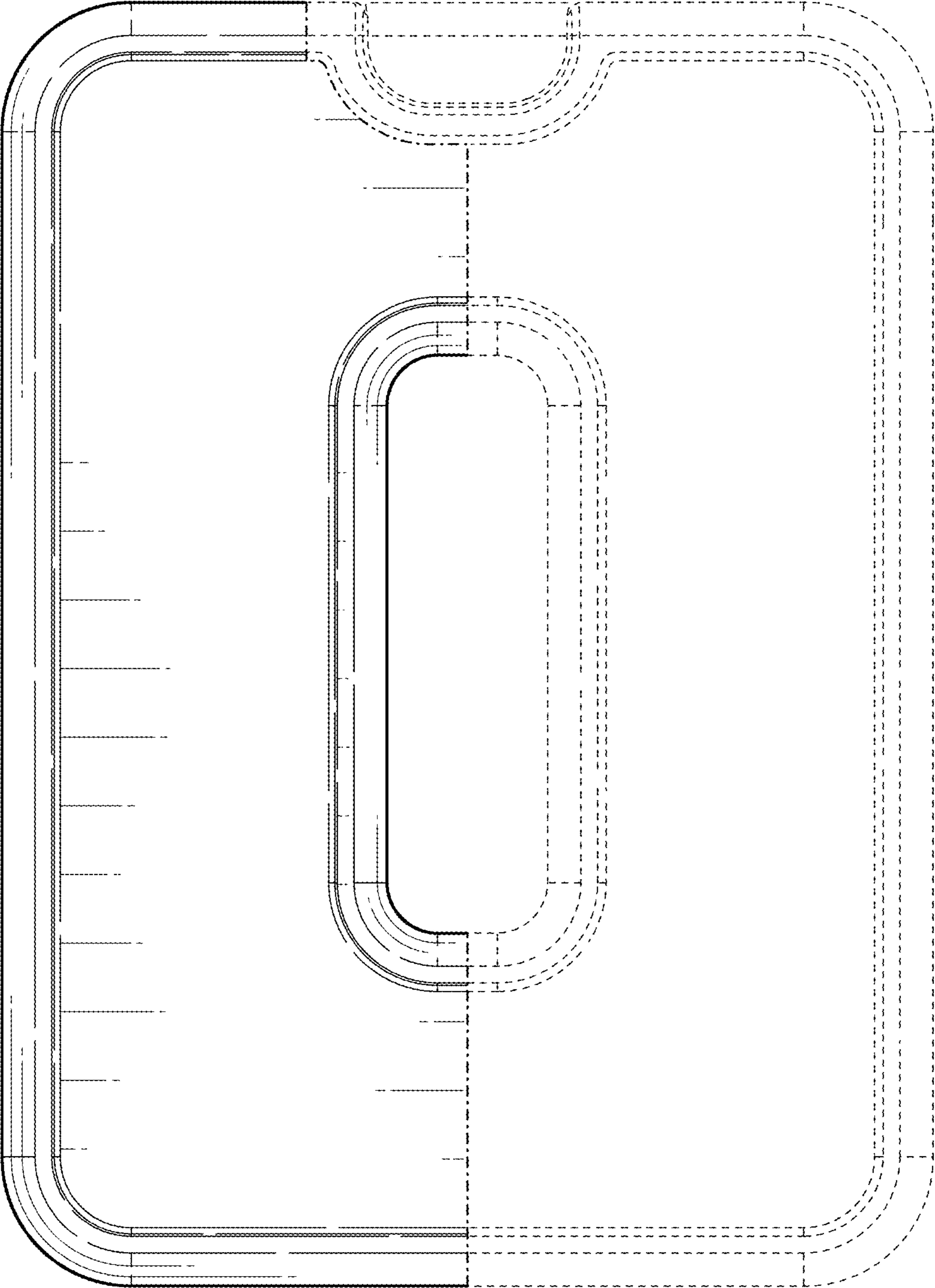

FIG. 3

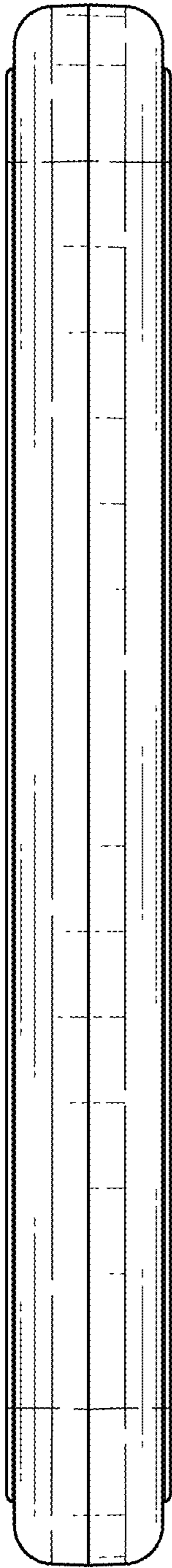

FIG. 4

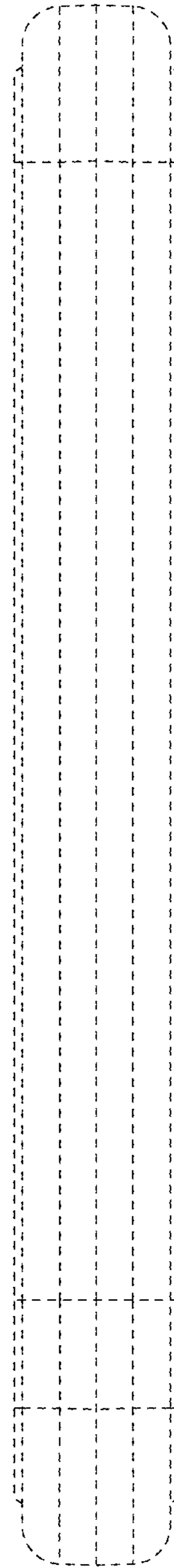

FIG. 5

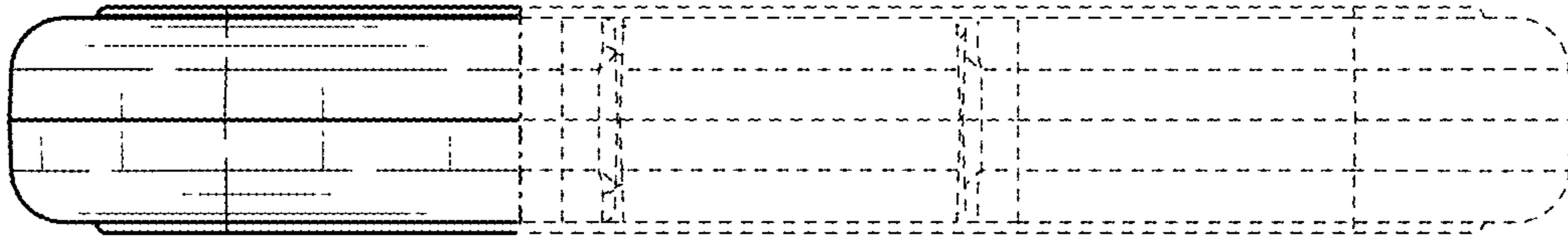

FIG. 6

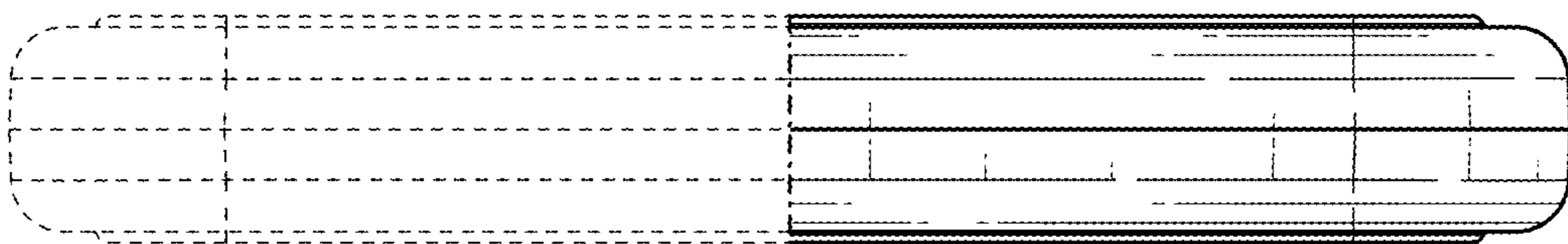

FIG. 7

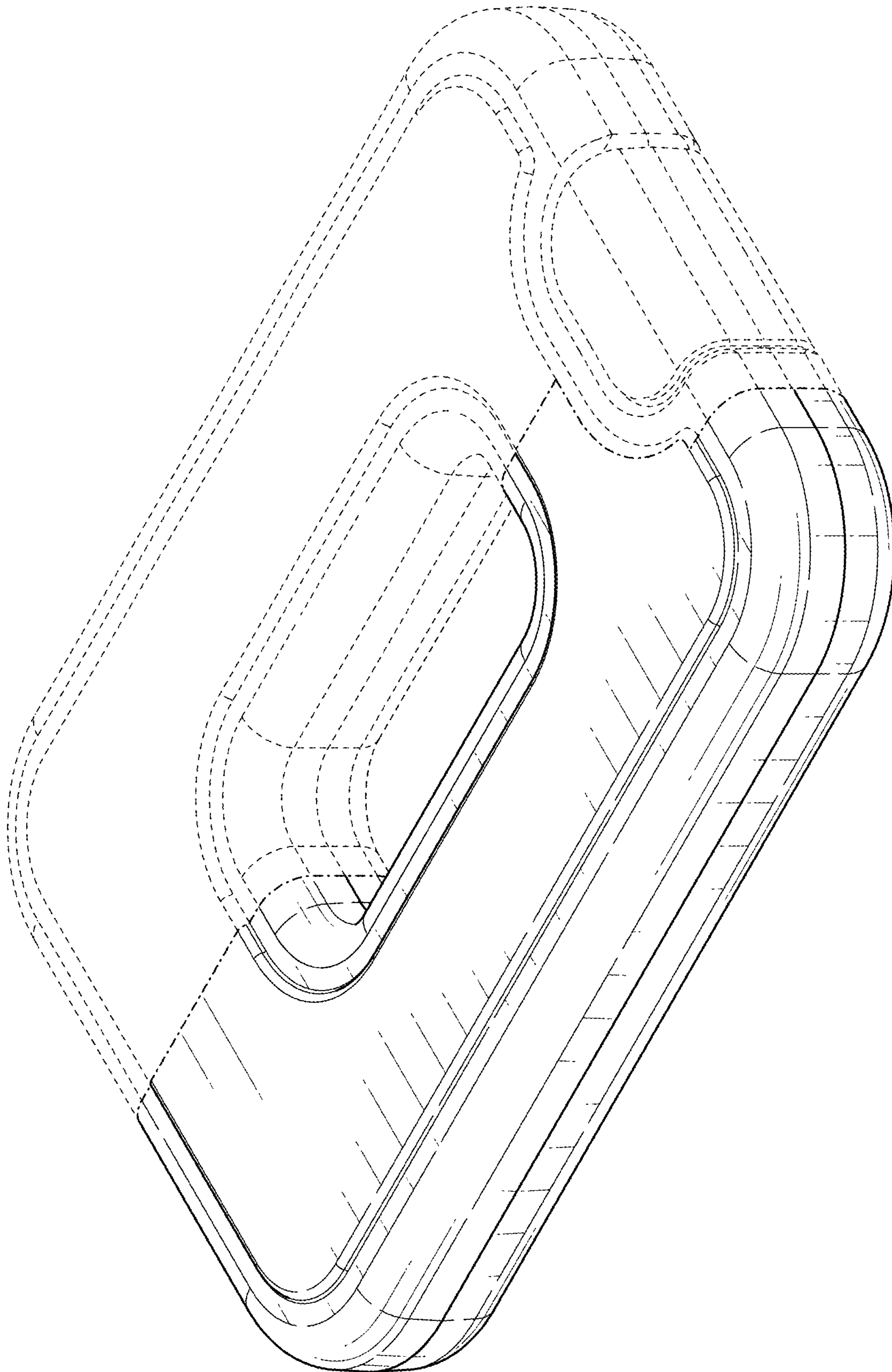

FIG. 8

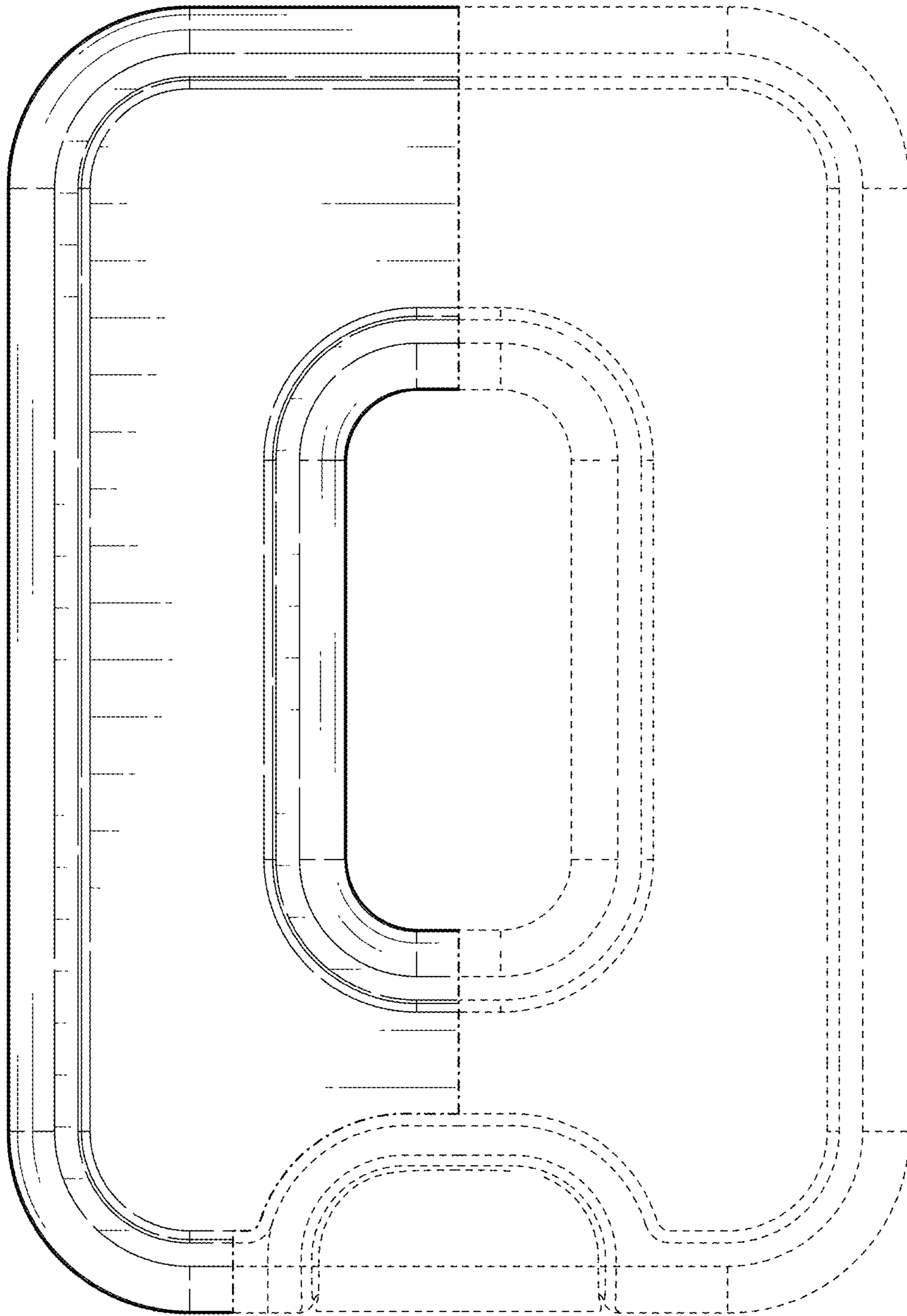

FIG. 9

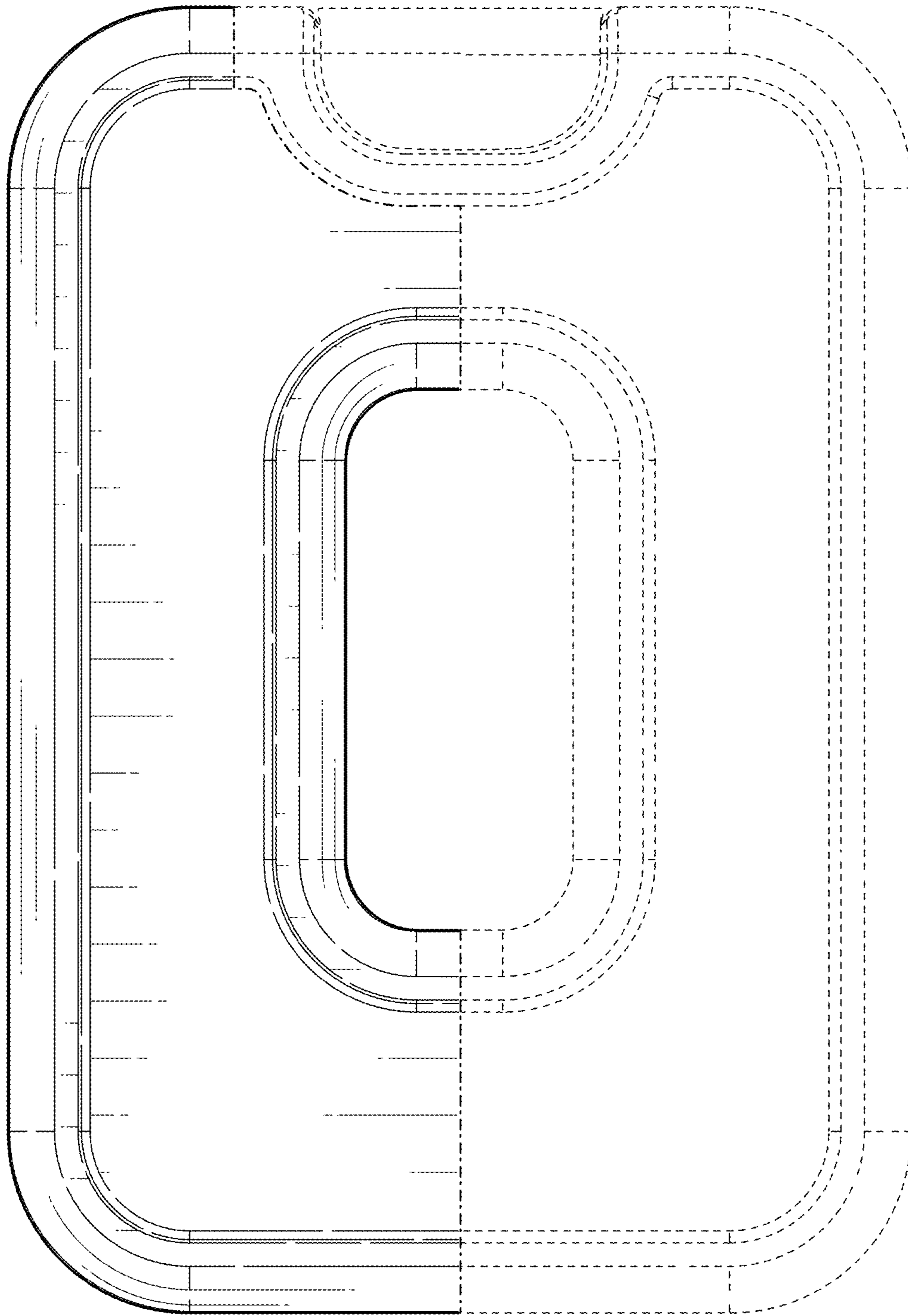

FIG. 10

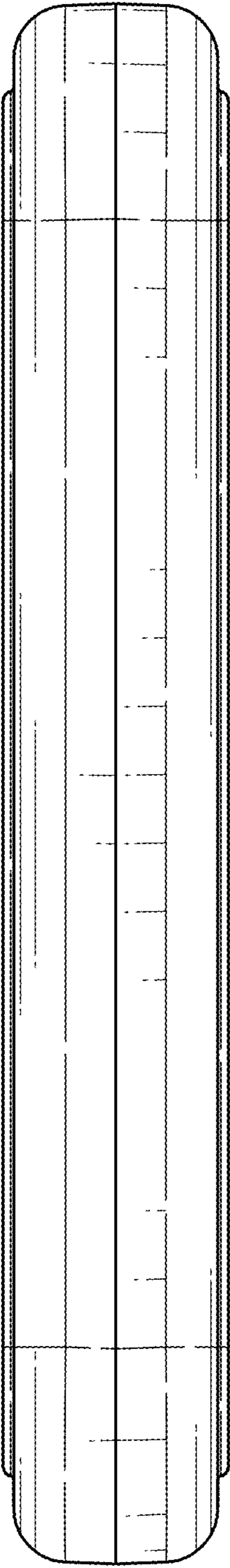

FIG. 11

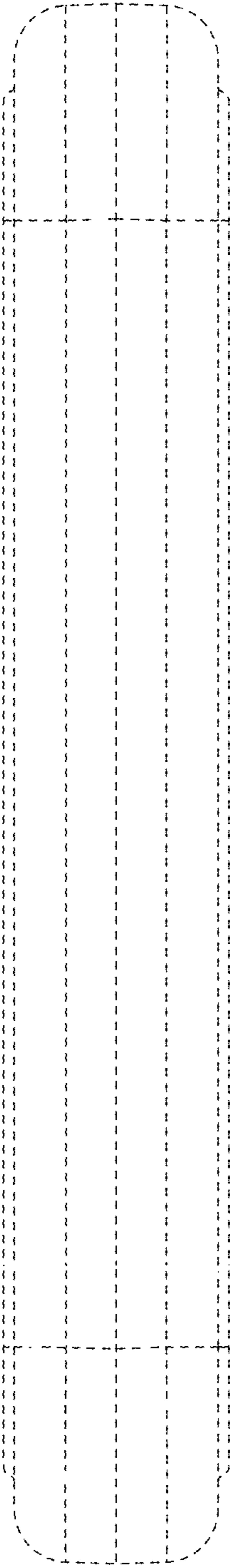

FIG. 12

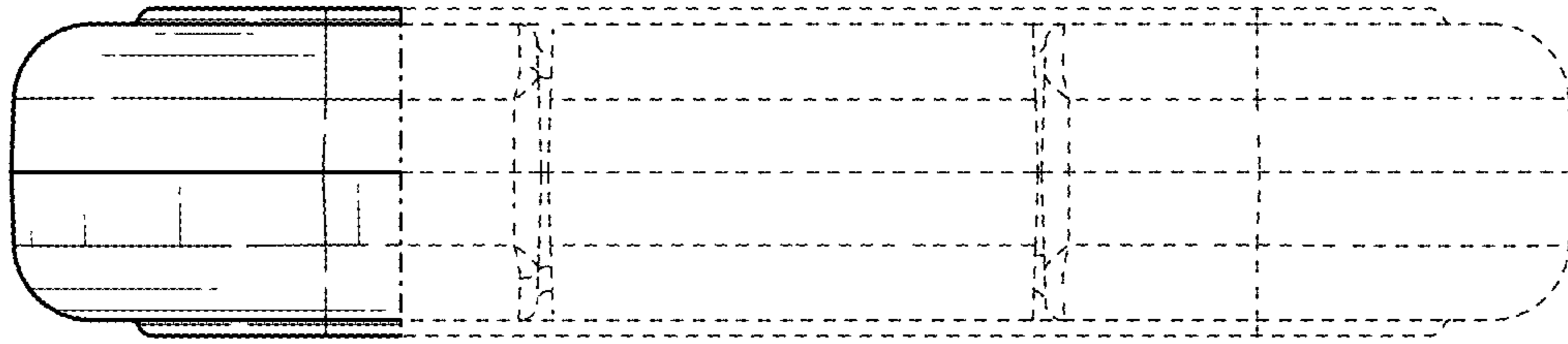

FIG. 13

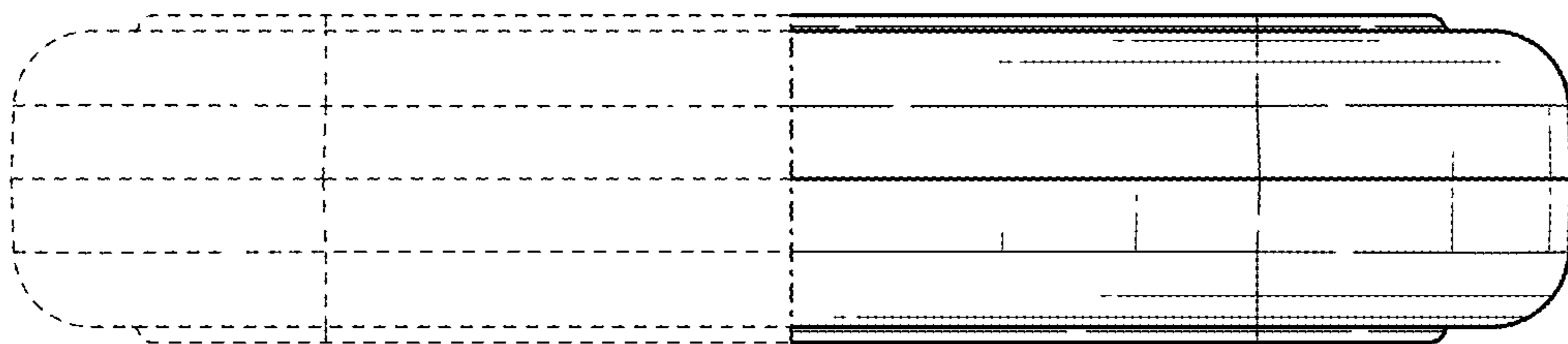

FIG. 14