



US00D989821S

(12) **United States Design Patent**
Morris et al.

(10) **Patent No.:** **US D989,821 S**
(45) **Date of Patent:** **** Jun. 20, 2023**

(54) **ICE PACK**

(71) Applicant: **YETI Coolers, LLC**, Austin, TX (US)

(72) Inventors: **Liza Morris**, Austin, TX (US); **Max Burtner**, Austin, TX (US)

(73) Assignee: **YETI Coolers, LLC**, Austin, TX (US)

(**) Term: **15 Years**

(21) Appl. No.: **29/787,002**

(22) Filed: **Jun. 3, 2021**

(51) **LOC (14) Cl.** **15-07**

(52) **U.S. Cl.**
USPC **D15/90**

(58) **Field of Classification Search**
USPC D15/79-91

CPC .. F25D 3/08; F25D 11/006; F25D 2303/0845;
F25D 11/003; F25D 11/025; F25D 16/00;
F25D 17/042; F25D 2303/0822; F25D
2303/0832; F25D 2303/0841; F25D
2303/0843; F25D 2303/0844; F25D
2317/043; F25D 2331/803; F25D
2331/804; F25D 2331/805; F25D
2331/808; F25D 2331/809; F25D
2331/81; F25D 23/00; F25D 23/06; F25D
23/12; F25D 2400/10; F25D 2400/16;
F25D 2400/38; F25D 25/025; F25D
31/008; F25D 3/06

See application file for complete search history.

(56) **References Cited**

U.S. PATENT DOCUMENTS

4,656,840 A 4/1987 Loofbourrow et al.
D473,572 S * 4/2003 Linberg D15/90
(Continued)

FOREIGN PATENT DOCUMENTS

CA 172680 S 12/2017
CN 305119716 S 4/2019
(Continued)

OTHER PUBLICATIONS

“Hydro Flask Unbound Ice Pack”; Hydro Flask; retrieved Jun. 3, 2021; disclosure date unknown but prior to the filing date of the present application; URL:<<https://www.rei.com/product/134143/hydro-flask-unbound-ice-pack>>.

(Continued)

Primary Examiner — Khawaja Anwar

(74) *Attorney, Agent, or Firm* — Banner & Witcoff, Ltd.

(57) **CLAIM**

The ornamental design for an ice pack, as shown and described.

DESCRIPTION

FIG. 1 is a front perspective view of an ice pack showing our new design;

FIG. 2 is a top view thereof;

FIG. 3 is a bottom view thereof;

FIG. 4 is a right side view thereof;

FIG. 5 is a left side view thereof;

FIG. 6 is a front view thereof;

FIG. 7 is a rear view thereof;

FIG. 8 is a front perspective view of a second embodiment of an ice pack showing our new design;

FIG. 9 is a top view thereof;

FIG. 10 is a bottom view thereof;

FIG. 11 is a right side view thereof;

FIG. 12 is a left side view thereof;

FIG. 13 is a front view thereof; and,

FIG. 14 is a rear view thereof.

The uneven-length broken lines immediately adjacent to the shaded areas represent the bounds of the claimed design and form no part thereof. The even-length broken lines depicting the remainder of the ice pack form no part of the claimed design.

1 Claim, 10 Drawing Sheets

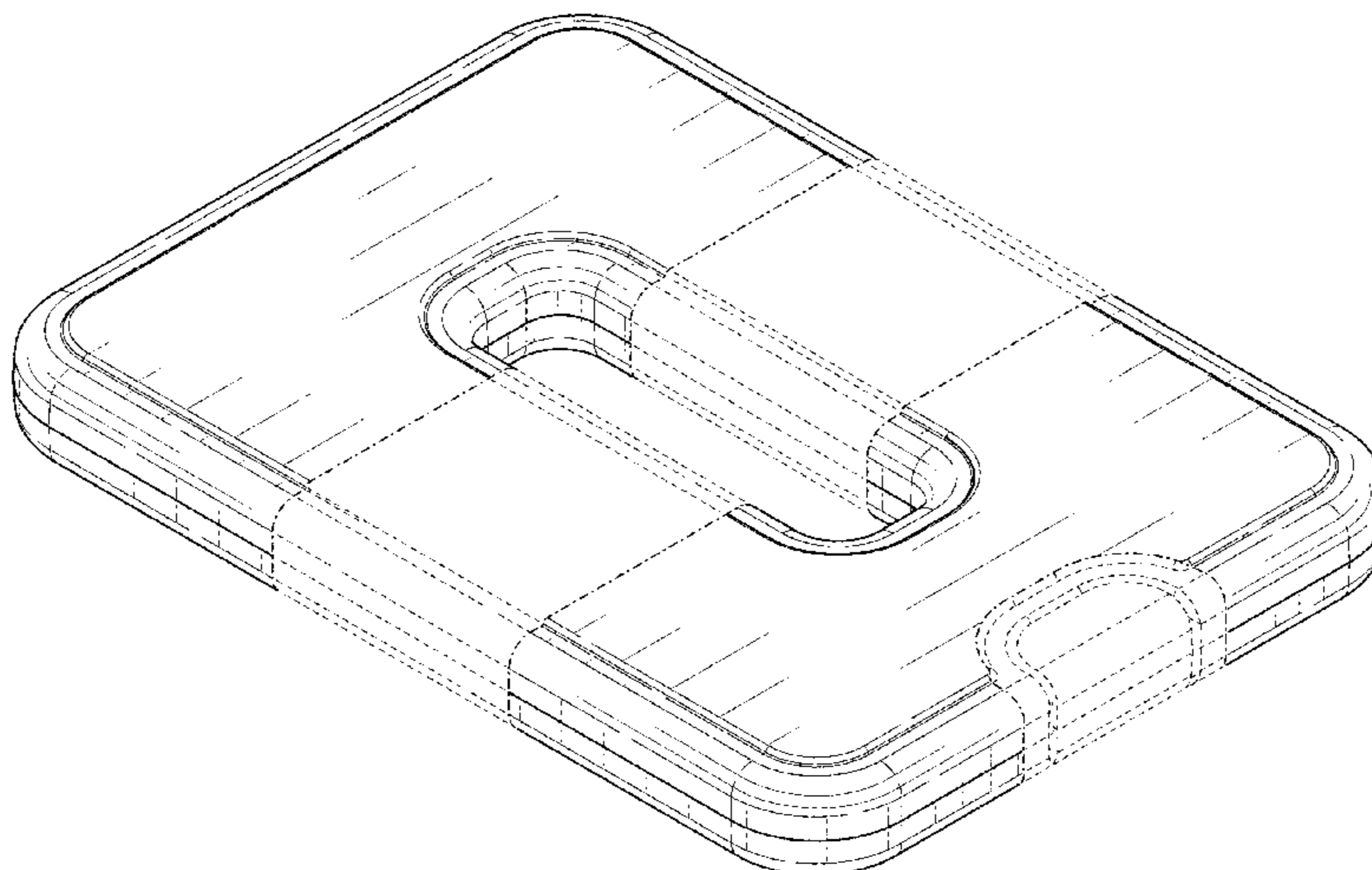

(56)

References Cited

U.S. PATENT DOCUMENTS

D520,534 S 5/2006 Nicholson
 D537,851 S 3/2007 Mount
 D538,309 S 3/2007 Mount
 D700,637 S 3/2014 Maggioni
 D711,439 S * 8/2014 Garg D15/90
 D711,945 S 8/2014 Garg
 D712,442 S 9/2014 Garg
 D714,438 S 9/2014 Quaye
 D714,439 S 9/2014 Huang
 D733,195 S 6/2015 Lum
 D741,919 S * 10/2015 Seiders D15/90
 D741,920 S * 10/2015 Seiders D15/90
 D746,343 S * 12/2015 Mount D15/90
 D791,201 S * 7/2017 Kim D15/90
 D803,066 S * 11/2017 Rudolf D9/569
 D804,543 S * 12/2017 Carvajal D15/90
 D847,221 S 4/2019 Coulombe et al.
 D851,691 S 6/2019 Dai
 D905,131 S * 12/2020 Dai D15/90
 D907,506 S * 1/2021 Xoy D9/542
 D908,010 S * 1/2021 Demarest D9/542
 D911,845 S * 3/2021 Huang D3/202
 D914,068 S * 3/2021 Chen D15/90
 D923,480 S * 6/2021 Xoy D9/542
 D923,481 S * 6/2021 Demarest D9/542

FOREIGN PATENT DOCUMENTS

DK 9014717 U1 4/1991
 EM 300766738-0004 8/2007
 EM 300766738-0027 8/2007
 EM 300766738-0035 8/2007
 EP 0765819 B1 7/2002
 IN 264760-0001 3/2015
 IN 265855-0001 7/2015
 IN 265856-0001 7/2015
 IN 284119-0001 6/2017
 JP D1505230 8/2014
 JP D1643485 10/2019
 JP D1643486 10/2019
 JP D1643487 10/2019
 KR 300597188.0000 4/2011
 KR 20120007666 A 1/2012
 KR 301006148.0000 5/2019
 KR 301021543.0000 9/2019
 MY 13-152-0101-0001 3/2014

SG 2011596 6/2011
 WO 12117575 A1 9/2012
 WO D091314-001 7/2016

OTHER PUBLICATIONS

“Healthy Packers Blue Gel Slim Long-Lasting Ice Packs for Lunch Box or Cooler Bag (4, 6, 8, or 10 pack)”; “Healthy Packers”; retrieved Jun. 3, 2021; disclosure date unknown but prior to the filing date of the present application; URL: <<https://healthypackers.com/products/cool-pack-slim-long-lasting-ice-packs-great-for-coolers-or-lunch-box>>.
 “Cooling Cold Plate Cooler Brick for Frozen Food”; JISILL; retrieved Jun. 3, 2021; disclosure date unknown but prior to the filing date of the present application; URL:<<https://www.cooler-boxs.com/big-large-ice-pack/57402134.html>>.
 “Plastic Eutectic Plate Reusable Gel Ice Pack Cooler”; JISILL; retrieved Jun. 3, 2021; disclosure date unknown but prior to the filing date of the present application; URL: <<https://www.cooler-boxs.com/big-large-ice-pack/57165589.html>>.
 “1600ml large cooling eutectic freezer can ice pack”; JISILL; retrieved Jun. 3, 2021; disclosure date unknown but prior to the filing date of the present application; URL:<<https://www.cooler-boxs.com/big-large-ice-pack/57165077.html>>.
 “Large high quality nontoxic cold plate ice pack”; JISILL; retrieved Jun. 3, 2021; disclosure date unknown but prior to the filing date of the present application; URL: <<https://www.cooler-boxs.com/big-large-ice-pack/57165060.html>>.
 “Top 5 Best Ice Packs for Coolers and How to Maximize Ice Retention”; Best Cooler; retrieved Jun. 3, 2021; disclosure date unknown but prior to the filing date of the present application; URL: <<https://bestcooler.reviews/best-ice-packs-for-coolers-reviews/>>.
 “Ice Pack”; Hydro Flask; retrieved Jun. 3, 2021; disclosure date unknown but prior to the filing date of the present application; URL: <<https://www.hydroflask.com/ice-pack?color=pacific>>.
 Feb. 22, 2022—(JP) Office Action—App. No. 2021-026388.
 Mar. 15, 2022—(JP) Office Action—App. No. 2021-026391.
 Mar. 15, 2022—(JP) Office Action—App. No. 2021-026390.
 Mar. 15, 2022—(JP) Office Action—App. No. 2021.026387.
 Mar. 15, 2022—(JP) Office Action—App. No. 2021-026389.
 Amazon.com, Inc., “Yeti Thin Ice Refreezable Reusable Cooler Ice Pack”, published May 6, 2021, retrieved from <<https://www.amazon.com/YETI-Thin-Refreezable-Reusable-Cooler/dp/B08ZQ8V133?th=1&ppsc=1>>, Apr. 20, 2022, 6 pgs.

* cited by examiner

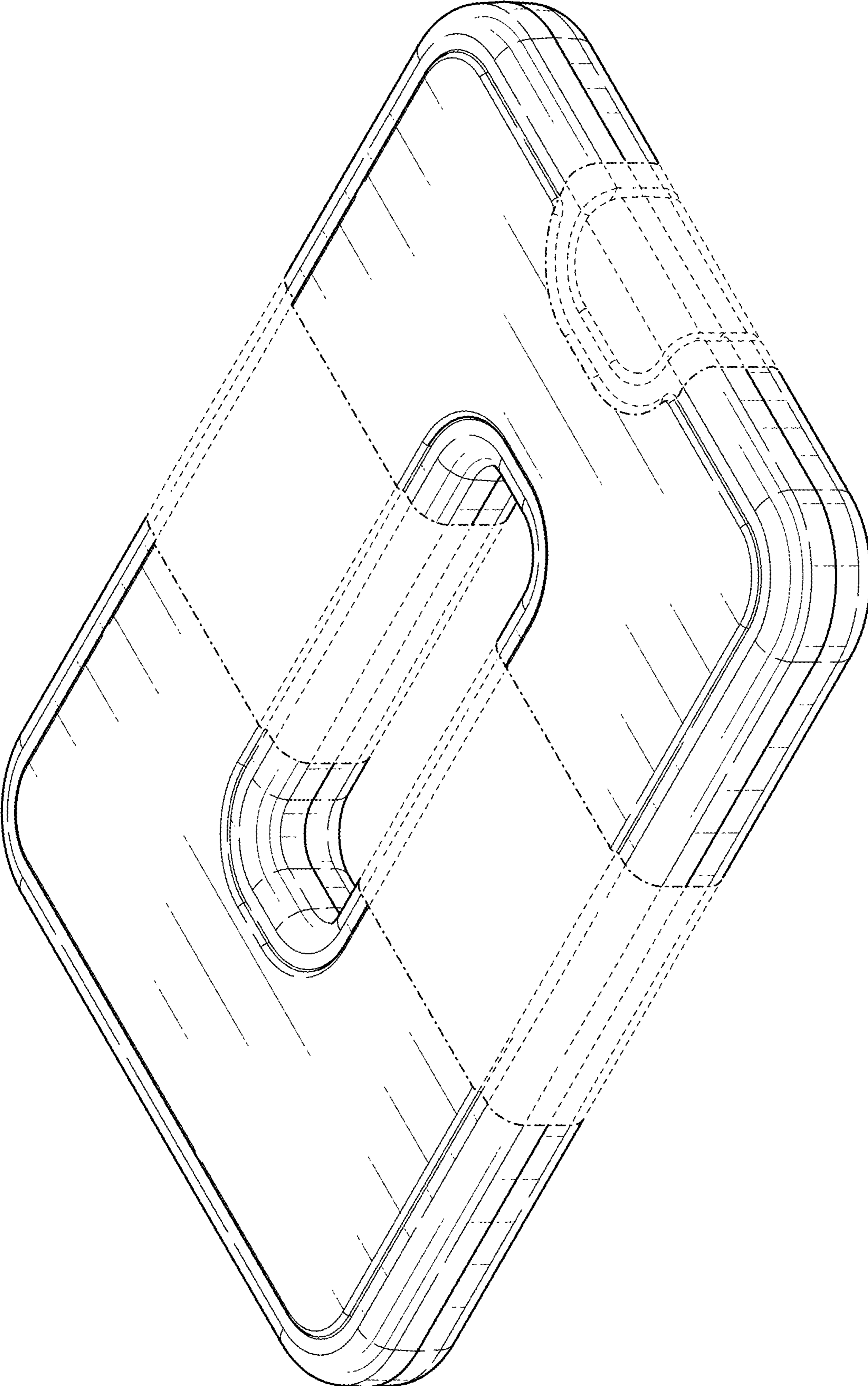

FIG. 1

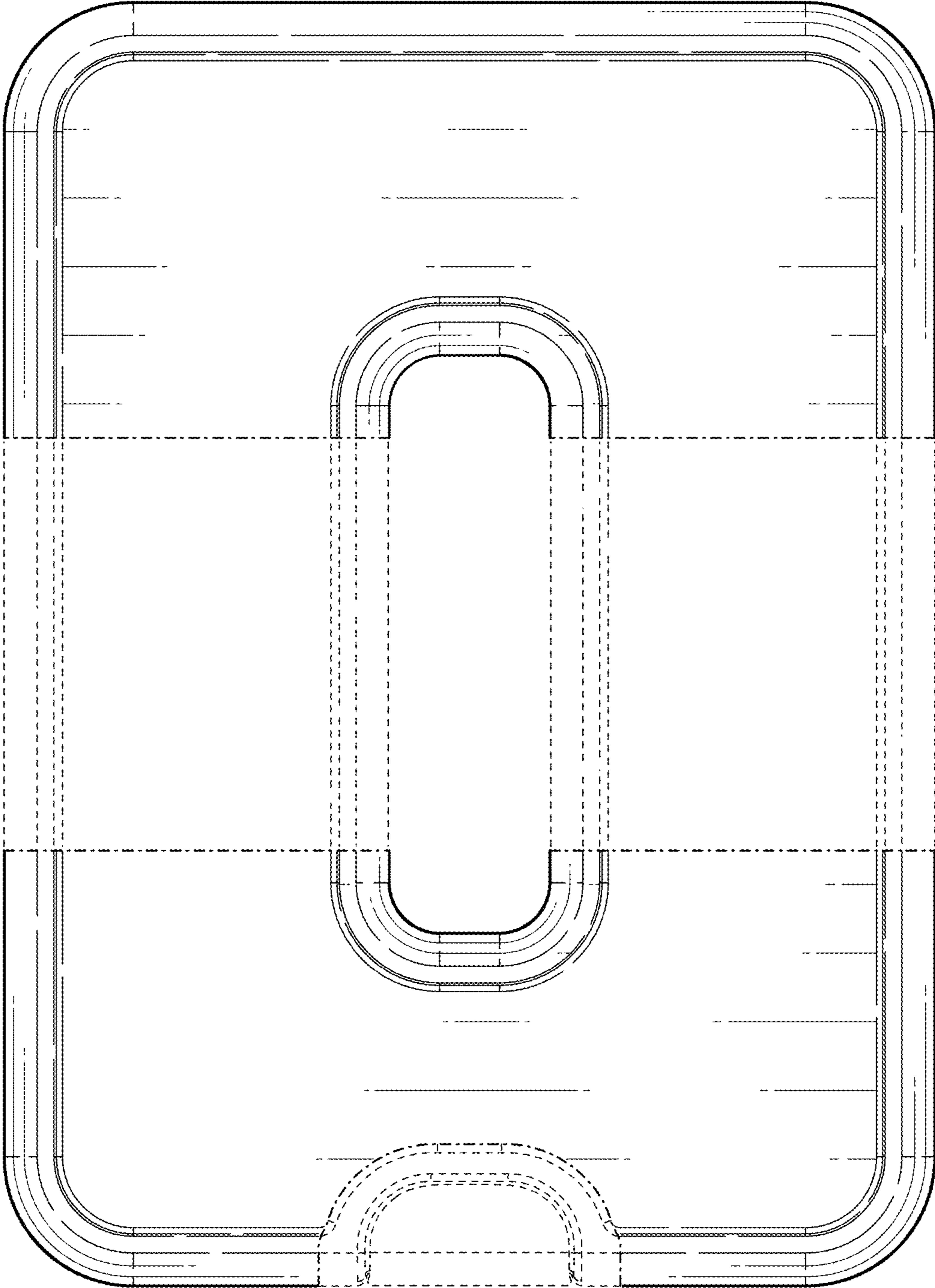

FIG. 2

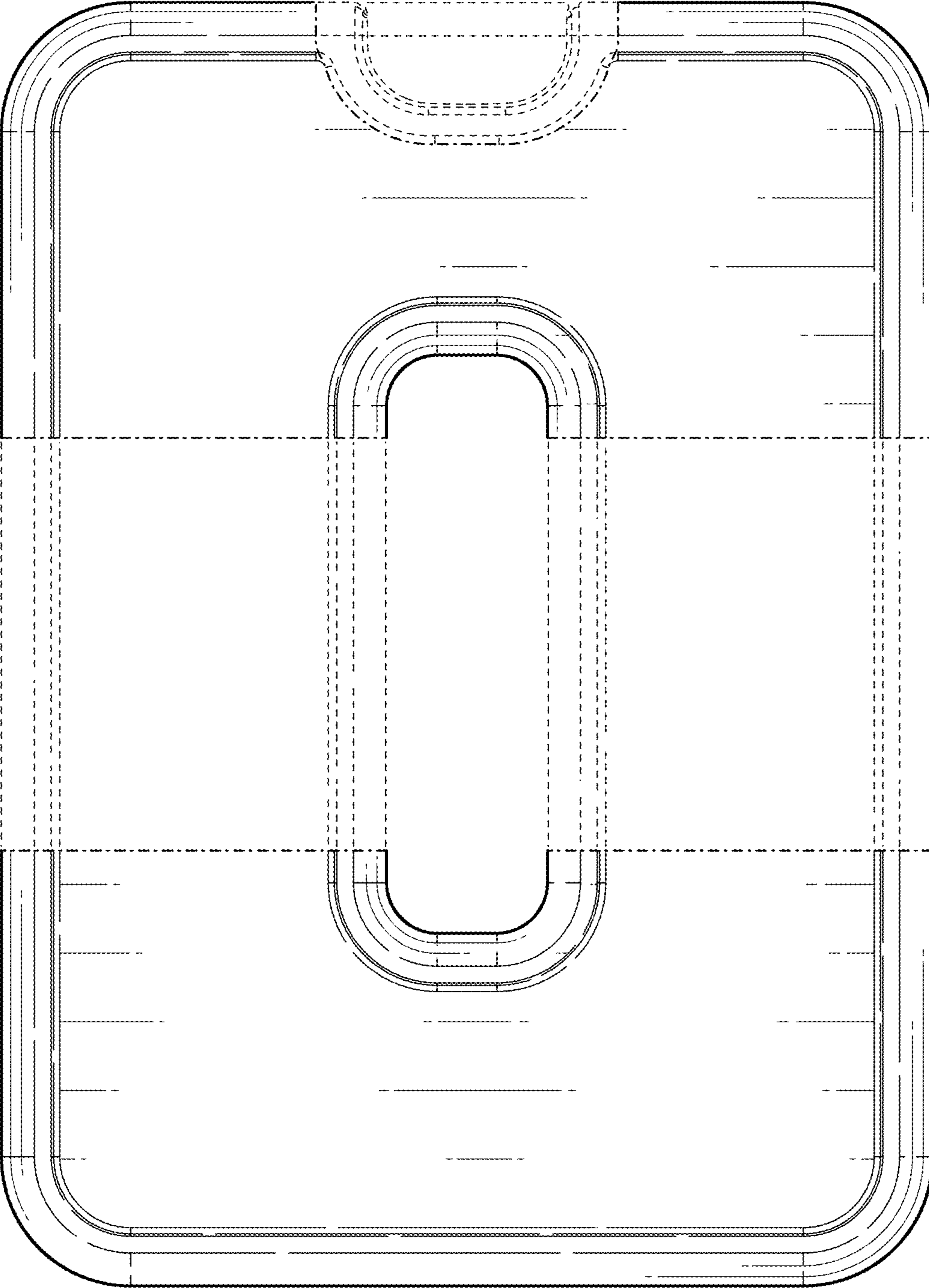

FIG. 3

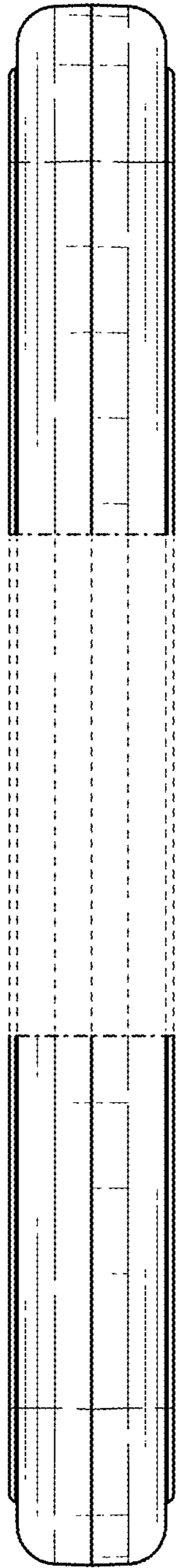

FIG. 4

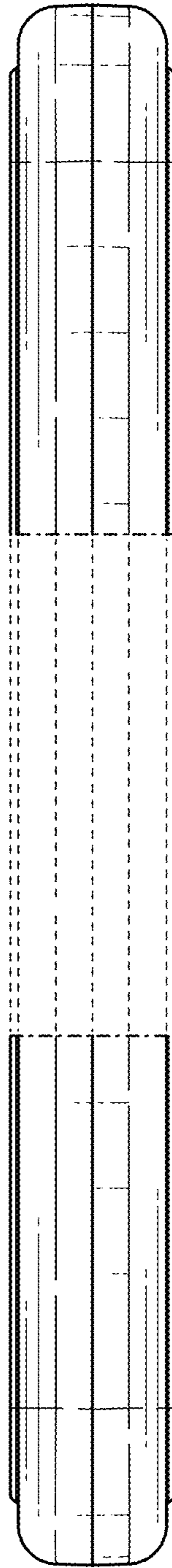

FIG. 5

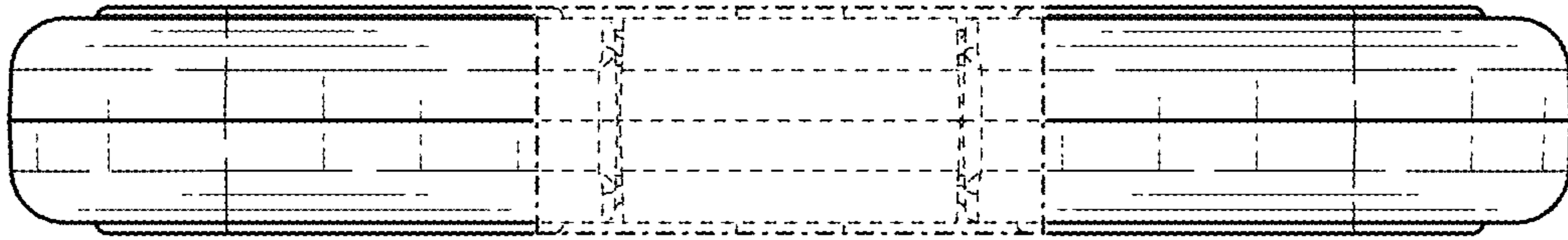

FIG. 6

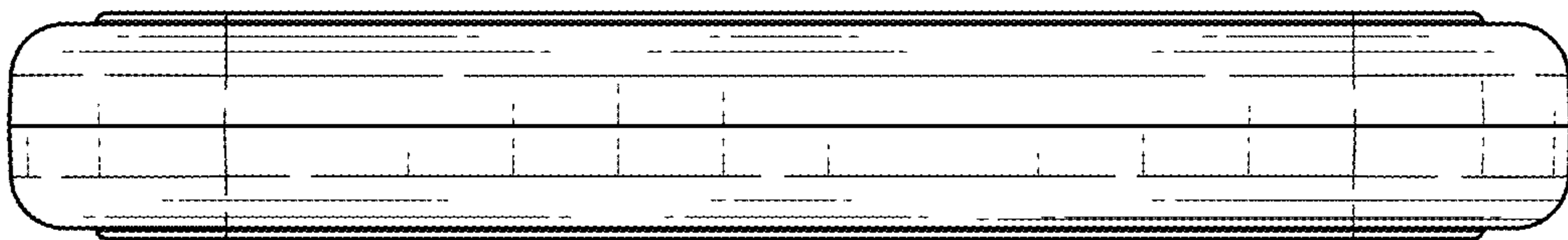

FIG. 7

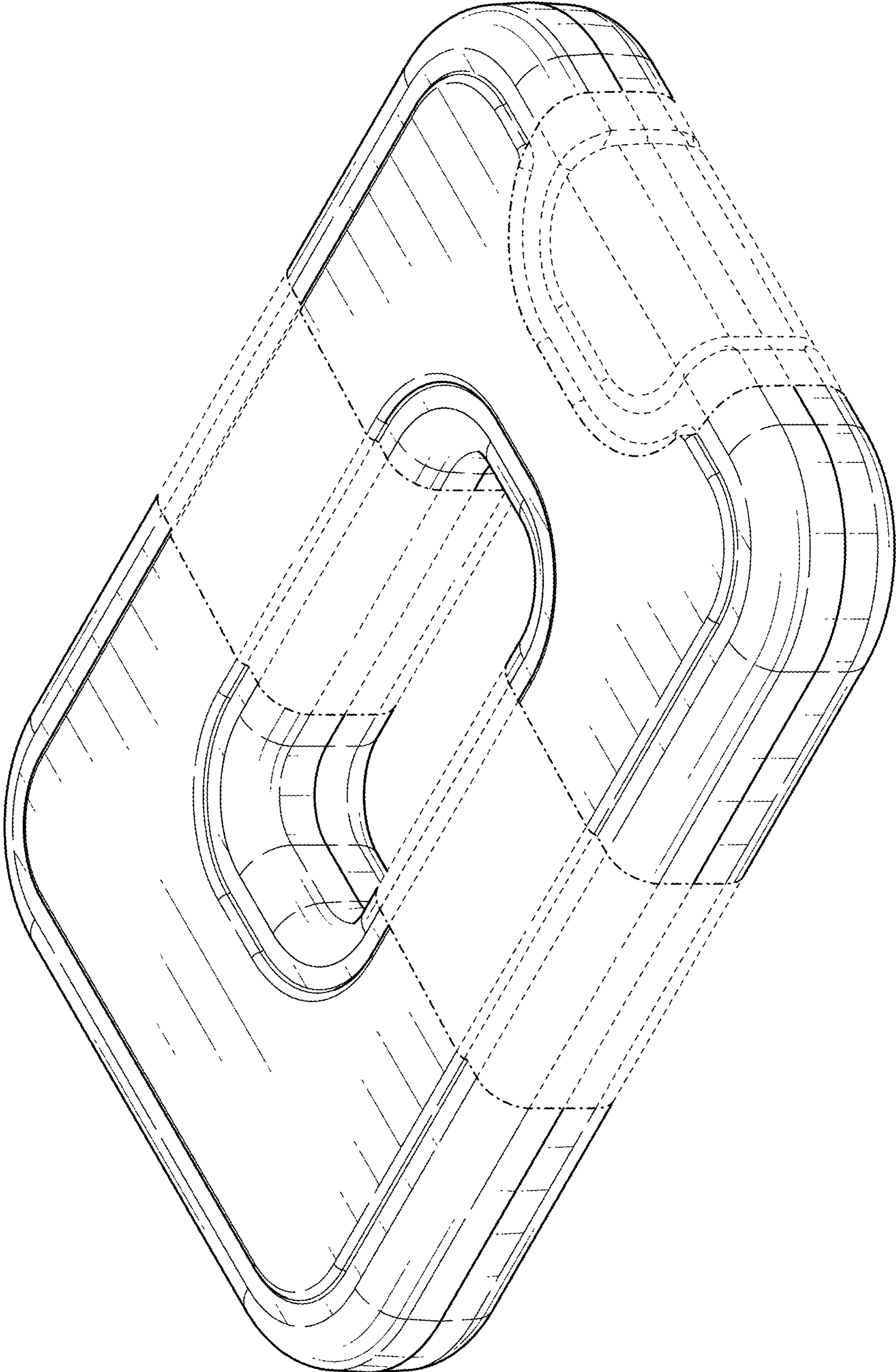

FIG. 8

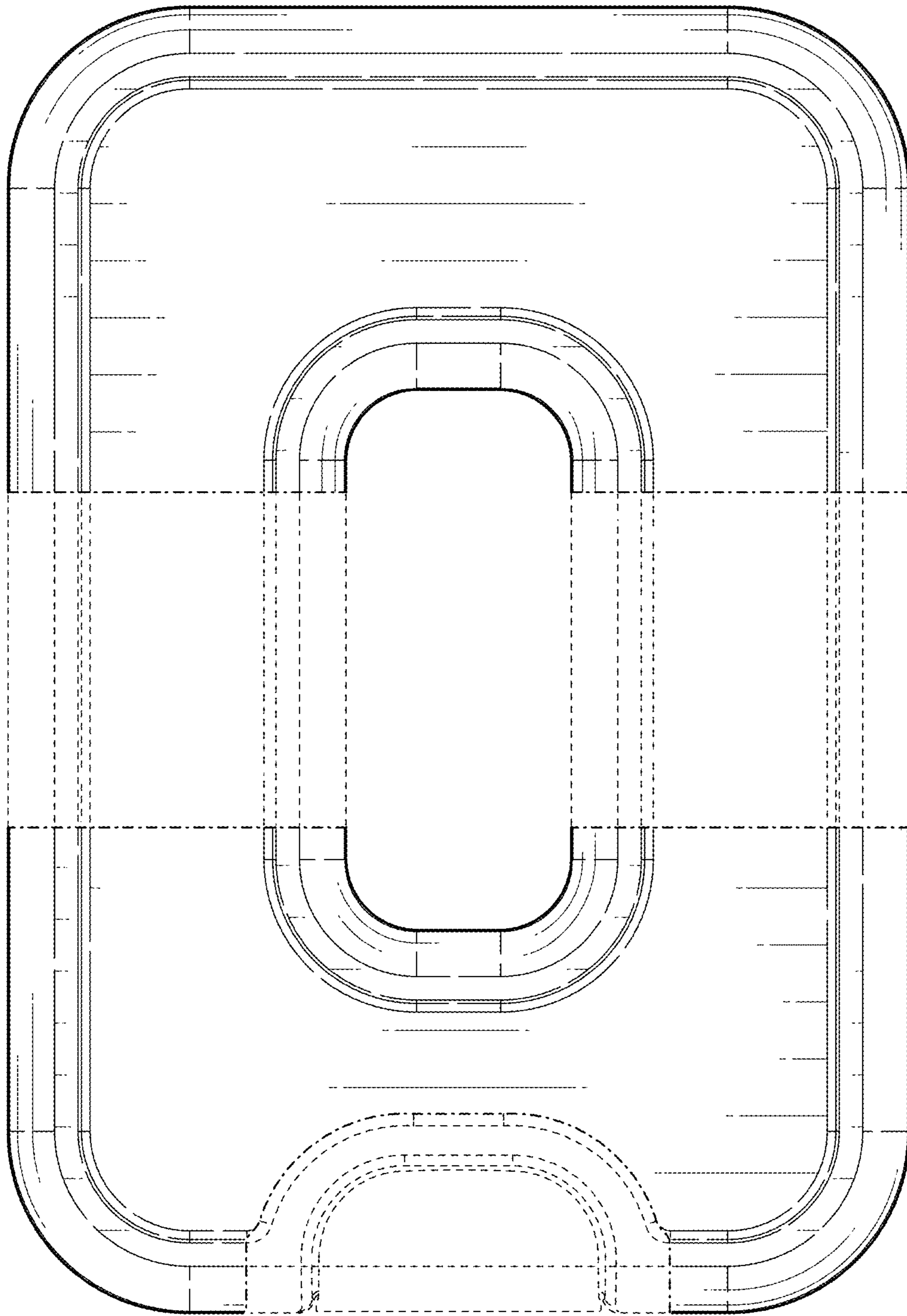

FIG. 9

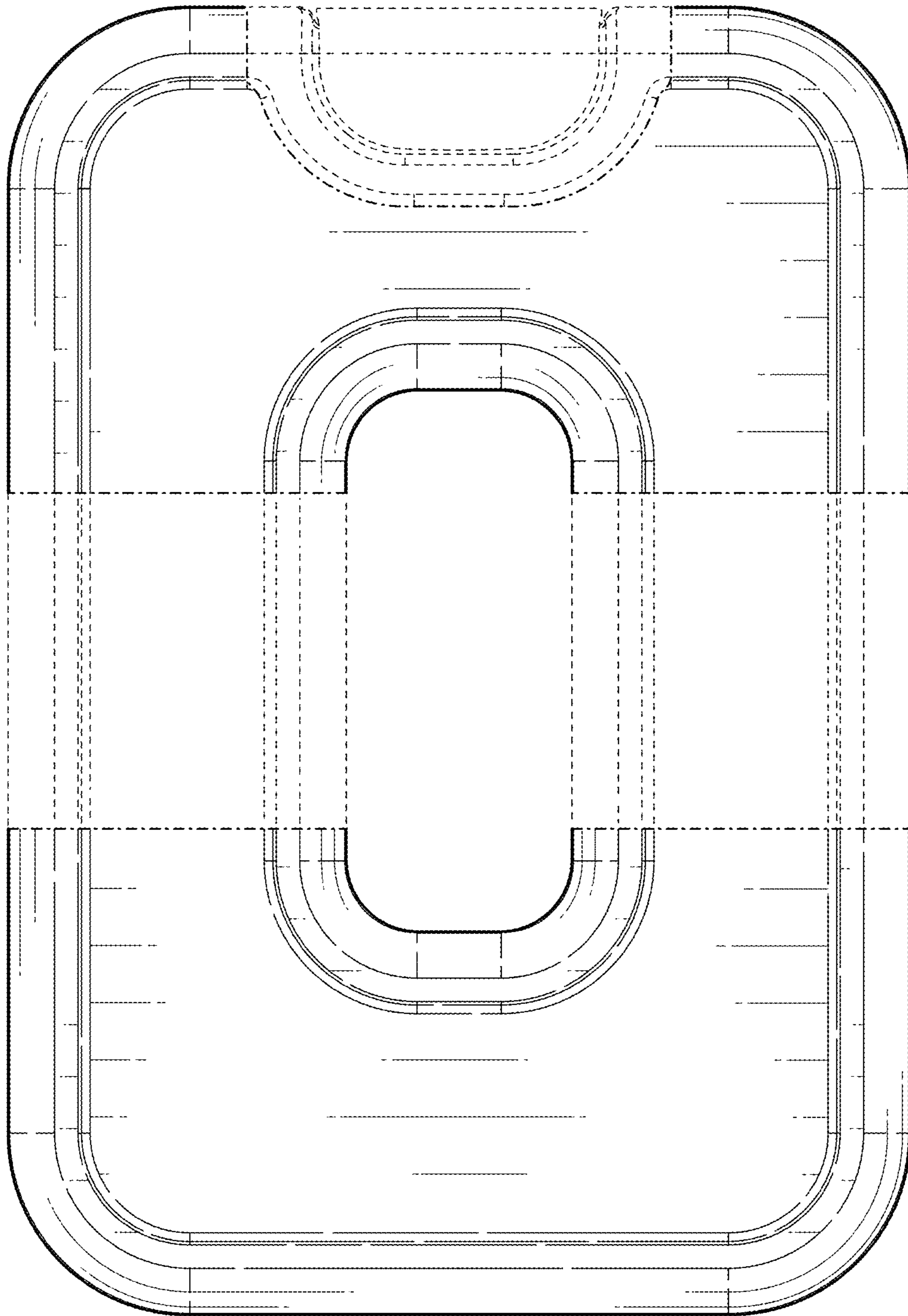

FIG. 10

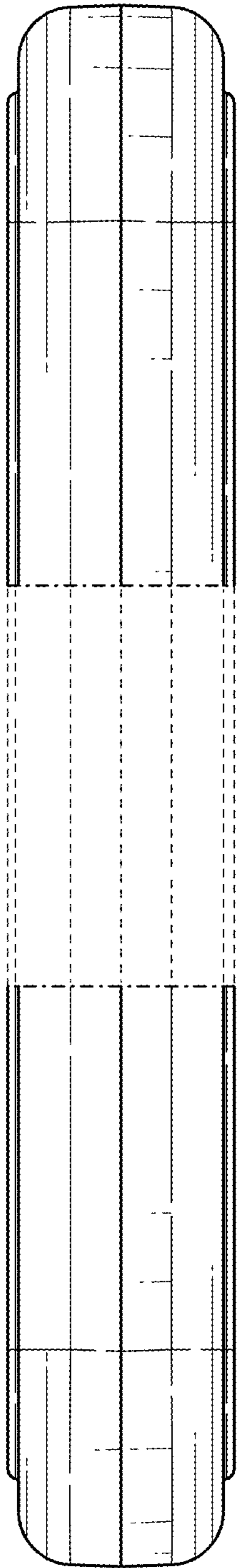

FIG. 11

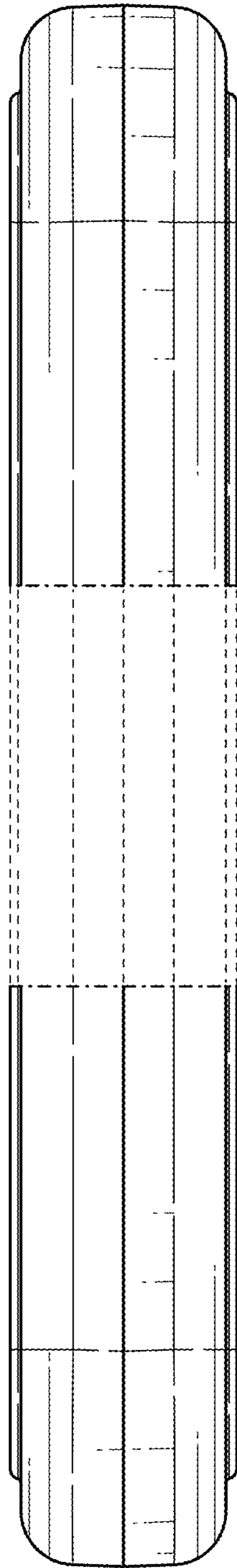

FIG. 12

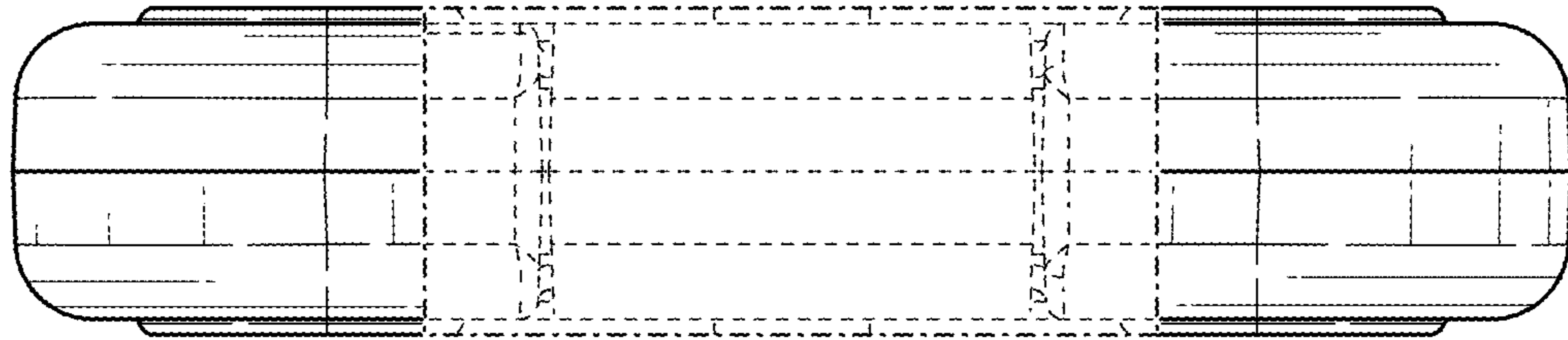

FIG. 13

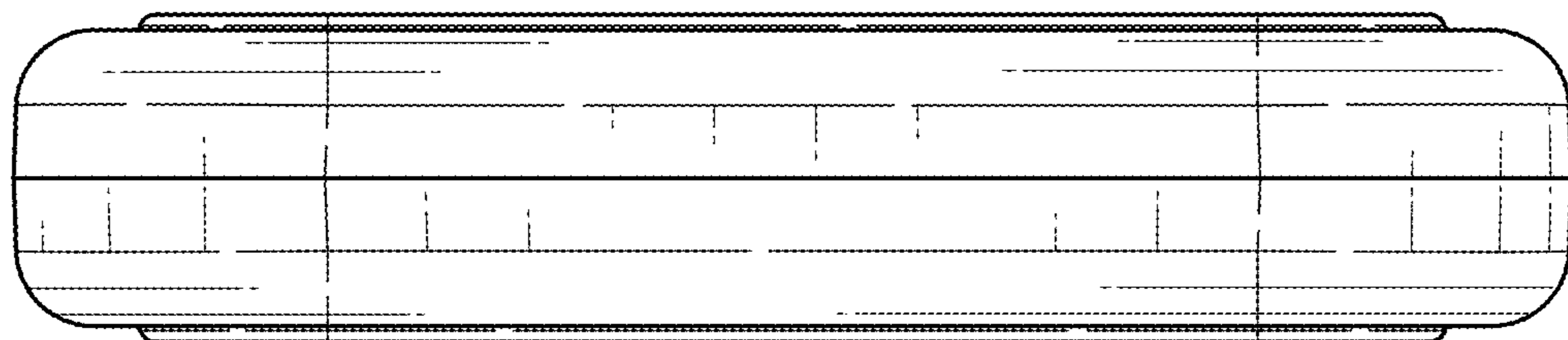

FIG. 14