



US00D989716S

(12) **United States Design Patent**
Yan

(10) **Patent No.:** **US D989,716 S**
(45) **Date of Patent:** **** Jun. 20, 2023**

(54) **CABLE**
(71) Applicant: **Shenzhen Diyiwei Electronics Co., Ltd.**, Shenzhen (CN)
(72) Inventor: **Lei Yan**, Shenzhen (CN)
(73) Assignee: **Shenzhen Diyiwei Electronics Co., Ltd.**, Shenzhen (CN)
(**) Term: **15 Years**

| | | | |
|--------------|---------|---------------|---------|
| D618,178 S * | 6/2010 | Andre | D13/154 |
| D632,261 S * | 2/2011 | Andre | D13/154 |
| D712,836 S * | 9/2014 | Lee | D13/133 |
| D818,439 S * | 5/2018 | Kim | D13/153 |
| D823,261 S * | 7/2018 | Uggla | D13/153 |
| D858,456 S * | 9/2019 | Hanover | D13/153 |
| D898,031 S * | 10/2020 | Zhang | D13/153 |
| D898,032 S * | 10/2020 | Yuan | D13/153 |
| D901,506 S * | 11/2020 | He | D13/133 |
| D916,665 S * | 4/2021 | Zhen | D13/153 |
| D939,504 S * | 12/2021 | Zhang | D14/433 |
| D956,759 S * | 7/2022 | Deng | D14/433 |
| D971,161 S * | 11/2022 | Liu | D13/153 |

(21) Appl. No.: **29/805,056**

* cited by examiner

(22) Filed: **Aug. 24, 2021**

Primary Examiner — Rhea Shields

(30) **Foreign Application Priority Data**

(57) **CLAIM**

Aug. 20, 2021 (EM) 008657191-0001

The ornamental design for a cable, as shown and described.

(51) **LOC (14) Cl.** **13-03**

DESCRIPTION

(52) **U.S. Cl.**
USPC **D13/153**

FIG. 1 is a perspective view of a cable showing my new design;
FIG. 2 is another perspective view thereof;
FIG. 3 is a front elevational view thereof;
FIG. 4 is a rear elevational view thereof;
FIG. 5 is a left side elevational view thereof;
FIG. 6 is a right side elevational view thereof;
FIG. 7 is a top plan view thereof; and,
FIG. 8 is a bottom plan view thereof.

(58) **Field of Classification Search**
USPC D13/153, 133, 147, 154; D14/433
See application file for complete search history.

The broken lines in the drawings depict portions of the cable that form no part of the claimed design.

(56) **References Cited**

1 Claim, 7 Drawing Sheets

U.S. PATENT DOCUMENTS

| | | | |
|--------------|---------|---------------------|---------|
| D349,099 S * | 7/1994 | Robertson, Jr. | D13/147 |
| D447,735 S * | 9/2001 | Nakashima | D13/153 |
| D448,734 S * | 10/2001 | Nakashima | D13/153 |
| D454,542 S * | 3/2002 | Nakashima | D13/153 |

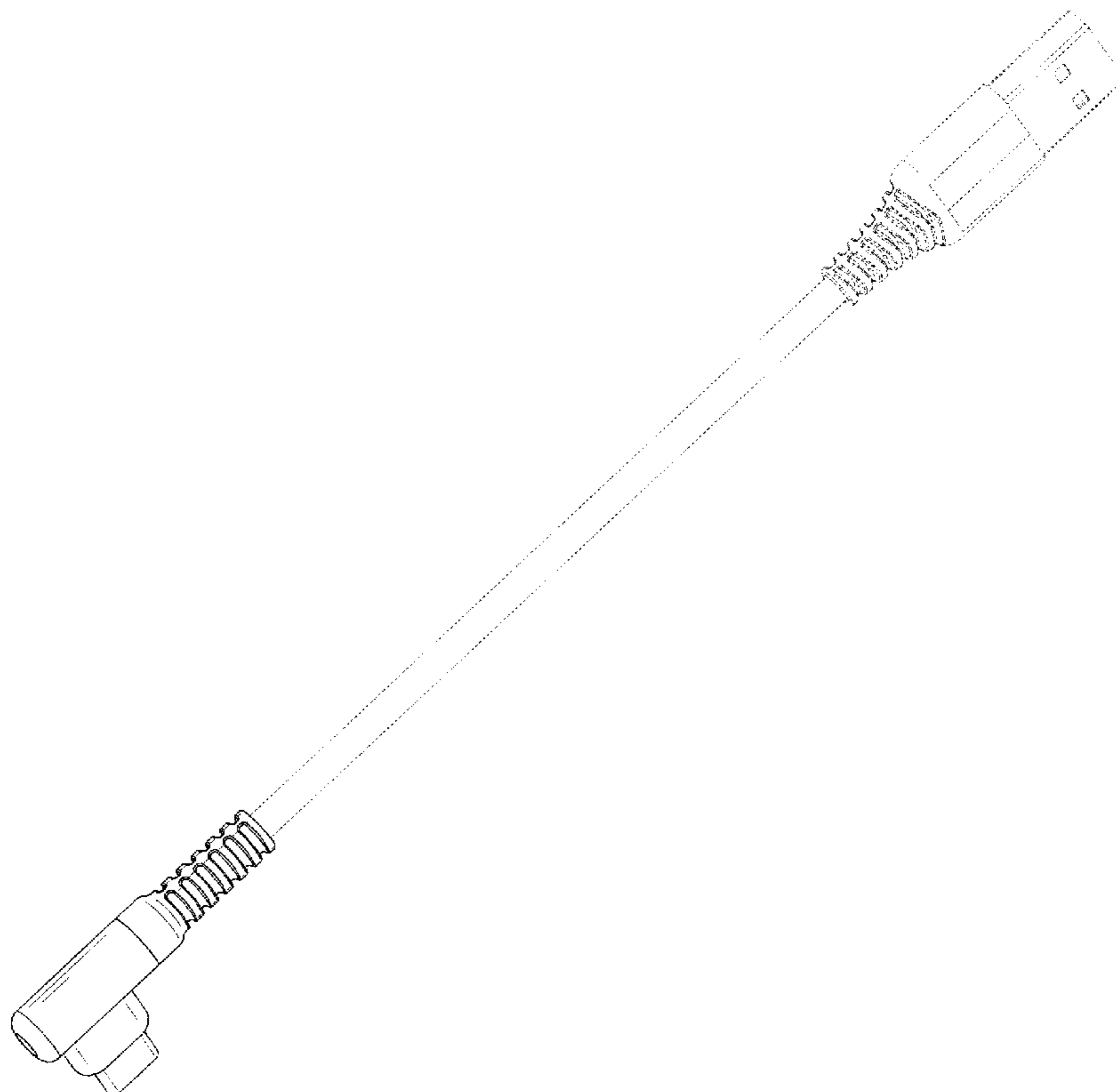

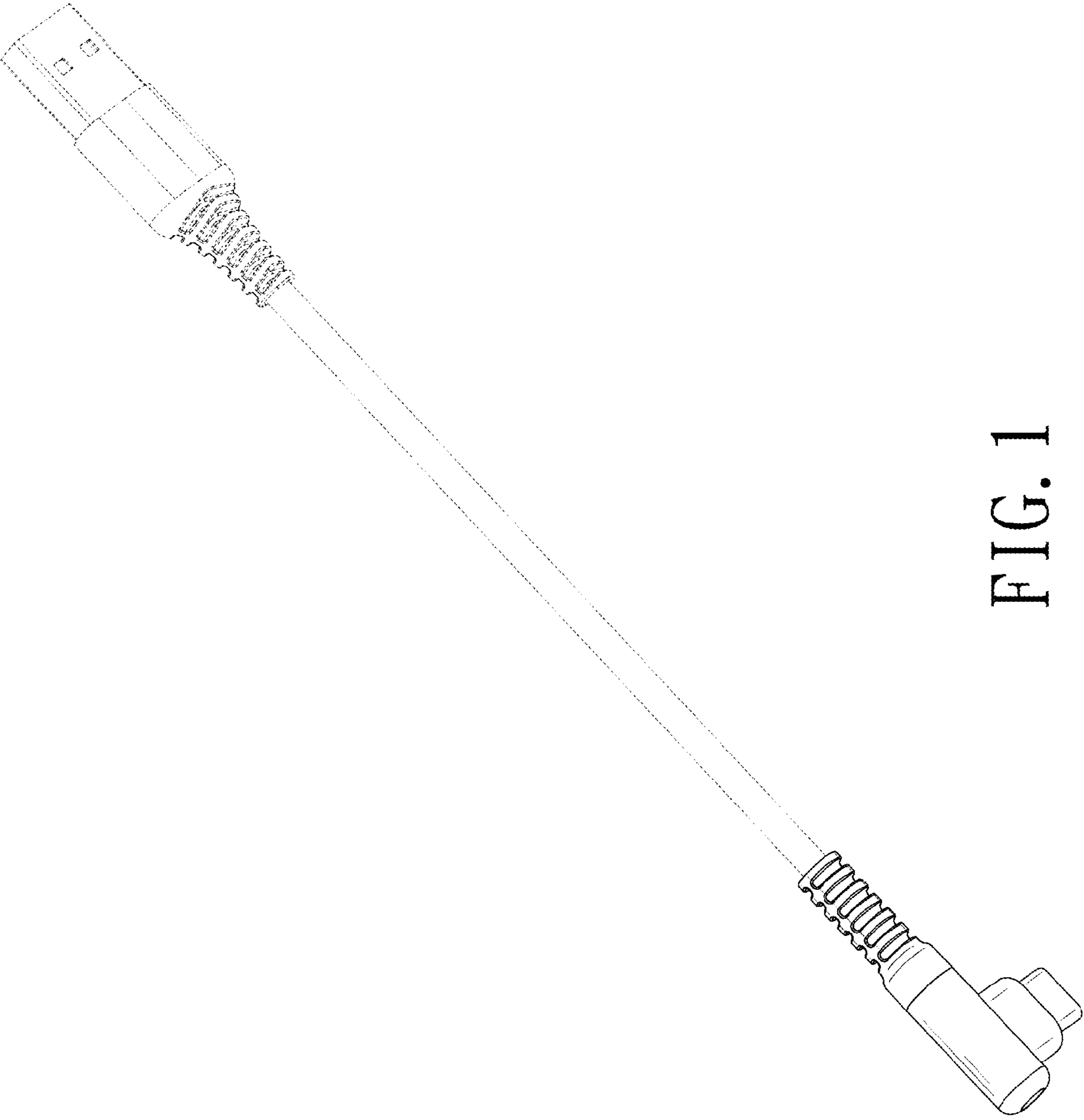

FIG. 1

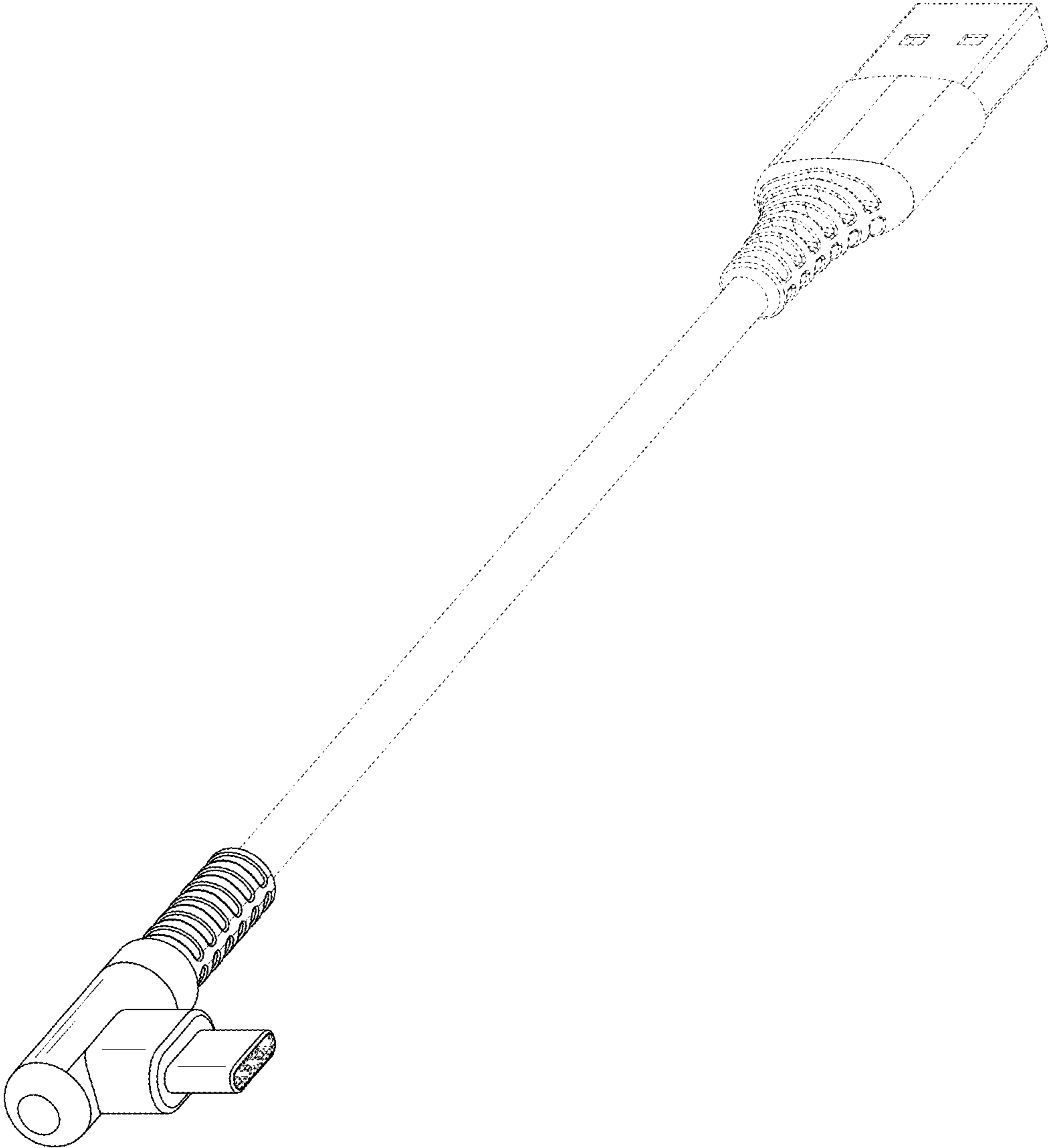

FIG. 2

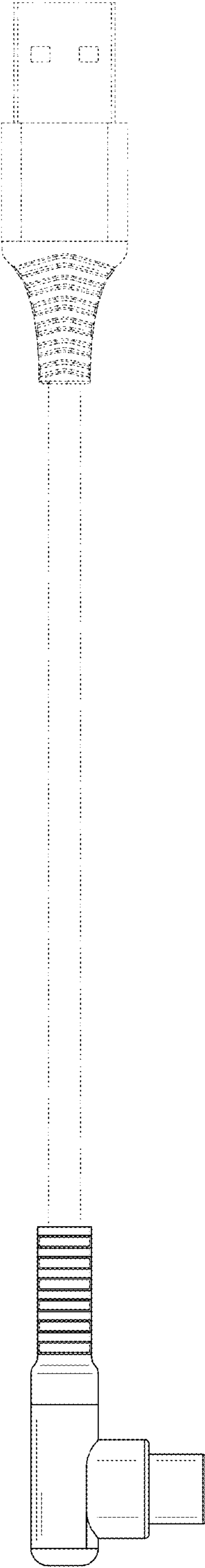

FIG. 3

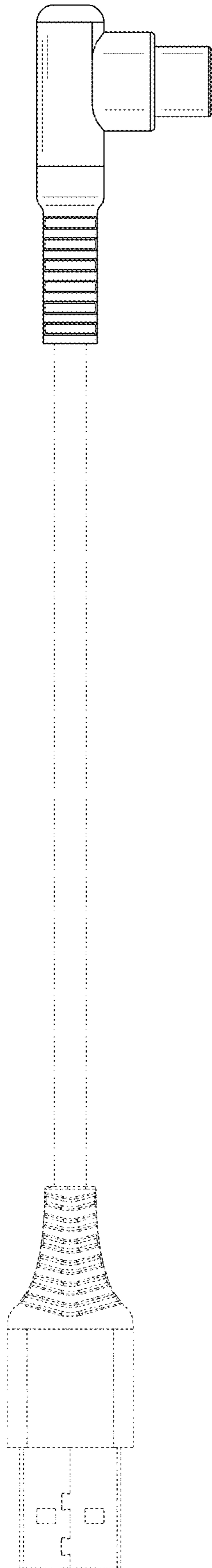

FIG. 4

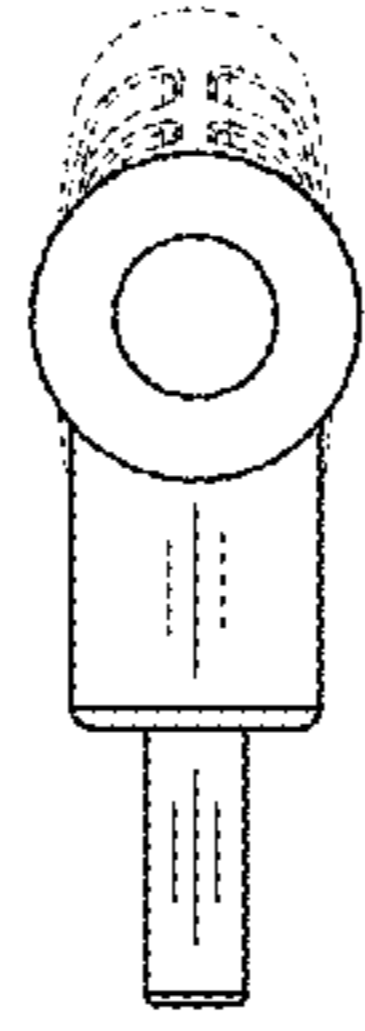

FIG. 5

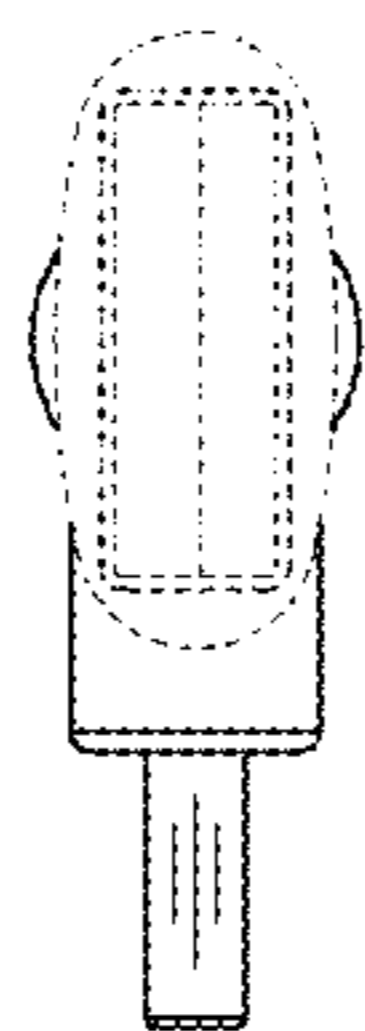

FIG. 6

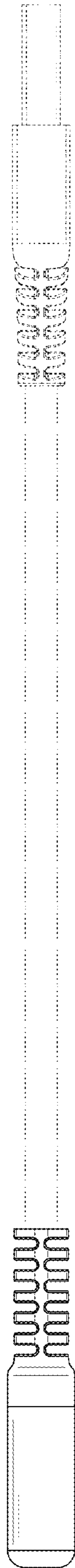

FIG. 7

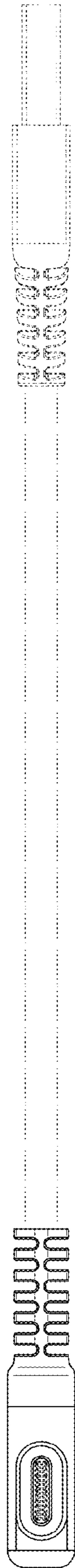

FIG. 8