



US00D989646S

(12) **United States Design Patent**
Hu

(10) **Patent No.:** **US D989,646 S**
(45) **Date of Patent:** **** Jun. 20, 2023**

(54) **TIRE BALANCER**

(71) Applicant: **Qingdao Runbell Co., Ltd.**, Shandong (CN)

(72) Inventor: **Lijun Hu**, Shandong (CN)

(73) Assignee: **Qingdao Runbell Co., Ltd.**, Shandong (CN)

(**) Term: **15 Years**

(21) Appl. No.: **29/835,650**

(22) Filed: **Apr. 20, 2022**

Related U.S. Application Data

(63) Continuation of application No. 29/703,485, filed on Aug. 15, 2019, now abandoned.

(51) **LOC (14) Cl.** **34-32**

(52) **U.S. Cl.**
USPC **D34/32; D10/82**

(58) **Field of Classification Search**
USPC **D10/82; D34/32**
CPC . **B66F 7/243; Y02A 30/60; B60T 3/00; B60P 3/077; B64F 1/16**

See application file for complete search history.

(56) **References Cited**

U.S. PATENT DOCUMENTS

D552,497 S *	10/2007	Parker	D10/82
D912,363 S *	3/2021	Cheung	D34/32
D921,324 S *	6/2021	Zhang	D34/32
11,021,350 B2 *	6/2021	Belton	B66F 13/00
11,097,697 B2 *	8/2021	Hu	B64F 1/16
D941,549 S *	1/2022	Hu	D34/32
D975,394 S *	1/2023	Sanchez Mora	D10/69

* cited by examiner

Primary Examiner — Antoine Duval Davis

(74) *Attorney, Agent, or Firm* — Houtteman Law LLC

(57) **CLAIM**

The ornamental design for a tire balancer, as shown and described.

DESCRIPTION

FIG. 1 is a perspective view of a tire balancer with a removable block showing my new design;

FIG. 2 is a perspective view of the tire balancer without the removable block shown in FIG. 1;

FIG. 3 is a top view of the tire balancer shown in FIG. 2;

FIG. 4 is a bottom view of the tire balancer shown in FIG. 2;

FIG. 5 is a left side view of the tire balancer shown in FIG. 2; and

FIG. 6 is a rear side view of the tire balancer shown in FIG. 2;

FIG. 7 is a front side view of the tire balancer shown in FIG. 2;

FIG. 8 is a perspective view of the removable block shown in FIG. 1;

FIG. 9 is a top view of the removable block shown in FIG. 8;

FIG. 10 is a bottom view of the removable block shown in FIG. 8;

FIG. 11 is a front side view of the removable block shown in FIG. 8;

FIG. 12 is a rear side view of the removable block shown in FIG. 8; and,

FIG. 13 is a left side view of the removable block shown in FIG. 8.

The broken line showing of structural features—is included for the purpose of illustrating non-claimed subject matter and forms no part of the claimed design.

1 Claim, 13 Drawing Sheets

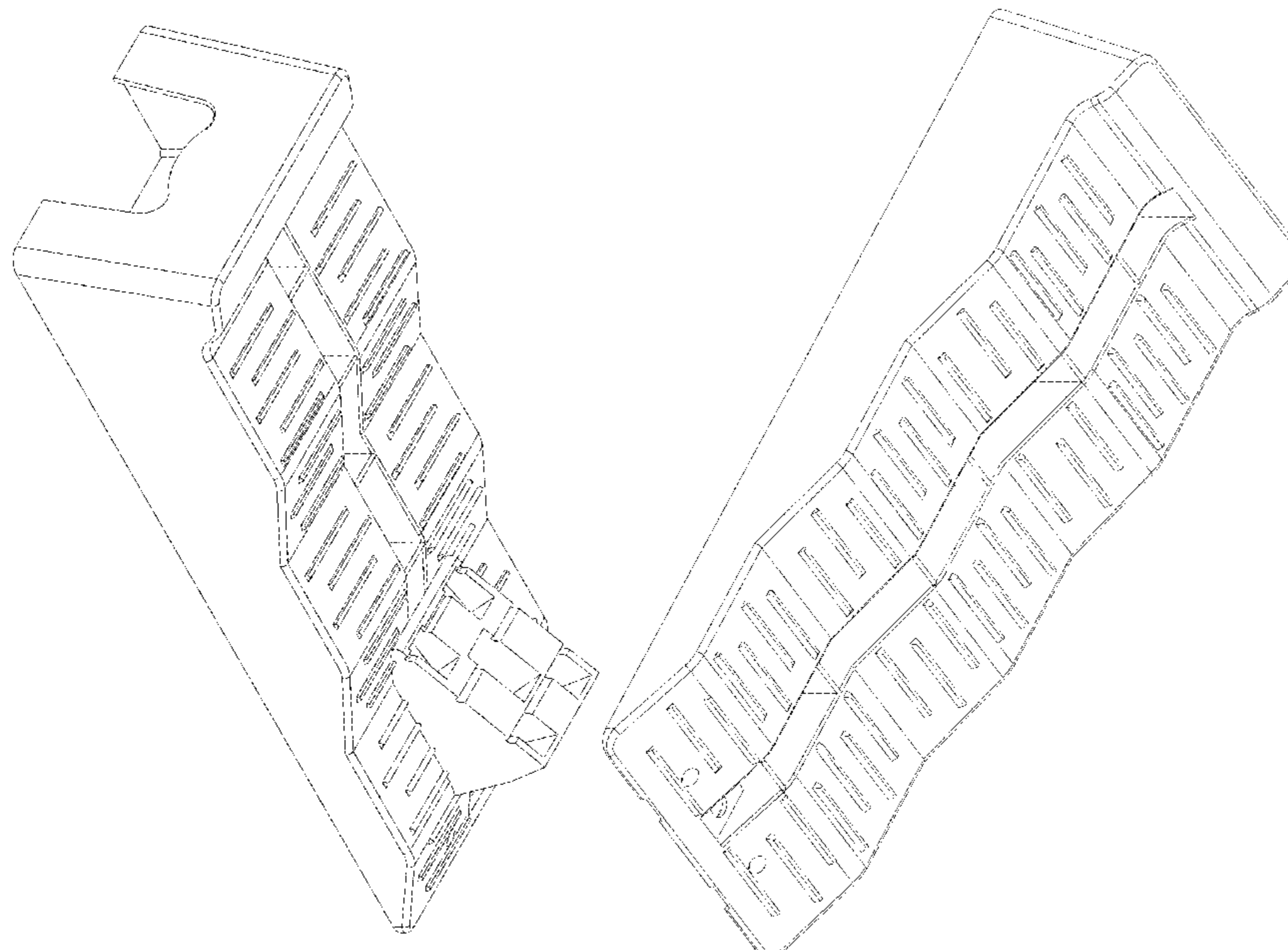

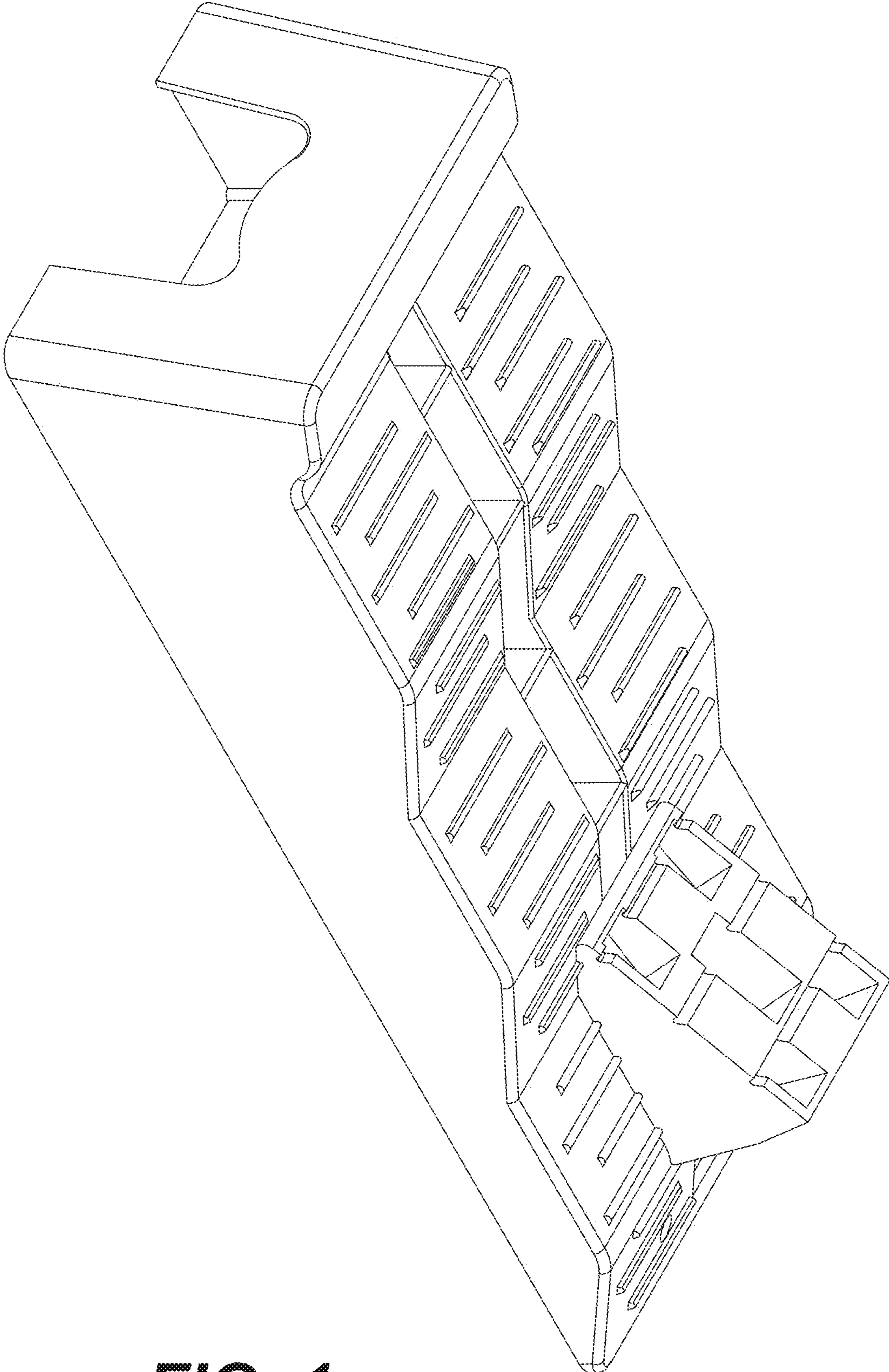

FIG. 1

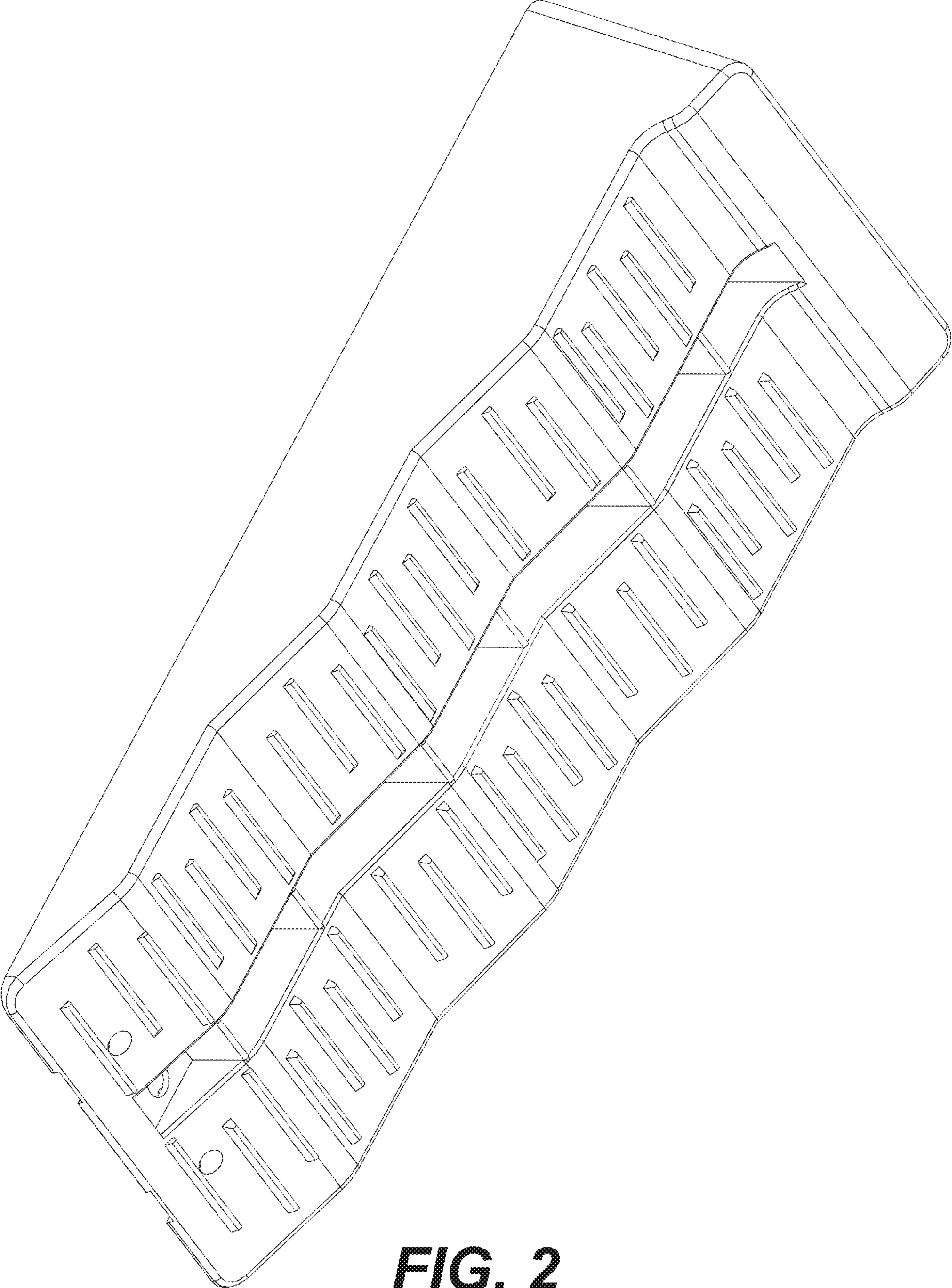

FIG. 2

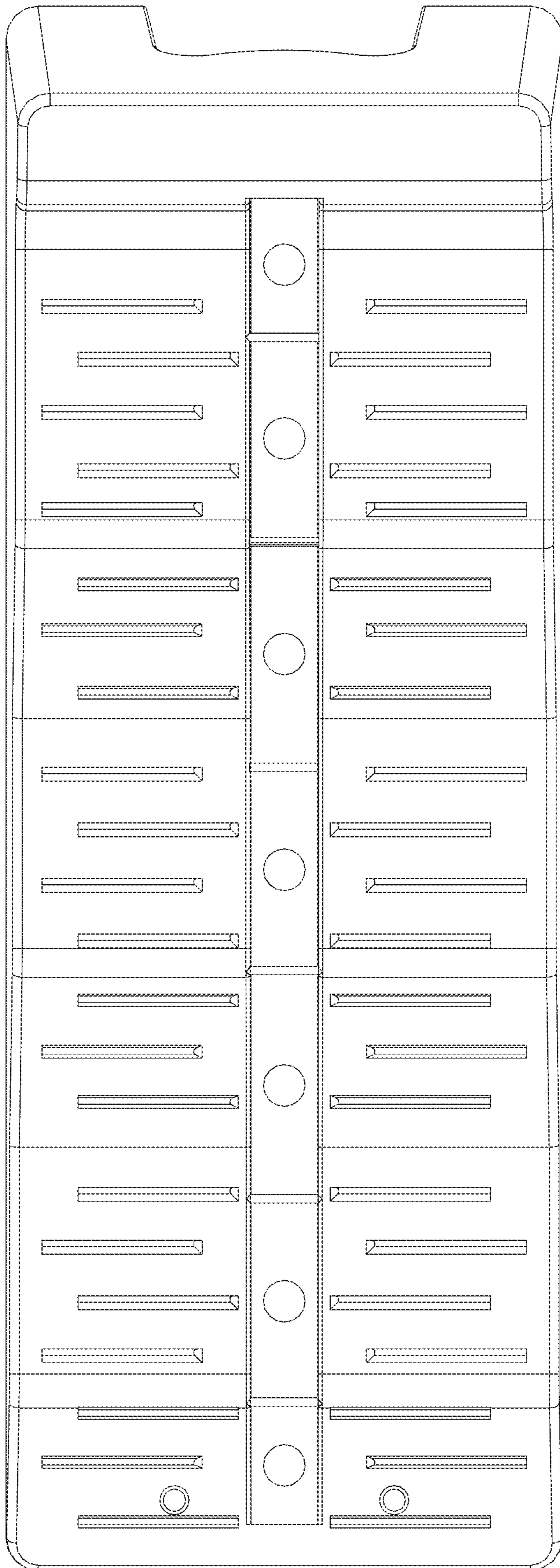

FIG. 3

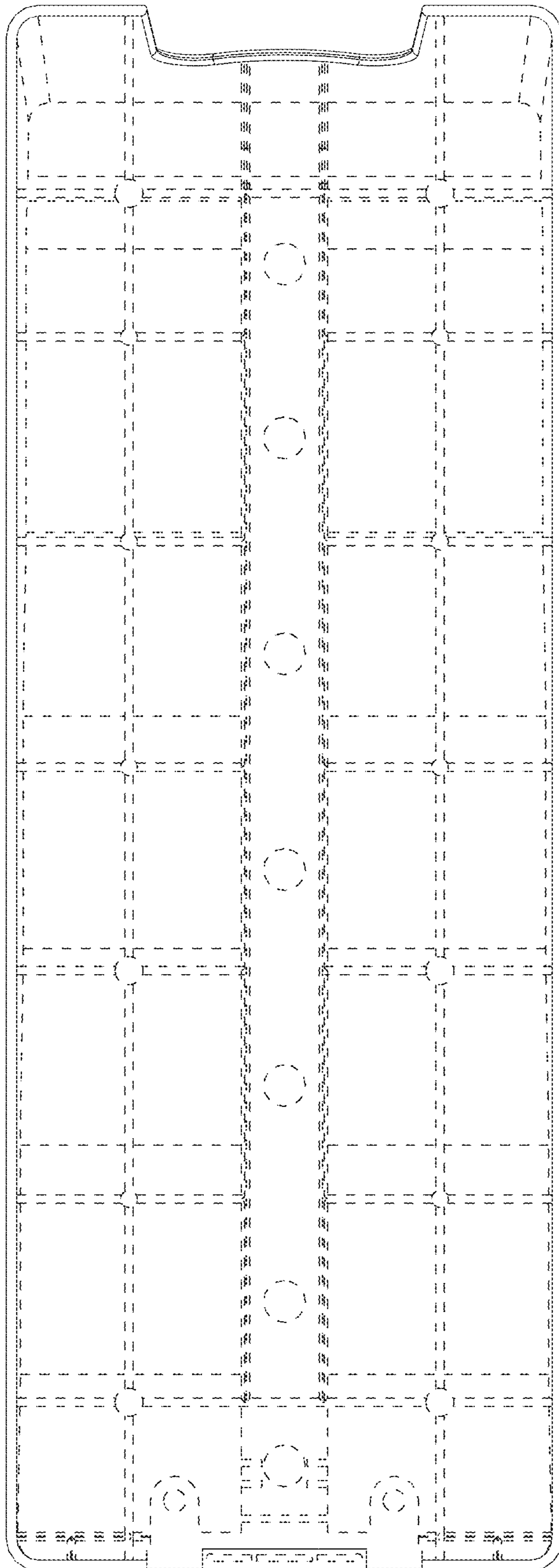

FIG. 4

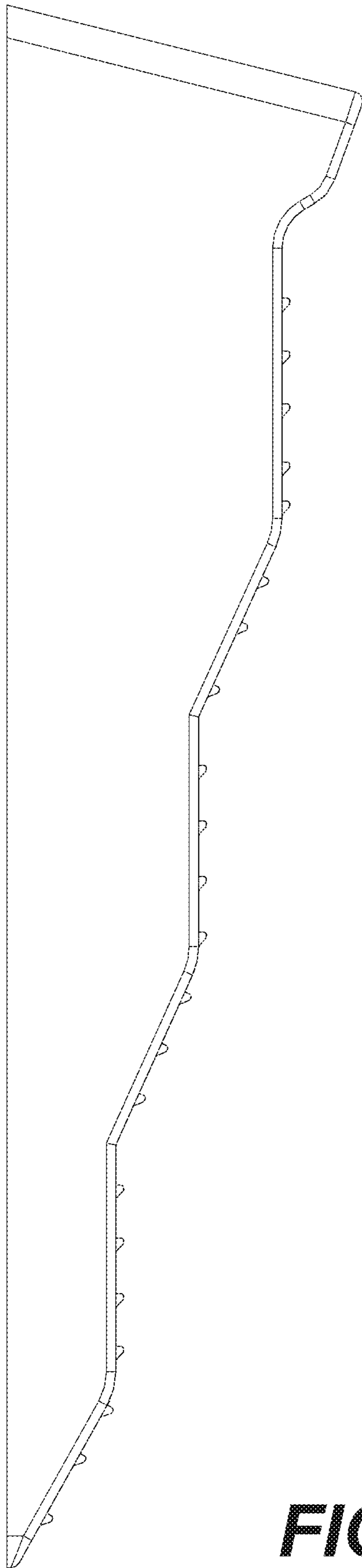

FIG. 5

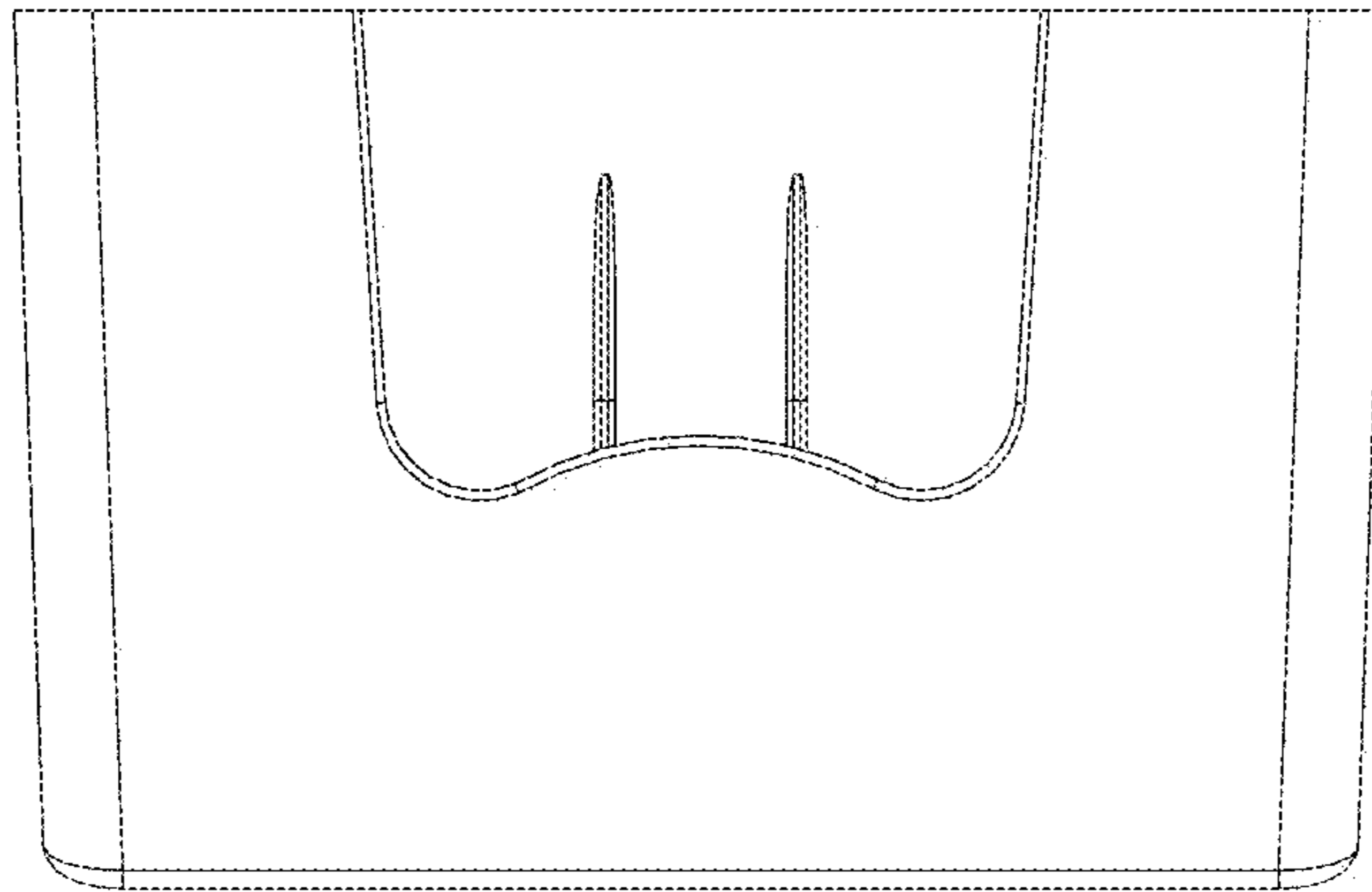

FIG. 6

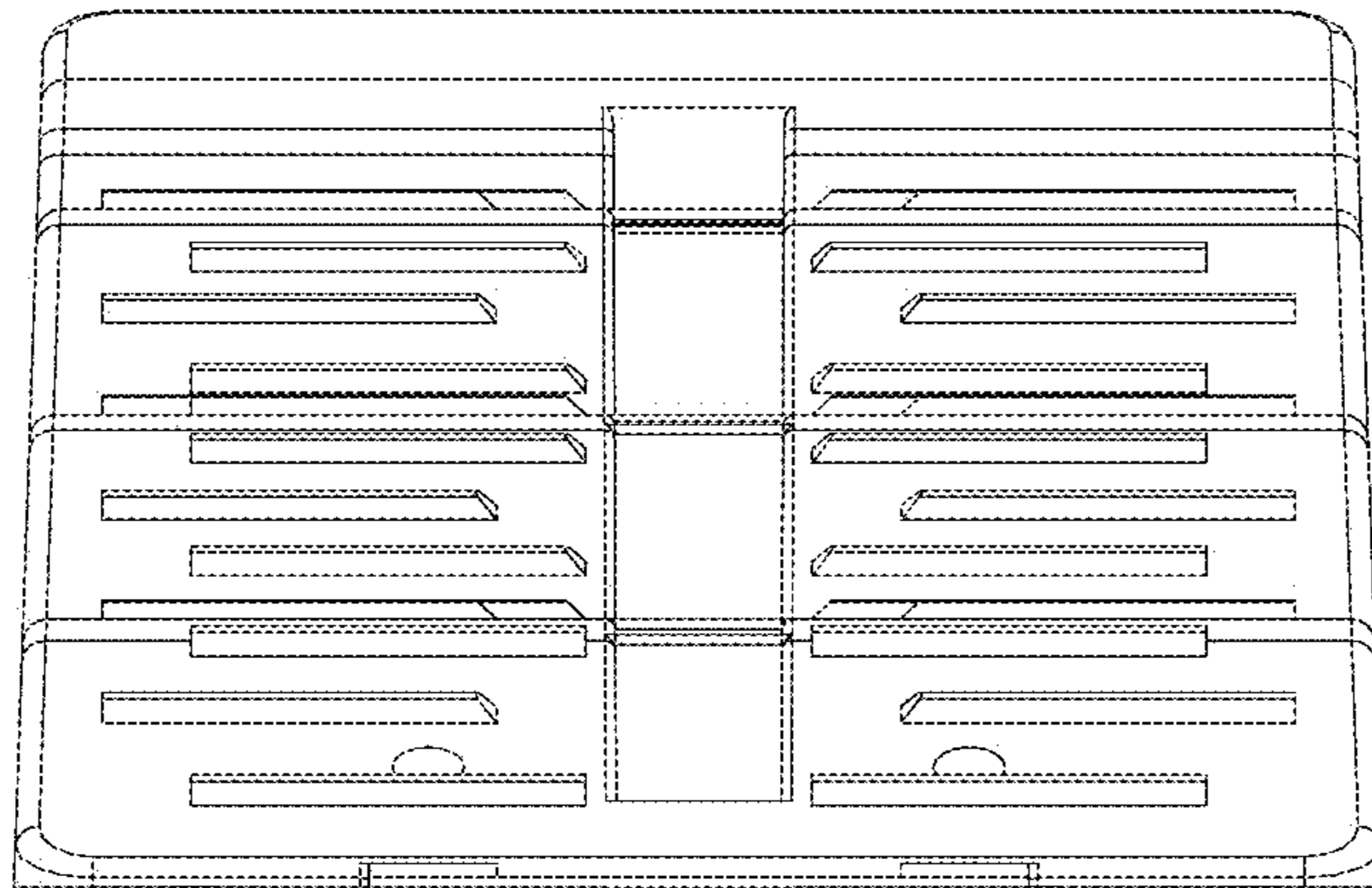

FIG. 7

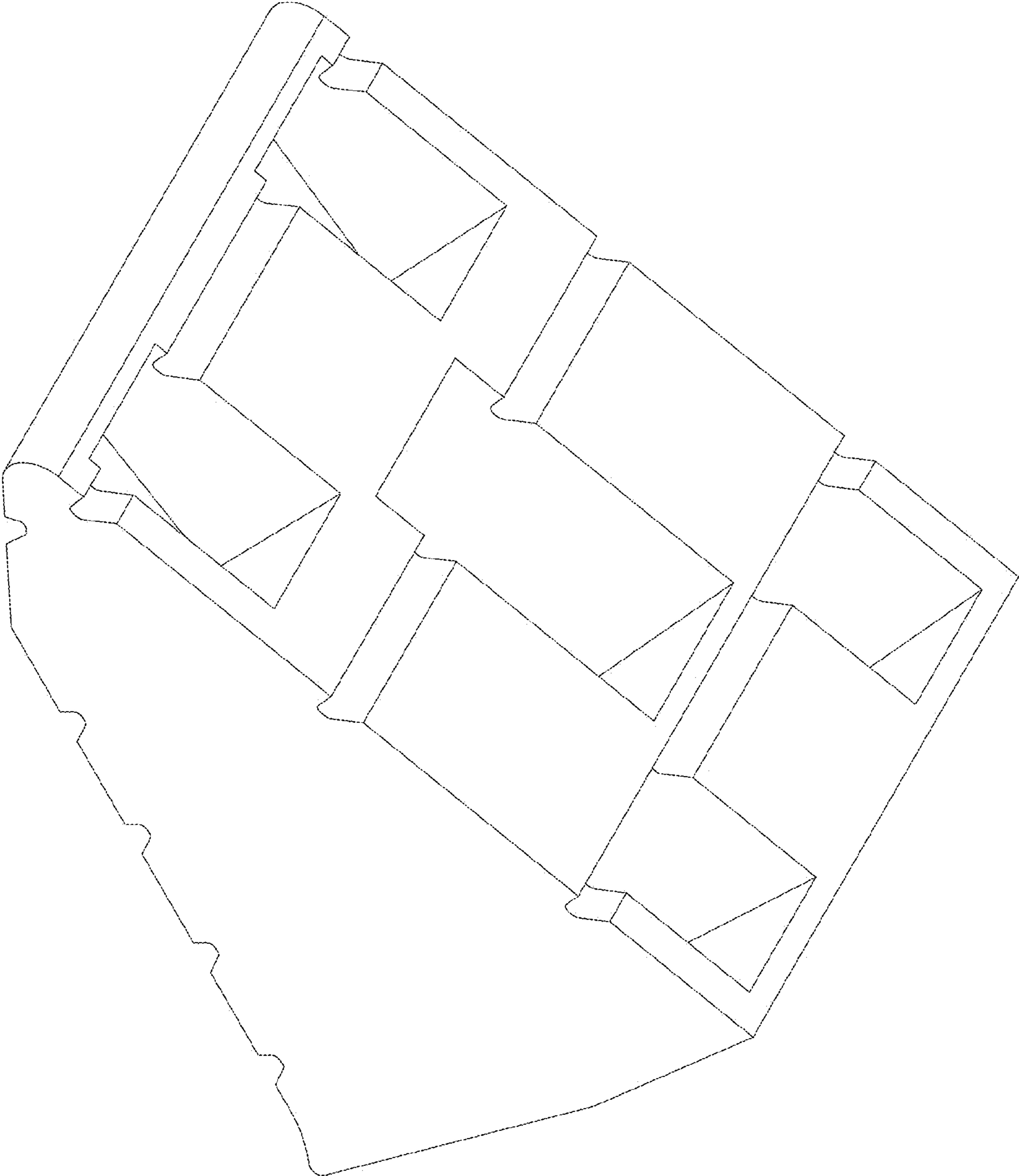

FIG. 8

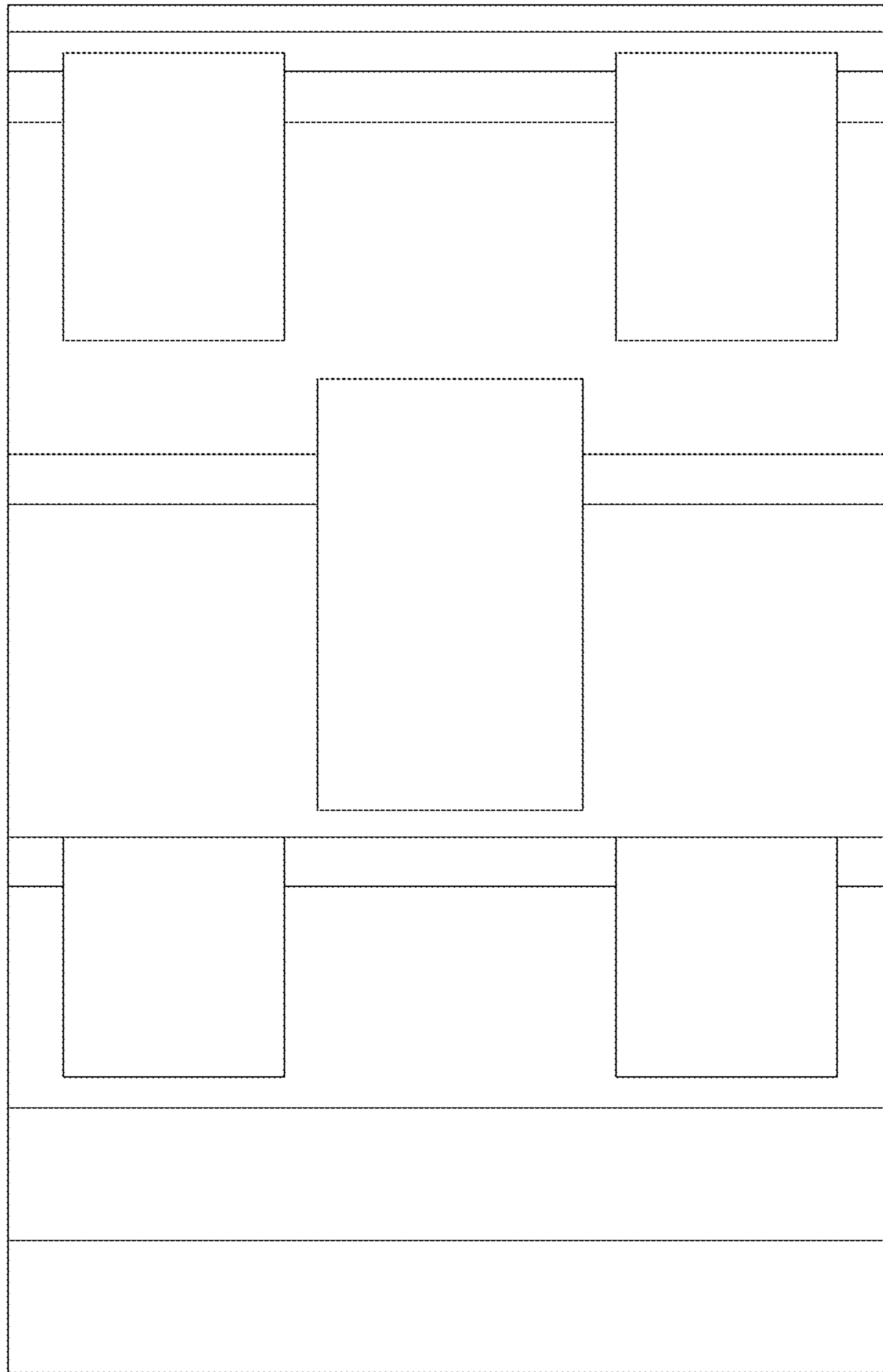

FIG. 9

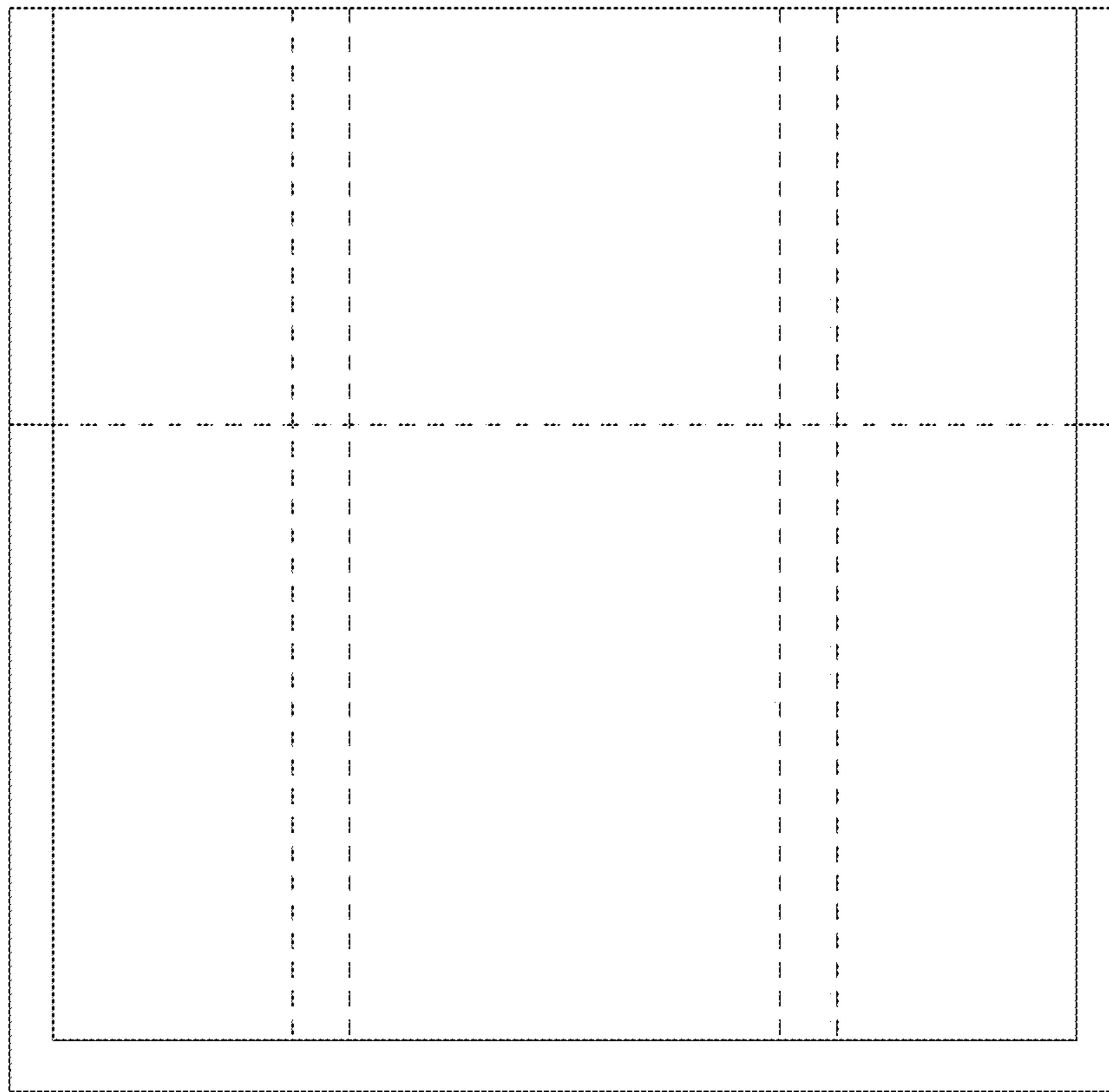

FIG. 10

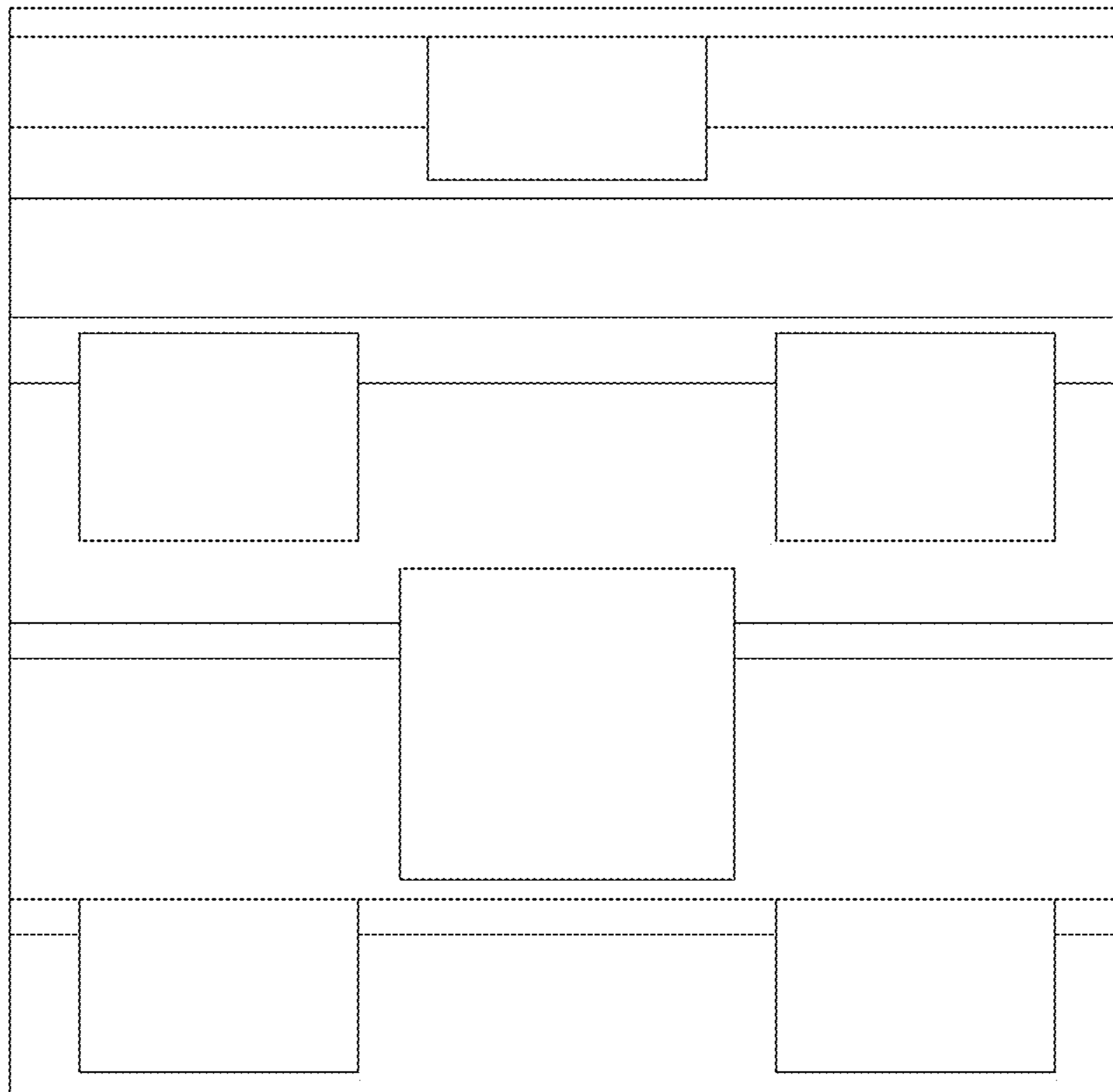

FIG. 11

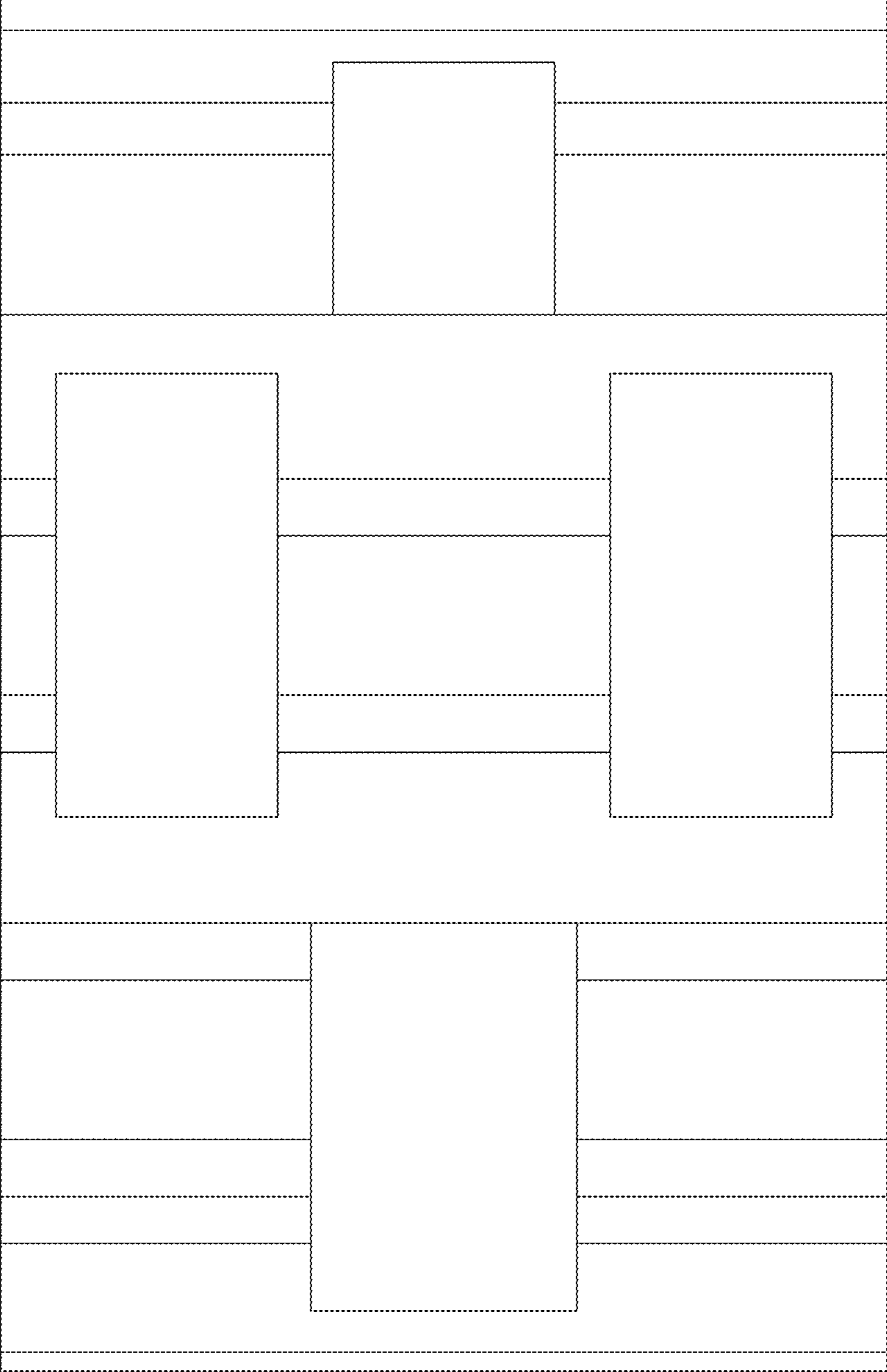

FIG. 12

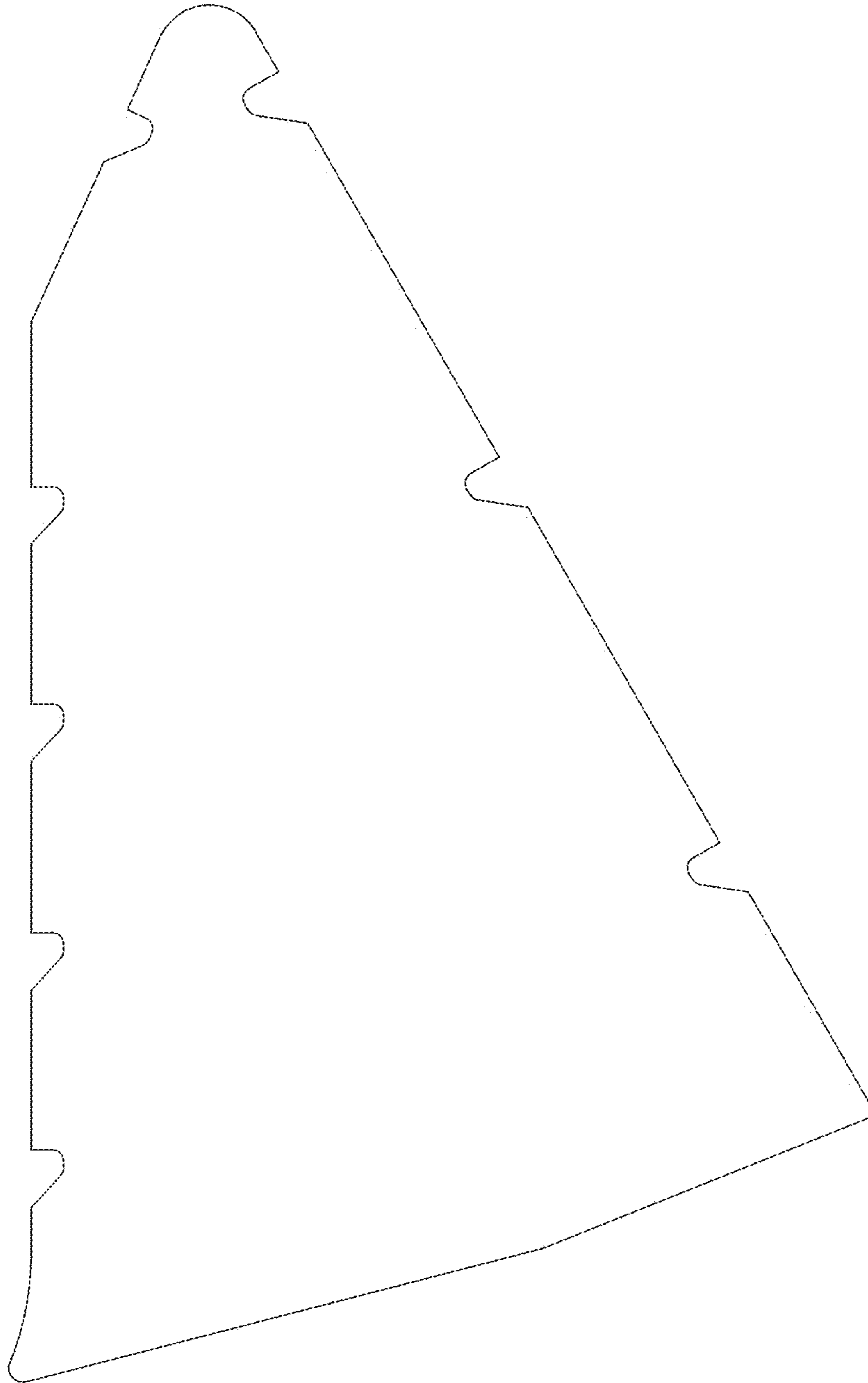

FIG. 13