



US00D989560S

(12) **United States Design Patent** (10) **Patent No.:** **US D989,560 S**
Ross (45) **Date of Patent:** **** Jun. 20, 2023**

(54) **WATER MUG BODY**
(71) Applicant: **BONGO LLC**, Austin, TX (US)
(72) Inventor: **Gary Ross**, Oxnard, CA (US)
(73) Assignee: **SPRINGER PETS**, Austin, TX (US)
(**) Term: **15 Years**

D443,980 S * 6/2001 Stewart D3/202
D455,610 S * 4/2002 Bridges D7/533
D483,982 S * 12/2003 Irvine D7/300.1
D487,020 S * 2/2004 Blank D9/542
D545,131 S * 6/2007 Seum D7/509
D569,263 S * 5/2008 Bradley D9/691
D581,738 S * 12/2008 Bodum D7/509

(Continued)

(21) Appl. No.: **29/793,342**
(22) Filed: **Apr. 5, 2022**
(51) **LOC (14) Cl.** **07-01**
(52) **U.S. Cl.**
USPC **D7/523**; D9/500
(58) **Field of Classification Search**
USPC D7/507, 509, 510, 511, 529, 531, 532,
D7/523, 533-536, 543, 392.1, 396.1,
D7/396.2, 300.1, 300.2, 608, 612;
D3/202; D26/9; D9/574, 516, 559, 563,
D9/500
CPC A47G 19/22; A47G 19/2288; A47G
19/2205; A47J 41/0077; A47J 41/0088
See application file for complete search history.

FOREIGN PATENT DOCUMENTS

CN 300724078 * 12/2007
CN 301941076 * 5/2012

(Continued)

OTHER PUBLICATIONS

Cooking Light [online] URL: <https://www.cookinglight.com/cooking-101/essential-ingredients/best-dijon-mustards> (site visited: Oct. 4, 2022) (Year: 2010).*

(Continued)

Primary Examiner — Jae Liang
Assistant Examiner — Tia Ruth-Renee Polidori
(74) *Attorney, Agent, or Firm* — Jonathan E. Grant Patent Services

(56) **References Cited**

U.S. PATENT DOCUMENTS

D87,167 S * 6/1932 Noble D9/559
D112,951 S * 1/1939 Soule D9/554
3,038,623 A * 6/1962 Schwarz A47J 41/0077
215/12.1
D283,595 S * 4/1986 Fortuna D9/500
4,714,550 A * 12/1987 Malson C02F 1/003
222/401
D325,687 S * 4/1992 Embree D7/533
D400,442 S * 11/1998 Nosella D9/500
D409,921 S * 5/1999 Jones D9/558
D424,444 S * 5/2000 Lefebvre D9/503
D425,422 S * 5/2000 David D9/503
6,159,513 A * 12/2000 Judlowe B65D 55/0818
426/115

(57) **CLAIM**

The ornamental design for a water mug body, as shown and described.

DESCRIPTION

FIG. 1—is a a top perspective view of a water mug body showing the new design;
FIG. 2—is a left side view thereof;
FIG. 3—is a right side view thereof;
FIG. 4—is a front view thereof;
FIG. 5—is a rear view thereof;
FIG. 6—is a top plan view thereof; and,
FIG. 7—is a bottom plan thereof.

1 Claim, 4 Drawing Sheets

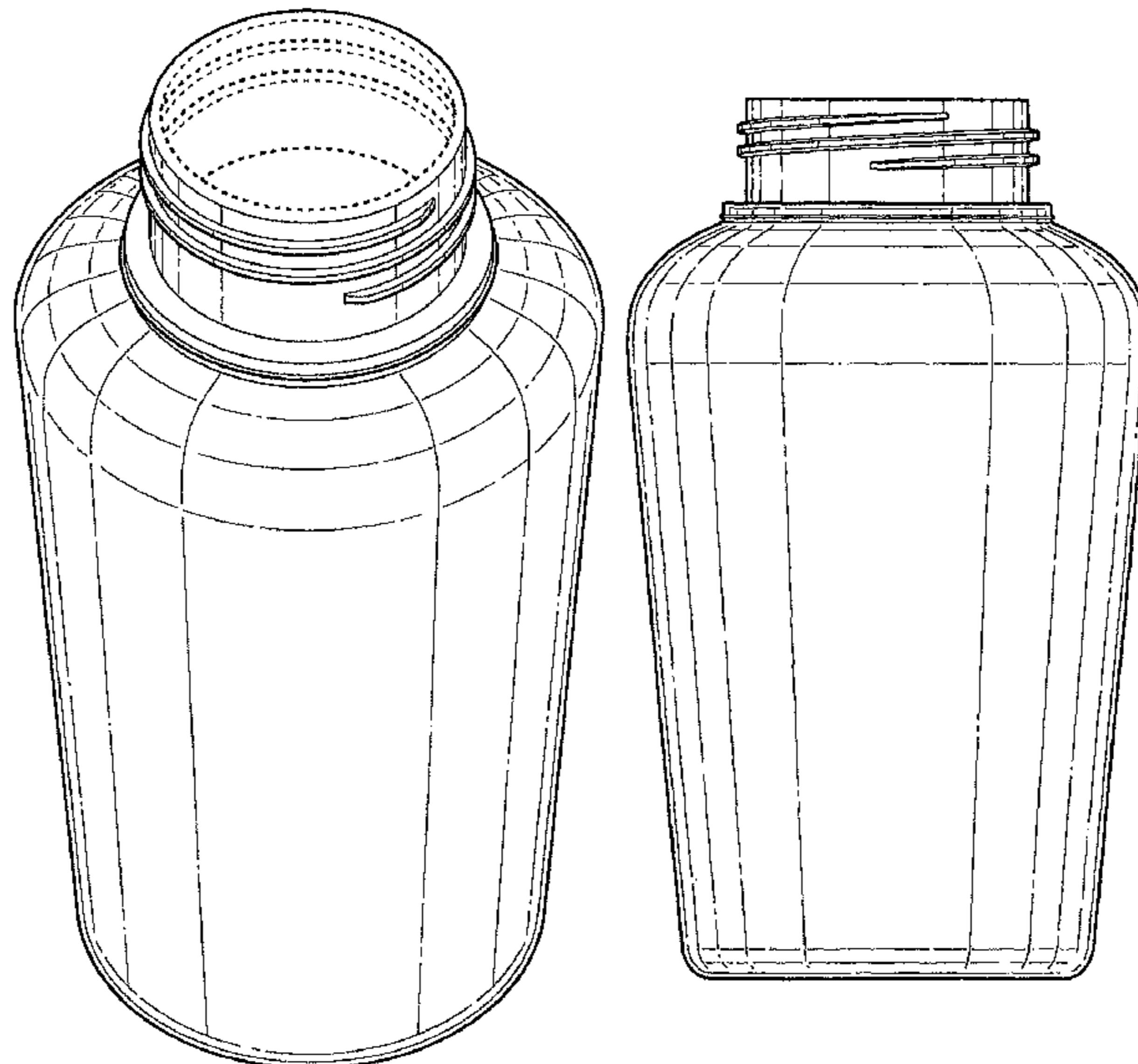

(56)

References Cited

U.S. PATENT DOCUMENTS

D587,594 S * 3/2009 Crawford D9/563
D596,505 S * 7/2009 Diss D9/500
D596,958 S * 7/2009 Diss D9/500
D654,752 S * 2/2012 Krasner D7/300.1
D754,999 S * 5/2016 Gamelli D7/300.1
D802,422 S * 11/2017 Laib D9/500
D806,379 S * 1/2018 Korfonta D3/202
D832,058 S * 10/2018 Pisarevsky D9/500
D849,540 S * 5/2019 Robinson D9/500
D889,114 S * 7/2020 Huang D3/202
2017/0367536 A1 * 12/2017 Wall A47G 19/2288

FOREIGN PATENT DOCUMENTS

CN 302751672 * 4/2014
CN 305653350 * 3/2020
CN 306326844 * 2/2021

OTHER PUBLICATIONS

Pro Impact [online] URL: <https://www.amazon.com/Pro-Impact-Lacrosse-Squeezable-Plastic/dp/B07Z6JXC56> (site visited: Oct. 4, 2022) (Year: 2019).*

Gets [online] URL: <https://www.amazon.com/Stainless-Bottle-Vacuum-Insulated-Tumbler/dp/B08PP7BJPV> (site visited: Oct. 4, 2022) (Year: 2020).*

* cited by examiner

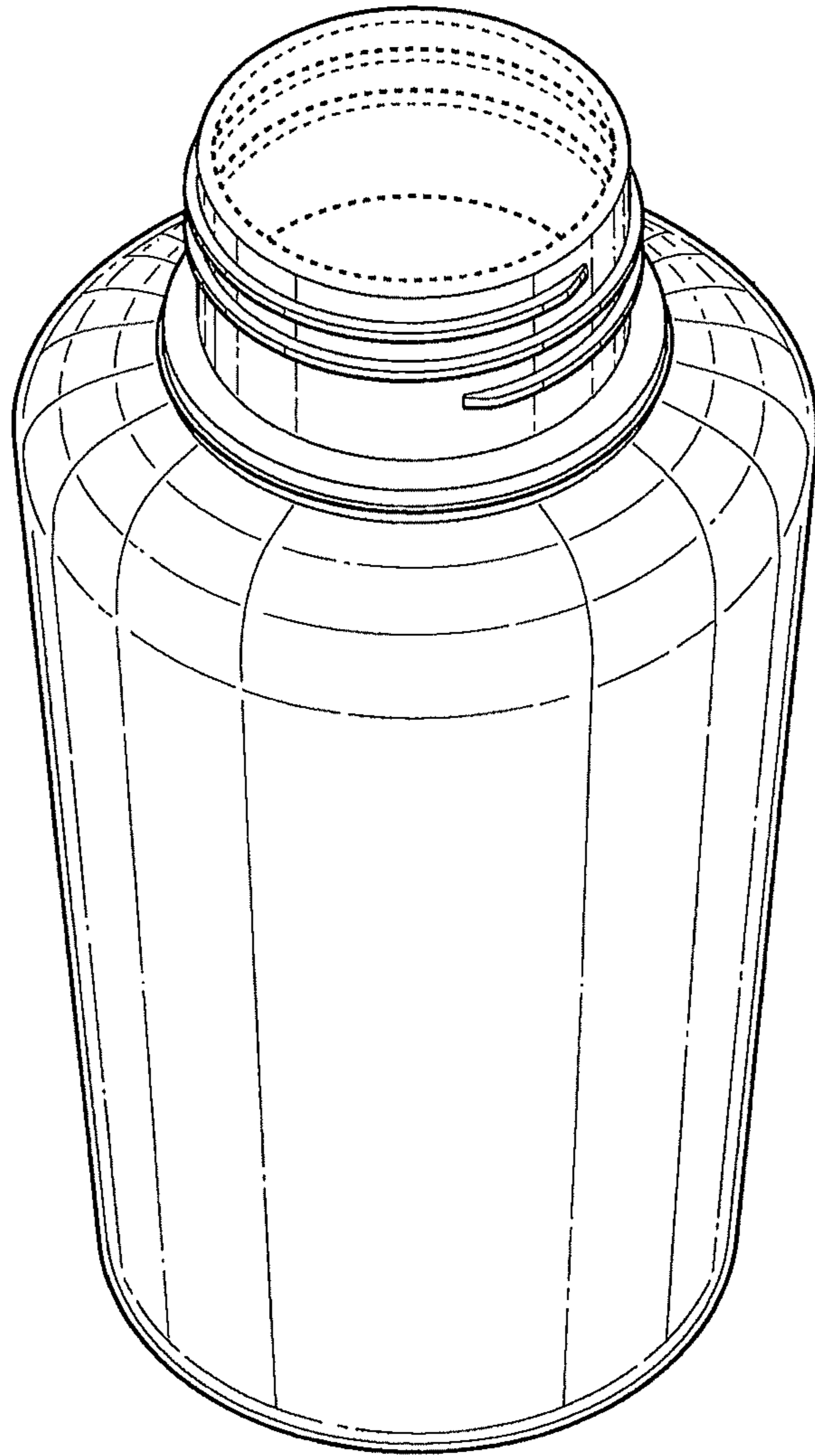

FIG. 1

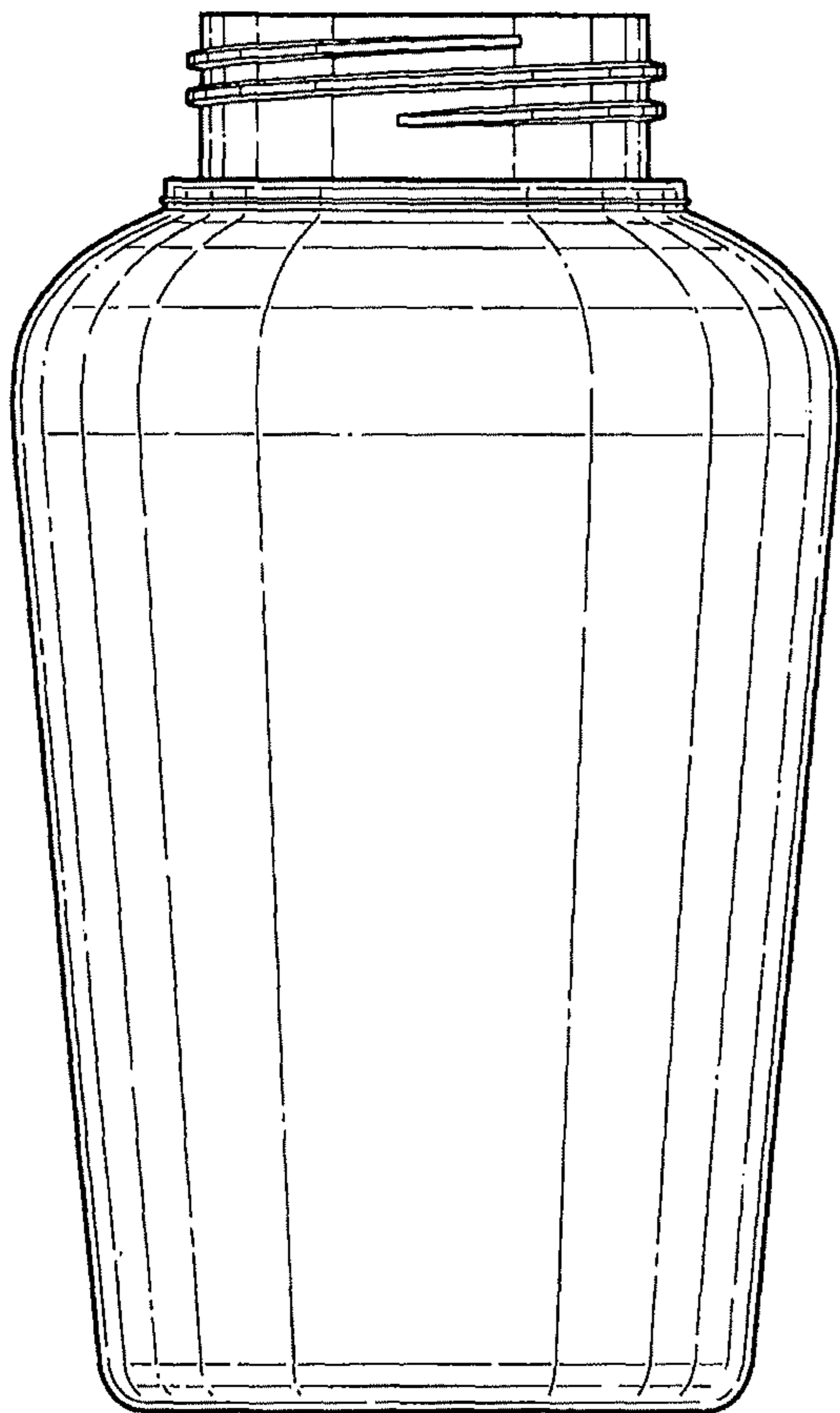

FIG. 2

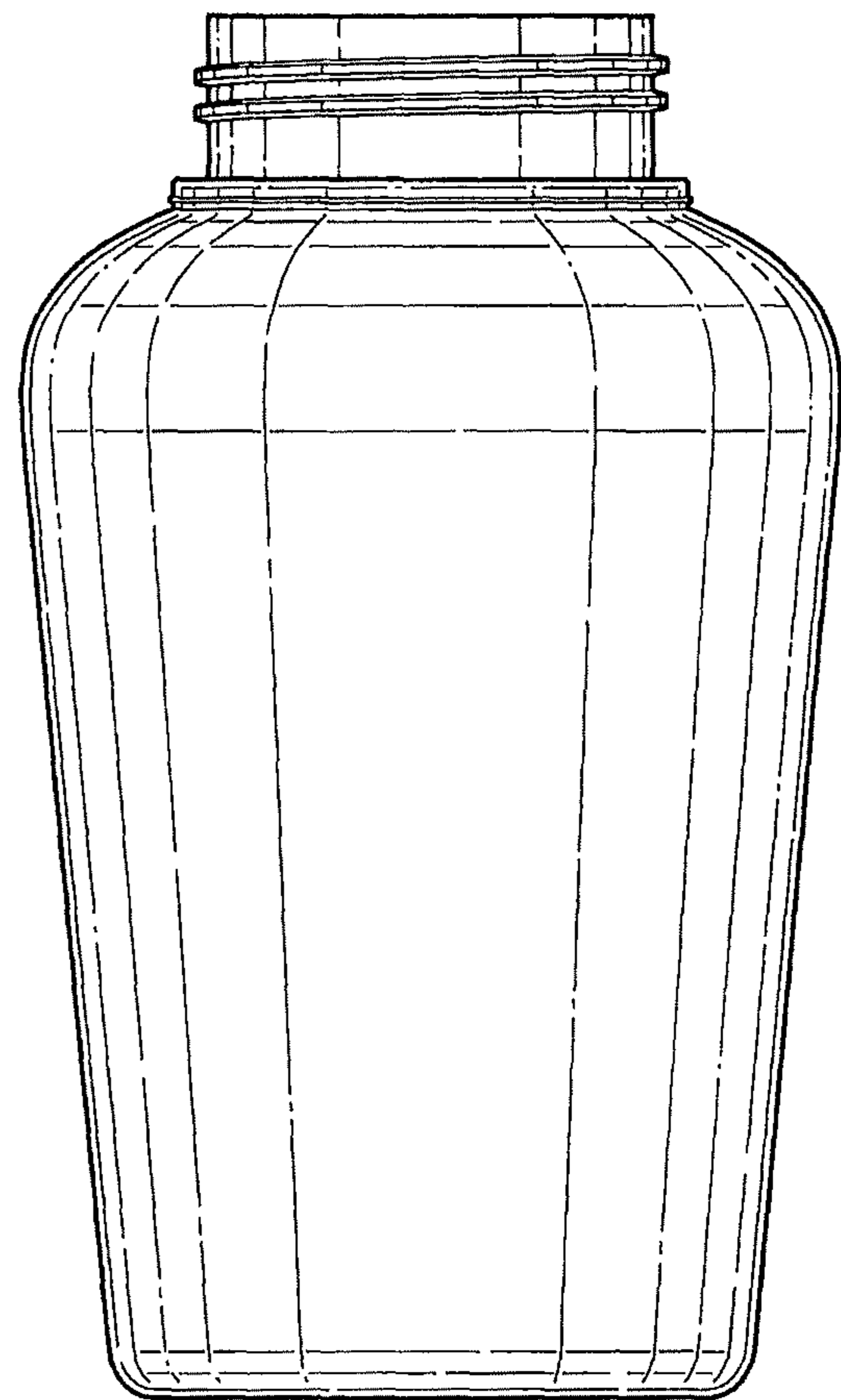

FIG. 3

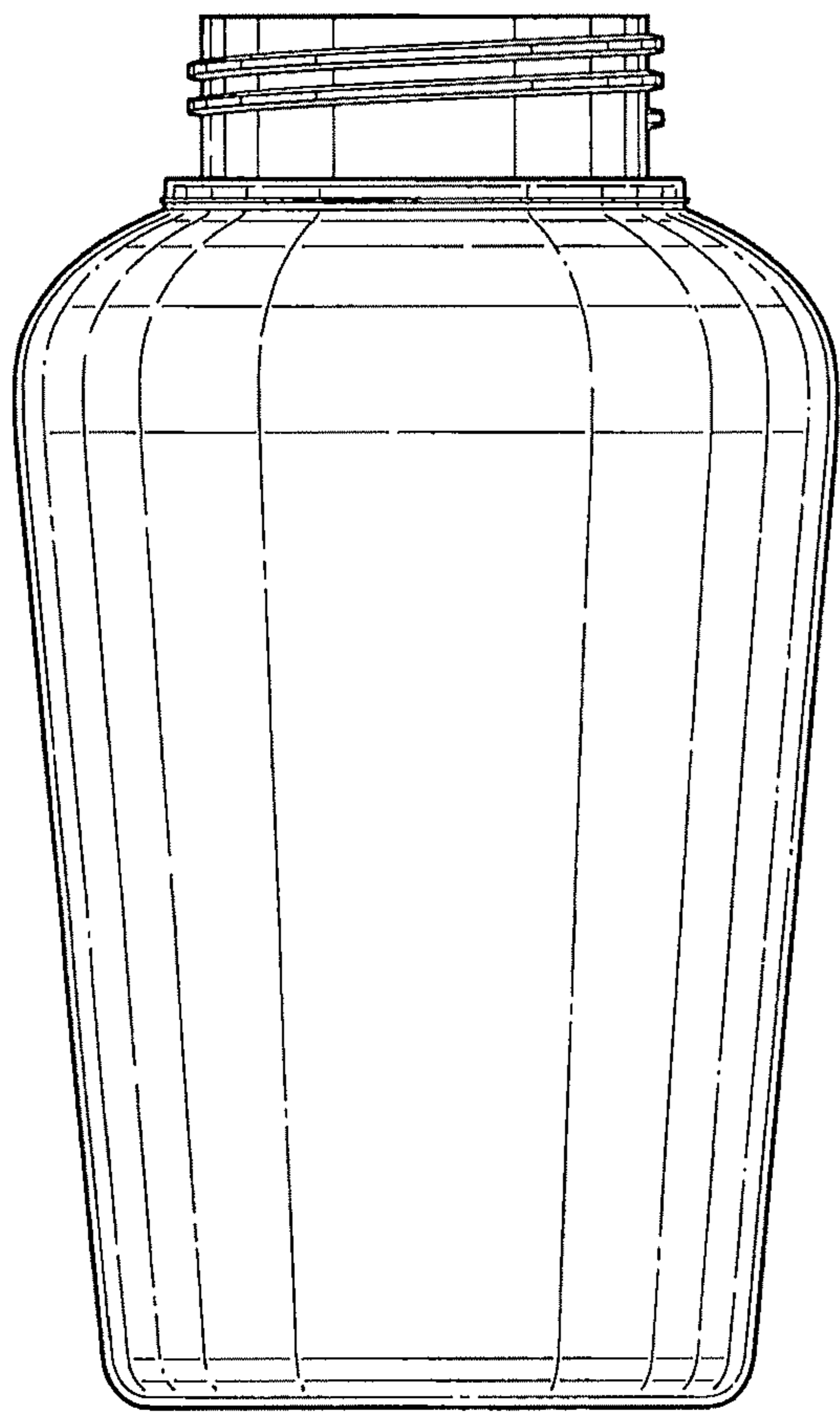

FIG. 4

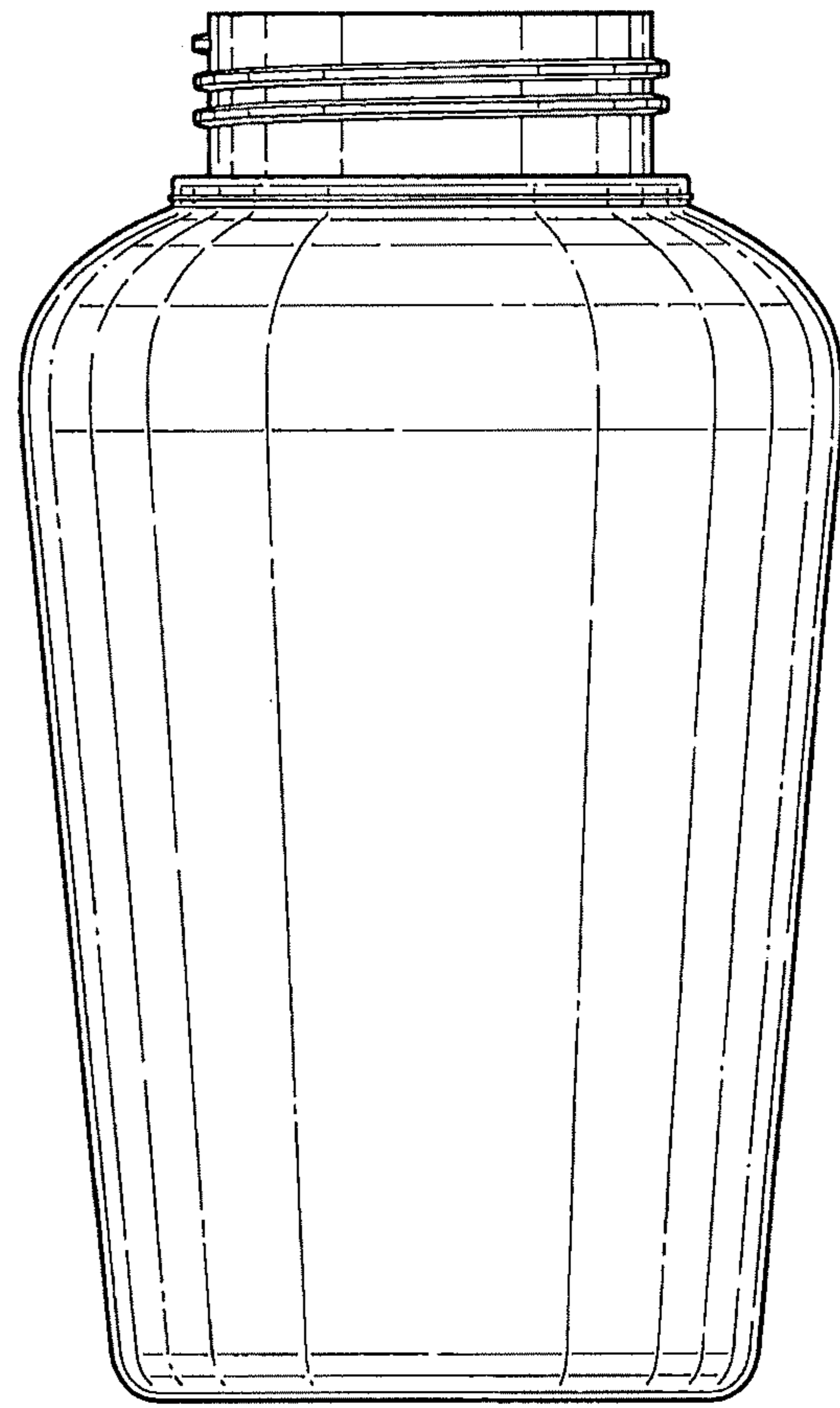

FIG. 5

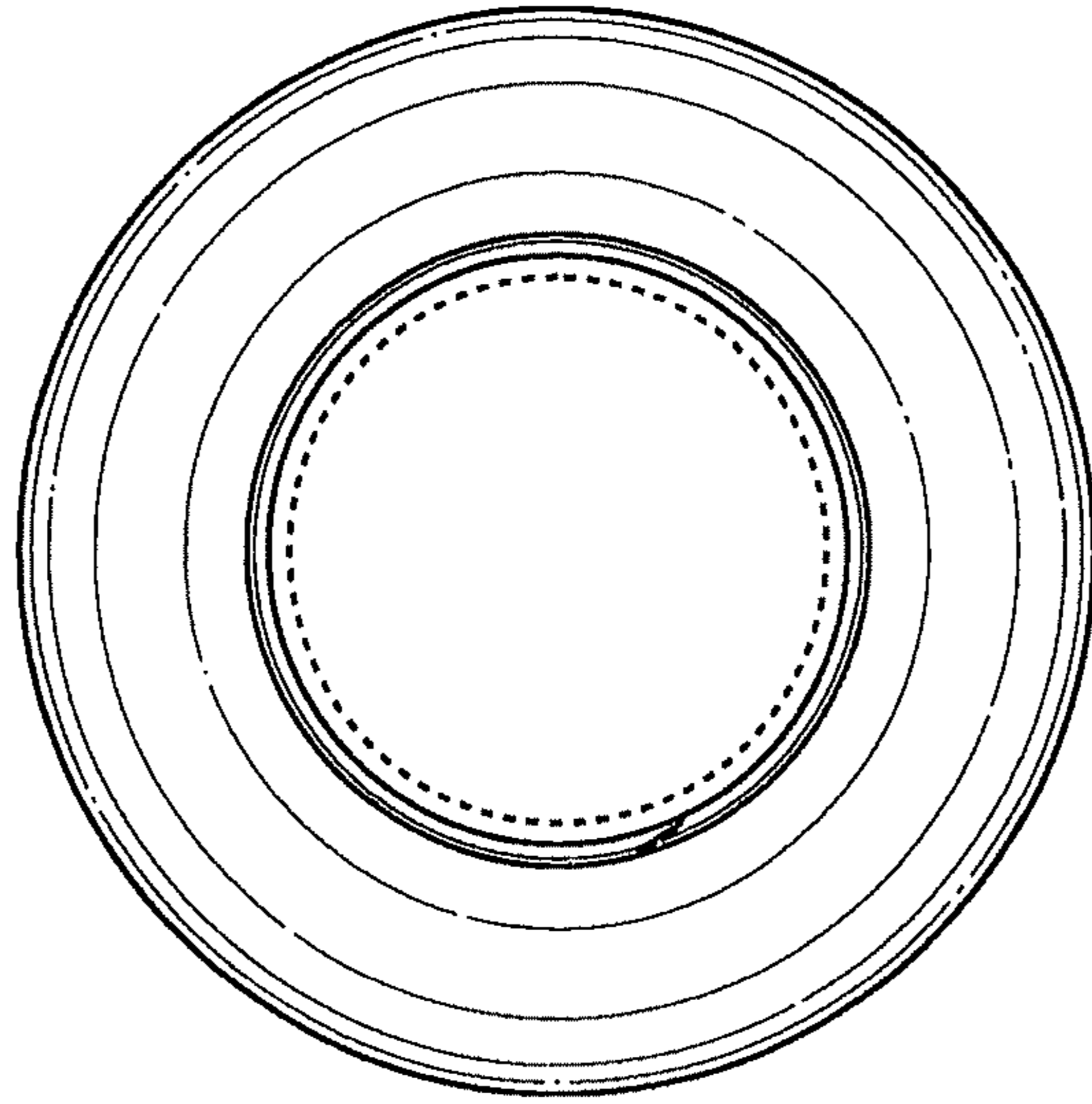

FIG. 6

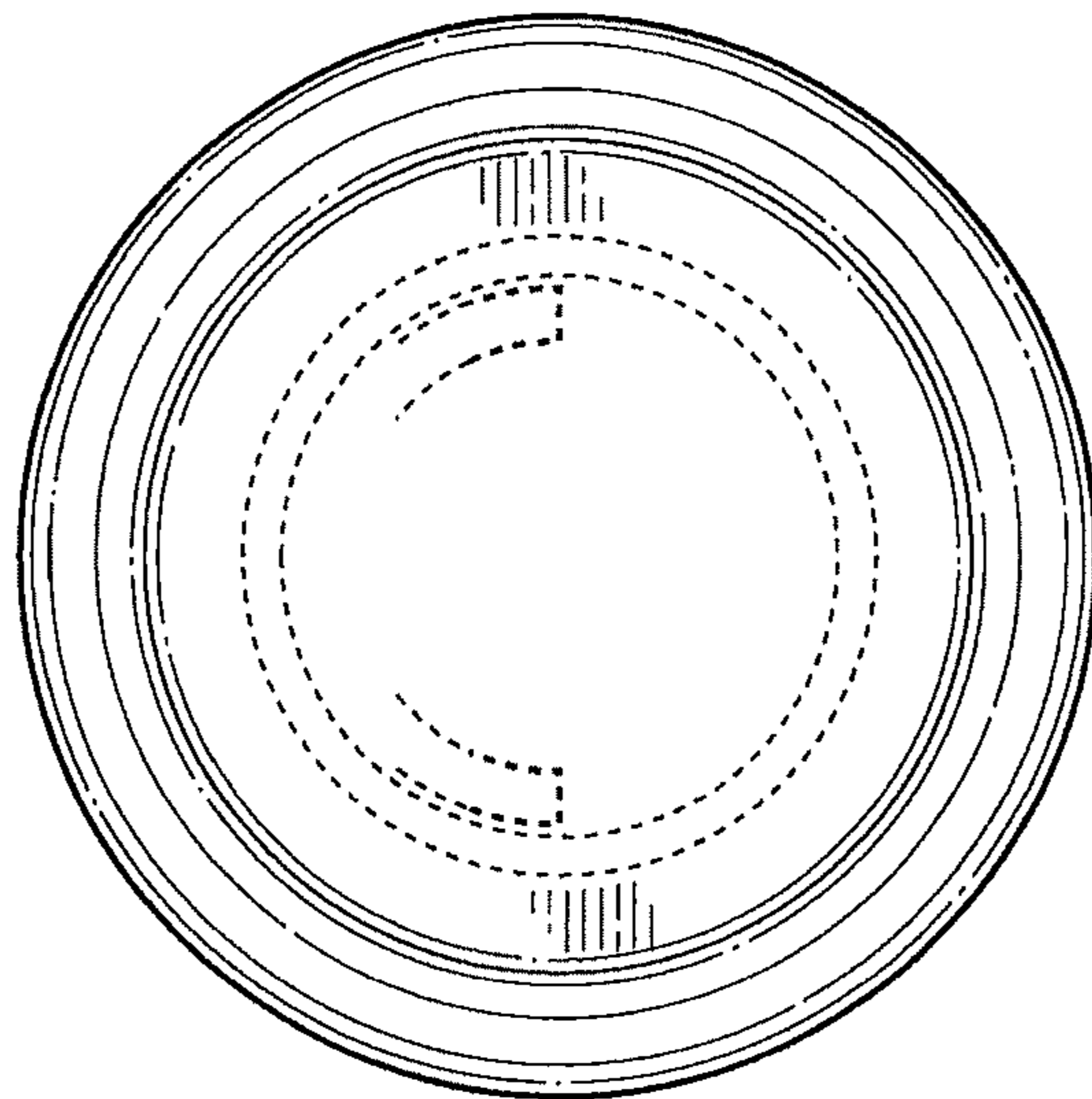

FIG. 7