



US00D989532S

(12) **United States Design Patent** (10) **Patent No.:** **US D989,532 S**
Lykouria et al. (45) **Date of Patent:** **** Jun. 20, 2023**

(54) **CHAIR**

(71) Applicant: **RAINLIGHT STUDIO LLC**, New York, NY (US)

(72) Inventors: **Yorgo Lykouria**, London (GB); **Pierce Brennan**, Peckham (GB); **James Bennett**, London (GB)

(73) Assignee: **RAINLIGHT STUDIO LLC**, New York, NY (US)

(**) Term: **15 Years**

(21) Appl. No.: **29/794,979**

(22) Filed: **Jun. 16, 2021**

(30) **Foreign Application Priority Data**

Dec. 18, 2020 (JP) 2020-027401 D

(51) **LOC (14) Cl.** **06-06**

(52) **U.S. Cl.**
USPC **D6/716**

(58) **Field of Classification Search**
USPC D6/334, 366, 367, 372, 373, 374, 379,
D6/380, 716-716.5, 360

CPC A47C 1/02; A47C 1/022; A47C 1/024;
A47C 3/12; A47C 3/18; A47C 3/026;
A47C 7/18; A47C 7/36; A47C 7/40;
A47C 7/46; A47C 1/03294; A47C 1/034;
A47C 1/032; A47C 1/031; A47C 1/023;
A47C 3/029; A47C 3/027; A47C 3/04;
A47C 4/03; A47C 4/04; A47C 5/12;
A47C 7/029; A47C 7/02; A47C 7/28;
A47C 7/32; A47C 7/38; A47C 7/44;
A47C 7/54; A47C 7/425; A47C 7/445;
A47C 31/023; A47C 31/04; A47C 1/14;
A47C 1/03244; A47C 4/20; A47C 4/28;
A47C 4/30; A47C 4/42; A47C 4/46;
A47C 4/54; A47C 4/286; A47C 7/06;
A47C 7/24; A47C 7/66; A47C 7/68;
A47C 7/62; A47C 7/624; A47C 7/622;
A47C 7/407; A47C 9/06; A47C 9/00;

A47C 9/10; A47C 9/105; A47C 11/00;
A47C 11/005; A47C 15/00; A47C 21/00;
A47C 31/00; A47C 4/02; B60R 2/0284;
B60R 2/062; B60R

(Continued)

(56) **References Cited**

U.S. PATENT DOCUMENTS

D196,429 S * 10/1963 Johnson D6/366
D196,719 S * 10/1963 Johnson D6/366

(Continued)

OTHER PUBLICATIONS

Swan Chair, posted unknown [online], [retrieved Mar. 1, 2023]. Retrieved from internet, <https://www.danishdesignstore.com/products/fritz-hansen-swan-chair-design-arne-jacobsen> (Date:2023) (Year: 2023).*

(Continued)

Primary Examiner — Christian P. McLean
Assistant Examiner — Kristopher Michael Blechschmidt
(74) *Attorney, Agent, or Firm* — Sughrue Mion, PLLC

(57) **CLAIM**

The ornamental design for a chair, as shown and described.

DESCRIPTION

FIG. 1 is a front and right perspective view of a chair, showing our new design;
FIG. 2 is a rear and left perspective view thereof;
FIG. 3 is a front elevation view thereof;
FIG. 4 is a rear elevation view thereof;
FIG. 5 is a left side elevation view thereof;
FIG. 6 is a right side elevation view thereof;
FIG. 7 is a top plan view thereof; and,
FIG. 8 is a bottom plan view thereof.
The broken lines shown in the drawings illustrate portions of the chair that form no part of the claimed design.

1 Claim, 8 Drawing Sheets

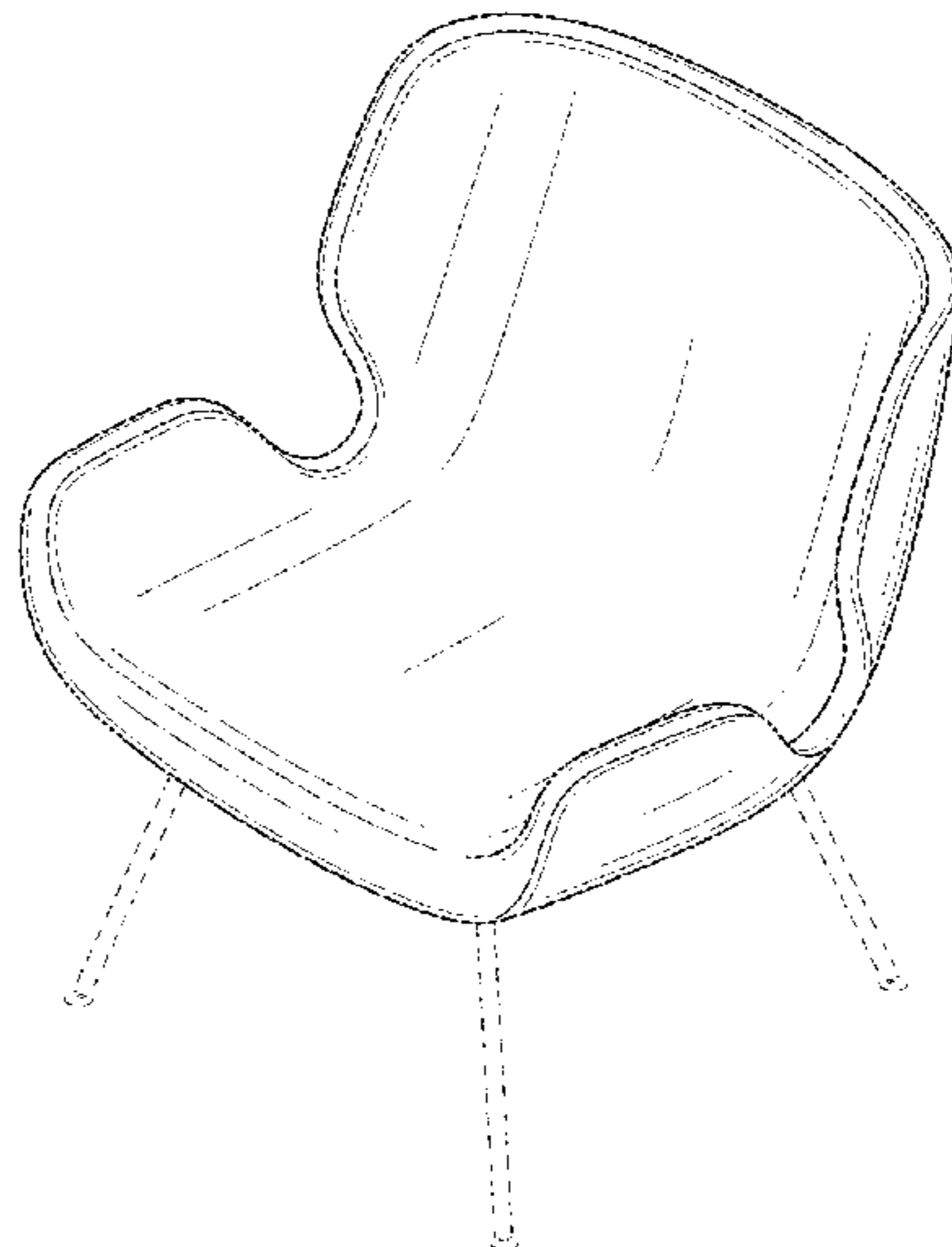

(58) **Field of Classification Search**

CPC 22/001; B60R 22/24; B60R 22/28; B60R 22/58; B60R 22/64; B60R 22/68; B60R 22/80; B60R 22/99; B60R 22/245; B60R 22/643; B60R 22/646; B60R 22/665; B60R 22/686; B60R 22/688; B60R 22/803; B60R 22/986; B60R 22/914; B60R 22/995; F16B 2/08; F16B 45/00; Y10S 297/01; Y10S 35/901; A47D 13/10; B60N 2/00; B60N 2/20; B60N 2/58; B60N 2/64; B60N 2/646; B60N 2/686; B60N 2/86; B60N 2/803; B60N 2/806; B60N 2/04; A47B 5/00; A01M 31/00; A01M 31/02; A01M 31/025; A45F 3/22; A45F 3/24; A47G 9/06; A61G 7/10; A63B 63/00; B25H 1/14; B25H 1/12; B25H 1/04; E04H 15/30; F16M 11/22; F42B 12/38; F41A 23/14; F41A 23/16; F41A 23/18; F41C 27/00

See application file for complete search history.

(56) **References Cited**

U.S. PATENT DOCUMENTS

D222,745 S * 12/1971 Bernard D6/364
 D255,183 S * 6/1980 Locher D6/366

D531,420 S * 11/2006 Kita D6/366
 D646,496 S * 10/2011 Fukasawa D6/375
 D678,690 S * 3/2013 Eldoy D6/366
 D702,451 S * 4/2014 Hayon D6/375
 D720,146 S * 12/2014 Fukasawa D6/375
 D801,716 S * 11/2017 Fukasawa D6/366
 D899,799 S * 10/2020 Li D6/366
 D907,422 S * 1/2021 Izawa D6/716.4
 D925,243 S * 7/2021 Li D6/366

OTHER PUBLICATIONS

Okamura, posted unknown [online], [retrieved Mar. 2, 2023]. Retrieved from internet, [https://www.okamura.com/en-ap/product-detail/collaborative/phlox/\(Date:2023\) \(Year: 2023\).](https://www.okamura.com/en-ap/product-detail/collaborative/phlox/(Date:2023) (Year: 2023).)*

Living Divani, posted 2022 [online], [retrieved Mar. 2, 2023]. Retrieved from internet, [https://livingdivani.it/en/products-materials/armchairs/oolong/ \(Date:2023\) \(Year: 2022\).](https://livingdivani.it/en/products-materials/armchairs/oolong/ (Date:2023) (Year: 2022).)*

Moby Two-seater, posted Sep. 20, 2017 [online], [retrieved Mar. 1, 2023]. Retrieved from internet, [https://www.retrotogo.com/2017/09/moby-two-seater-retro-sofa-at-made.html \(Date:2023\) \(Year: 2017\).](https://www.retrotogo.com/2017/09/moby-two-seater-retro-sofa-at-made.html (Date:2023) (Year: 2017).)*

* cited by examiner

FIG. 1

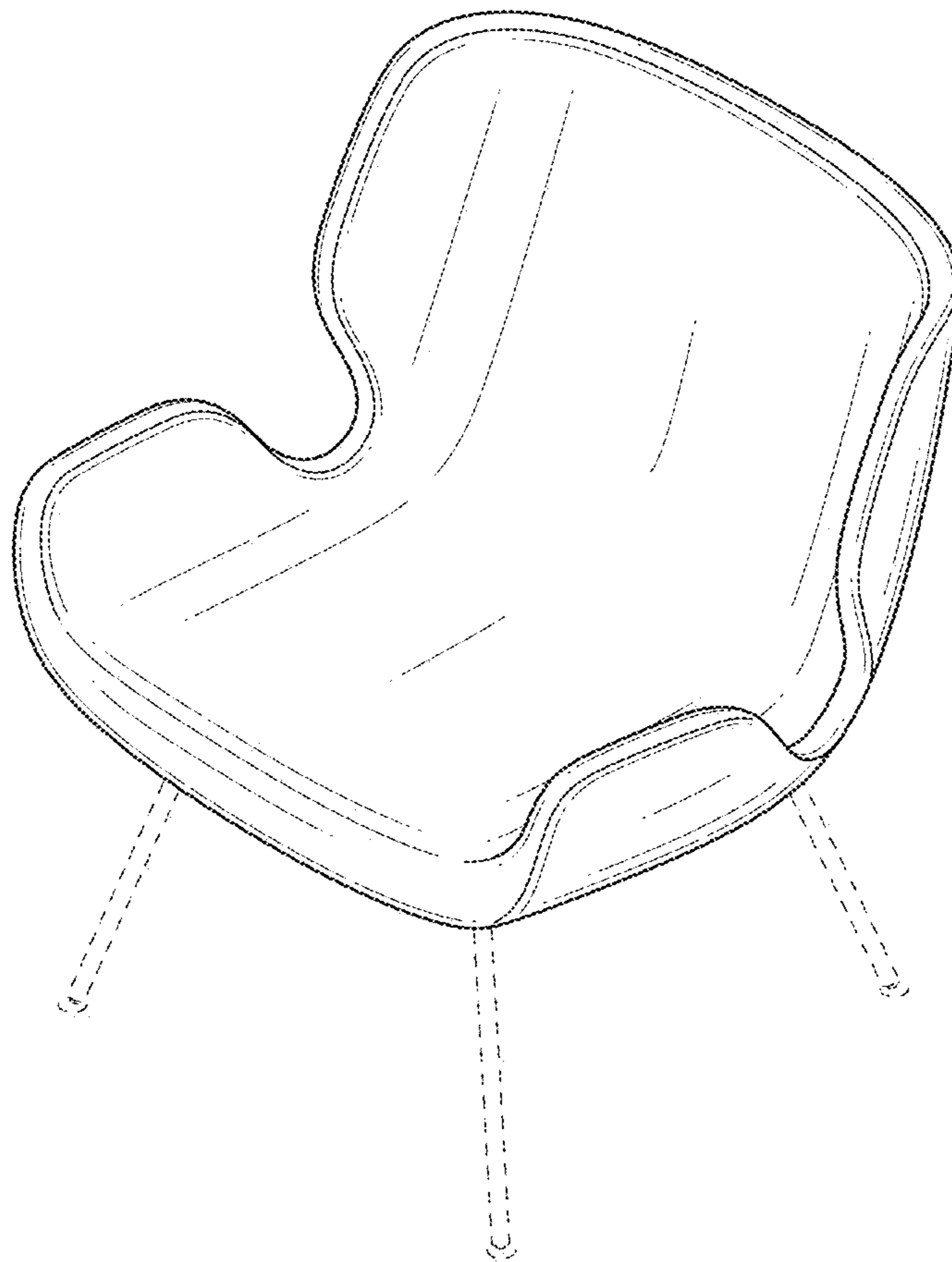

FIG. 2

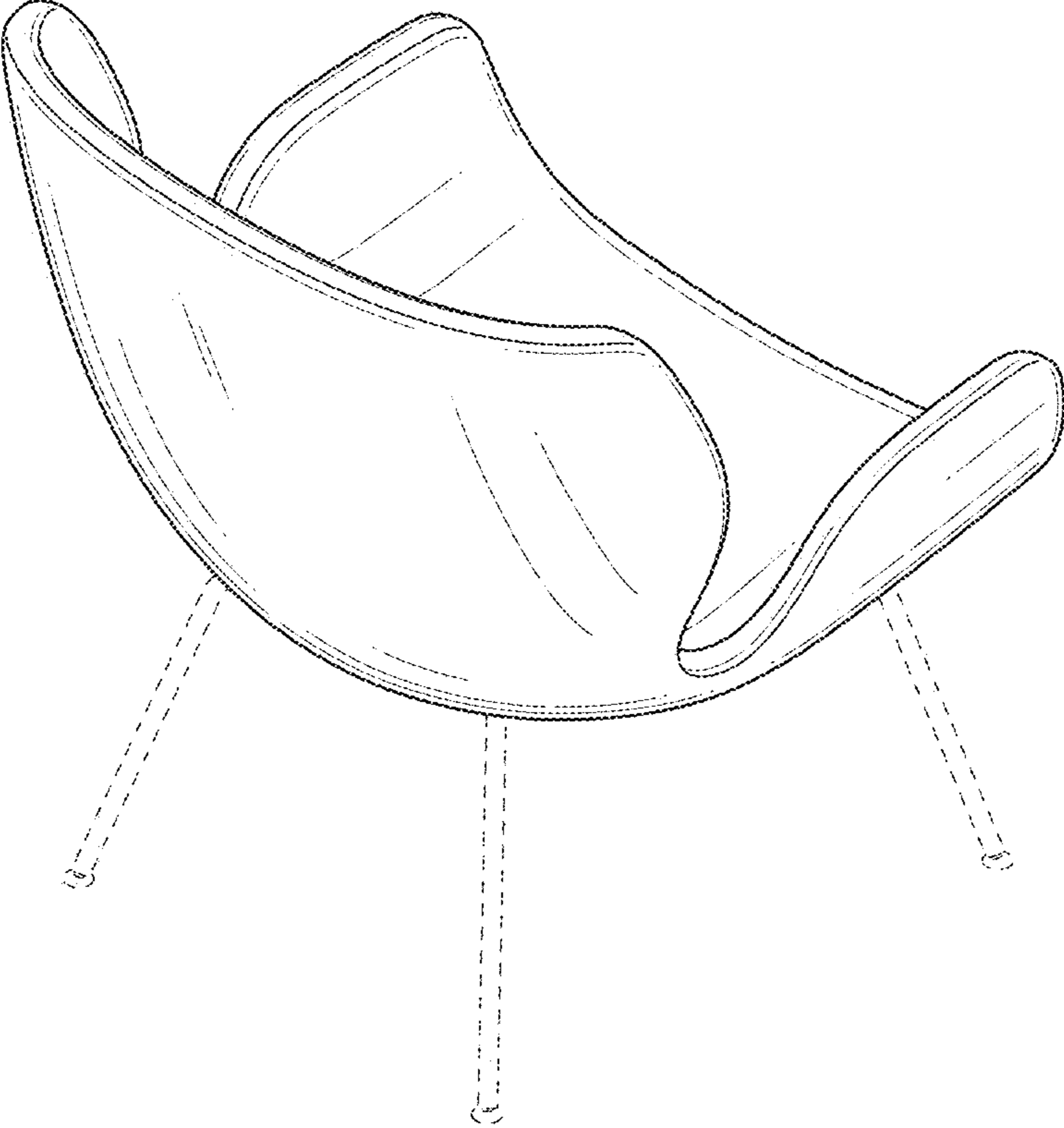

FIG. 3

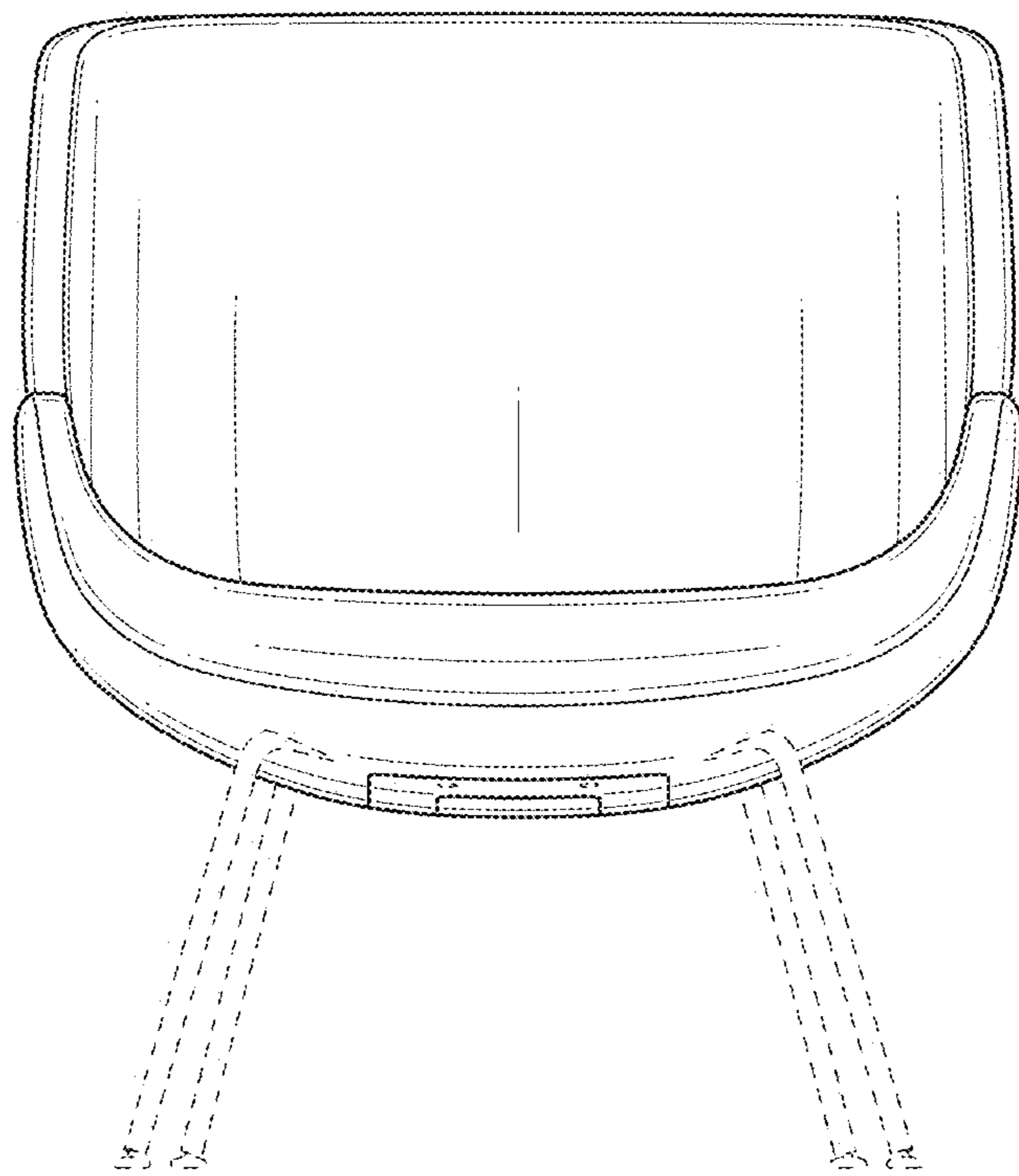

FIG. 4

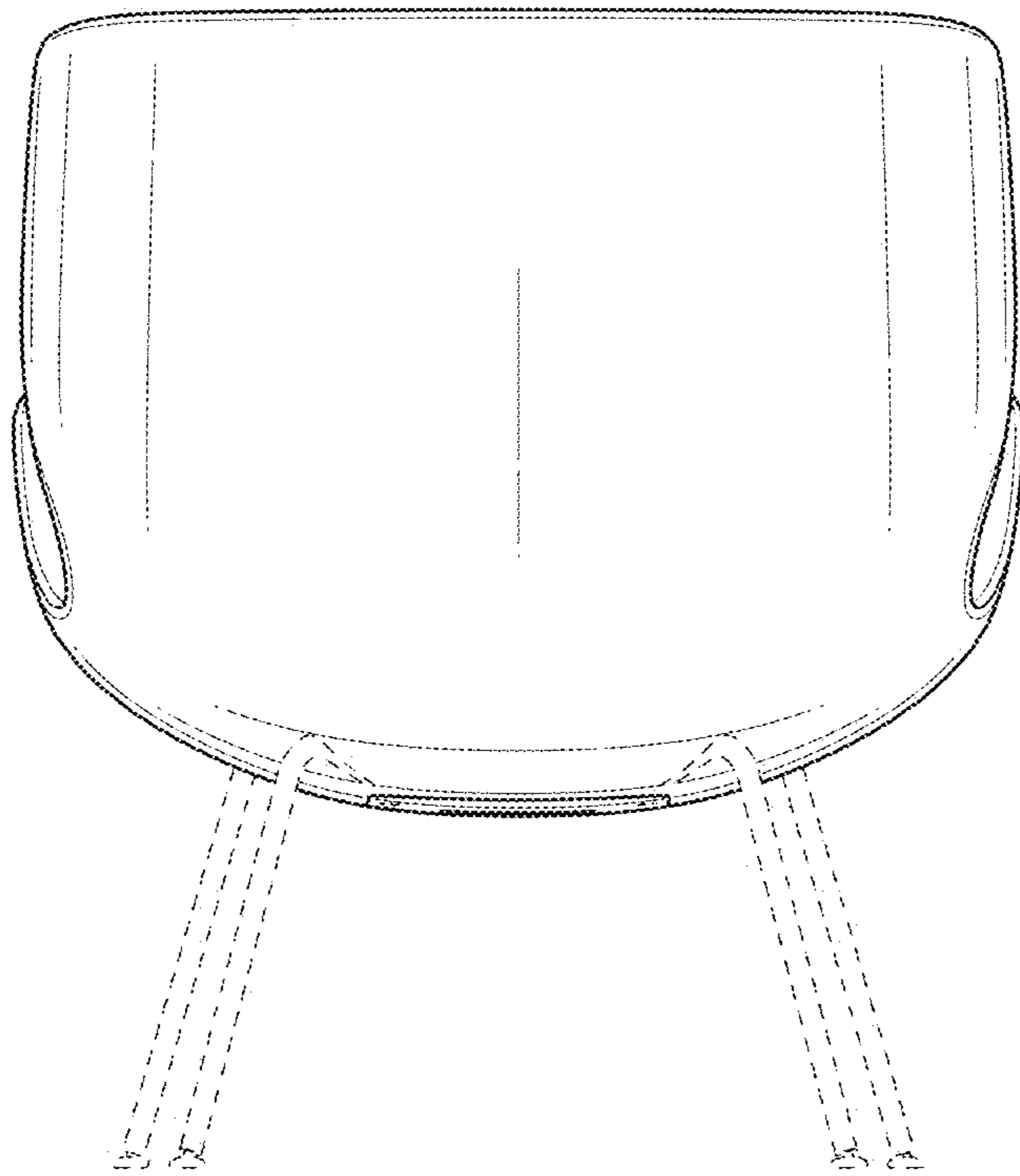

FIG. 5

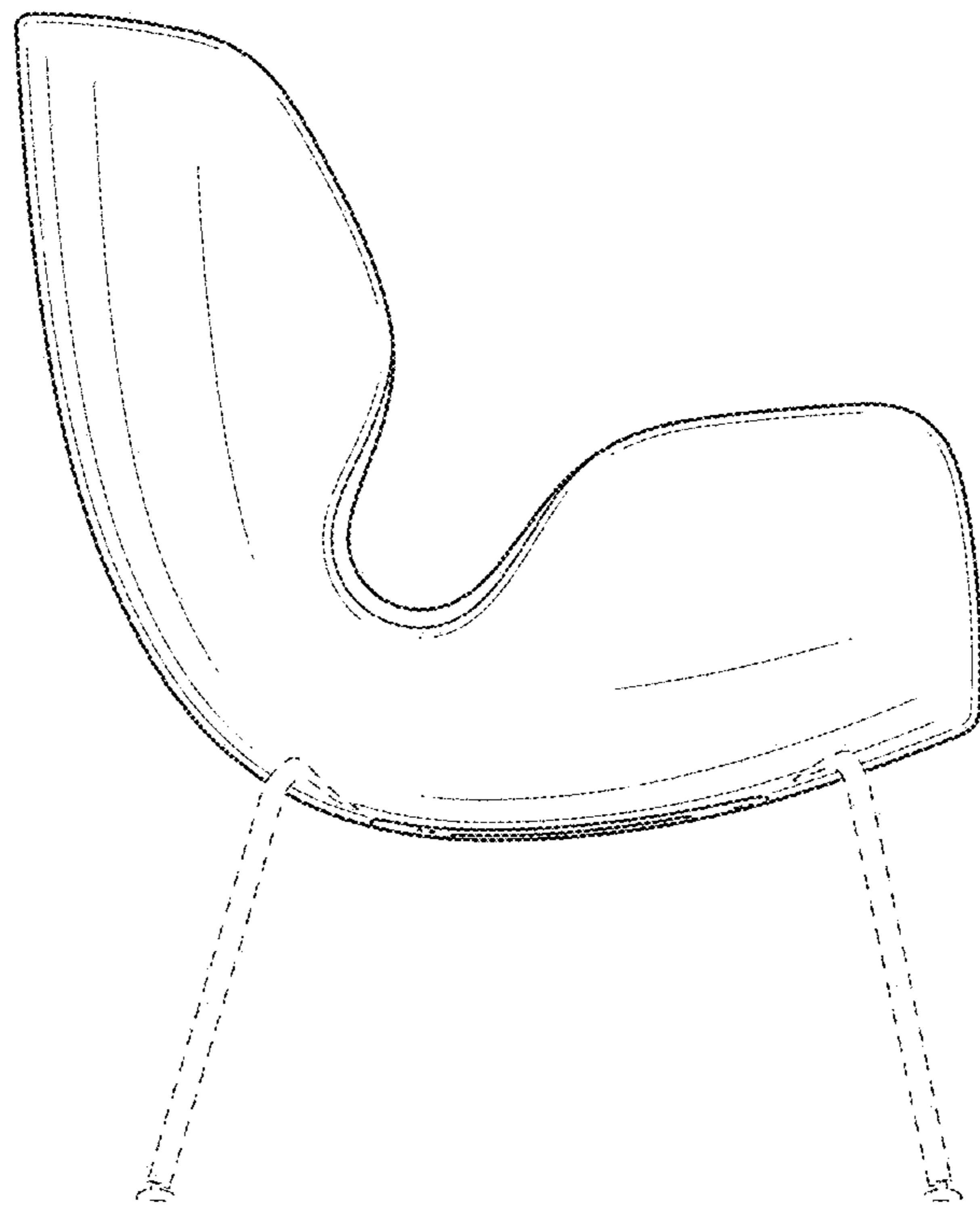

FIG. 6

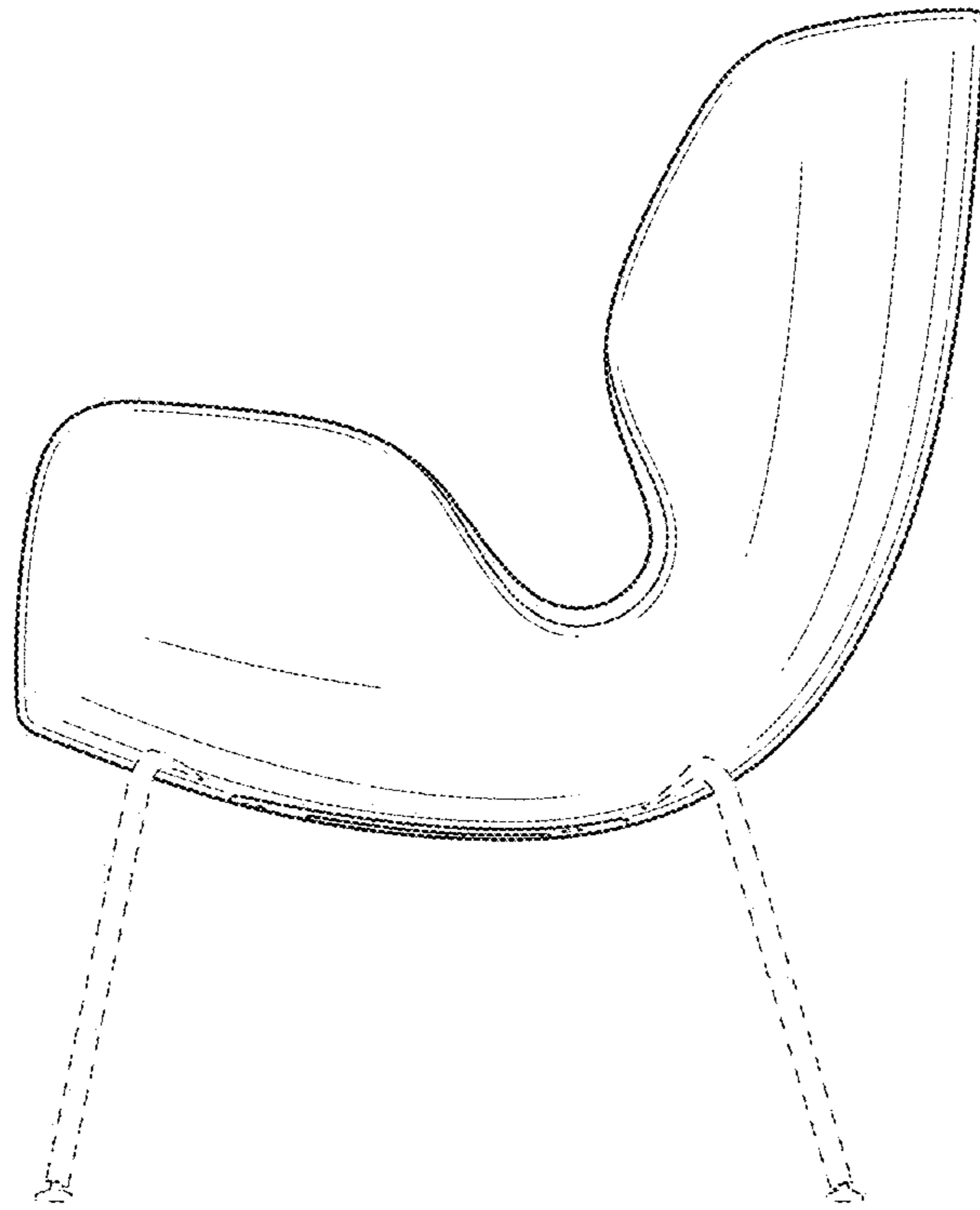

FIG. 7

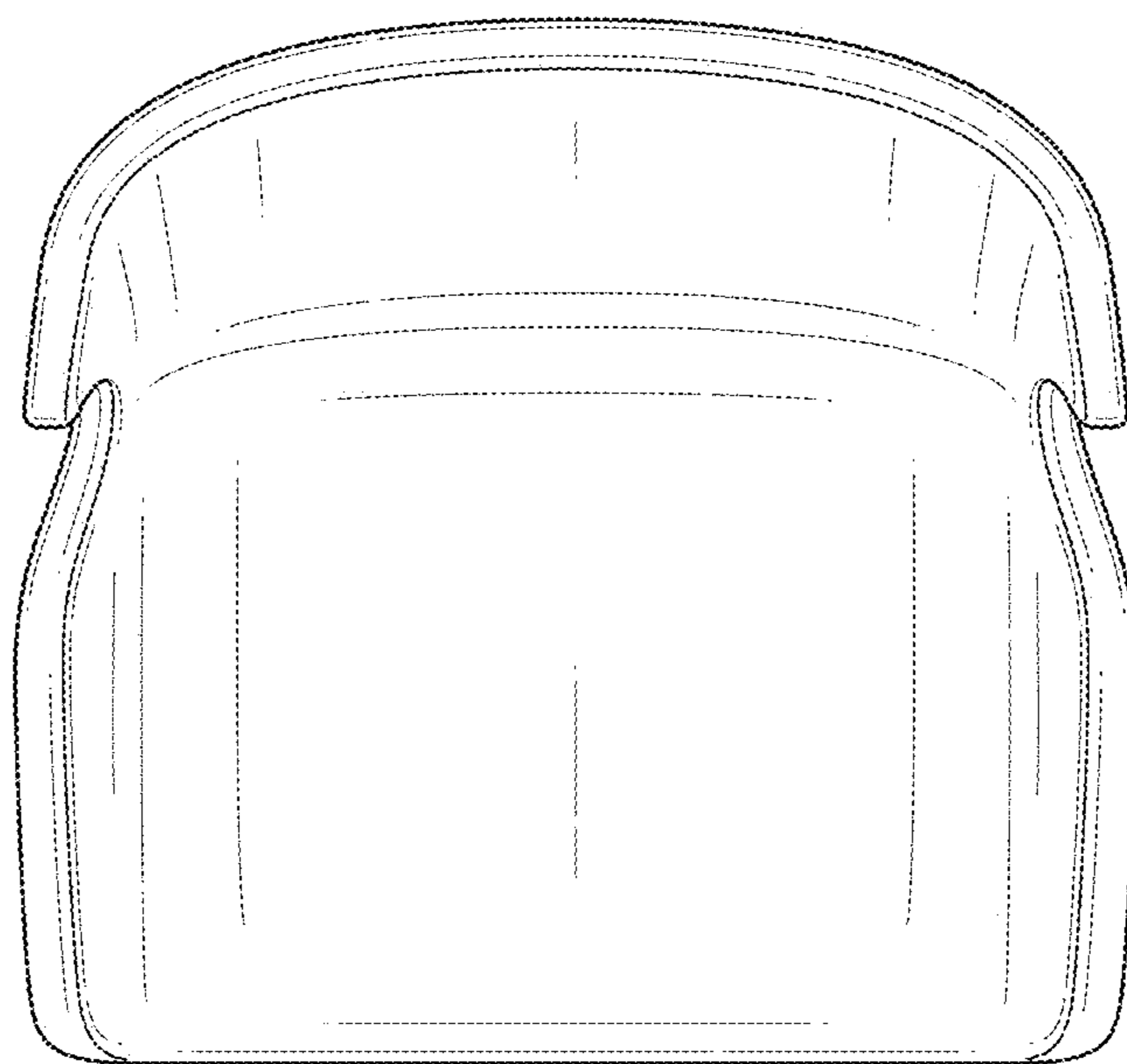

FIG. 8

