



US00D989500S

(12) **United States Design Patent**
Matsumoto et al.

(10) **Patent No.:** **US D989,500 S**
(45) **Date of Patent:** **** Jun. 20, 2023**

(54) **COMBINED TRANSMISSIVE DISPLAY AND AIRPLANE SEAT UNIT**

(71) Applicant: **Panasonic Intellectual Property Management Co., Ltd.**, Osaka (JP)

(72) Inventors: **Masaharu Matsumoto**, Osaka (JP);
Takeshi Hatakeyama, Osaka (JP);
Toshihiro Ezaki, Osaka (JP)

(73) Assignee: **PANASONIC INTELLECTUAL PROPERTY MANAGEMENT CO., LTD.**, Osaka (JP)

(**) Term: **15 Years**

(21) Appl. No.: **29/751,990**

(22) Filed: **Sep. 24, 2020**

(51) **LOC (14) Cl.** **06-01**

(52) **U.S. Cl.**
USPC **D6/356**

(58) **Field of Classification Search**
USPC D6/335, 353, 356, 361, 364, 365, 367,
D6/374, 375, 379, 702, 713, 716.1-716.7;
D12/195, 345
CPC B64D 11/0015; B64D 11/00155; B64D
11/0601; B64D 11/0604; B64D 11/0606;
B64D 11/0639; B64D 11/064; B64D
11/0641; B64D 2011/0069
See application file for complete search history.

(56) **References Cited**

U.S. PATENT DOCUMENTS

D260,823 S * 9/1981 Stulik, Jr. D6/335
D439,425 S * 3/2001 Park D6/356
D534,734 S * 1/2007 Bennett D6/367
D558,993 S * 1/2008 Saint-Jalmes D6/357

(Continued)

OTHER PUBLICATIONS

Business class _ El Al, available on elal.com, site visited on Oct. 14, 2022, URL:https://www.elal.com/eng/onboard/business (Year: 2022).*

Primary Examiner — Mary Ann Calabrese
Assistant Examiner — Mark David Wolfley
(74) *Attorney, Agent, or Firm* — Crowell & Moring LLP

(57) **CLAIM**

The ornamental design for a combined transmissive display and airplane seat unit, as shown and described.

DESCRIPTION

FIG. 1 is a front perspective view of a combined transmissive display and airplane seat unit of a first embodiment according to the invention;

FIG. 2 is a front view thereof;

FIG. 3 is a rear view thereof;

FIG. 4 is a left view thereof;

FIG. 5 is a right view thereof;

FIG. 6 is a top view thereof;

FIG. 7 is a bottom view thereof;

FIG. 8 is a cross-sectional view thereof taken along lines 8-8 of FIG. 6;

FIG. 9 is a front perspective view of a combined transmissive display and airplane seat unit of a second embodiment according to the invention;

FIG. 10 is a front view thereof;

FIG. 11 is a rear view thereof;

FIG. 12 is a left view thereof;

FIG. 13 is a right view thereof;

FIG. 14 is a top view thereof;

FIG. 15 is a bottom view thereof; and,

FIG. 16 is a cross-sectional view thereof taken along lines 16-16 of FIG. 14.

The broken lines in the drawings form no part of the claimed design. Broken lines formed by equal length dashes show unclaimed subject matter. Broken lines formed of unequal length dashes (i.e., dash-dot) define bounds of the claimed design.

1 Claim, 16 Drawing Sheets

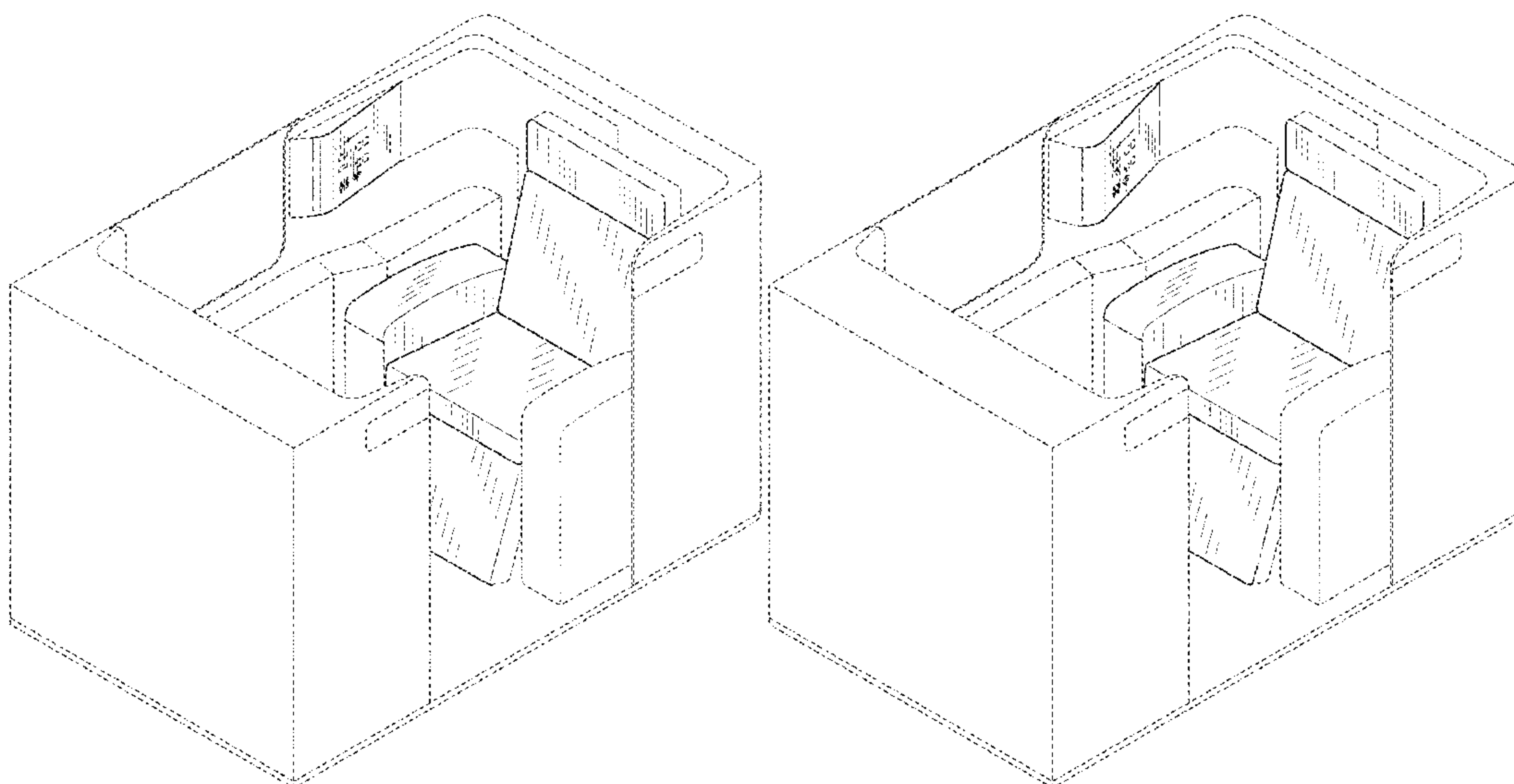

(56)

References Cited

U.S. PATENT DOCUMENTS

D583,579 S 12/2008 Pearson et al.
D623,577 S * 9/2010 Orson D12/345
D623,578 S * 9/2010 Orson D12/345
D641,982 S 7/2011 Darbyshire
D661,116 S 6/2012 Darbyshire
D696,524 S * 12/2013 Ersan D6/356
D713,160 S * 9/2014 Roberts D6/356
D856,692 S * 8/2019 Veneruso D6/335
D893,931 S * 8/2020 Katakura D6/716
D901,199 S * 11/2020 Katakura D6/356
D911,899 S * 3/2021 Aung D12/345
D934,782 S * 11/2021 Lin D12/345
D966,024 S * 10/2022 Matsumoto D6/703
2009/0302158 A1 * 12/2009 Darbyshire B64D 11/064
244/118.6
2012/0133192 A1 * 5/2012 Simpson B64D 11/0643
428/158
2022/0161929 A1 * 5/2022 Katakura B64D 11/0606

* cited by examiner

FIG. 1

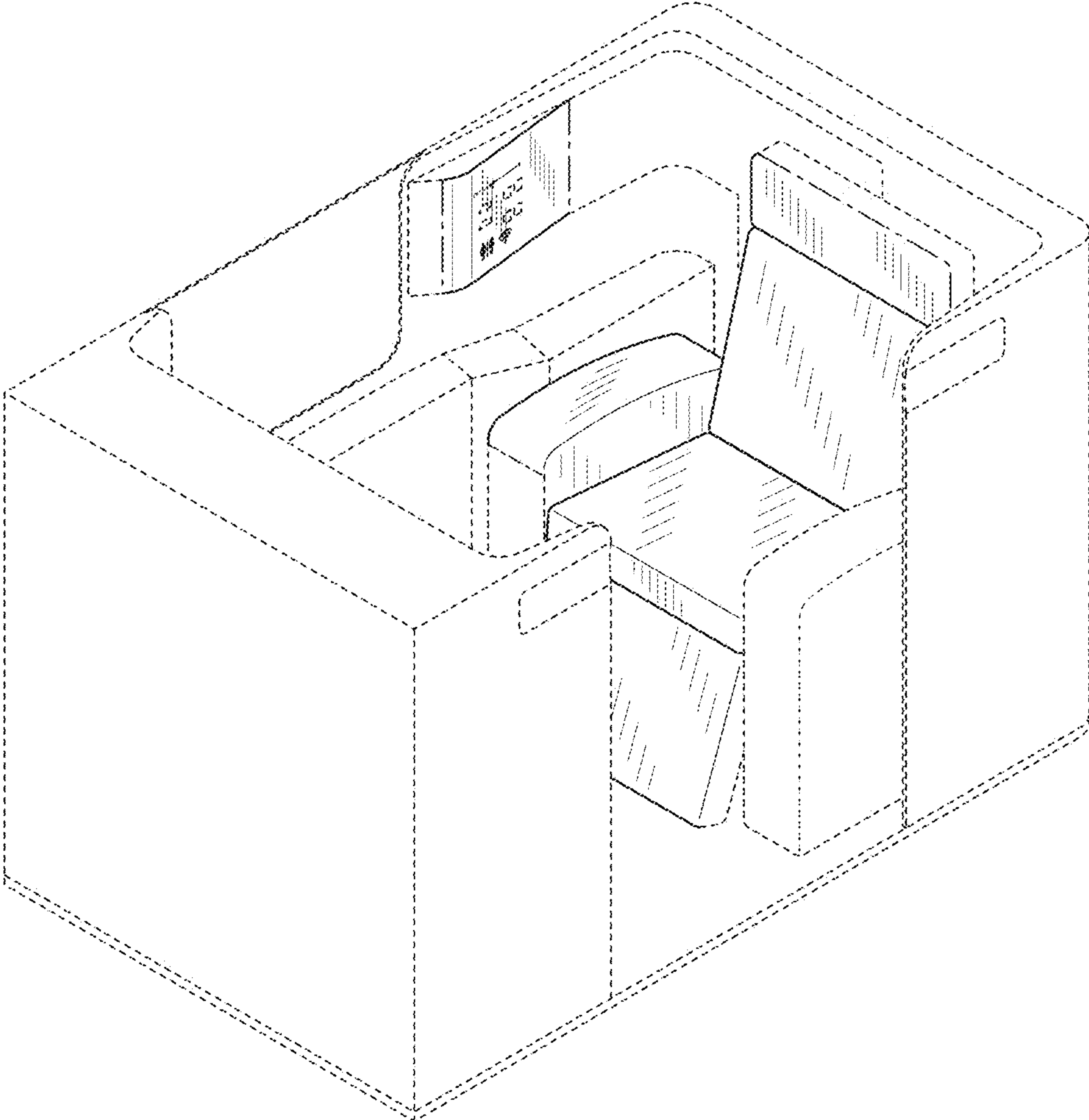

FIG. 2

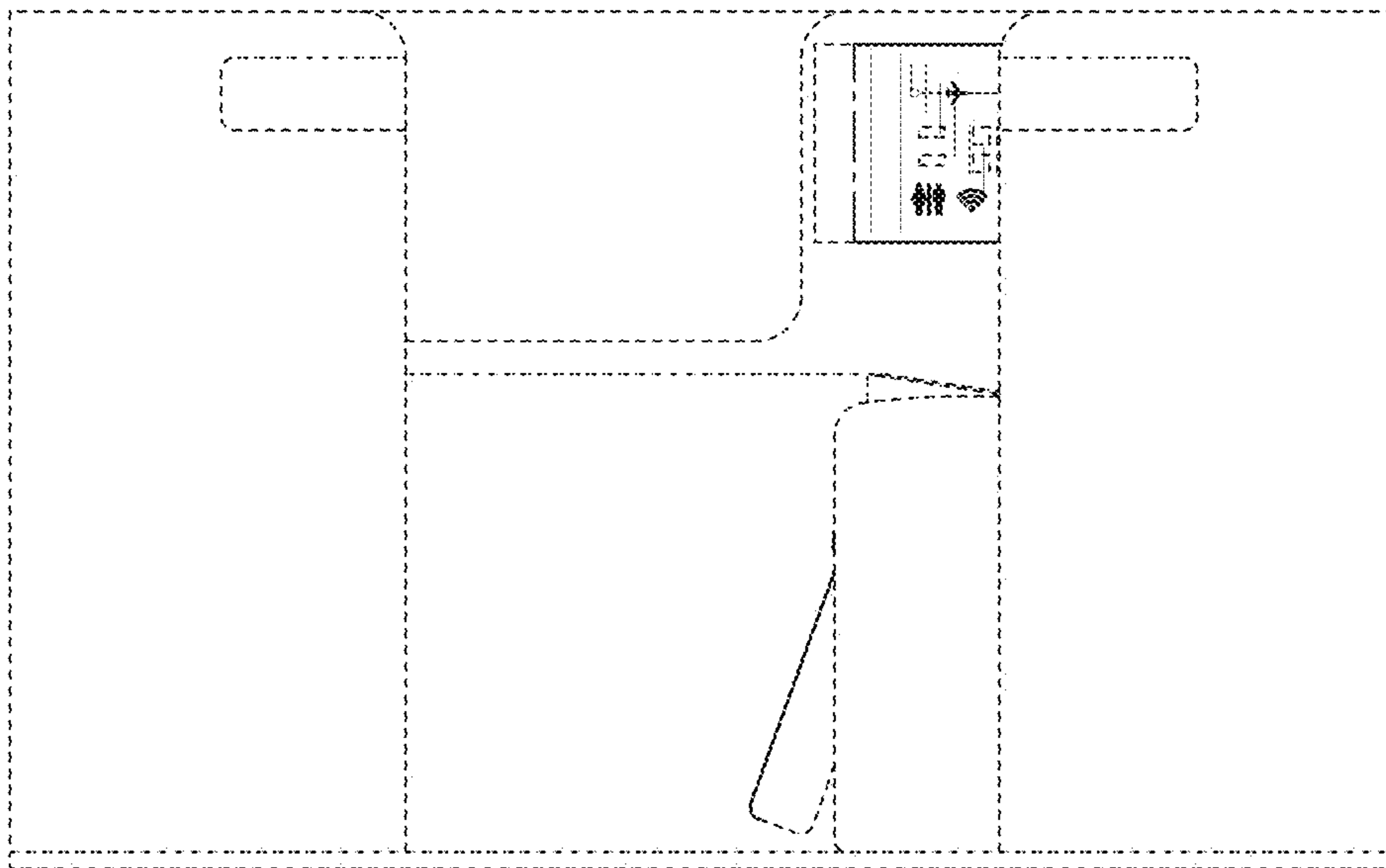

FIG. 3

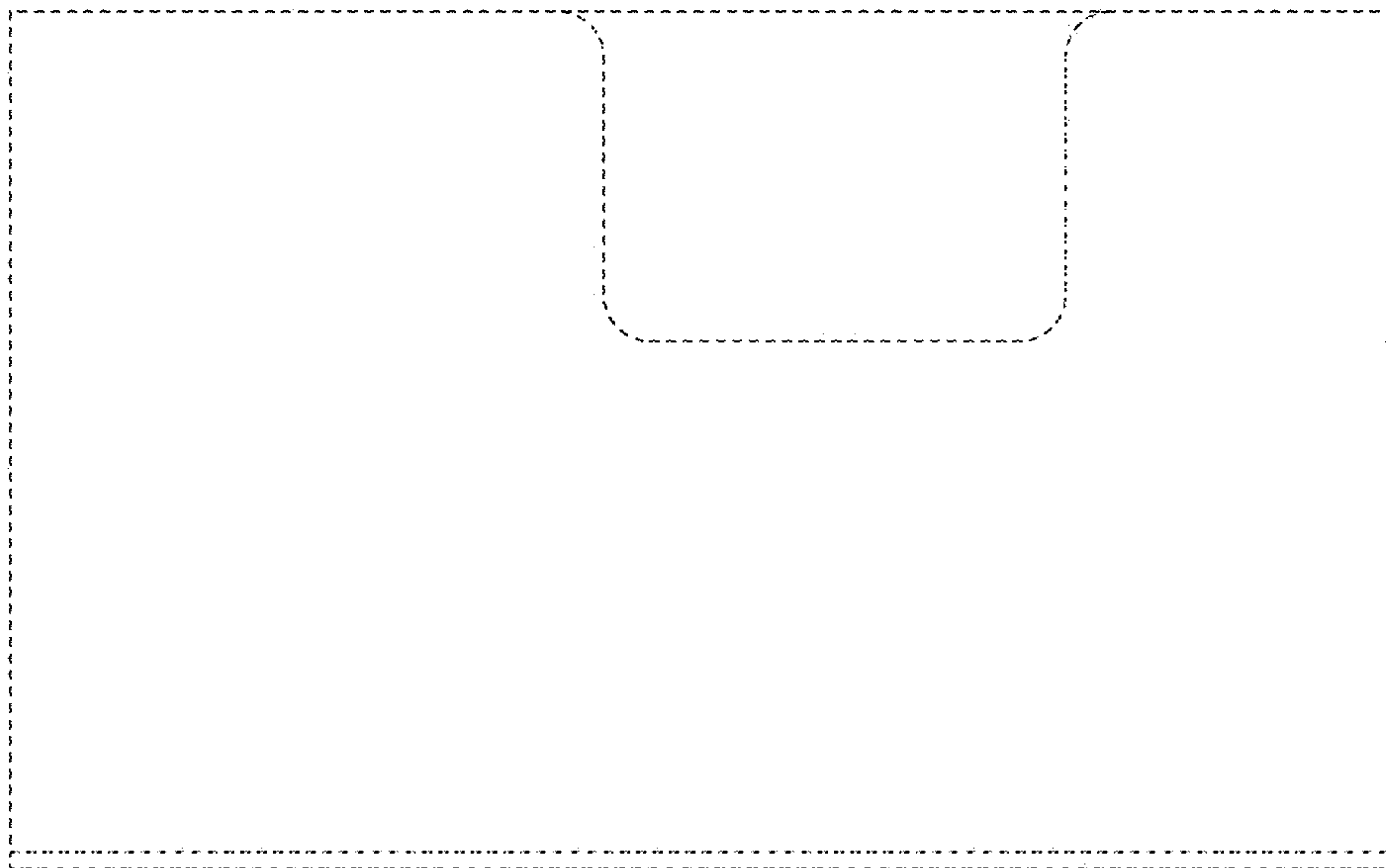

FIG. 4

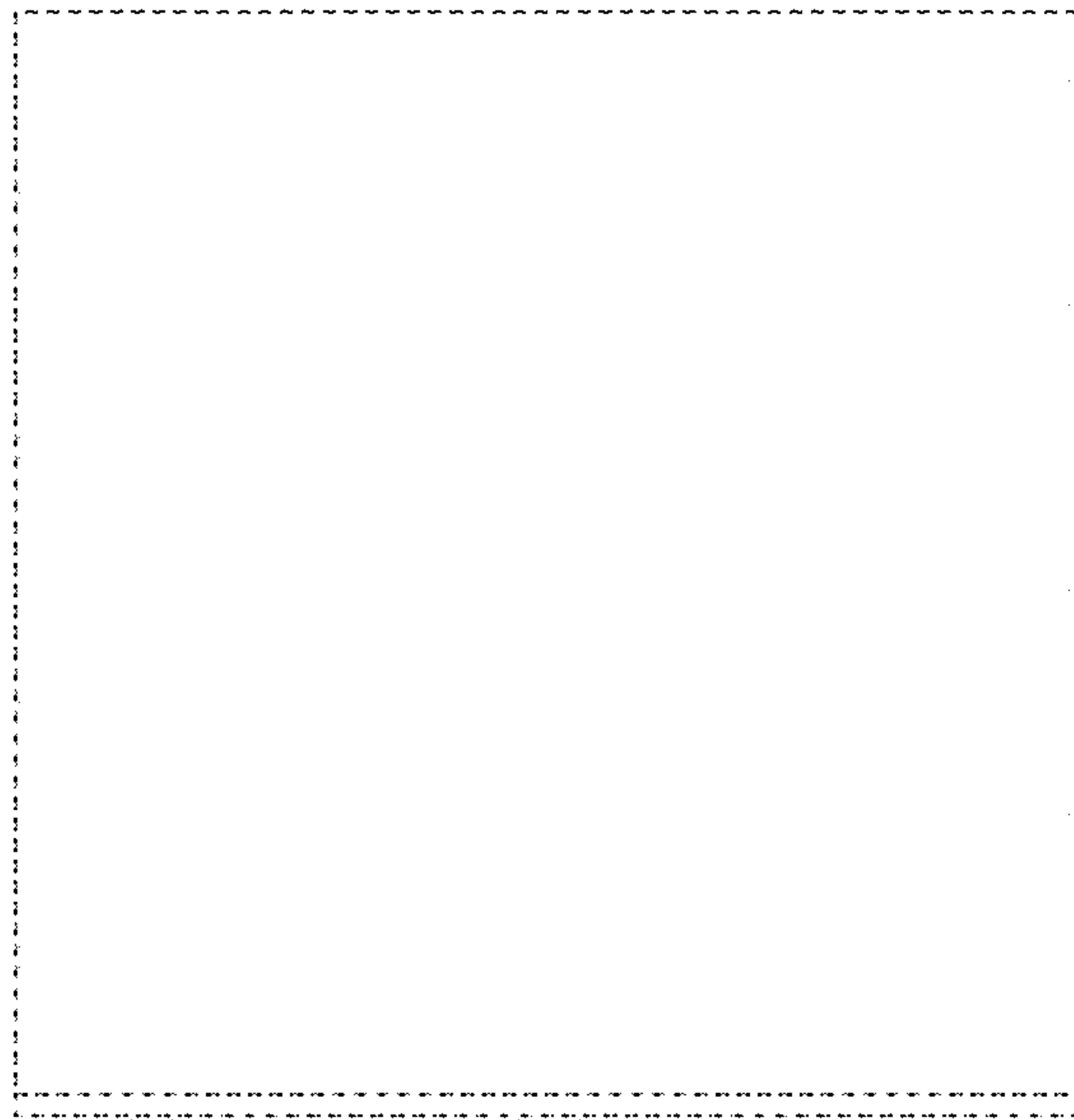

FIG. 5

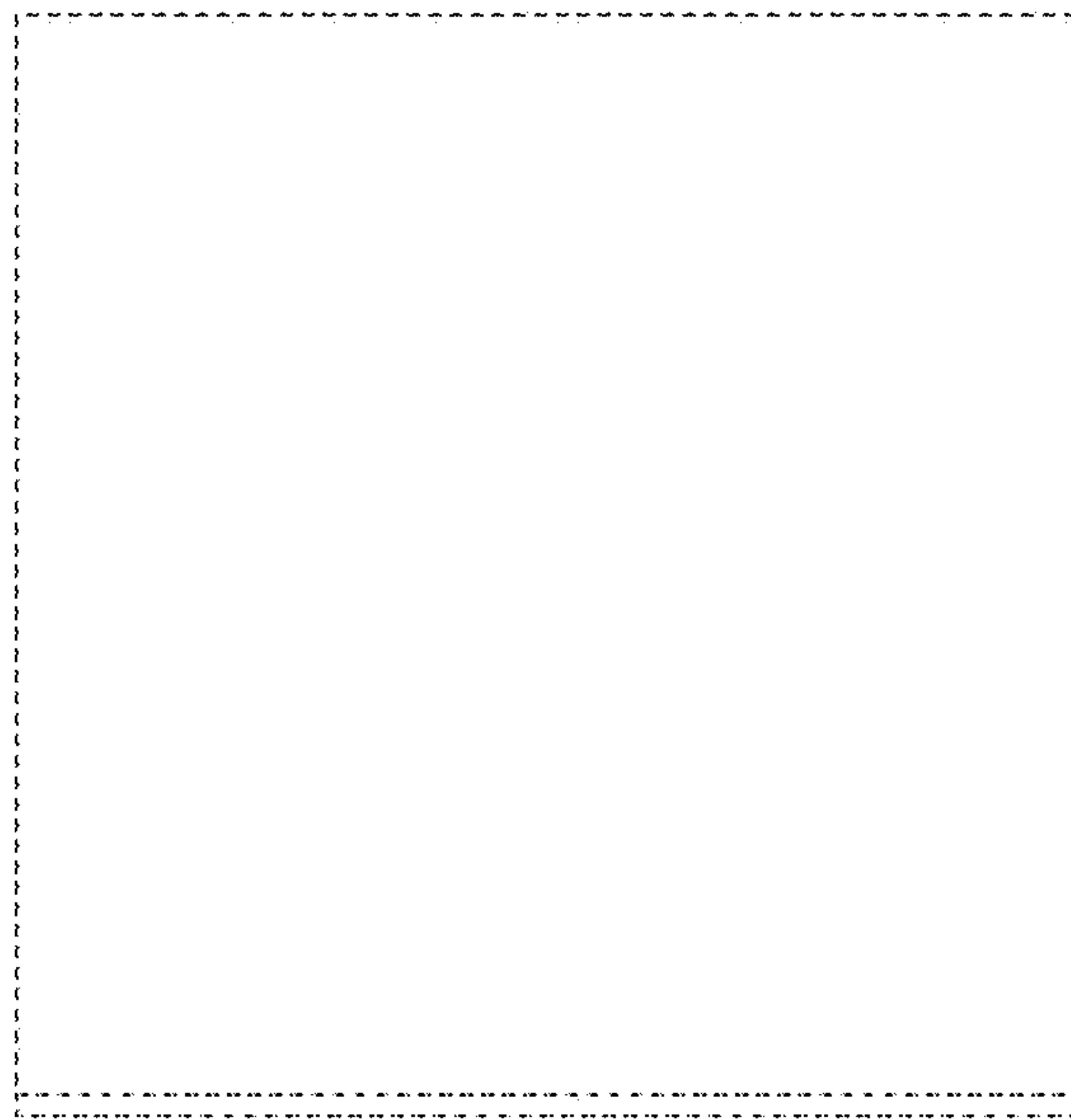

FIG. 6

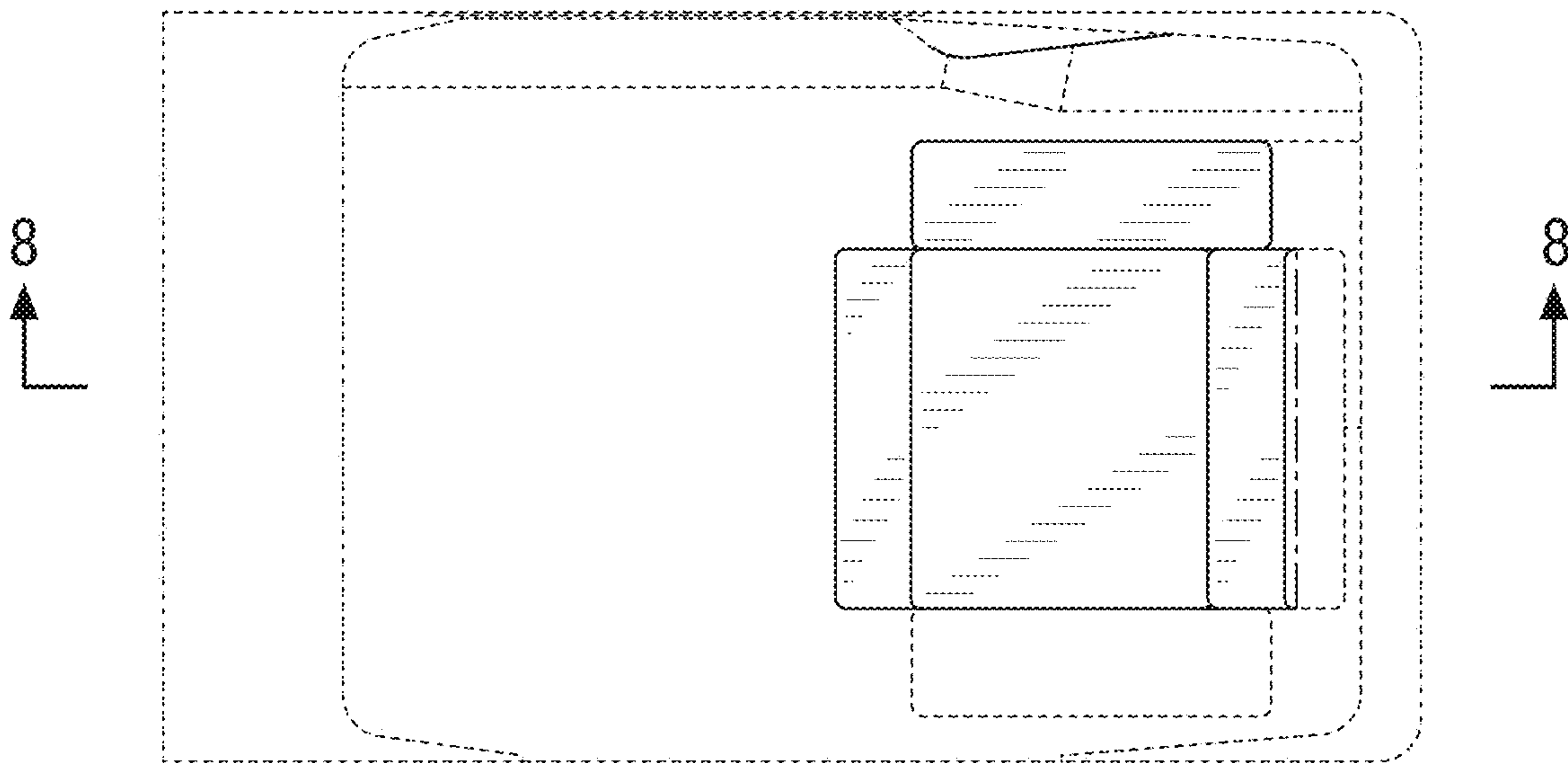

FIG. 7



FIG. 8

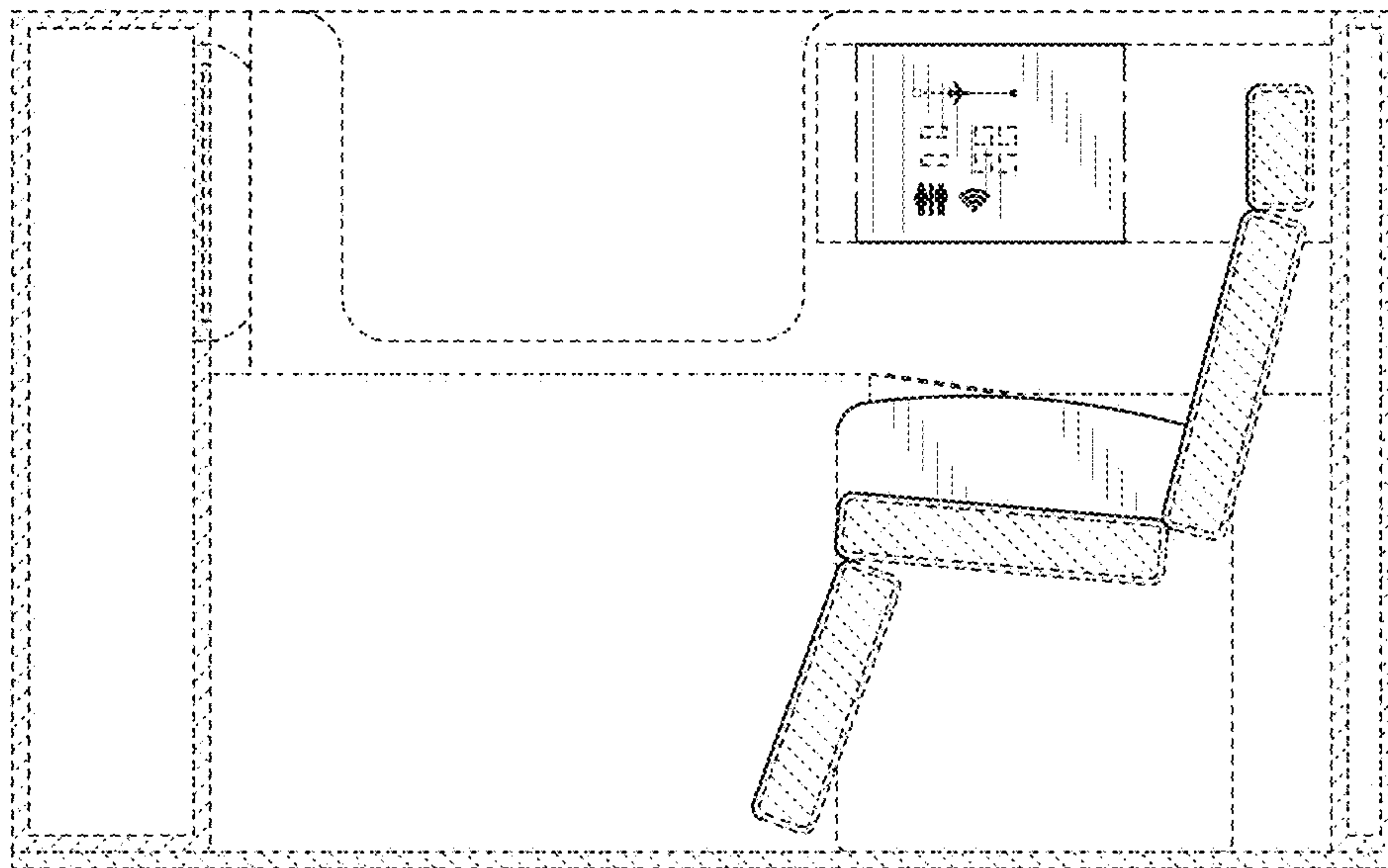

FIG. 9

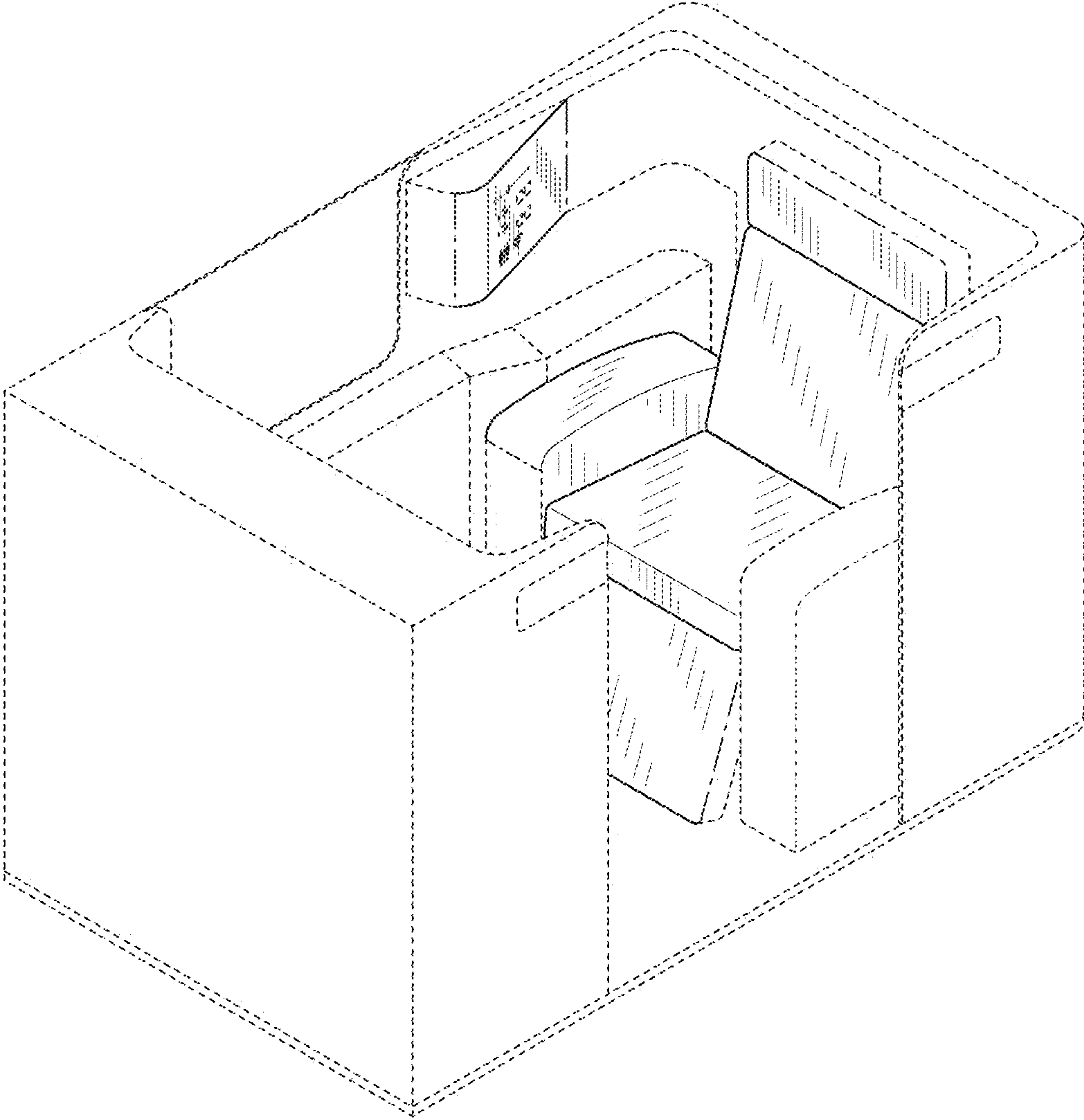

FIG. 10

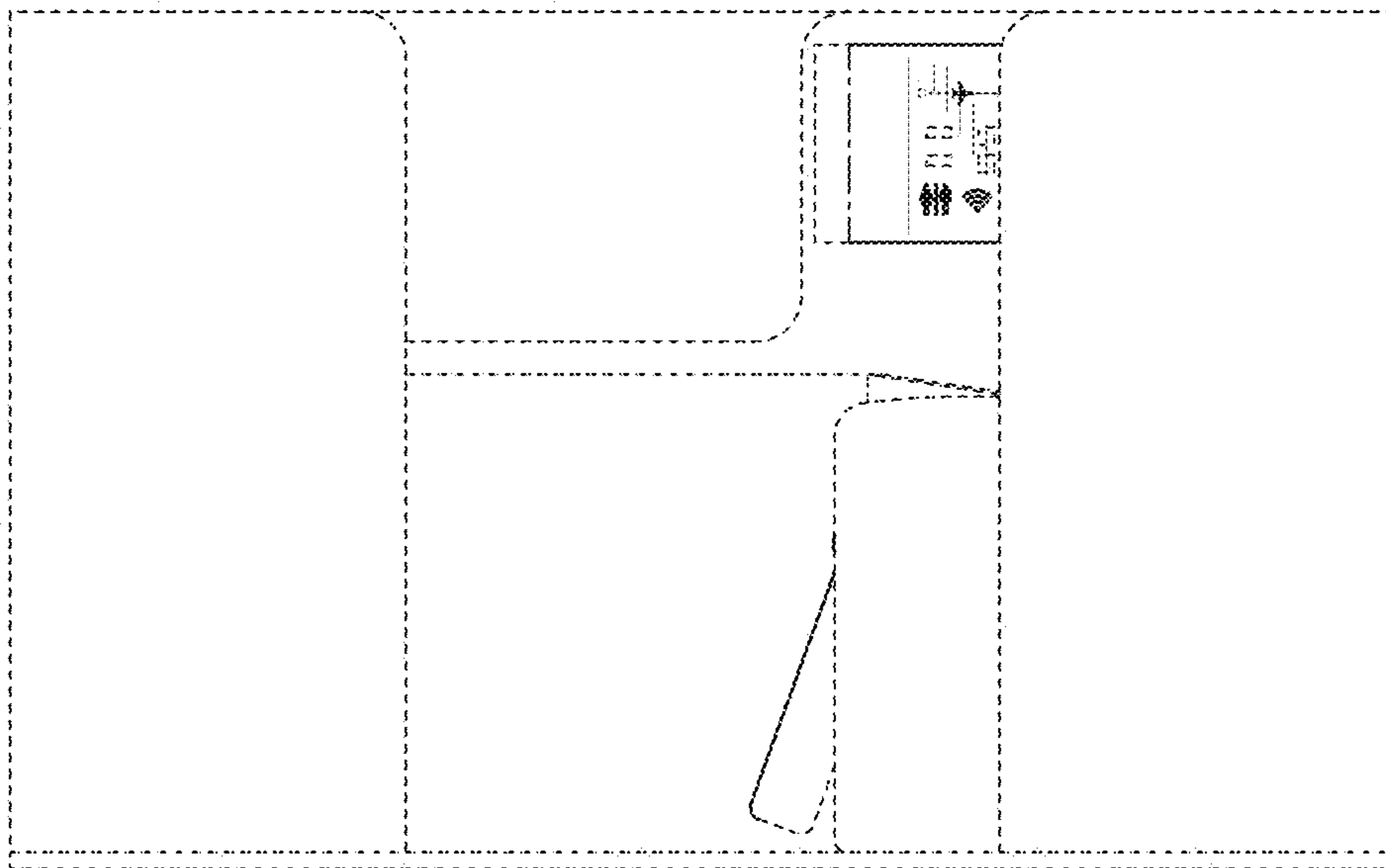

FIG. 11

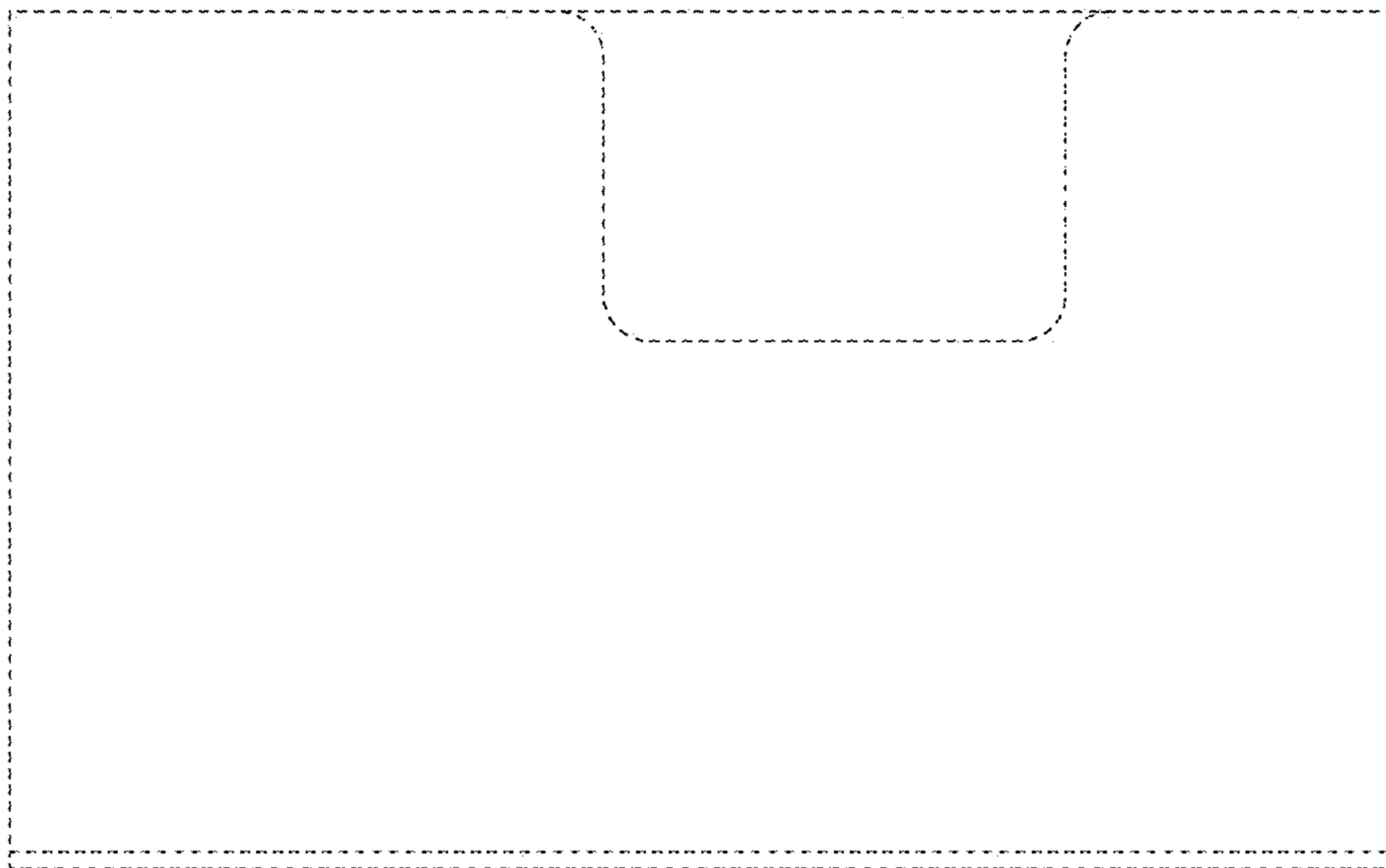

FIG. 12

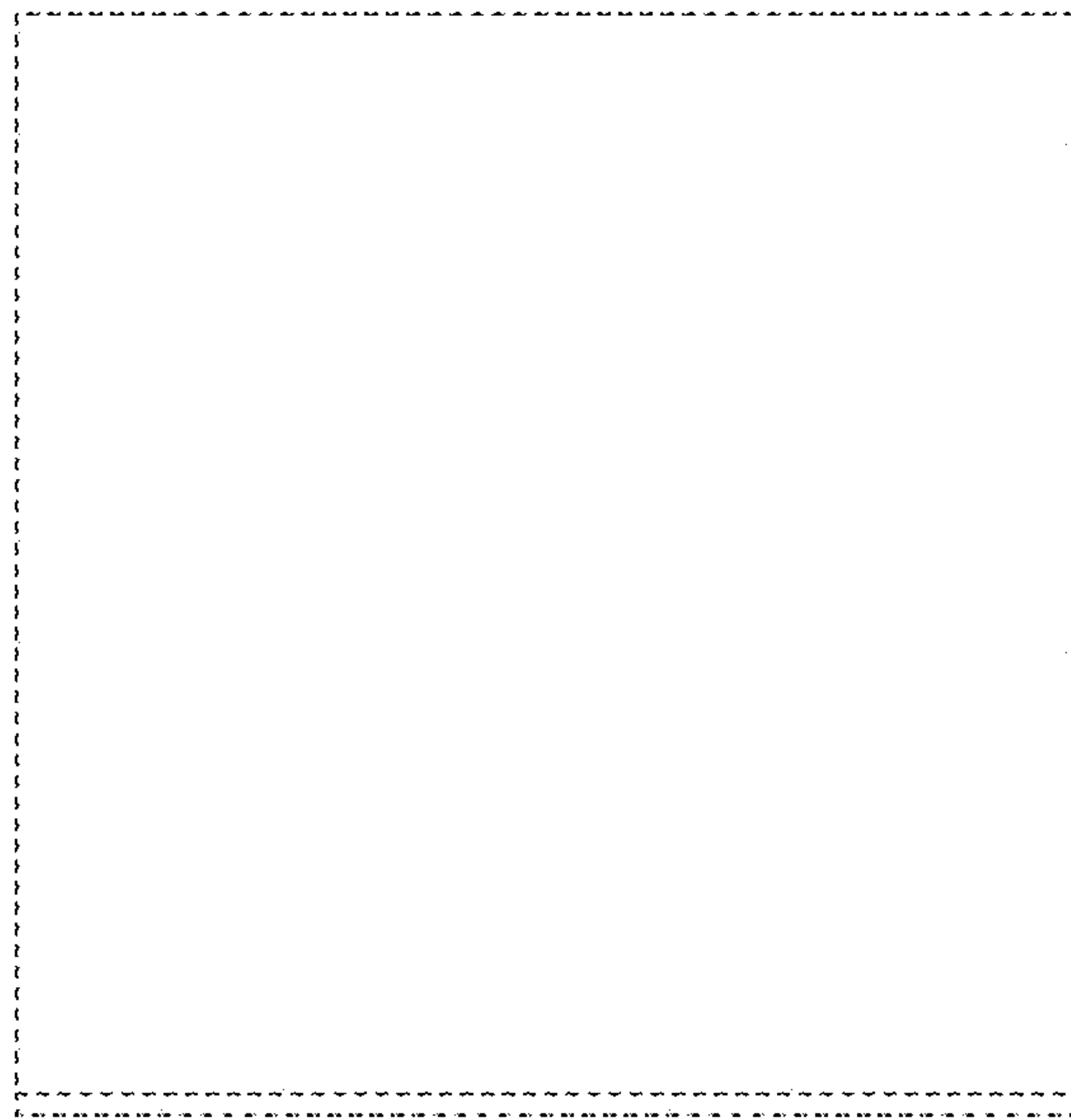

FIG. 13

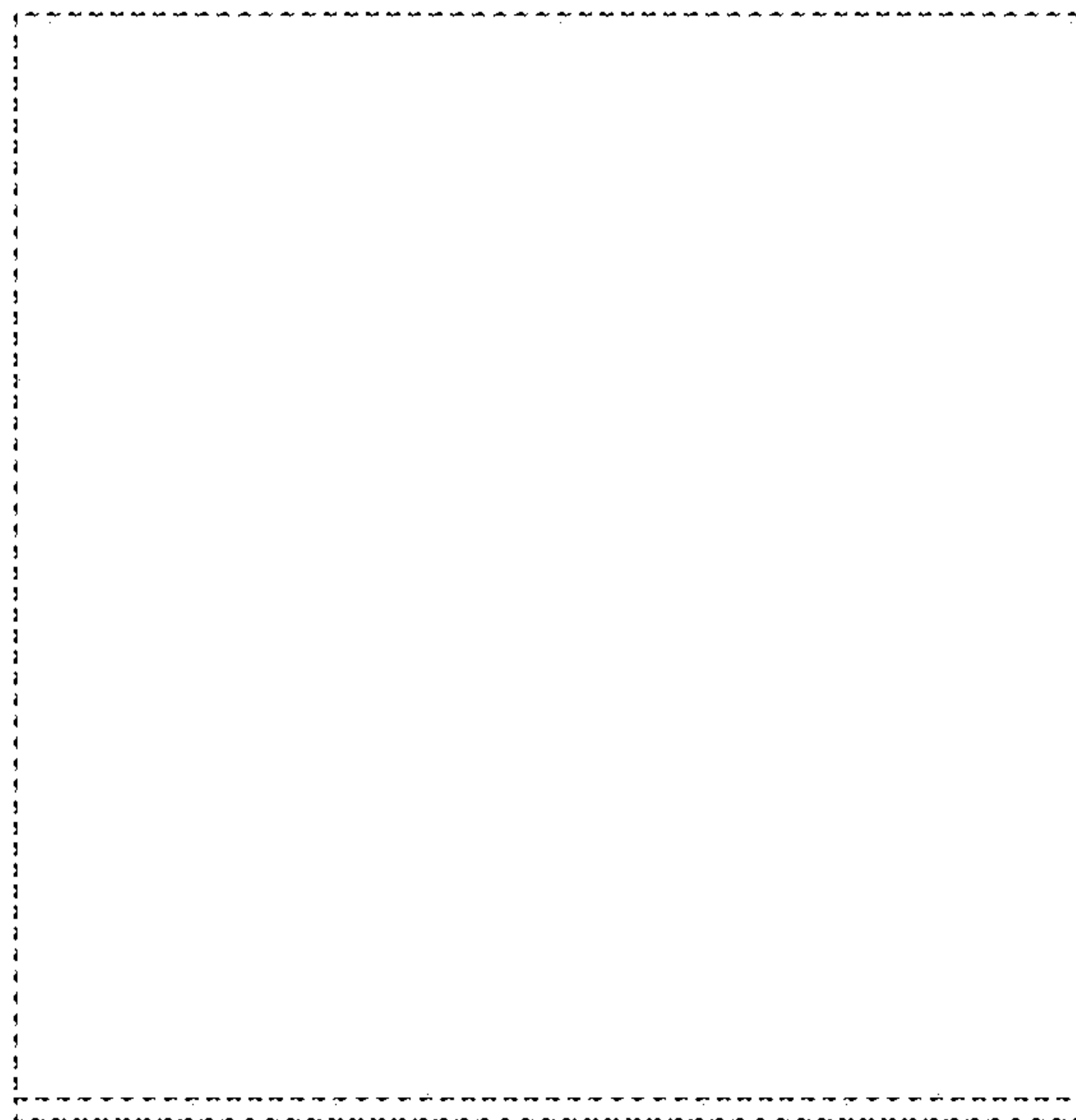

FIG. 14

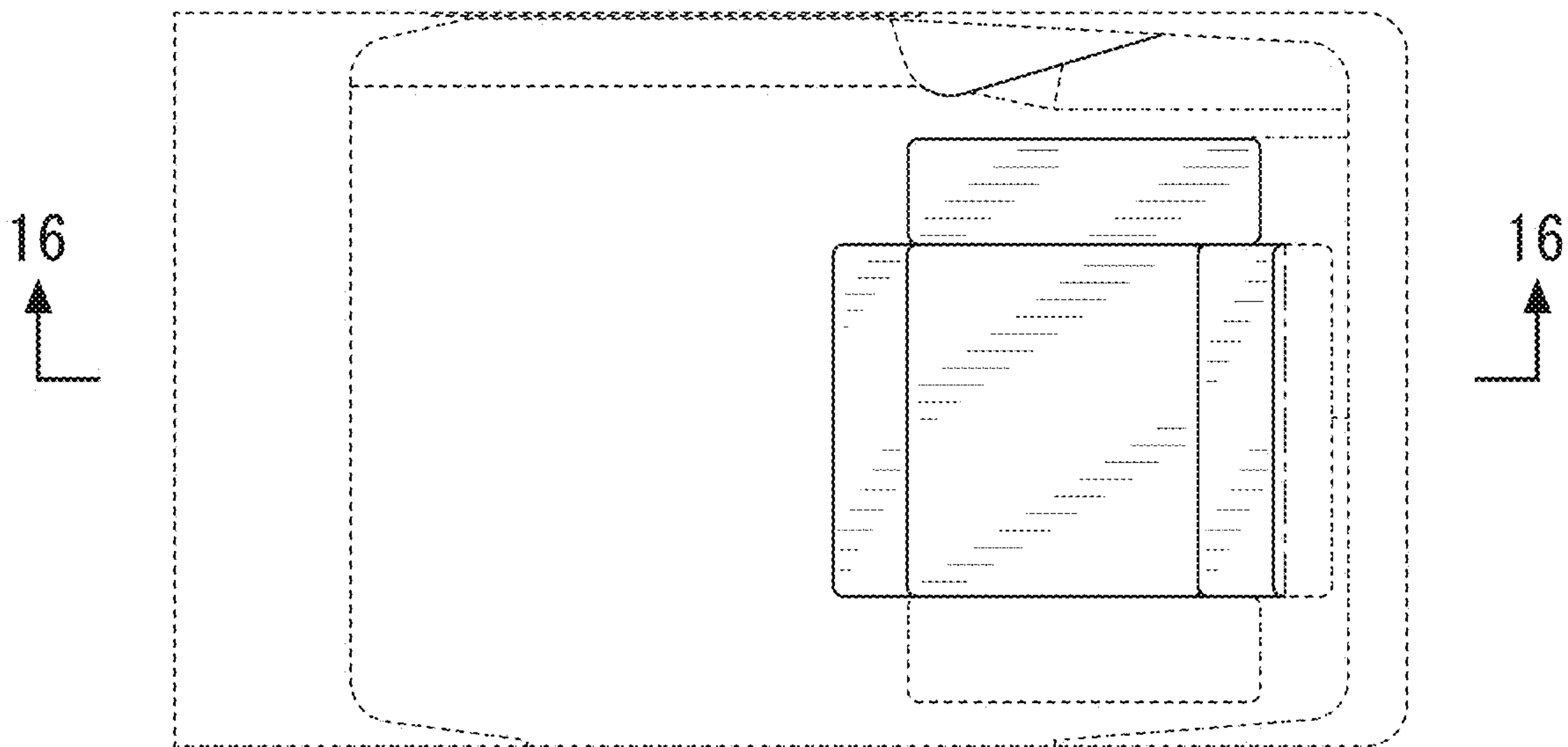

FIG. 15



FIG. 16

