



US00D989483S

(12) **United States Design Patent**
Chen

(10) **Patent No.:** **US D989,483 S**

(45) **Date of Patent:** **** Jun. 20, 2023**

(54) **TOOL BOX**

(71) Applicant: **BRIGHTEVER CO., LTD.**, Changsha (CN)

(72) Inventor: **Yaodong Chen**, Changsha (CN)

(**) Term: **15 Years**

(21) Appl. No.: **29/861,966**

(22) Filed: **Dec. 5, 2022**

(51) **LOC (14) Cl.** **03-01**

(52) **U.S. Cl.**
USPC **D3/276; D3/905**

(58) **Field of Classification Search**
USPC D3/276, 282, 291, 294, 905, 901, 903,
D3/284, 289, 302, 271.2
CPC B25H 3/02; B25H 3/00
See application file for complete search history.

(56) **References Cited**

U.S. PATENT DOCUMENTS

D563,670 S *	3/2008	Cornwell	D3/905
D566,392 S *	4/2008	Aglassinger	D3/905
D613,944 S *	4/2010	Molina	D3/905
D685,178 S *	7/2013	Lv	D3/273
D789,087 S *	6/2017	Harrah	D3/905
D799,822 S *	10/2017	Kanda	D3/276
D949,560 S	4/2022	Chen	
D960,572 S *	8/2022	Chang	D3/276
2022/0355462 A1 *	11/2022	Cho	B25H 3/021

OTHER PUBLICATIONS

Alibaba, "Vicring Household Cordless Power Screwdriver", accessed Feb. 15, 2023. <https://www.alibaba.com/product-detail/VICRING->

Household-Cordless-Power-Screwdriver_1600513377392.html?spm=a2700.shop_plgr.41413.21.221651b4sH2Xfn) (Year: 2023).*

Lowes, "Dremel EZ Lock 18-Piece Set Multipurpose Accessory Kit", First reviewed May 17, 2016. (<https://www.lowes.com/pd/Dremel-EZ-Lock-18-Piece-Set-Set-Multipurpose-Accessory-Kit/50428104>) (Year: 2016).*

* cited by examiner

Primary Examiner — April Rivas

(57) **CLAIM**

The ornamental design for a tool box, as shown and described.

DESCRIPTION

FIG. 1 is a front and top perspective view of a tool box, showing my new design;
FIG. 2 is a rear and bottom perspective view thereof;
FIG. 3 is a front elevation view thereof;
FIG. 4 is a rear elevation view thereof;
FIG. 5 is a left side elevation view thereof;
FIG. 6 is a right side elevation view thereof;
FIG. 7 is a top plan view thereof;
FIG. 8 is a bottom plan view thereof; and,
FIG. 9 is an enlarged perspective view of detail "9" identified in FIG. 5.

The dashed lines in the figures illustrate portions of the tool box that form no part of the claimed design. The dash dot dash lines in FIGS. 5 and 9 are for the purpose of illustrating the enlarged view indicators and form no part of the claimed design.

1 Claim, 9 Drawing Sheets

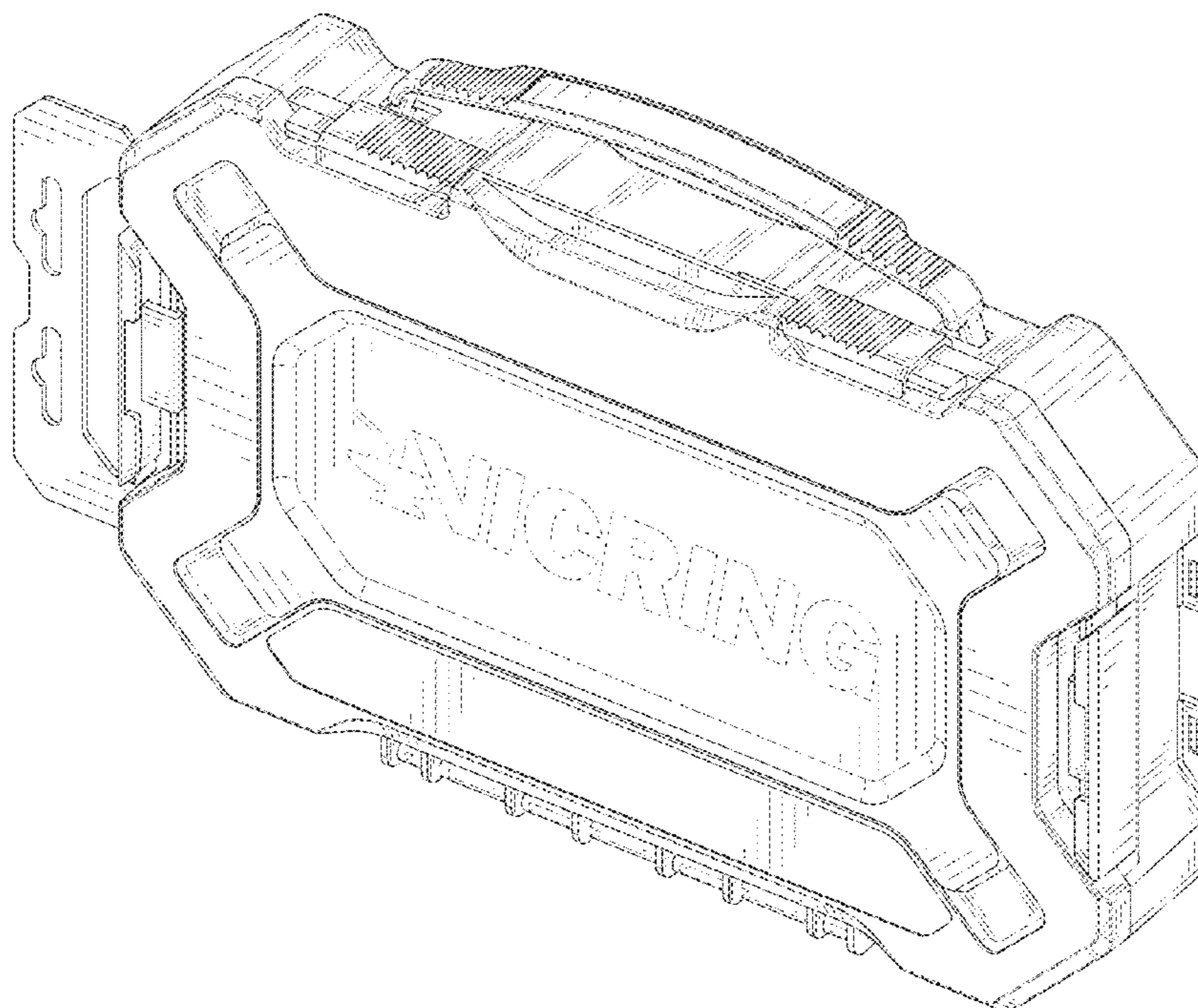

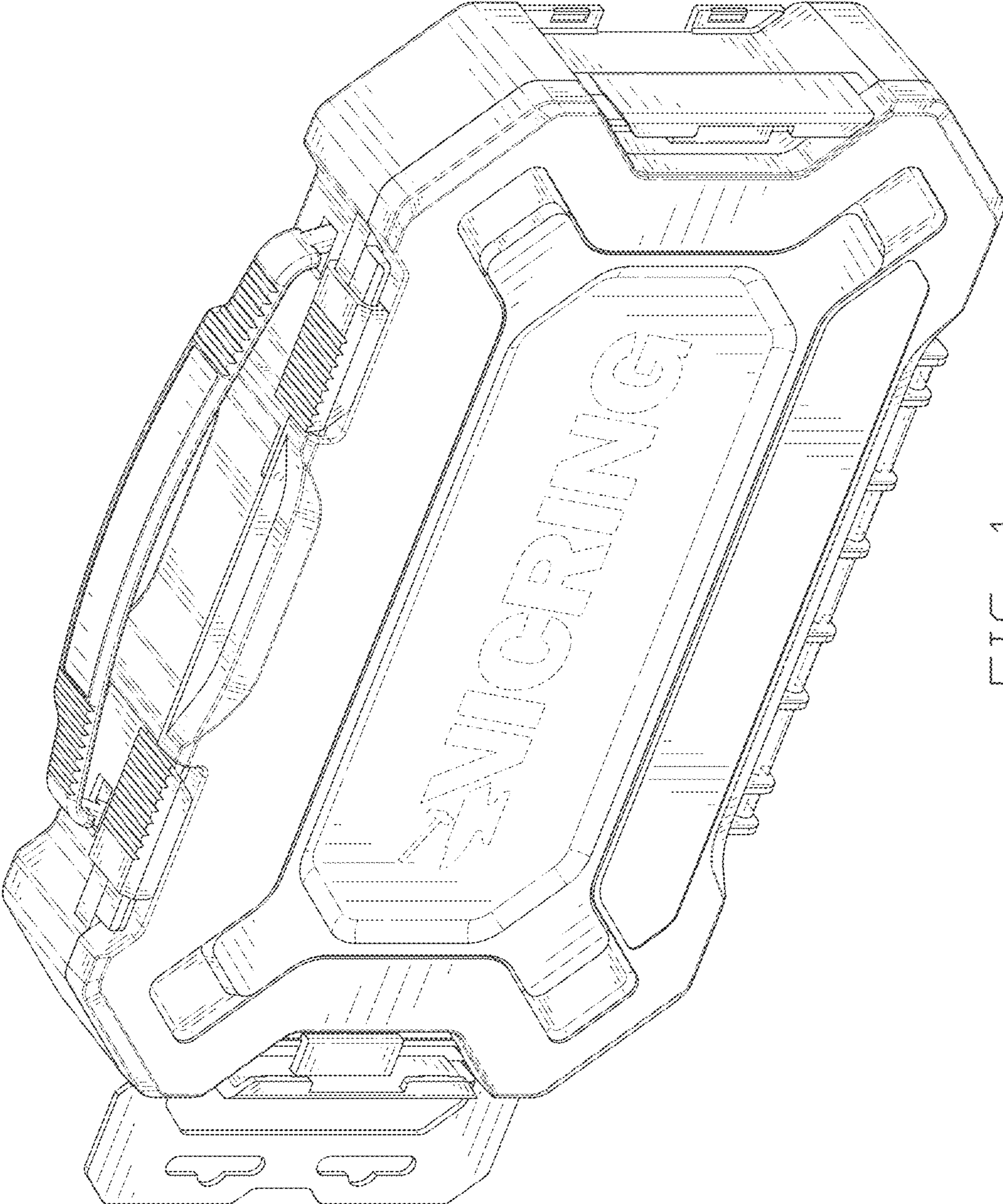

FIG. 1

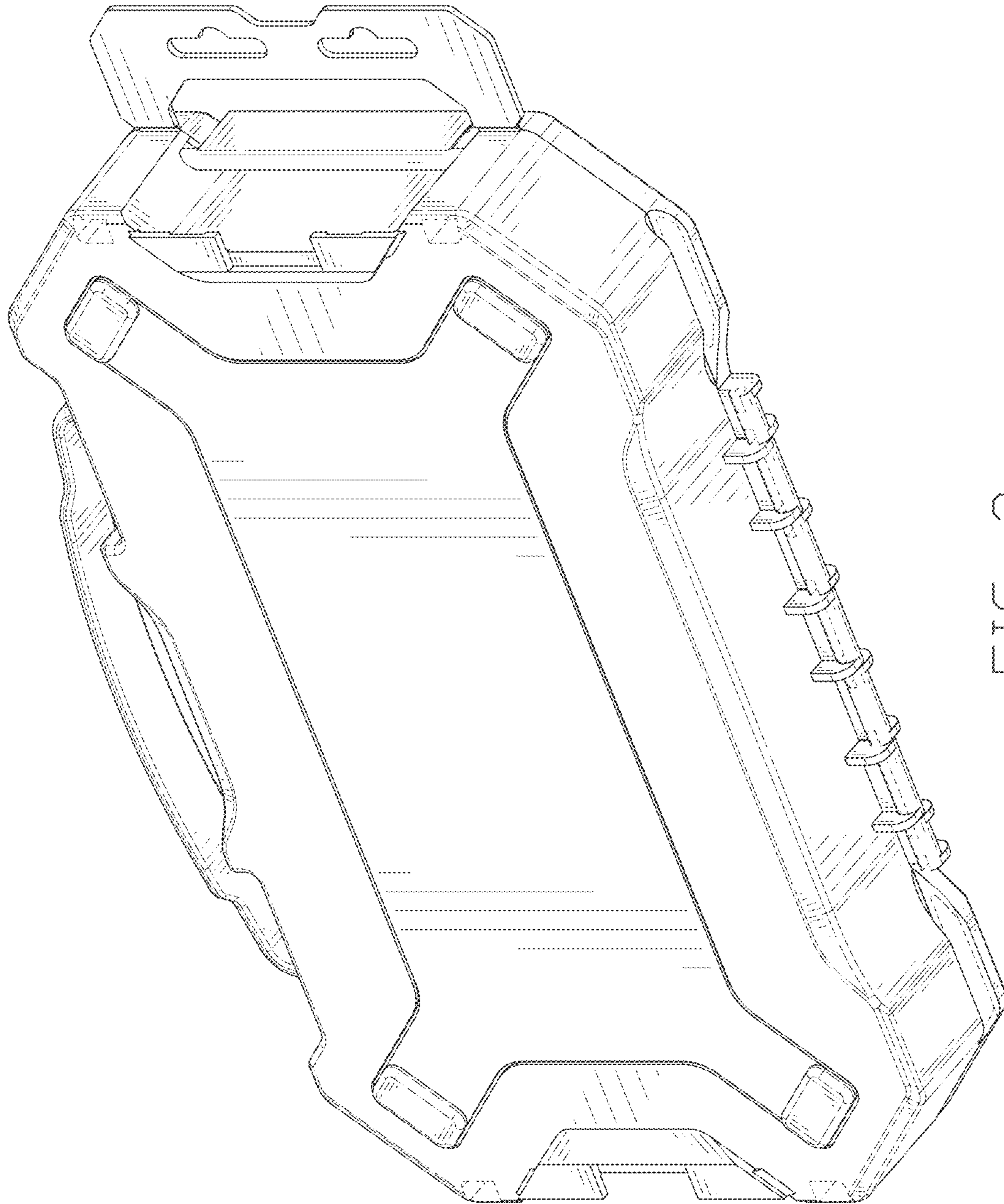

FIG. 2

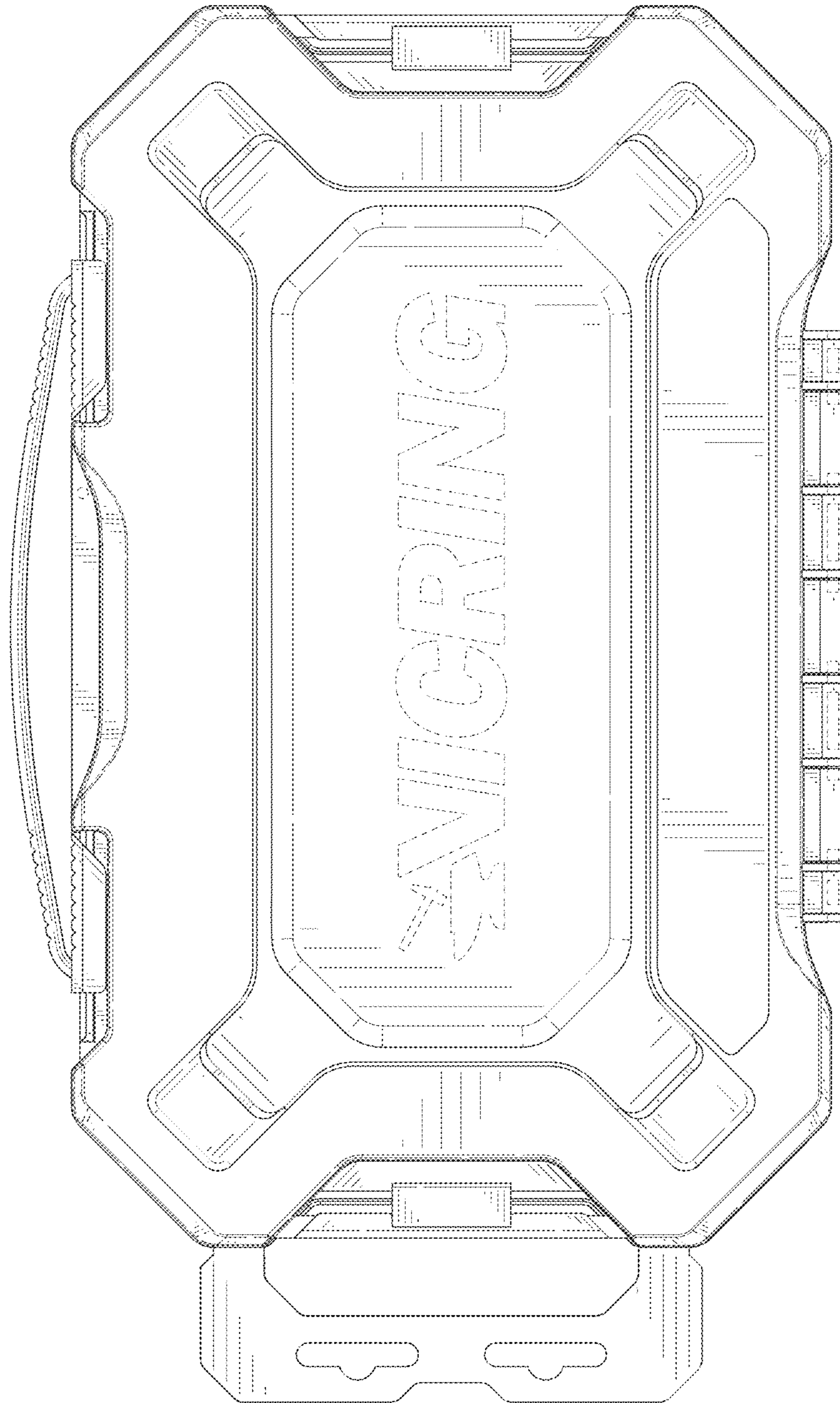

FIG. 3

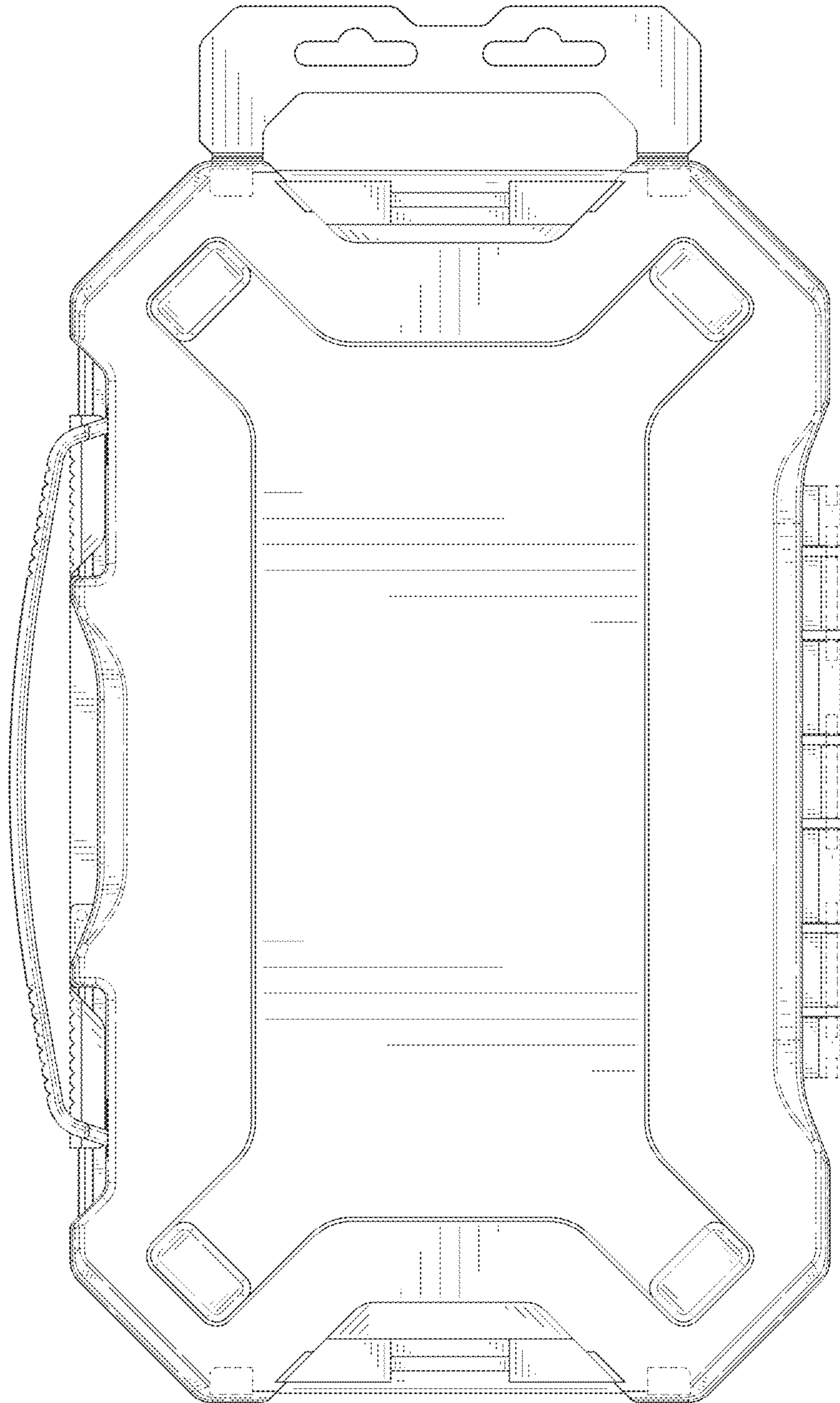

FIG. 4

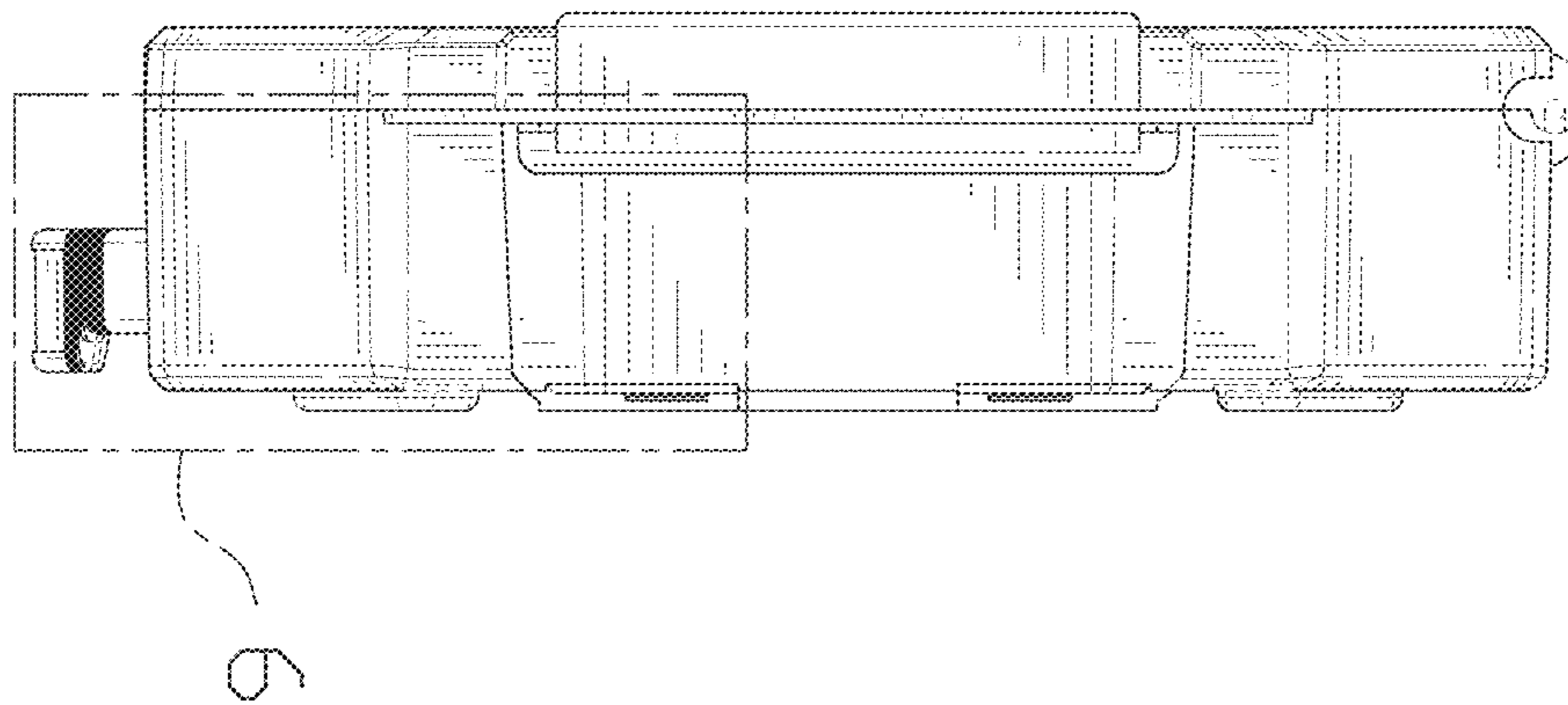

FIG. 5

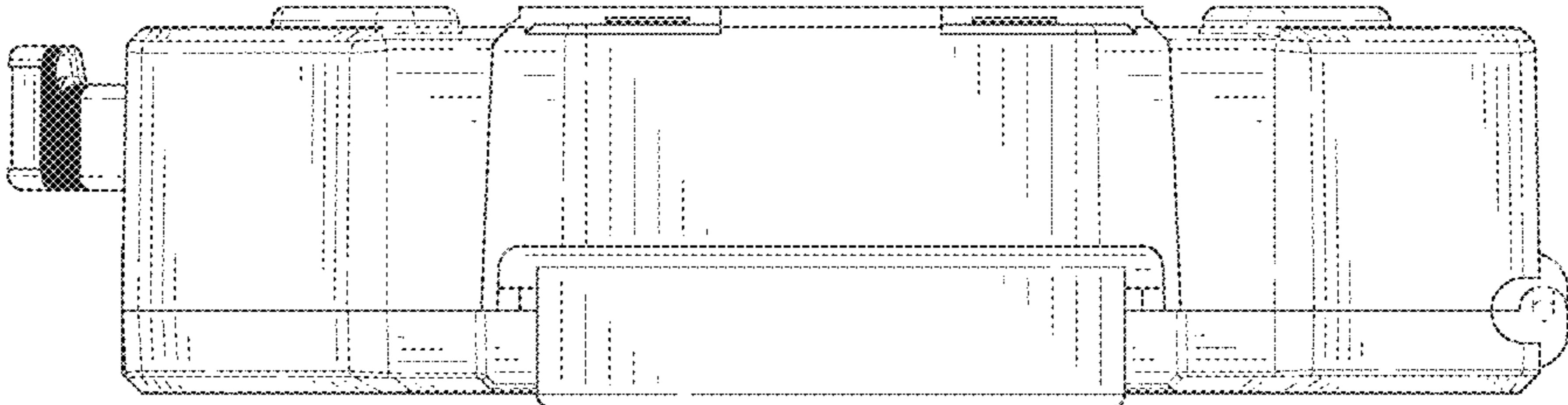

FIG. 6

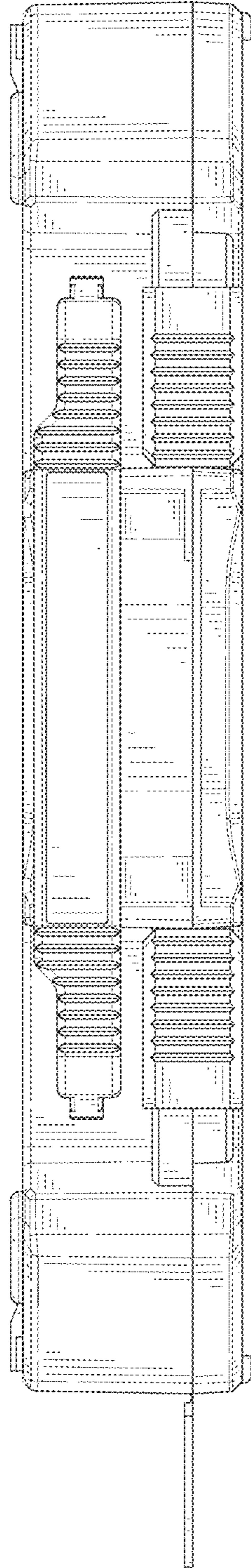

FIG. 7

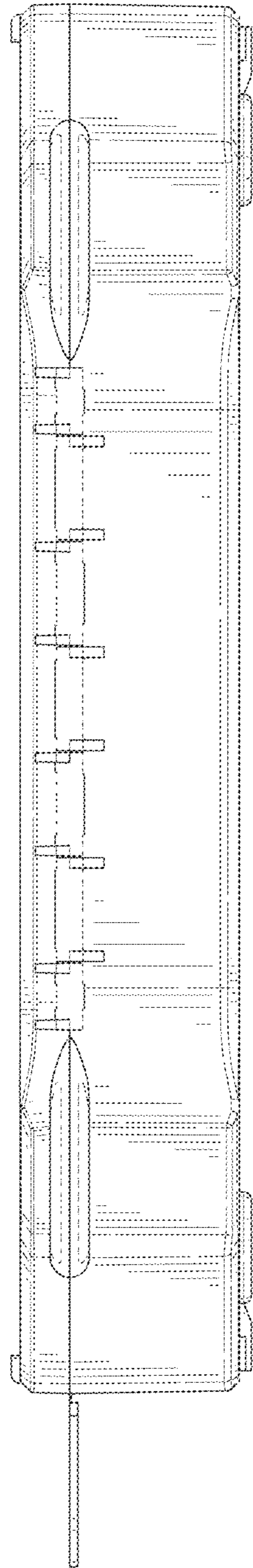

FIG. 8

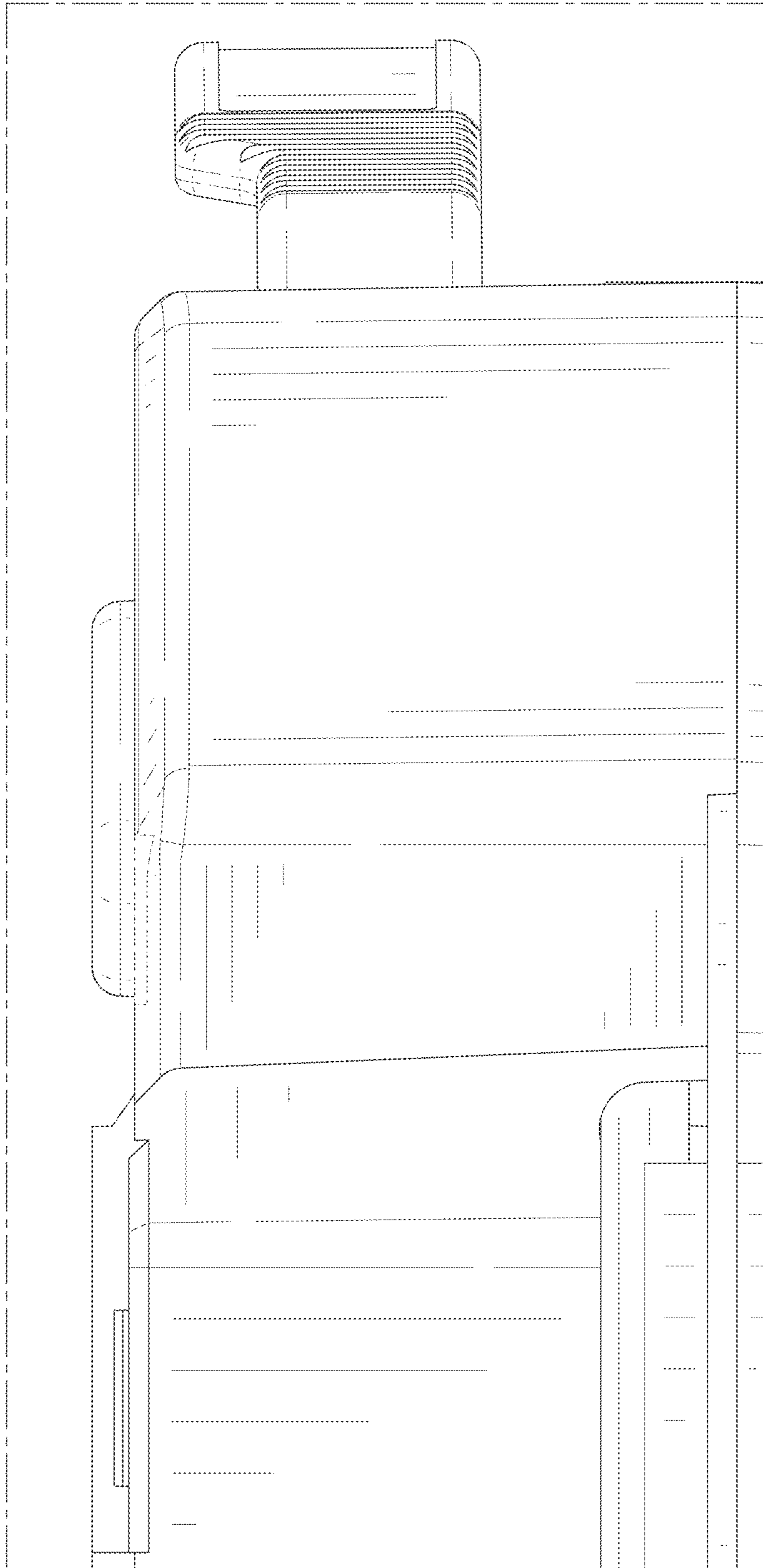

FIG. 9