



US00D989379S

(12) **United States Design Patent** (10) **Patent No.:** **US D989,379 S**
Ji (45) **Date of Patent:** **** Jun. 13, 2023**

- (54) **LAMP**
- (71) Applicant: **HUIZHOU SUNRISE TECHNOLOGY CO., LTD**, Huizhou (CN)
- (72) Inventor: **Min Ji**, Huizhou (CN)
- (73) Assignee: **HUIZHOU SUNRISE TECHNOLOGY CO., LTD**, Huizhou (CN)
- (**) Term: **15 Years**
- (21) Appl. No.: **29/771,409**
- (22) Filed: **Feb. 23, 2021**
- (51) **LOC (14) Cl.** **26-05**
- (52) **U.S. Cl.**
USPC **D26/97**
- (58) **Field of Classification Search**
USPC D26/24, 32, 93, 94, 95, 97, 98, 101;
D21/420, 421, 427, 428, 431, 483, 484,
D21/490, 494, 510, 511, 533, 548, 576,
D21/584, 604, 611, 832, 836, 426, 433,
D21/477, 495, 828, 831, 833; D25/7, 8,
D25/17, 19, 22; D12/1, 4, 10, 83, 87, 92,
D12/424, 426
CPC . A63H 3/00; A63H 3/006; A63H 3/52; A63H
7/04; A63H 9/00; A63H 17/00; A63H
17/28; A63H 17/40; A63H 33/008; H01H
2231/026; F21W 2121/00; F21W
2131/00; F21W 2131/30; F21S 4/15;
F21S 6/00; F21S 6/002; F21S 6/003;
F21S 9/02; F21S 10/00; F21S 13/00;
F21S 13/12; F21L 2/00; F21L 4/00; F21L
4/085; F21L 19/00; F21L 26/00; F21V
1/02; F21V 1/06; F21V 1/18; F21V 3/00;
F21V 3/02; F21V 5/007; F21V 7/045;
F21V 33/0004; F21V 33/0028; F21Y
2105/10; F21Y 2105/12; F21Y 2105/14;

F21Y 2111/00; F21Y 2115/00; F21Y
2115/10; F21K 9/232
See application file for complete search history.

(56) **References Cited**

U.S. PATENT DOCUMENTS

D301,263 S *	5/1989	Ishizawa	D21/581
D385,220 S *	10/1997	Warkuss	D12/90
D389,784 S *	1/1998	Ishikawa	D12/92
D470,797 S *	2/2003	Warkuss	D12/92
D678,962 S *	3/2013	Tsuchiya	D21/551
D683,888 S *	6/2013	Johnson	D26/97
D712,589 S *	9/2014	Johnson	D26/97
D728,844 S *	5/2015	Johnson	D26/97
D868,174 S *	11/2019	Chen	D12/83
D870,209 S *	12/2019	Chen	D21/431
D903,787 S *	12/2020	Chen	D21/531
D976,337 S *	1/2023	Ma	D21/561
2007/0130783 A1 *	6/2007	Wu	B43L 23/08 30/451

* cited by examiner

Primary Examiner — Angela J Lee
Assistant Examiner — Audris Park

(57) **CLAIM**

The ornamental design for a lamp, as shown and described.

DESCRIPTION

FIG. 1 is a perspective view of a lamp showing my new design;
FIG. 2 is another perspective view thereof;
FIG. 3 is a front elevational view thereof;
FIG. 4 is a rear elevational view thereof;
FIG. 5 is a left side elevational view thereof;
FIG. 6 is a right side elevational view thereof;
FIG. 7 is a top plan view thereof; and,
FIG. 8 is a bottom plan view thereof.
The broken lines in the drawings depict portions of the lamp that form no part of the claimed design.

1 Claim, 8 Drawing Sheets

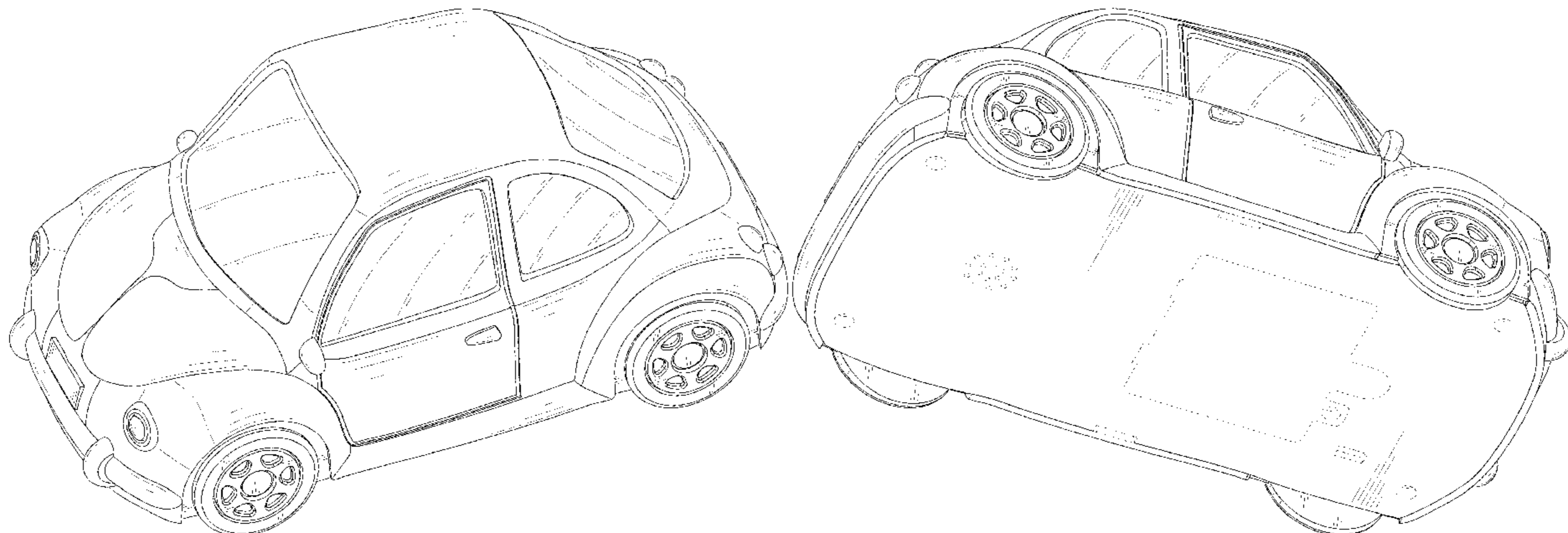

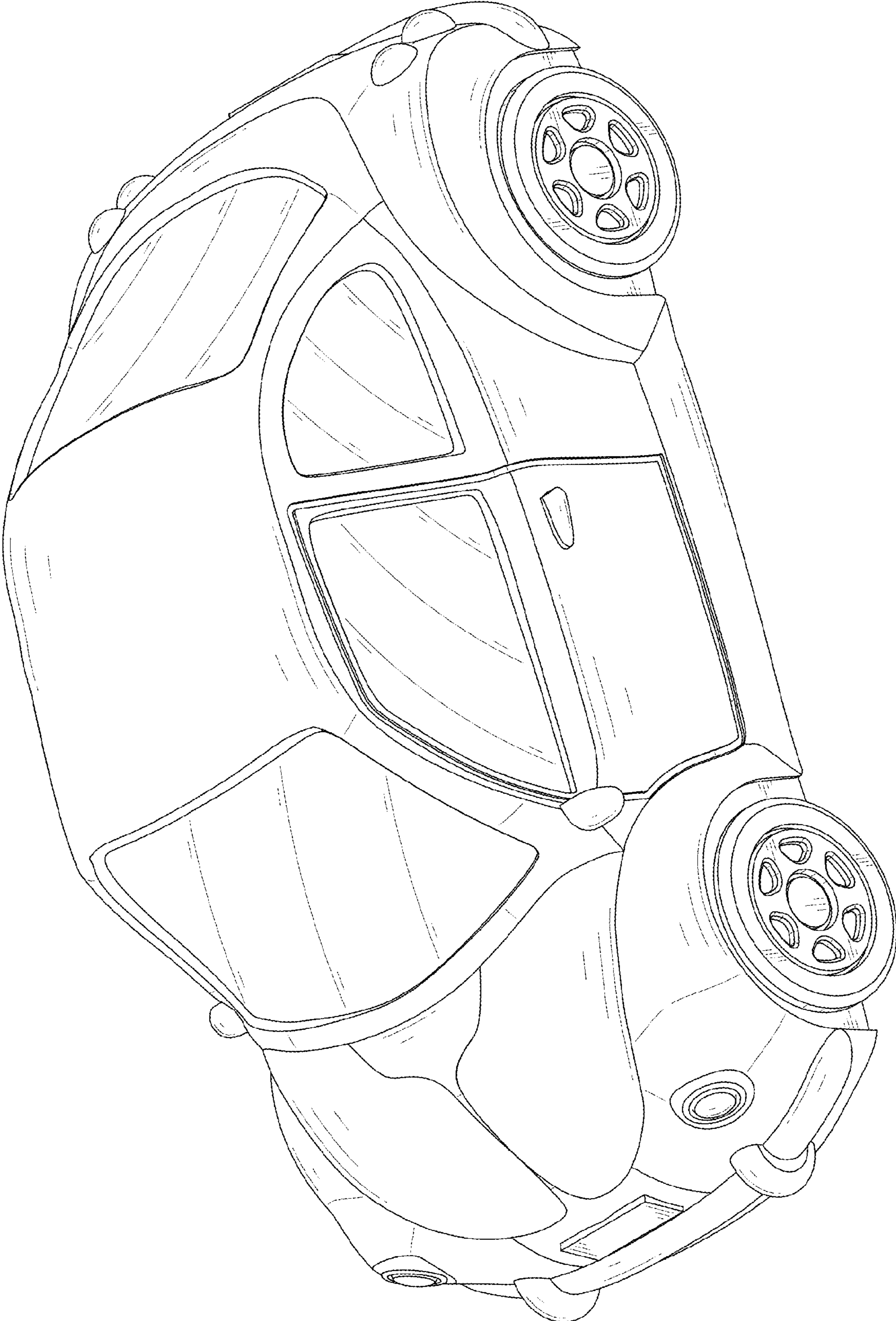

FIG. 1

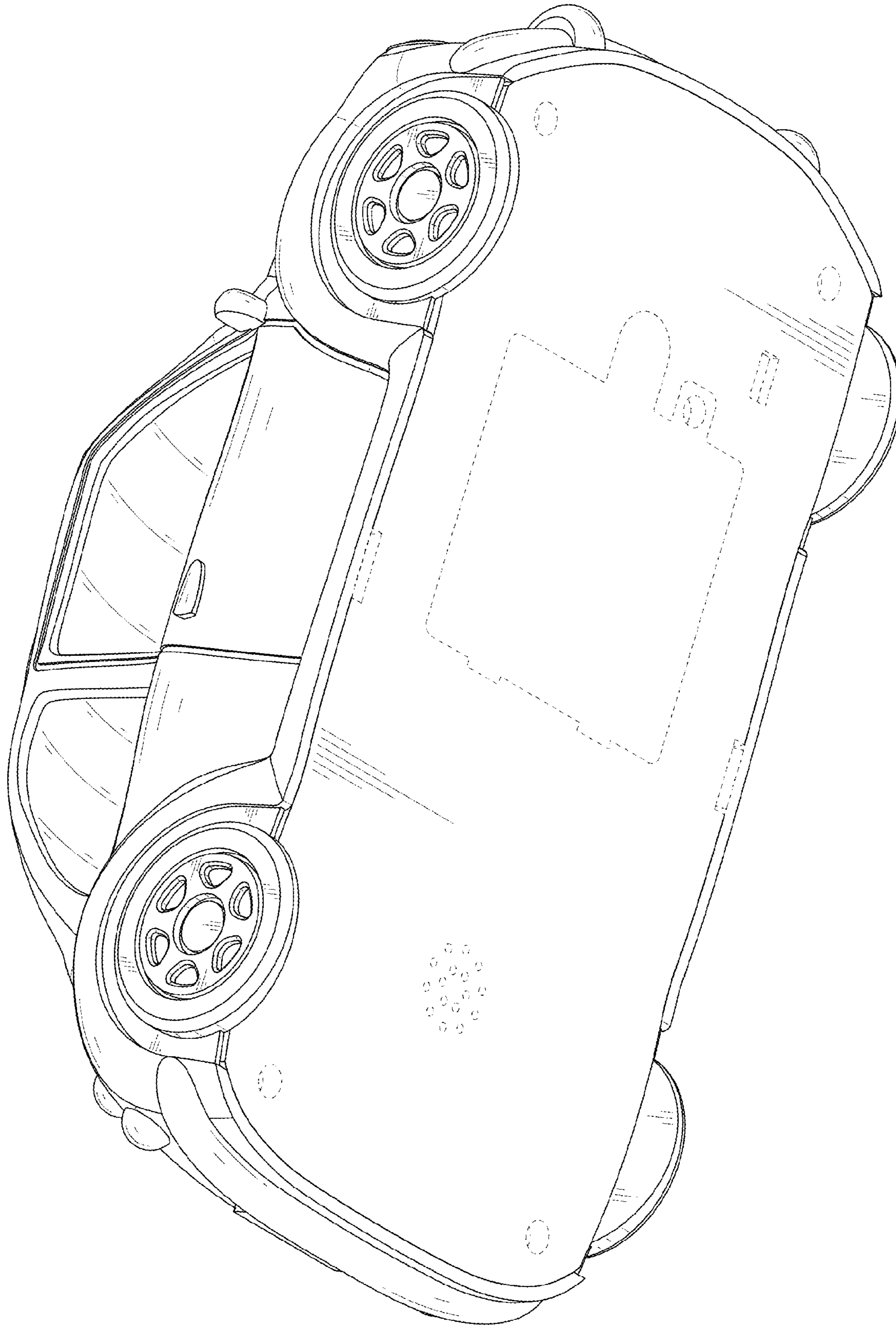

FIG. 2

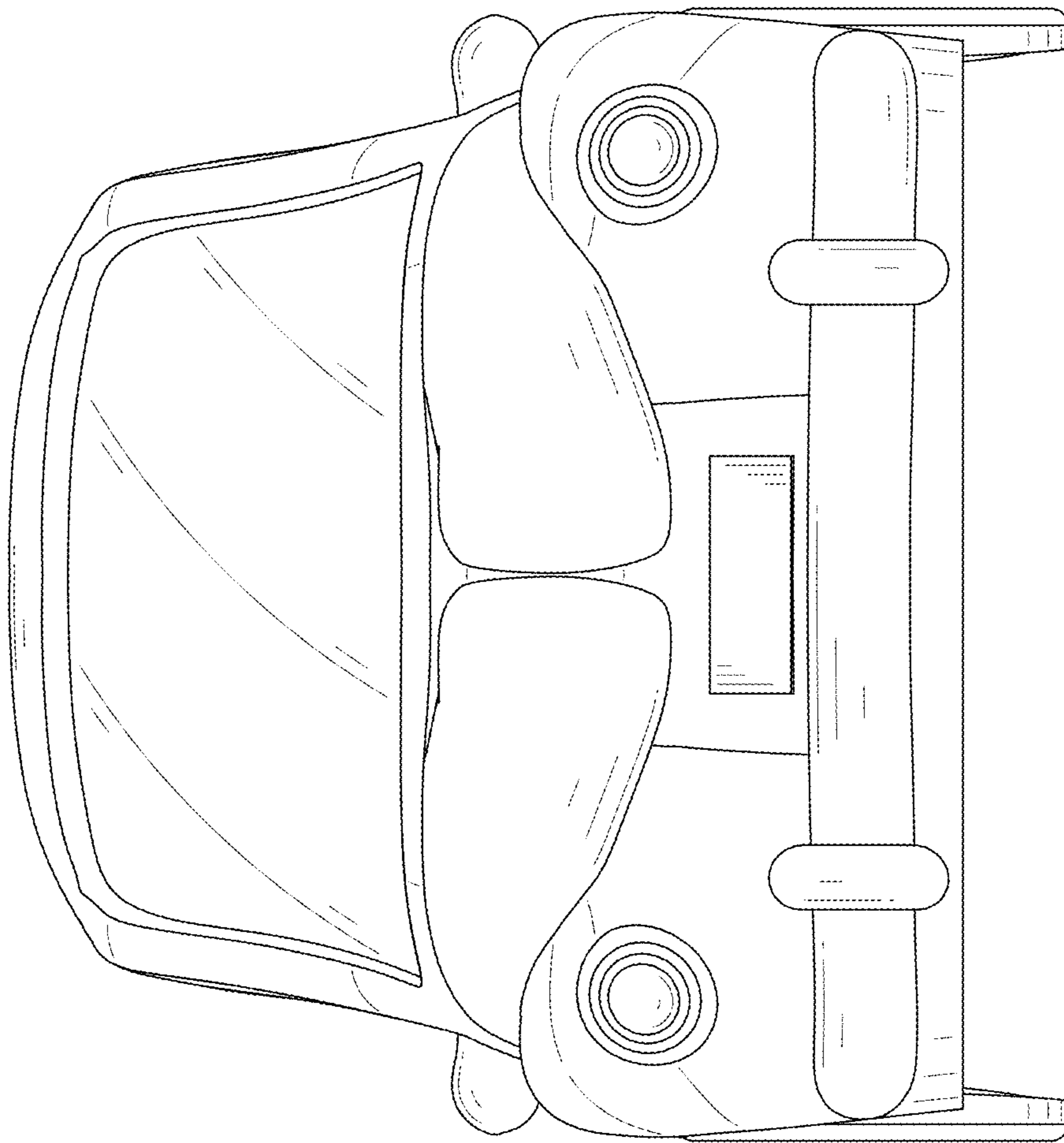

FIG. 3

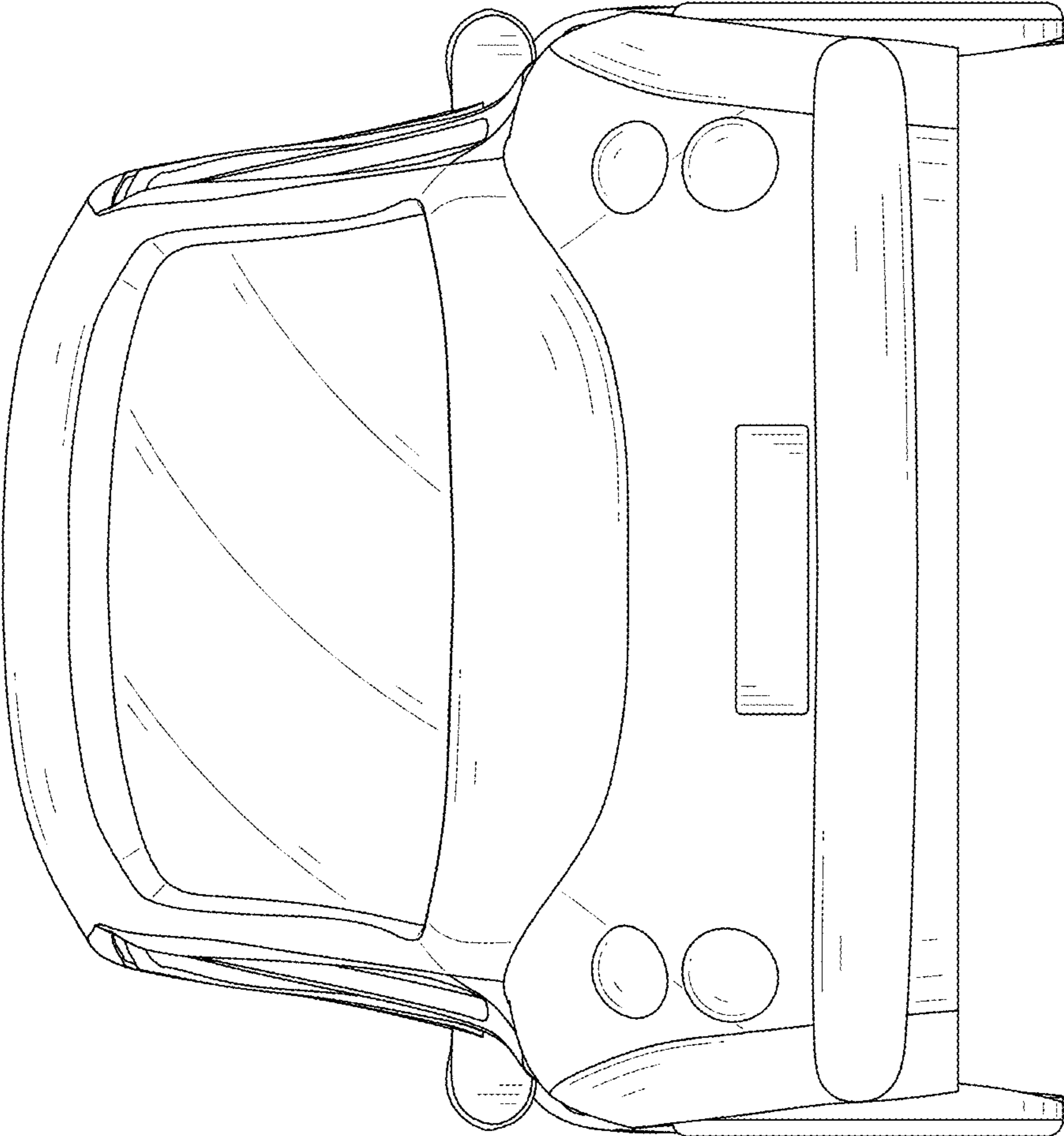

FIG. 4

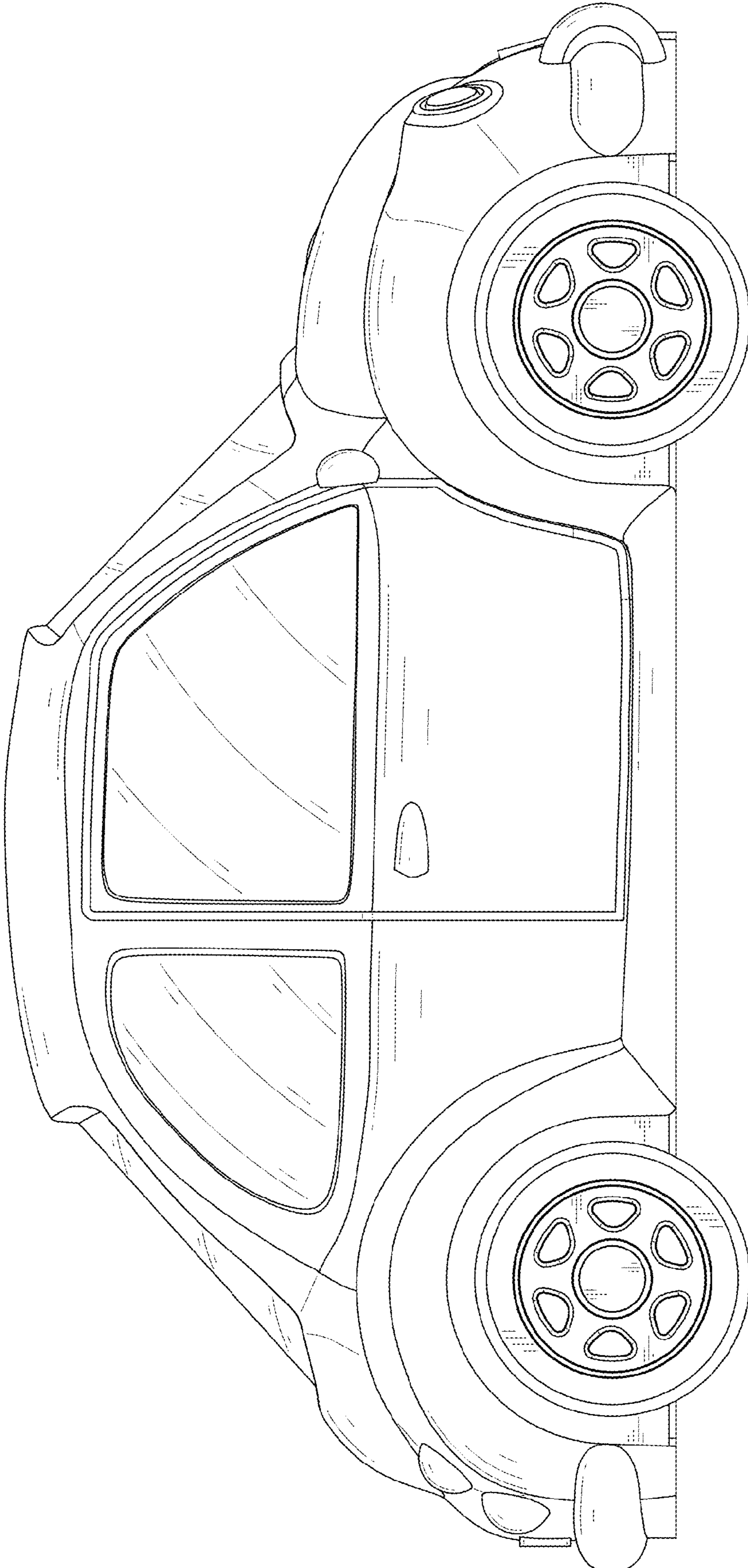

FIG. 5

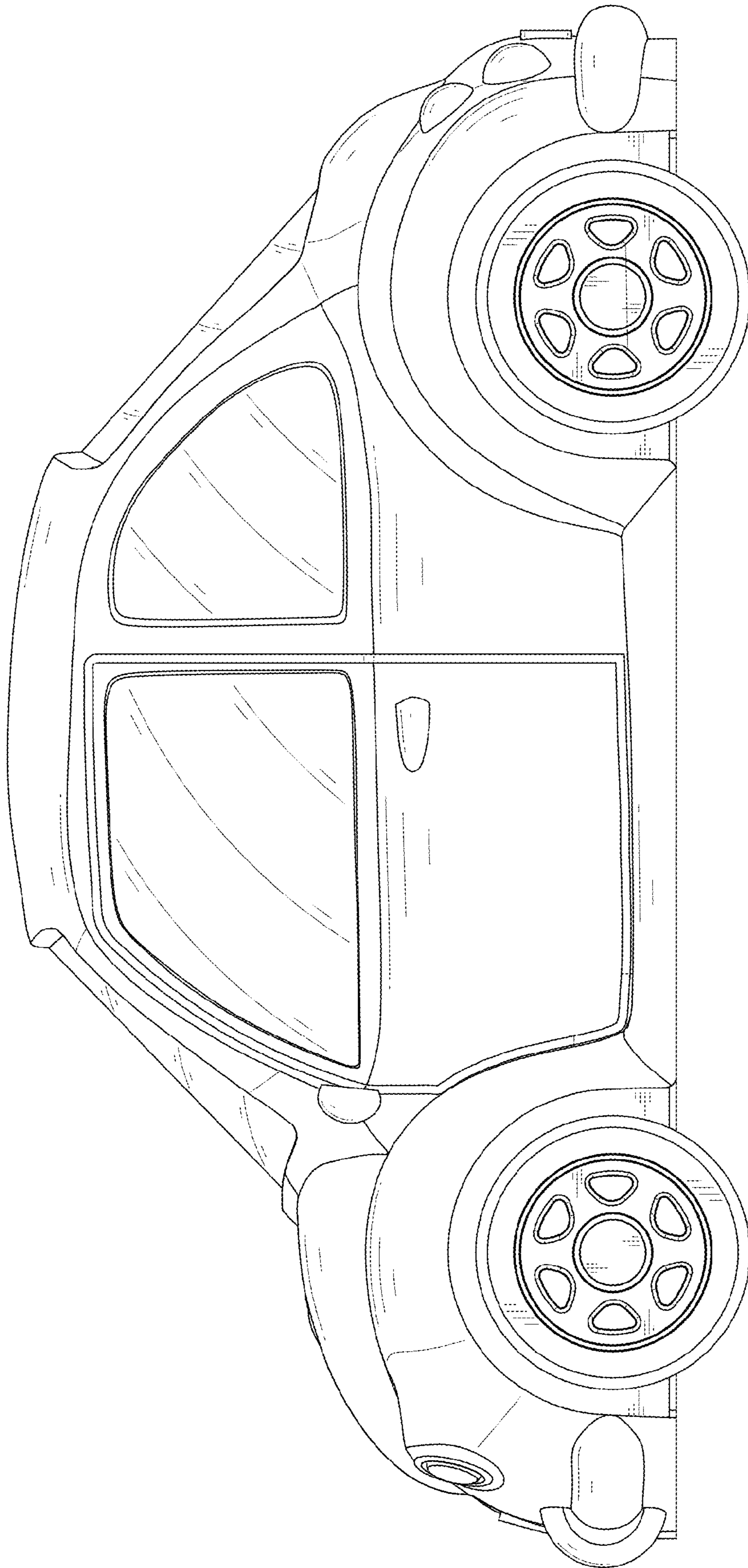

FIG. 6

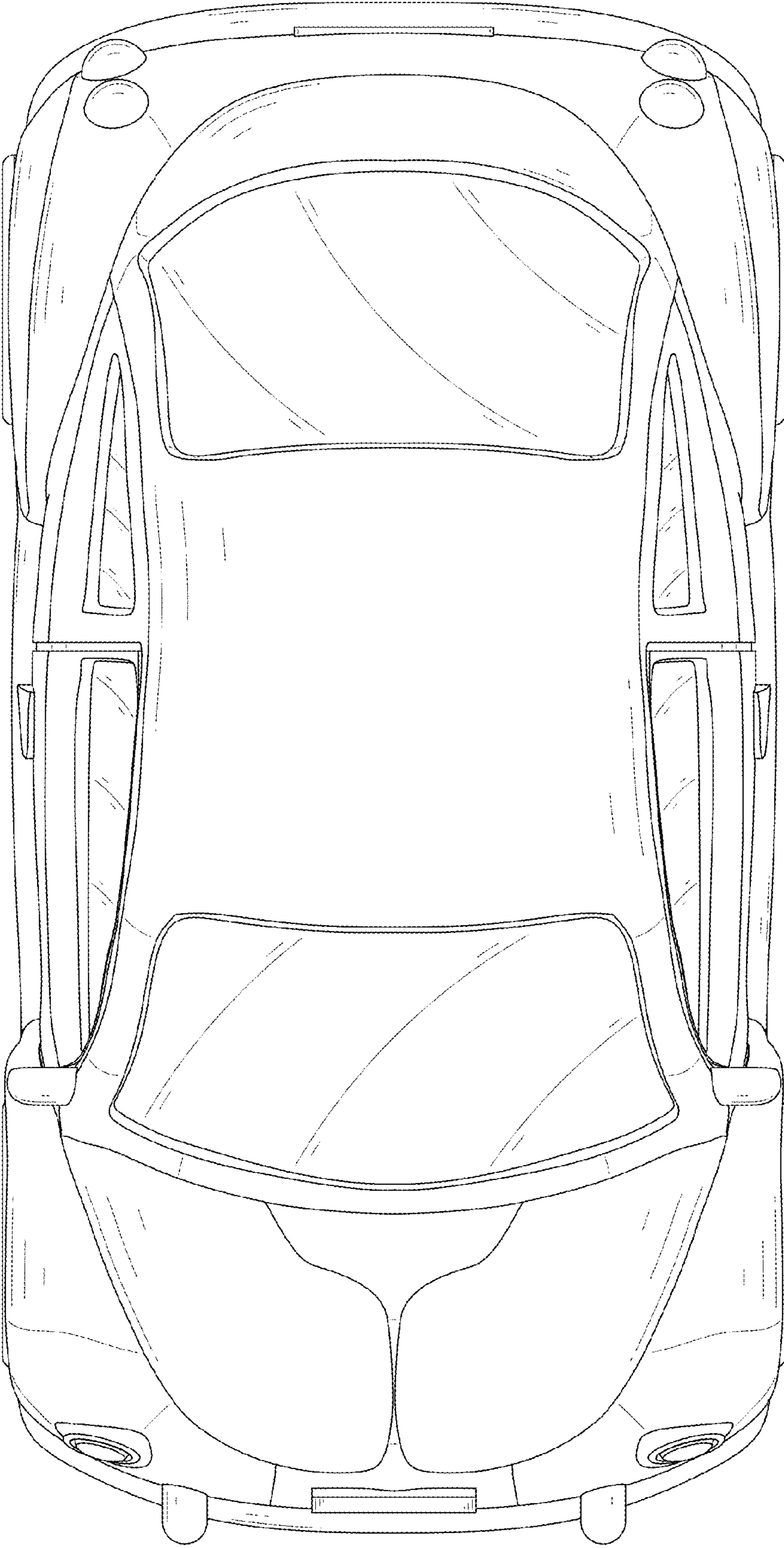

FIG. 7

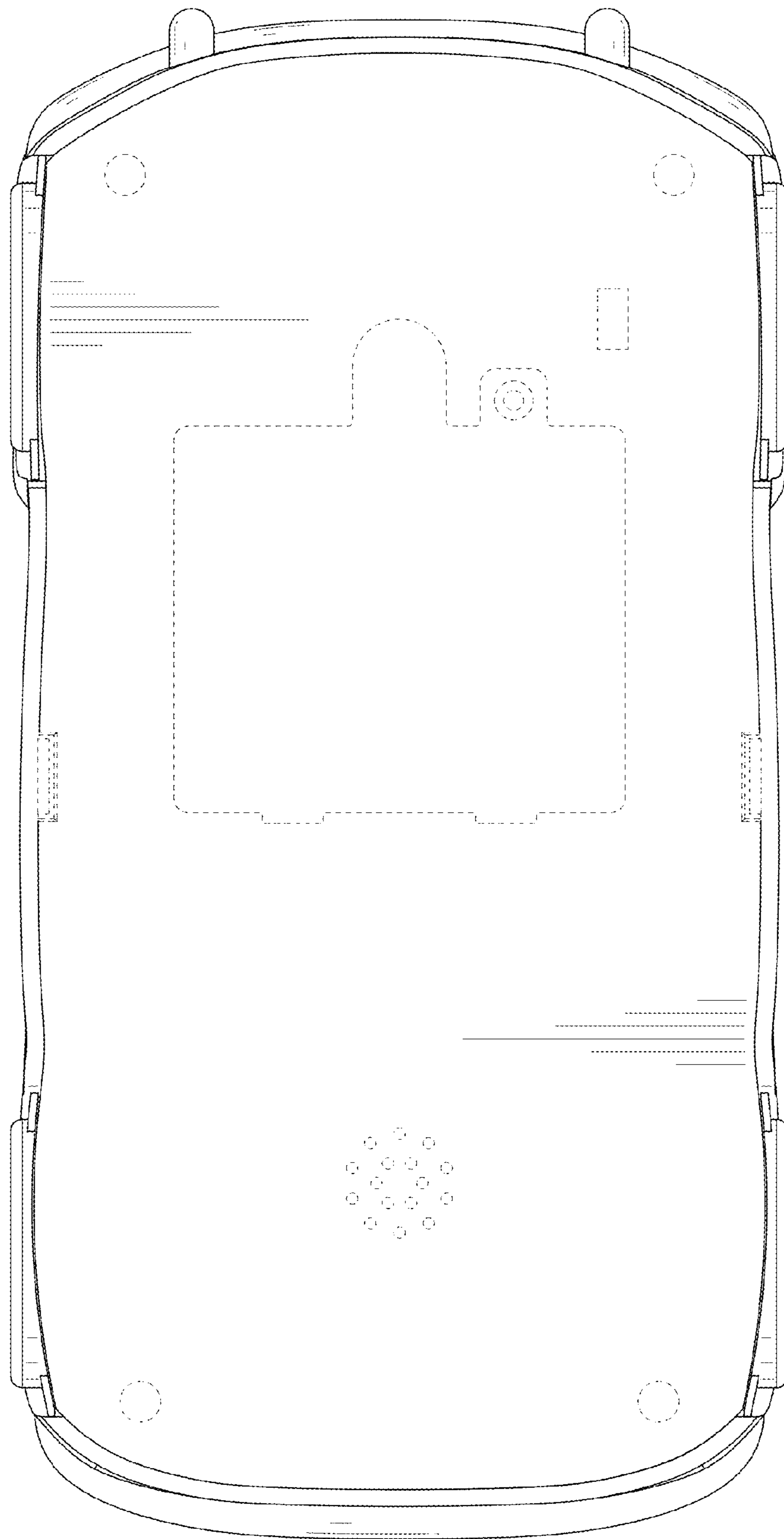

FIG. 8