



US00D989309S

(12) **United States Design Patent**
Levy et al.

(10) **Patent No.:** **US D989,309 S**
(45) **Date of Patent:** **** Jun. 13, 2023**

(54) **ULTRASONIC SURGICAL BLADE**
(71) Applicant: **MISONIX, INCORPORATED**,
Farmingdale, NY (US)
(72) Inventors: **Elad I. Levy**, Amherst, NY (US);
Timothy O'Connor, Boca Raton, FL
(US); **Dan Voic**, Cedar Grave, NJ (US)
(73) Assignee: **MISONIX, LLC**, Farmingdale, NY
(US)

D665,908 S * 8/2012 Detry D24/146
D667,117 S 9/2012 Darian et al.
D680,218 S * 4/2013 Darian D24/146
8,888,783 B2 11/2014 Young
9,763,673 B2 9/2017 Young
D862,184 S * 10/2019 Bloom D8/20
D882,789 S * 4/2020 Qun D24/146
D888,955 S * 6/2020 Qun D24/146
D910,849 S * 2/2021 Shi D24/146
D939,089 S * 12/2021 Cao D24/146
D972,137 S * 12/2022 Schifano D24/147
D974,558 S * 1/2023 Gras D24/146
2021/0030435 A1 * 2/2021 Cao A61B 17/142

(**) Term: **15 Years**

* cited by examiner

(21) Appl. No.: **29/803,646**

Primary Examiner — Samantha Q Lawrence

(22) Filed: **Aug. 13, 2021**

(74) *Attorney, Agent, or Firm* — R. Neil Sudol; Henry D. Coleman

(51) **LOC (14) Cl.** **24-02**

(52) **U.S. Cl.**
USPC **D24/146**

(58) **Field of Classification Search**
USPC D24/146, 147, 127, 130, 133
CPC A61B 17/089; A61B 17/1617; A61B
17/3211; A61B 17/3417; A61B 17/1411;
A61B 50/33; A61B 17/3209; A61B
50/20; A61B 17/32; A61B 50/3001; A61B
50/36; A61B 50/362; A61B 17/16; A61B
17/142; A61B 17/144; A61B 17/14;
A61H 39/08; A61M 2025/0246; A61M
16/04; A61M 16/0463; A61M 16/0484;
A61M 25/0009; A61M 25/007; A61M
25/02; A61M 25/09033; A61M 5/3286;
A61M 5/343
See application file for complete search history.

(57) **CLAIM**

The ornamental design for the ultrasonic surgical blade, as shown and described.

DESCRIPTION

FIG. 1 is a top plan view of an ultrasonic surgical blade, showing our new design, the bottom plan view being a mirror image thereof; FIG. 2 is a rear, left side and top perspective view thereof; FIG. 3 is a front elevational view thereof; FIG. 4 is a rear elevational view thereof; FIG. 5 is a right side elevational view thereof, the left side elevation view being a mirror image thereof; and, FIG. 6 is a partial top plan view thereof, on an enlarged scale, showing detail VI in FIG. 1.

(56) **References Cited**

U.S. PATENT DOCUMENTS

5,261,922 A 11/1993 Hood
D655,006 S * 2/2012 Rajaiah D24/152

1 Claim, 1 Drawing Sheet

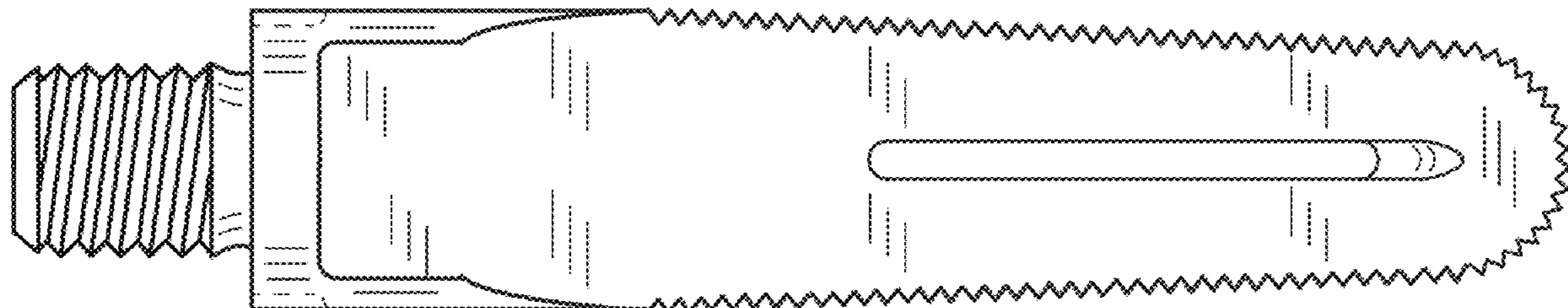

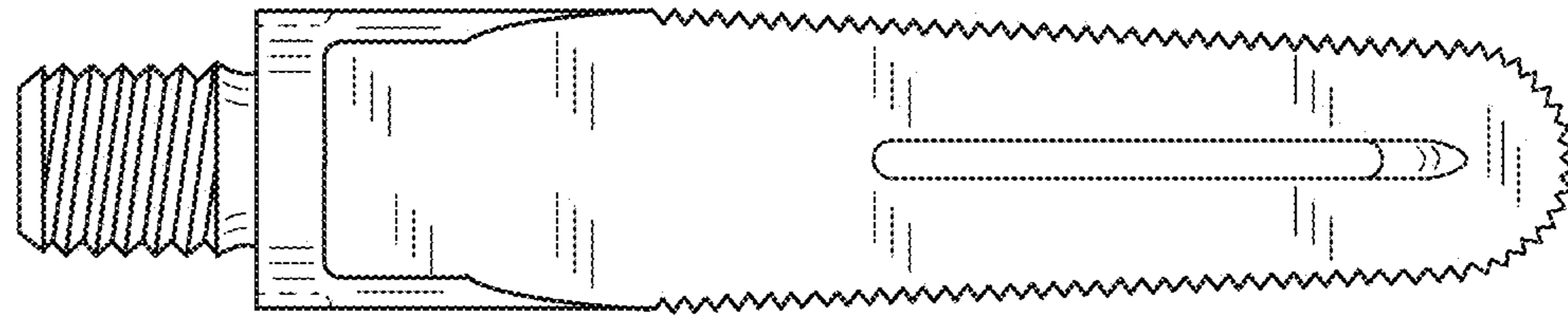

FIG. 1

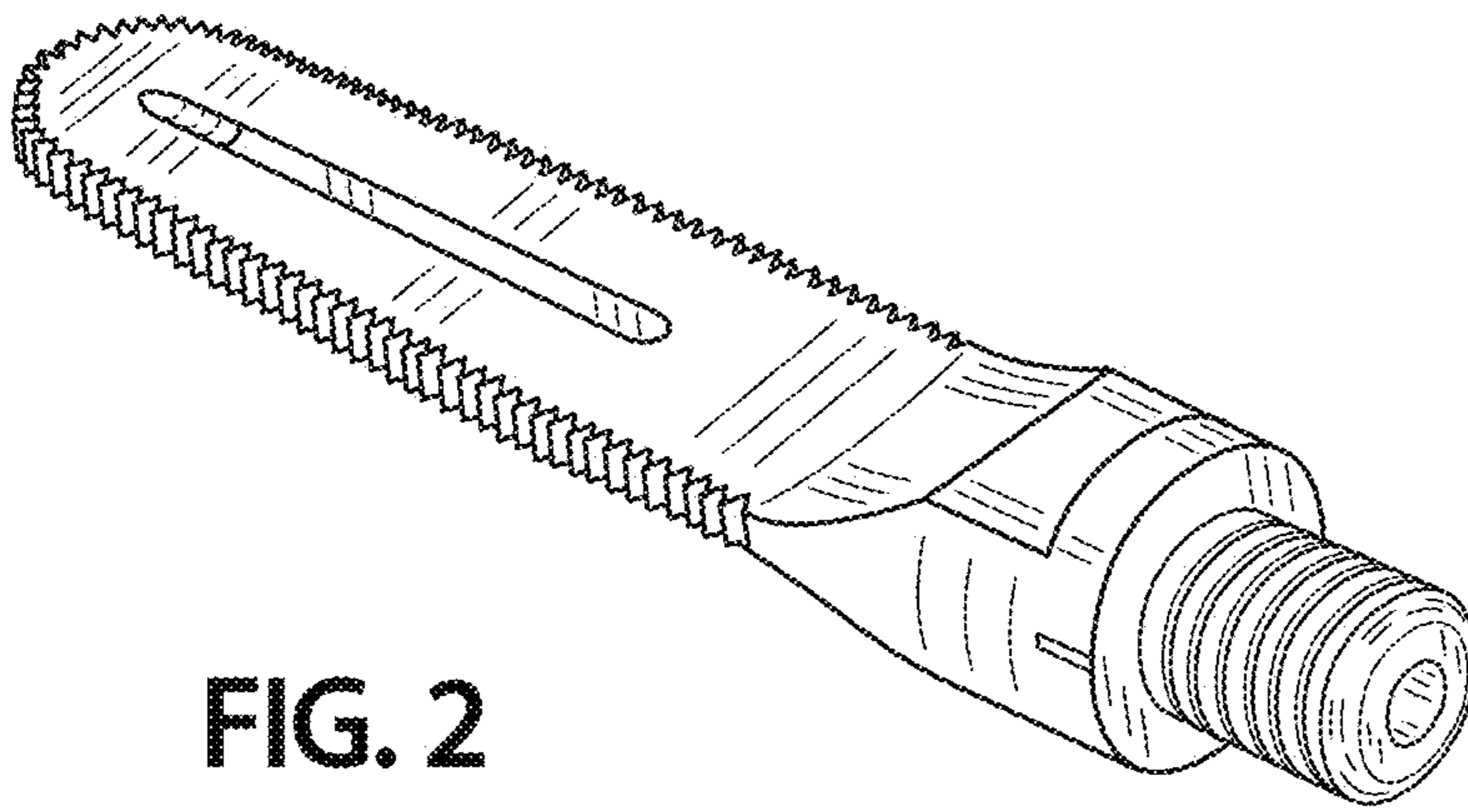

FIG. 2

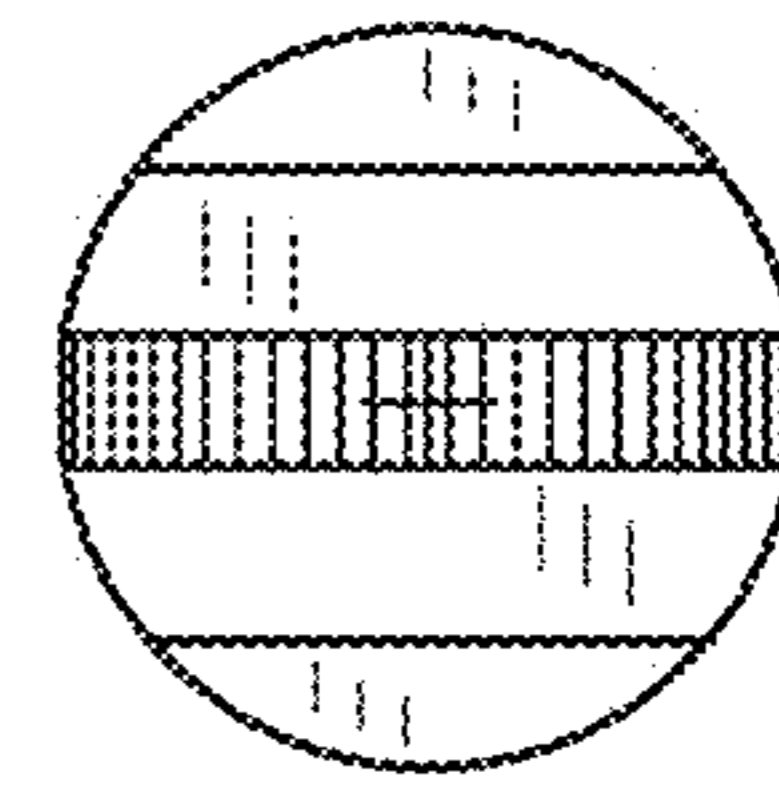

FIG. 3

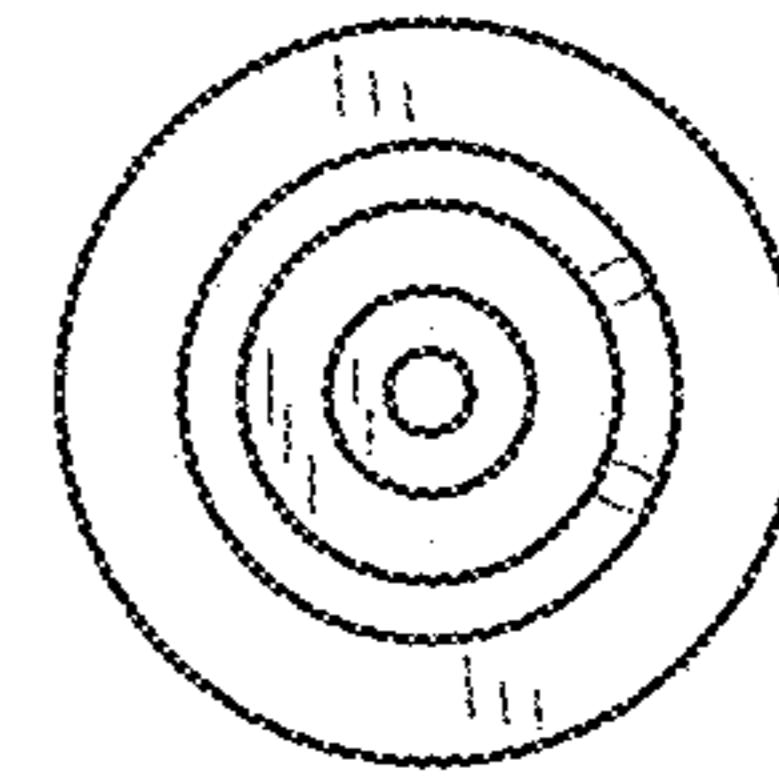

FIG. 4

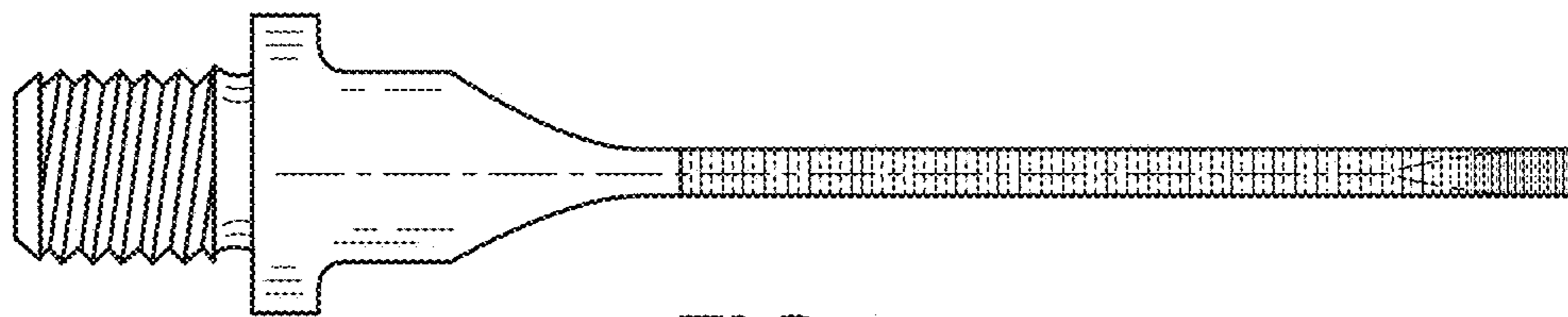

FIG. 5

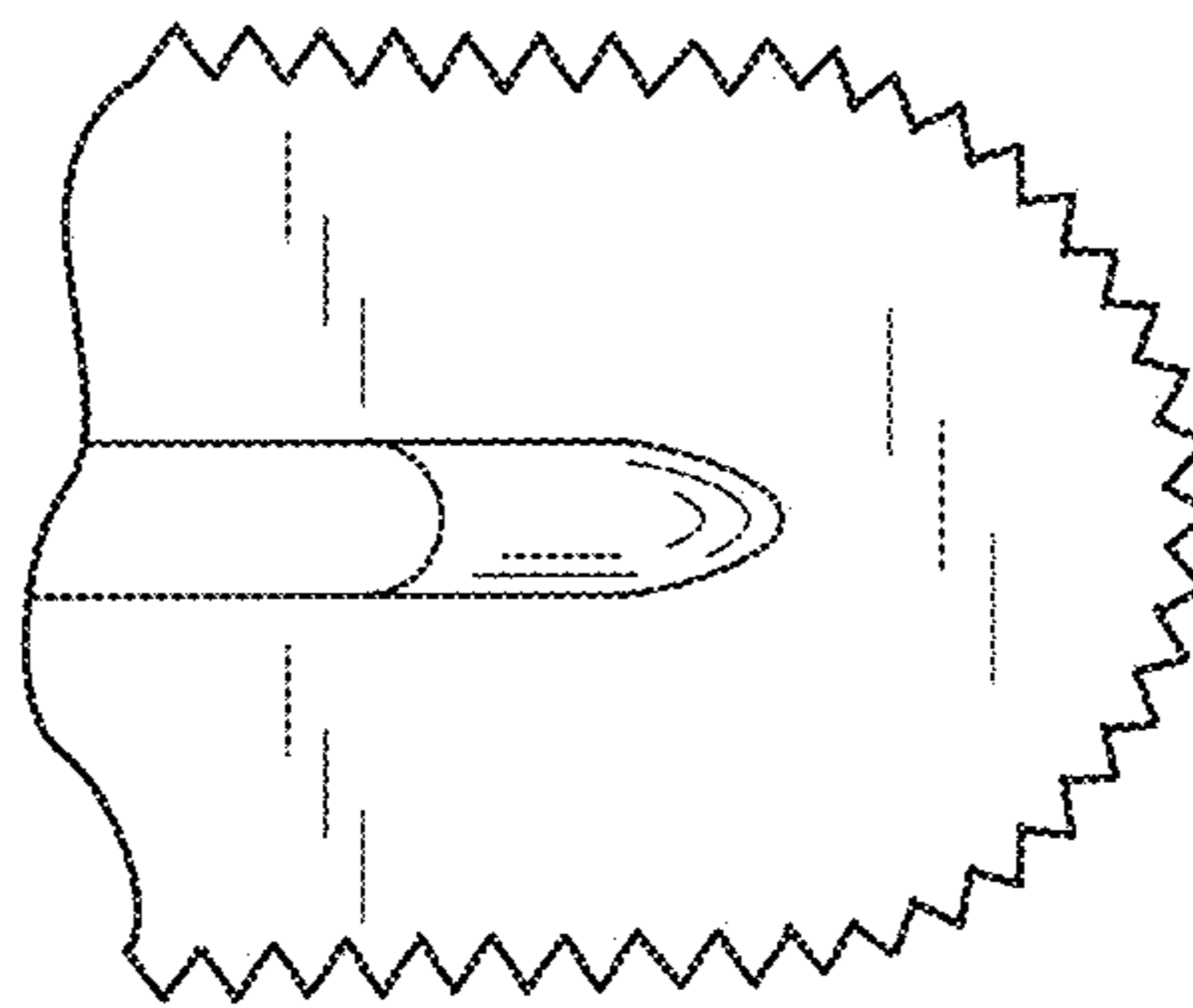

FIG. 6