



US00D989249S

(12) **United States Design Patent**
Yang

(10) **Patent No.:** **US D989,249 S**
(45) **Date of Patent:** **** Jun. 13, 2023**

(54) **CHILD URINAL**

(71) Applicant: **XIAMEN BABY PRETTY PRODUCTS CO., LTD.**, Xiamen (CN)

(72) Inventor: **Jianbo Yang**, Xiamen (CN)

(73) Assignee: **XIAMEN BABY PRETTY PRODUCTS CO., LTD.**, Xiamen (CN)

(**) Term: **15 Years**

(21) Appl. No.: **29/783,009**

(22) Filed: **May 11, 2021**

(51) **LOC (14) Cl.** **23-07**

(52) **U.S. Cl.**
USPC **D23/302**

(58) **Field of Classification Search**
USPC D23/278–279, 295–303, 309, 311, 499
CPC A47K 13/06
See application file for complete search history.

(56) **References Cited**

U.S. PATENT DOCUMENTS

3,170,170	A *	2/1965	Deslauriers	A61G 9/006 4/144.1
D362,716	S *	9/1995	Kolada	D23/302
D501,675	S *	2/2005	Iranyi	D23/302
8,635,716	B2 *	1/2014	Shon	A47K 11/12 4/144.1
D884,848	S *	5/2020	Nakashima	D23/302
2022/0211228	A1 *	7/2022	Yang	A47K 11/12

FOREIGN PATENT DOCUMENTS

CN	305386046	*	10/2019
ID	A00202100769-0001	*	3/2021

OTHER PUBLICATIONS

Potty Training for Boys, announced Feb. 23, 2019[online], [site visited Sep. 22, 2022]. Available from internet, URL:<<https://www.amazon.ca/dp/B07L5DS3W4?th=1>> (Year: 2019).*

Ivyrise Frog Children Toilet Potty Training Urinal, announced Oct. 14, 2016[online], [site visited Sep. 22, 2022]. Available from internet, URL:<<https://www.amazon.ca/dp/B01M6WU8OA?th=1>> (Year: 2016).*

* cited by examiner

Primary Examiner — Jae Liang

Assistant Examiner — Jamaal Rasheed

(74) *Attorney, Agent, or Firm* — Bayramoglu Law Offices LLC

(57) **CLAIM**

The ornamental design for a child urinal, as shown and described.

DESCRIPTION

FIG. 1 is a perspective view of a child urinal showing my new design;

FIG. 2 is a front view thereof;

FIG. 3 is a rear view thereof;

FIG. 4 is a left side view thereof;

FIG. 5 is a right side view thereof;

FIG. 6 is a top view thereof; and,

FIG. 7 is a bottom view thereof.

The broken lines depict portions of the child urinal that form no part of the claimed design.

1 Claim, 7 Drawing Sheets

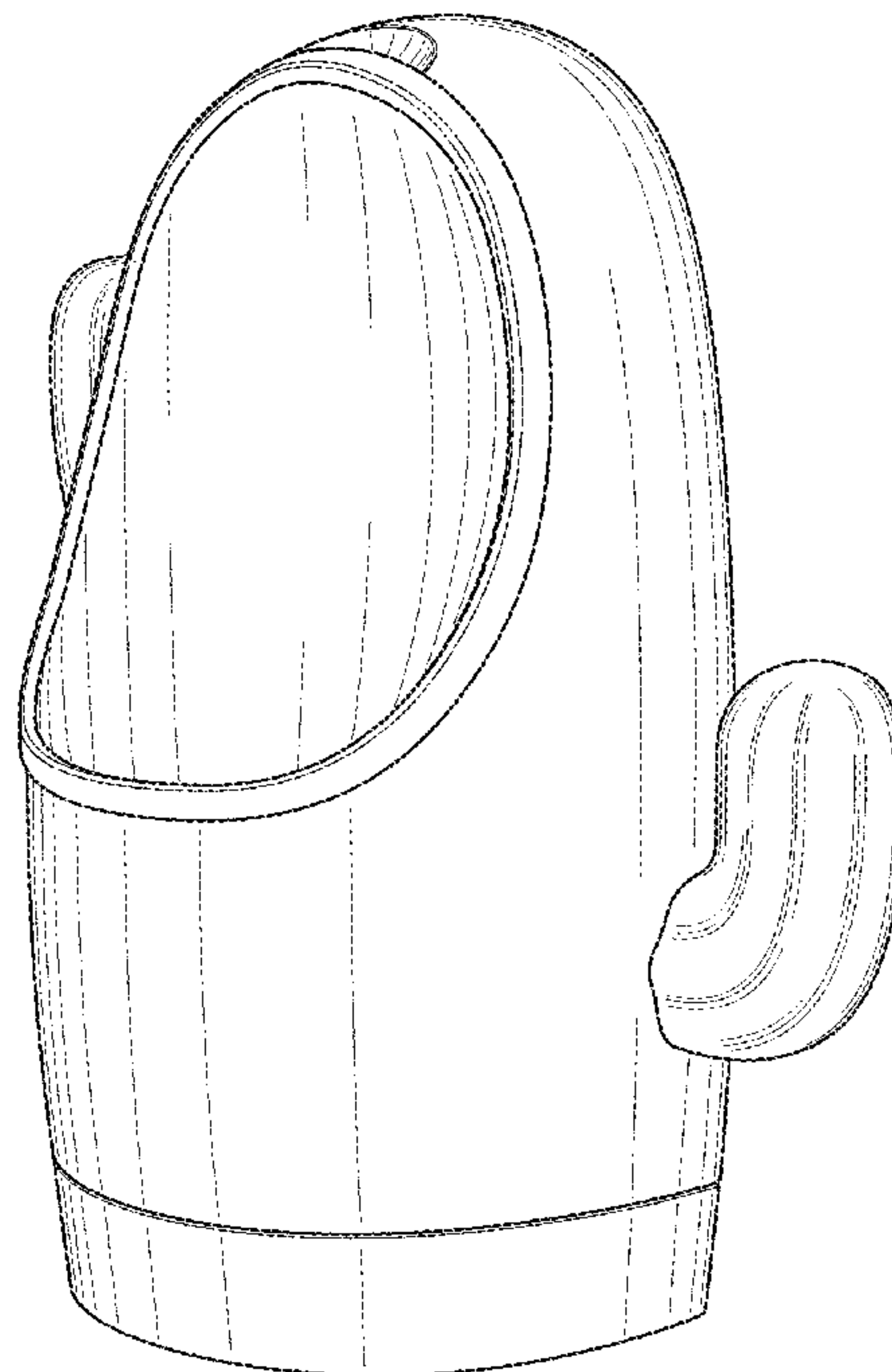

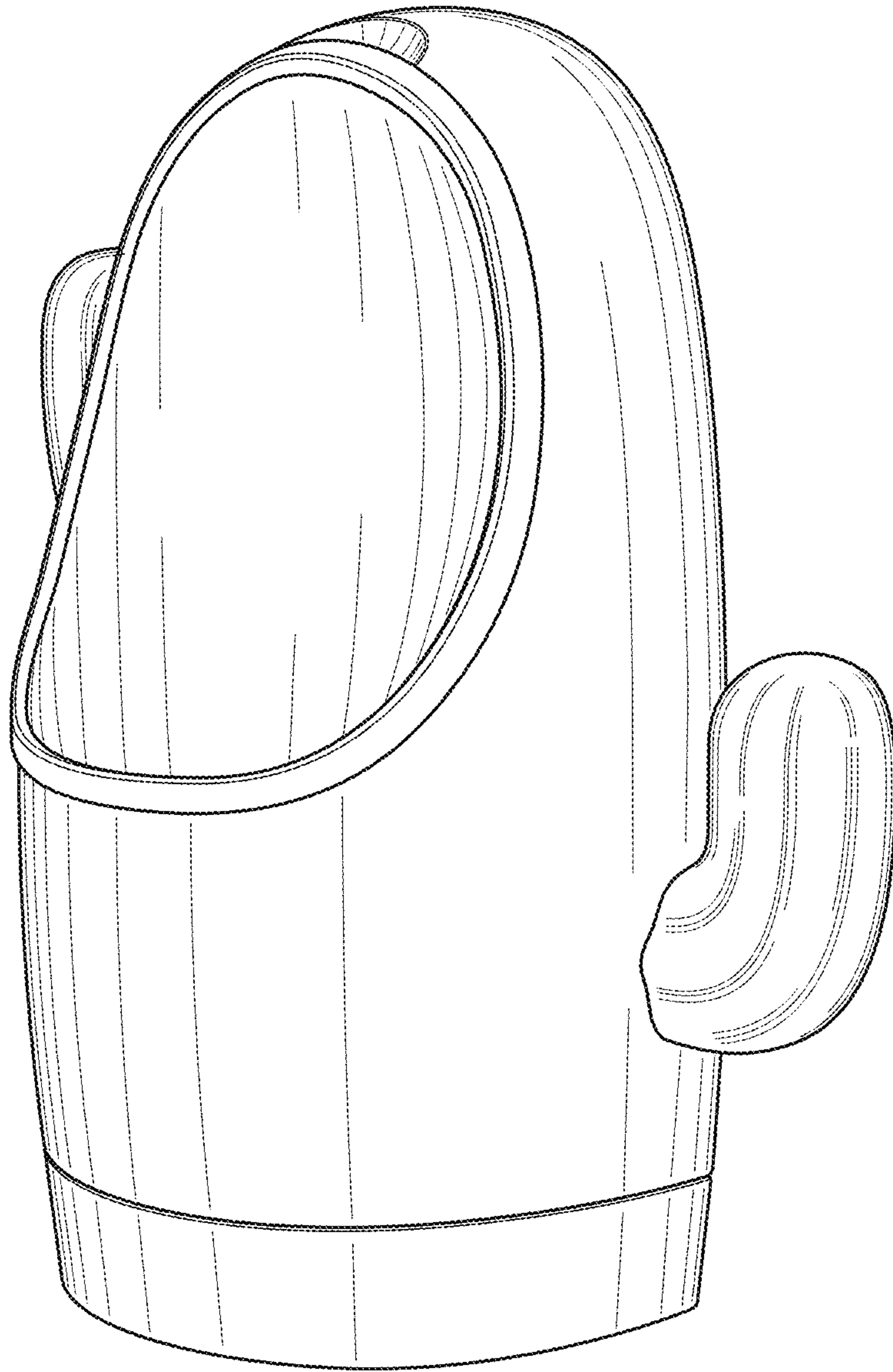

Fig. 1

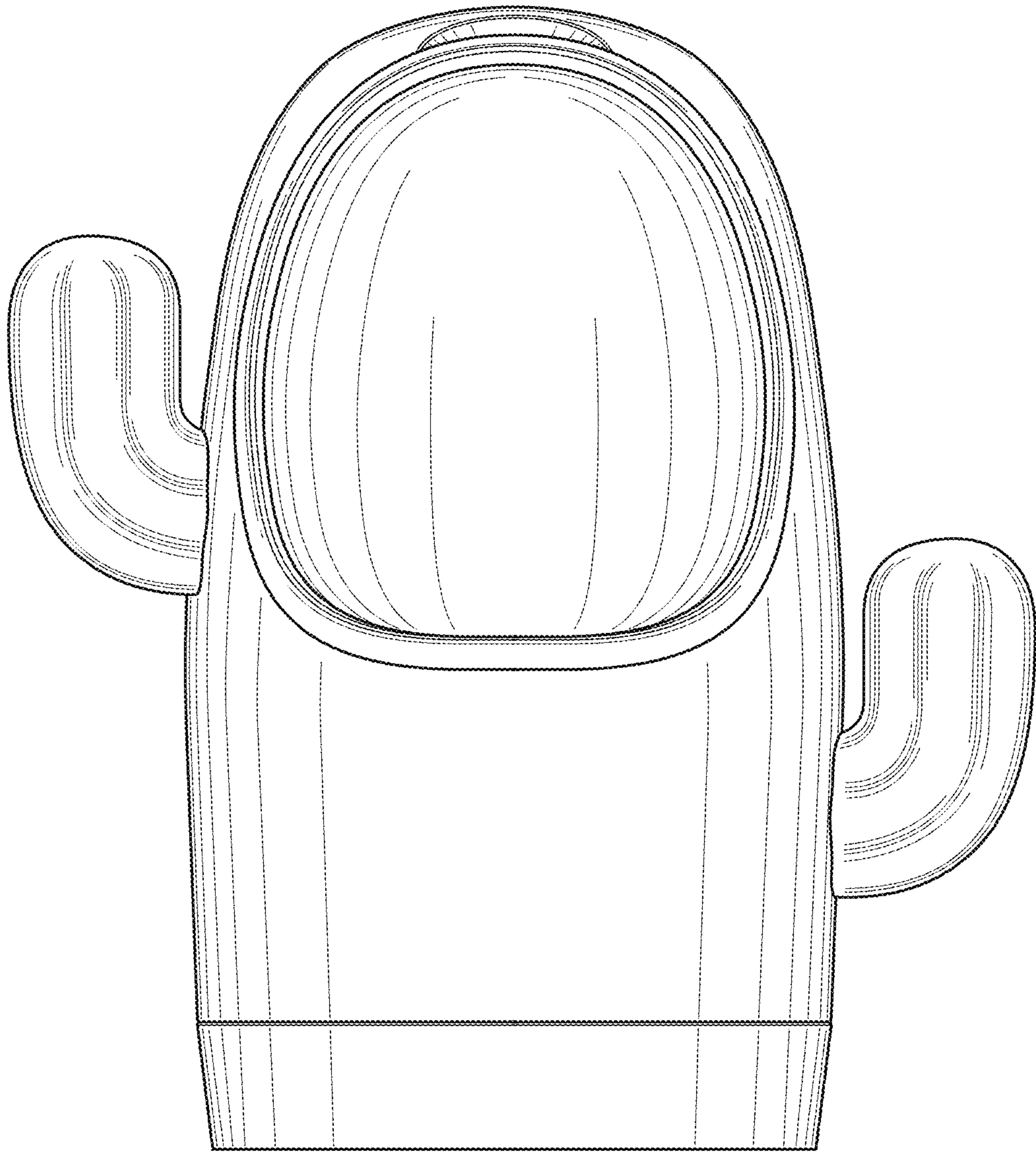

Fig. 2

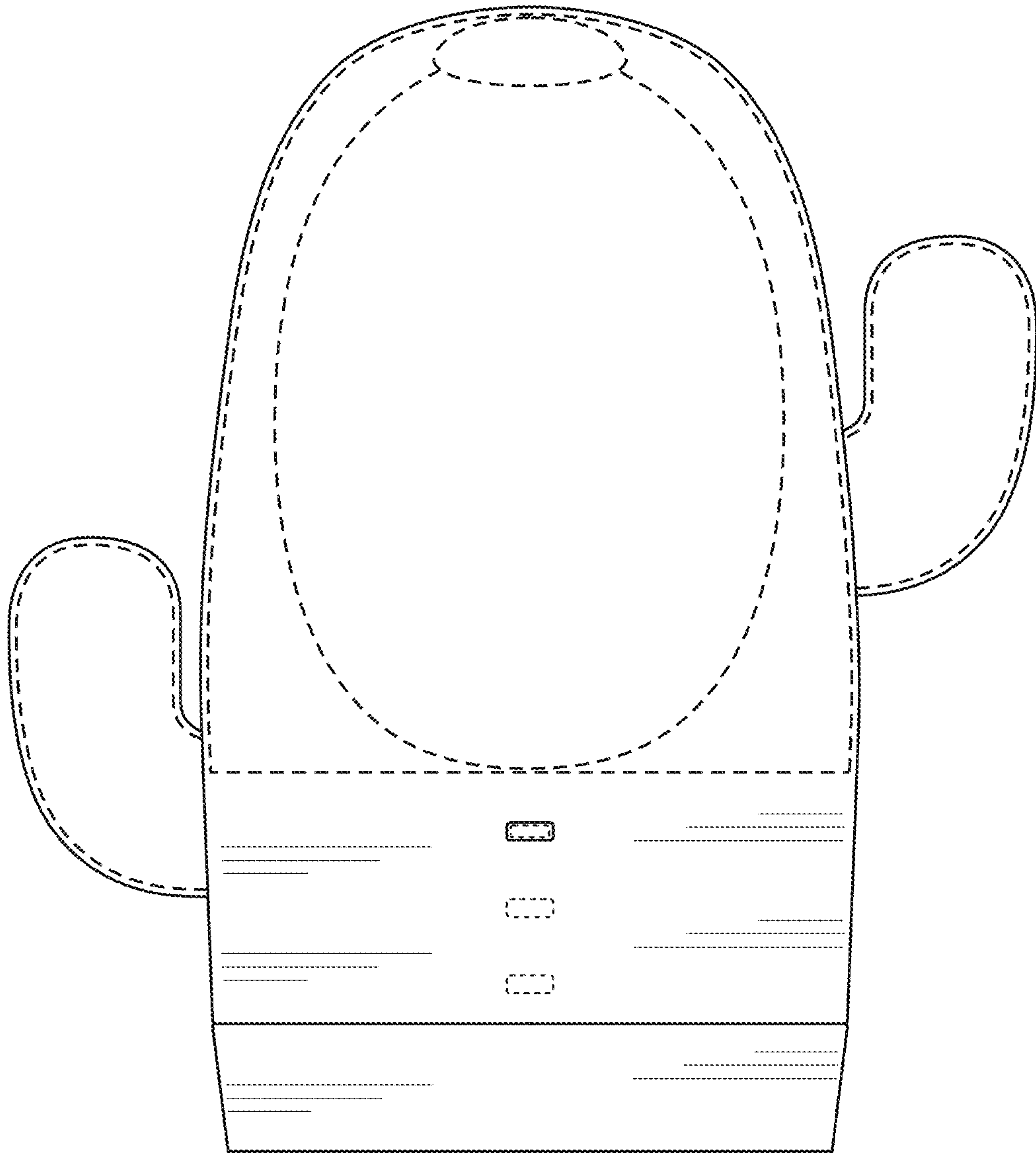

Fig. 3

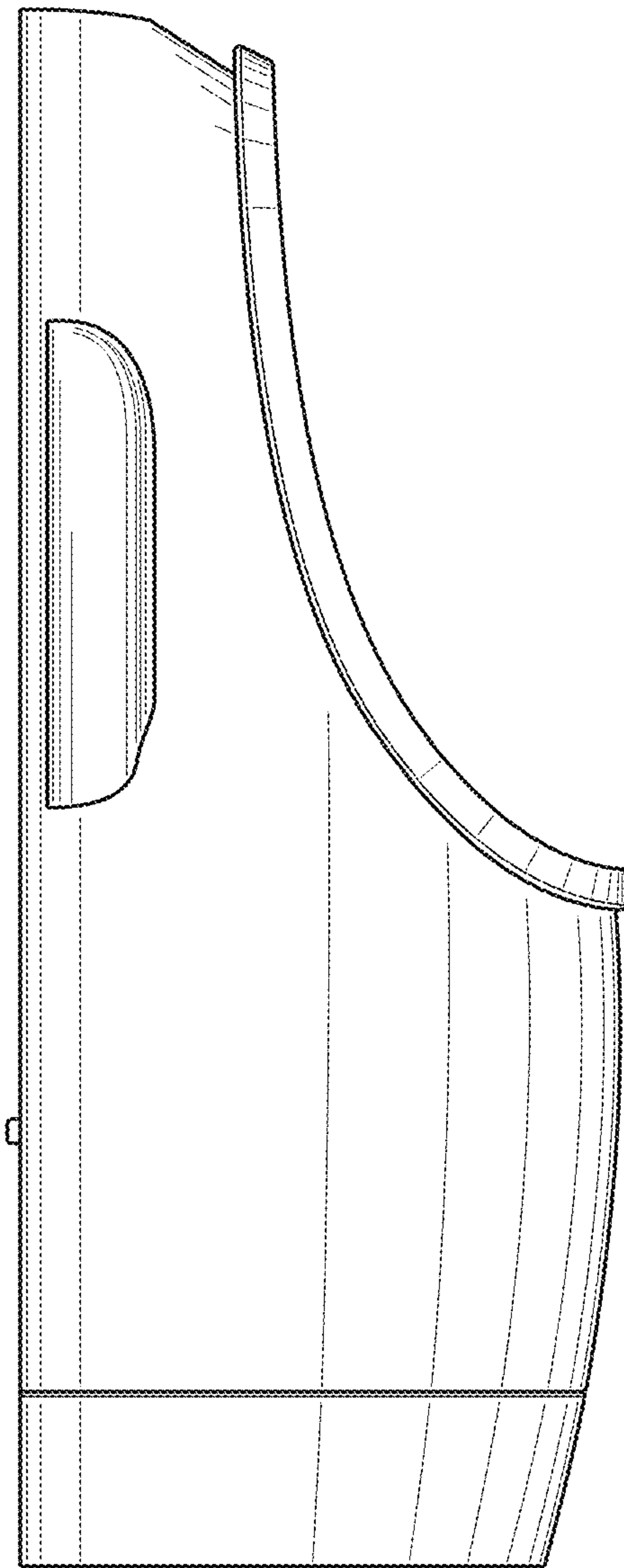

Fig. 4

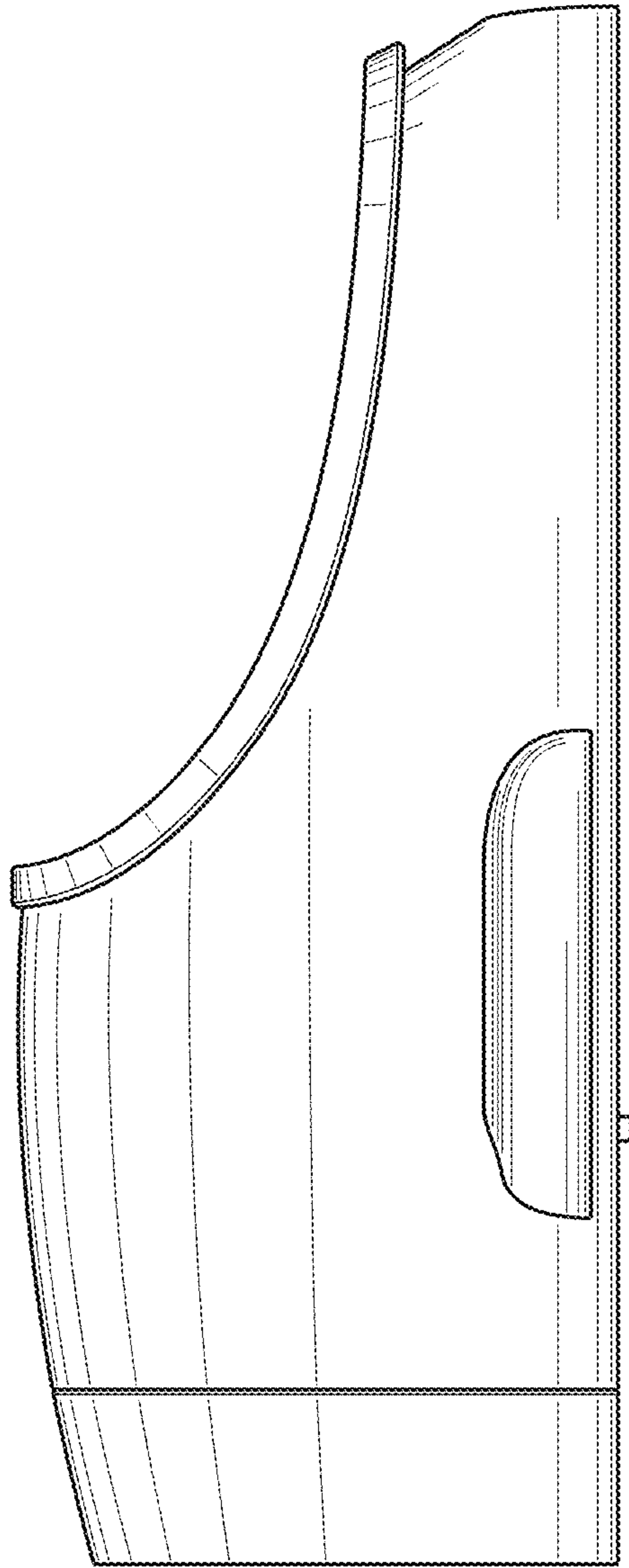

Fig. 5

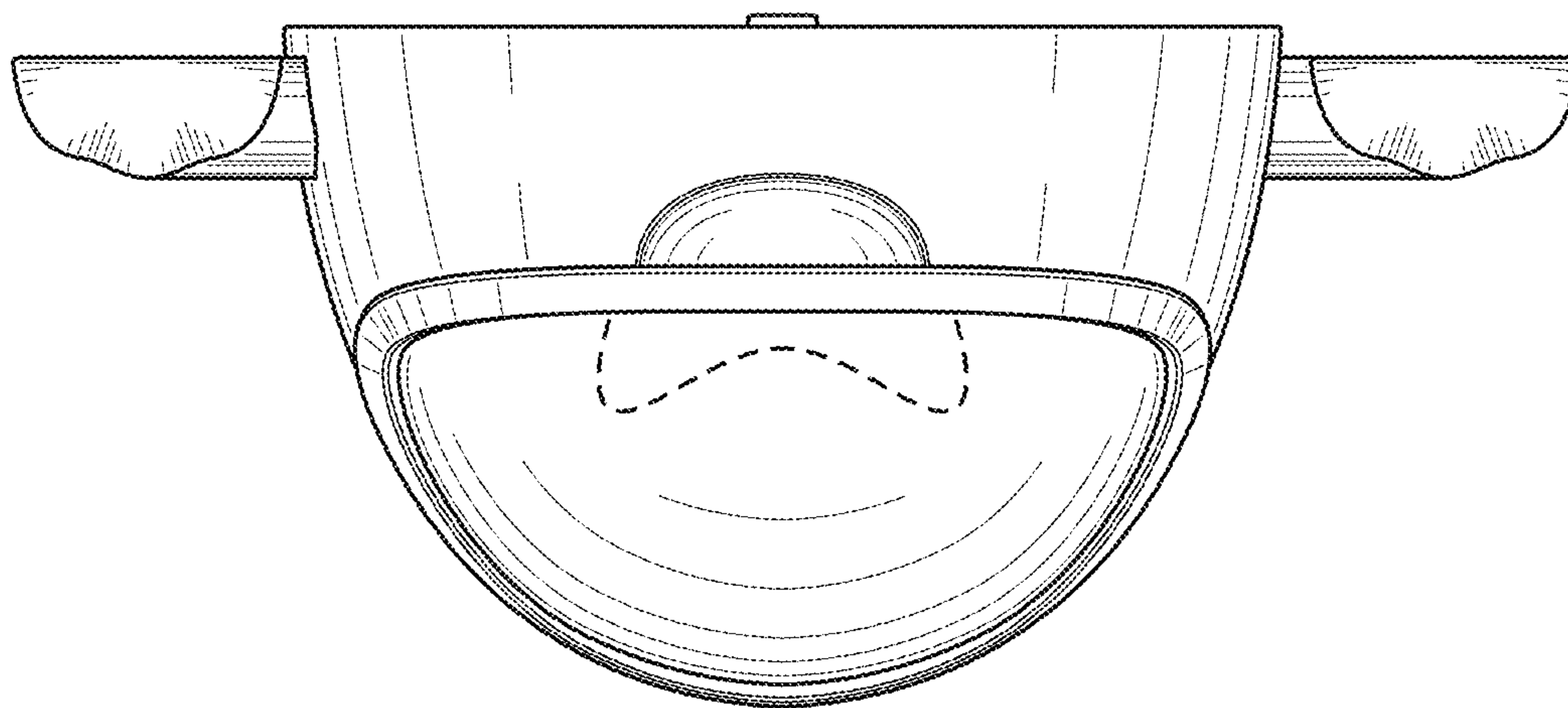

Fig. 6

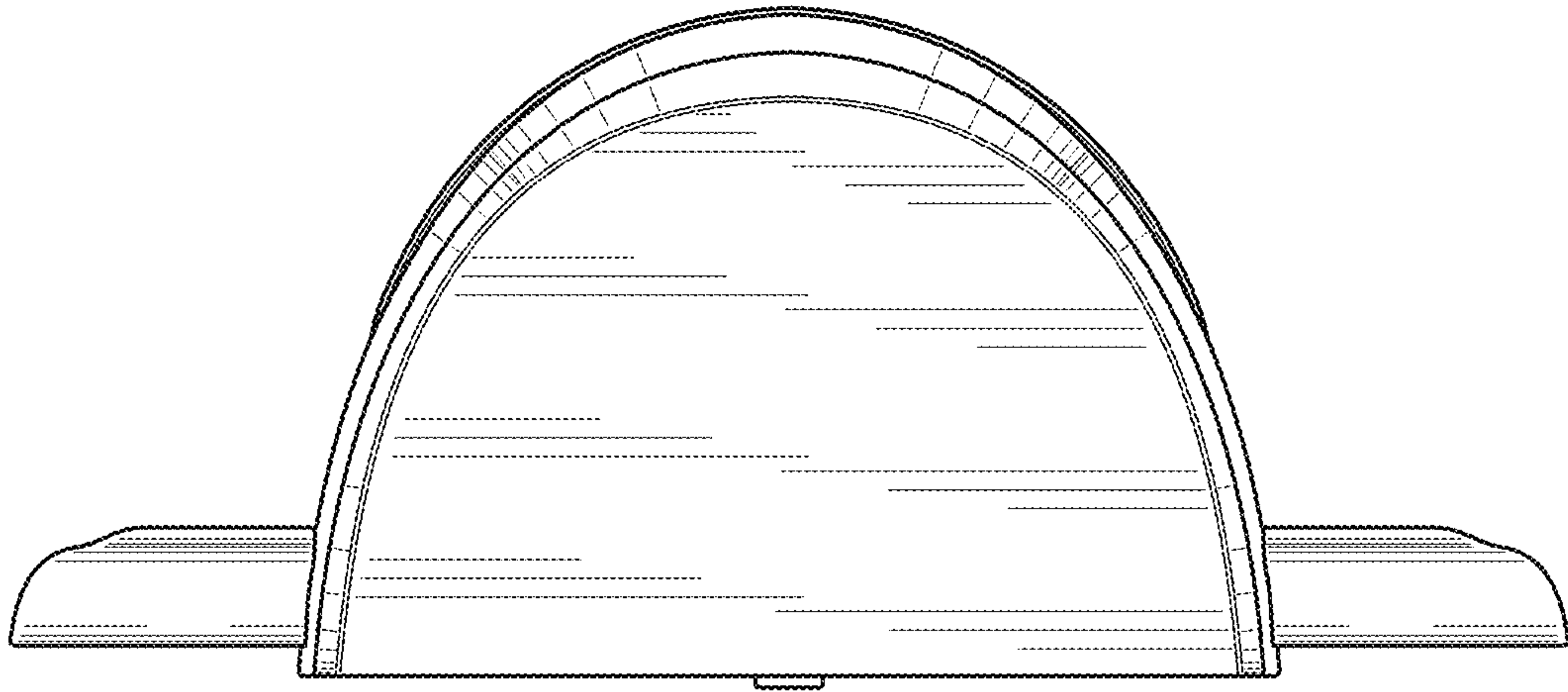

Fig. 7