



US00D989241S

(12) **United States Design Patent** (10) **Patent No.:** **US D989,241 S**
Lee et al. (45) **Date of Patent:** **** Jun. 13, 2023**

(54) **SHOWER HANDLE**

D465,268 S * 11/2002 Mullenmeister D23/253
D509,285 S * 9/2005 Blattner D23/252
D520,606 S 5/2006 Hoernig

(Continued)

(71) Applicant: **Kohler Co.**, Kohler, WI (US)

(72) Inventors: **Dongha Lee**, Sheboygan, WI (US);
Rafael A. Rexach, Sheboygan, WI
(US); **Drew Johnson**, Sheboygan, WI
(US)

FOREIGN PATENT DOCUMENTS

CN 101945708 A 1/2011
CN 104822462 A 8/2015
DE 39 07 379 A1 5/1990

(73) Assignee: **KOHLER CO.**, Kohler, WI (US)

(**) Term: **15 Years**

OTHER PUBLICATIONS

(21) Appl. No.: **29/853,911**

ferguson.com, "Weymouth Two Handle Bathroom Sink Faucet in Matte Black Cross Handle", https://www.ferguson.com/product/moen-weymouth-two-handle-bathroom-sink-faucet-in-matte-black-cross-handle-mts22101bl/_/R-7911812, dated Jul. 8, 2011 (3 pages).

(22) Filed: **Sep. 20, 2022**

Related U.S. Application Data

Primary Examiner — Robert A Delehanty

(60) Continuation of application No. 29/820,609, filed on Dec. 22, 2021, now Pat. No. Des. 967,938, which is a division of application No. 29/766,292, filed on Jan. 14, 2021, now Pat. No. Des. 941,436, which is a division of application No. 29/682,389, filed on Mar. 5, 2019, now Pat. No. Des. 909,541, which is a division of application No. 29/606,581, filed on Jun. 6, 2017, now Pat. No. Des. 847,307.

(74) *Attorney, Agent, or Firm* — Foley & Lardner LLP

(51) **LOC (14) Cl.** **23-01**

(57) **CLAIM**

(52) **U.S. Cl.**

We claim the ornamental design for a shower handle, as shown and described.

USPC **D23/253**

(58) **Field of Classification Search**

DESCRIPTION

USPC D23/238–243, 250, 252–254, 245, 249;
D8/307–308

See application file for complete search history.

FIG. 1 is a perspective view of the claimed design;
FIG. 2 is a front view thereof;
FIG. 3 is a rear view thereof;
FIG. 4 is a side view thereof;
FIG. 5 is another side view thereof;
FIG. 6 is a top view thereof; and,
FIG. 7 is a bottom view thereof.

The ornamental design which is claimed is shown in solid lines in the drawings. The broken lines in the drawings are for illustrative purposes only and form no part of the claimed design. Broken lines formed by equal length dashes show unclaimed subject matter. Broken lines formed by unequal length dashes (i.e., dash-dot) define bounds of the claimed design.

(56) **References Cited**

U.S. PATENT DOCUMENTS

3,465,968 A 9/1969 Halpern
D317,816 S 6/1991 Robbins
D458,344 S 6/2002 Mullenmeister
D458,346 S 6/2002 Mullenmeister
D458,668 S 6/2002 Mullenmeister

1 Claim, 6 Drawing Sheets

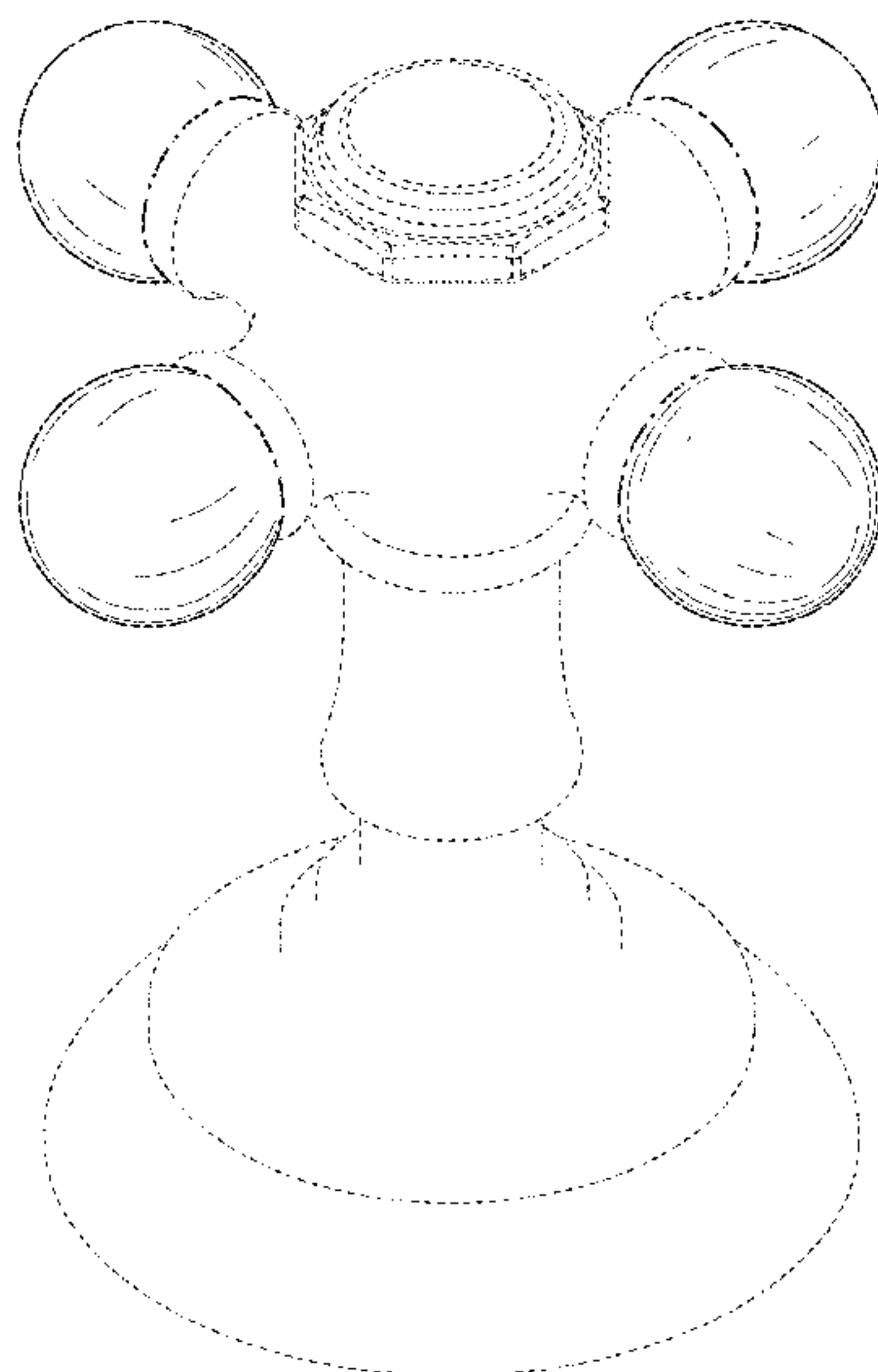

(56)

References Cited

U.S. PATENT DOCUMENTS

D527,804 S	9/2006	Chu et al.
D582,014 S	12/2008	Spangler
D615,626 S	5/2010	Tippens
D657,023 S	4/2012	McKeone
D672,437 S	12/2012	Kwok
D688,353 S	8/2013	Flowers
D717,919 S	11/2014	Rexach
D717,920 S	11/2014	Rexach
D717,921 S	11/2014	Rexach
D718,423 S	11/2014	Rexach
D718,842 S	12/2014	Rexach
D729,351 S	5/2015	Fritz
D731,029 S	6/2015	Fritz
D827,106 S	8/2018	Rexach et al.
2017/0189919 A1	7/2017	Mei

* cited by examiner

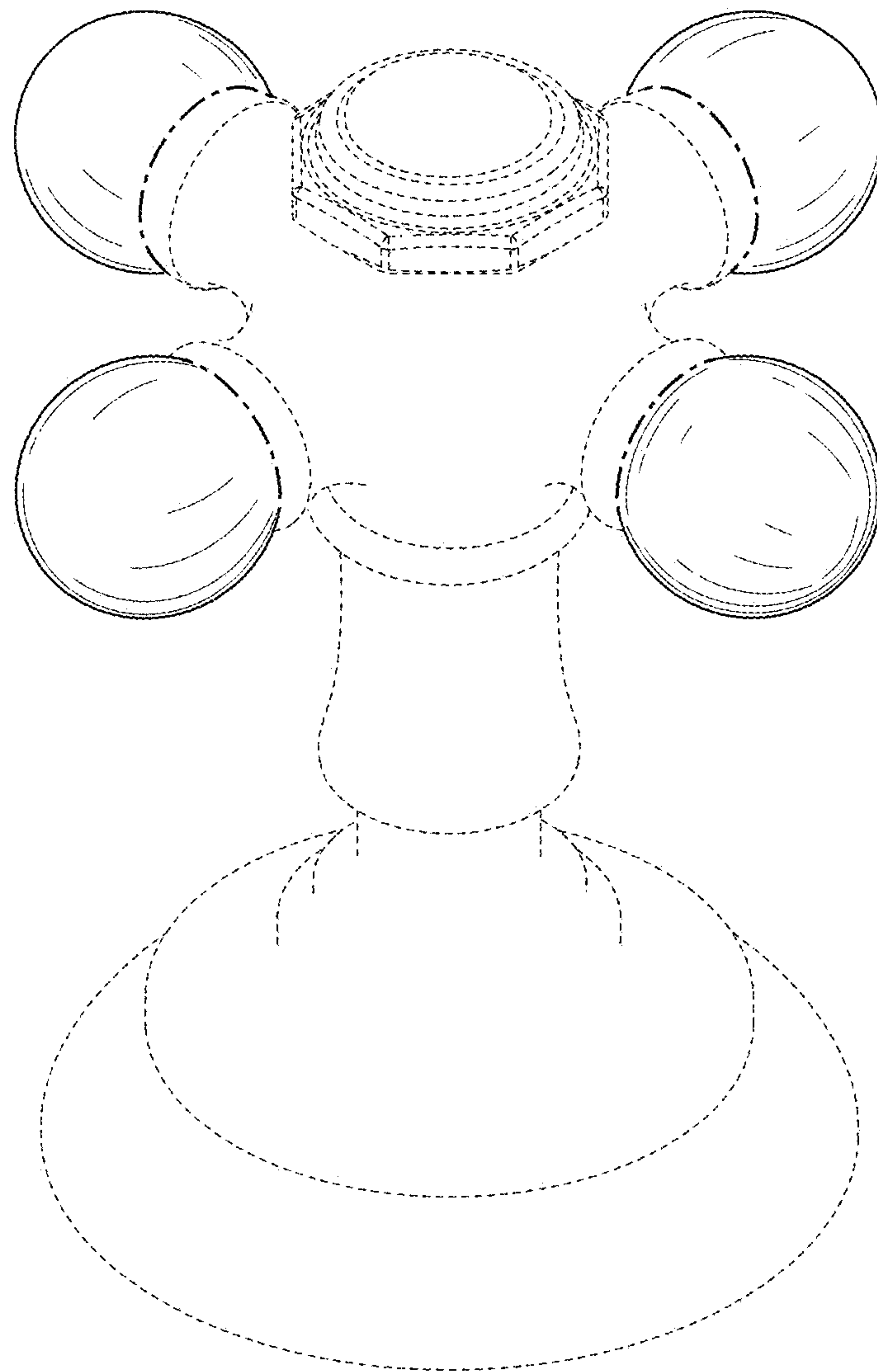

FIG. 1

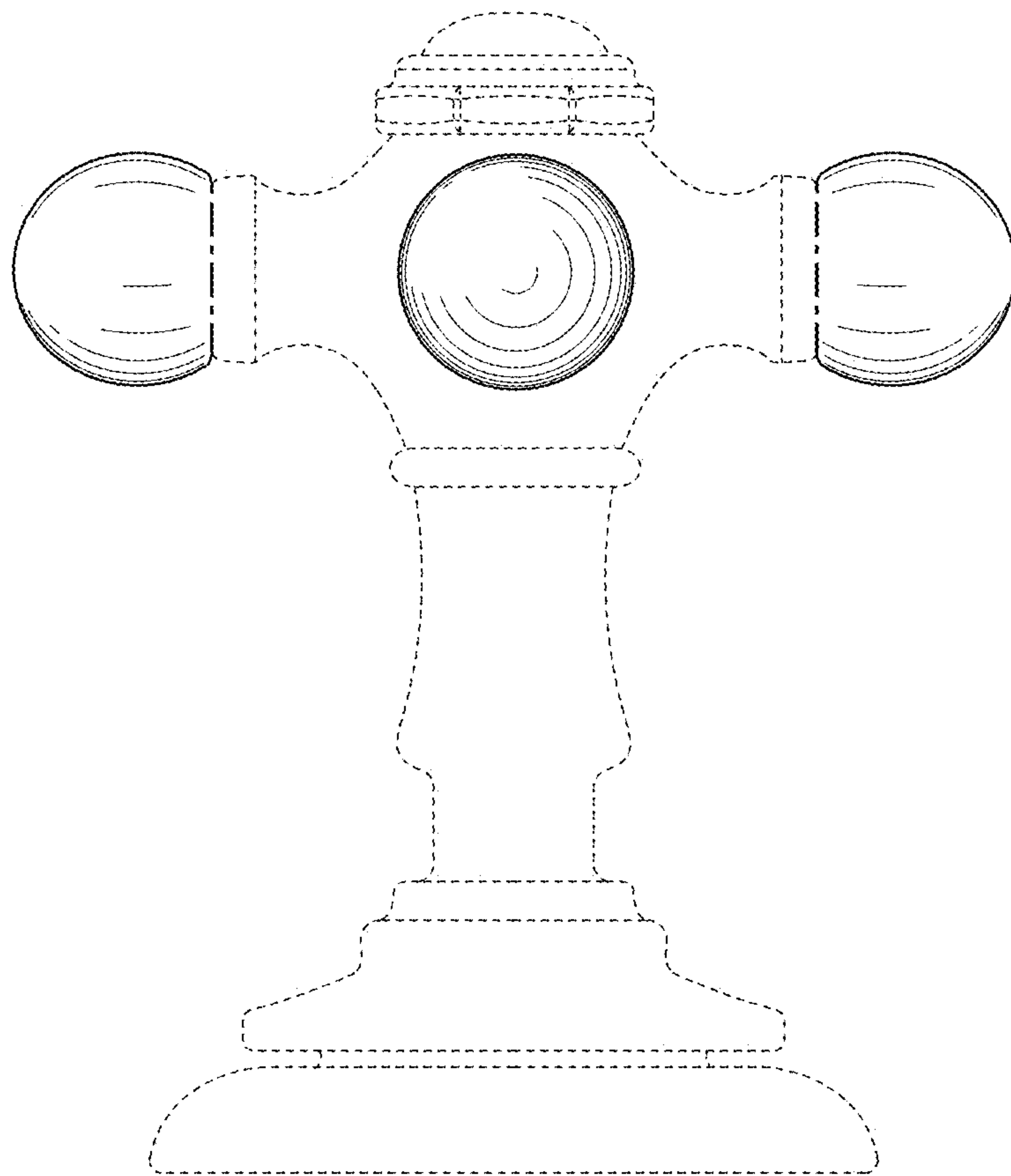

FIG. 2

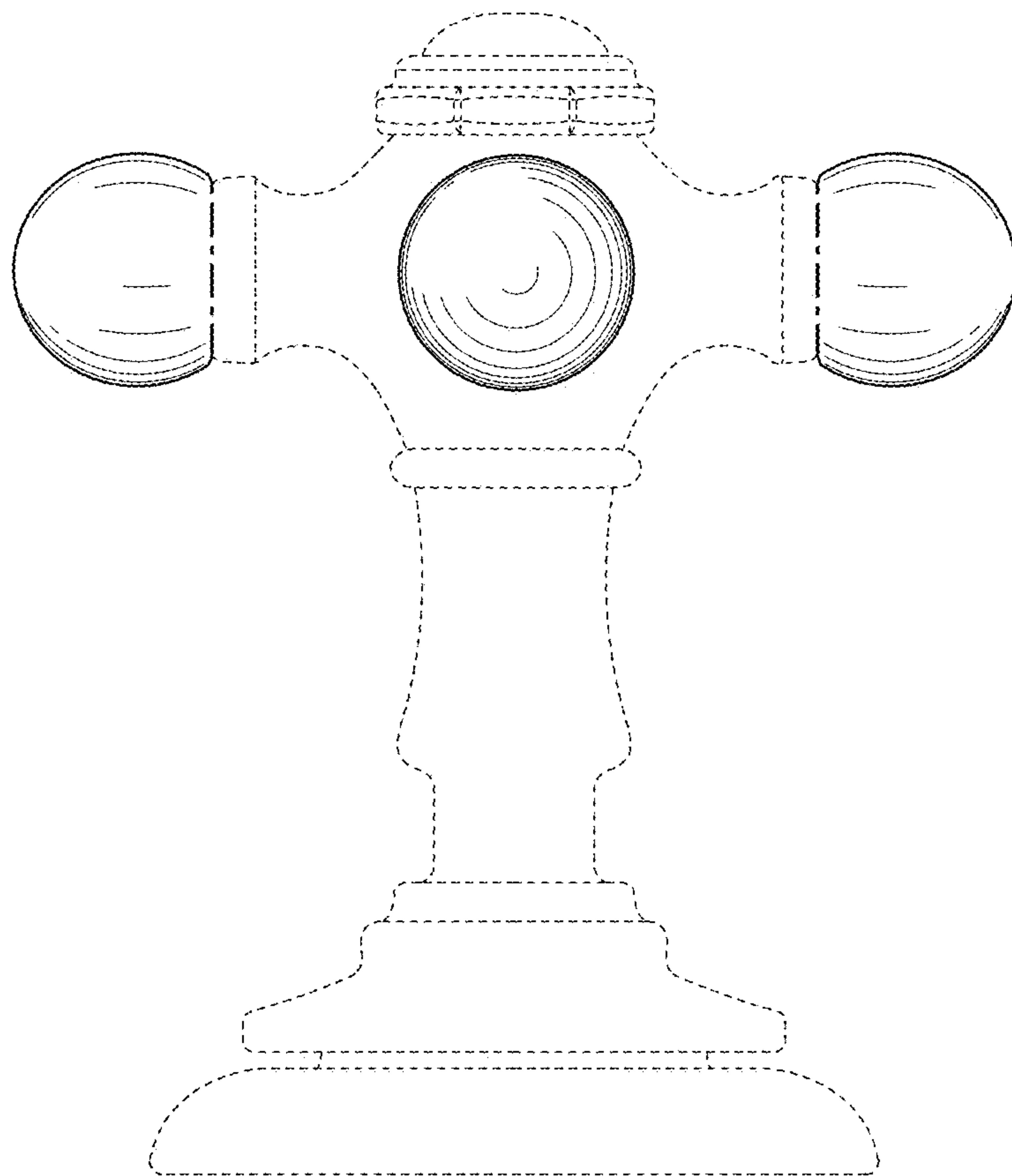

FIG. 3

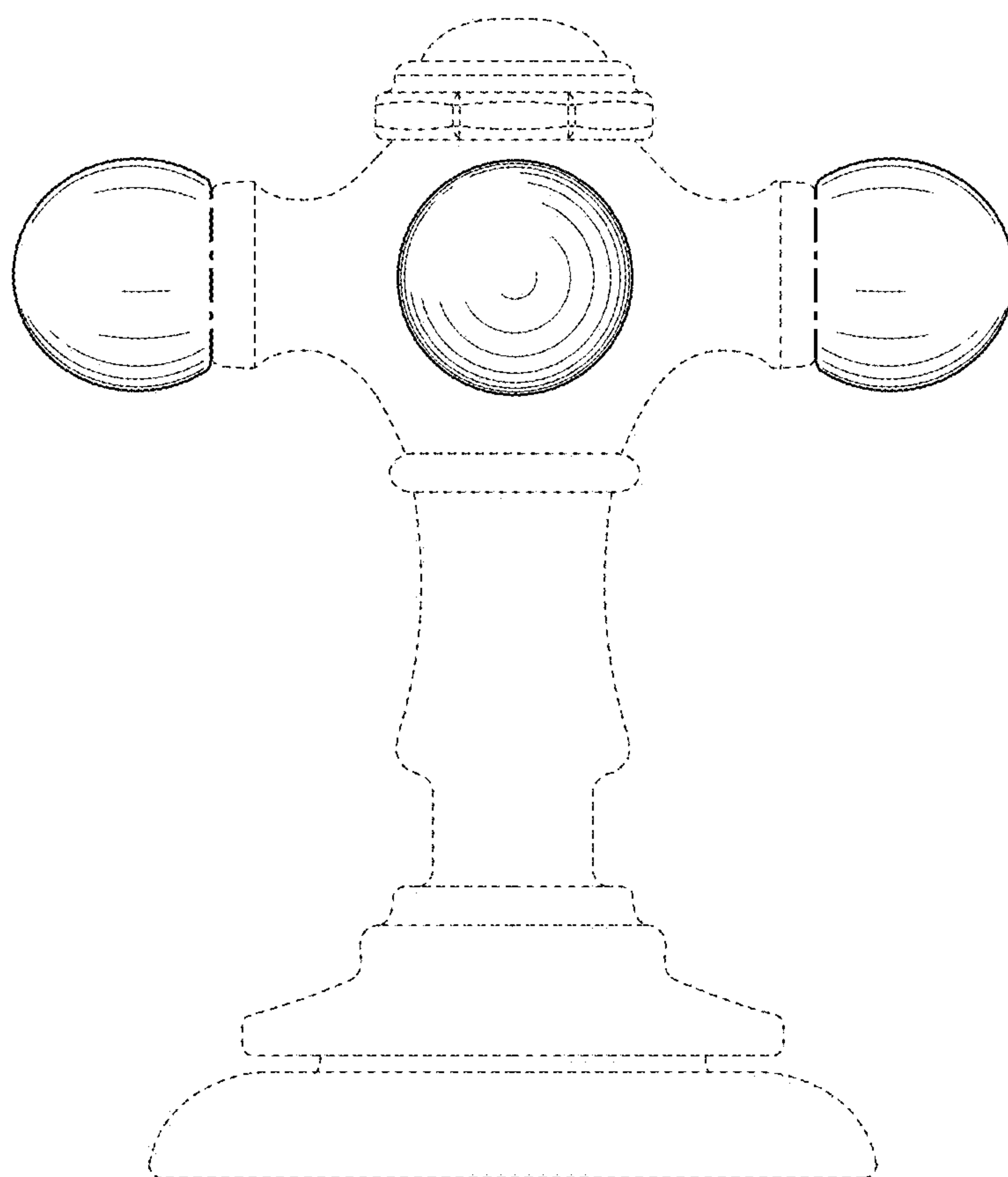

FIG. 4

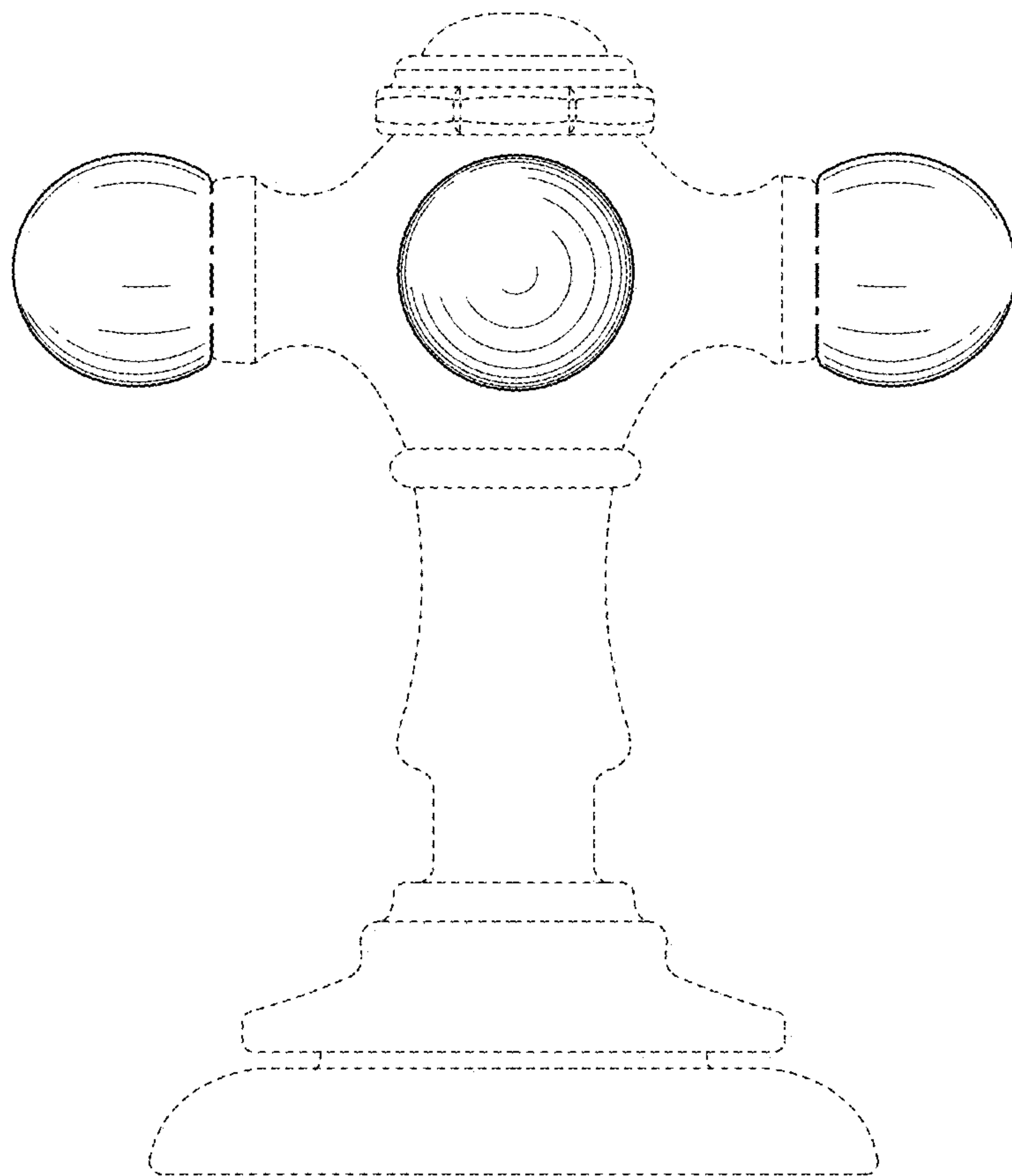

FIG. 5

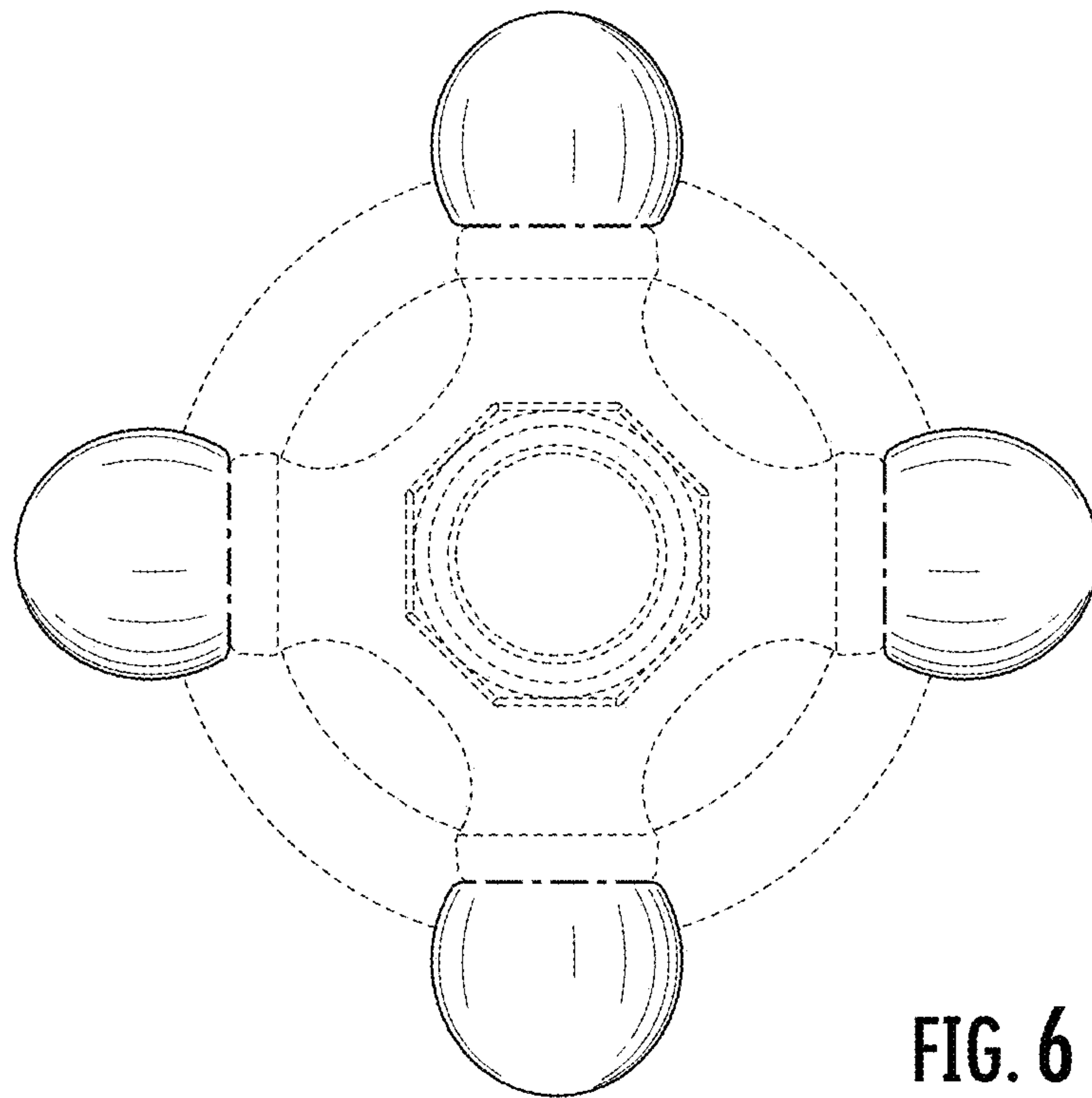

FIG. 6

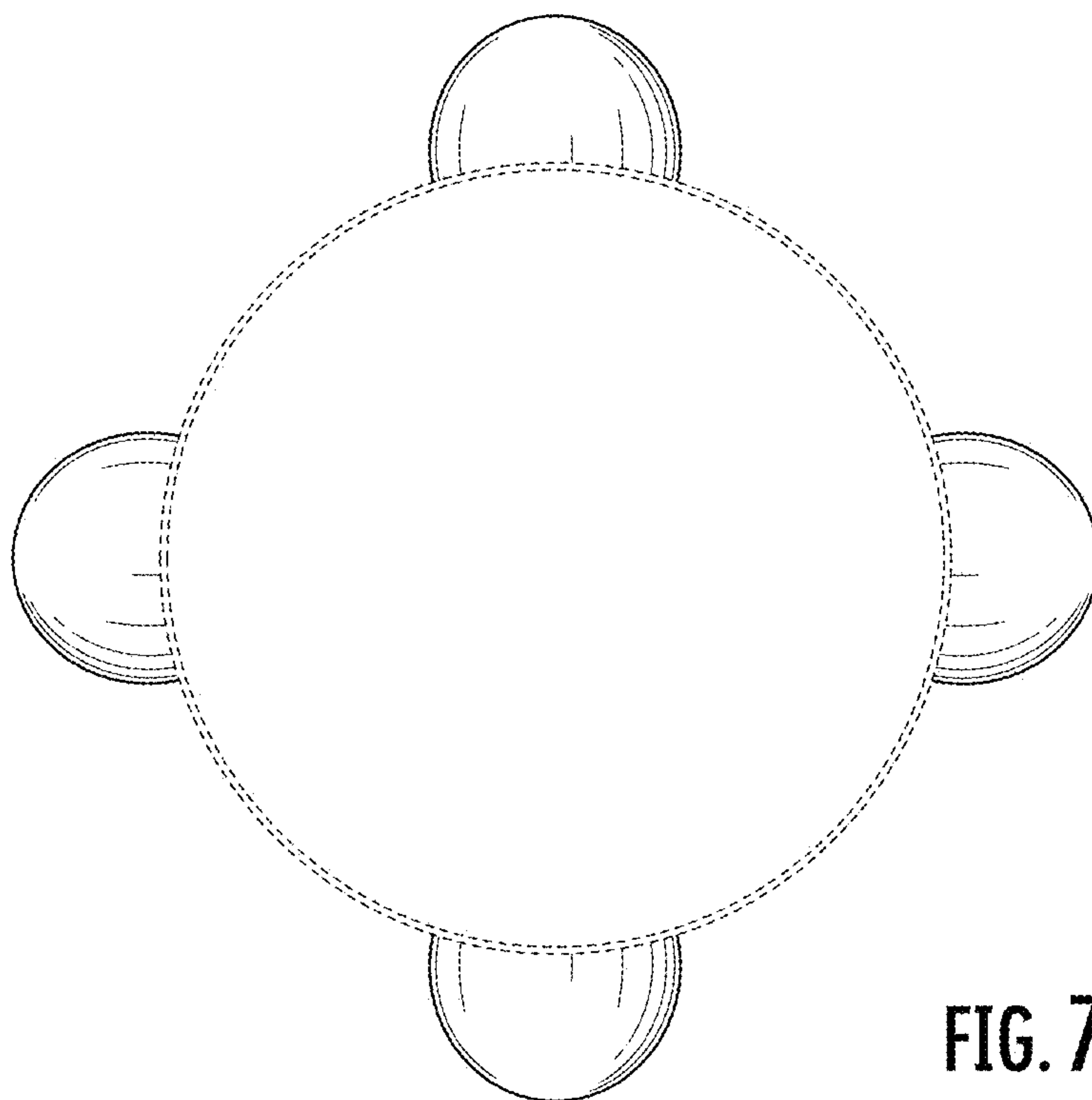

FIG. 7