



US00D989222S

(12) **United States Design Patent**
Rubel et al.

(10) **Patent No.:** **US D989,222 S**
(45) **Date of Patent:** **** Jun. 13, 2023**

- (54) **INSECT ELIMINATING DEVICE**
- (71) Applicant: **PIC Corporation**, Linden, NJ (US)
- (72) Inventors: **Eric Rubel**, Westfield, NJ (US); **Lisa M. French**, Belford, NJ (US); **David L. Lowe**, Port Monmouth, NJ (US); **Lawrence E. Bradford**, Westfield, NJ (US)
- (73) Assignee: **PIC Corporation**, Linden, NJ (US)
- (**) Term: **15 Years**
- (21) Appl. No.: **29/778,666**
- (22) Filed: **Apr. 14, 2021**
- (51) **LOC (14) Cl.** **22-06**
- (52) **U.S. Cl.**
USPC **D22/123**
- (58) **Field of Classification Search**
USPC D22/119–123; D23/364, 366, 367–368
CPC A01M 1/023; A01M 1/14; A01M 1/104;
A01M 1/106; A01M 1/145; A01M 1/2016; A01M 29/34; A01M 2200/01;
A01M 2200/011; A01M 2200/012
See application file for complete search history.

D421,477 S * 3/2000 Kalal D22/122
D958,312 S * 7/2022 Xu D23/356
D963,233 S * 9/2022 Li D26/41
D966,482 S * 10/2022 Shan D23/364

* cited by examiner

Primary Examiner — Catherine R Oliver-Garcia
(74) *Attorney, Agent, or Firm* — Amster, Rothstein & Ebenstein LLP

(56) **References Cited**

U.S. PATENT DOCUMENTS

550,345 A * 11/1895 Humphereys et al. 43/113
5,020,270 A * 6/1991 Lo A01M 1/08
43/112

(57) **CLAIM**

The ornamental design for an insect eliminating device, as shown and described.

DESCRIPTION

FIG. 1 is a front view of an insect eliminating device showing our new design;
FIG. 2 is a rear view thereof;
FIG. 3 is a rear perspective view thereof;
FIG. 4 is a front perspective view thereof;
FIG. 5 is a top view thereof;
FIG. 6 is a bottom view thereof;
FIG. 7 is a side view thereof; and,
FIG. 8 is an opposite side view thereof.
The broken lines showing of portions of the insect eliminating device is included for the purpose of illustrating environmental structure and forms no part of the claimed design.

1 Claim, 16 Drawing Sheets

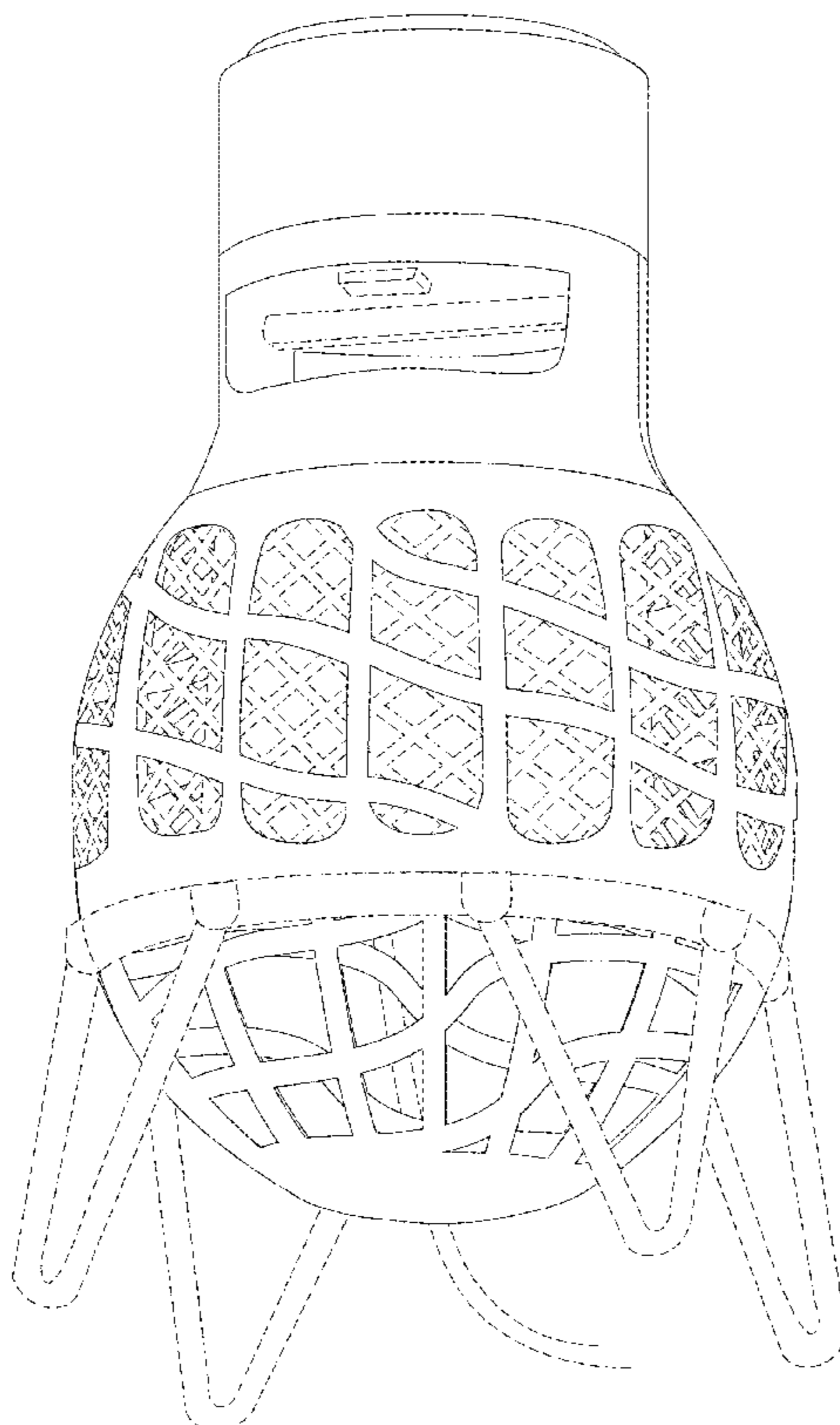

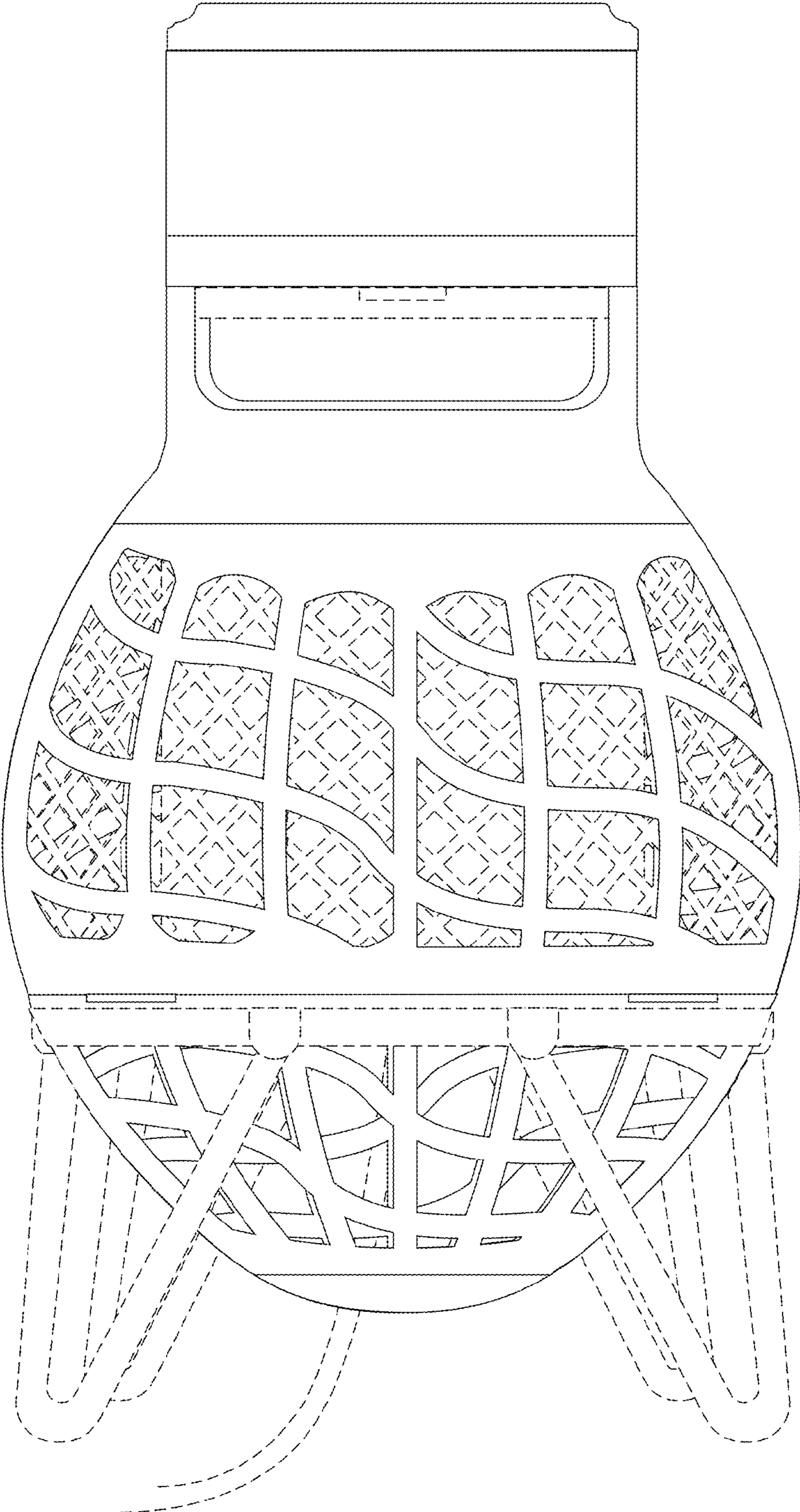

FIG. 1

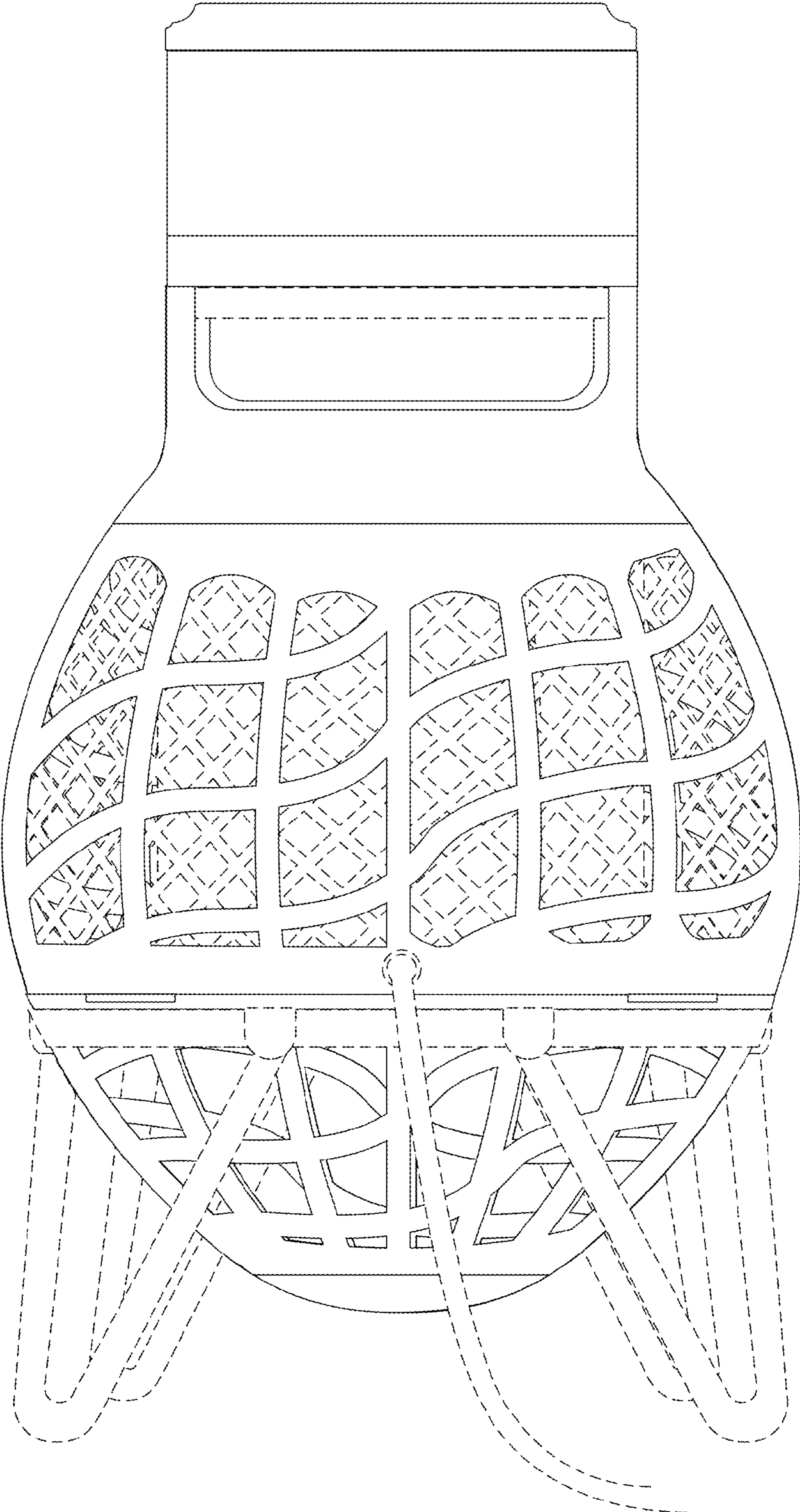

FIG. 2

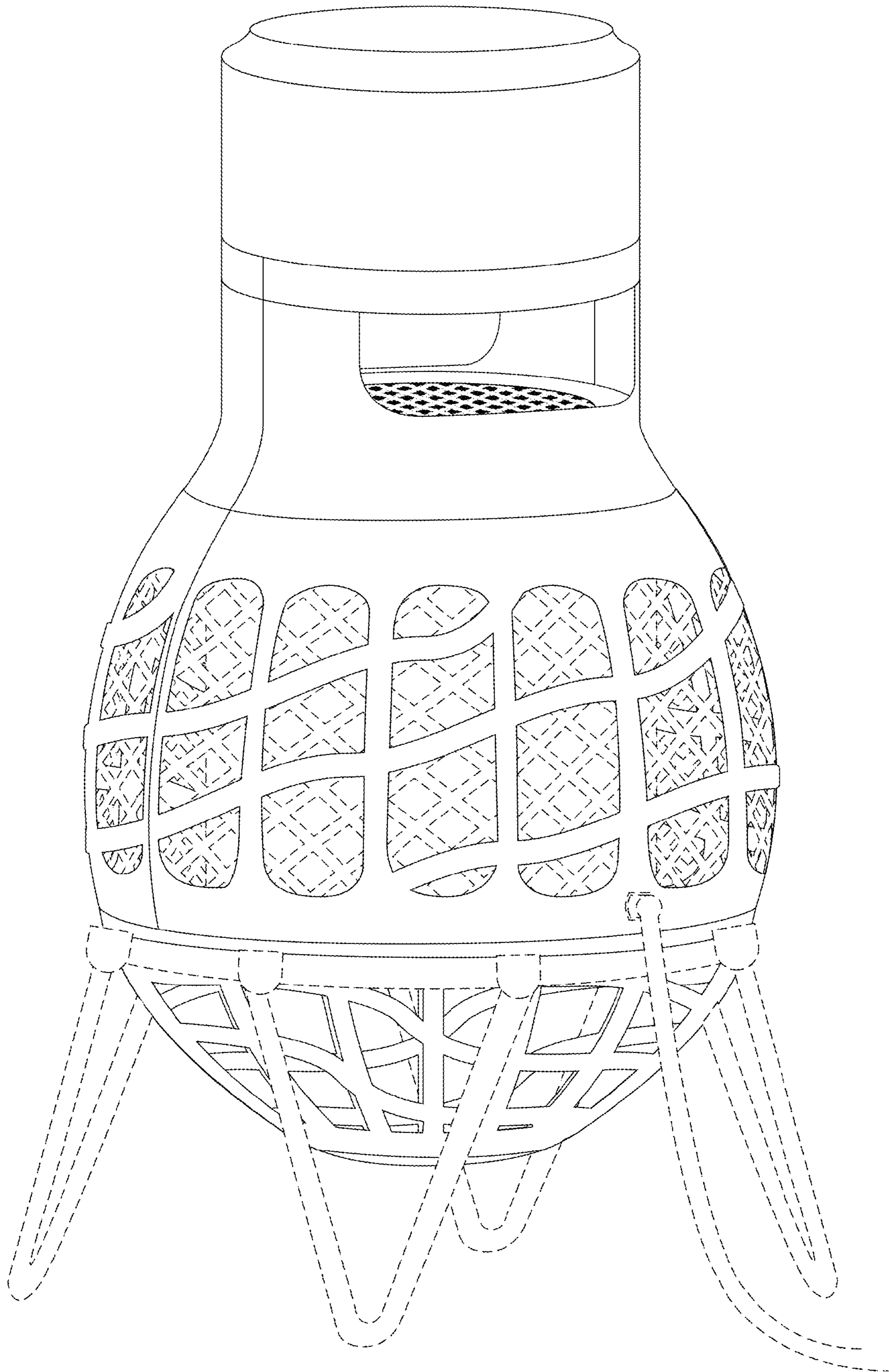

FIG. 3

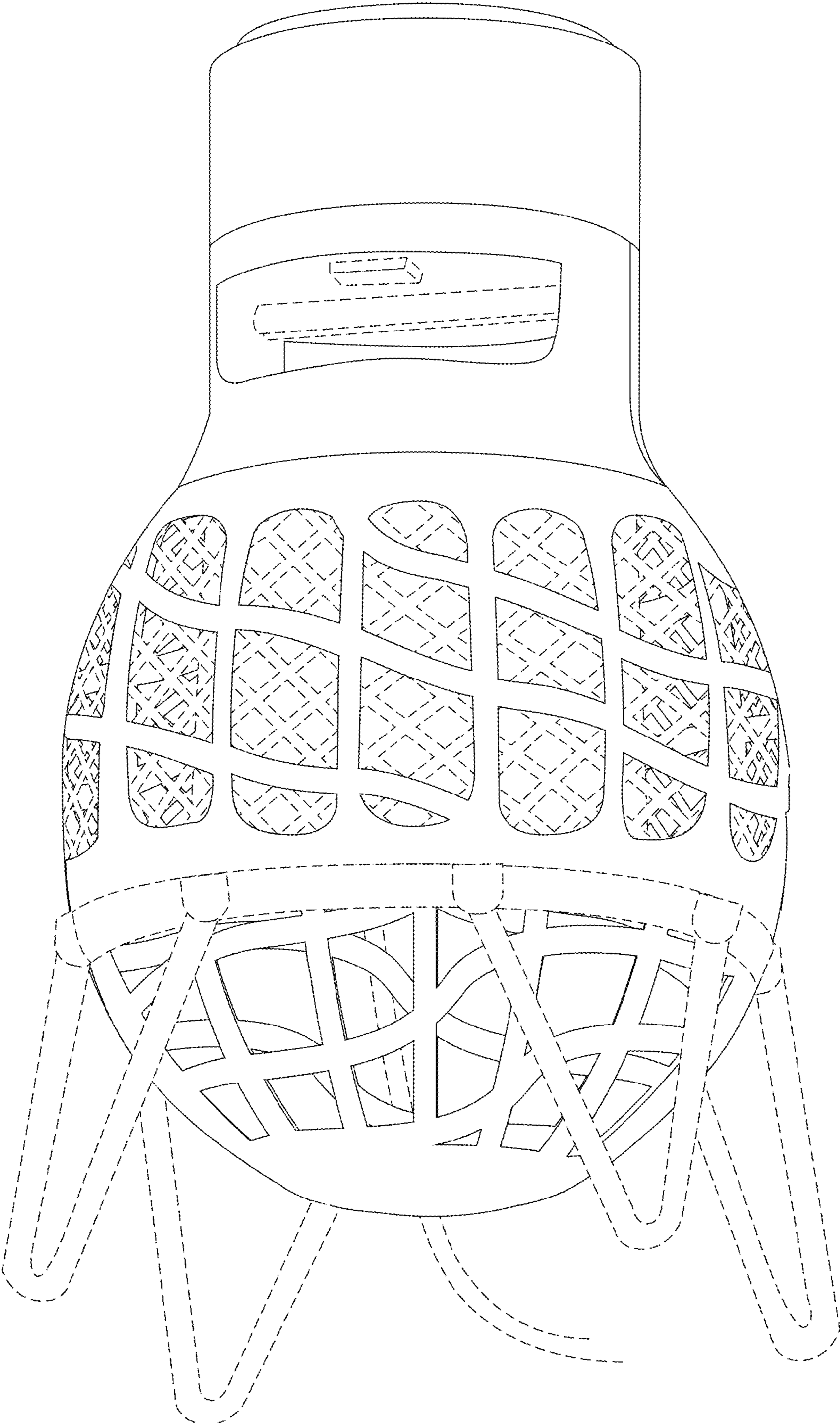

FIG. 4

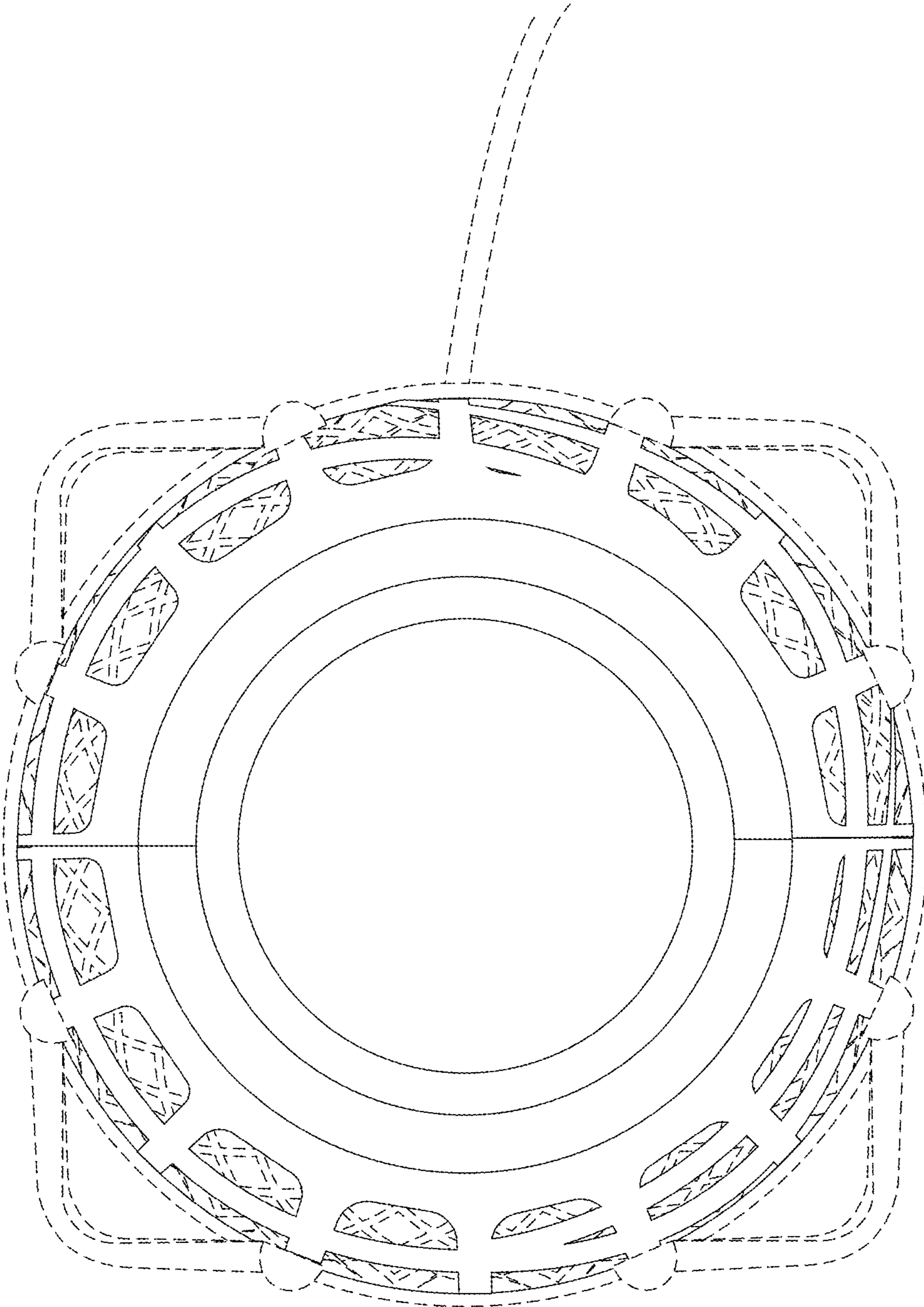

FIG. 5

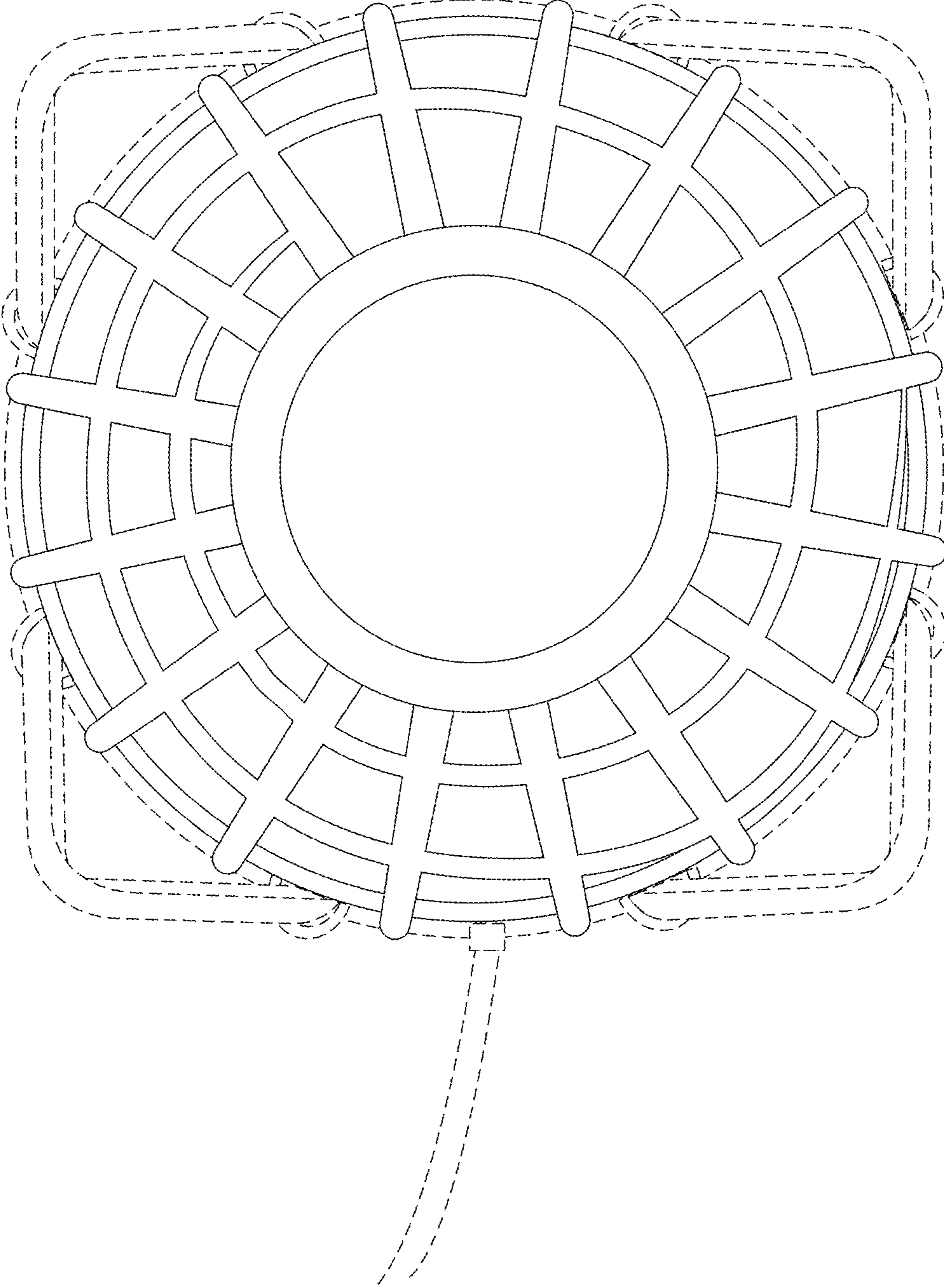

FIG. 6

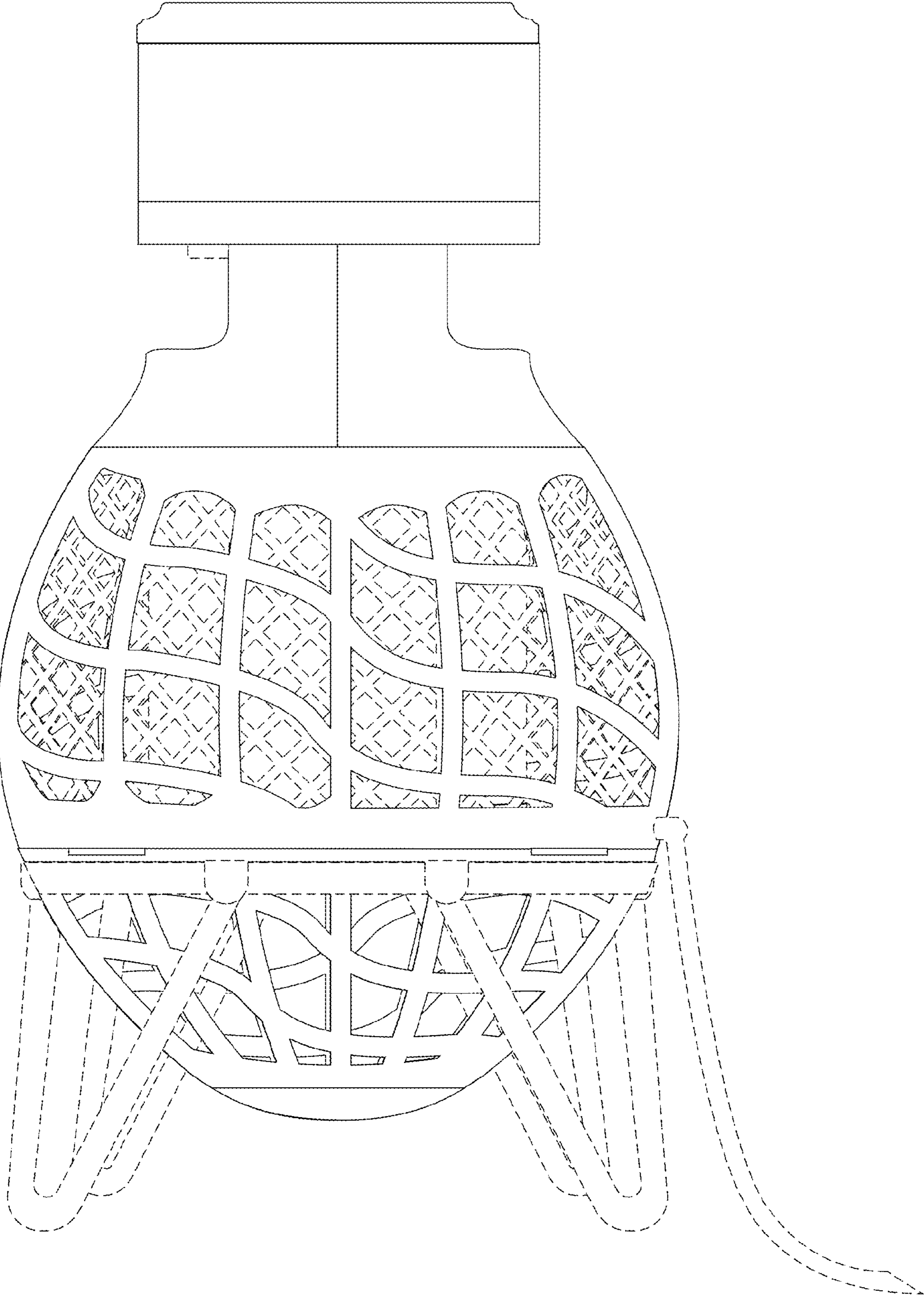

FIG. 7

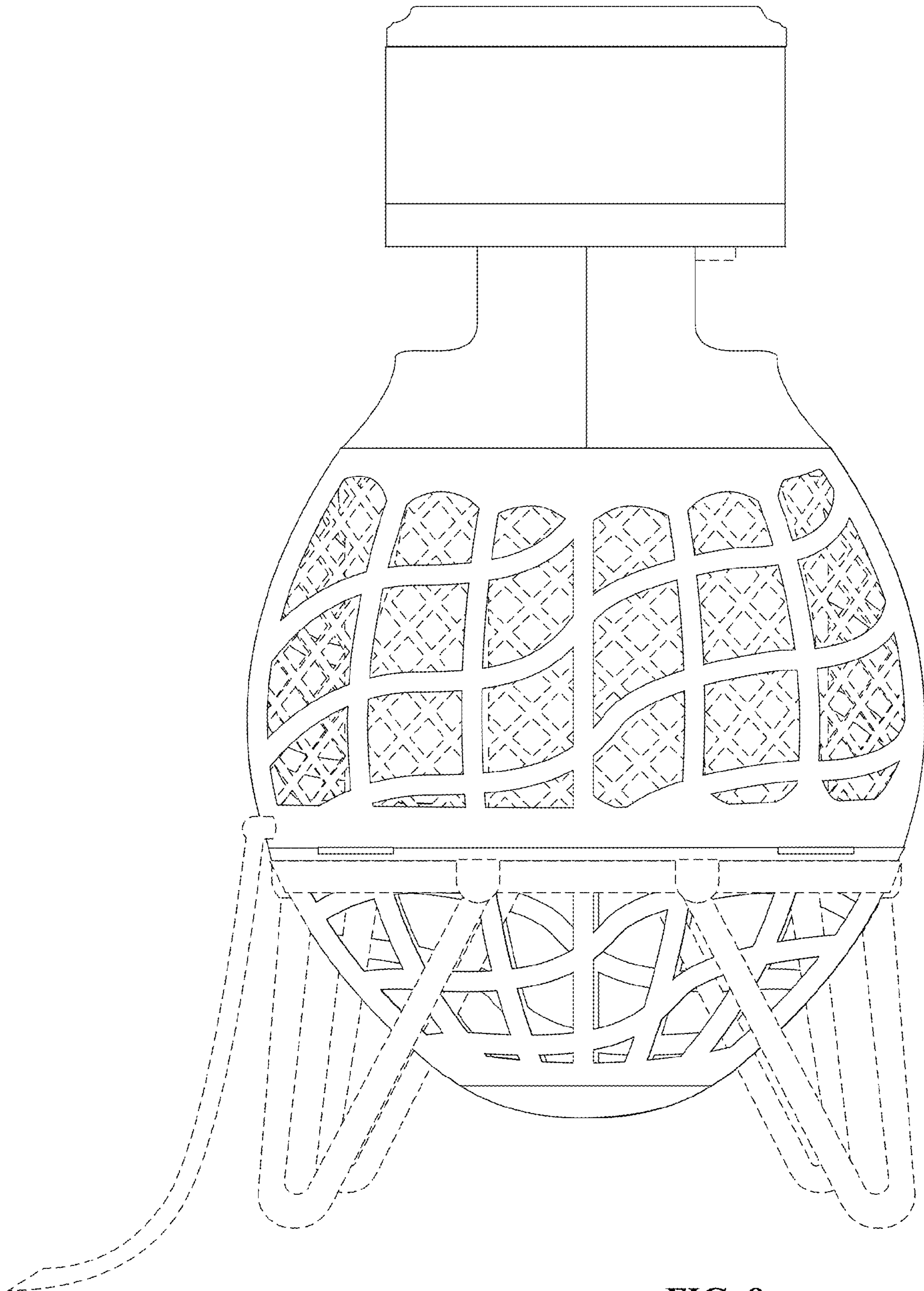

FIG. 8

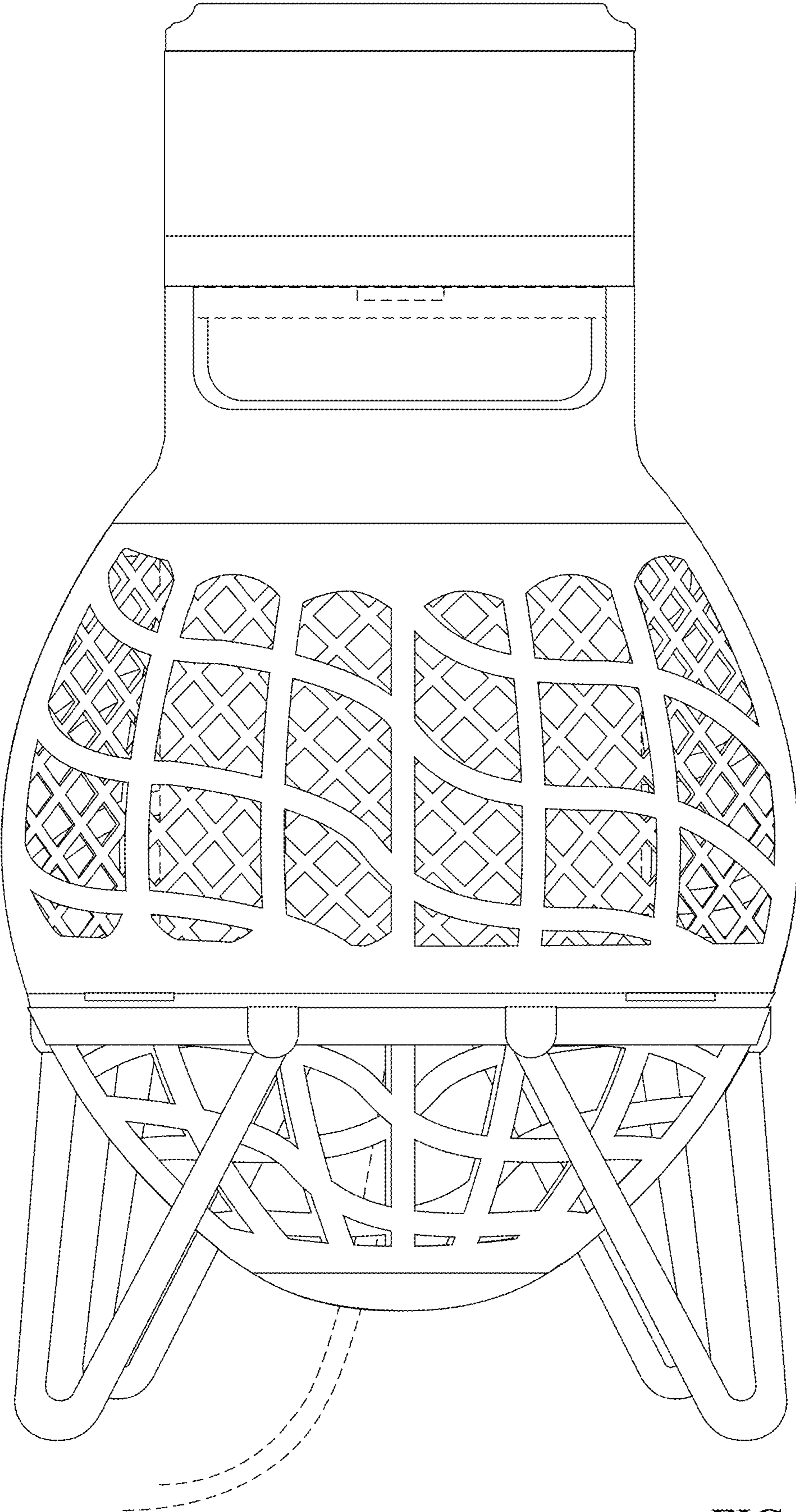

FIG. 9

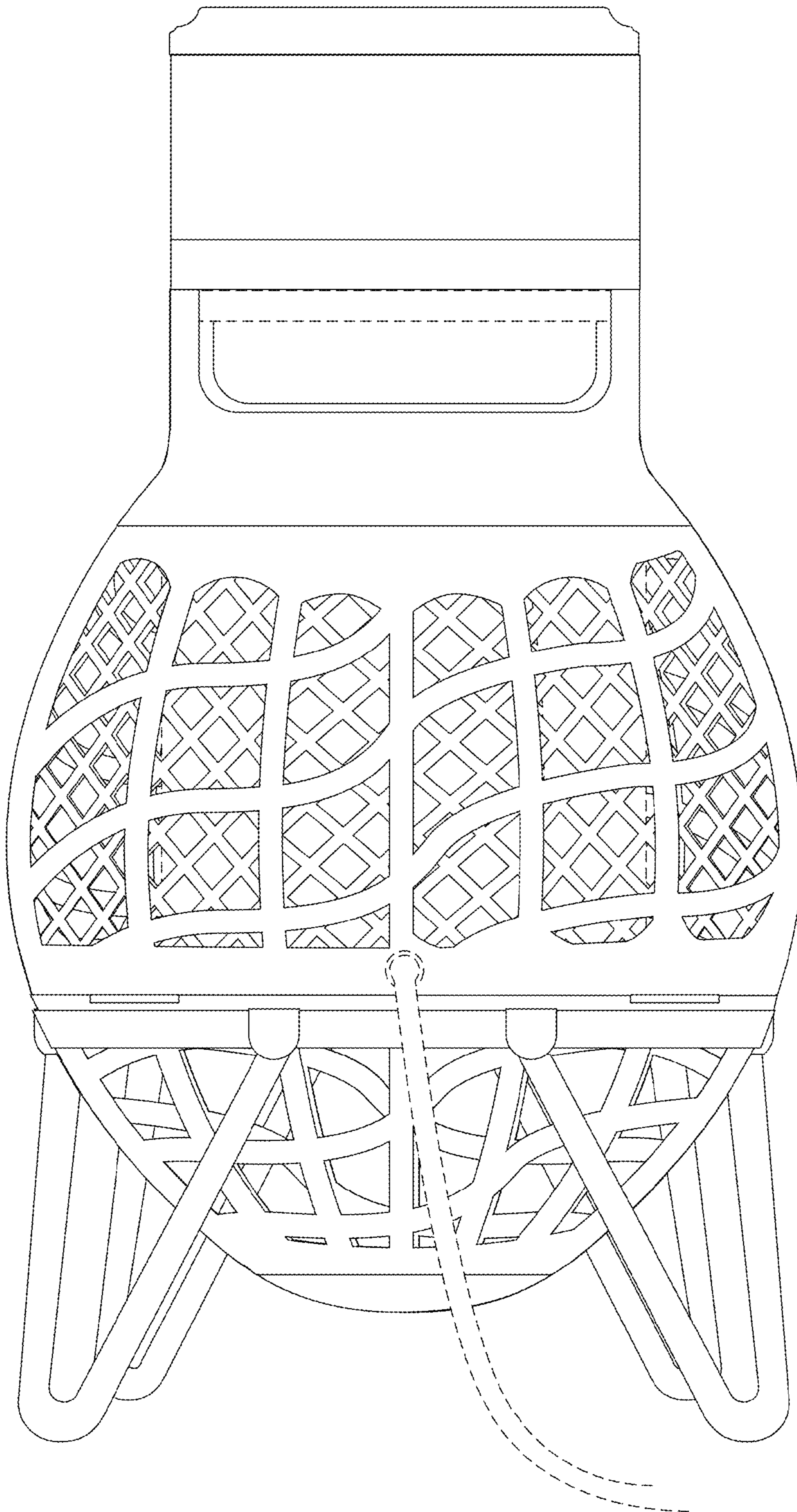

FIG. 10

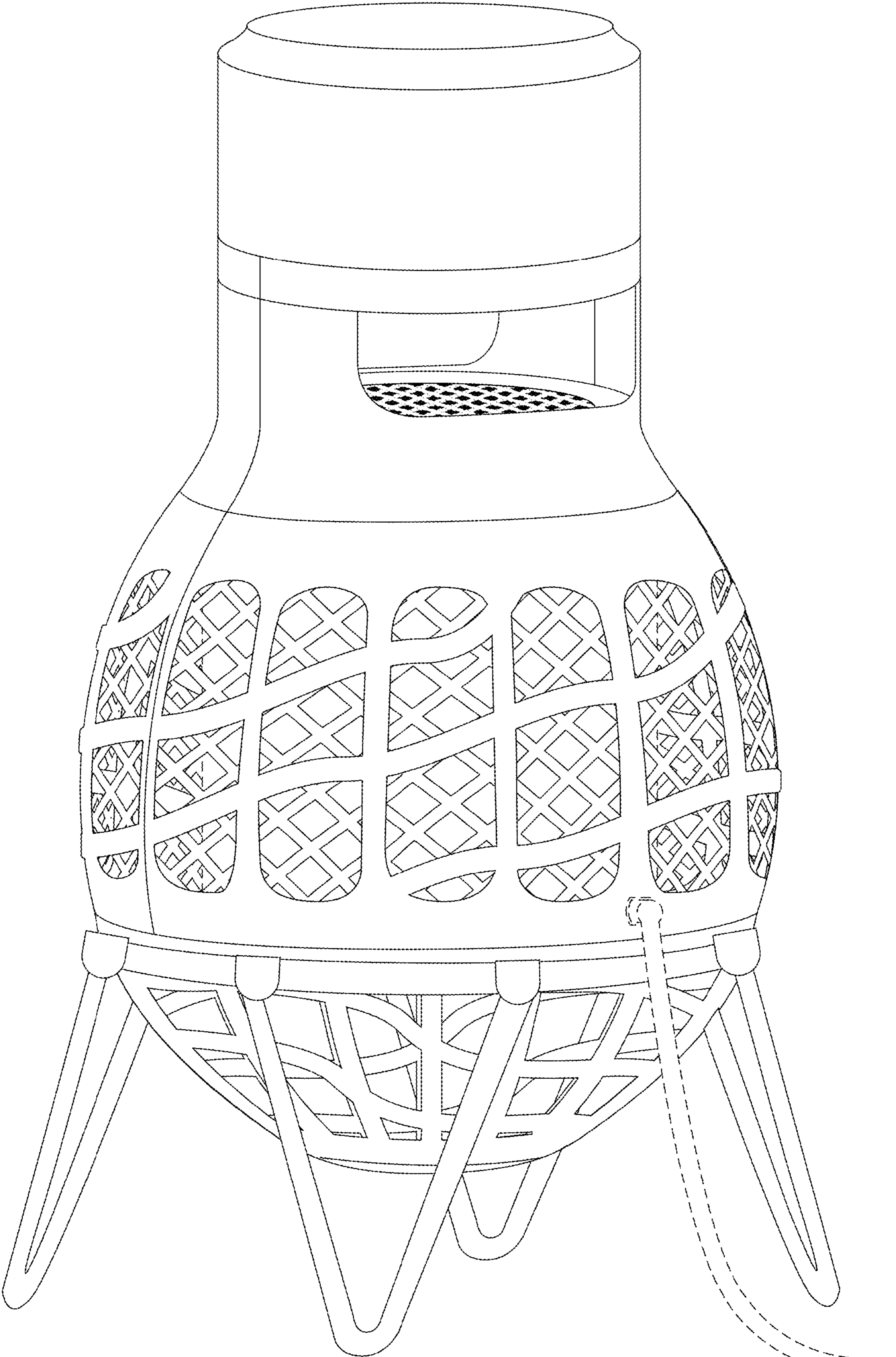

FIG. 11

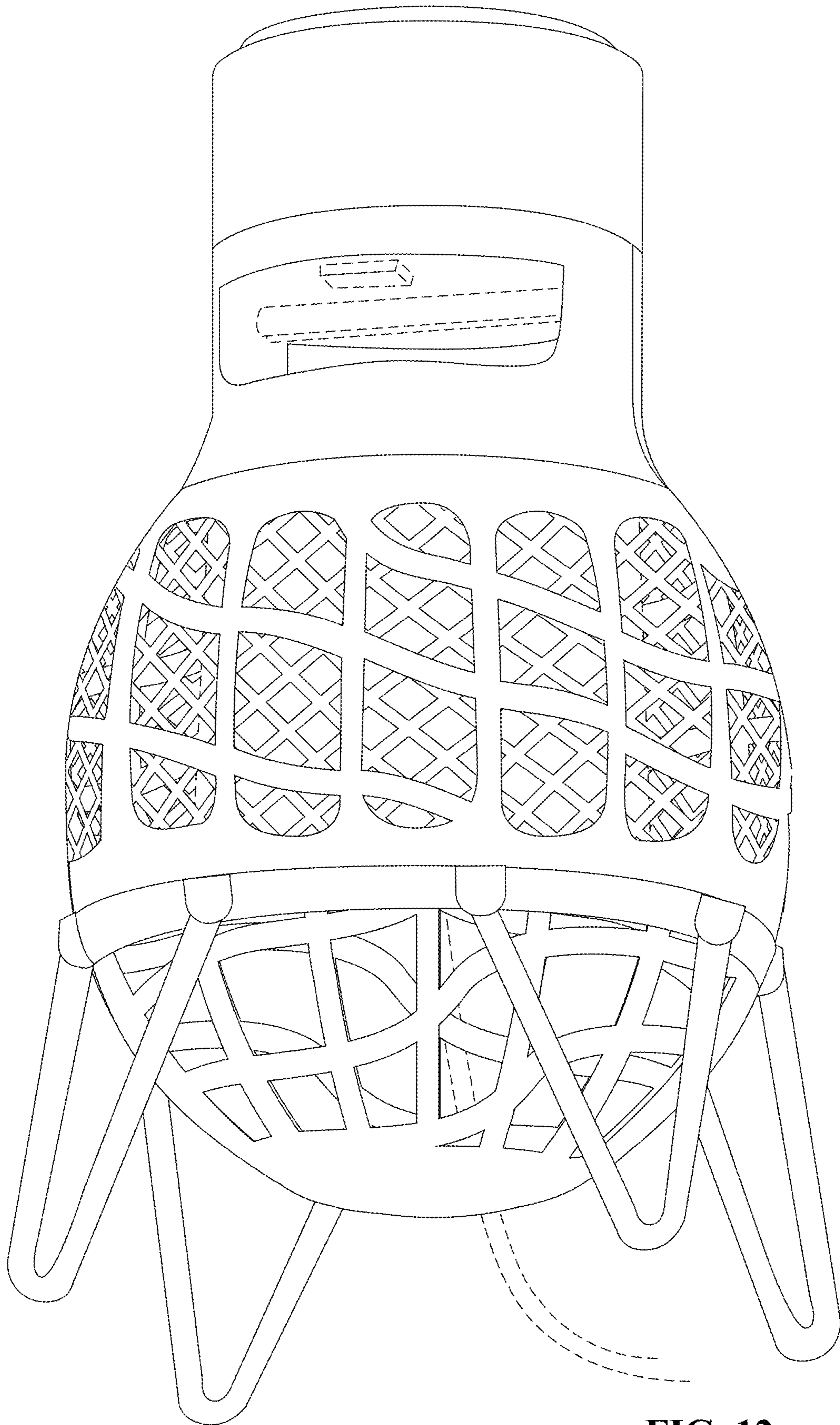

FIG. 12

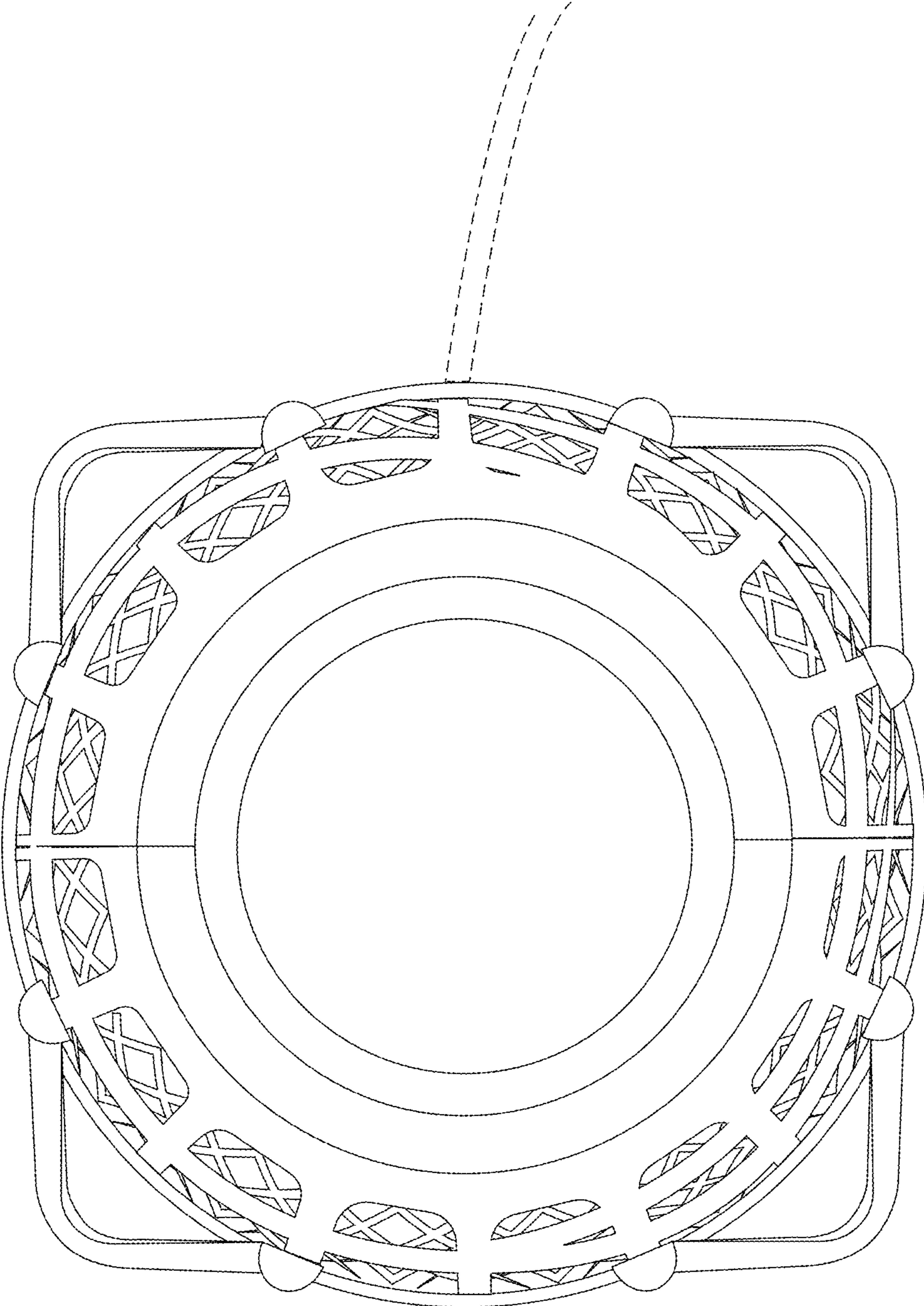

FIG. 13

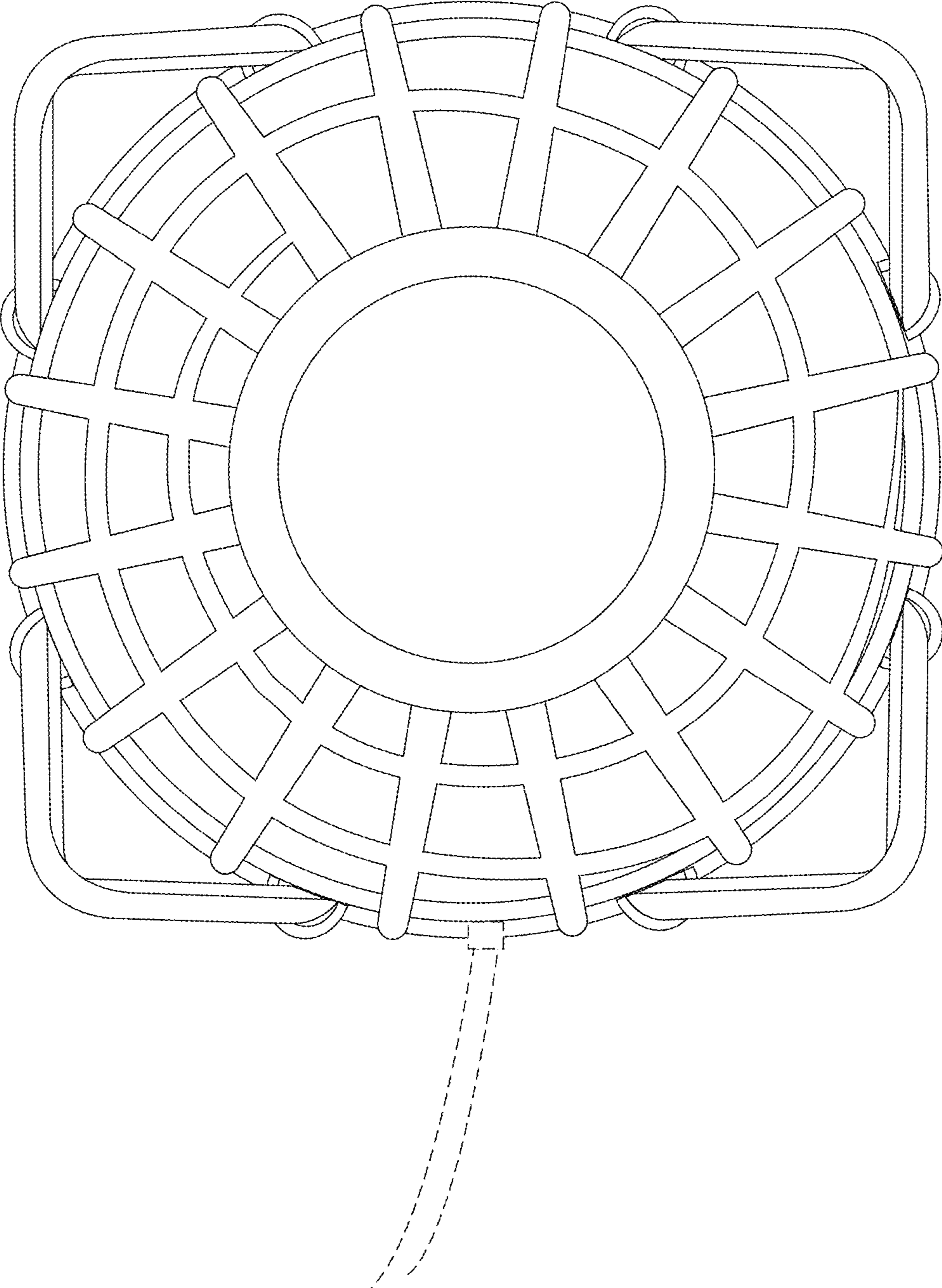

FIG. 14

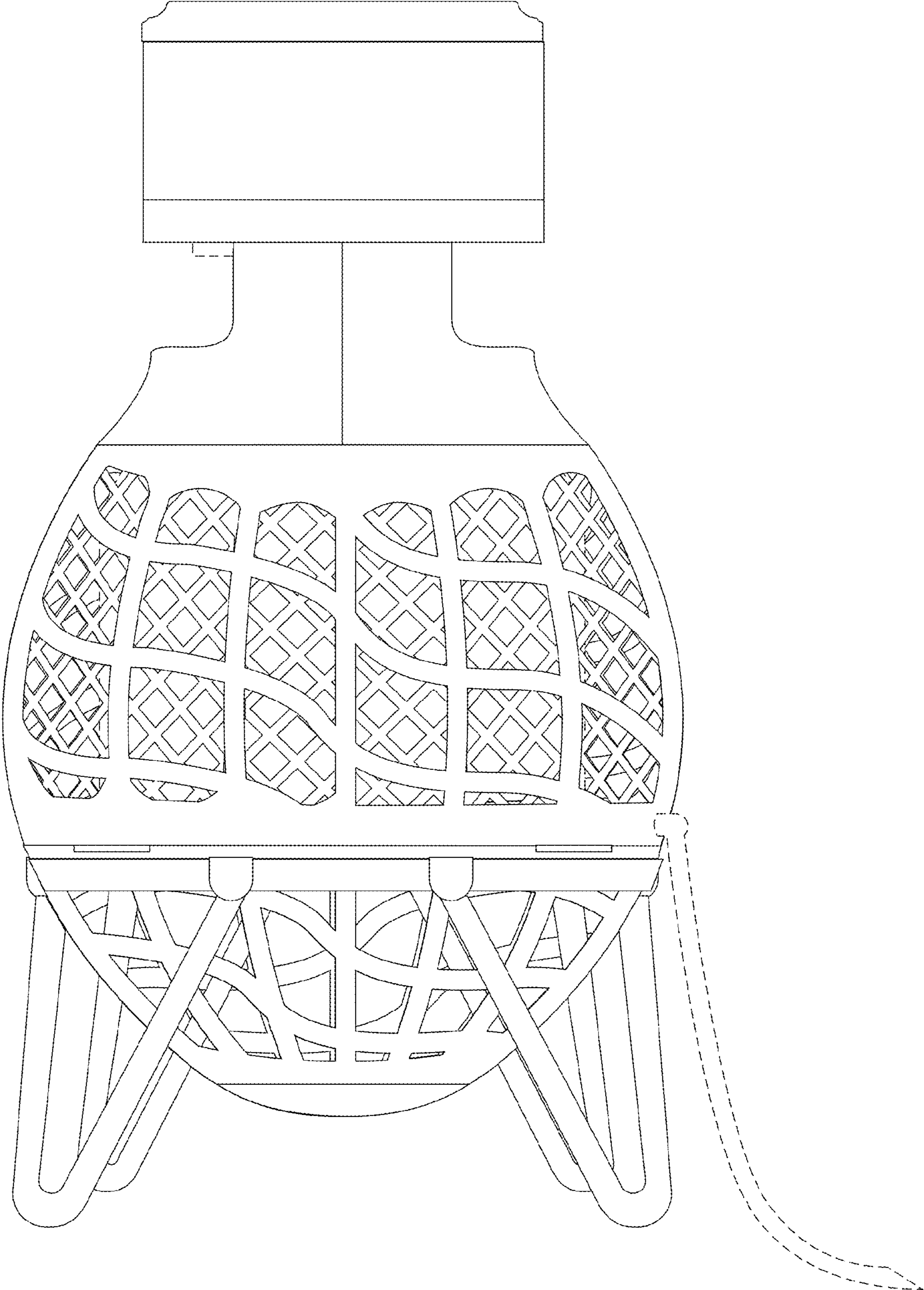

FIG. 15

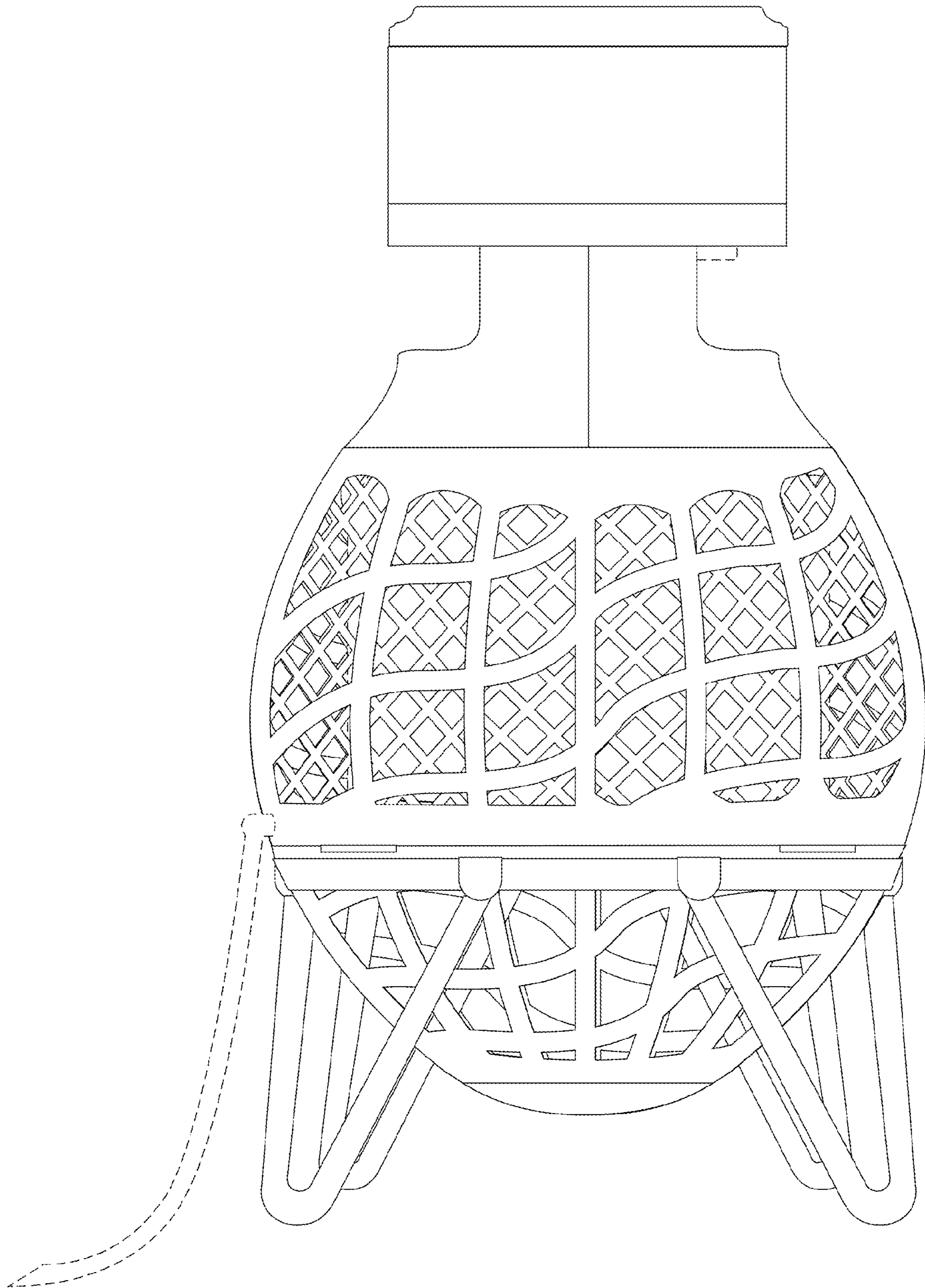

FIG. 16