



US00D989169S

(12) **United States Design Patent** (10) **Patent No.:** **US D989,169 S**
Motoyama et al. (45) **Date of Patent:** **** Jun. 13, 2023**

(54) PRINTER	D653,703 S * 2/2012 Seki D18/55
	D653,704 S * 2/2012 Seki D18/55
(71) Applicant: BROTHER INDUSTRIES, LTD., Nagoya (JP)	D722,339 S * 2/2015 Nakagawa D18/55
	D723,616 S * 3/2015 Nakagawa D18/55
	D786,343 S * 5/2017 Kil D18/55
	D786,348 S * 5/2017 Mita D18/56
(72) Inventors: Takahiro Motoyama, Nagoya (JP); Nobuyuki Iwai, Chita-gun (JP)	D806,162 S * 12/2017 Tashima D18/50
	D810,194 S * 2/2018 Kim D18/50
	D824,455 S * 7/2018 Inada D18/50
	D826,319 S * 8/2018 Inada D18/50
(73) Assignee: BROTHER INDUSTRIES, LTD., Nagoya (JP)	D838,771 S * 1/2019 Kim D18/50
	D944,892 S * 3/2022 Inada D18/53
(**) Term: 15 Years	2004/0131378 A1 * 7/2004 Hattori G03G 15/80 399/107
(21) Appl. No.: 29/775,414	2007/0014620 A1 * 1/2007 Sugimoto B41J 29/02 400/691

(22) Filed: **Mar. 23, 2021**

FOREIGN PATENT DOCUMENTS

(30) **Foreign Application Priority Data**

Oct. 6, 2020 (JP) 2020-021391 D

(51) **LOC (14) Cl.** **14-02**

(52) **U.S. Cl.**
USPC **D18/53**

(58) **Field of Classification Search**
USPC D18/40, 43, 46, 47, 48, 50, 53, 54, 55,
D18/56; D15/122, 135, 138; D14/307,
D14/314, 432
CPC . G06T 2207/30196; G06T 2207/30242; G06T
7/70; G06F 3/126; G06F 3/1284
See application file for complete search history.

JP 1653330 S 12/2020

* cited by examiner

Primary Examiner — Nicole C Shiflet
Assistant Examiner — Danielle Nichole Bowly
(74) *Attorney, Agent, or Firm* — Oliff PLC

(56) **References Cited**
U.S. PATENT DOCUMENTS

(57) **CLAIM**

The ornamental design for a printer, as shown and described.

D534,209 S * 12/2006 Yamaguchi D18/55
D534,579 S * 1/2007 Yamaguchi D18/55
D535,325 S * 1/2007 Yamaguchi D18/55
D578,494 S * 10/2008 Hattori D18/55
D617,829 S * 6/2010 Suzuki D18/55
D639,847 S * 6/2011 Nakata D18/50
D643,058 S * 8/2011 Seki D18/55

DESCRIPTION

FIG. 1 is a perspective view of the printer;
FIG. 2 is a front elevational view thereof;
FIG. 3 is a rear elevational view thereof;
FIG. 4 is a left-side elevational view thereof;
FIG. 5 is a right-side elevational view thereof;
FIG. 6 is a top plan view thereof; and,
FIG. 7 is a bottom plan view thereof.
The evenly spaced broken lines depict unclaimed parts of
the printer and form no part of the claimed design.

1 Claim, 7 Drawing Sheets

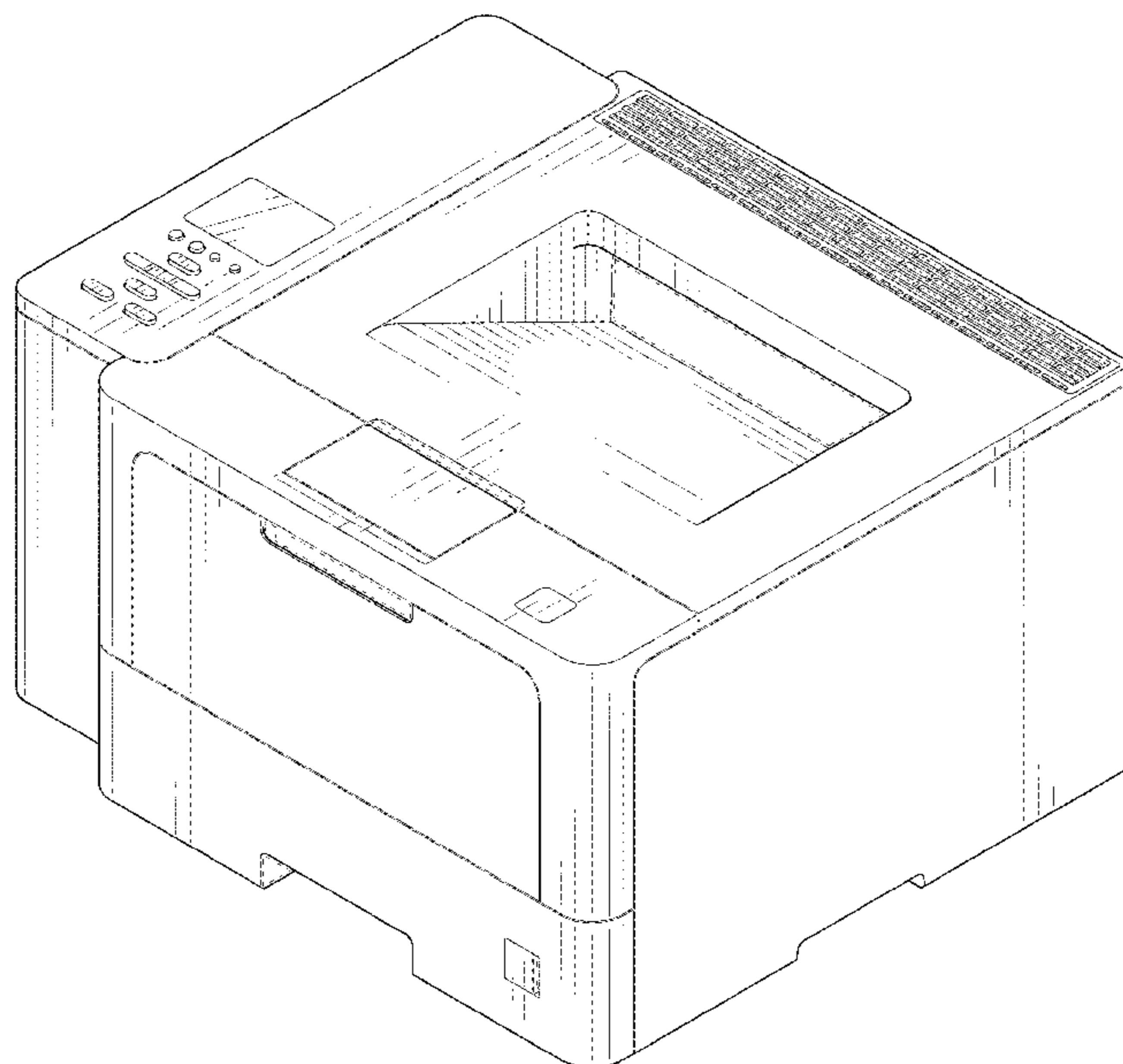

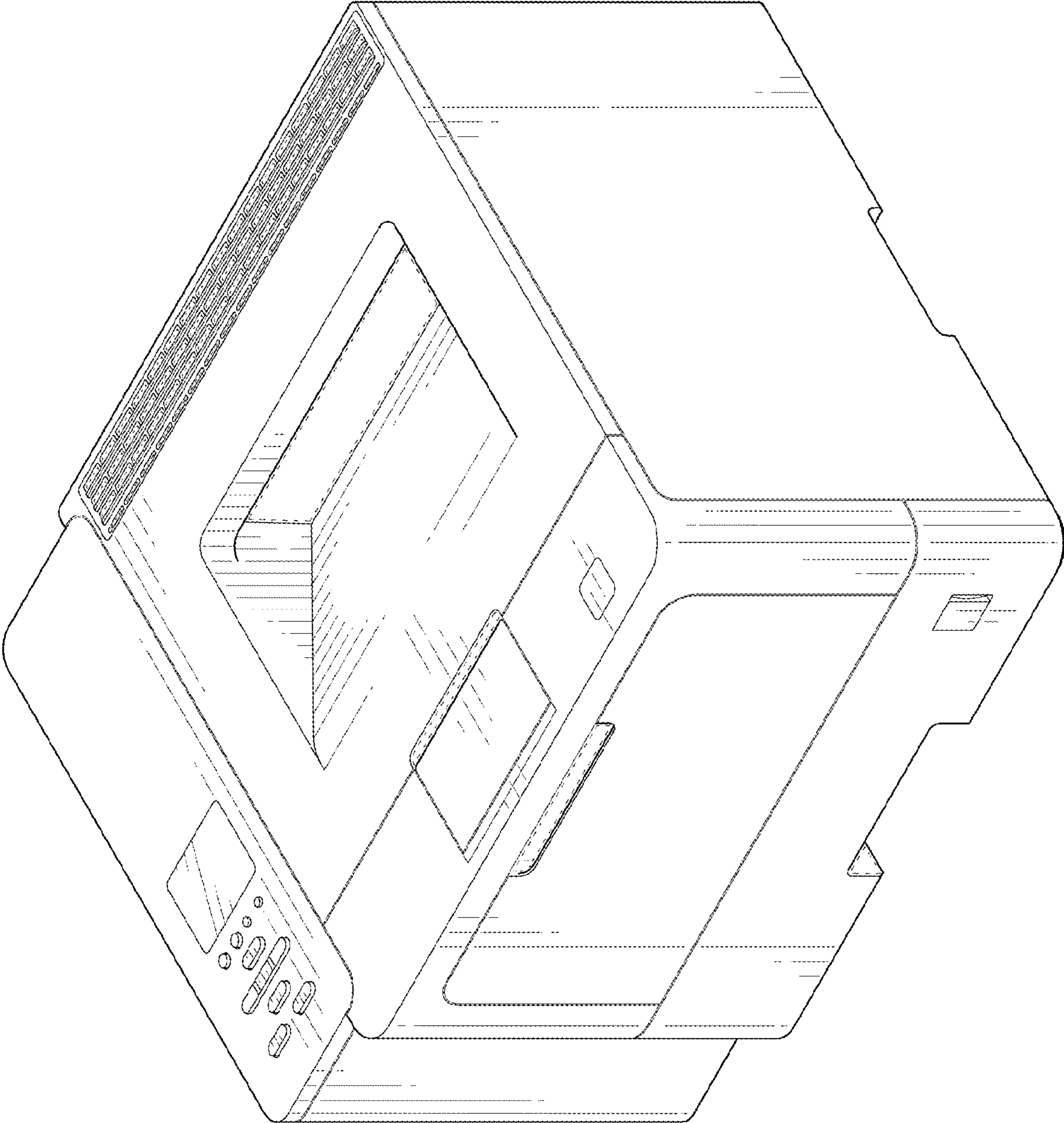

FIG. 1

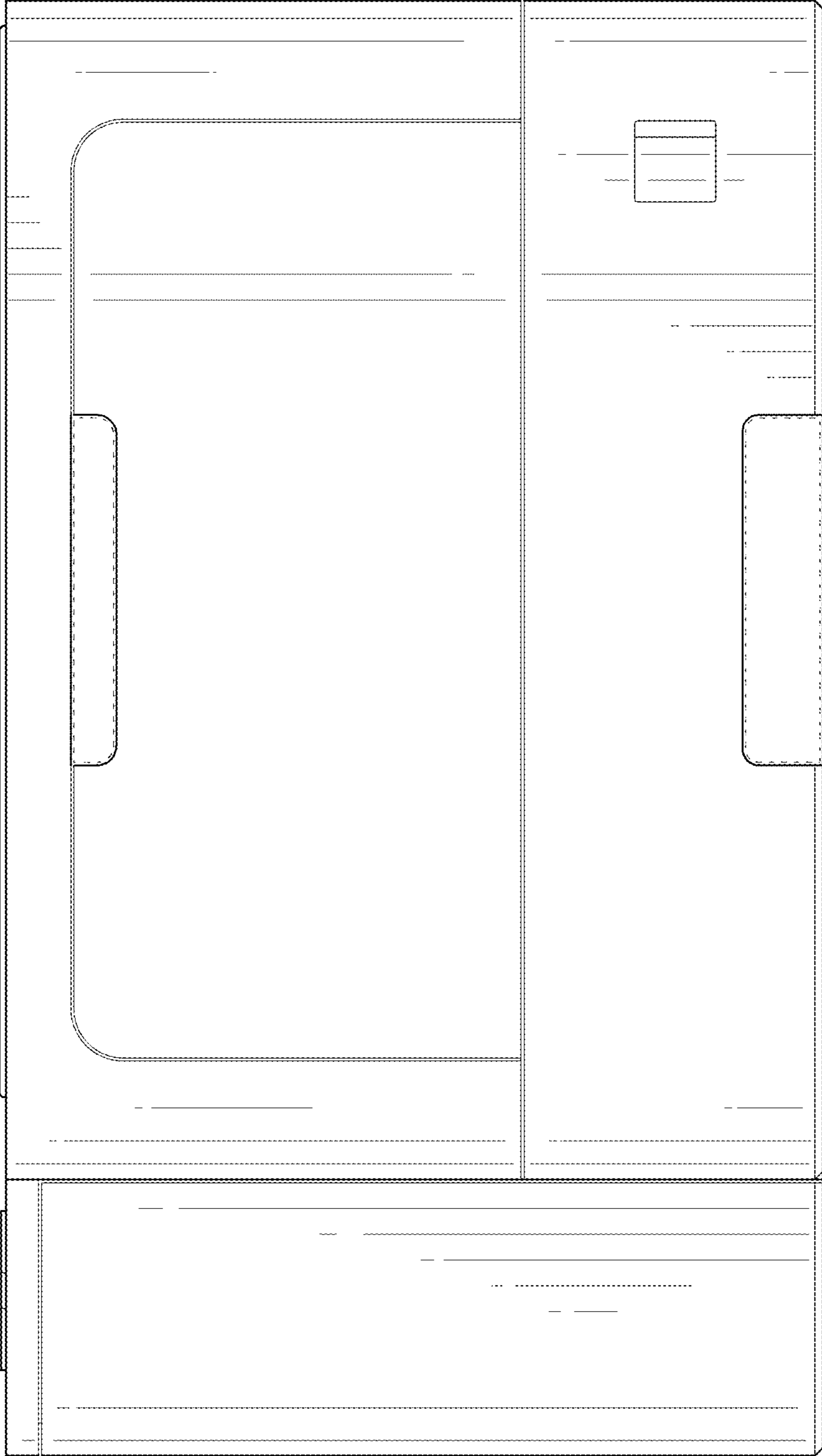

FIG. 2

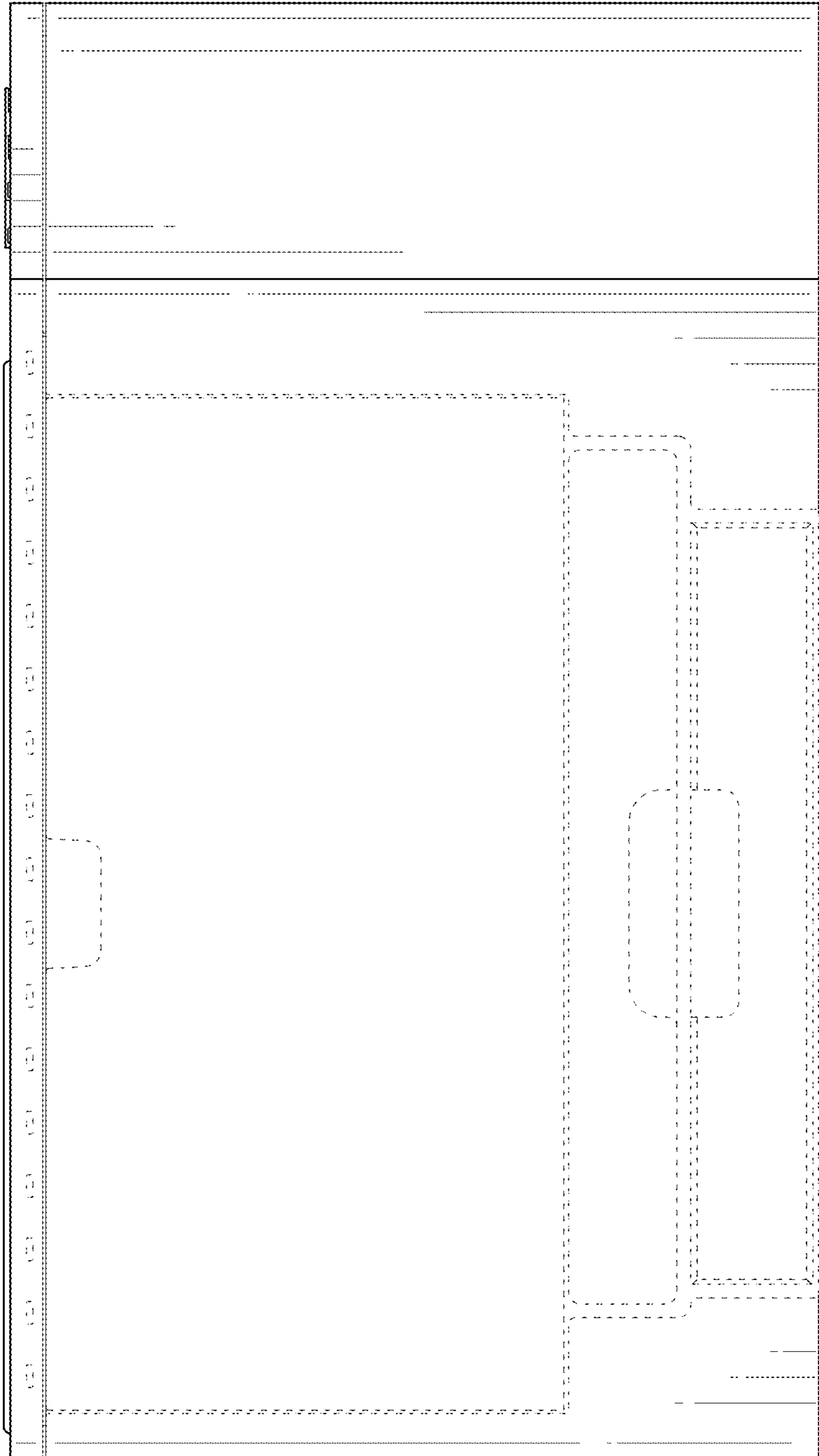

FIG. 3

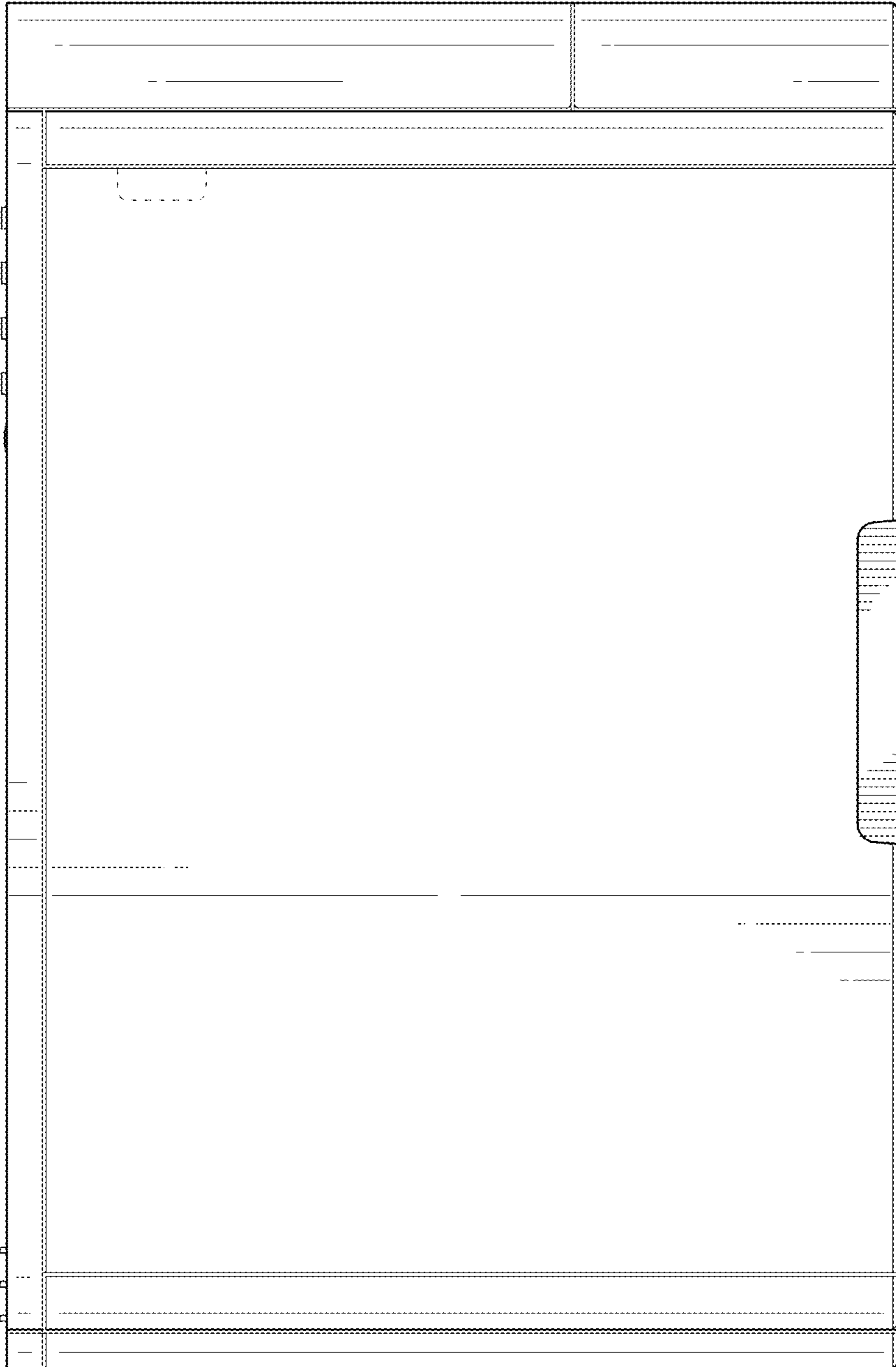

FIG. 4

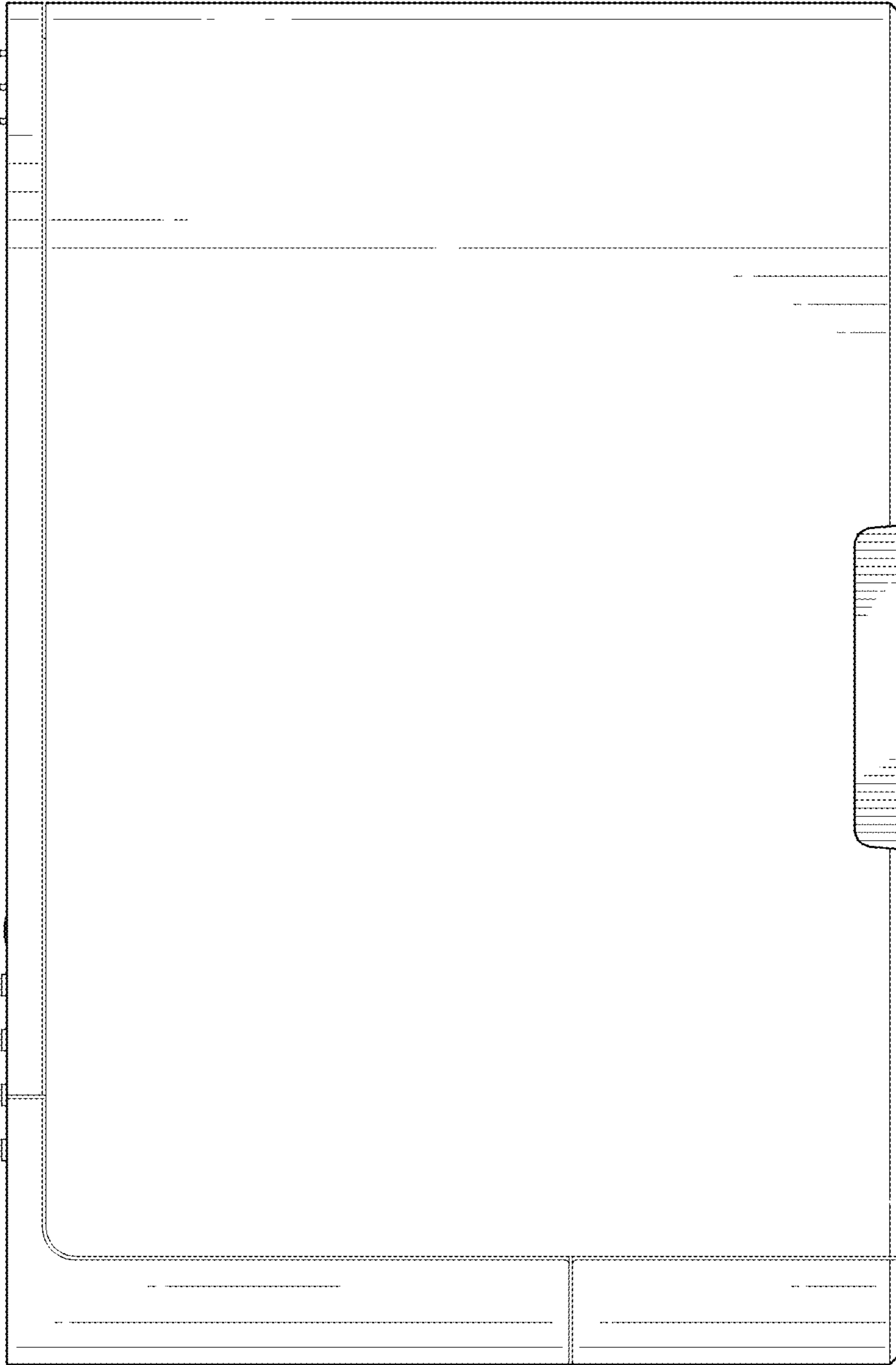

FIG. 5

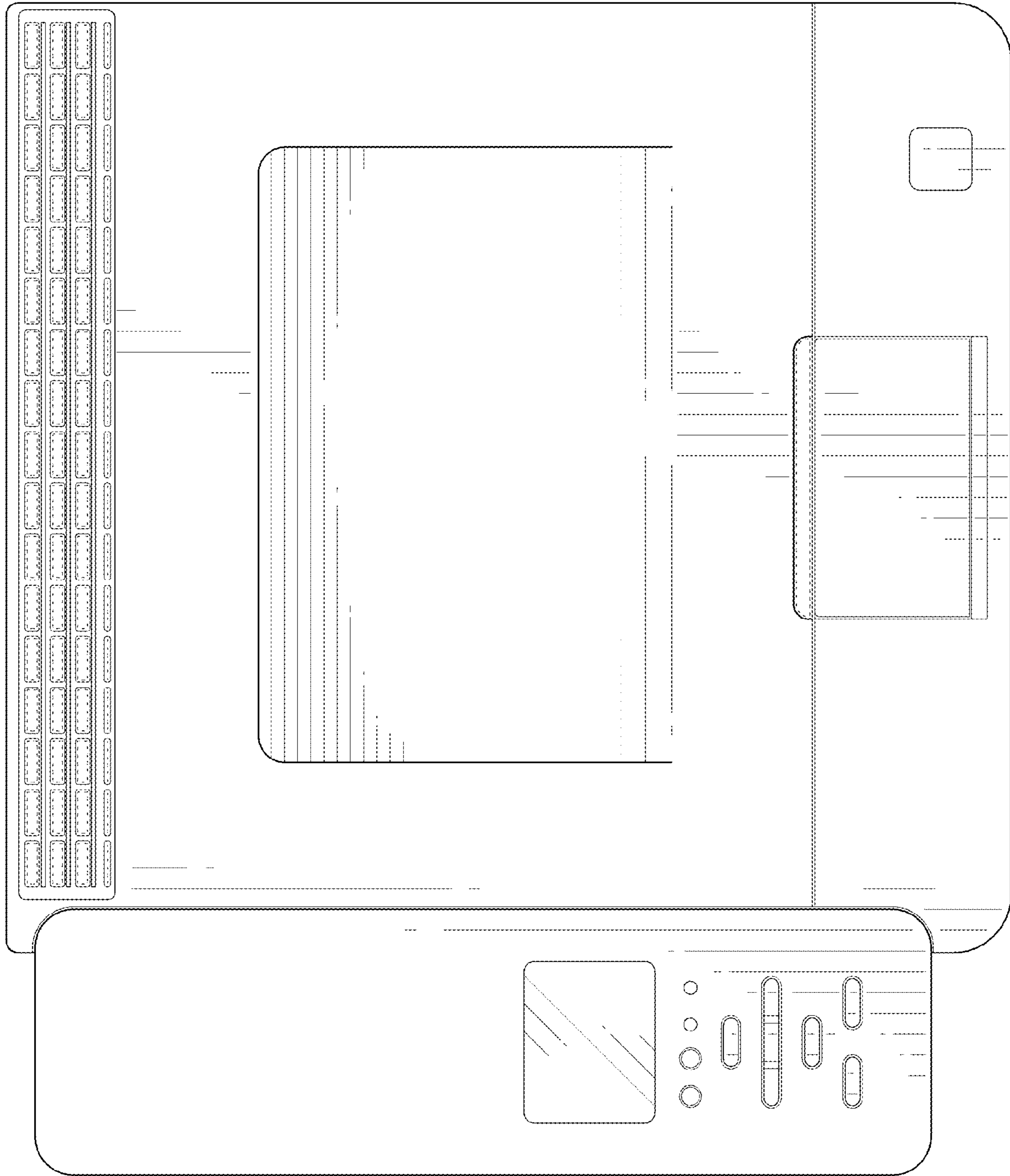

FIG. 6

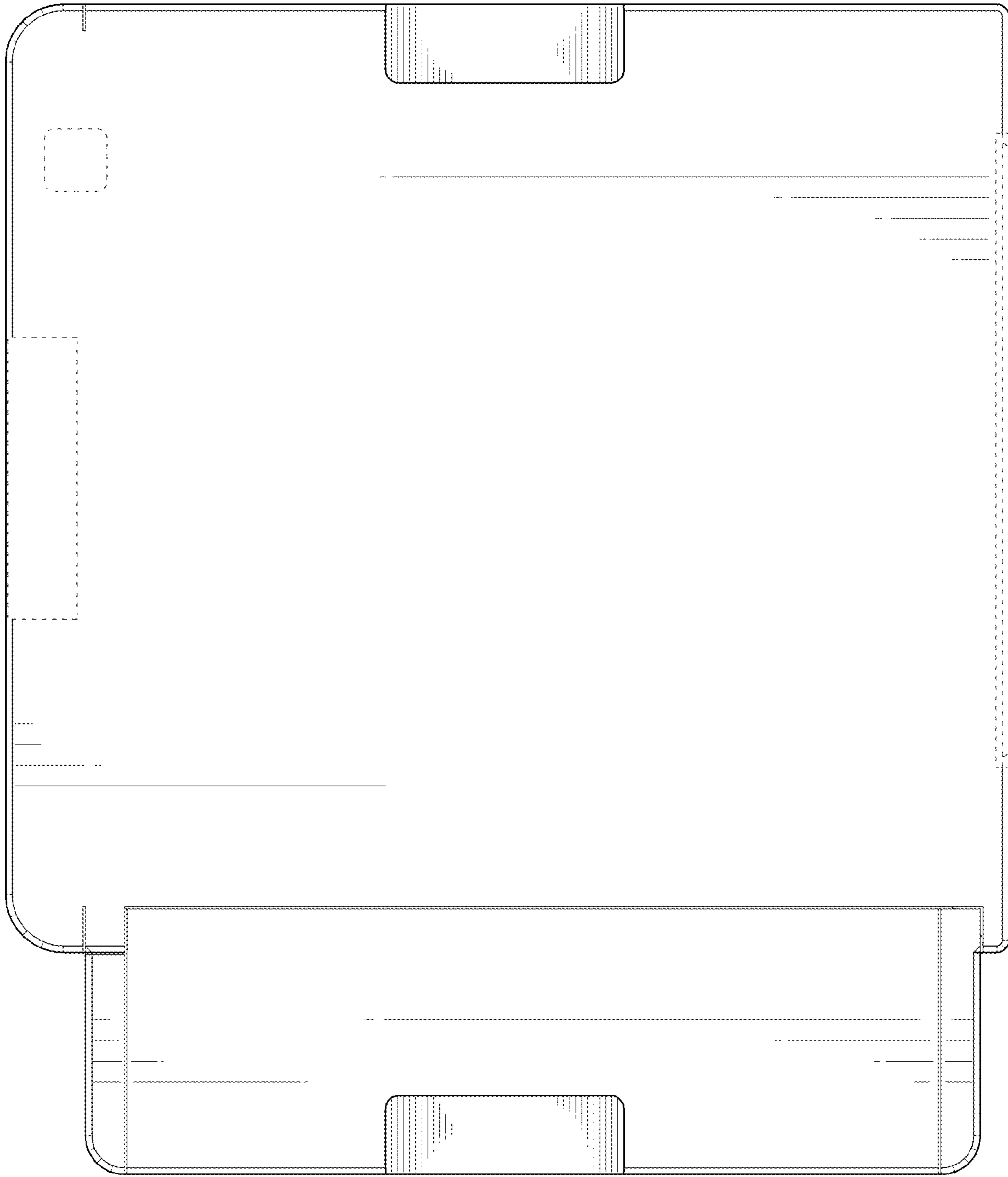

FIG. 7