



US00D989084S

(12) **United States Design Patent** (10) **Patent No.:** **US D989,084 S**
Mercaldi (45) **Date of Patent:** **** *Jun. 13, 2023**

(54) **MONITOR ADAPTER**

(71) Applicant: **Joseph Mercaldi**, Montreal (CA)

(72) Inventor: **Joseph Mercaldi**, Montreal (CA)

(73) Assignee: **GLADIATOR JOE INC.**, Montreal (CA)

(*) Notice: This patent is subject to a terminal disclaimer.

(**) Term: **15 Years**

(21) Appl. No.: **29/774,279**

(22) Filed: **Mar. 16, 2021**

(51) **LOC (14) Cl.** **14-01**

(52) **U.S. Cl.**
USPC **D14/229**

(58) **Field of Classification Search**

USPC D14/371-382, 125-129, 335-337, D14/447-452, 492, 376-382, 239, 229, D14/457, 439-441, 432, 251-253; D8/349, 354, 363, 373, 376, 380; 348/180, 184, 325, 739, 825; D12/407, D12/415; D3/218; 341/12; D13/108
CPC G06F 3/0412; G06F 3/016; G06F 3/0488; G06F 3/011; G06F 3/038; G06F 3/03543; G06F 3/0338; G06F 3/0202; G06F 3/0219; G06F 3/0213; G06F 1/1616; G06F 3/023; G06F 3/04883; G02F 1/13338; G02F 1/1313; G02F 1/1333; G02F 1/135; G02F 1/132; G02F 1/133308; G02F 1/134309; G02F 1/13718; G09G 3/3648; G06K 15/1252; B41J 2/465; G03F 7/70291; G02B 27/0172; G02B 5/30; G02B 2027/0118; G02B 27/0101; F16M 13/02; F16M 13/00; F16M 11/10; F16M 11/04; F16M 2200/08; F16M 11/2021; A47B 21/0314; A47B 88/044; A47B 2021/0335; H02G 3/126; F16B 47/00; F16B 47/006; A47G 1/17; A47K 2201/00

See application file for complete search history.

(56) **References Cited**

U.S. PATENT DOCUMENTS

2,896,901 A * 7/1959 Levy F21V 21/30 248/278.1
D418,044 S 12/1999 Schoeneweis
6,079,682 A * 6/2000 Olkkola B60R 11/0241 248/292.12
D505,671 S * 5/2005 Dayan D14/216
D568,144 S * 5/2008 Wohlford D8/354
D568,721 S 5/2008 Greaves
D624,055 S * 9/2010 Lazzeroni D14/221
D637,593 S * 5/2011 Zanetti D14/253
D652,836 S * 1/2012 Voorhees D14/238.1

(Continued)

OTHER PUBLICATIONS

US Trademark Registration No. 4825669; Word Mark—Gladiator Joe Registration date: Oct. 6, 2015 Publication date: Jul. 21, 2015.

(Continued)

Primary Examiner — Katie Jane Stofko
(74) *Attorney, Agent, or Firm* — Legalforce RAPC Worldwide

(57) **CLAIM**

The ornamental design for a monitor adapter, as shown and described.

DESCRIPTION

FIG. 1 is a rear, bottom and left side perspective view of a monitor adapter, showing my new design; FIG. 2 is a front elevational view thereof; FIG. 3 is a rear elevational view thereof; FIG. 4 is a right side elevational view thereof; FIG. 5 is a left side elevational view thereof; FIG. 6 is a top plan view thereof; and, FIG. 7 is a bottom plan view thereof.

1 Claim, 7 Drawing Sheets

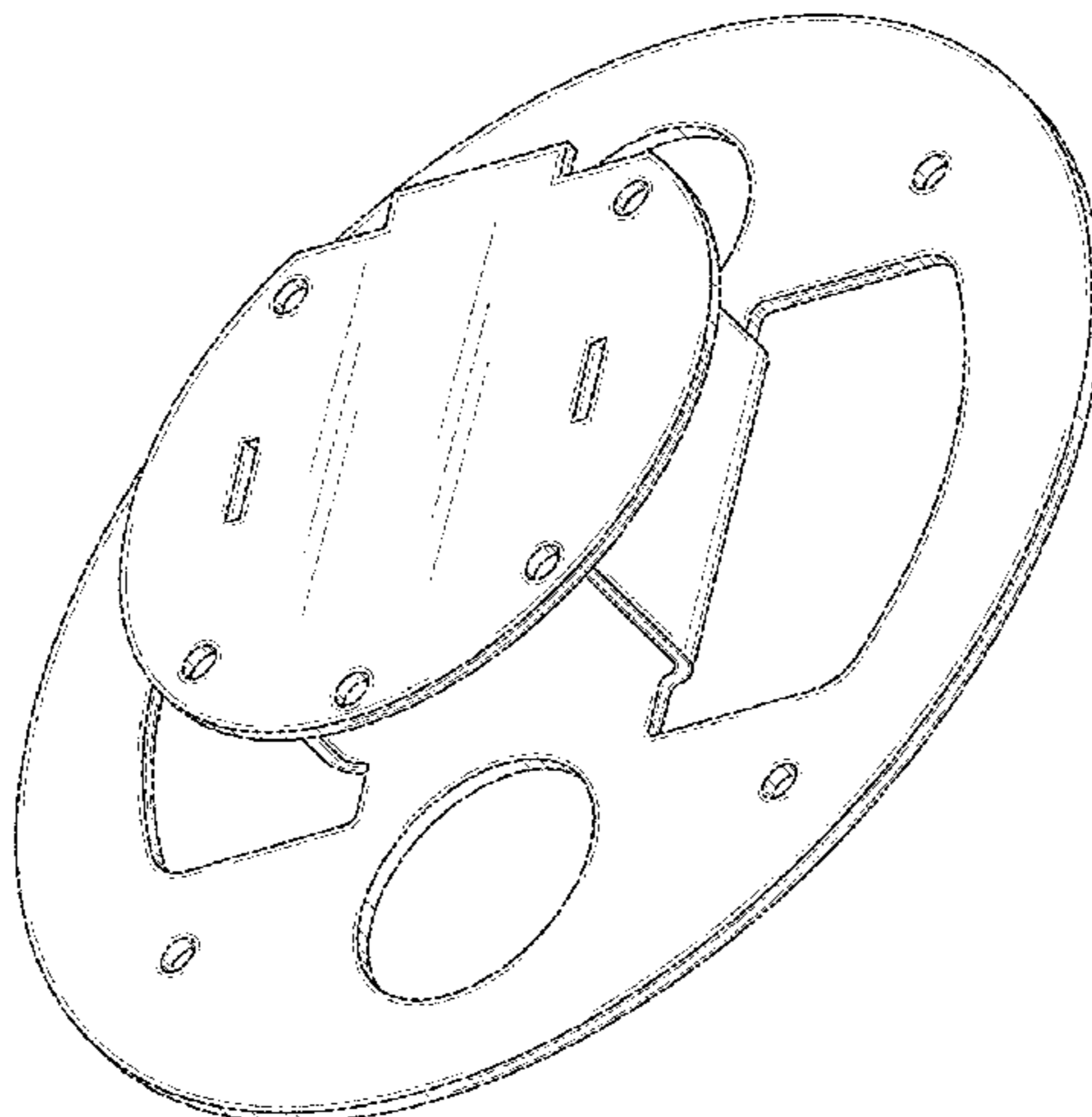

(56)

References Cited

U.S. PATENT DOCUMENTS

D734,129 S	7/2015	Allen et al.	
D819,427 S	6/2018	Mercaldi	
D822,453 S	7/2018	Kanter	
D822,454 S	7/2018	Kanter	
D823,093 S	7/2018	Kanter	
D823,094 S	7/2018	Kanter	
D826,906 S *	8/2018	Lasnier de Lavalette D8/349
D833,851 S	11/2018	Kanter	
D891,232 S	7/2020	Zhang	
D899,225 S	10/2020	Zhang	
D900,593 S	11/2020	McKillips	
D901,483 S *	11/2020	Kory D8/382
D901,745 S *	11/2020	Yang D26/74
D921,474 S *	6/2021	Borst D8/349
D922,177 S *	6/2021	Pride D8/349
D942,665 S *	2/2022	Hsu D26/74

OTHER PUBLICATIONS

US Trademark Registration No. 4825790; Word Mark—G J Registration date: Oct. 6, 2015 Publication date: Jul. 21, 2015.

US Trademark Registration No. 5298001; Word Mark—I Am Gladiator I Am Victorious Registration date: Sep. 26, 2017 Publication date: Jan. 24, 2017.

“Apple Vesa Mount Adapter” by Apple Computer, Published Online on [Dec. 12, 2019] https://images-na.ssl-images-amazon.com/images/I/61c3eHVjvHL._AC_SL1389_.jpg.

“AmazonBasics Tilting TV Wall Mount” by AmazonBasics, Published Online on [Sep. 16, 2017] https://images-na.ssl-images-amazon.com/images/I/91%2BJyS1JxKL._SL1500_.jpg.

“Universal Articulating TV Wall Mount” by Sound Around, Published Online on [Oct. 8, 2010] https://images-na.ssl-images-amazon.com/images/I/619TvuATIiL._AC_SL1000_.jpg.

“InstallerParts 10"-23" TV Wall Mount Bracket” by InstallerParts, Published Online on [Jul. 7, 2012] https://images-na.ssl-images-amazon.com/images/I/31gKKRgjLmL._AC_.jpg.

“B-Tech AviBall Swivel Tilt Wall Mount Bracket” by B-Tech AviBall, Found Online on [Mar. 22, 2021] <https://www.selby.com.au/media/catalog/product/cache/8dc42fa2ff86d291f127cfbcf7f58b48/b/t/bt7519c-chrome-bracket-1.jpg>.

* cited by examiner

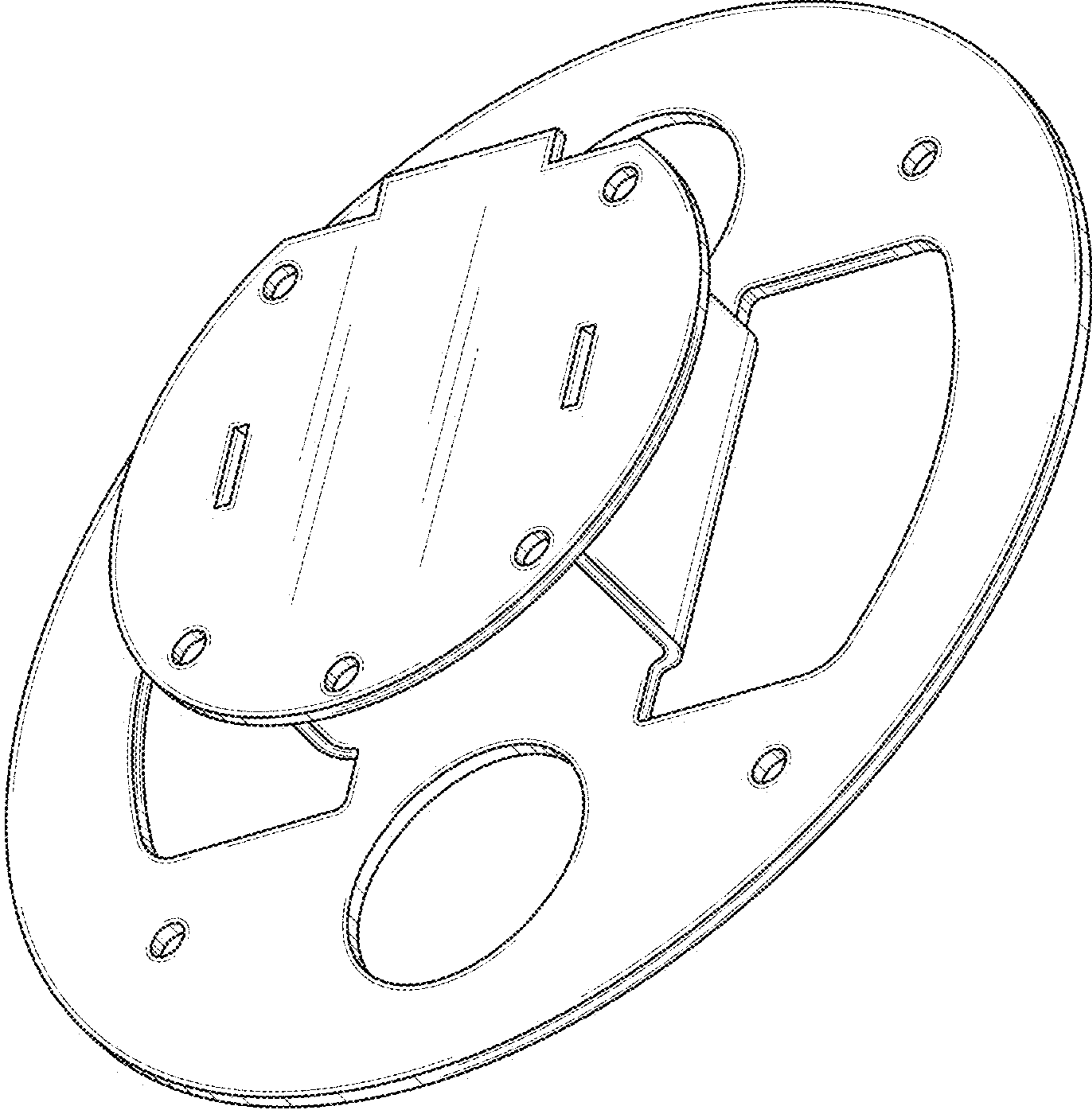

FIG. 1

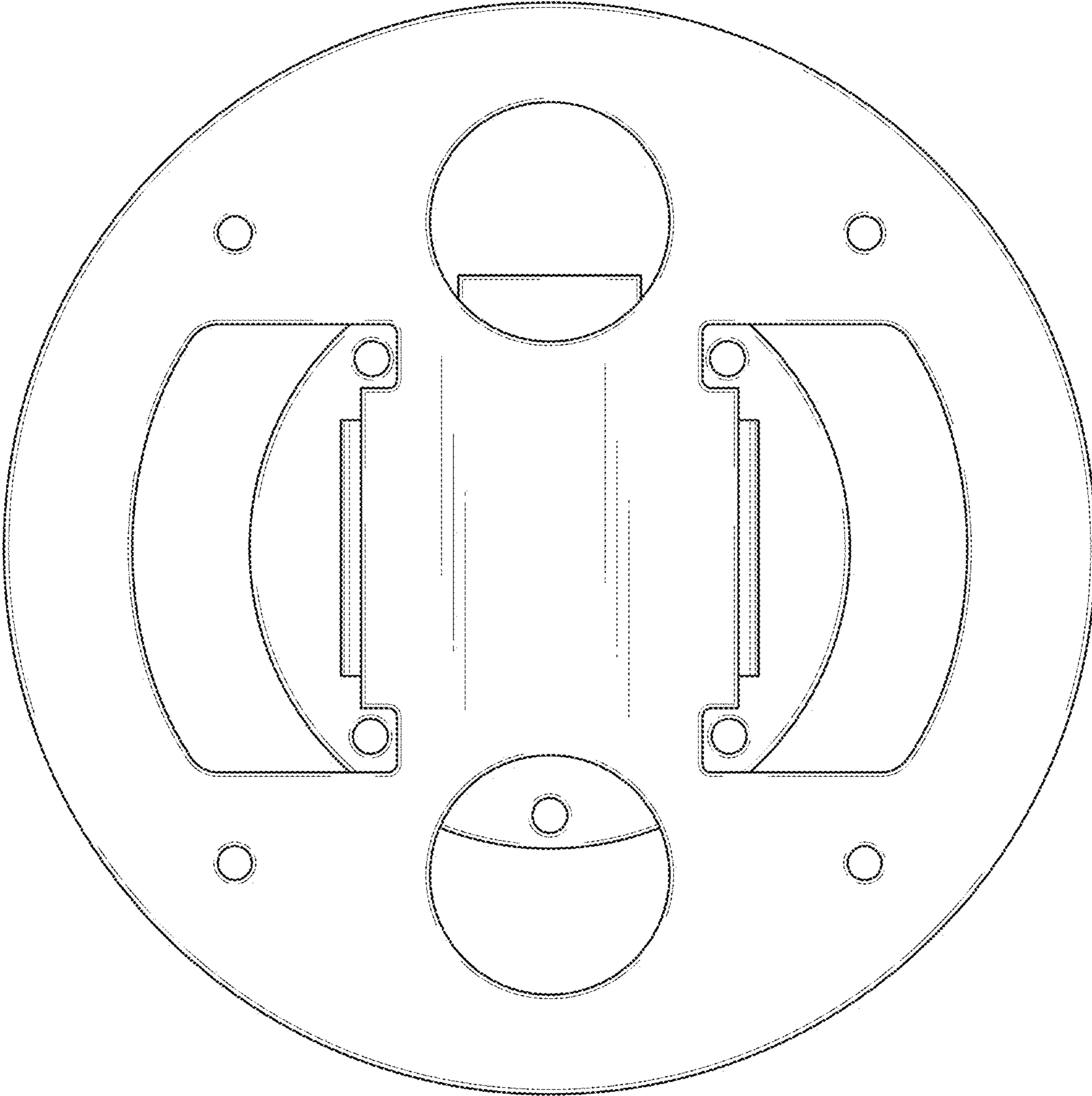

FIG. 2

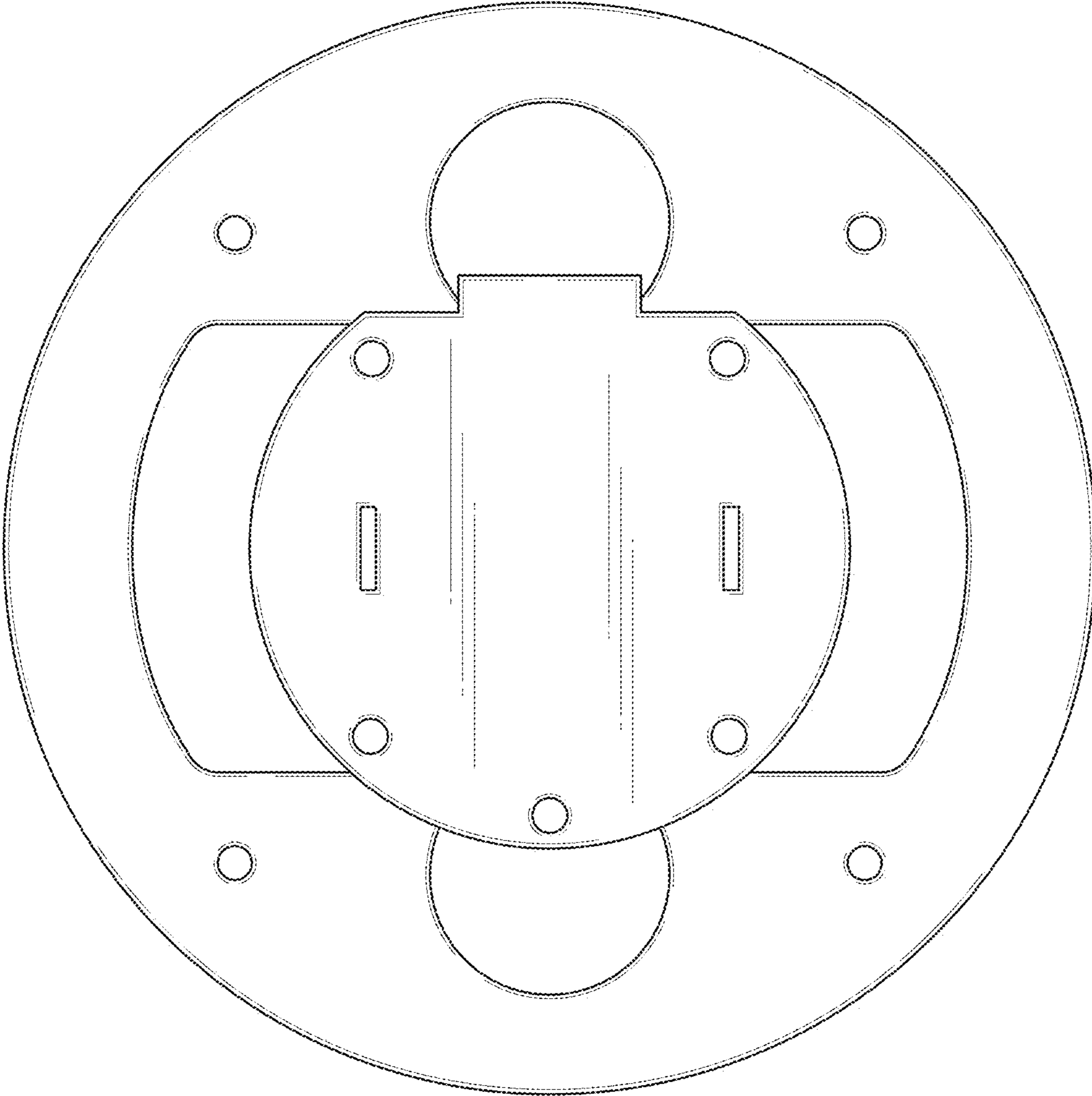

FIG. 3

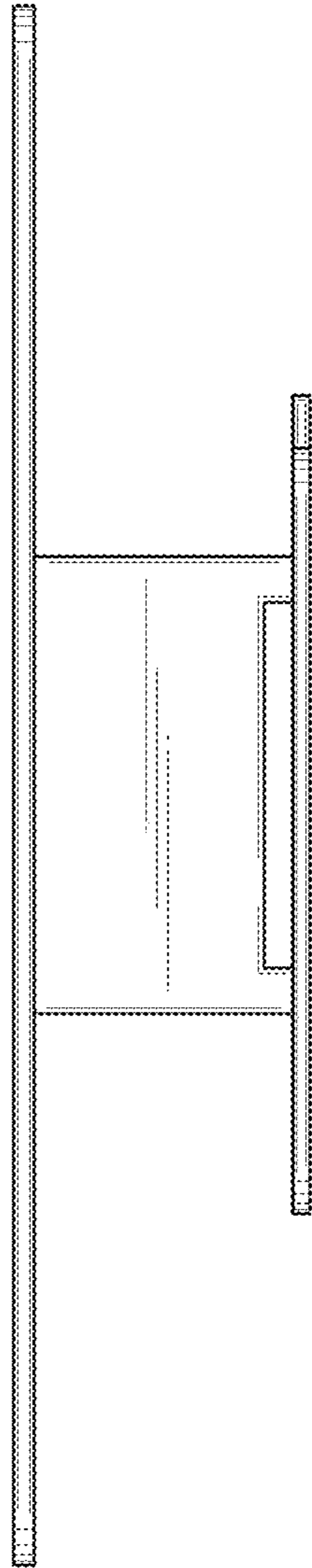

FIG. 4

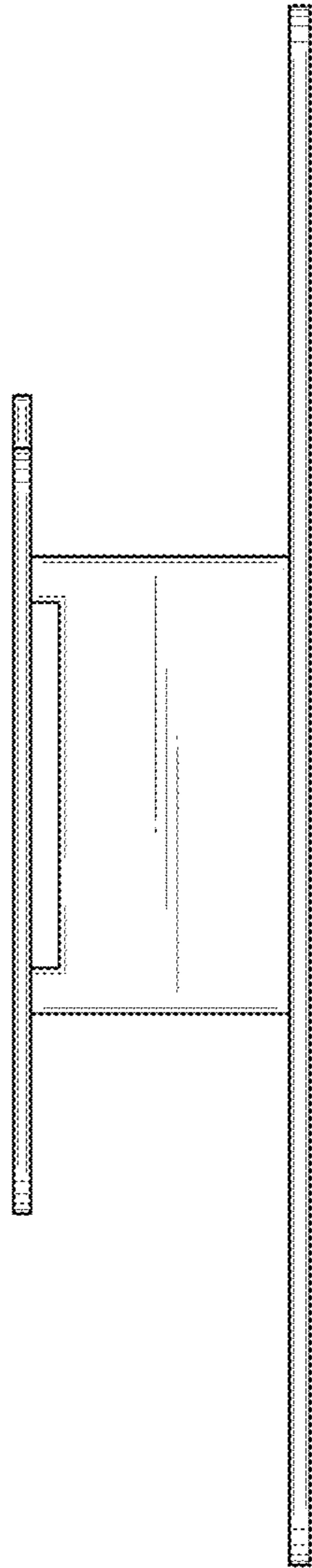

FIG. 5

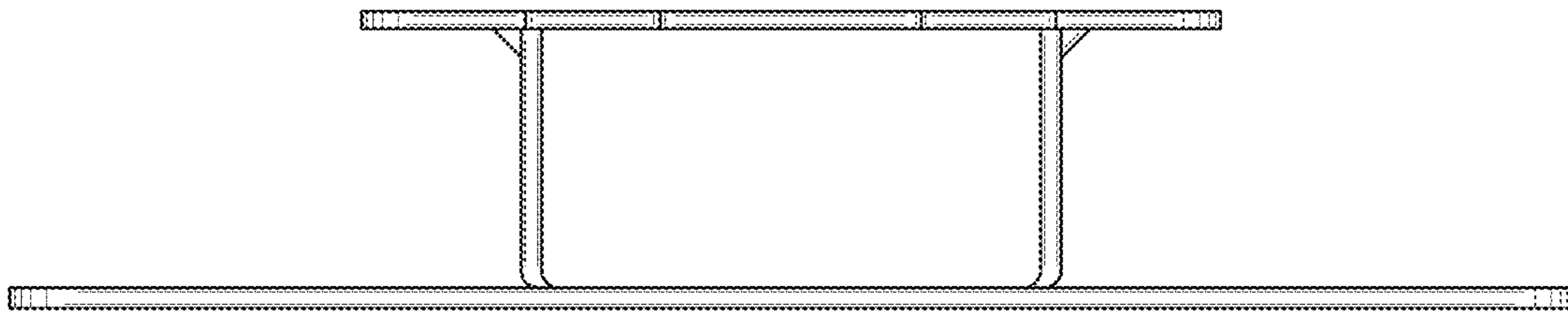

FIG. 6



FIG. 7