



US00D989024S

(12) **United States Design Patent**
Suzuki

(10) **Patent No.:** **US D989,024 S**

(45) **Date of Patent:** **** *Jun. 13, 2023**

(54) **AUDIO AMPLIFIER**

FOREIGN PATENT DOCUMENTS

(71) Applicant: **Audio-Technica Corporation**, Tokyo (JP)

JP D1664364 * 7/2020
JP D1664365 * 7/2020

(Continued)

(72) Inventor: **Wataru Suzuki**, Tokyo (JP)

OTHER PUBLICATIONS

(73) Assignee: **Audio-Technica Corporation**, Tokyo (JP)

Audio-Technica AT-BHA100 Balanced Headphone Amp, review date: Jun. 30, 2021, [retrieved Sep. 26, 2022], Retrieved from Internet, URL: <<https://drop.com/buy/audio-technica-at-bha100-balanced-headphone-amp/reviews#reviews>> (Year: 2021).*

(*) Notice: This patent is subject to a terminal disclaimer.

(Continued)

(**) Term: **15 Years**

Primary Examiner — Barbara Fox

Assistant Examiner — Aram Kwon

(21) Appl. No.: **29/742,284**

(74) *Attorney, Agent, or Firm* — WC&F IP

(22) Filed: **Jul. 22, 2020**

(57) **CLAIM**

The ornamental design for an audio amplifier, as shown and described.

(30) **Foreign Application Priority Data**

Jan. 23, 2020 (JP) 2020-001136

DESCRIPTION

(51) **LOC (14) Cl.** **14-03**

(52) **U.S. Cl.**
USPC **D14/188**

(58) **Field of Classification Search**
USPC ... D14/125–129, 138 AA, 138 AB, 138 AC, D14/138 AD, 138 C, 138 G, 155–159, D14/160–173, 187–188, 189–198, D14/203.1–203.8, 204–216, 217–222, D14/239, 248, 257–258, 315–318,
(Continued)

FIG. 1 is a perspective view of an audio amplifier; FIG. 2 is a front elevational view of the audio amplifier; FIG. 3 is a rear elevational view of the audio amplifier; FIG. 4 is a top plan view of the audio amplifier; FIG. 5 is a bottom plan view of the audio amplifier; FIG. 6 is a right side elevational view of the audio amplifier; FIG. 7 is a left side elevational view of the audio amplifier; FIG. 8 is a front elevational view of the audio amplifier shown in a state of use; and, FIG. 9 is a perspective view of the audio amplifier shown in another state of use.

(56) **References Cited**

U.S. PATENT DOCUMENTS

D263,955 S * 4/1982 Meelen D10/2
D310,371 S * 9/1990 Scott D14/258

(Continued)

Portions of the audio amplifier shown in evenly-spaced broken lines form no part of the claimed design. The dot-dot-dash line showing of the stands in FIGS. 8 and 9 depicts environmental structure and forms no part of the claimed design.

1 Claim, 9 Drawing Sheets

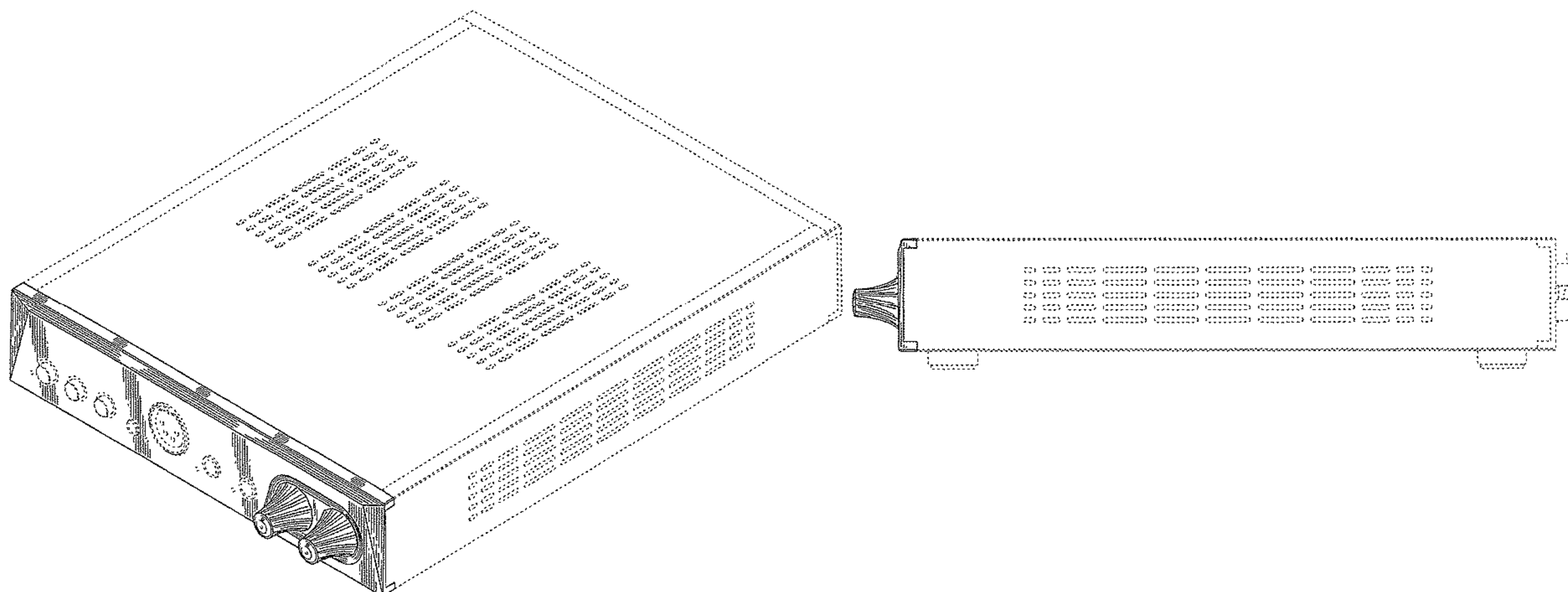

(58) **Field of Classification Search**

USPC D14/341–347, 371, 374, 413, 432,
 D14/439–441, 496, 498–506; D6/308,
 D6/310; D10/50, 65, 104.1; D18/6–7;
 D21/324, 329–330, 332
 CPC ... H04M 1/0202; H04M 1/0266; H04M 1/725
 See application file for complete search history.

(56) **References Cited**

U.S. PATENT DOCUMENTS

D311,920 S	*	11/1990	Fuller	D14/257
D347,844 S	*	6/1994	Diachyo	D14/198
D386,174 S	*	11/1997	Boyd	D14/125
D399,840 S	*	10/1998	Curbbun	D14/358
D434,737 S	*	12/2000	Jensen	D14/125
D446,779 S	*	8/2001	Jensen	D14/125
D458,908 S	*	6/2002	Liu	D14/125
D509,490 S	*	9/2005	Storti	D14/125
D521,000 S	*	5/2006	Sanefuji	D14/356
D526,306 S	*	8/2006	Hori	D14/506
D571,741 S	*	6/2008	Cha	D14/125
D593,989 S	*	6/2009	Endo	D14/258
D597,973 S	*	8/2009	Kaneko	D14/125
D856,299 S	*	8/2019	Kuramoto	D14/188
D964,307 S	*	9/2022	Suzuki	D14/257

FOREIGN PATENT DOCUMENTS

JP	D1664366	*	7/2020
WO	WOD209552-001	*	1/2021

OTHER PUBLICATIONS

Audio-Technica AT-BHA100, Nov. 10, 2021, [retrieved Sep. 26, 2022], Retrieved from Internet, URL: <<https://www.ecoustics.com/products/audio-technica-at-bha100-dac100/>> (Year: 2021).*

Audio-Technica Consumer AT-BHA100, date not available, [retrieved Sep. 26, 2022], Retrieved from Internet, URL: <https://www.bhphotovideo.com/c/product/1672206-REG/audio_technica_consumer_at_bha100_balanced_headphone_amplifier.html> (Year: 2022).*

Audio-Technica's Releases New Balanced Headphone Amplifier, Nov. 4, 2020, [retrieved Sep. 26, 2022], Retrieved from Internet, URL: <<https://sea.audio-technica.com/blog/Audio-Technica-Releases-New-Balanced-Headphone-Amplifier-AT-BHA100>> (Year: 2020).*

ST-10, date not available, [retrieved Sep. 26, 2022], Retrieved from Internet, URL: <<https://nuprimeaudio.com/product/st-10/?v=7516fd43adaa>> (Year: 2022).*

* cited by examiner

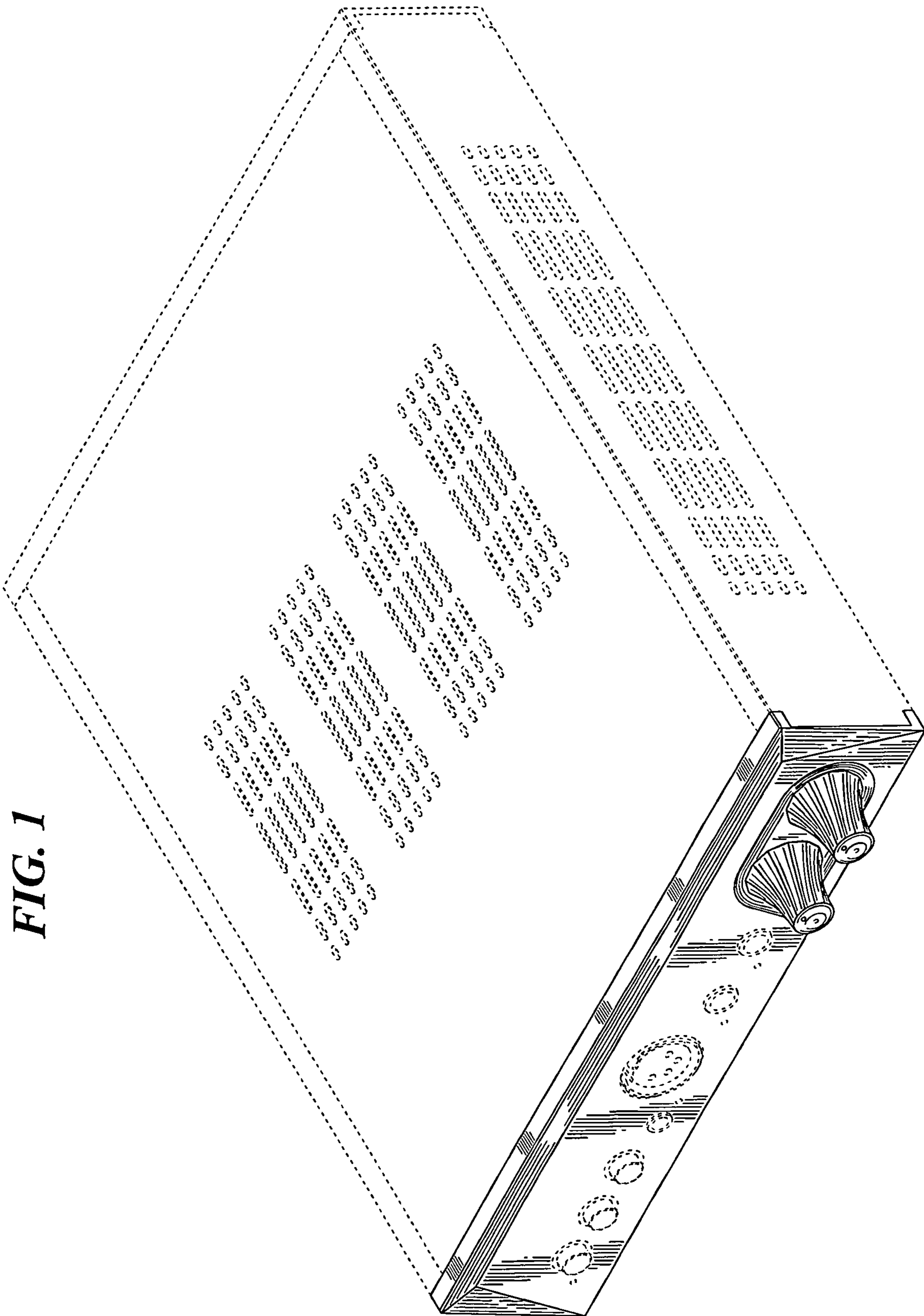

FIG. 2

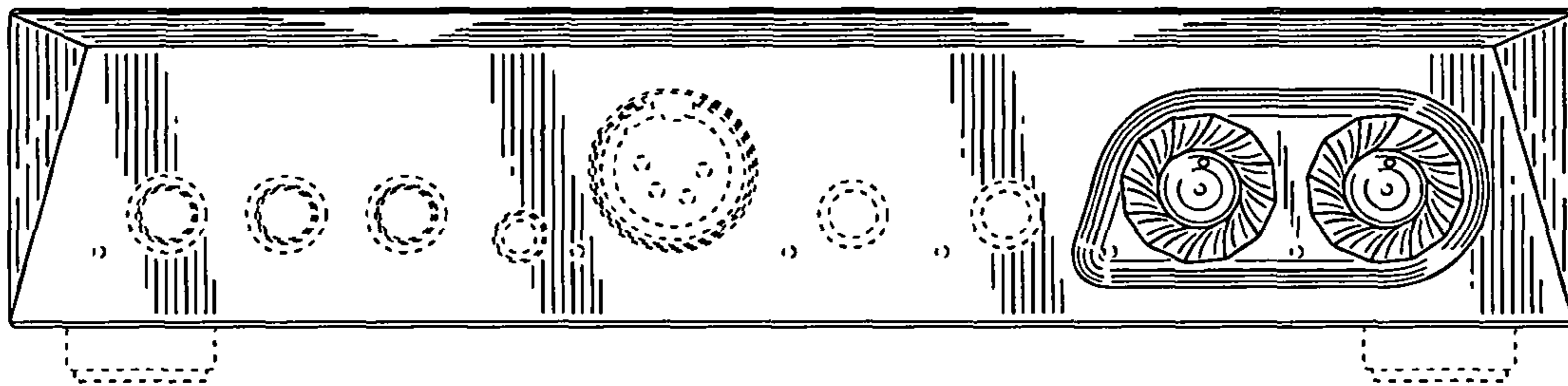

FIG. 3

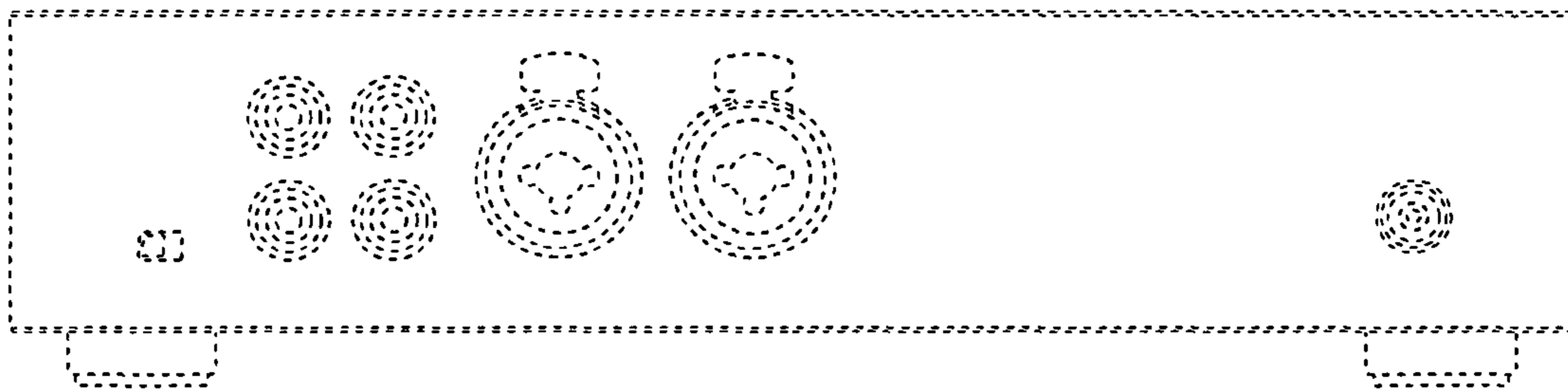

FIG. 4

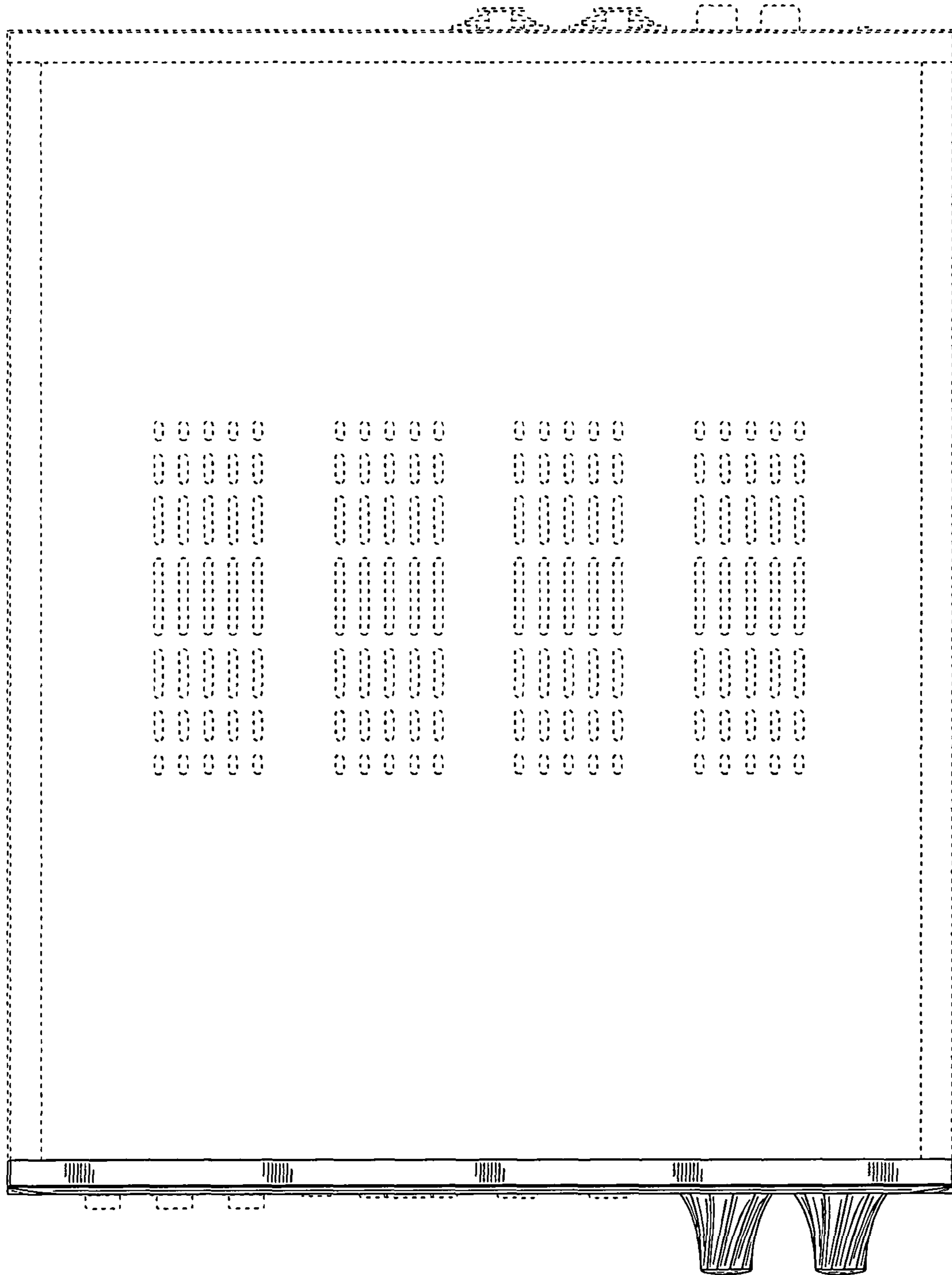

FIG. 5

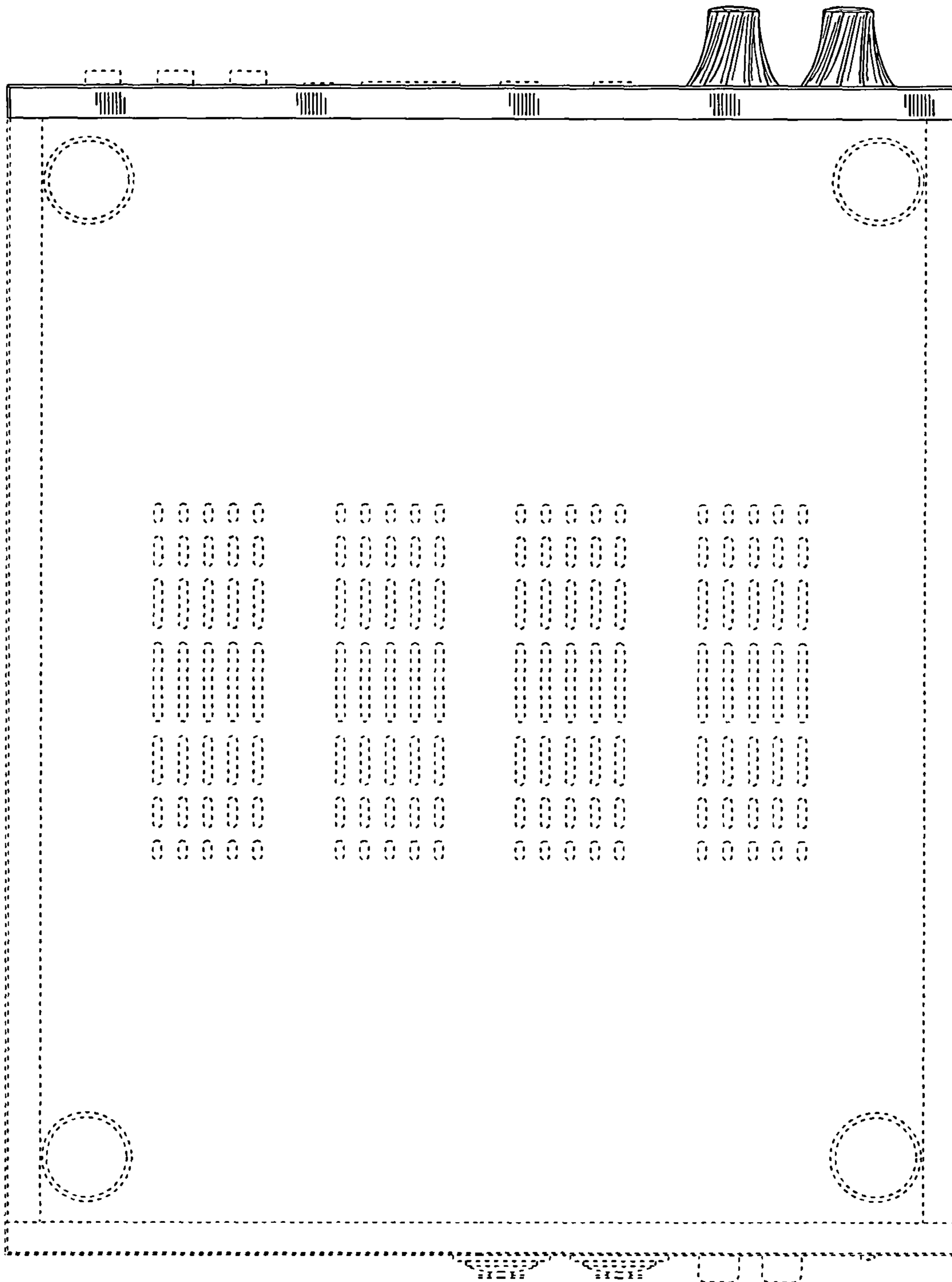

FIG. 6

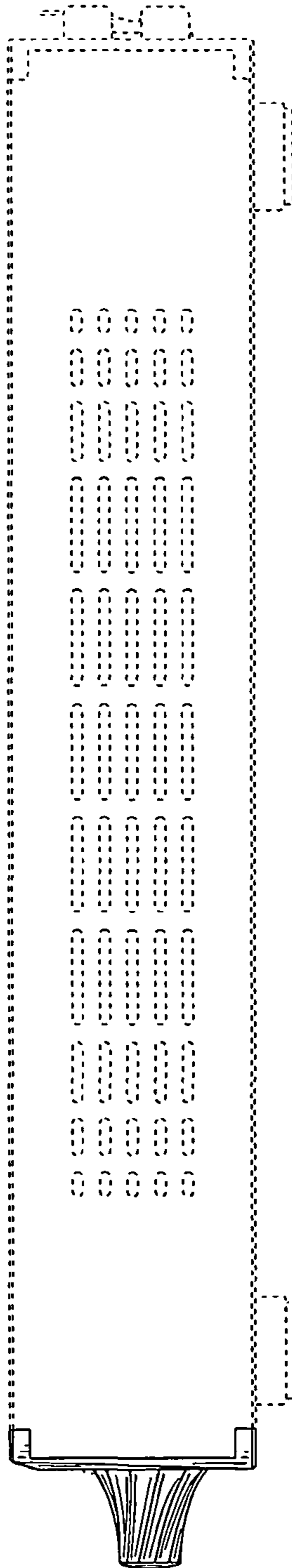

FIG. 7

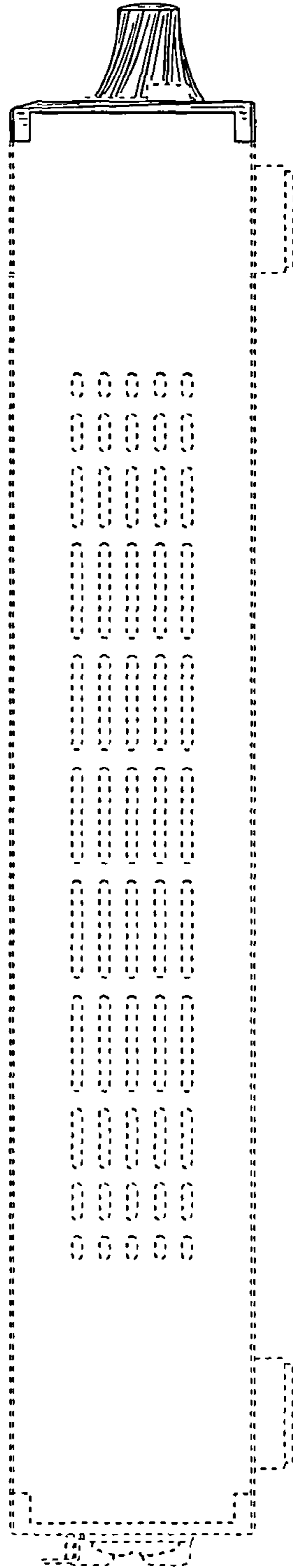

FIG. 8

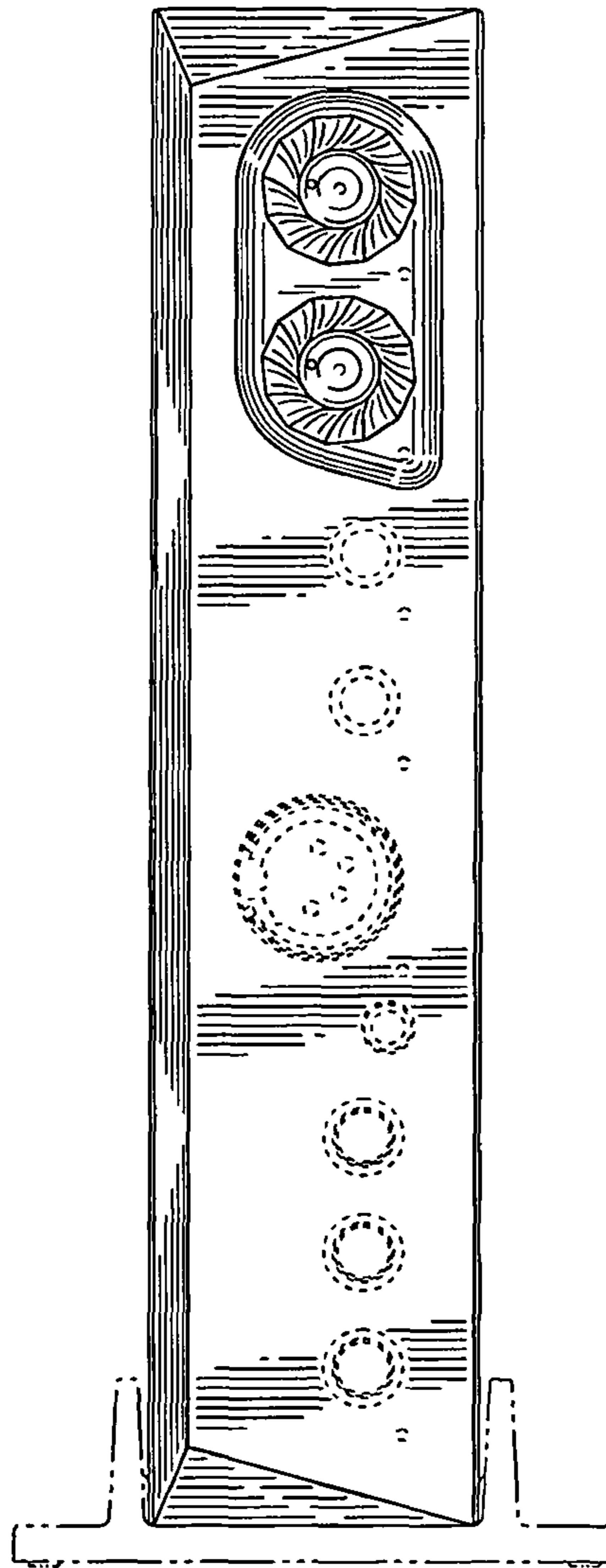

FIG. 9

