



US00D988867S

(12) **United States Design Patent**
Le Roux et al.

(10) **Patent No.:** **US D988,867 S**
(45) **Date of Patent:** **** Jun. 13, 2023**

(54) **BOTTLE CAP**

2525/286; B65D 2525/287; B65D
2525/288; B65D 53/02;

(71) Applicant: **McCormick & Company, Inc.**, Hunt
Valley, MD (US)

(Continued)

(72) Inventors: **Morgan Le Roux**, Avignon (FR);
Olivier Rattin, Althen-des-Paluds (FR);
Mark Armstrong, Wales (GB); **Janet
Anne Oliver**, Berkshire (GB)

(56) **References Cited**

U.S. PATENT DOCUMENTS

D613,553 S * 4/2010 Wilson D7/401.1
8,235,317 B2 8/2012 Wilson et al.

(Continued)

(73) Assignee: **MCCORMICK & COMPANY,
INCORPORATED**, Hunt Valley, MD
(US)

FOREIGN PATENT DOCUMENTS

WO 2020/180665 9/2020

(**) Term: **15 Years**

OTHER PUBLICATIONS

(21) Appl. No.: **29/777,091**

McCormick Grinder: Site Visited (Sep. 24, 2022). Available from
Interent URL: https://www.amazon.com/McCormick-Italian-Herb-Seasoning-Grinder/dp/B016F7BP50/ref=cm_cr_arp_d_product_top?ie=UTF8.*

(22) Filed: **Apr. 2, 2021**

(Continued)

(30) **Foreign Application Priority Data**

Feb. 25, 2021 (WO) WIPO101962
Feb. 25, 2021 (WO) WIPO101965

Primary Examiner — Catherine S Posthauer
(74) *Attorney, Agent, or Firm* — Greenblum & Bernstein,
P.L.C.

(51) **LOC (14) Cl.** **09-07**

(52) **U.S. Cl.**
USPC **D9/449**

(57) **CLAIM**

(58) **Field of Classification Search**

USPC D7/372, 387, 391, 392.1, 396.1, 396.2,
D7/396.6, 414, 388, 402, 403; D9/434,
D9/435, 436, 438, 439, 440, 442, 443,
D9/445, 446, 449, 452, 453, 454, 455,
D9/456; D3/201, 273, 304, 315, 318,
D3/319, 323; D23/209, 258, 259, 260,
D23/261; D24/127, 162, 193, 194, 197,
D24/199, 224, 227; D34/10, 11; D6/518
CPC B25B 13/5008; B25B 15/008; B65D 1/02;
B65D 1/0233; B65D 1/08; B65D 1/10;
B65D 41/14; B65D 41/16; B65D
41/3428; B65D 55/16; B65D 43/169;
B65D 43/26; B65D 43/08; B65D
2543/00972; B65D 2525/285; B65D

We claim the ornamental design for a bottle cap, as shown
and described.

DESCRIPTION

FIG. 1 is a top, front perspective view of a bottle cap,
showing our new design;
FIG. 2 is a bottom, front perspective view thereof;
FIG. 3 is a front view thereof;
FIG. 4 is a rear view thereof;
FIG. 5 is a left side view thereof;
FIG. 6 is a right side view thereof;
FIG. 7 is a top view thereof;
FIG. 8 is a bottom view thereof; and,
FIG. 9 is an exploded top, front perspective view thereof.

(Continued)

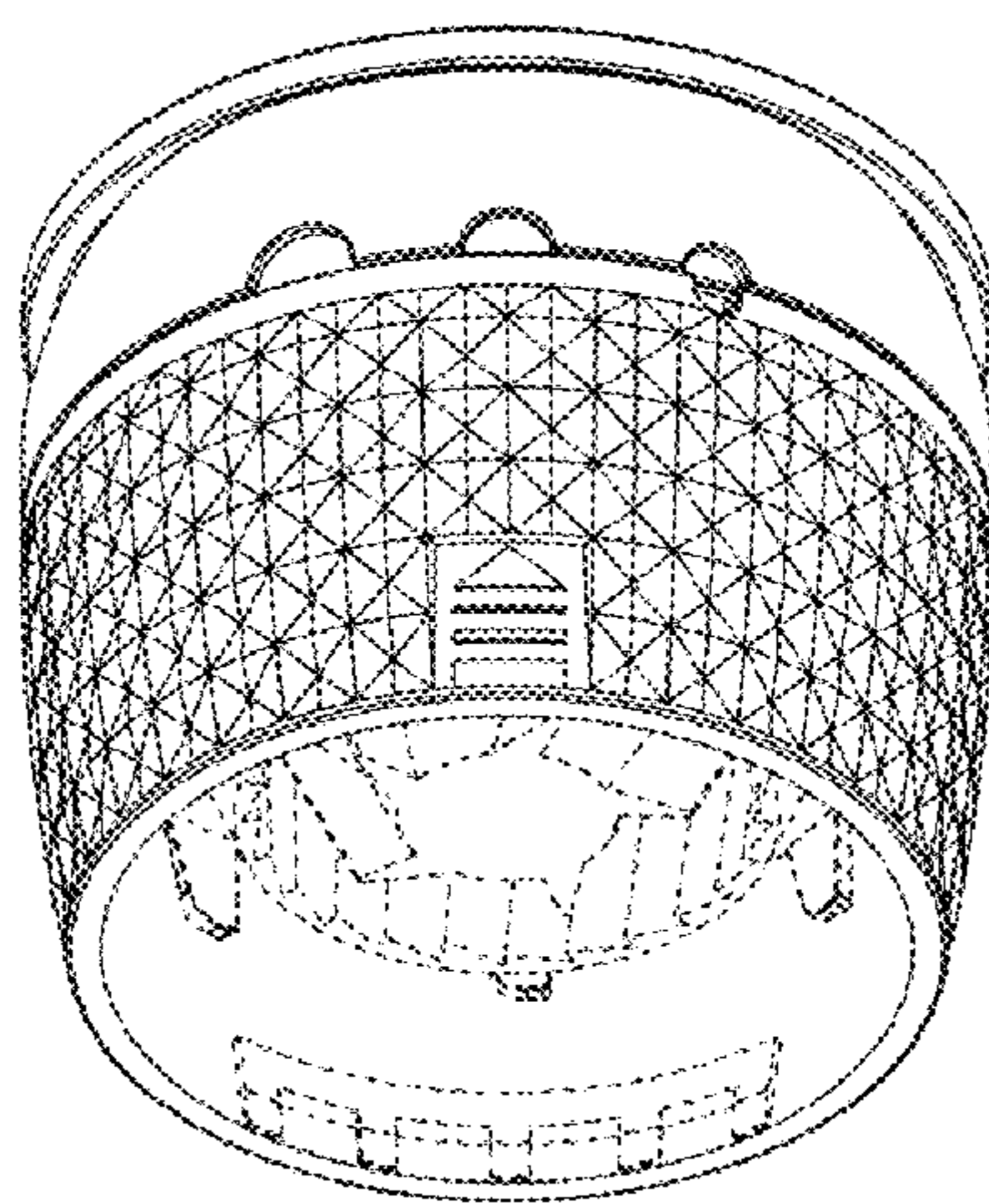
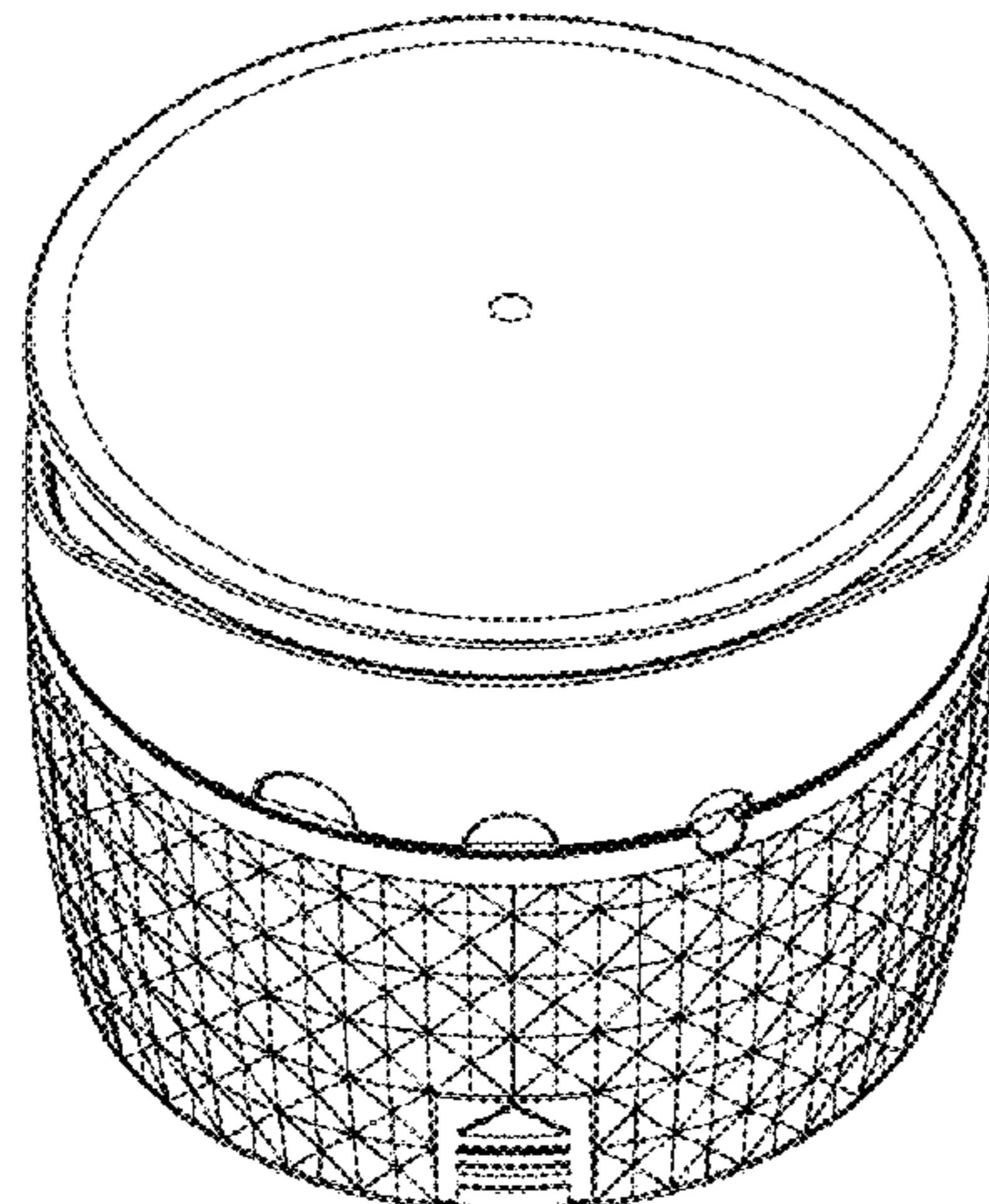

The broken lines shown in the drawings indicate portions of the bottle cap that form no part of the claimed design.

1 Claim, 9 Drawing Sheets

(58) Field of Classification Search

CPC B65D 83/0805; B65D 75/5894; B65D 43/088; A47G 19/24; B67D 3/00
See application file for complete search history.

(56)

References Cited

U.S. PATENT DOCUMENTS

D666,494	S	*	9/2012	Stull	D9/449
D675,523	S	*	2/2013	Bartz	D9/443
D833,875	S	*	11/2018	Harrison	D9/503
D869,275	S	*	12/2019	Taunk	D9/453

D873,070	S	*	1/2020	Frings	D9/452
D883,783	S	*	5/2020	Pinard	D9/454
D902,717	S	*	11/2020	Jiménez Gálvez	D9/453
D918,719	S	*	5/2021	Tamarindo	D9/446
D920,114	S	*	5/2021	Reeve	D9/446
D924,018	S	*	7/2021	Huang	D7/679
D926,034	S	*	7/2021	Bravman	D9/452
D941,145	S	*	1/2022	Wang	D9/454
D942,806	S	*	2/2022	Dean	D7/392.1
D942,857	S	*	2/2022	De Baschmakoff	D9/452
D945,265	S	*	3/2022	Wanders	D9/452
2022/0248906	A1	*	8/2022	Le Roux	A47J 42/38

OTHER PUBLICATIONS

Spice Grinder Cap: Site Visited (Nov. 8, 2022). Available from URL: <https://www.seyca.com/en/producto/caps-covers-en/spice-grinder-cap/>.*

* cited by examiner

FIG. 1

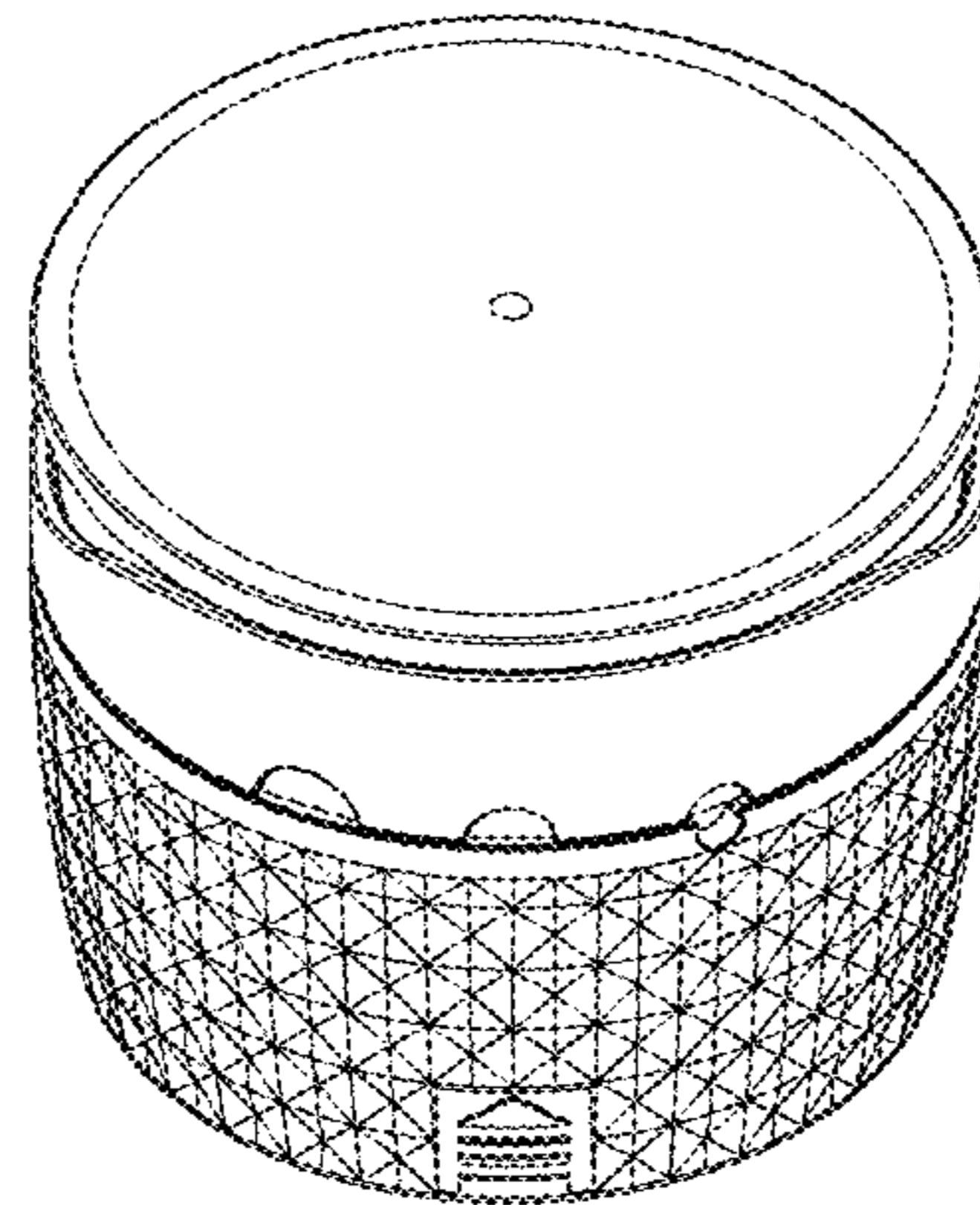

FIG. 2

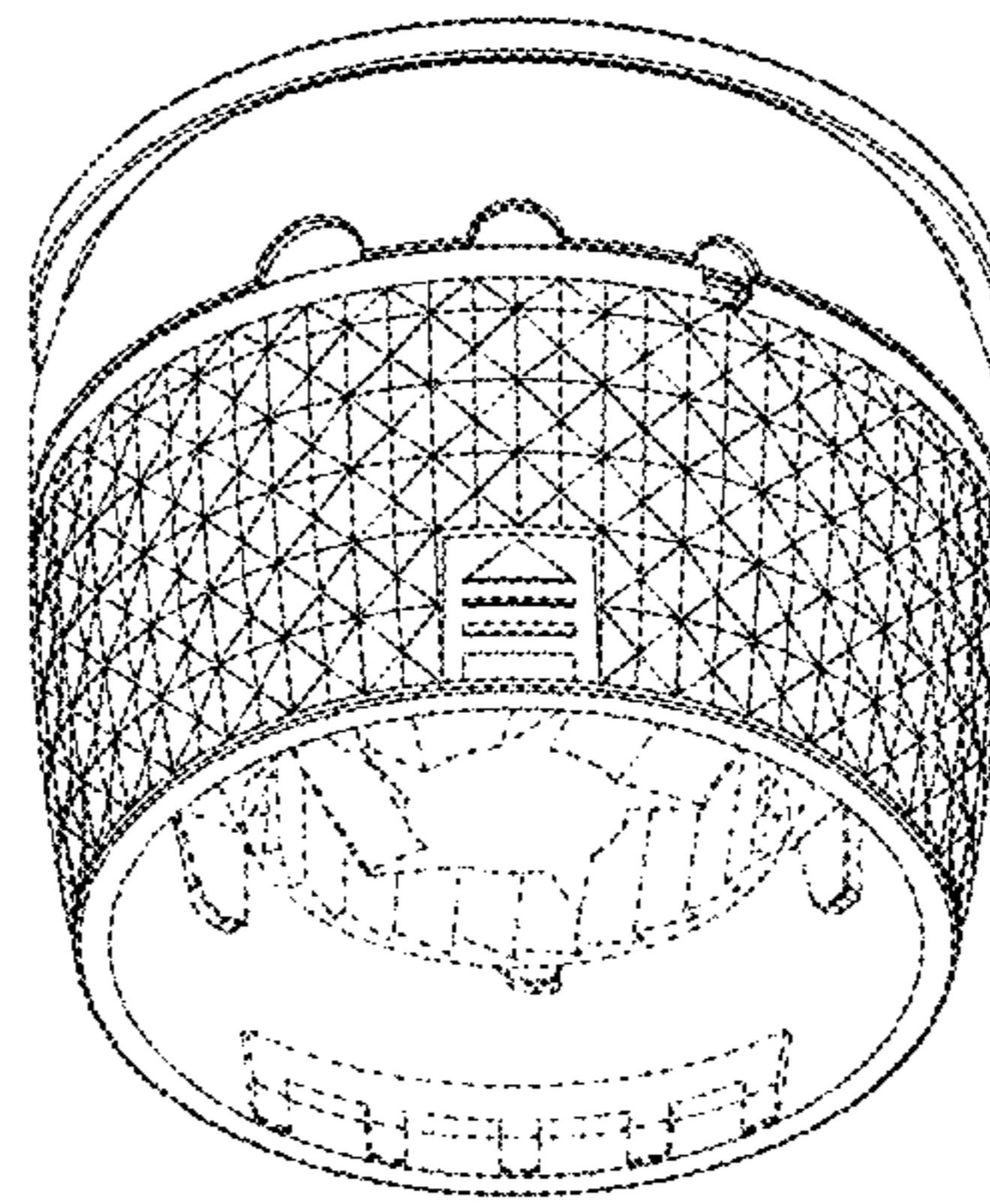

FIG. 3

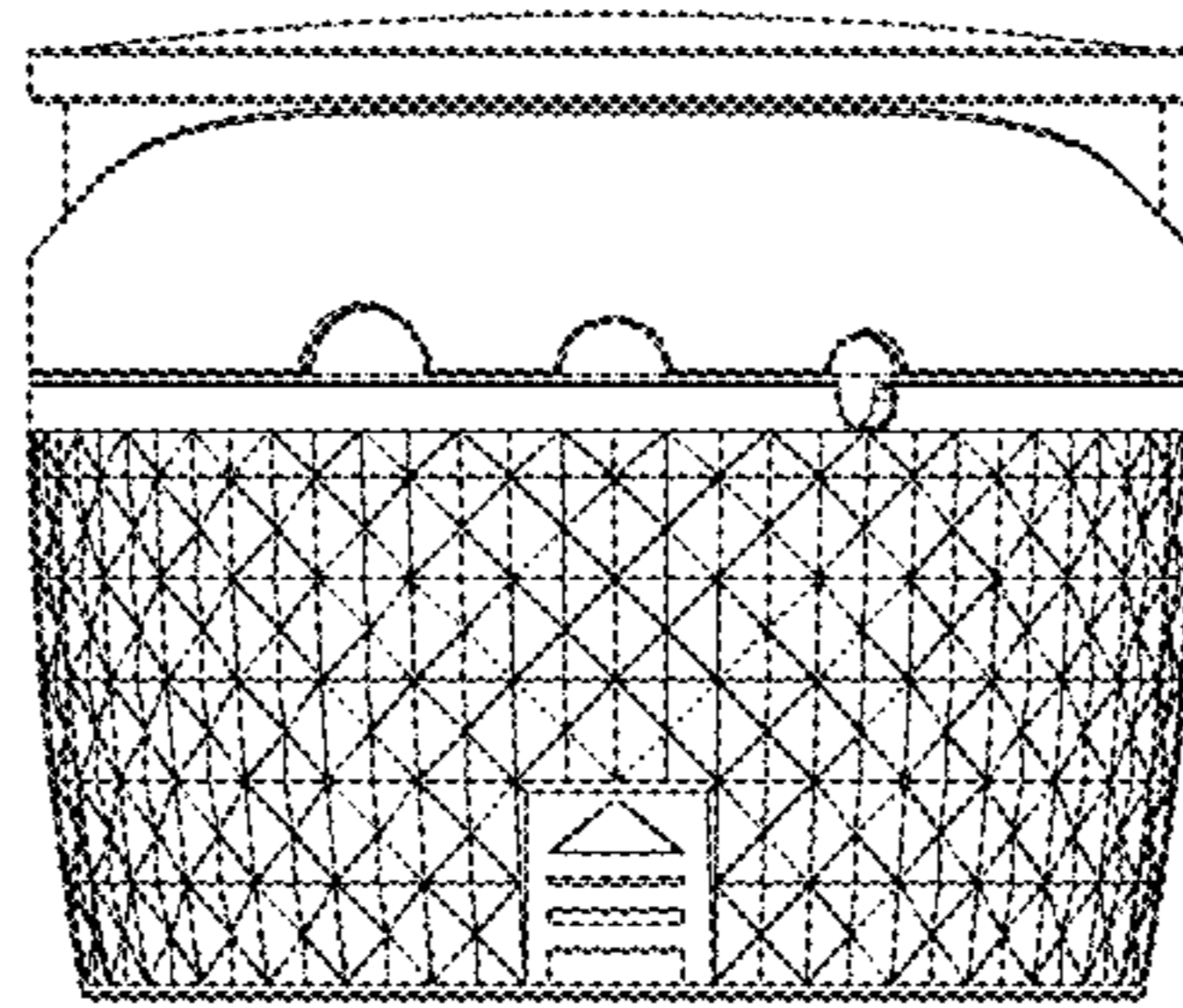

FIG. 4

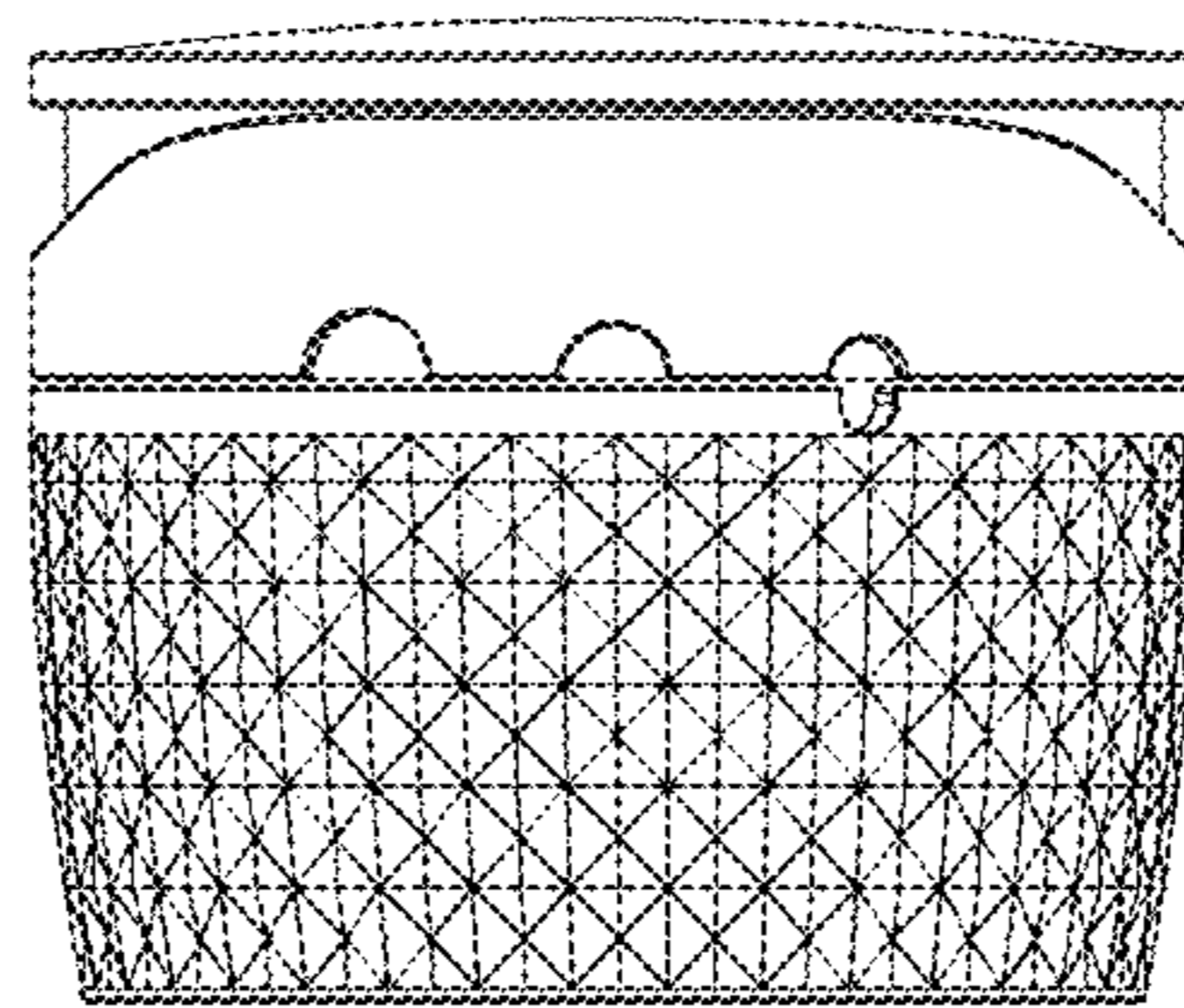

FIG. 5

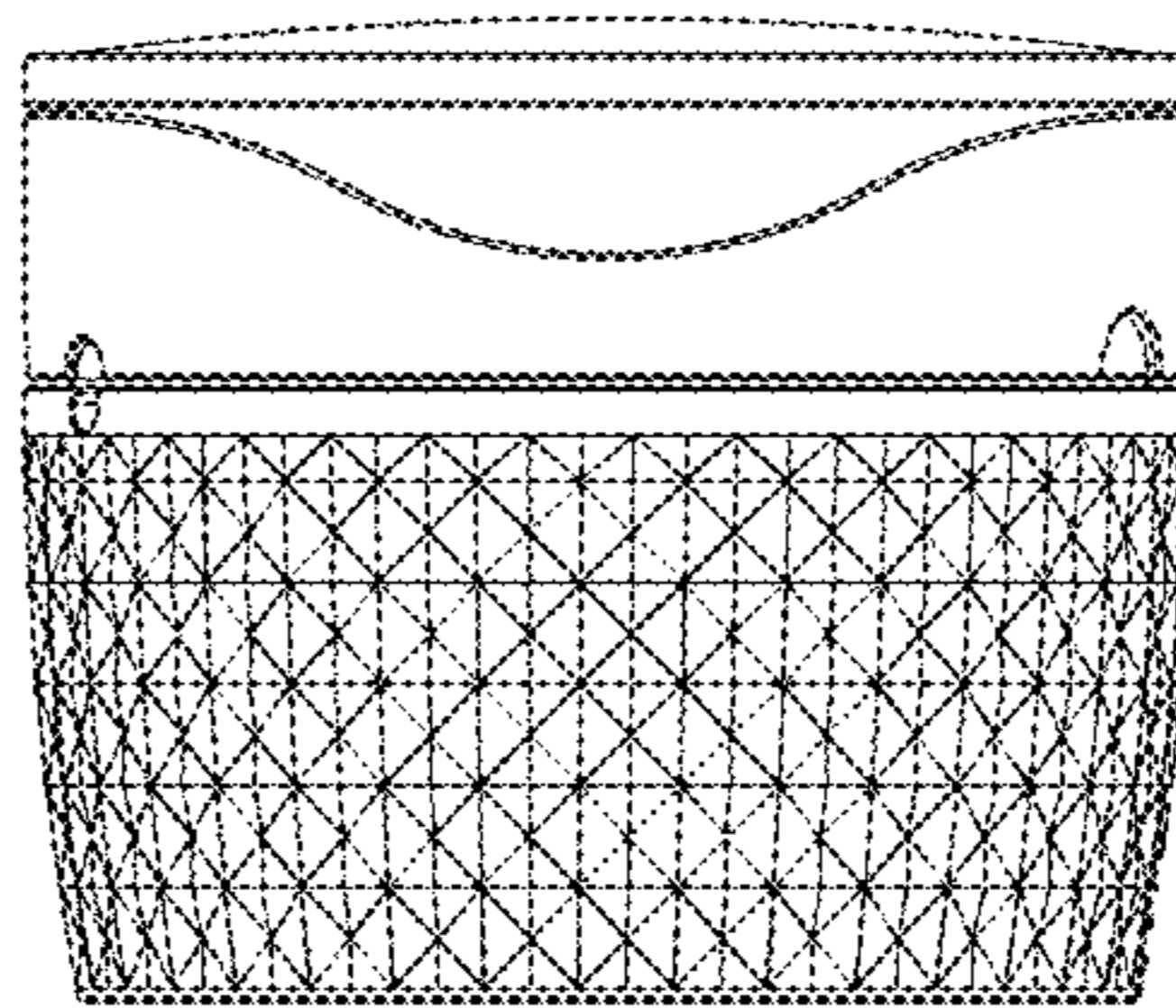

FIG. 6

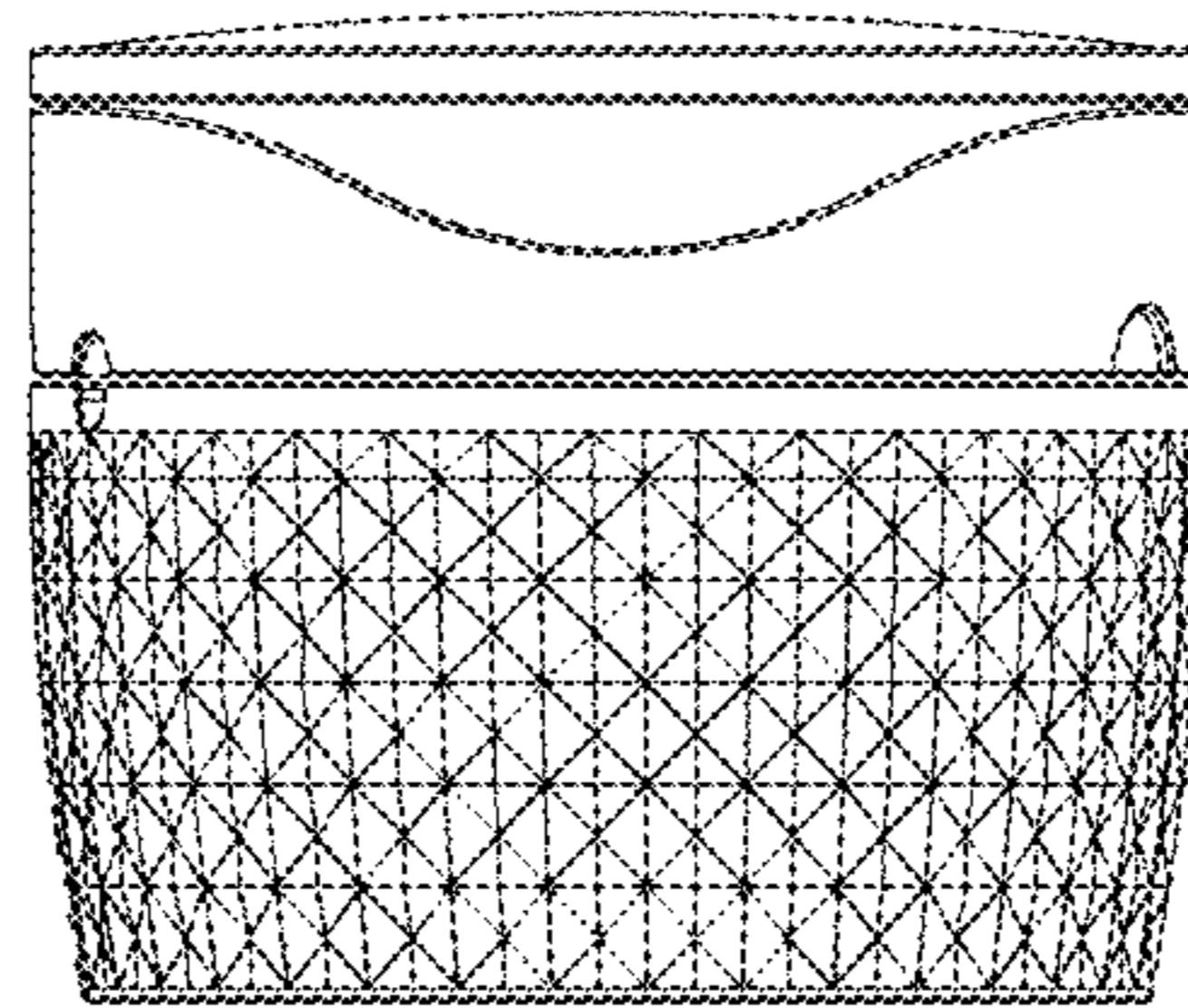

FIG. 7

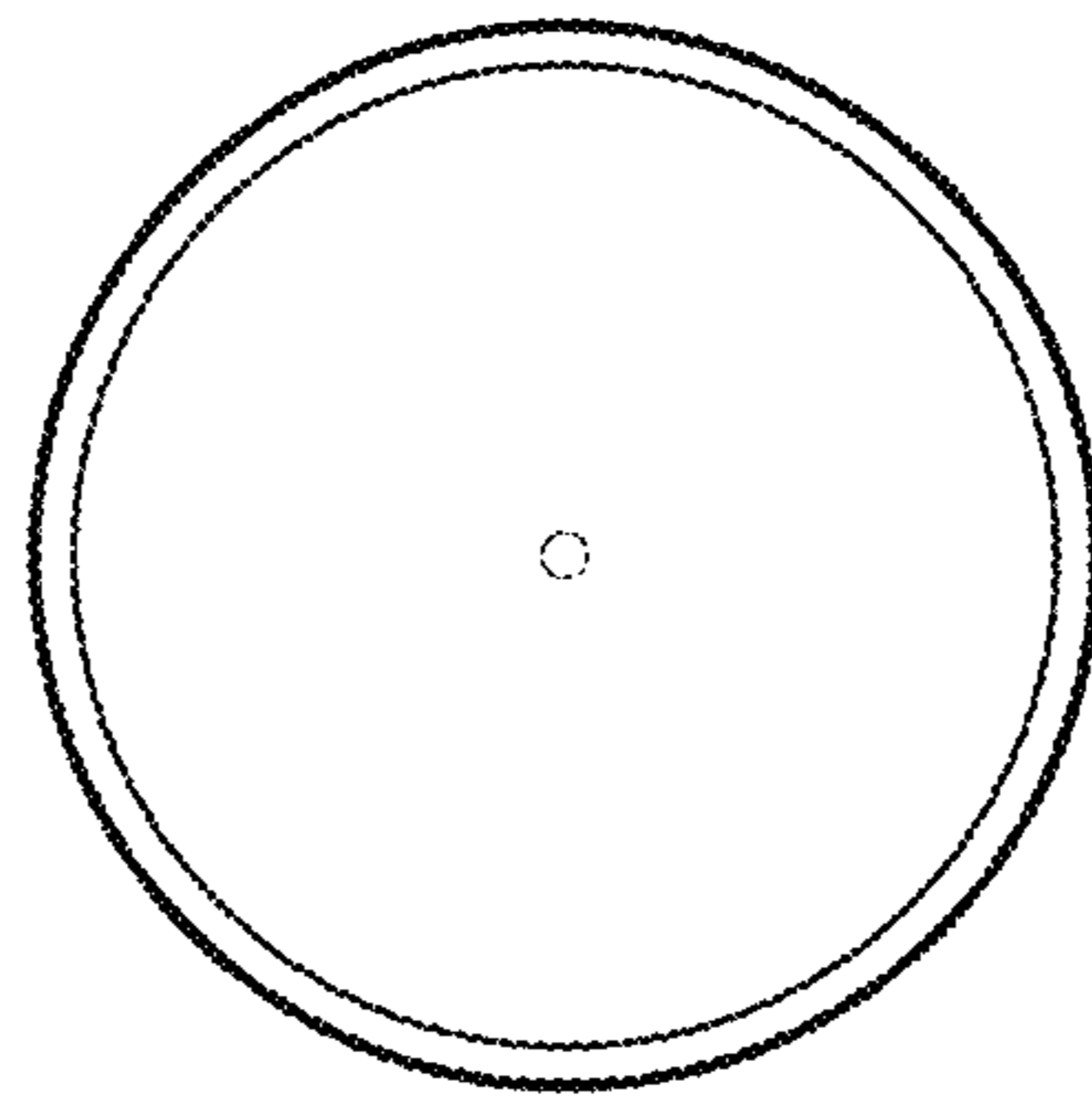

FIG. 8

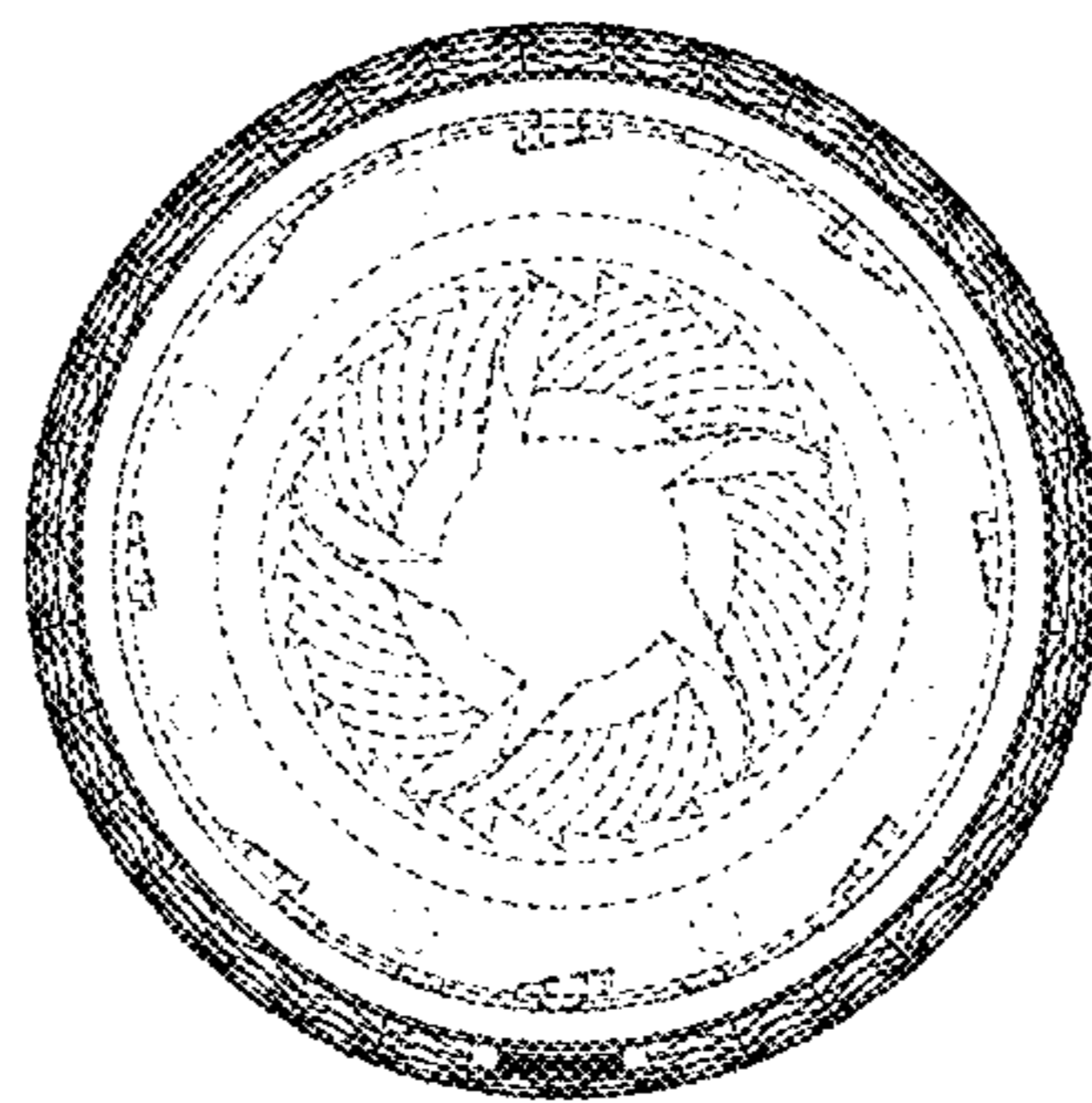

FIG. 9

