



US00D988770S

(12) **United States Design Patent**
Cosgarea et al.

(10) **Patent No.:** **US D988,770 S**
(45) **Date of Patent:** **** Jun. 13, 2023**

- (54) **FRENCH PRESS**
- (71) Applicant: **Fellow Industries, Inc.**, San Francisco, CA (US)
- (72) Inventors: **Andrew Cosgarea**, San Francisco, CA (US); **Yulian Bagirov**, Middletown, RI (US)
- (73) Assignee: **Fellow Industries, Inc.**, San Francisco, CA (US)

D691,409 S *	10/2013	Dichraff	D7/317
D783,334 S *	4/2017	Kotani	D7/317
D787,876 S *	5/2017	Thurlow	D7/317
D802,449 S *	11/2017	Kim	D10/46.2
D814,222 S *	4/2018	Bronwasser	D7/318
D817,065 S *	5/2018	Chen	D7/318
D833,196 S *	11/2018	Mutch	D7/318
D869,892 S *	12/2019	Zou	D7/318
D871,820 S *	1/2020	Zou	D7/318
D889,182 S *	7/2020	Zhang	D7/318
D889,895 S *	7/2020	Chen	D7/318
2016/0287002 A1 *	10/2016	Van Breugel	A23F 3/18
2017/0354278 A1 *	12/2017	Silsby	A47J 45/067

(**) Term: **15 Years**

* cited by examiner

(21) Appl. No.: **29/750,051**

Primary Examiner — Andrew Kerr

(22) Filed: **Sep. 10, 2020**

(74) *Attorney, Agent, or Firm* — Morgan, Lewis & Bockius LLP

(51) **LOC (14) Cl.** **07-01**

(52) **U.S. Cl.**

USPC **D7/318**

(58) **Field of Classification Search**

USPC D7/300, 312, 316–318, 321, 322, 393,
D7/395, 396, 397, 399, 400, 590, 598,
D7/600; D9/435, 544, 545, 549

CPC A47G 19/12; A47G 19/14; A47G 19/16;
A47G 19/22; A47J 31/00; A47J 27/21;
A47J 27/21008

See application file for complete search history.

(56) **References Cited**

U.S. PATENT DOCUMENTS

5,632,194 A *	5/1997	Lin	A47J 31/02 99/285
D557,978 S *	12/2007	Bodum	D7/397
D603,647 S *	11/2009	Bodum	D7/317

(57) **CLAIM**

An ornamental design for a French press, as shown and described.

DESCRIPTION

FIG. 1 is a top perspective view of a French press, showing our new design;
FIG. 2 is a side perspective view of the French press;
FIG. 3 is a side view of the French press;
FIG. 4 is a front view of the French press;
FIG. 5 is a back view of the French press;
FIG. 6 is a top aerial view of the French press; and,
FIG. 7 is a bottom view of the French press.

The broken lines in the drawings depict portions of the French press that form no part of the claimed design.

1 Claim, 7 Drawing Sheets

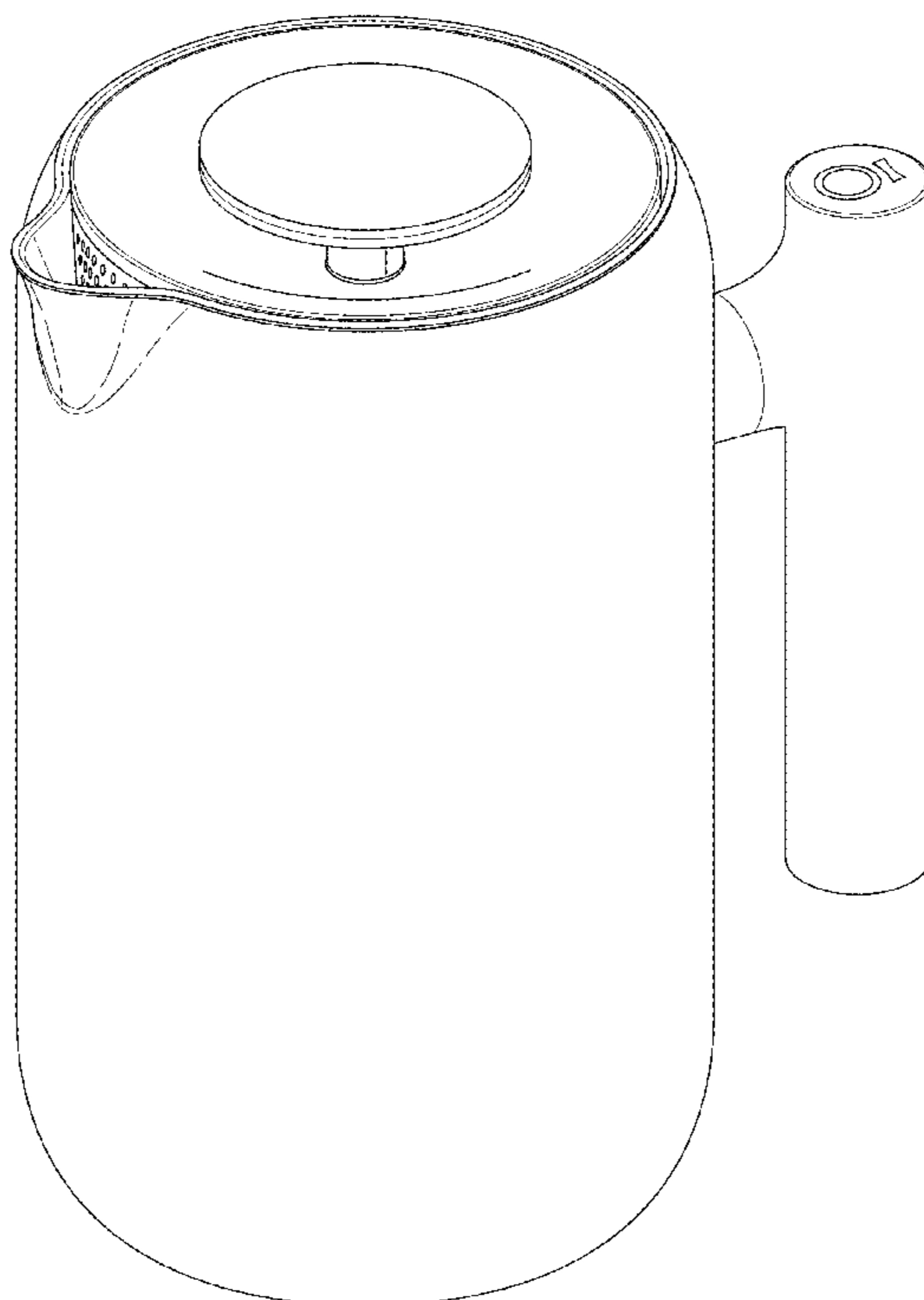

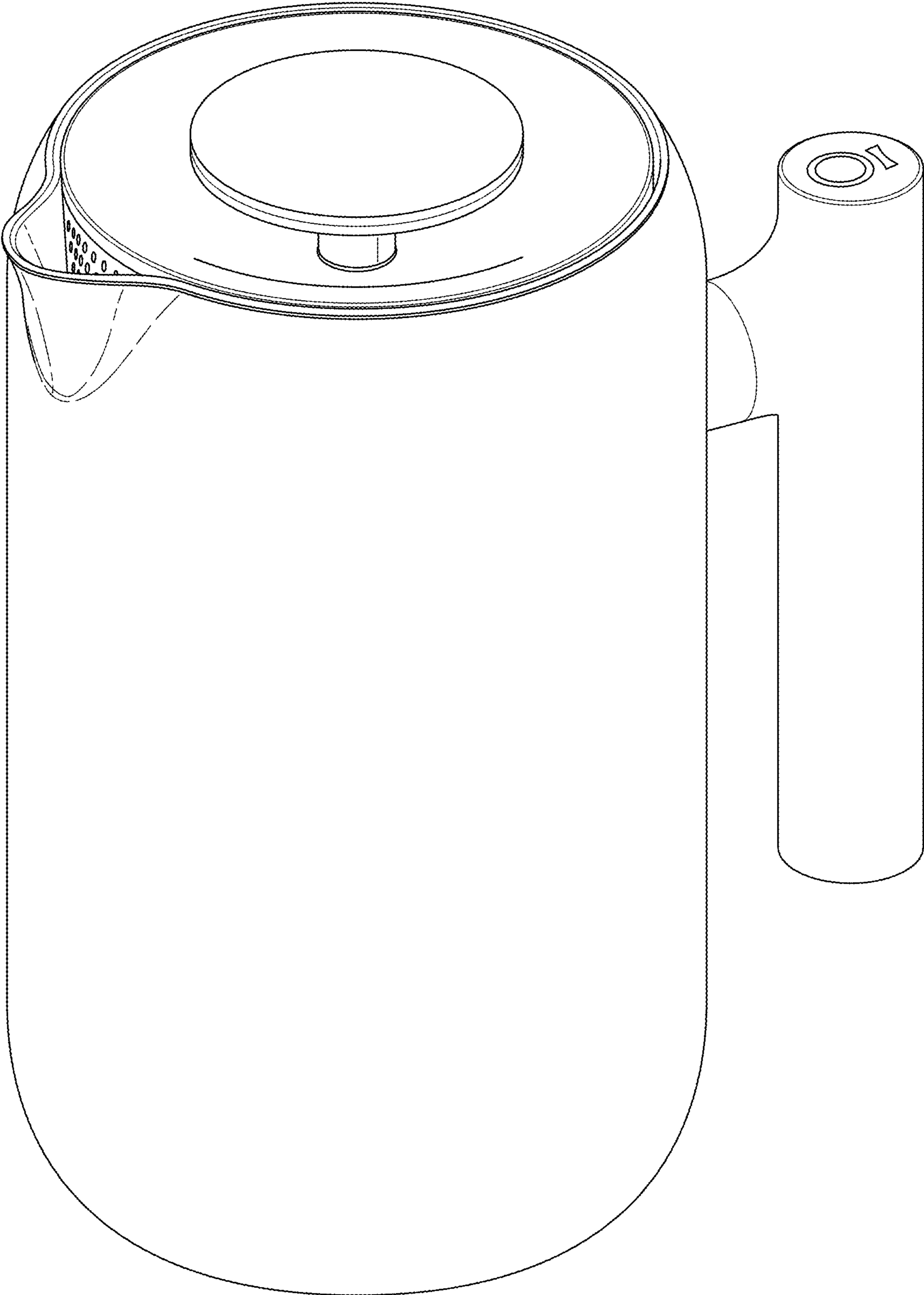

Figure 1

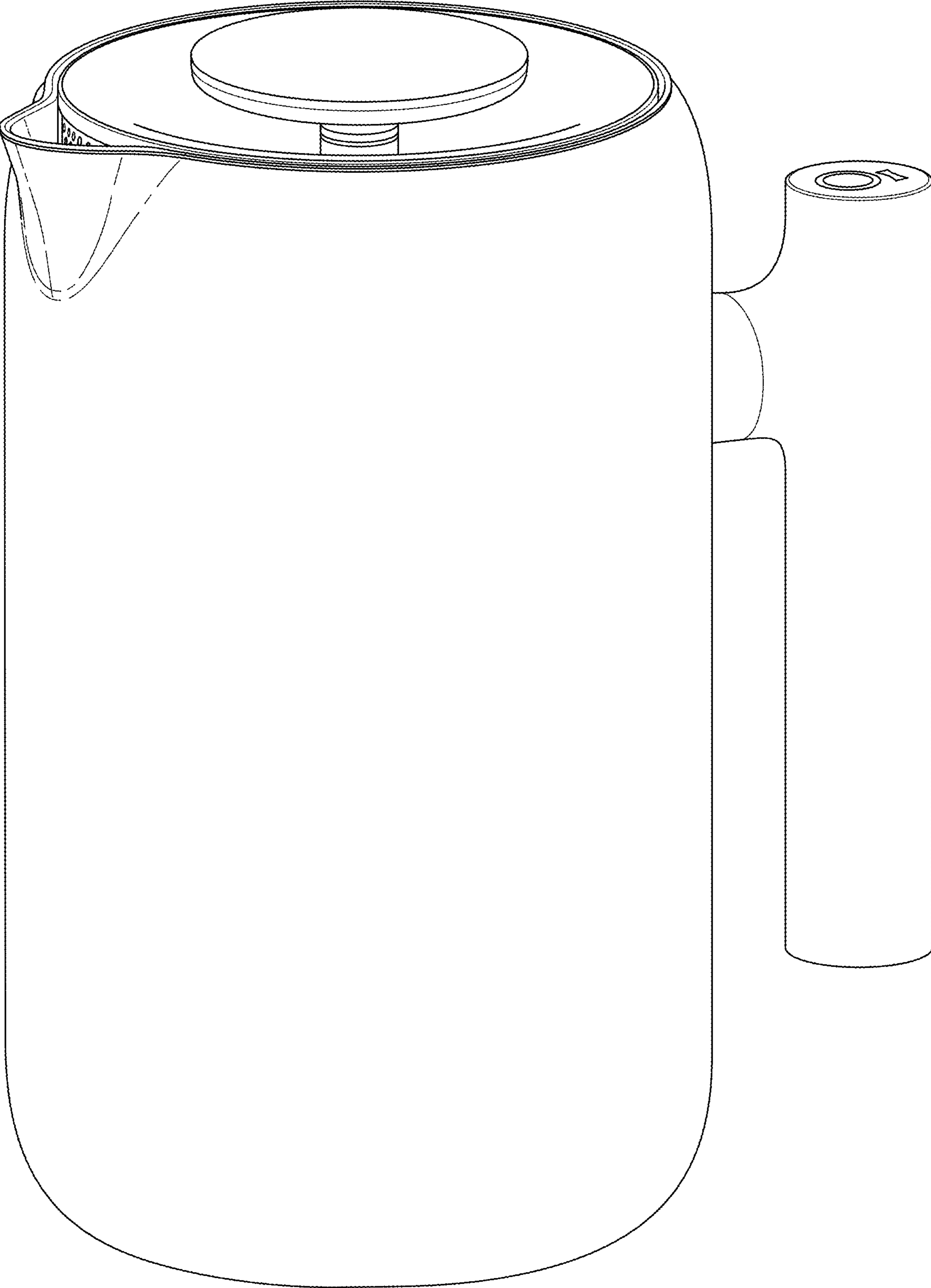

Figure 2

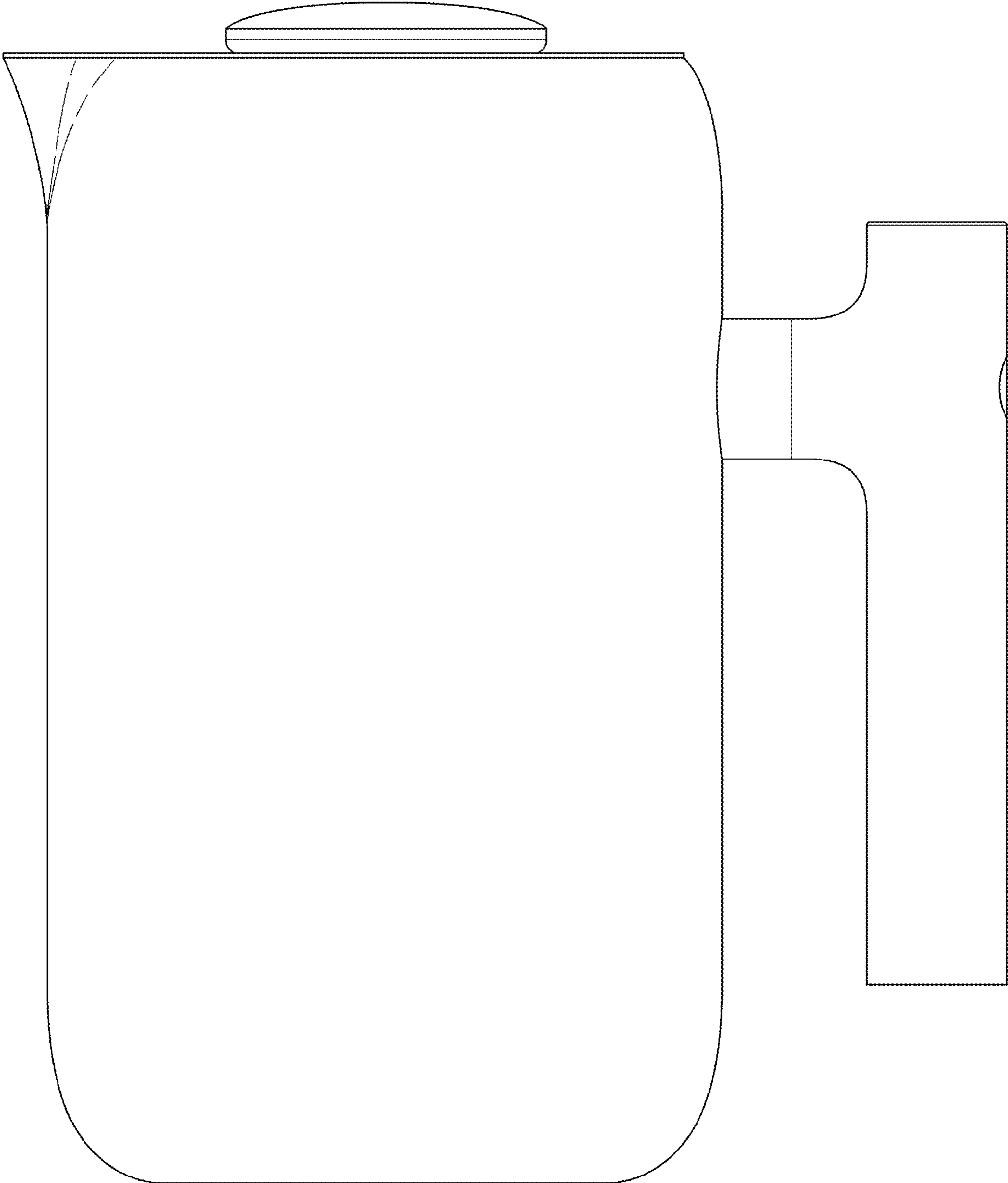

Figure 3

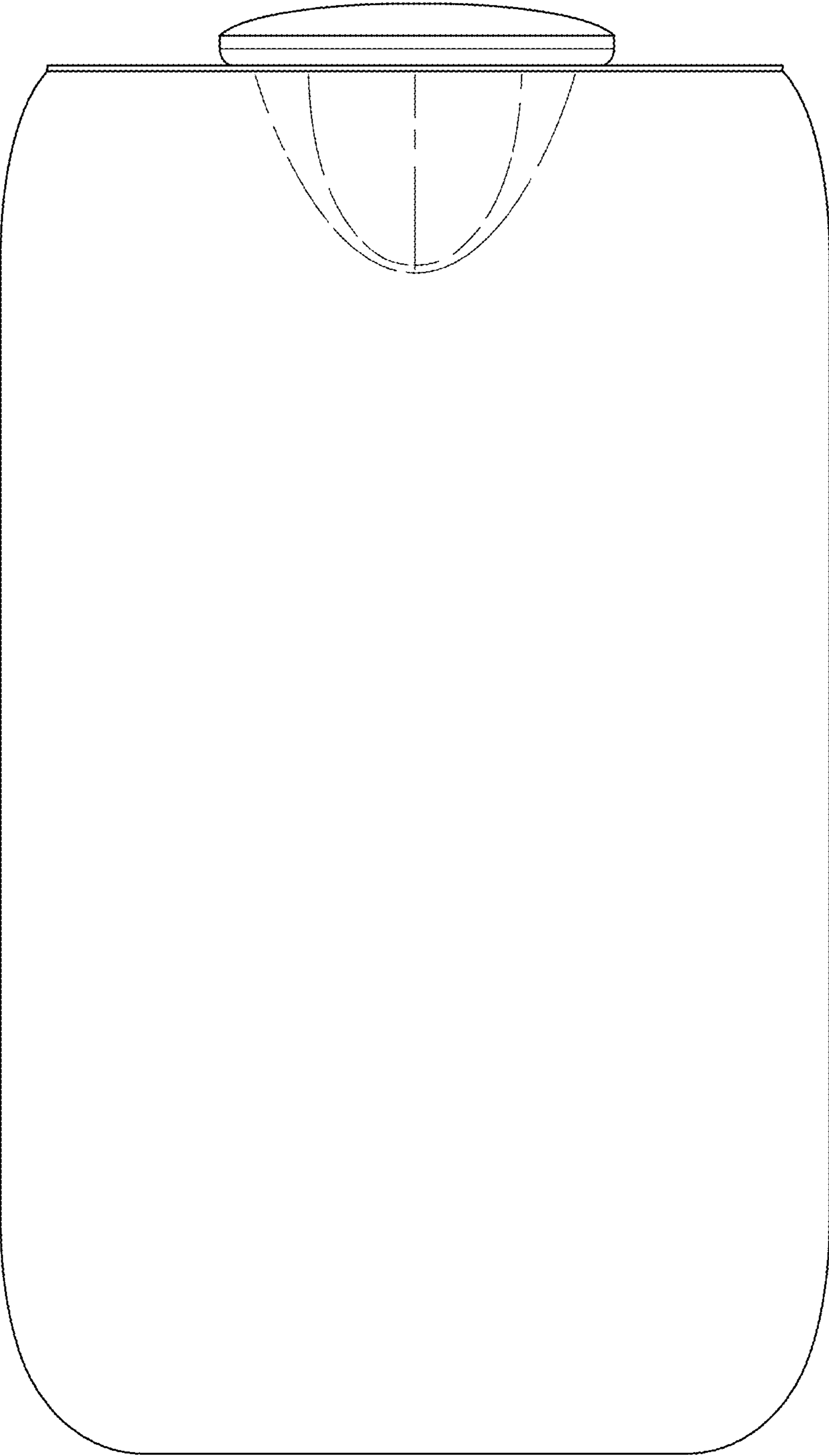

Figure 4

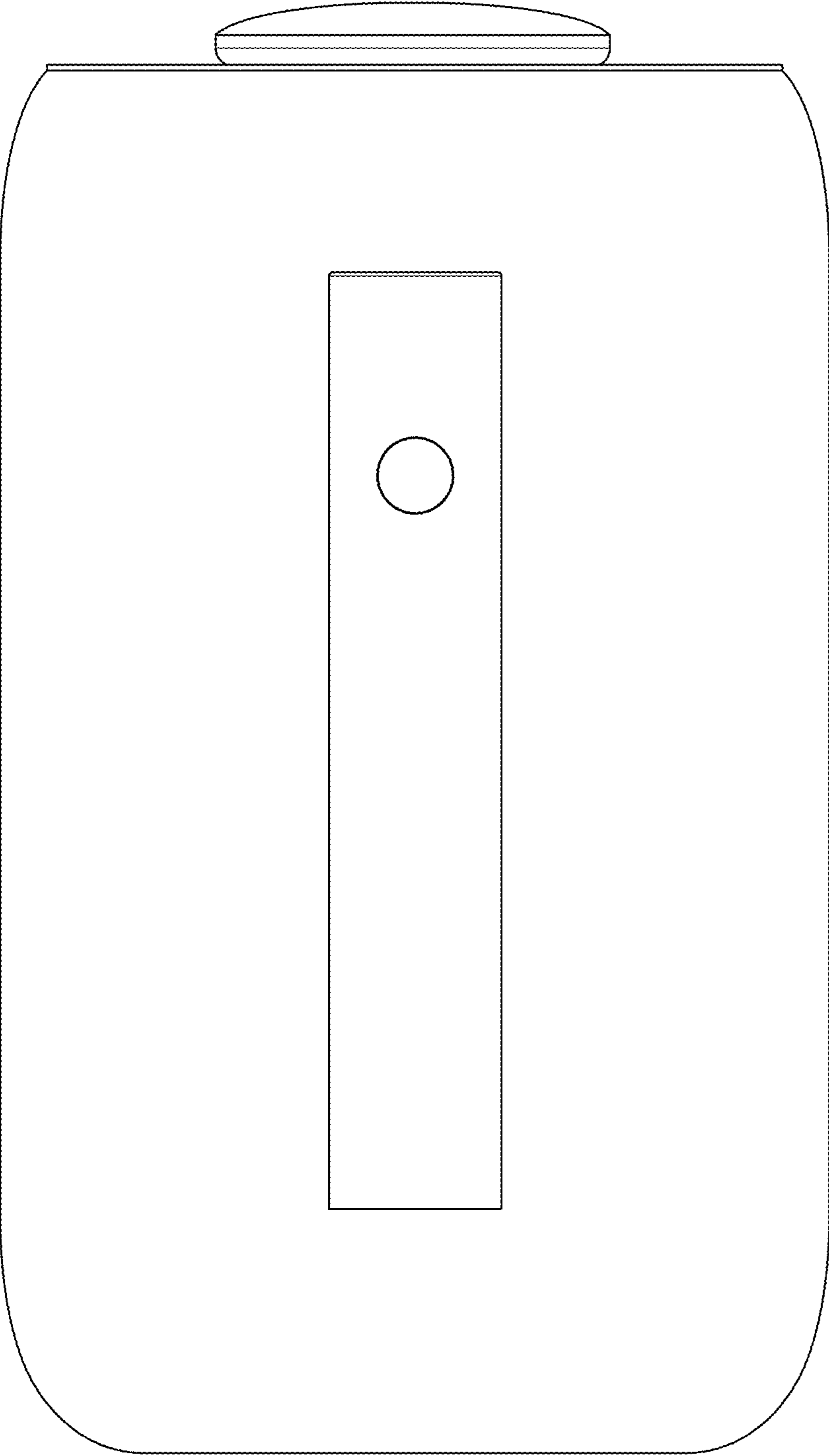

Figure 5

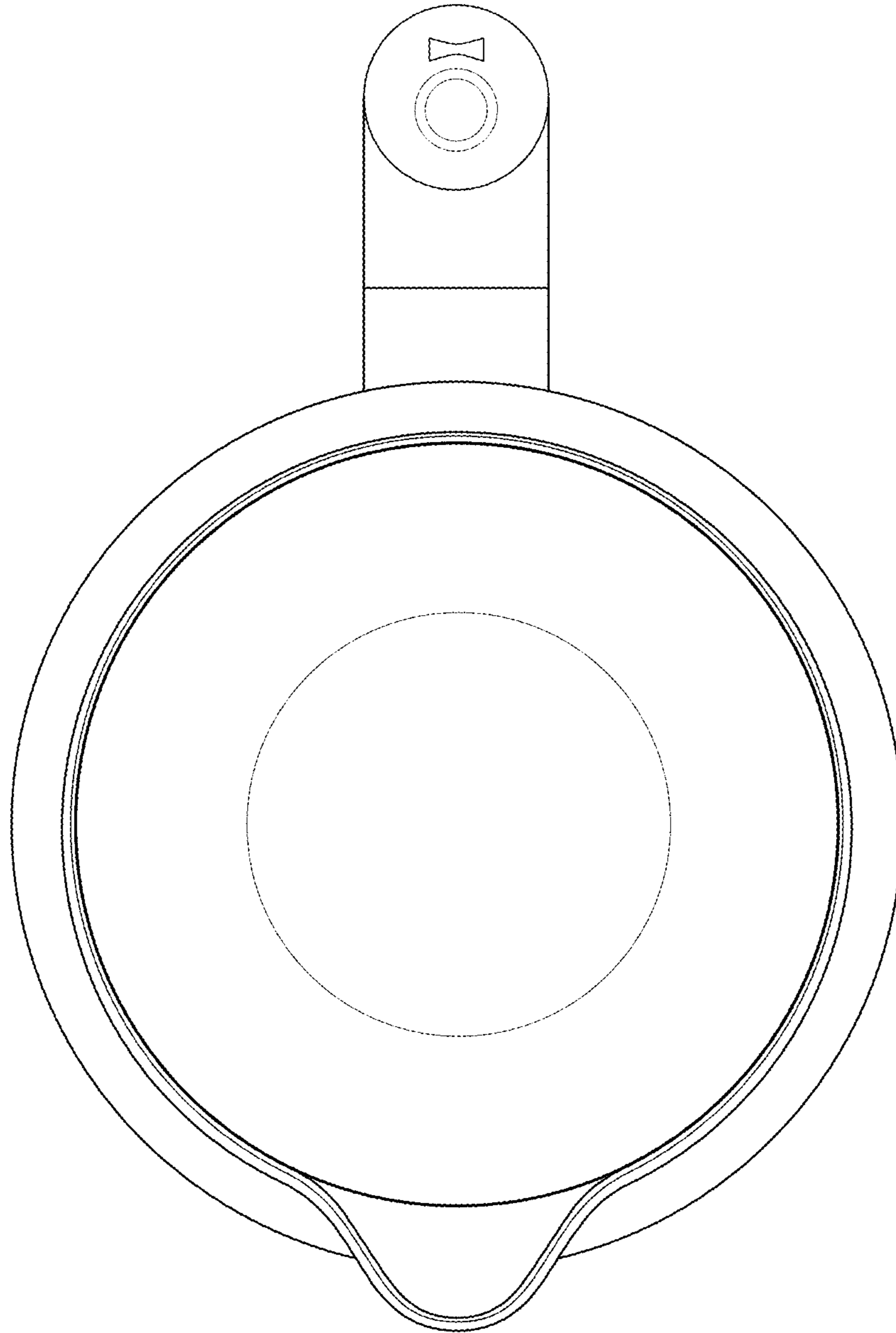

Figure 6

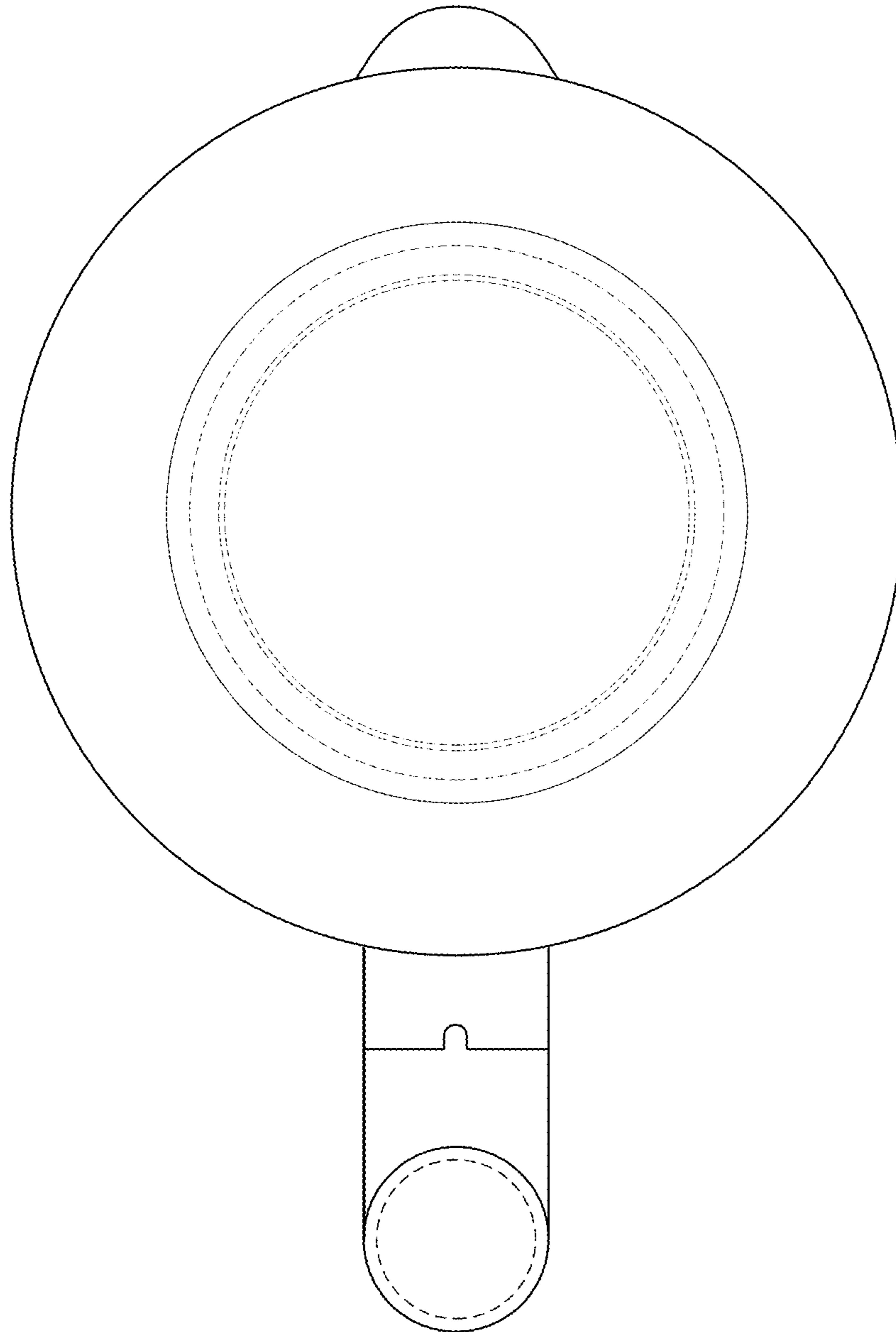

Figure 7