



US00D988766S

(12) **United States Design Patent**  
**Nichols**

(10) **Patent No.:** **US D988,766 S**  
(45) **Date of Patent:** **\*\* Jun. 13, 2023**

(54) **TABLE**

(71) Applicant: **Yardbird Outside, LLC**, Austin, TX  
(US)

(72) Inventor: **Steve Charles Nichols**, Austin, TX  
(US)

(73) Assignee: **Yardbird Outside, LLC**, Driftwood,  
TX (US)

(\*\*) Term: **15 Years**

(21) Appl. No.: **29/799,027**

(22) Filed: **Jul. 12, 2021**

(51) **LOC (14) Cl.** ..... **06-03**

(52) **U.S. Cl.**  
USPC ..... **D6/690**

(58) **Field of Classification Search**  
USPC ..... D6/349, 672, 685, 686, 690, 691,  
D6/691.1–691.9  
CPC ..... A47B 7/00; A47B 13/00; A47B 13/02;  
A47B 13/04; A47B 13/06; A47B 13/08;  
A47B 13/12; A47B 13/21; A47B  
2200/0001; A47B 2200/0011; A47B  
2200/002

See application file for complete search history.

(56) **References Cited**

**U.S. PATENT DOCUMENTS**

D600,944 S \* 9/2009 McConnell ..... D6/675  
D789,713 S \* 6/2017 Velez ..... D6/691  
D840,181 S \* 2/2019 Bougay ..... D6/689  
D854,362 S \* 7/2019 Fentress ..... D6/691.3

**OTHER PUBLICATIONS**

Mid Century Modern Side End Table by Jack Van der Molen—  
Picked Vintage <https://pickedvintage.com/2017/04/30/mid-century-modern-side-end-table/> retrieved from the internet on Jan. 9, 2023.\*

\* cited by examiner

*Primary Examiner* — Mary Ann Calabrese

(74) *Attorney, Agent, or Firm* — Banner & Witcoff, Ltd.

(57) **CLAIM**

The ornamental design for a table, as shown and described.

**DESCRIPTION**

FIG. 1 is a front perspective view of a table showing my new design;  
FIG. 2 is a side view thereof;  
FIG. 3 is an opposite side view thereof;  
FIG. 4 is a front view thereof;  
FIG. 5 is a rear view thereof;  
FIG. 6 is a top view thereof; and,  
FIG. 7 is a bottom view thereof.

The broken lines immediately adjacent to the shaded area define the bounds of the claimed design and form no part thereof. The broken lines depicting the remainder of the table form no part of the claimed design.

**1 Claim, 7 Drawing Sheets**

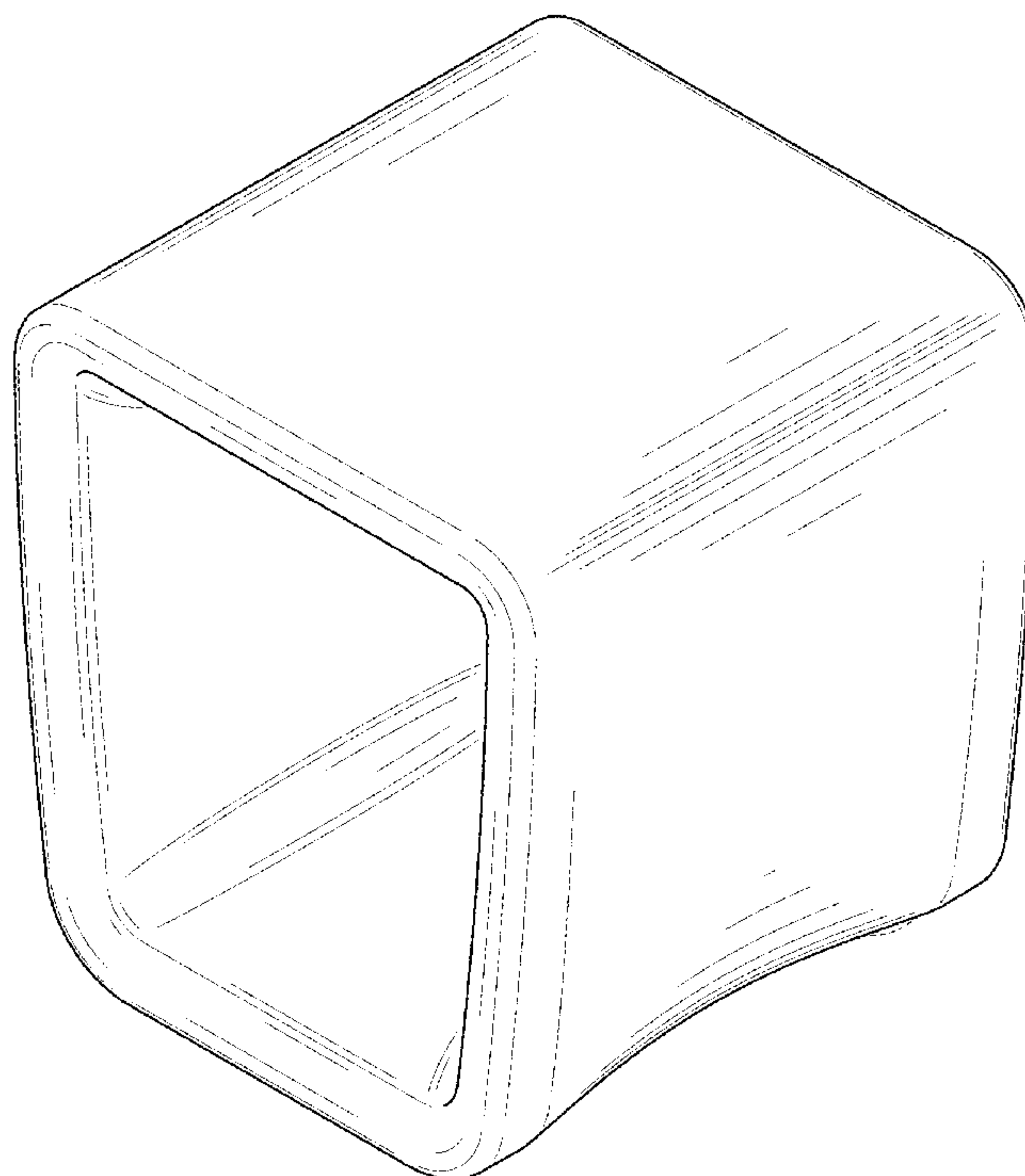

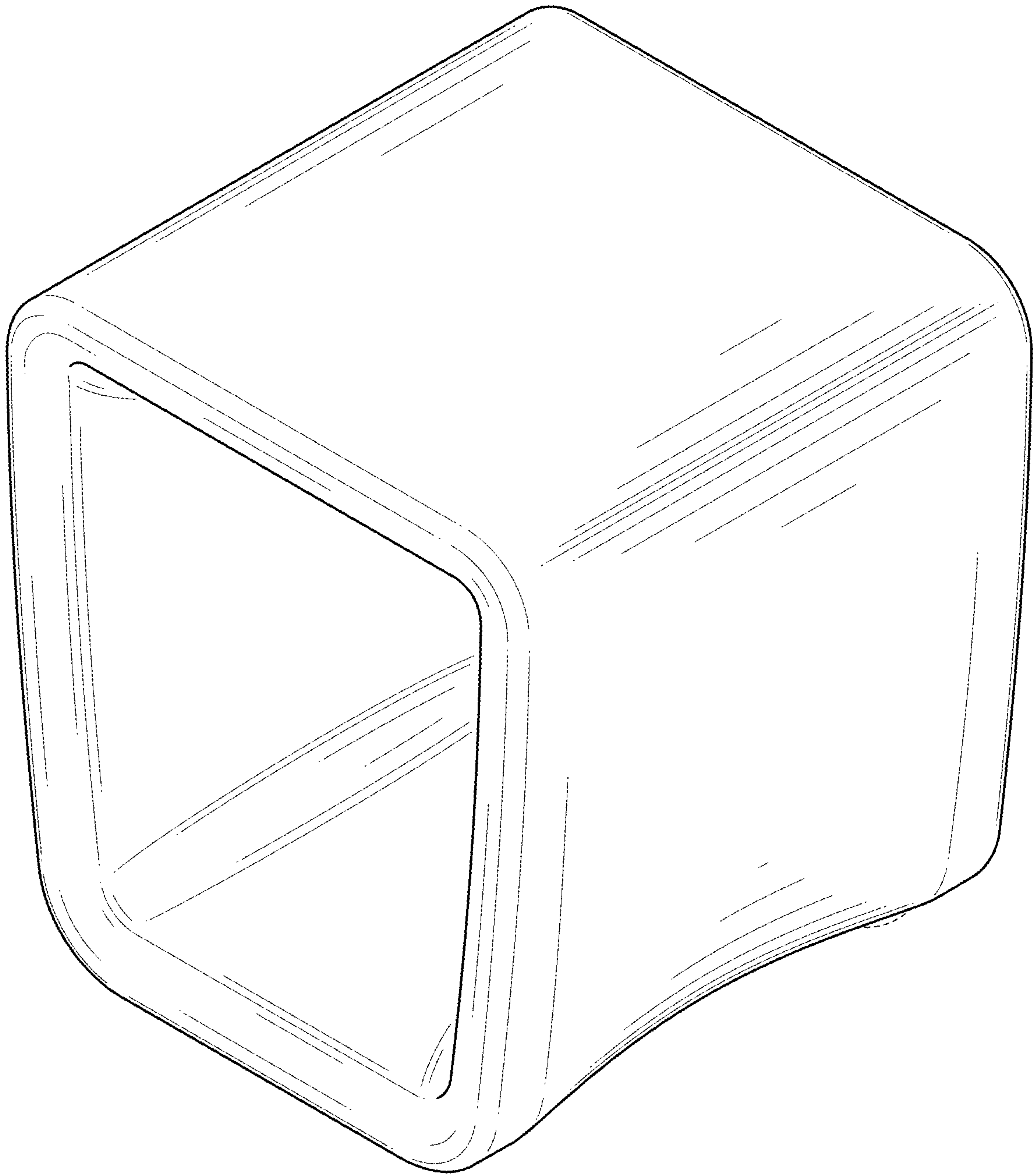

FIG. 1

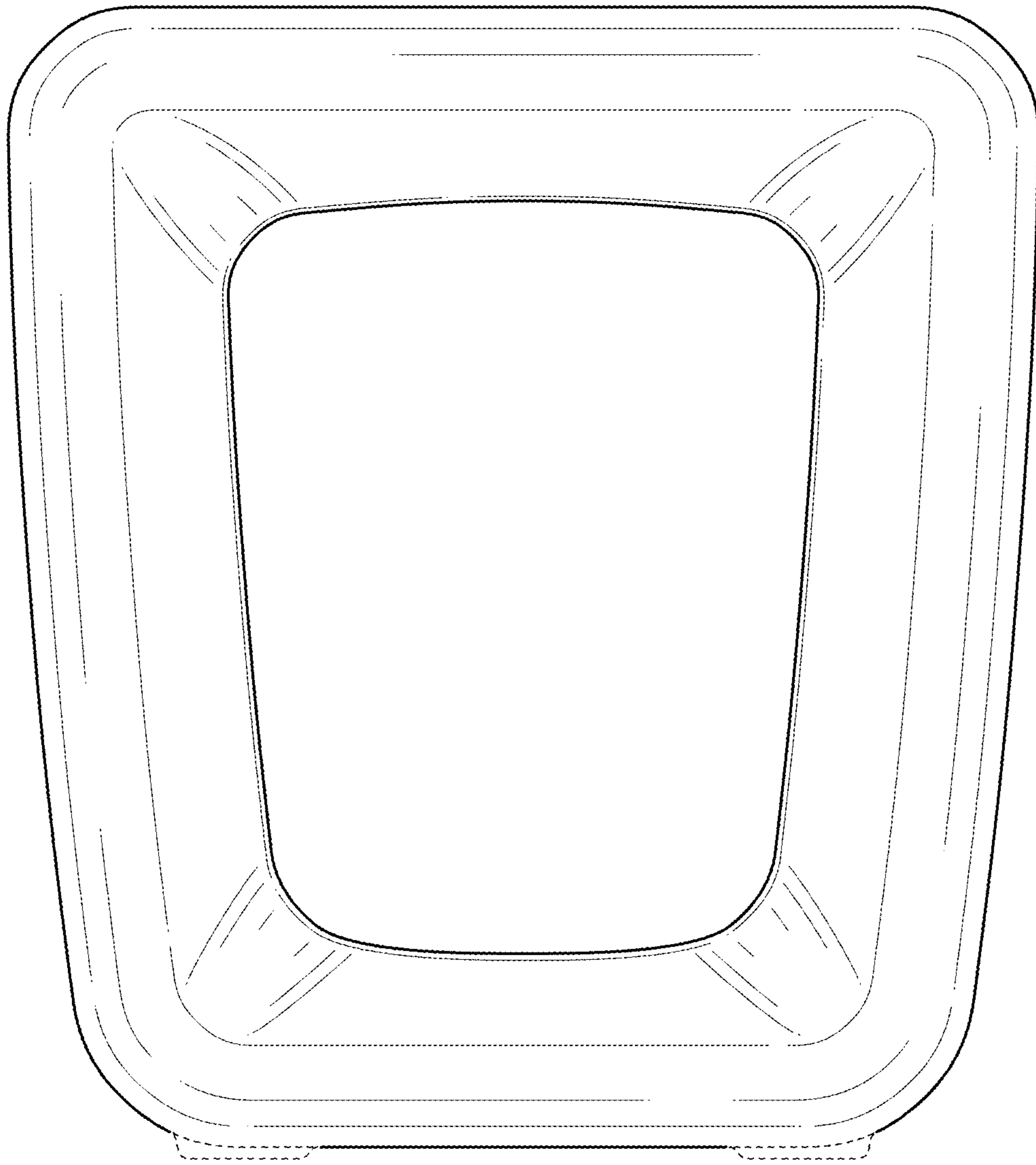

FIG. 2

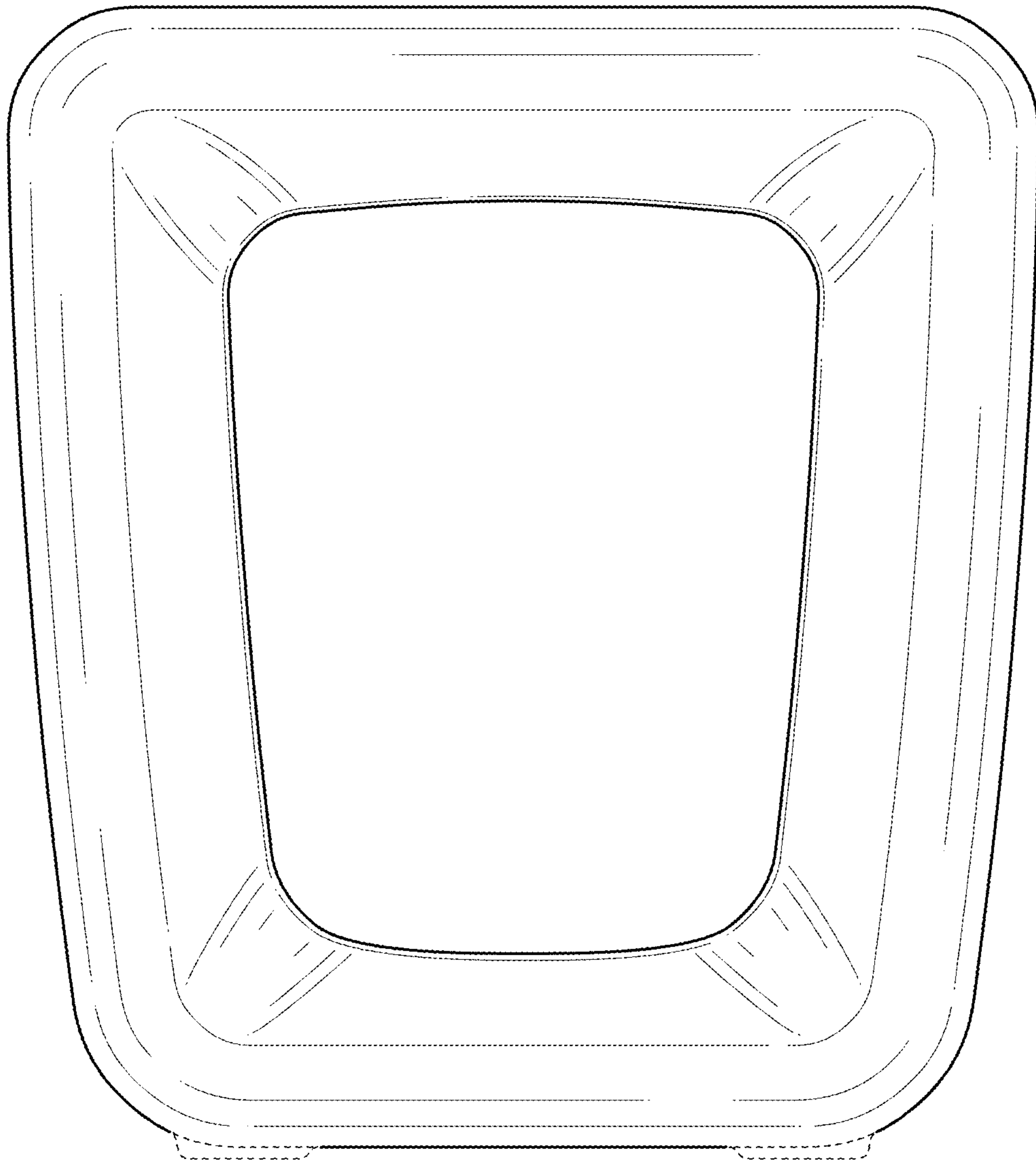

FIG. 3

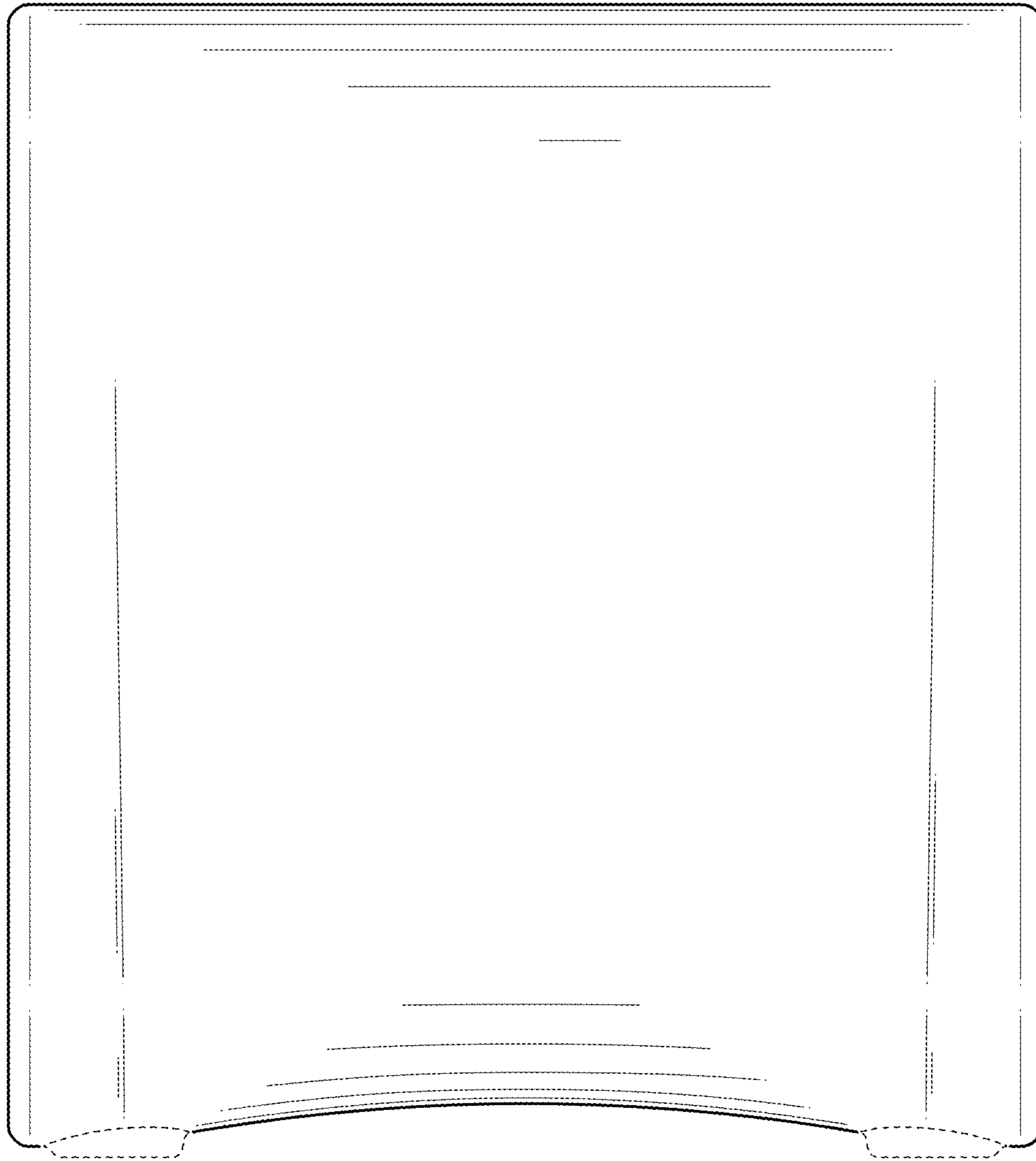

FIG. 4

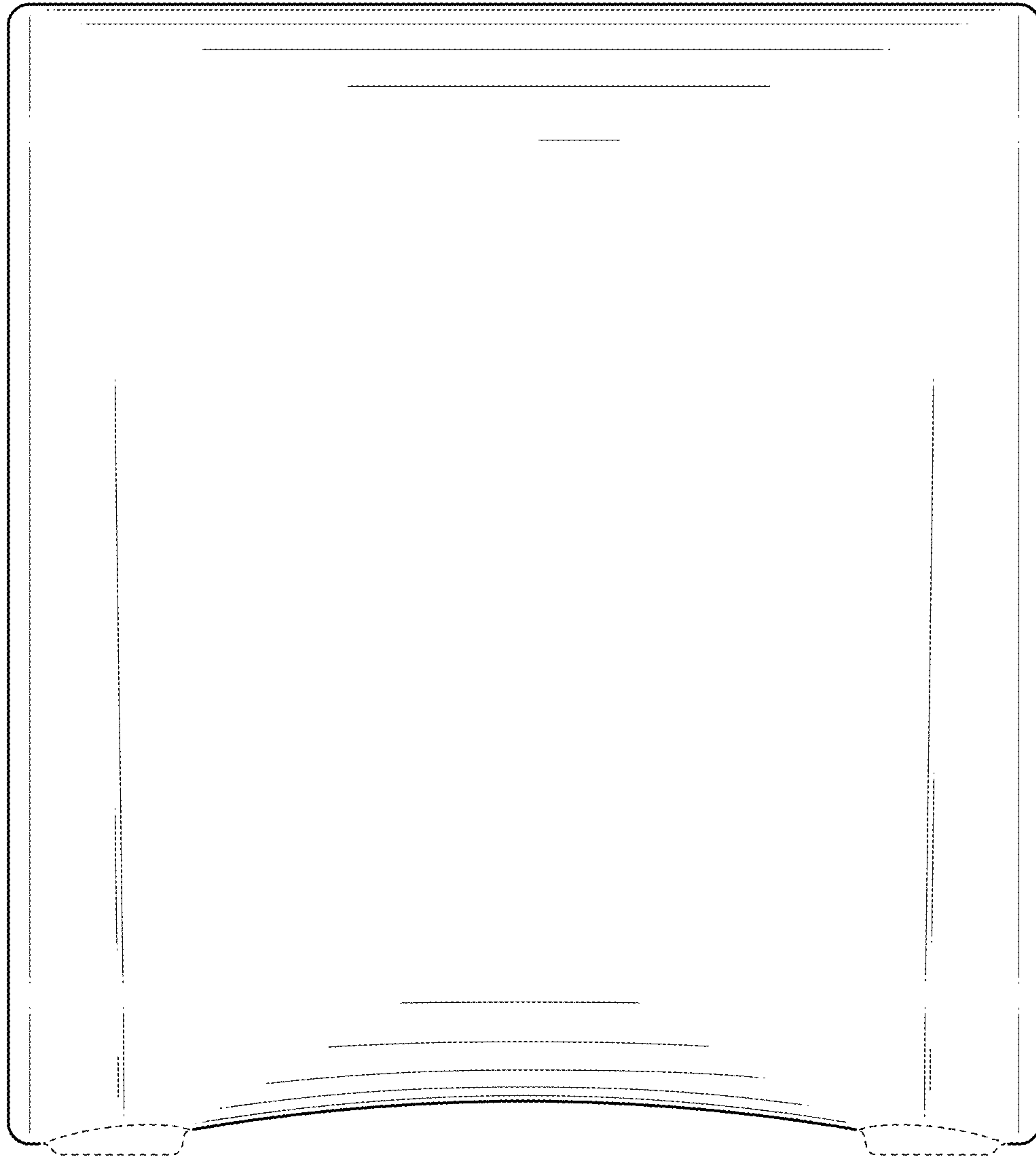

FIG. 5

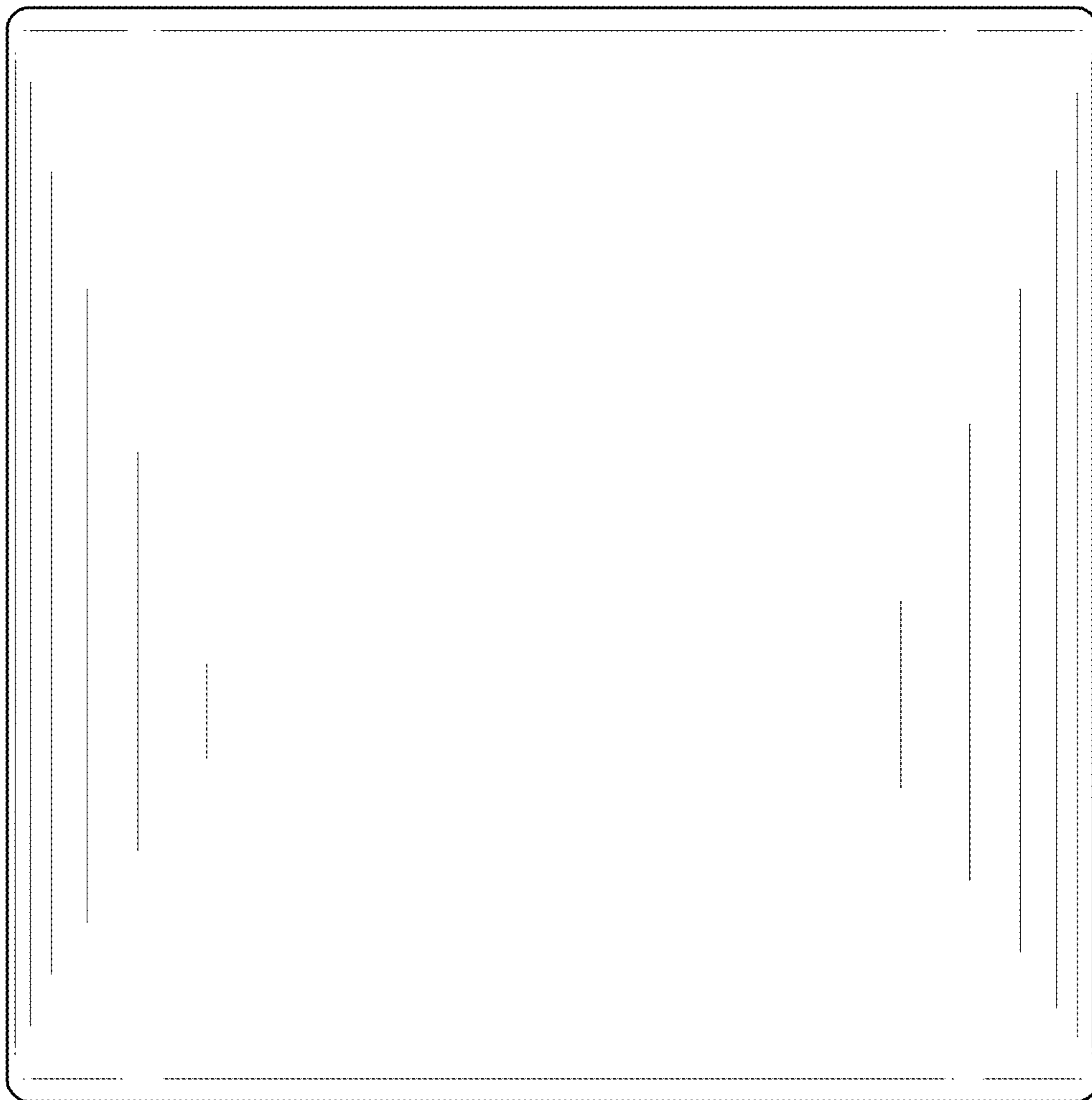

FIG. 6



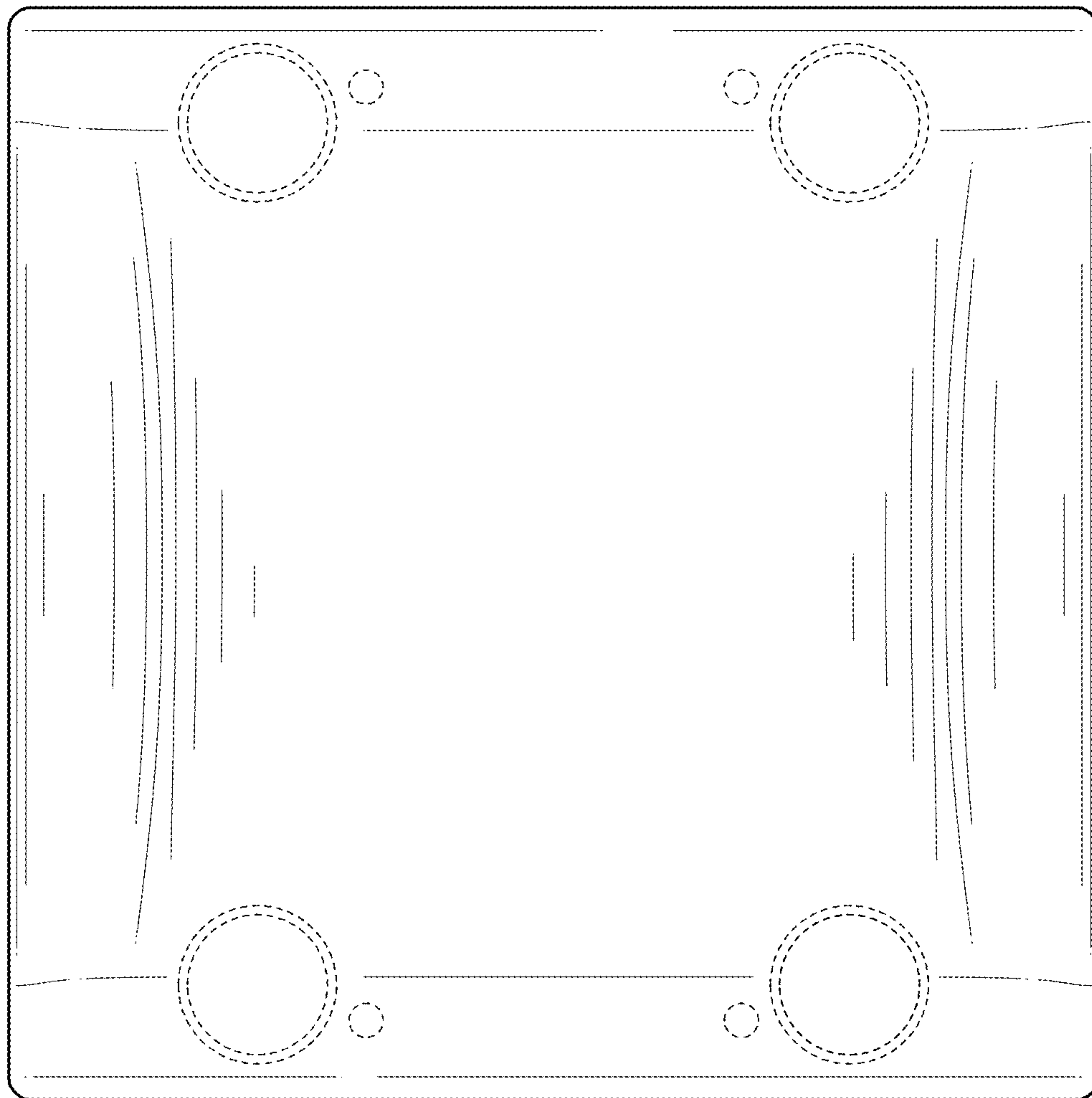

FIG. 7