



US00D988751S

(12) **United States Design Patent** (10) **Patent No.:** **US D988,751 S**  
**Sisto** (45) **Date of Patent:** **\*\* Jun. 13, 2023**

(54) **SHELF**  
(71) Applicant: **Salto, LLC**, Philadelphia, PA (US)  
(72) Inventor: **Salvatore Sisto**, East Brunswick, NJ (US)  
(73) Assignee: **Salto, LLC**  
(\*\*) Term: **15 Years**  
(21) Appl. No.: **29/783,433**  
(22) Filed: **May 13, 2021**

D764,834 S 8/2016 Citterio  
D778,072 S 2/2017 Sandgrund  
D778,645 S \* 2/2017 Merritt ..... D6/691  
D780,488 S \* 3/2017 Celano ..... D6/675  
D787,701 S \* 5/2017 Wilson ..... D24/227  
D802,344 S 11/2017 Bailey  
D805,719 S 12/2017 Kelly  
D838,511 S 1/2019 Kim  
D841,357 S 2/2019 Hu  
D843,761 S 3/2019 Chang  
(Continued)

**Related U.S. Application Data**

(62) Division of application No. 29/673,143, filed on Dec. 12, 2018, now Pat. No. Des. 922,093.  
(51) **LOC (14) Cl.** ..... **06-04**  
(52) **U.S. Cl.**  
USPC ..... **D6/574**  
(58) **Field of Classification Search**  
USPC ..... D2/672; D6/320-324, 553, 574, 672, D6/675, 705; D7/698; D21/686; D26/72  
CPC ..... A47B 43/00; A47B 43/04; A47B 47/0066; A47B 47/04; A47B 63/00; A47B 69/00; A47B 71/00  
See application file for complete search history.

**OTHER PUBLICATIONS**

Etsy: Grey Space Furniture, C Side Table, Wooden C Table, <https://www.etsy.com/listing/892290402/c-side-table-wooden-c-table-c-end-table?pro=1>, Mar. 21, 2021 (Year: 2021).\*

(Continued)

*Primary Examiner* — Jennifer L Rempfer  
*Assistant Examiner* — Bethany Louise Mallino  
(74) *Attorney, Agent, or Firm* — Belles Katz LLC

(57) **CLAIM**

The ornamental design for a shelf, as shown and described.

**DESCRIPTION**

FIG. 1 is a front perspective view of a shelf according to my new design;  
FIG. 2 is a rear perspective view thereof;  
FIG. 3 is a front view thereof;  
FIG. 4 is a rear view thereof;  
FIG. 5 is a left side view thereof, the right side view being a mirror image of the left side view;  
FIG. 6 is a top view thereof; and,  
FIG. 7 is a bottom view thereof.  
The broken lines illustrating portions of the shelf form no part of the claimed design. The dash-dot-broken lines define the bounds of the claimed design and form no part thereof.

(56) **References Cited**

**U.S. PATENT DOCUMENTS**

D267,992 S \* 2/1983 Shelton ..... D6/675  
D289,116 S \* 4/1987 Kando ..... D6/675  
D298,707 S \* 11/1988 Knight ..... D6/675  
D351,845 S 10/1994 Johnson et al.  
D560,400 S \* 1/2008 Austin ..... D6/675  
D600,943 S \* 9/2009 Austin ..... D6/675  
D600,944 S \* 9/2009 McConnell ..... D6/675  
D754,267 S \* 4/2016 Ross ..... D21/686

**1 Claim, 7 Drawing Sheets**

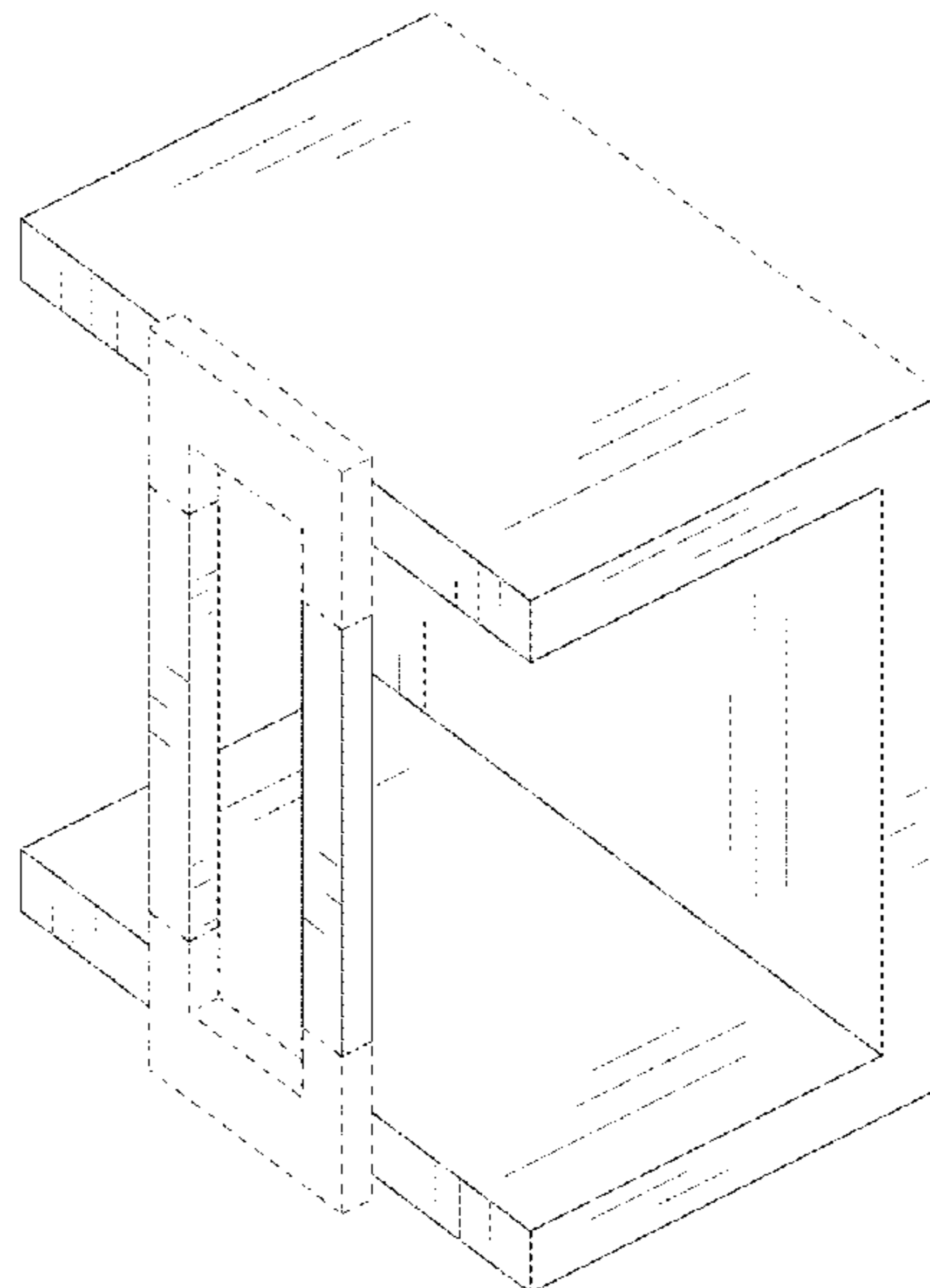

(56)

**References Cited**

## U.S. PATENT DOCUMENTS

10,294,017 B2 \* 5/2019 Farid ..... B65D 85/34  
D853,750 S 7/2019 Theisen  
D897,744 S 10/2020 Silver  
D922,093 S \* 6/2021 Sisto ..... D6/574  
D956,709 S \* 7/2022 Lin ..... D13/117

## OTHER PUBLICATIONS

Wayfair: Bletsoe Floor Shelf C Table, <https://www.apartmenttherapy.com/10-best-space-saving-side-tables-for-small-apartments-241431>, Mar. 2, 2021 (Year: 2021).\*

Hayneedle, Finley Home Hudson C End Table, Published on Internet at: <https://www.hayneedle.com/product/finley-home-hudson-c-table.cfm>; 8 pages; Retrieved Dec. 5, 2018.

Etsy, Double Wall Mounted Shelf Bracket Set, Published on Internet at <https://www.etsy.com/listing/526313831/double-wall-mounted-shelf-bracket-set>; 5 pages; Retrieved Dec. 5, 2018.

C Shape Natural Wood Side Table 3D CGTrader, Published on Internet at <http://www.frequency.com/c-shaped-side-table/picture/7bbd/c-shape-natural-wood-side-table-3d-cgtrader/>; 4 pages; Retrieved Dec. 5, 2018.

Pinterest, C-shaped shelf, cat wall perch by HUVE Collection, Published on <https://www.pinterest.com/pin/180495897545144692/?lp=true>; 3 pages; Retrieved Dec. 5, 2018.

Amazon, C-Shaped Bar Table—Glass Top, Black Laquer4 Base by Diamond Sofa, Published on Internet at <https://www.amazon.com/c-shaped-bar-table-lacquer-diamond/dp/b00bgmvjhe>; 4 pages; Retrieved Dec. 5, 2018.

Winglts, Forza—Floating “C” Shelf, Technical Data Sheet; 2 pages, dated Mar. 2, 2017.

\* cited by examiner

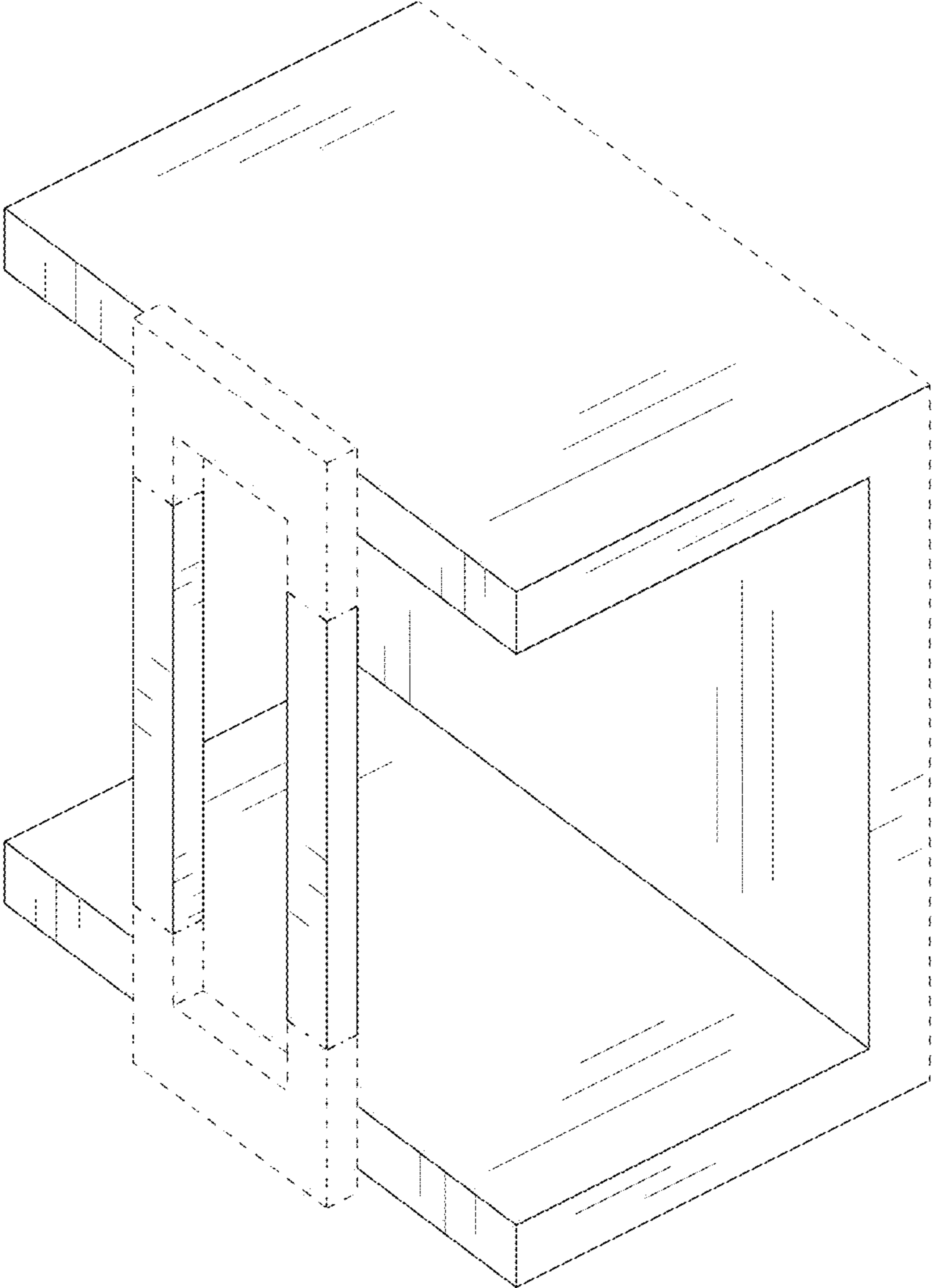

FIG. 1

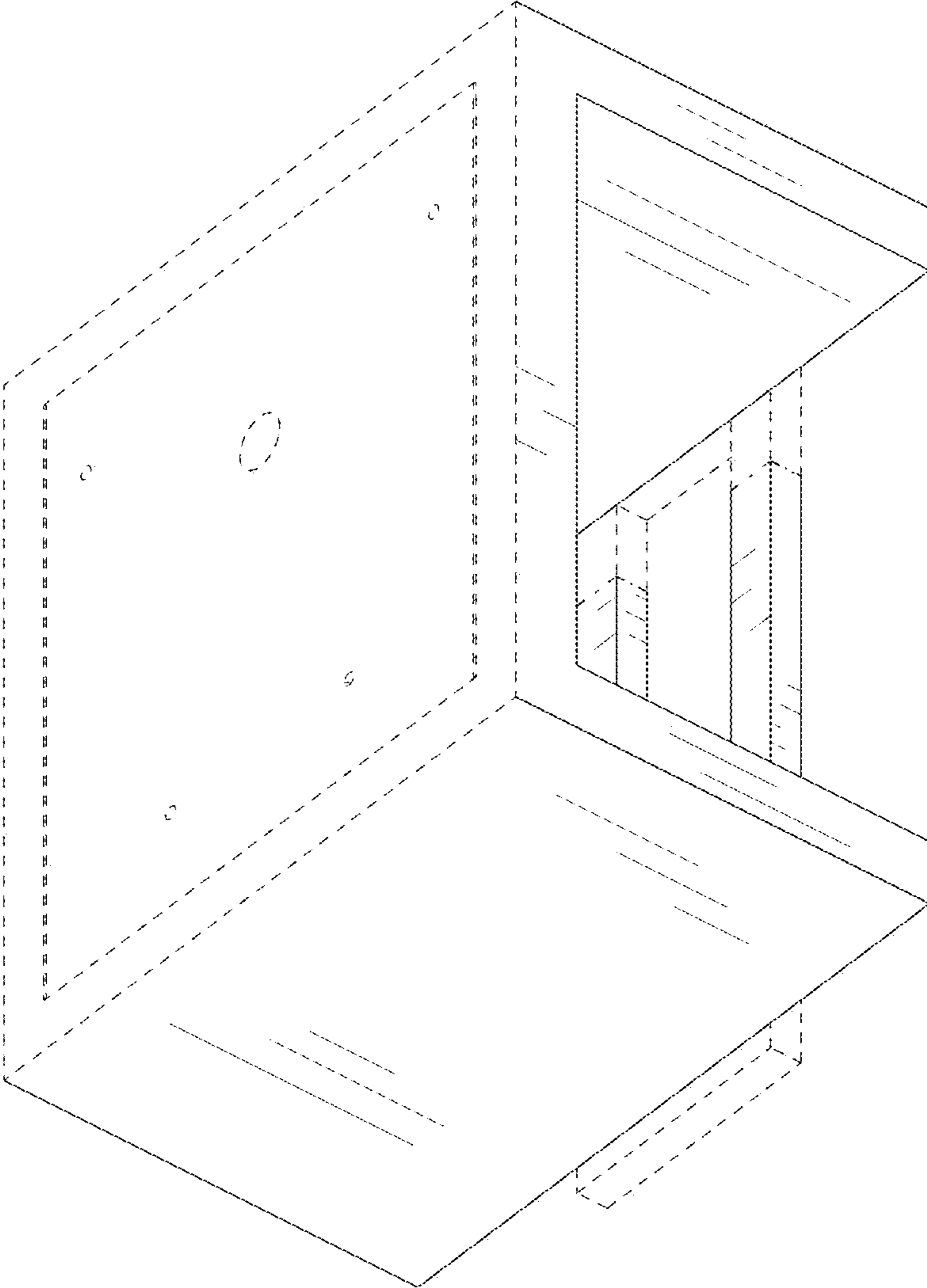

FIG. 2

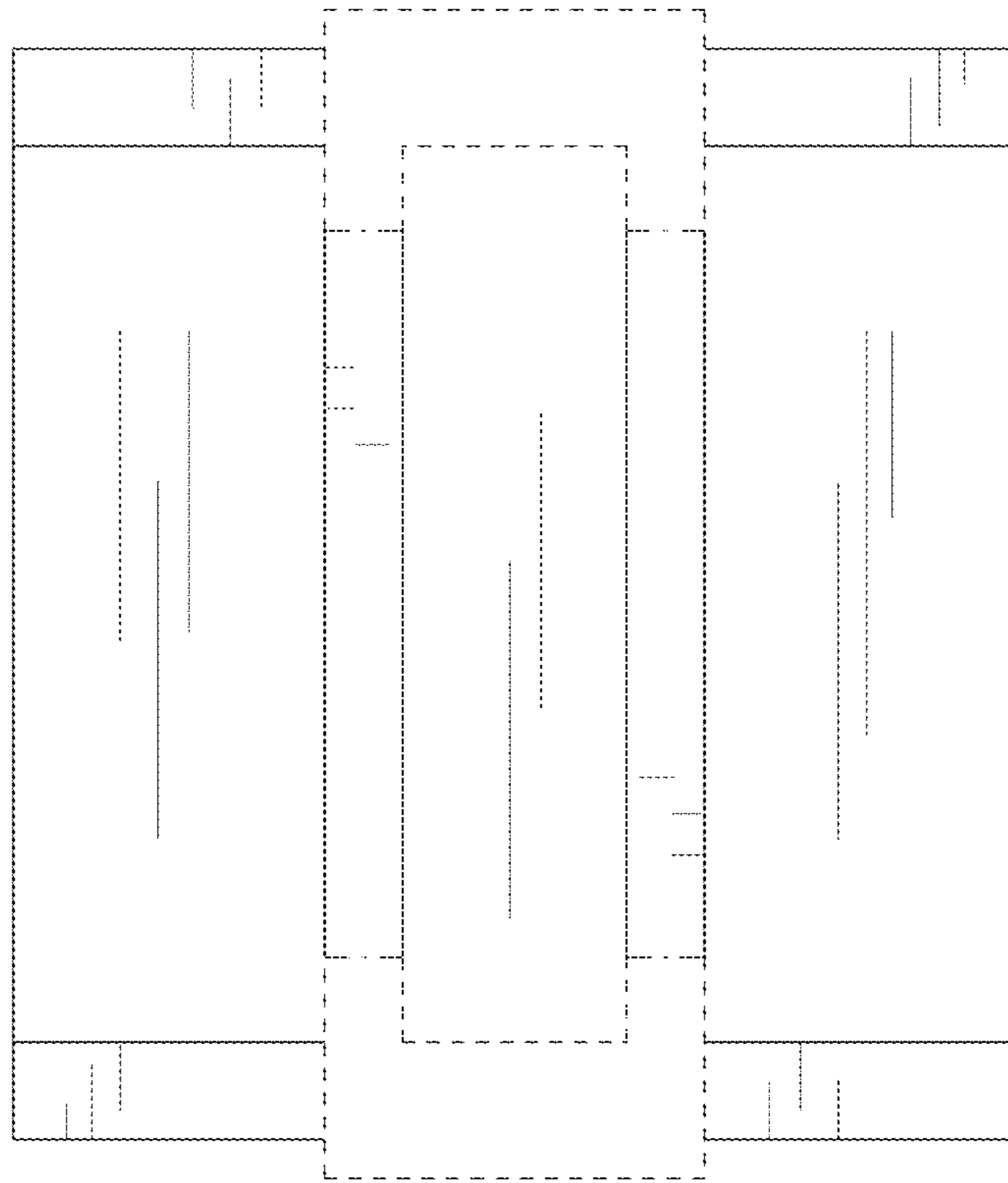

FIG. 3

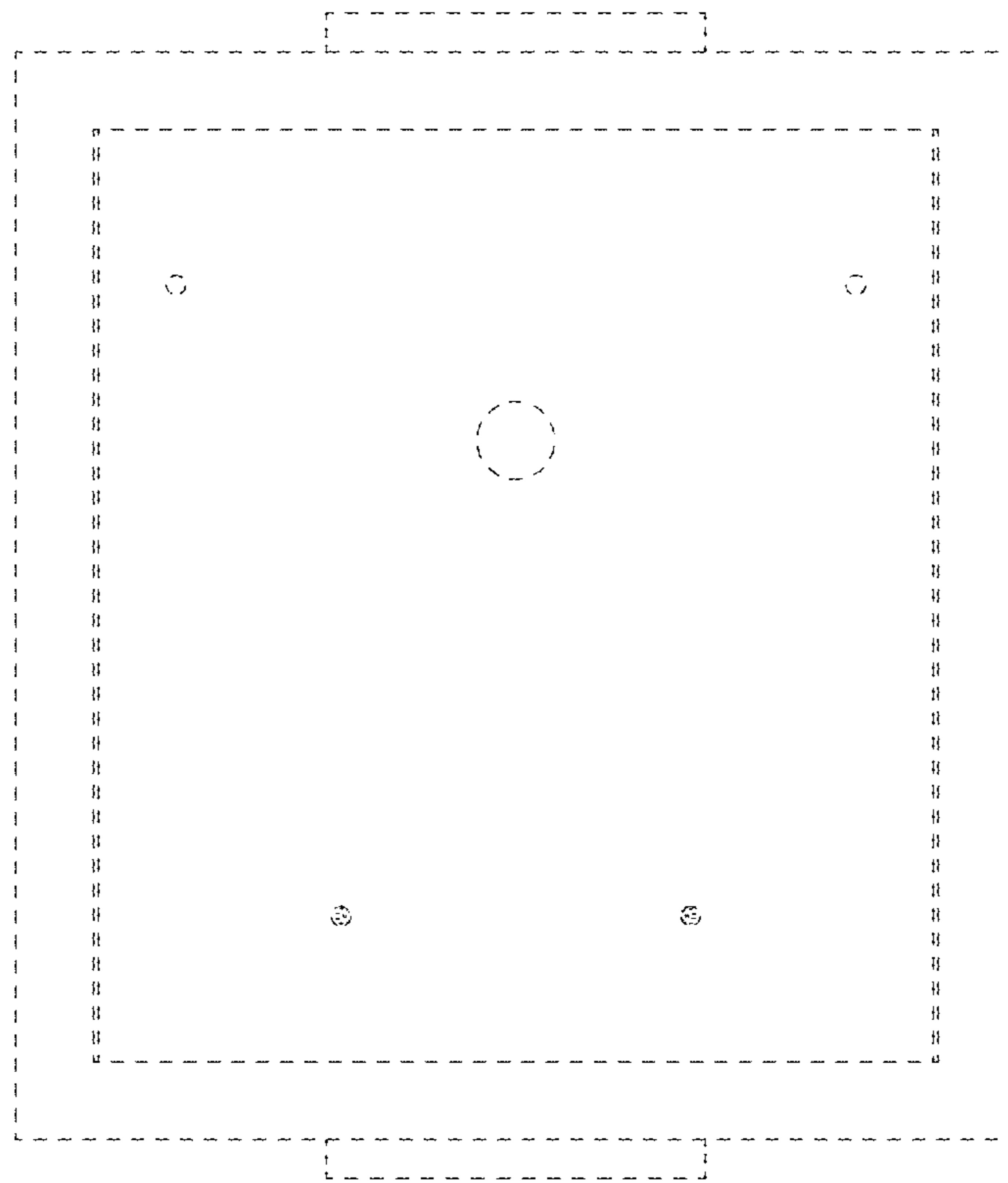

FIG. 4

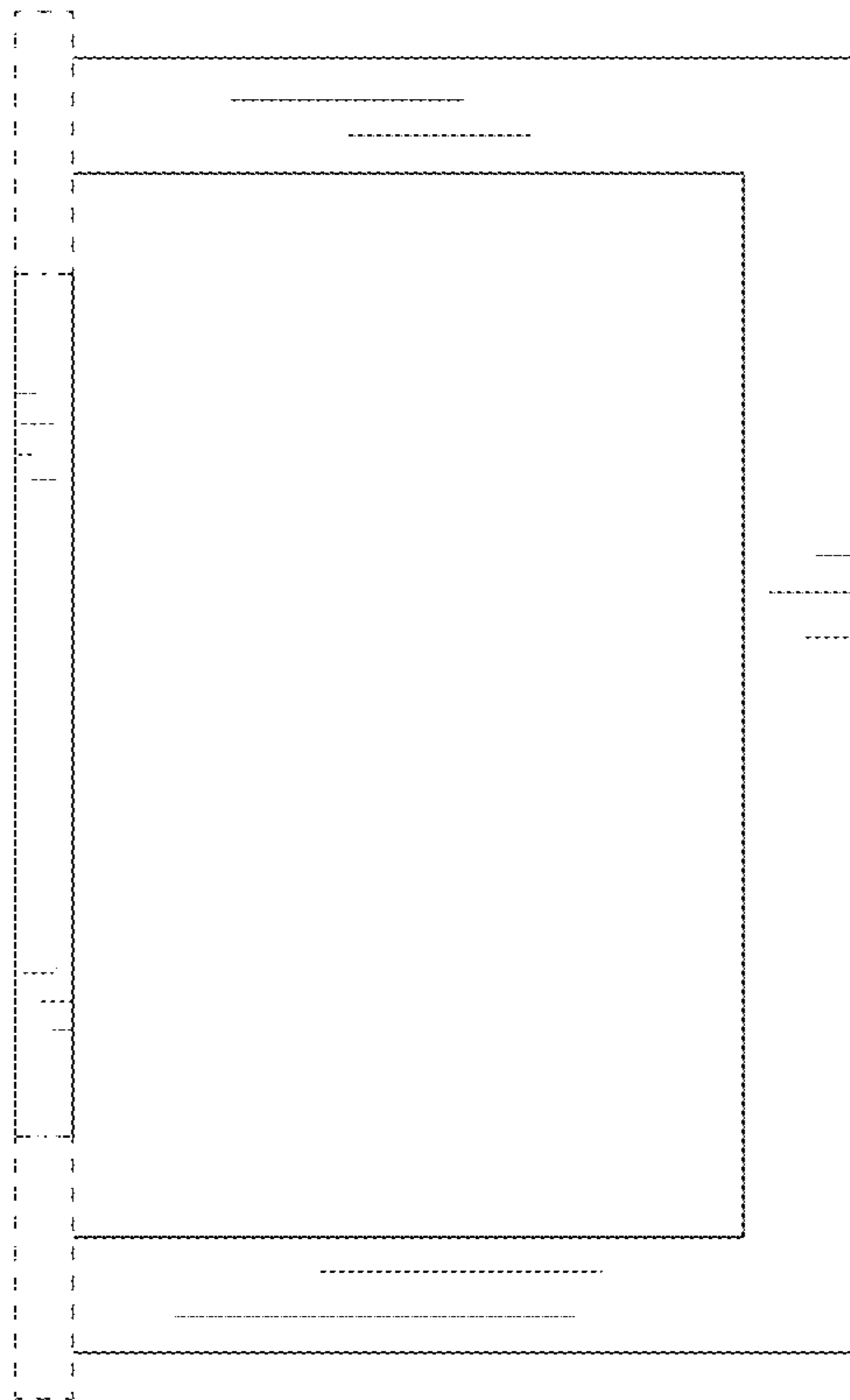

FIG. 5

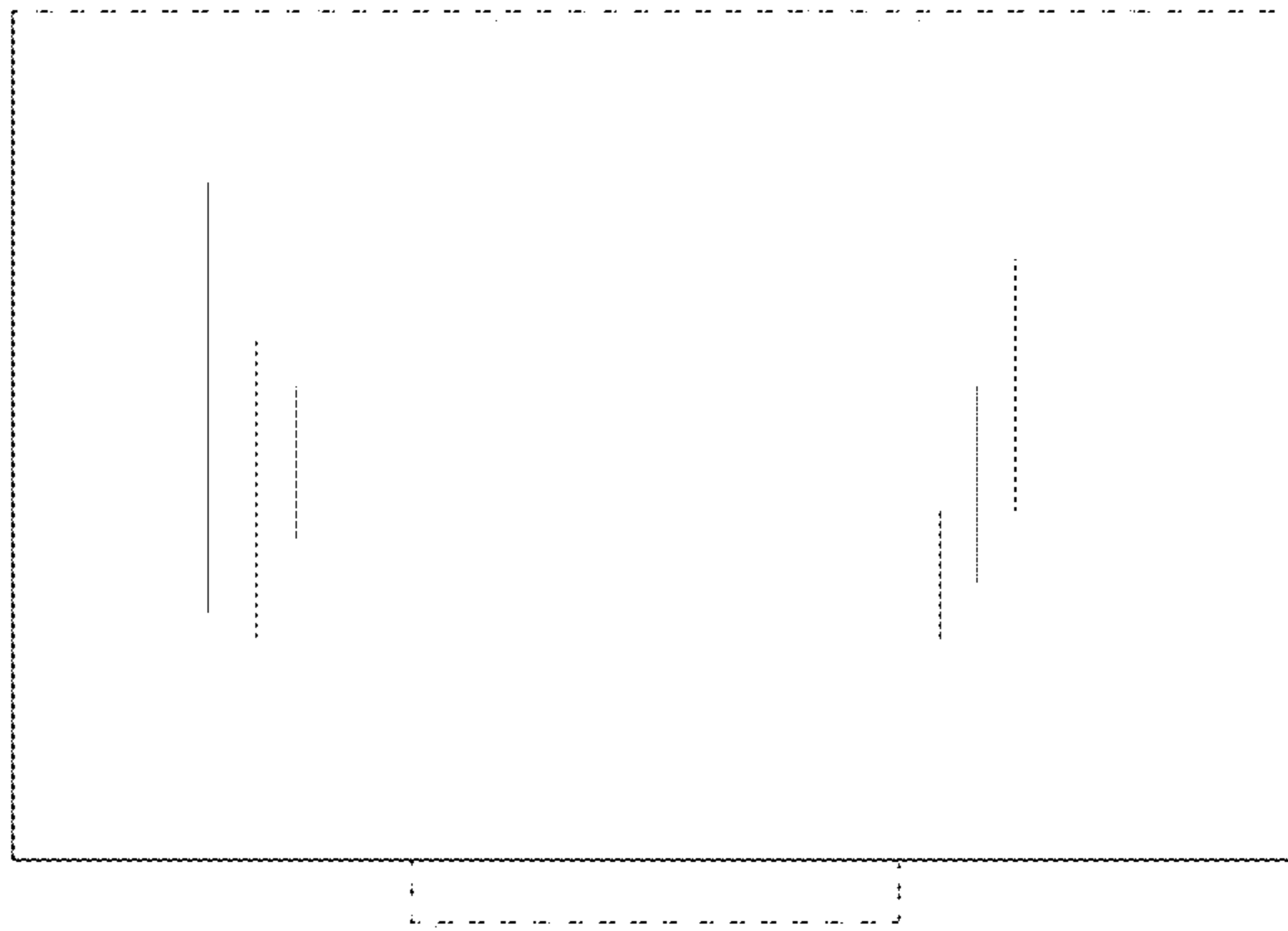

FIG. 6



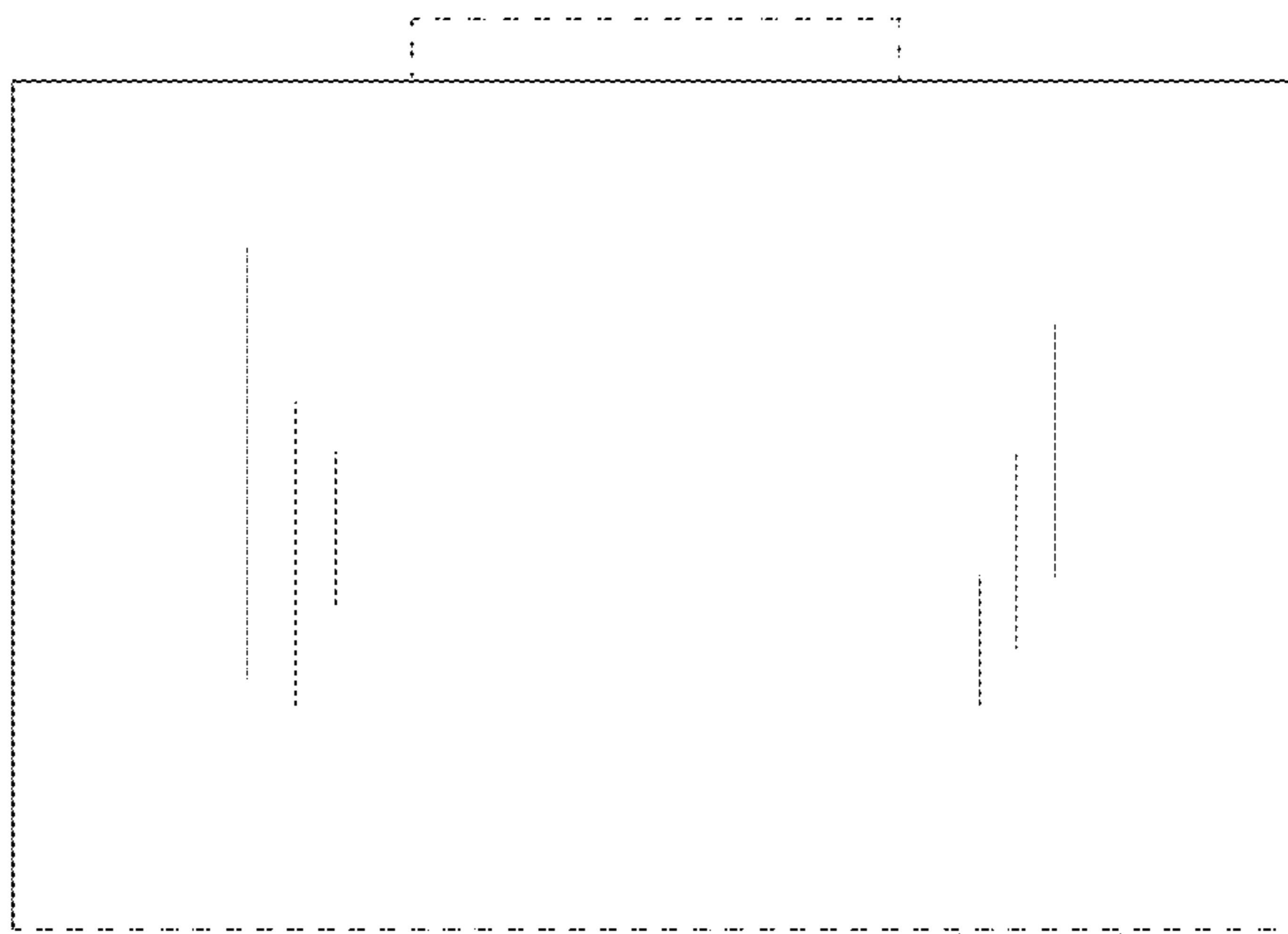

FIG. 7