



US00D988732S

(12) **United States Design Patent** (10) **Patent No.:** **US D988,732 S**  
**Giroux** (45) **Date of Patent:** **\*\* Jun. 13, 2023**

(54) **PERCH SEAT COMBINED WITH TABLE ASSEMBLY**

D873,204 S \* 1/2020 Von Holzhausen ..... D12/418  
D895,992 S \* 9/2020 Hall ..... D6/349  
2021/0188329 A1\* 6/2021 Giroux ..... B60N 3/001

(71) Applicant: **Bombardier Transportation GmbH**,  
Berlin (DE)

FOREIGN PATENT DOCUMENTS

EP 3838665 A1 \* 6/2021 ..... B60N 3/001

(72) Inventor: **Alexandre Giroux**, Saint-Hubert (CA)

OTHER PUBLICATIONS

(73) Assignee: **Bombardier Transportation GmbH**,  
Berlin (DE)

Ahrend Living Wall [online], [site visited Dec. 2022]. Available from internet, URL: <<https://www.apresfurniture.co.uk/ahrend-living-wall>> (Year: 2023).\*

(\*\*) Term: **15 Years**

\* cited by examiner

(21) Appl. No.: **29/734,521**

(22) Filed: **May 13, 2020**

*Primary Examiner* — Cynthia Ramirez

*Assistant Examiner* — Xavier Marti-Santos

(30) **Foreign Application Priority Data**

(74) *Attorney, Agent, or Firm* — The Webb Law Firm

Dec. 19, 2019 (CA) ..... CA 191984

(51) **LOC (14) Cl.** ..... **06-01**

(57) **CLAIM**

(52) **U.S. Cl.**

The ornamental design for a perch seat combined with table assembly, as shown and described.

USPC ..... **D6/336**

(58) **Field of Classification Search**

**DESCRIPTION**

USPC ..... D6/329, 334, 335, 336, 347, 349, 350,  
D6/355, 362, 363, 377, 381, 384, 382,  
D6/630, 641, 685, 694.2, 698; D12/400,  
D12/416

FIG. 1 is a front perspective view of a perch seat combined with table assembly showing my new design;  
FIG. 2 is a front elevation view thereof;  
FIG. 3 is a right side elevation view thereof;  
FIG. 4 is a left side elevation view thereof;  
FIG. 5 is a rear elevation view thereof;  
FIG. 6 is a top view thereof; and,  
FIG. 7 is a bottom view thereof.

CPC ..... B61D 1/04; B61D 33/0064; B61D 37/00  
See application file for complete search history.

The broken line showings of FIG. 1 are for the purpose of illustrating environmental structure and form no part of the claimed design.

(56) **References Cited**

The perch seat combined with table assembly is shown with symbolic breaks in its length, the appearance of any portions of the perch seat combined with table assembly extending within the symbolic breaks forms no part of the claimed design.

U.S. PATENT DOCUMENTS

D237,917 S \* 12/1975 Seymour ..... D6/349  
D249,670 S \* 9/1978 VanderWaal ..... D12/423  
D335,033 S \* 4/1993 Pontoppidan ..... D6/349  
D365,465 S \* 12/1995 Kniefel ..... D6/641  
D418,326 S \* 1/2000 Sexton ..... D6/357  
D507,420 S \* 7/2005 Reza-Hadden ..... D6/349  
D534,613 S \* 1/2007 Zeilinger ..... D21/823  
D729,537 S \* 5/2015 Ferm ..... D6/362  
D810,456 S \* 2/2018 Hiyoshi ..... D6/377  
D815,848 S \* 4/2018 Longo ..... D6/362

**1 Claim, 3 Drawing Sheets**

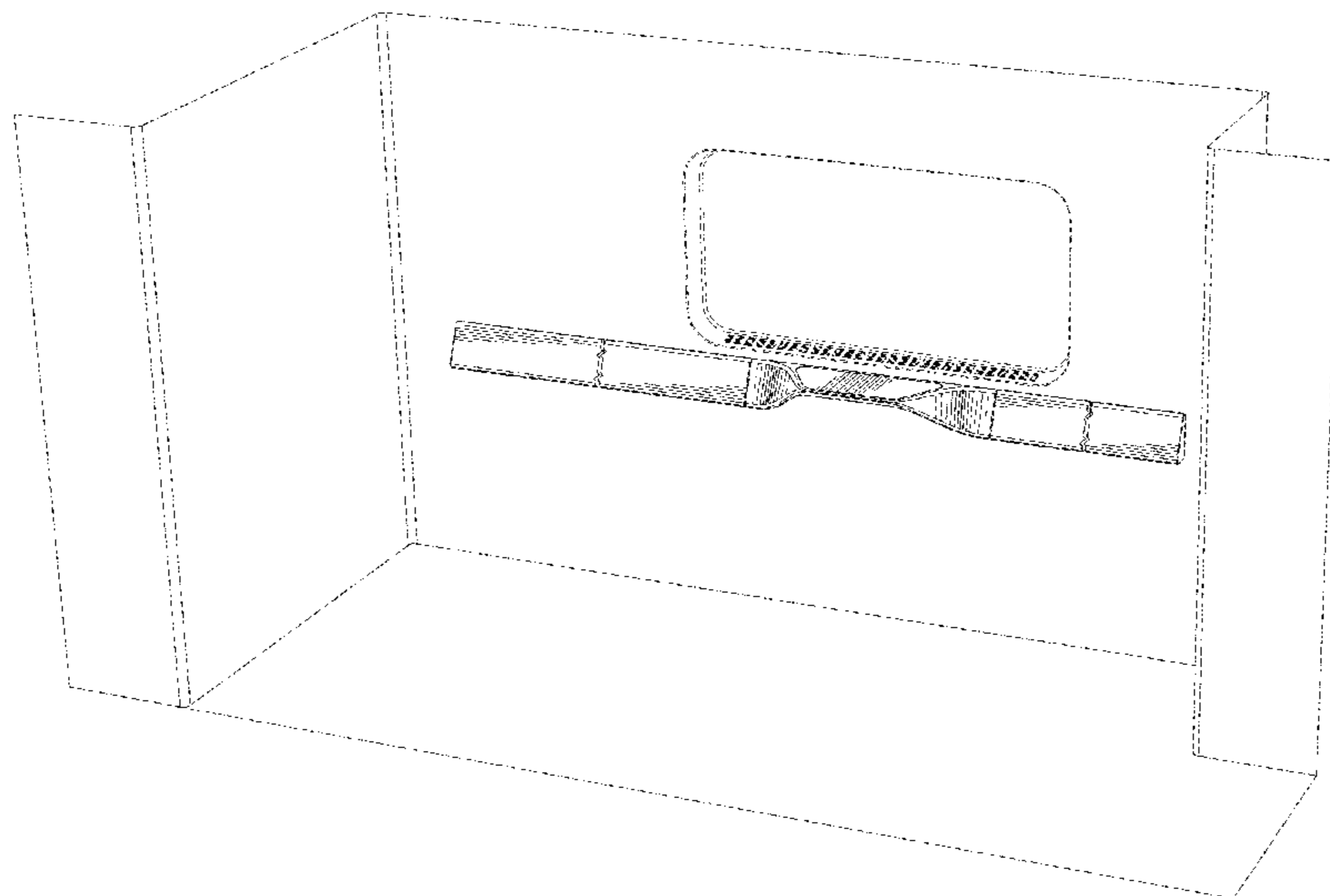

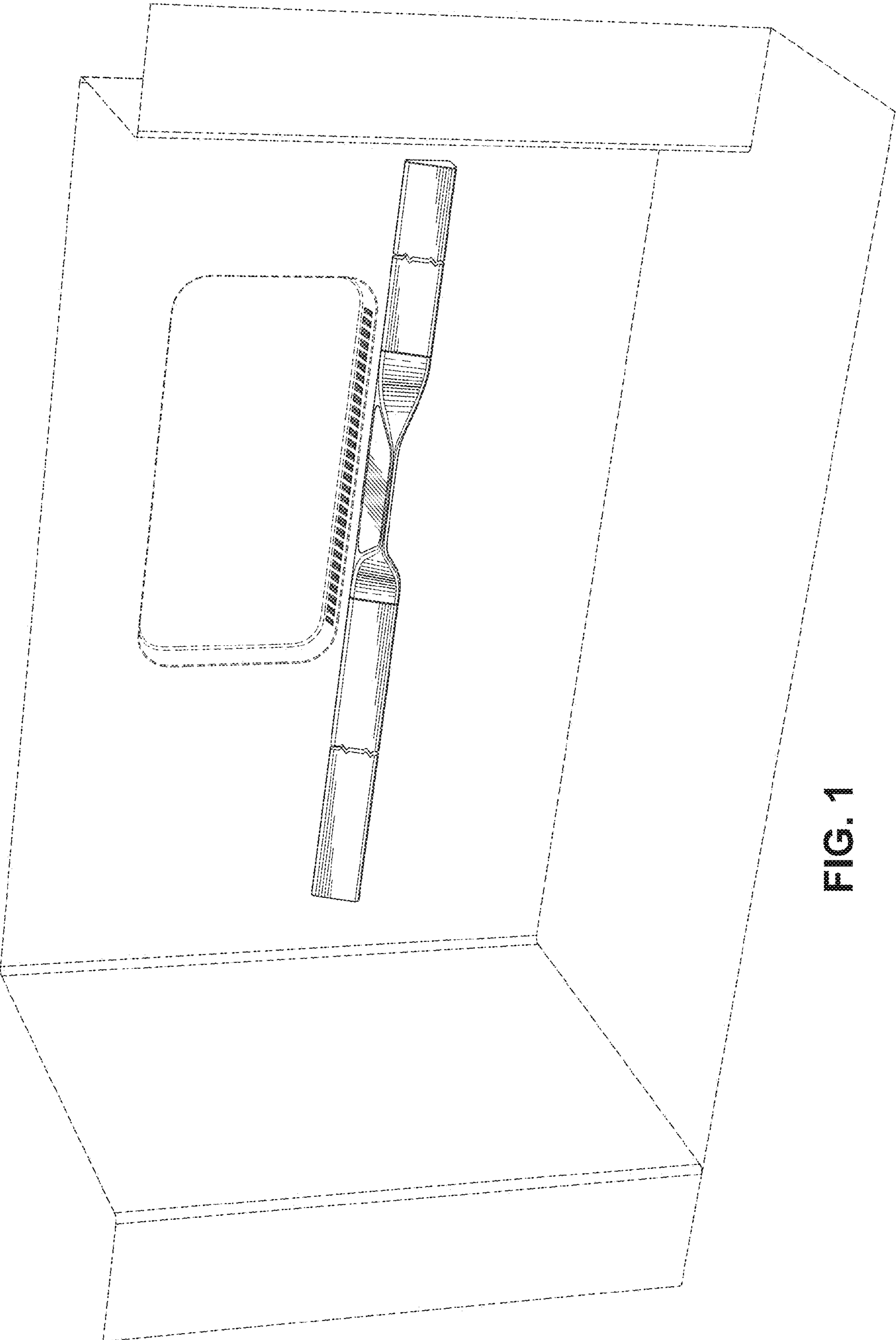

FIG. 1

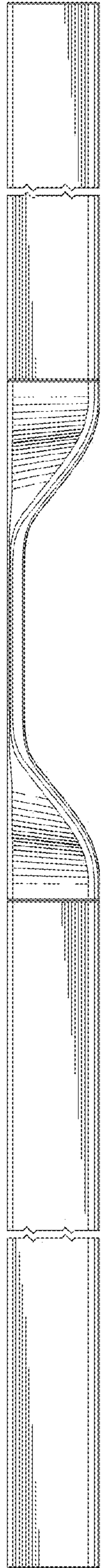

FIG. 2

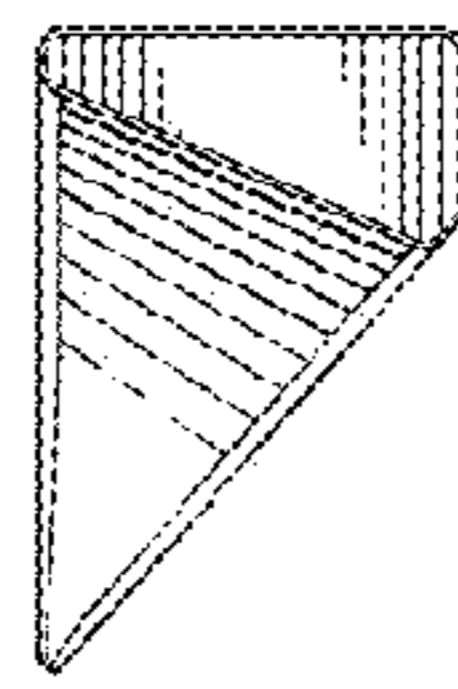

FIG. 3

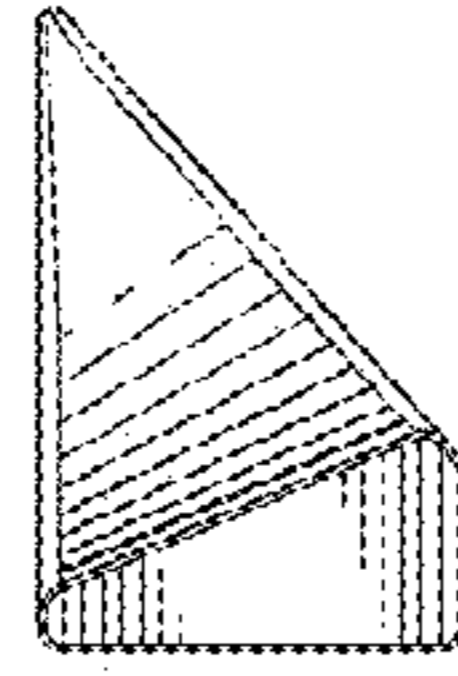

FIG. 4

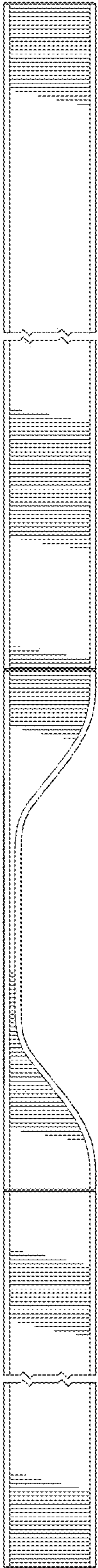

FIG. 5

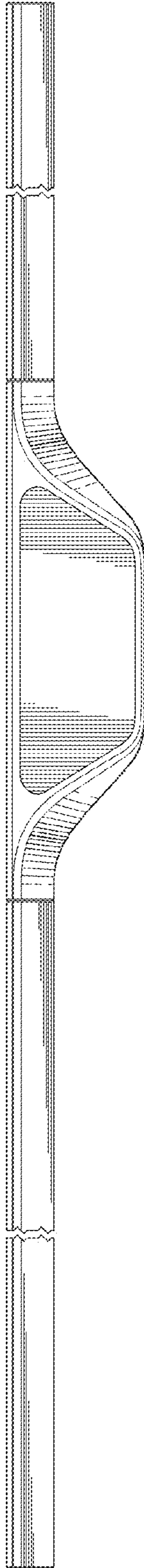

FIG. 6

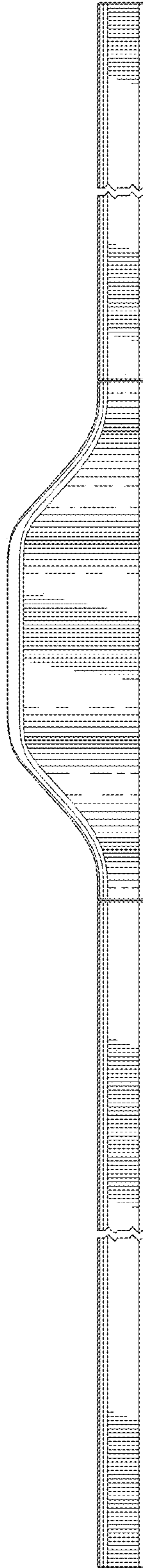

FIG. 7