



US00D988640S

(12) **United States Design Patent**
Ambelang

(10) **Patent No.:** **US D988,640 S**
(45) **Date of Patent:** **** Jun. 13, 2023**

(54) **SHIRT**

- (71) Applicant: **Bryce Ambelang**, Addison, TX (US)
- (72) Inventor: **Bryce Ambelang**, Addison, TX (US)
- (**) Term: **15 Years**
- (21) Appl. No.: **29/770,393**
- (22) Filed: **Feb. 11, 2021**
- (51) **LOC (14) Cl.** **02-02**
- (52) **U.S. Cl.**
USPC **D2/849**
- (58) **Field of Classification Search**
USPC D2/717, 728, 731, 736, 737, 840, 841,
D2/842, 844, 847
CPC A41B 1/08; A41B 1/04; A41B 1/06; A41B
9/008; A41B 1/00; A41B 9/08; A41B
9/14; A41F 17/00; A41F 5/00; A41F
1/008; A41D 15/00
See application file for complete search history.

(56) **References Cited**

U.S. PATENT DOCUMENTS

959,611 A	5/1910	Rosen	
1,975,285 A *	10/1934	Pearse	A41B 1/00 2/128
2,104,487 A *	1/1938	Kessler	A41B 1/06 2/70
2,109,867 A	3/1938	Pedlar	
2,130,690 A *	9/1938	Lemoine	A41D 13/02 2/70
2,142,479 A *	1/1939	Rosenfelder	A41D 15/00 D2/714
2,164,683 A *	7/1939	Kessler	A41B 1/06 2/70
2,274,382 A	2/1942	Richman	

(Continued)

FOREIGN PATENT DOCUMENTS

CA	2545122 A1 *	9/2005
FR	2559652 A1 *	8/1985

OTHER PUBLICATIONS

Iiniim Men's Long Sleeve Zipper Front Romper Shirt One-Piece Bowtie Leotard Bodysuit, announced Oct. 8, 2018 [online], [site visited Dec. 16, 2022]. Available from internet, URL: <<https://www.amazon.com/iiniim-Sleeve-One-Piece-Leotard-Bodysuit/dp/B07D3SGK2S/?th=1>> (Year: 2018).*

(Continued)

Primary Examiner — Kevin K Rudzinski

Assistant Examiner — Amber J Rabie

(74) *Attorney, Agent, or Firm* — Banner & Witcoff, Ltd.

(57) **CLAIM**

The ornamental design for a shirt, as shown and described.

DESCRIPTION

FIG. 1 is a front perspective view of a shirt showing my new design;
 FIG. 2 is a front view thereof;
 FIG. 3 is a rear view thereof;
 FIG. 4 is a right side view thereof;
 FIG. 5 is a left side view thereof;
 FIG. 6 is a top view thereof;
 FIG. 7 is a bottom view thereof;
 FIG. 8 is a front perspective view of a shirt of FIGS. 1-7 shown with the bottom portion of the shirt downwards;
 FIG. 9 is a front view thereof;
 FIG. 10 is a rear view thereof;
 FIG. 11 is a right side view thereof;
 FIG. 12 is a left side view thereof;
 FIG. 13 is a top view thereof; and,
 FIG. 14 is a bottom view thereof.
 The even-length broken lines represent stitching that forms no part of the claimed design. The dot-dash broken lines represent environment that forms no part of the claimed design.

1 Claim, 14 Drawing Sheets

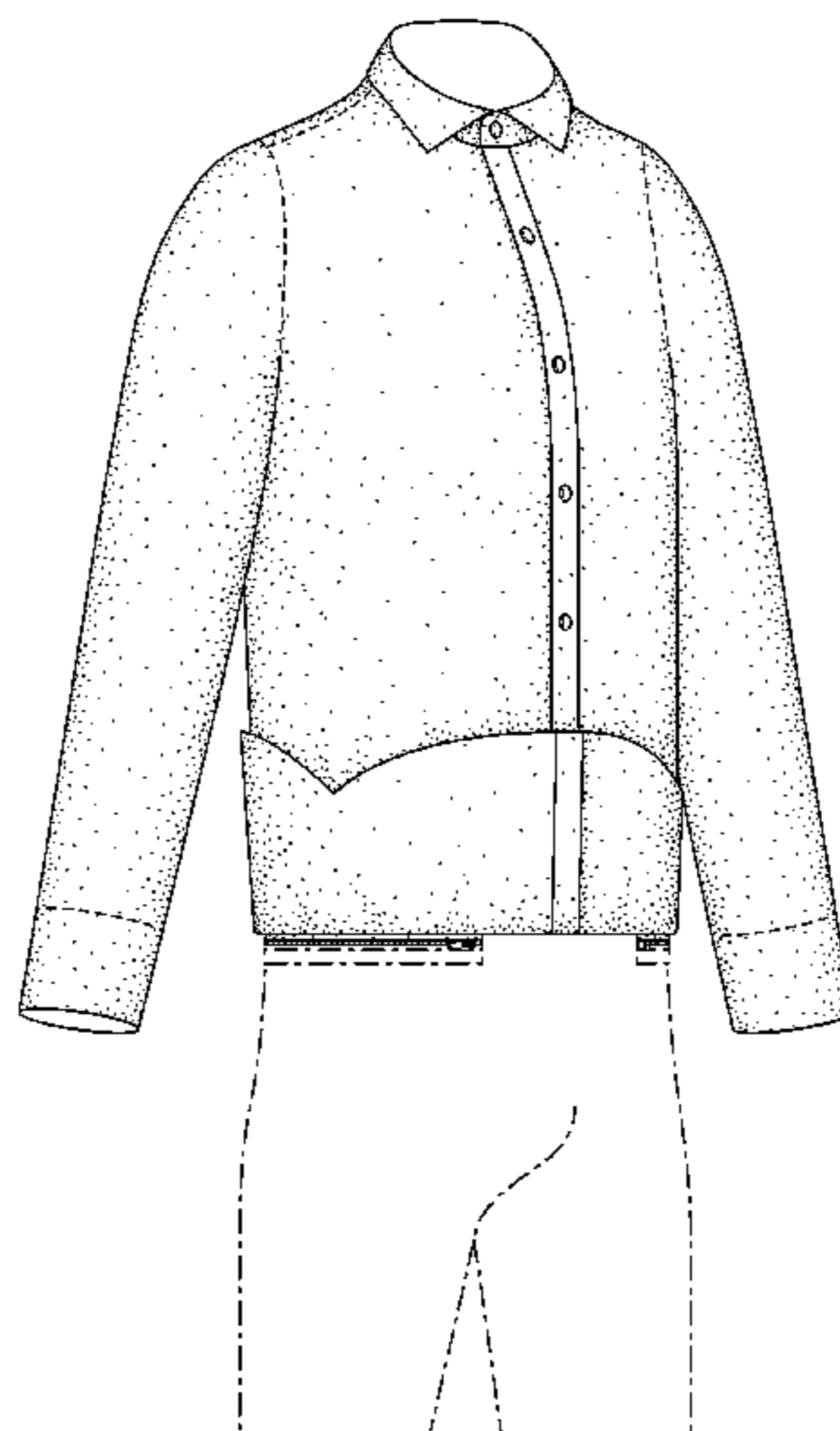

(56)

References Cited

U.S. PATENT DOCUMENTS

2,559,953	A	7/1951	Evans	
2,562,234	A *	7/1951	Gottschalk	A41B 1/06 2/70
2,849,716	A	9/1958	Kerson	
D214,011	S *	5/1969	Johnson	D2/847
5,802,612	A	9/1998	Hosking	
6,223,352	B1	5/2001	Watlington	
D853,684	S *	7/2019	Gillen	D2/728
11,234,467	B1 *	2/2022	Olsgard	A41B 9/06
2006/0010559	A1 *	1/2006	Hamlet	A41B 1/08 2/117
2009/0192433	A1	7/2009	Wells et al.	
2015/0026990	A1	1/2015	Ellis et al.	
2016/0324238	A1 *	11/2016	Tran	A41B 1/06
2017/0196283	A1	7/2017	Hart	
2017/0325519	A1	11/2017	Willingham	
2019/0320731	A1	10/2019	Singh	

2020/0221802	A1	7/2020	They	
2022/0000201	A1 *	1/2022	Torano	A41D 1/22
2022/0248773	A1 *	8/2022	Ambelang	A41F 17/00

OTHER PUBLICATIONS

Zip Tech® | Volcom Outerwear, announced Oct. 12, 2018 [online], [site visited Jan. 6, 2023]. Available from internet, URL: <<https://www.youtube.com/watch?v=izmOZN7iazU>> (Year: 2018).*

Tommy John Presents: Tuck Hacks // Underwear Tuck, announced Sep. 28, 2018 [online], [site visited Jan. 5, 2023]. Available from internet, URL: <<https://www.youtube.com/watch?v=zQ-xXkuDchQ>> (Year: 2018).*

Bambelang Shirt, announced Sep. 14, 2020 [online], [site visited Jan. 5, 2023]. Available from internet, URL: <https://www.instagram.com/p/CFIjmh1SA/?utm_source=ig_web_button_share_sheet> (Year: 2020).*

* cited by examiner

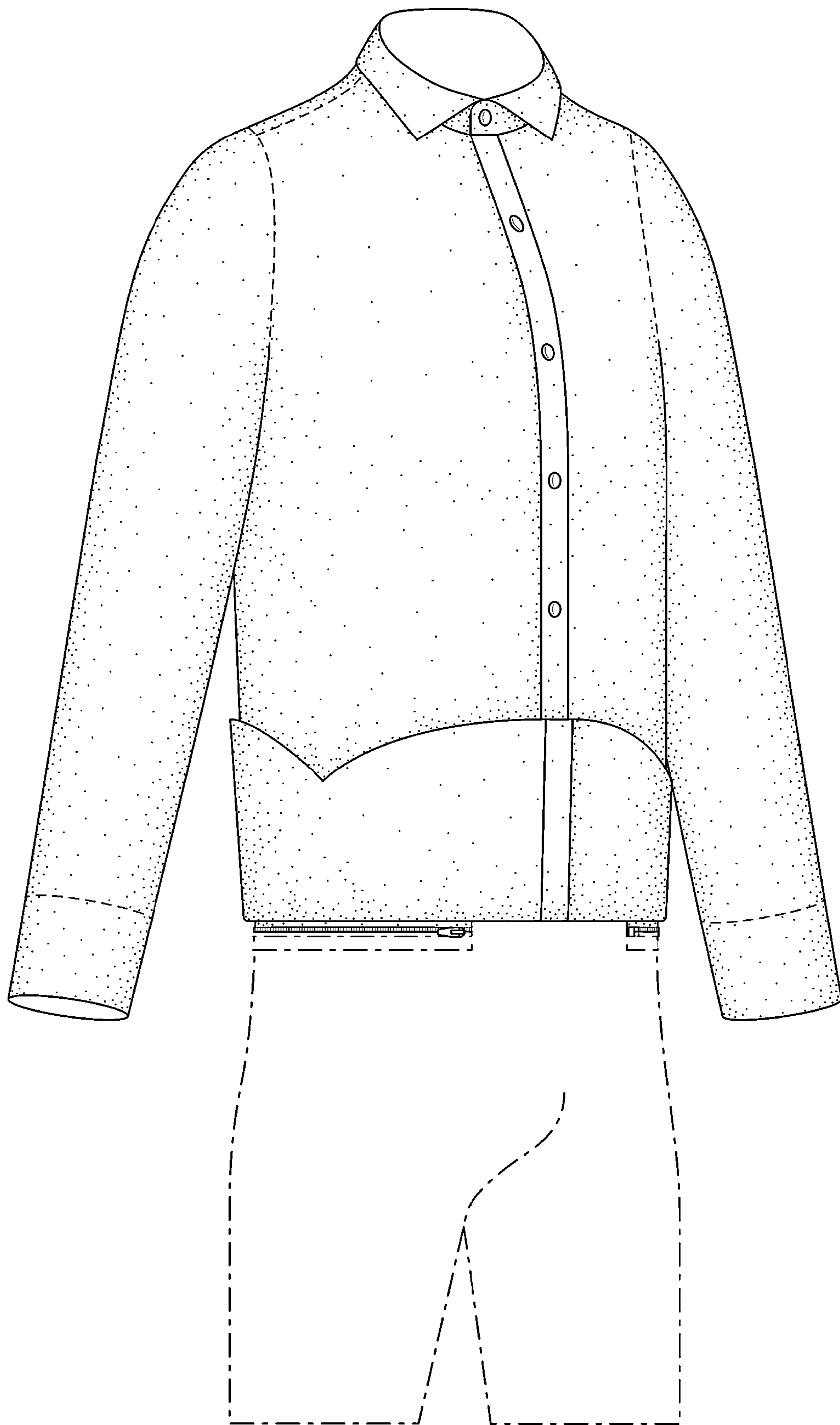

FIG. 1

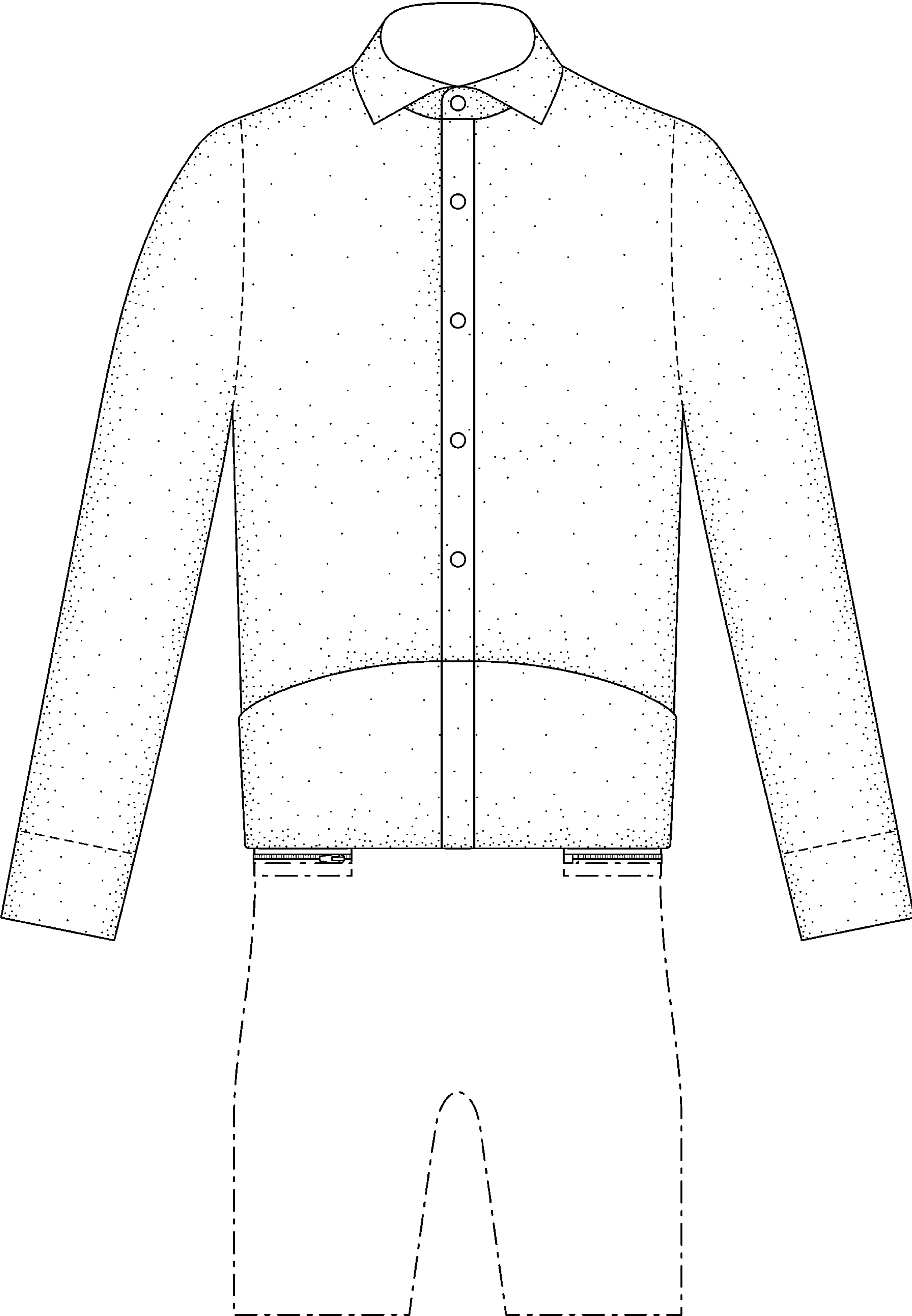

FIG. 2

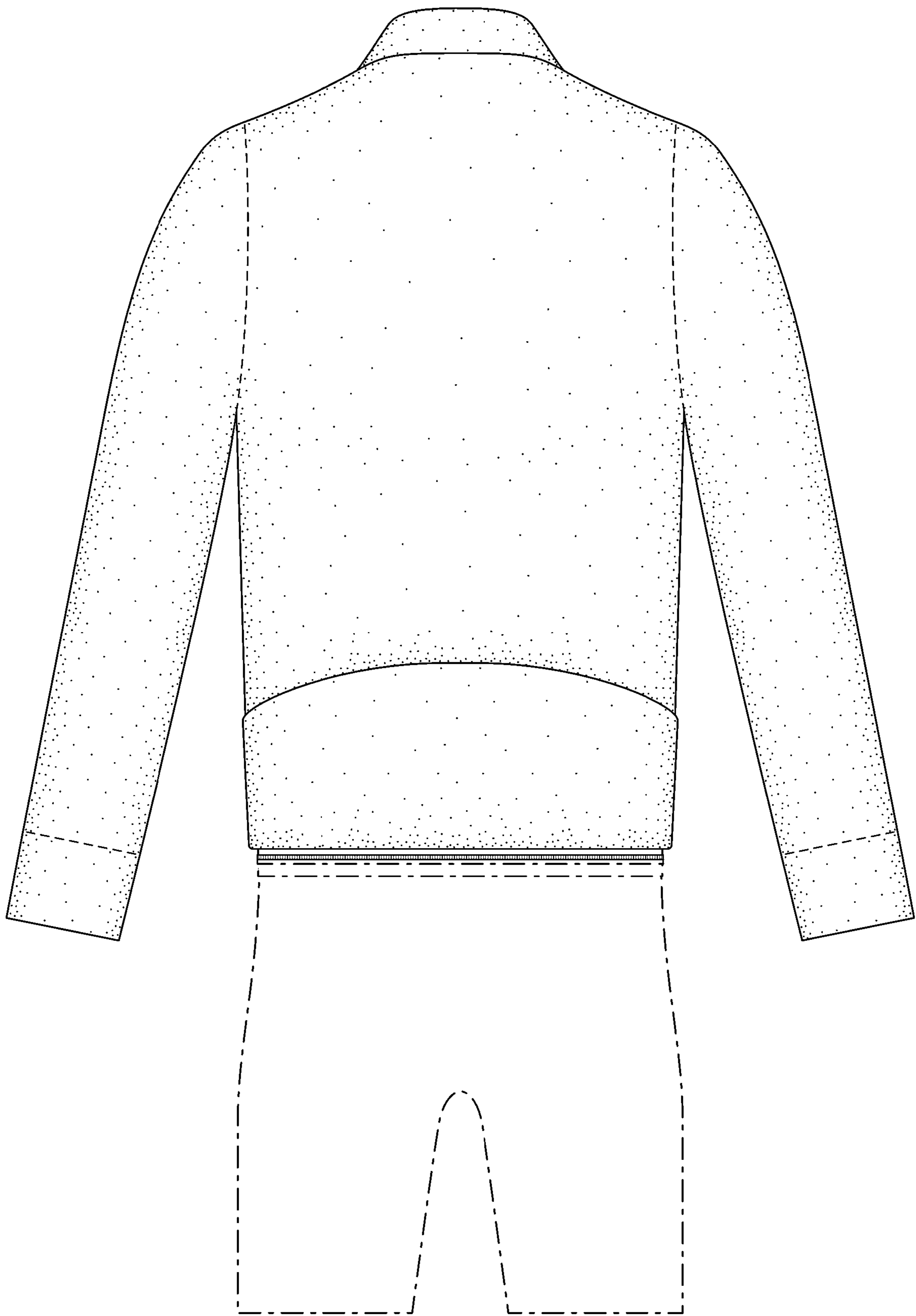

FIG. 3

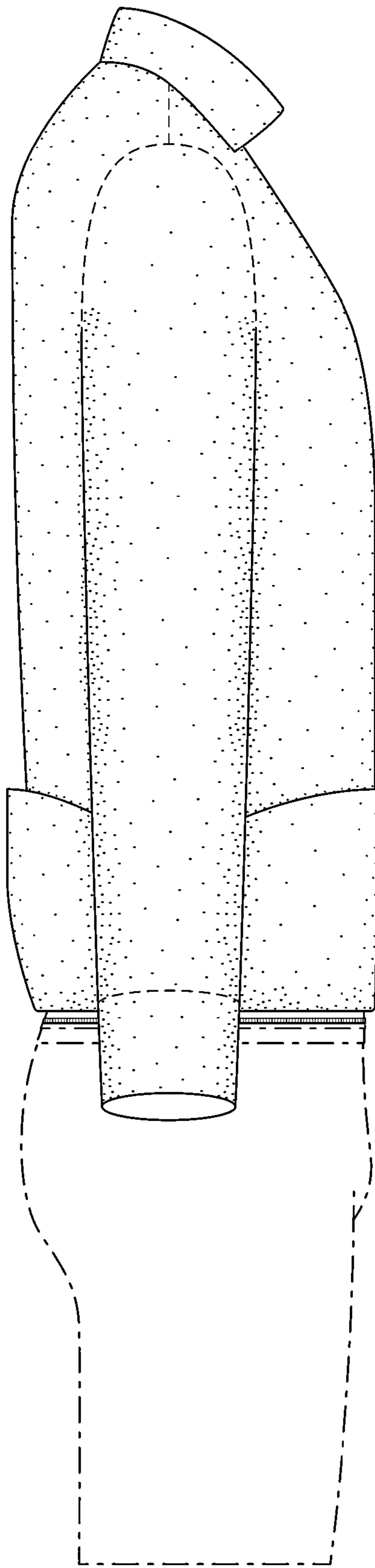

FIG. 4

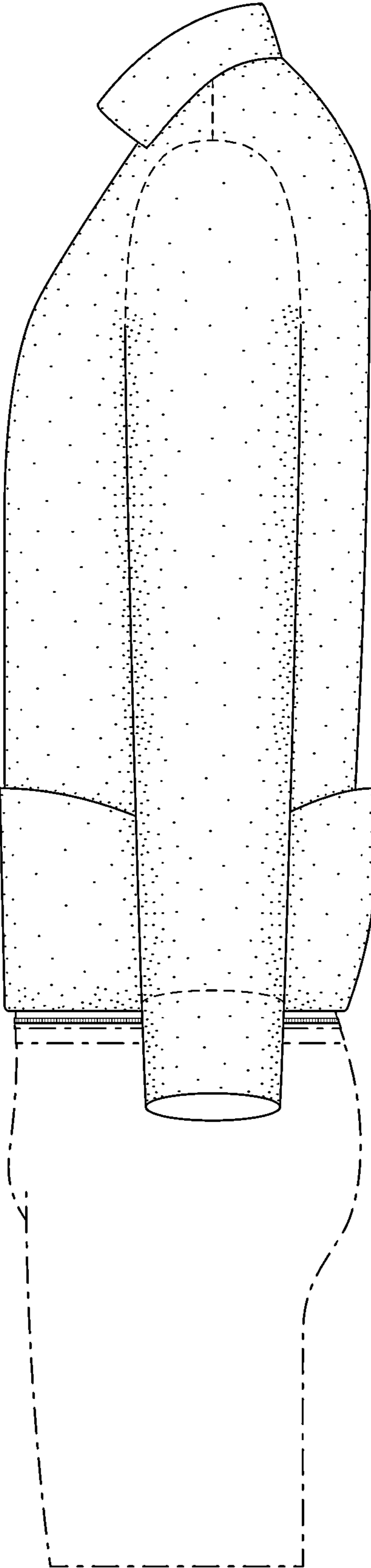

FIG. 5

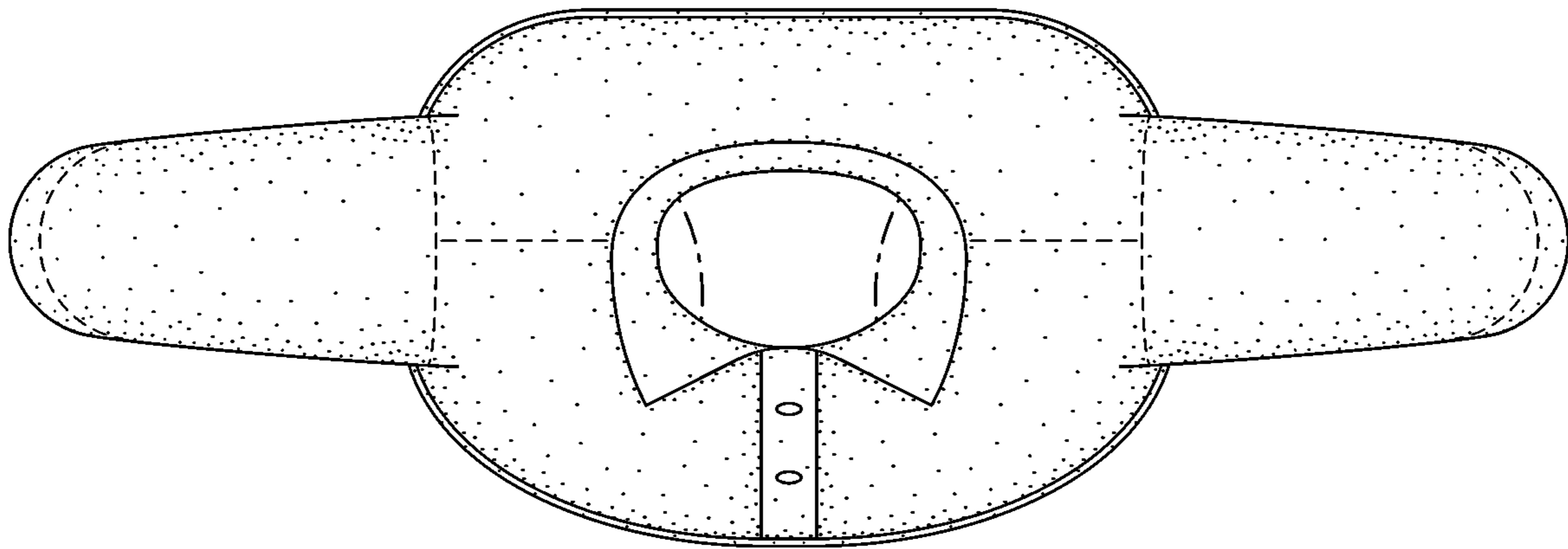

FIG. 6

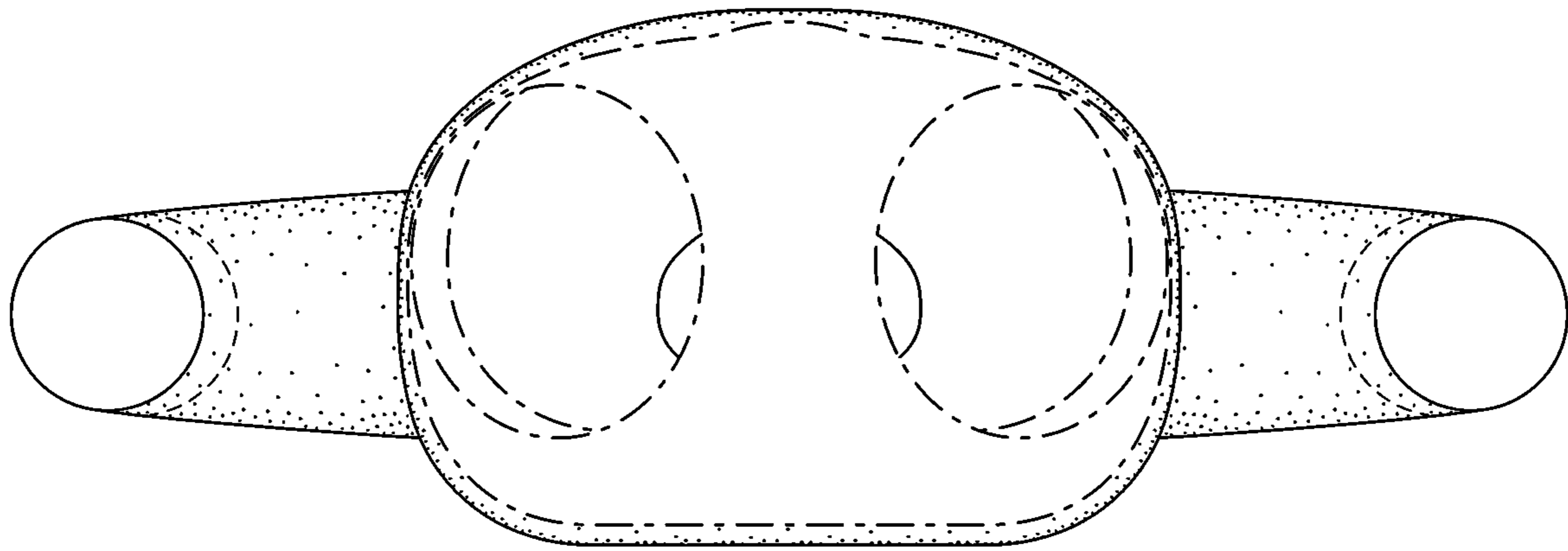

FIG. 7

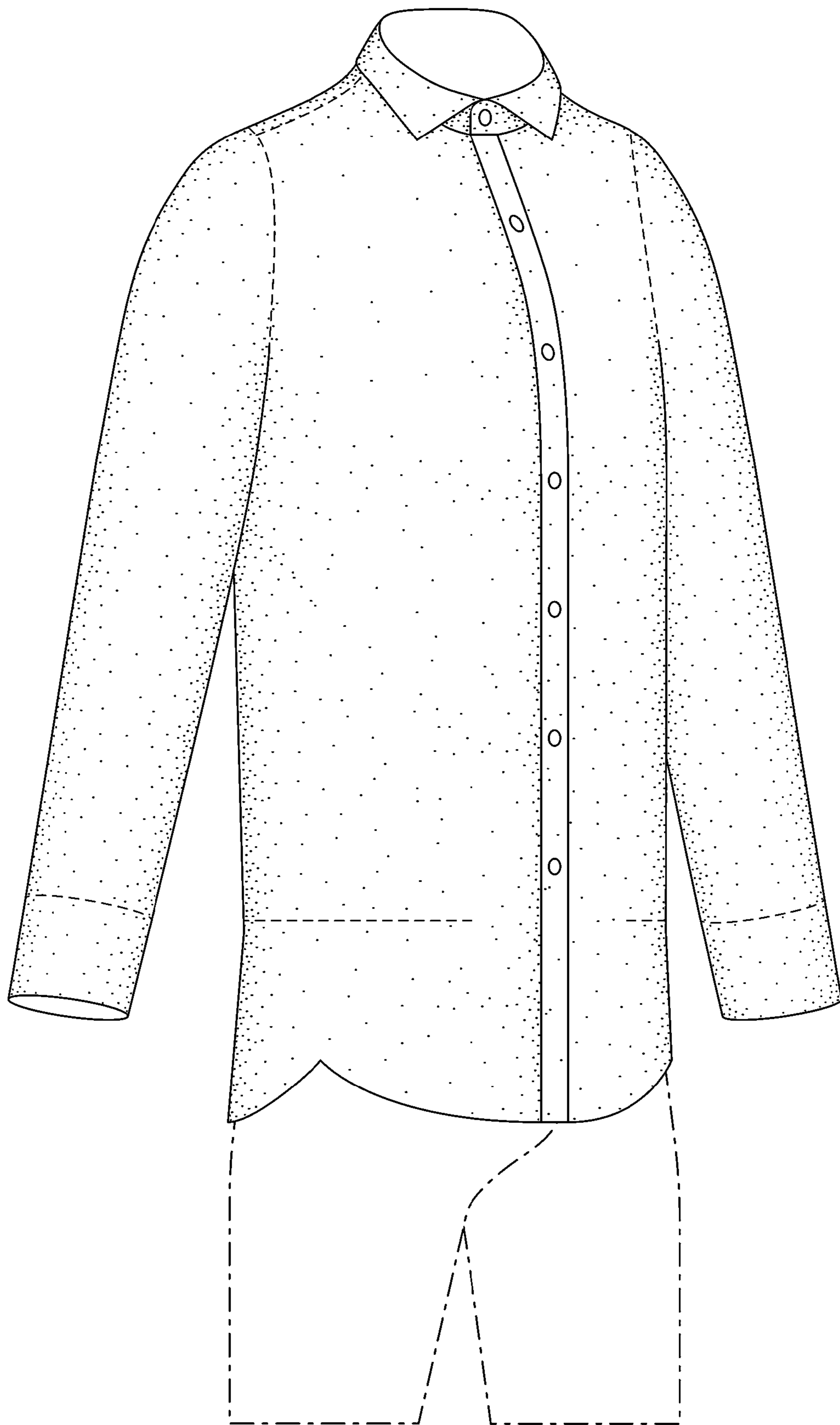

FIG. 8

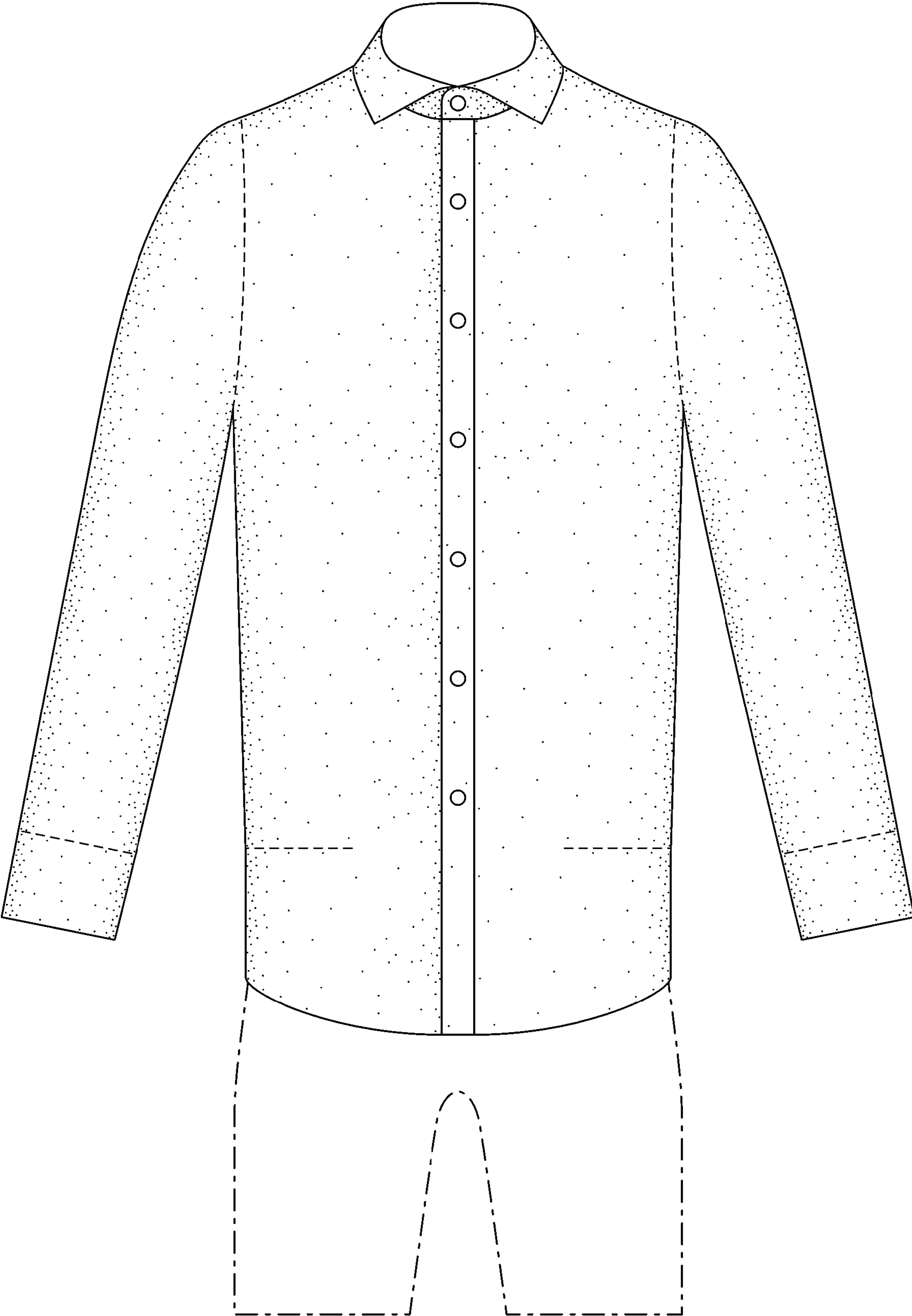

FIG. 9

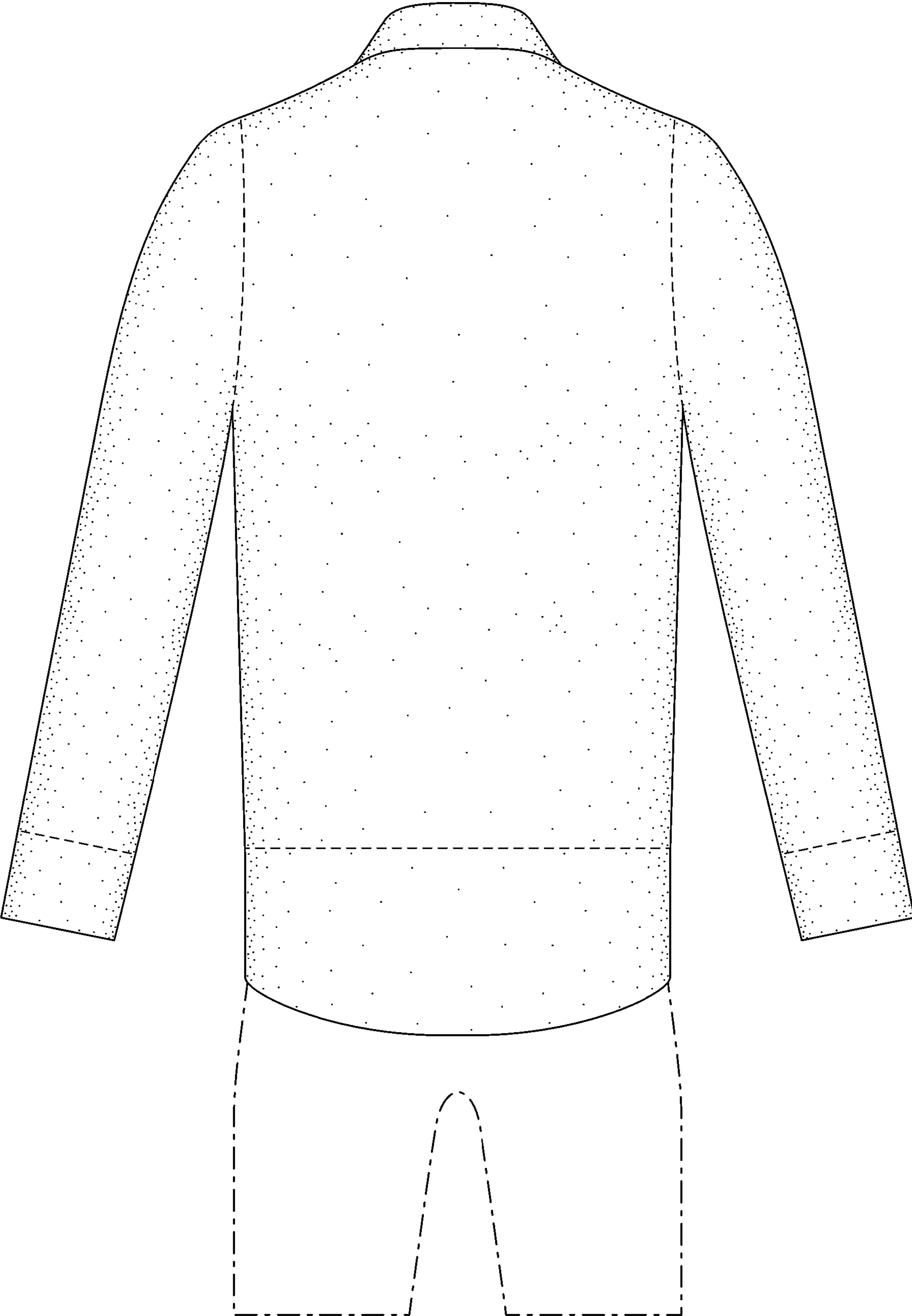

FIG. 10



FIG. 11

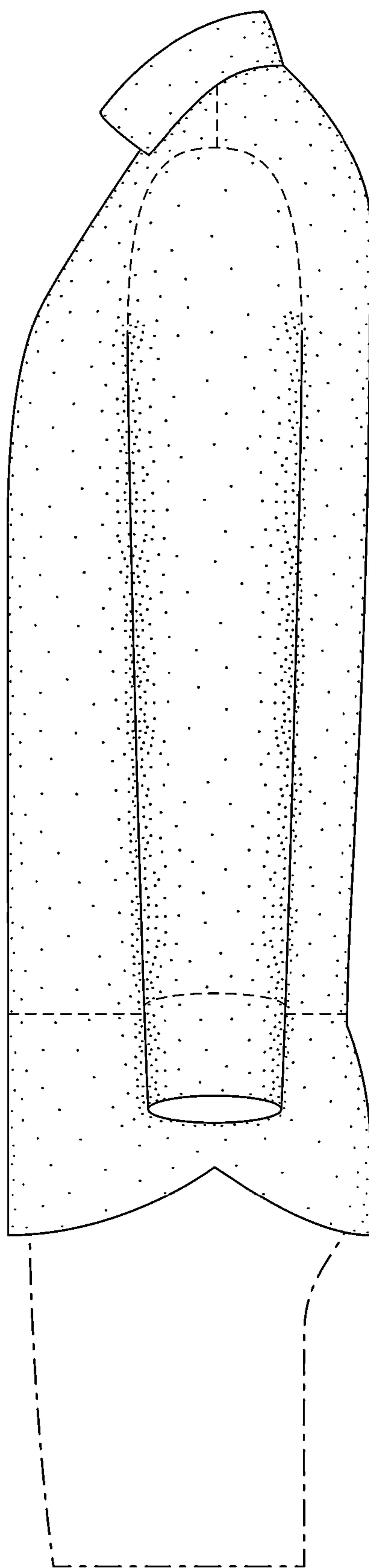

FIG. 12

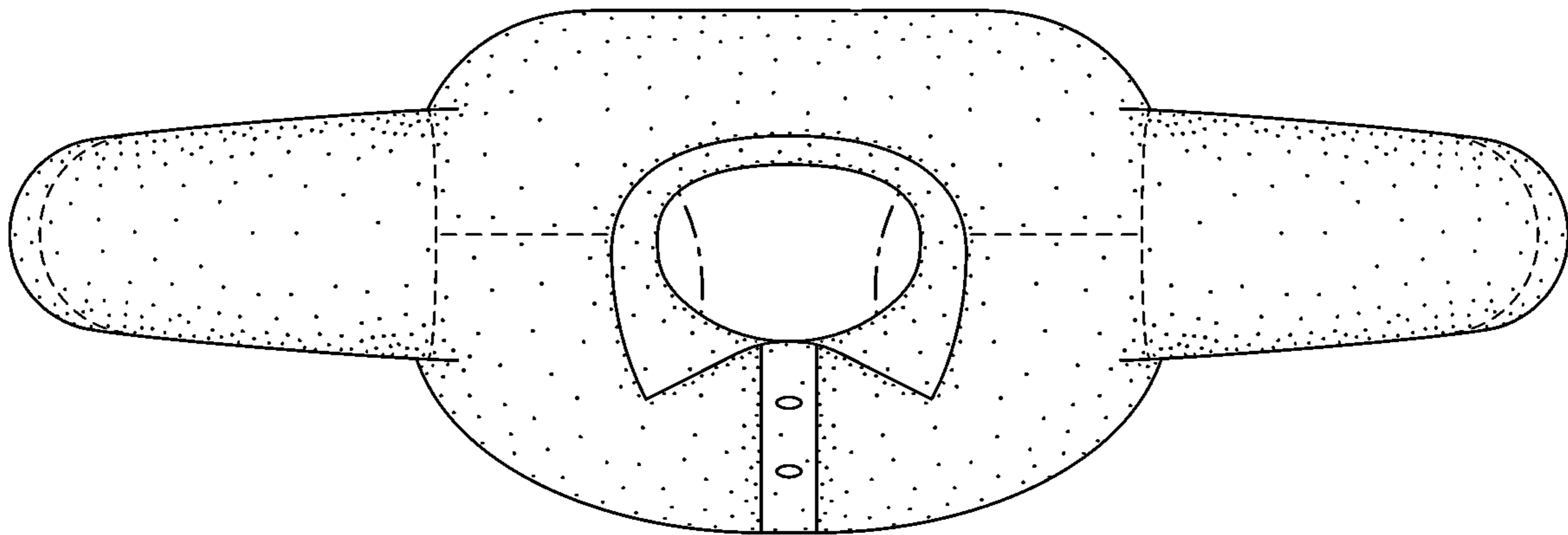

FIG. 13

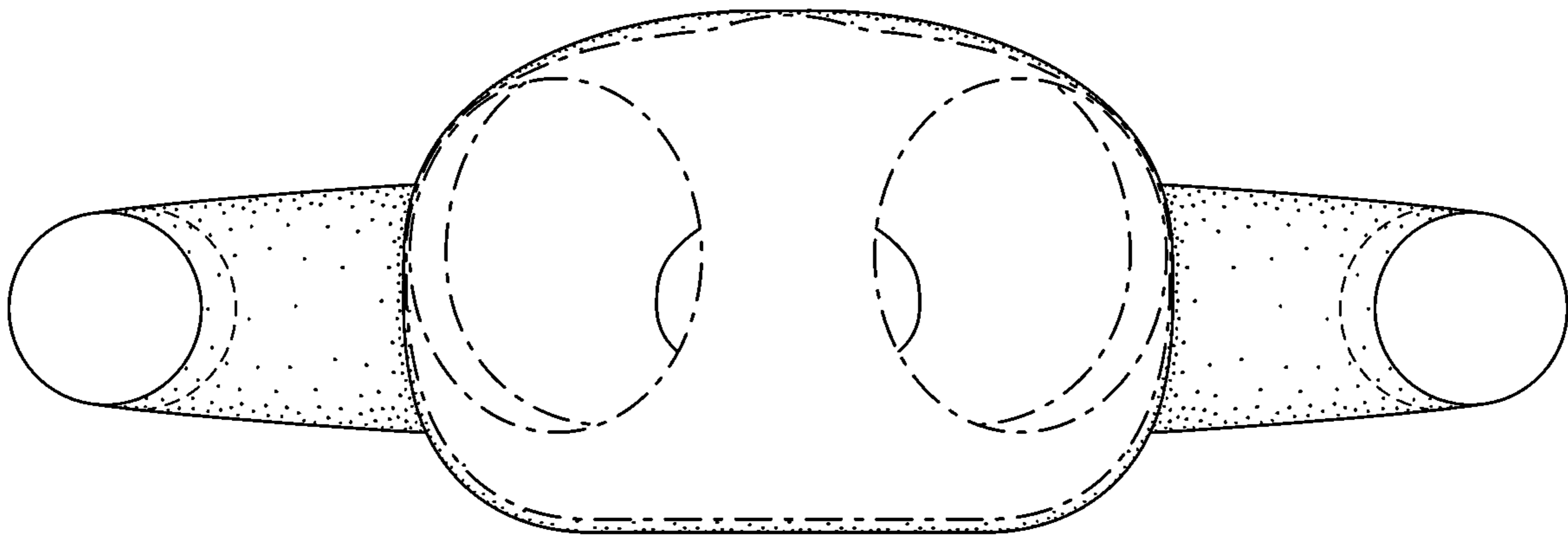

FIG. 14