



US00D988610S

(12) **United States Design Patent**
Huang

(10) **Patent No.:** **US D988,610 S**
(45) **Date of Patent:** **** Jun. 6, 2023**

- (54) **DOG CRATE**
- (71) Applicant: **Huizhou Zhongcheng Metal Products Co., Ltd., Huizhou (CN)**
- (72) Inventor: **Shanlue Huang, Meizhou (CN)**
- (73) Assignee: **Huizhou Zhongcheng Metal Products Co., Ltd., Huizhou (CN)**
- (**) Term: **15 Years**
- (21) Appl. No.: **29/854,233**
- (22) Filed: **Sep. 22, 2022**
- (51) **LOC (14) Cl.** **30-02**
- (52) **U.S. Cl.**
USPC **D30/108**
- (58) **Field of Classification Search**
USPC D30/108–120, 161, 121, 132–133;
D25/12, 15
CPC .. A01K 1/0107; A01K 1/0114; A01K 1/0125;
A01K 1/0121; A01K 1/035; A01K
1/0152; A01K 1/0157; A01K 1/034;
A01K 1/033; A01K 1/0245; A01K
1/0272; A01K 1/029
See application file for complete search history.

- D554,389 S * 11/2007 Pierce D30/108
- D609,407 S * 2/2010 Henley D30/112
- D613,000 S * 3/2010 Ward D30/119
- D622,913 S * 8/2010 Schroeder D30/129
- D634,078 S * 3/2011 Lee D30/119
- D640,837 S * 6/2011 Henley D30/108
- 7,997,234 B1 * 8/2011 Hughey A01K 1/034
119/500
- D666,782 S * 9/2012 Wygle D30/129
- D676,612 S * 2/2013 Wygle D30/118
- D680,696 S * 4/2013 Hammel D30/108
- D683,080 S * 5/2013 Snow D30/108
- D702,403 S * 4/2014 Snow D30/108
- D704,901 S * 5/2014 Diskin D30/108

(Continued)

Primary Examiner — Samantha Wood
Assistant Examiner — Aula Soroush
(74) *Attorney, Agent, or Firm* — Nitin Kaushik

(57) **CLAIM**

The ornamental design for a dog crate, as shown and described.

DESCRIPTION

FIG. 1 is a front perspective view of a dog crate, showing my new design;
FIG. 2 is another perspective view shown in an alternate configuration thereof;
FIG. 3 is an other perspective view shown in an alternate configuration thereof;
FIG. 4 is another perspective view shown in an alternate configuration thereof;
FIG. 5 is a front view thereof;
FIG. 6 is a rear view thereof;
FIG. 7 is a left side view thereof;
FIG. 8 is a right side view thereof;
FIG. 9 is a top view thereof; and,
FIG. 10 is a bottom view thereof.
The broken lines in the drawings illustrate the portions of the dog crate, which form no part of the claimed design.

1 Claim, 10 Drawing Sheets

- (56) **References Cited**
U.S. PATENT DOCUMENTS
3,872,832 A * 3/1975 Quinn A01K 1/0107
119/165
3,885,523 A * 5/1975 Coleman A01K 1/0107
119/482
3,924,572 A * 12/1975 Classe A01K 1/031
D30/118
D282,880 S * 3/1986 Barati D30/114
4,590,885 A * 5/1986 Sugiura A01K 31/08
119/497
D353,030 S * 11/1994 Fernandez D30/108
D424,249 S * 5/2000 Banzaca D30/119

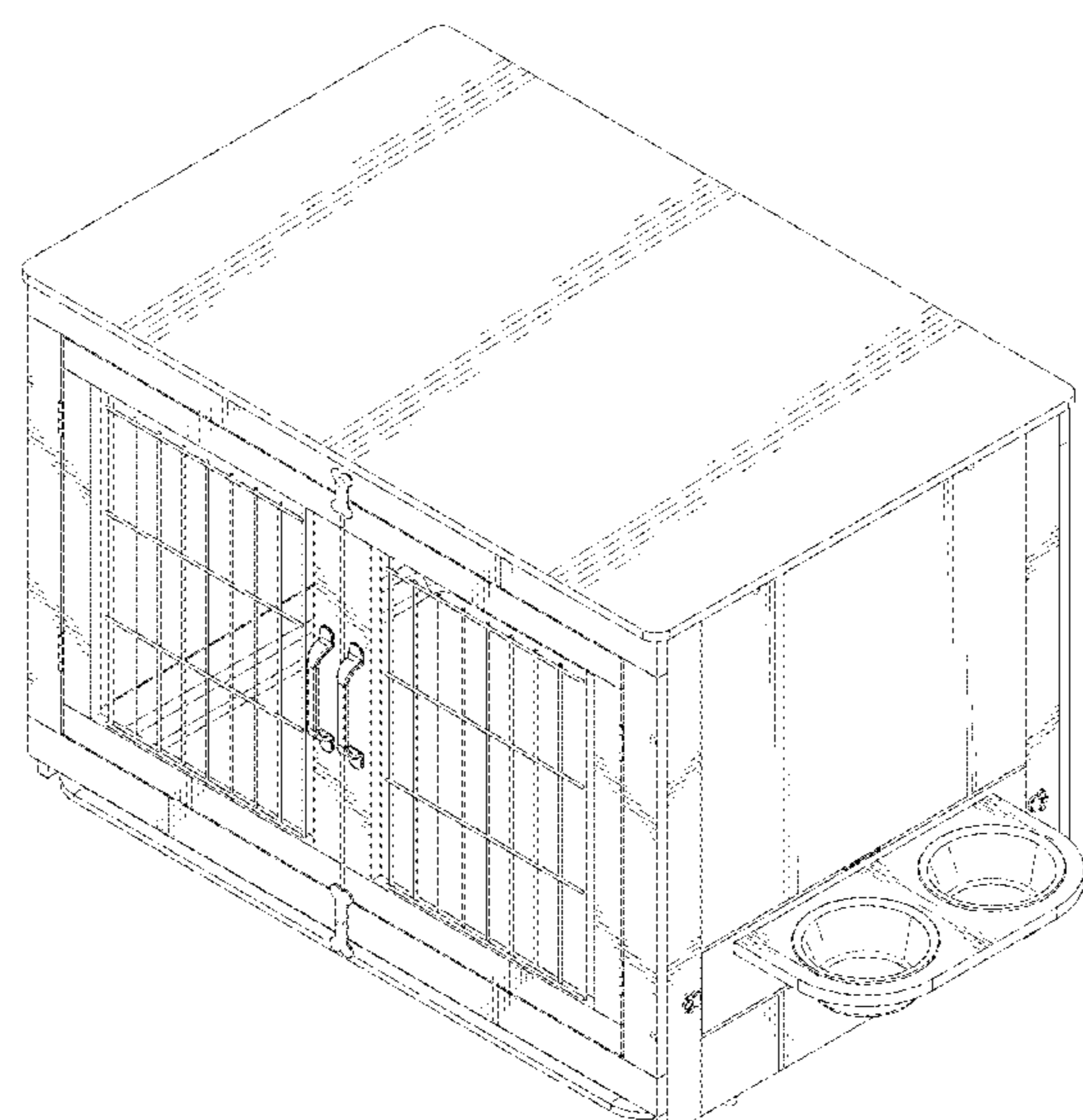

(56)

References Cited

U.S. PATENT DOCUMENTS

D814,121	S *	3/2018	Kim	D30/108
D820,526	S *	6/2018	Wilson	D30/108
D852,429	S *	6/2019	Rathman	D30/114
D853,052	S *	7/2019	Rathman	D30/114
D863,798	S *	10/2019	Klump	D6/349
D882,879	S *	4/2020	Lara	D30/118
D894,496	S *	8/2020	Hutchinson	D30/108
D903,948	S *	12/2020	Xin	D30/108
D921,995	S	6/2021	Gao	
D930,277	S *	9/2021	Huthmaker	D30/119
D952,263	S *	5/2022	Mihlbauer	D30/108
D952,955	S *	5/2022	Mihlbauer	D30/108
D954,355	S *	6/2022	Mihlbauer	D30/108
D957,745	S *	7/2022	Mihlbauer	D30/108
2007/0000448	A1 *	1/2007	Dietz	A01K 1/033 119/481
2014/0352628	A1 *	12/2014	Kellogg	A01K 1/033 119/497
2017/0359998	A1 *	12/2017	Kim	A01K 1/0245
2018/0359985	A1 *	12/2018	Jung	A01K 29/005
2019/0069509	A1 *	3/2019	Gulati	A01K 1/035

* cited by examiner

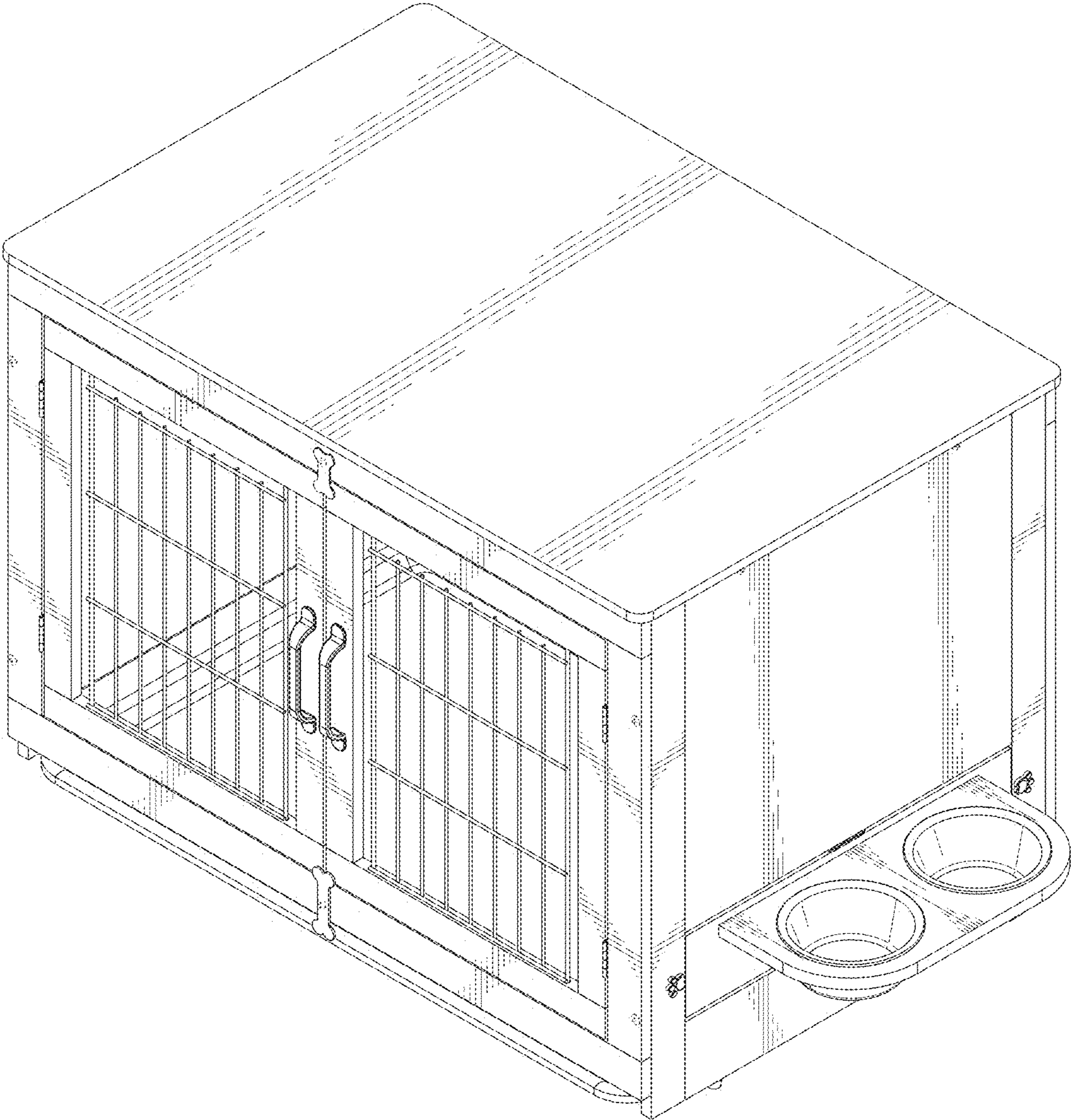

FIG. 1

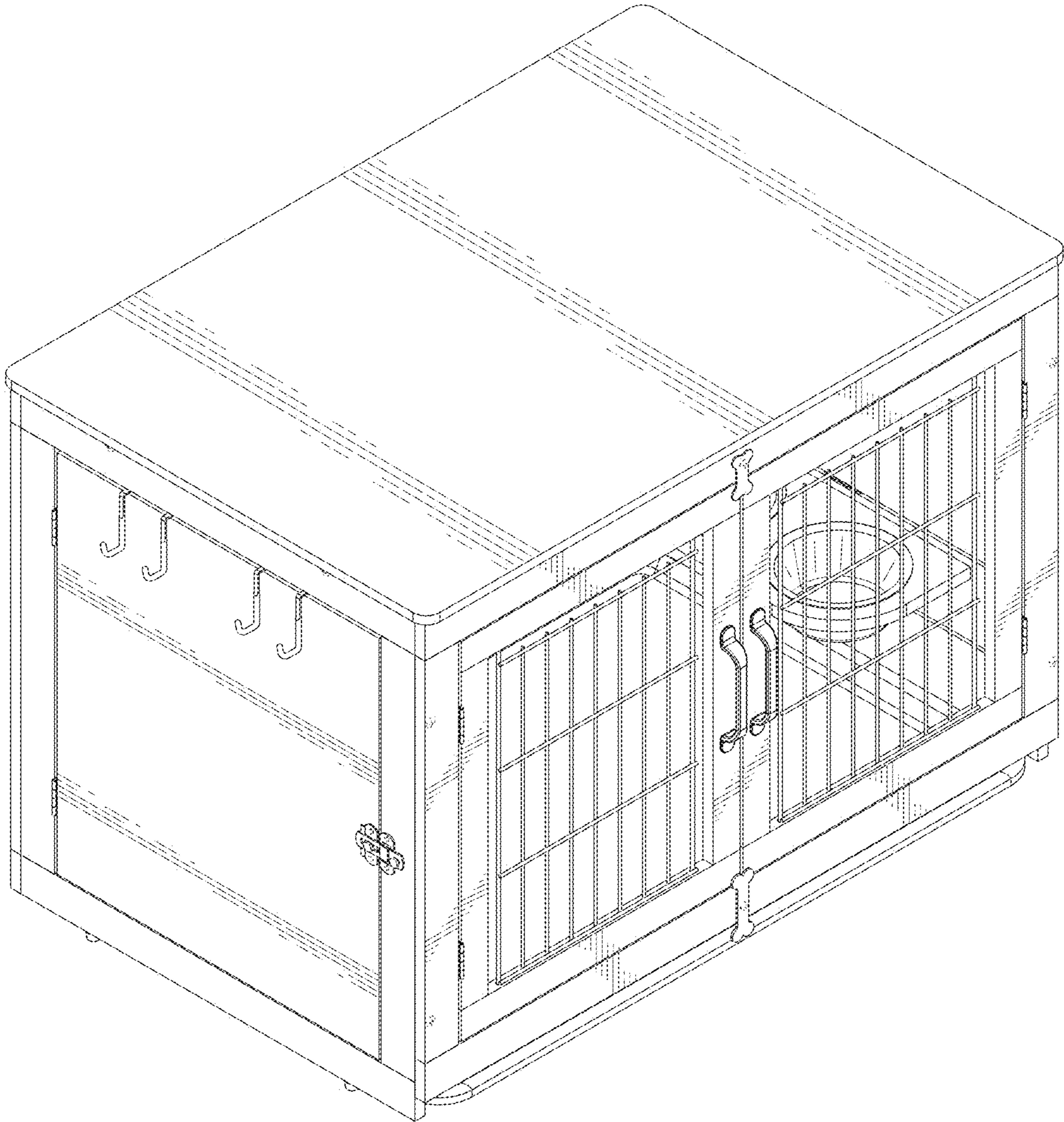

FIG. 2

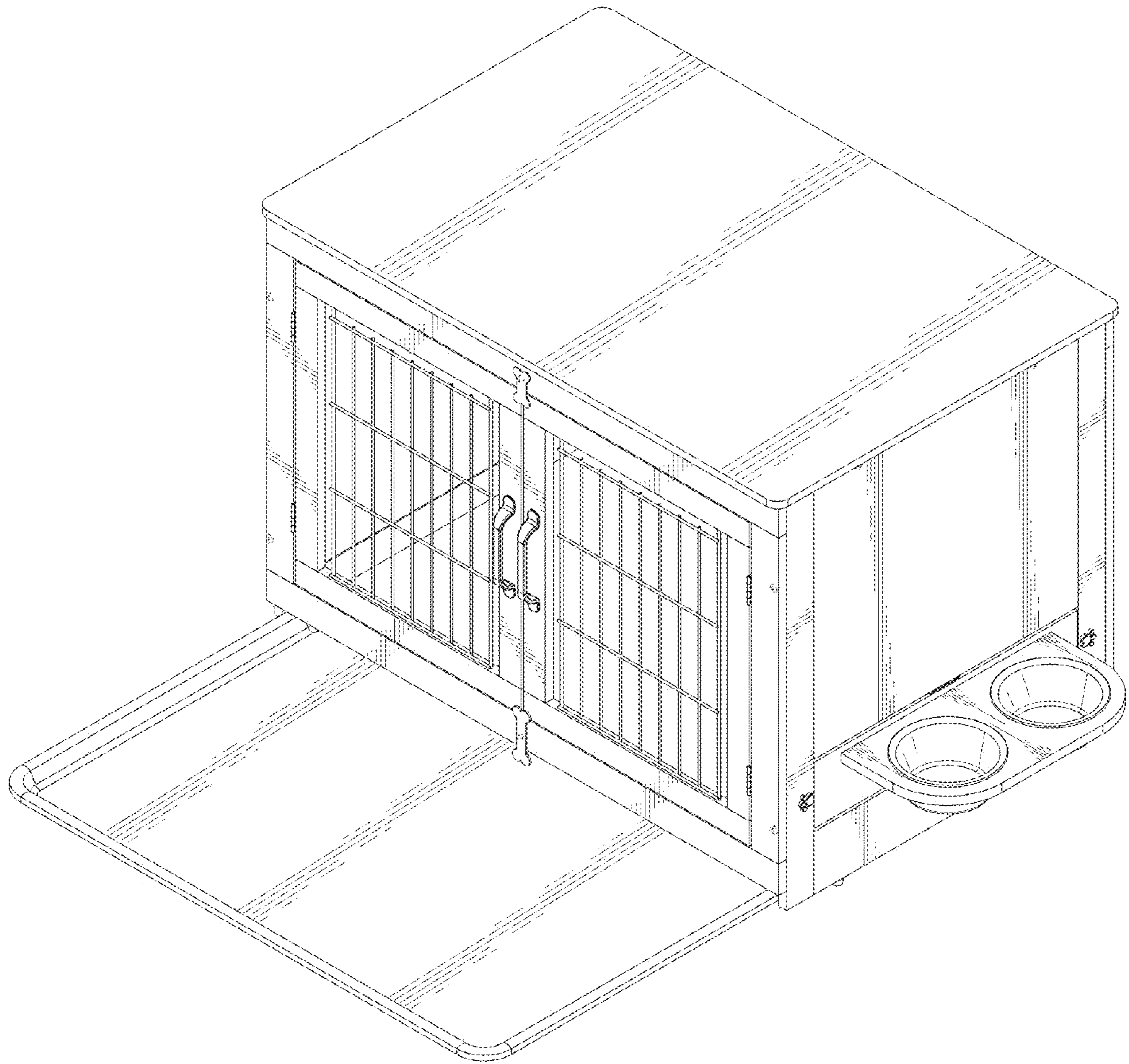

FIG. 3

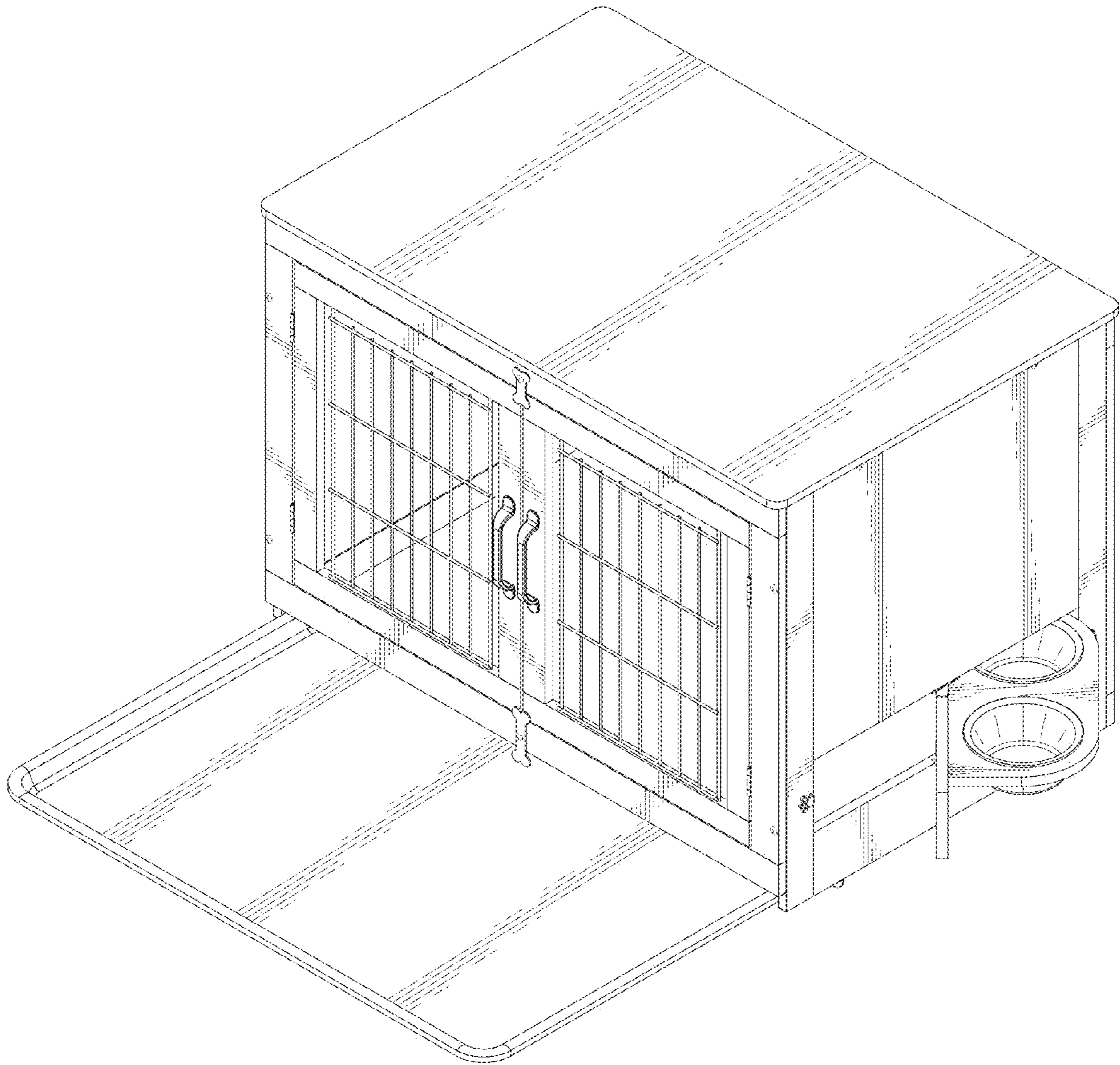

FIG. 4

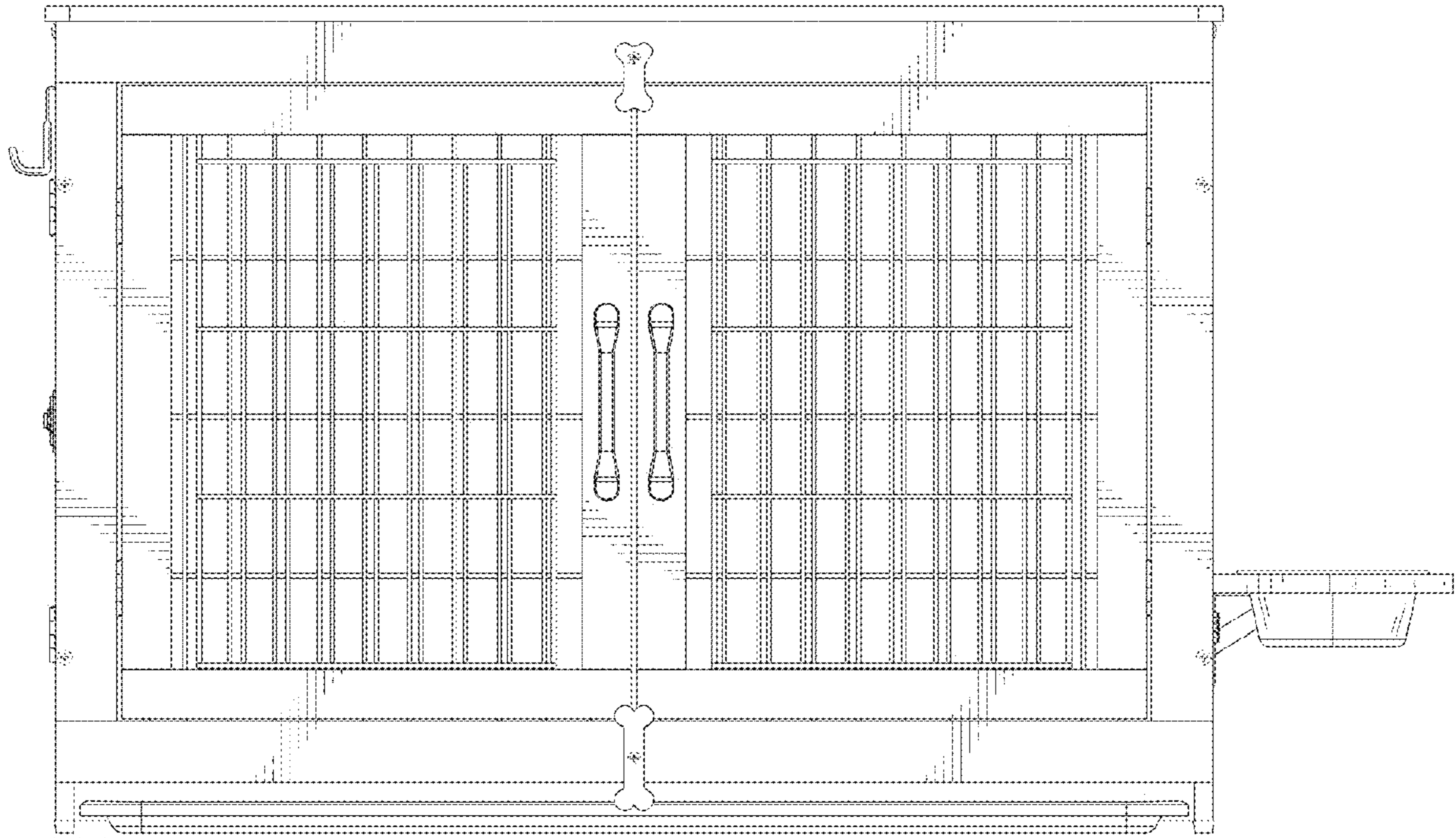

FIG. 5

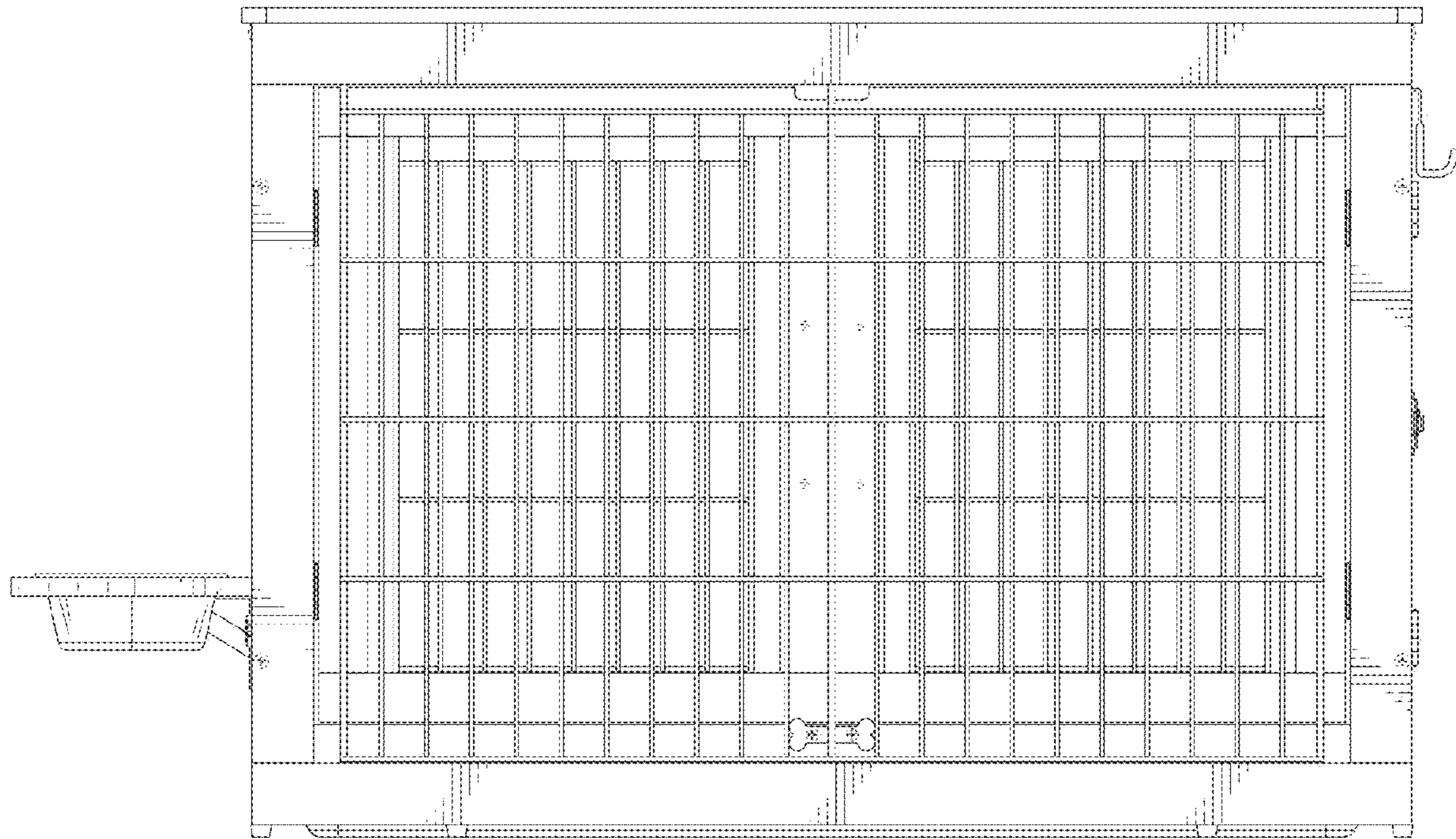

FIG. 6

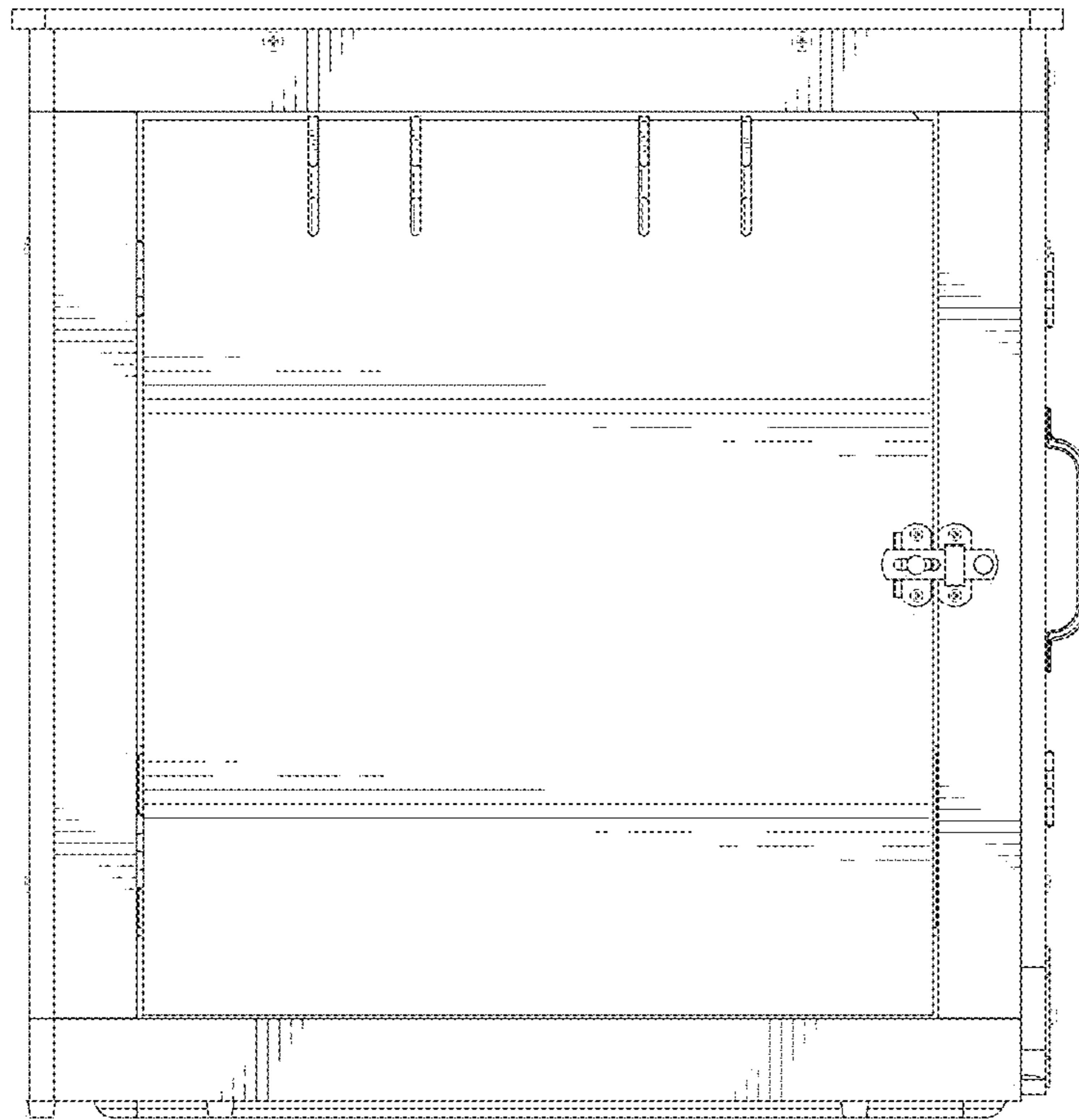

FIG. 7

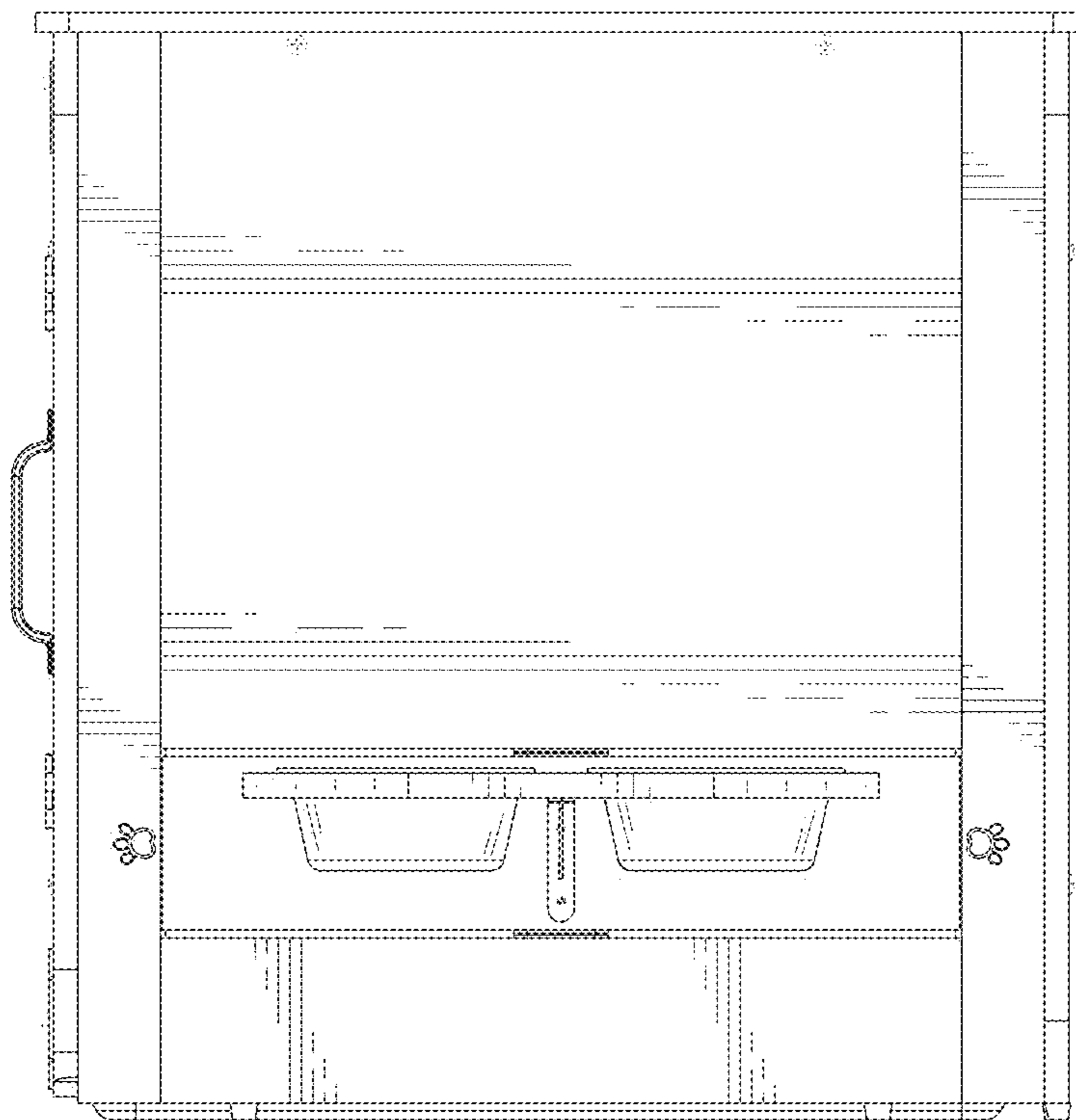

FIG. 8

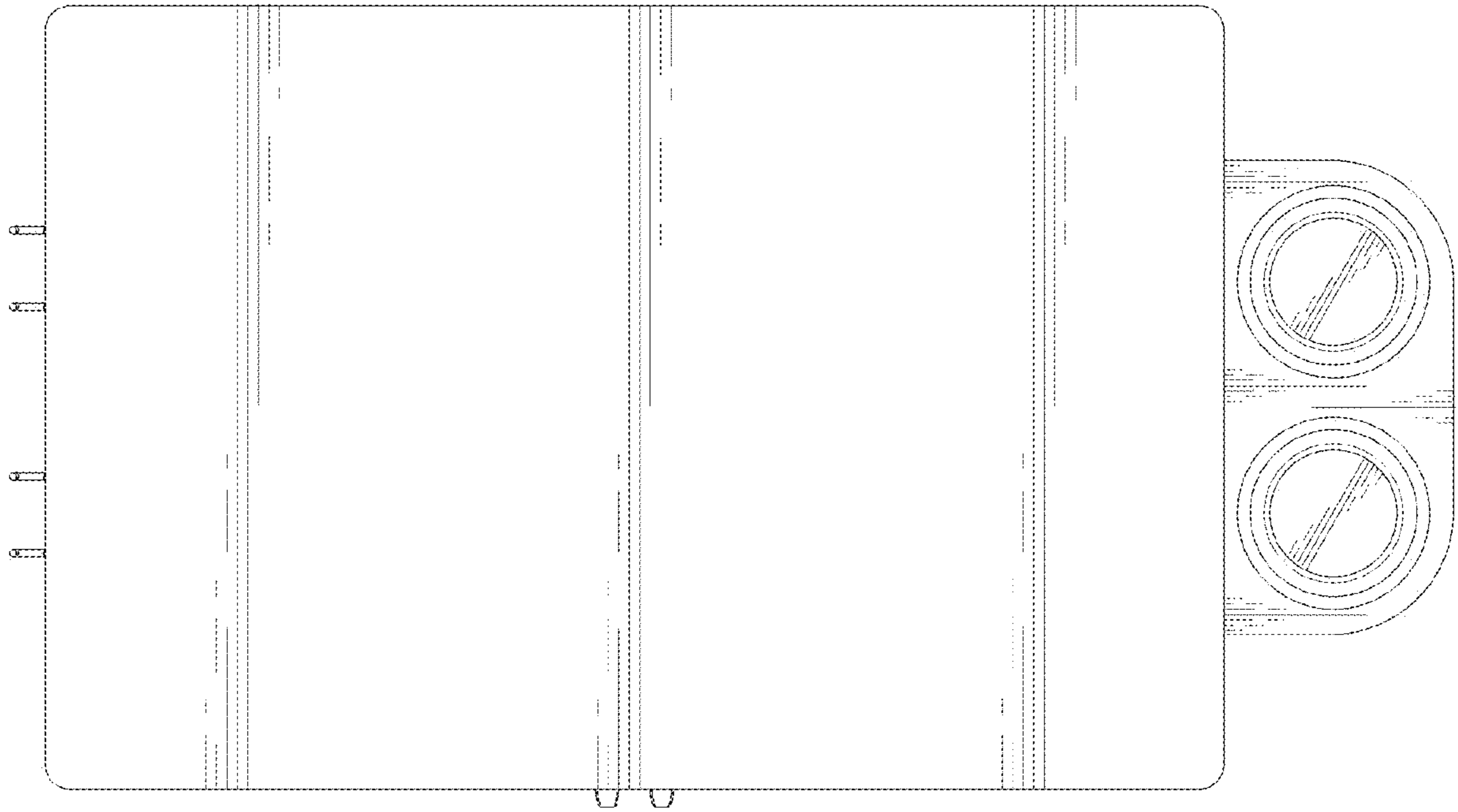

FIG. 9

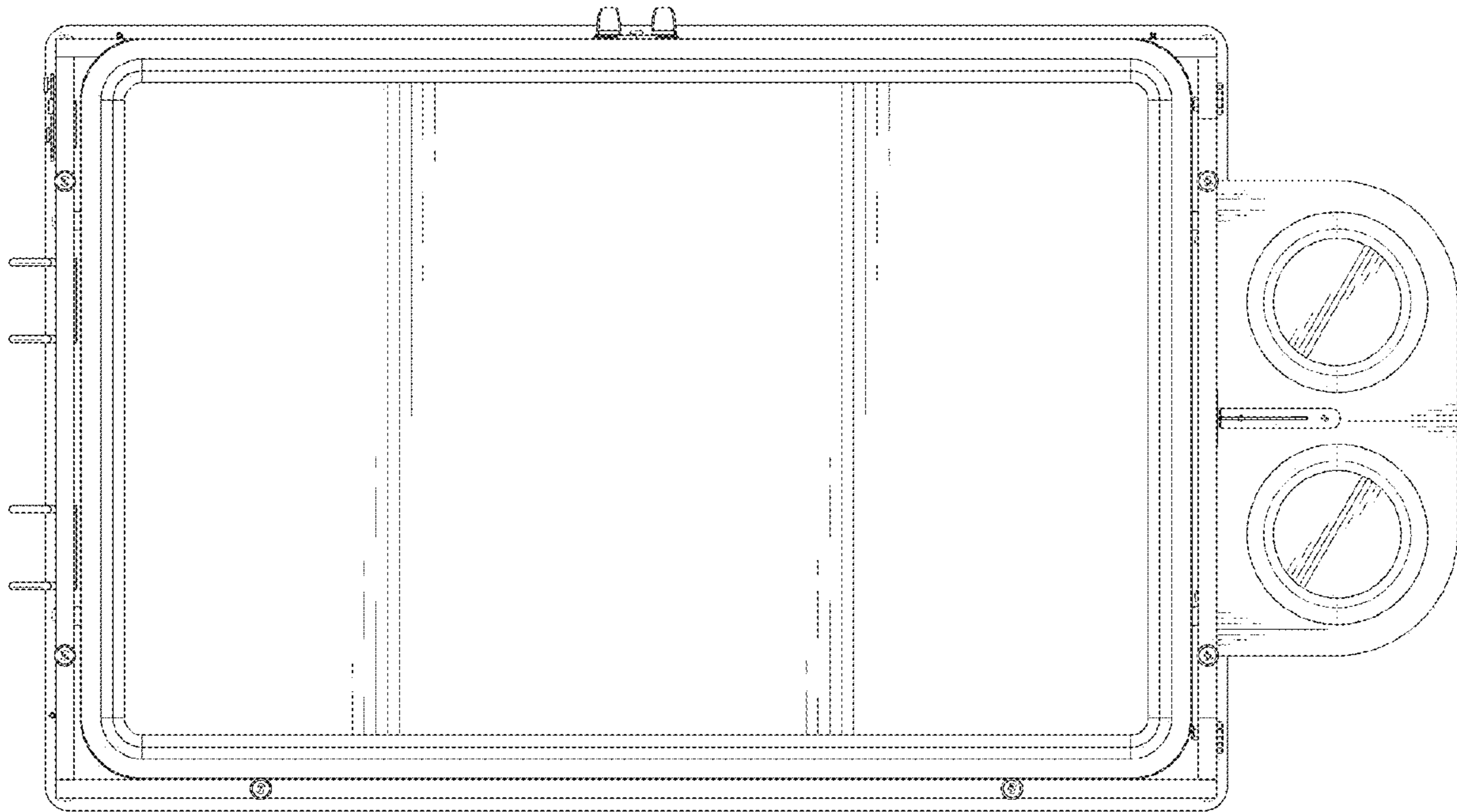

FIG. 10